



Form 562-18
Supersedes
Form 562-17

2018

PRODUCT GUIDE





FAST FACTS

PRODUCTS & PEOPLE YOU CAN TRUST, BACKED BY AN IRONCLAD WARRANTY

INDUSTRY BEST COVERAGE

OVER
7,000 OE QUALITY PARTS
WITH EASY CROSS-REFERENCE

PERFORMANCE

- Products designed to fully meet or exceed OEM performance
- Efficiency to protect the most sophisticated modern engines
- Capacity to meet standard and extended service intervals
- Products tested to ISO/SAE standards and in the field

QUALITY

- World-class quality exceeds 6 Sigma standards

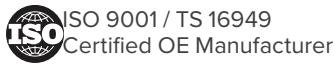

500,000
FILTERS MADE
PER DAY

- Complete process control, media development through production and final assembly
- High vertical manufacturing integration ensures quality parts
- Baldwin engineers guide products from design to production
- Sophisticated on-site test labs validate high performance

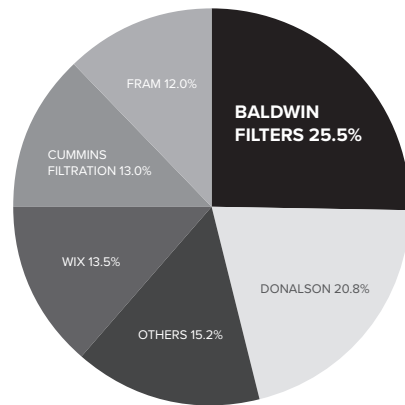

NORTH AMERICAN CLASS 4-8 MARKET SHARE

- Largest, most experienced field sales and technical support team
- Friendly, knowledgeable inside customer support team

Online catalog, cross-reference & application guides

92%
TOP 500 PARTS
MADE IN THE USA



Table of Contents	1
Form 123, Form 124, Form 125, Form 560 and Form 561 List of Contents.....	2
Baldwin New Products	3-8
Baldwin Obsolete Products	9-16
Abbreviations Used Anywhere in Our Catalogs	17-25
Notes.....	26
Prefixes and Suffixes	27-35

PRODUCT GUIDE.....36-602

How Product Guide is Arranged	36-40
Product Guide (Numerical Sequence Master List)	41-572
Filter Bases	130-132
Vacuum/Pressure Gauges	132
Farr Tube-Type Air Filters	155-156
Coolant Filters/Products	313-318
Automatic Transmission Filters	355, 505-511
Truck Service Kits	355-367
Hydraulic Bases & Indicators	441-443
Oil/Air Separators	584-592
Stanadyne Fuel Additives	593
Gaskets	594-601
Caterpillar Gaskets	602
DAHL	603-619
Industrial Air Cartridges	620-623

SIZE CHARTS.....624-690

O-Ring Uniform Dash Numbers	624
Round Gaskets Arranged by O.D.	625-626
Spin-on Filters by Tap Size (U.S. Thread)	627-640
Spin-on Filters by Tap Size (British Standard Pipe Thread)	641
Spin-on Filters by Tap Size (Metric Thread)	642-647
Liquid Elements by Length.....	648-662
Round Air Filters by Length.....	663-678
Panel Air Filters	679-684
Oval, Oblong & Miscellaneous Air Filters.....	685
Box-Style and Can-Type Fuel Filters	686
Oil/Air Separator Elements by Length.....	687
Oil/Air Separator Spin-on Filters by Tap Size (Metric Thread).....	688
In-Line Filters by Inlet Size.....	689-680
Decimal Equivalents Chart	691
UPC Code Explanation	692
Baldwin to UPC (Individual Parts)	693-712
UPC to Baldwin (Individual Parts)	713-732
Baldwin Case to I 2/5 (Shipping Cases).....	733-741
I 2/5 to Baldwin Case (Shipping Cases).....	742-750
Baldwin Weights and Volumes	751-783
Filter Wrenches.....	784-787
Baldwin Filter Date Coding Methods	788-796
A Word About Warranties	797-802
Baldwin Filter Warranty.....	797-802
Notes	803-804
Product Investigation	805
Field Report Form	806
Filter Survey.....	807-808

TABLE OF CONTENTS

Product Guide

Form 123-18, Form 124-17, Form 125-18, Form 560-18 & Form 561-18 List of Contents

FORM 123-18 AUTOMOTIVE APPLICATIONS

Refer to the following list of contents for information contained in the Baldwin Automotive Filter Applications Catalog, Form 123-18.

AUTOMOTIVE APPLICATIONS

- *Automotive and Light-Duty Truck Applications 1980-on (Includes Imports)*
- *Automotive and Light-Duty Truck Applications Pre-1980 (Includes Imports)*

FORM 124-17 OFF-HIGHWAY APPLICATIONS

Refer to the following list of contents for information contained in the Baldwin Off-Highway Filter Applications Catalog, Form 124-17.

OFF-HIGHWAY APPLICATIONS

- *Off-Highway Applications*

FORM 125-18 TRUCKS & BUSES APPLICATIONS

Refer to the following list of contents for information contained in the Baldwin Trucks & Buses Filter Applications Catalog, Form 125-18.

TRUCKS & BUSES APPLICATIONS

- *Trucks & Buses Applications*

FORM 560-18 MANUFACTURERS' CROSS-REFERENCE

Refer to the following list of contents for information contained in the Baldwin Manufacturers' Cross-Reference Catalog, Form 560-18.

MANUFACTURERS' CROSS-REFERENCE

- *Cross-Reference Information Arranged by Manufacturer*

FORM 561-18 NUMBER-FINDER CROSS-REFERENCE

Refer to the following list of contents for information contained in the Baldwin Number-Finder Cross-Reference Catalog, Form 561-18.

NUMBER-FINDER CROSS-REFERENCE

- *Cross-Reference Information Arranged in Number-Finder Format*

ALSO INCLUDED

- *Manufacturers' Codes*

BALDWIN NEW PRODUCTS

BALDWIN NUMBER	DESCRIPTION	REPLACES	APPLICATIONS
BF1347-O	Fuel/Water Separator Spin-on with Open End for Bowl	Racor S3226T; Donaldson P551034; Fleetguard FS19933, FS19798	Freightliner Chassis; Freightliner, International, Kenworth Trucks; Thomas Buses
BF1381-O	Fuel/Water Separator Spin-on with Open End for Bowl	Racor R12P; Donaldson P551768; Fleetguard FS19627	Genie S100, S105, S120, S125 Lifts; Volvo VHD430 Trucks
RS3518XP	Extreme Performance Radial Seal Outer Air	Donaldson DBA5069; Fleetguard AF25139M	Autocar, Ford, Freightliner, International, Peterbilt, Sterling, Volvo, WhiteGMC Trucks
BF5813-O	Fuel/Water Separator Spin-on with Open End for Bowl	Isuzu 8156189210; General Motors 156189210; Racor S3202T;	Isuzu FSR Trucks
BK6057	Service Kit for Mack Trucks		Mack Trucks
BK6068	Service Kit		
BK6069	Service Kit		
BK6082	Service Kit for Mack Engines		
BK6083	Service Kit for Mack GU713		Mack GU713
BK6085	Service Kit for Mack / Volvo Engines		
BK6088	Service Kit for Freightliner Coronado SD		
BK6089	Service Kit	Thermo King 10-449	
BK6092	Service Kit		
BK6093	Service Kit		
BK6094	Service Kit		
BK6112	Service Kit		GasJack Compressors
BK6117	Service Kit for Mack / Volvo Engines		Mack, Volvo Trucks
BK6118	Service Kit for Cummins		Cummins ISX, X15 Engines
PA10043	Cabin Air Element	Chrysler 68071668AA	Chrysler 300, Dodge Challenger, Charger
PA10044	Panel Air Element with Pull Tabs	Hyundai 28113C1100, 28113O3300	Hyundai Sonata; Kia Optima
PA10045	Panel Air Element with Foam Pad	Toyota 178010S020, 178010P100	Toyota Tundra, Sequoia, Tacoma
PA10047	Panel Air Element	Honda 172205LAA00	Honda CRV with (2.4L) Engine
PA10057	Panel Air Element	Honda 172205AAA00	Honda Civic, 2017-18 CR-V
PA10058	Panel Air Element	Honda 172205J6A10	Acura, Honda Automotive, Light-Duty Trucks
PA10061	Oval Air Element with Foam	Ford HC3Z-9601-A; Motorcraft FA1927	Ford Super-Duty Trucks with (6.7L) Engines
PA10062	Air Element with Foam Wrap	General Motors 39030321; ACDelco A3220C	Chevrolet Cruze
PA10064	Panel Air Element	Honda 1722051BH00	2016-18 Honda HR-V with (1.8L) Engine
PA10066	Panel Air Element	Kia 97133B2000	Kia Soul, Soul EV
PA10067	Cabin Air Element	Kia C6C79AC000	Kia Sorento
PA10068	Oval Air Element	Ford HC3Z-9601-B; Motorcraft FA1928	Ford Super-Duty Trucks with (6.2L), (6.8L) Engines
PA10070	Panel Air Element	Ford DG9Z9601A; Motorcraft FA1911	Ford C-Max, Fusion, Lincoln MKZ all with 4-122 (2.0L) FI Hybrid Engine
PA10071	Panel Air Element	Nissan 16546EJ70A	Infiniti M35, M37, Q70
PA10072	Panel Air Element	Honda 17220R8AA01	Acura RDX, 2017 ILX
PA10073	Panel Air Element	Acura 172205J6A00	Acura MDX
CV15006	Crankcase Breather	Case 87304662; New Holland 87304662	Case, Case-International, New Holland, Steyr Equipment
PE17001	Diesel Exhaust Fluid Strainer	Mack 82269261; Nissan 5282269261	Mack, Nissan UD and Volvo Trucks
PT23122	Hydraulic Strainer	Schroeder SS150100	
PT23123	Hydraulic Strainer	Schroeder SS125100	
PT23124	Hydraulic Strainer	Schroeder SS2100; Fleetguard HF6264	Schroeder Industrial Hydraulic Systems
PT23125-MPG	Maximum Performance Glass Hydraulic Element	Schroeder KSX3V; Donaldson P566412	Schroeder Industrial Hydraulic Systems
PT23126-MPG	Maximum Performance Glass Hydraulic Element	Pall HC9021FUS4H	Pall Hydraulic Applications
PT23127-MPG	Maximum Performance Glass Hydraulic Element	General Motors 29545785	Allison EV40, EV50 Transmissions
PT23128-MPG	Maximum Performance Glass Hydraulic Element	Wix 57871	Hydac Applications
PT23129-MPG	Maximum Performance Glass Hydraulic Element	Hydac 24D020BN3HCV	Hydac Hydraulic Applications



WARNING: These products can expose you to chemicals, including Diisononyl Phthalate, Carbon black extracts, Nickel, 1,3 Butadiene, Ethylene Oxide, Epichlorohydrin, which are known to the State of California to cause cancer, and Bisphenol-A, Ethylene Glycol, Ethylene Oxide, 1,3 Butadiene, Epichlorohydrin, which are known to the State of California to cause birth defects or other reproductive harm. For more information go to www.P65Warnings.ca.gov.

BALDWIN NEW PRODUCTS

BALDWIN NUMBER	DESCRIPTION	REPLACES	APPLICATIONS
PT23131-MPG	Maximum Performance Glass Hydraulic Element	Schroeder 8TSX7	Schroeder Hydraulic Applications
PT23132-MPG	Maximum Performance Glass Hydraulic Element	Hydac 110D003BH3HC	Hydac Applications
PT23133-MPG	Maximum Performance Glass Hydraulic Element	Pall HC2618FKP18H; Parker 934179Q; Donaldson P566705	Various Pall Applications
PT23134-MPG	Maximum Performance Glass Hydraulic Element	Wix 57231	Heil Equipment
PT23135-MPG	Maximum Performance Glass Hydraulic Element	Parker 932633Q	Parker Hydraulic Systems
PT23136	Hydraulic Element	Ford C5NN7B155A	Ford Tractors
PT23137	Hydraulic Element	Drilltech 318553; Donaldson P161917; Fleetguard HF6298	Drilltech Equipment
BT23543-MPG	Maximum Performance Glass Hydraulic Spin-on	John Deere AT335492; Donaldson P576064	John Deere Loaders, Motor Graders
PT23544-MPG	Maximum Performance Glass Hydraulic Element	Wirtgen 1285491; Hamm 1285491, 3001285491	Hamm DS120, HD130, HD275, 3412, 3307 Rollers
PT23556-MPG	Maximum Performance Glass Hydraulic Element	Schroeder 9V5Z10; Donaldson P572998	Schroeder Hydraulic Applications
PT23560	Hydraulic Element	Hitachi 4688140	Hitachi Excavators
PT23577-MPG	Maximum Performance Glass Hydraulic Element	Linde 9831643	Linde Applications
PT23586	Hydraulic Element	TMC 214A752081	TMC Applications
PT23592	Hydraulic Element	Case KRJ10590; New Holland KRJ10590	Case, Link-Belt Excavators
PT23595-MPG	Maximum Performance Glass Hydraulic Element	Galbreath A4968, GBA4968; Donaldson P572229	Various Industrial Hydraulic Applications
PT23600	Hydraulic Element	Hyundai E1310212; Donaldson R010109; Fleetguard HF35363	Hyundai Excavators
BT23603-MPG	Maximum Performance Glass Hydraulic Spin-on	John Deere LVA13038	John Deere Tractors
BT23607-MPG	Maximum Performance Glass Hydraulic Spin-on	Case KHJ17730, 47635916	Case Excavators, Motor Graders; Link-Belt Excavators, all with Isuzu Engines
BT23609-MPG	Maximum Performance Glass Hydraulic Element	Donaldson P170546; Fleetguard HF35438;	
BT23611	Lube Spin-on	Hyster 2075558, 4020588	Hyster Applications
PT23616-MPG	Maximum Performance Glass Hydraulic Element	McNeilus 1233304; Oshkosh 1233304	McNeilus Hydraulic Equipment
PA30023	Air Element	Vortex VF-100D	Vortex Housings
PA30032	Outer Air Element	Massey Ferguson 3824035M1	Massey Ferguson Loaders, Tractors
PA30033	Inner Air Element	Massey Ferguson 3824036M1	Massey Ferguson Loaders, Tractors
PA30042	Air Element in Disposable Housing	Air Refiner ARM2824	Alaska Marine Engines
PA30045	Panel Air Element	Case 86545652	New Holland Harvesters
RS30062	Radial Seal Air Element	Volvo 21377913	Volvo Genset Engines
PA30068	Air Element	Donaldson P131321	Cub Cadet Lawn Tractors
PA30074	Dynacell Panel Air Element	Clark Filter AE529; E.M.D. 9331454; Farr 60799, T529DR	Railroad and Marine Applications
CA30131	Channel Flow Air Element	Freightliner P621097; Donaldson P621097	Freightliner Trucks with Cummins Engines
CA30132	Channel Flow Air Element	Freightliner P619498; Donaldson P634517; Western Star P619498	Freightliner 114SD, Western Star 4700 Trucks with Cummins and Detroit Diesel Engines
PA30151	Cab Air Element with Pull Tab	New Holland LQ50V01008P1	Kobelco, New Holland Excavators
PA30164	Panel Air Element with Pull Tabs	Komatsu 12Y9791181	Komatsu Dozers
PA30170	Air Element	M.T.U. 180945802; Donaldson B120472; Fleetguard AH24332	M.T.U. Diesel Engines
PA30171	Air Element	M.T.U. 170941202; Donaldson B105036	M.T.U. Diesel Engines
RS30180	Radial Seal Air Element	M.A.N. 81083040093; Donaldson P782998; Fleetguard AF25899	M.A.N. Lion's City, C, L LE, GL LE Buses



WARNING: These products can expose you to chemicals, including Diisononyl Phthalate, Carbon black extracts, Nickel, 1,3 Butadiene, Ethylene Oxide, Epichlorohydrin, which are known to the State of California to cause cancer, and Bisphenol-A, Ethylene Glycol, Ethylene Oxide, 1,3 Butadiene, Epichlorohydrin, which are known to the State of California to cause birth defects or other reproductive harm. For more information go to www.P65Warnings.ca.gov.

BALDWIN NEW PRODUCTS

BALDWIN NUMBER	DESCRIPTION	REPLACES	APPLICATIONS
RS30181	Radial Seal Inner Air Element	New Holland 84072430; Massey Ferguson D46485600; Donaldson P781203; Fleetguard AF26215	Fendt Combines; Massey Ferguson, New Holland Harvesters
RS30182	Radial Seal Outer Air Element	New Holland 84072431; Donaldson P789638; Fleetguard AF26214	Fendt Combines; Massey Ferguson, New Holland Harvesters
PA30185	Cab Air Element	Caterpillar 3535058	Caterpillar Loaders
PA30189	Air Element with Foam Wrap & Bolt Hole	Subaru 26332610A1	Robin Engines
PA30190	Panel Air Element	Caterpillar 2931183	Caterpillar Excavators, Forestry Equipment, Hydraulic Power Units, Material Handlers
PA30204	Crankcase Breather	Volvo 843736, 876069, 876069-6, 876069-9	Volvo Marine Engines
PA30206	Air Element	Hyster 1620142; Yale 580069337; Donaldson P616742	Hyster Lift Trucks
PA30207	Outer Air Element	John Deere RE282286; Donaldson P609221; Baldwin PA5634	John Deere Loaders, Tractors
PA30208	Inner Air Element	John Deere RE282287; Donaldson P608599; Baldwin PA5635	John Deere Loaders, Tractors
RS30209	Radial Seal Outer Air Element	Agco 3607884M91, 3607884M92	Agco, Challenger Tractors; Massey Ferguson Equipment and Tractors
PA30211	Air Element	Caterpillar 9206107410	Caterpillar, Mitsubishi Lift Trucks
RS30216	Radial Seal Outer Air Element	Atlas Copco 3222188144, 4700394690; Dynapac 394690, 4700394690; Donaldson P785390, X7700691	Dynapac Compactors, Rollers
RS30217	Radial Seal Inner Air Element	Atlas Copco 3222188144, 4700394691; Dynapac 394691, 4700394691; Donaldson X7700691	Dynapac Compactors, Rollers
RS30223	Radial Seal Outer Air Element	Case 84286399	Case, New Holland Motor Graders
RS30224	Radial Seal Inner Air Element	Case 84286397	Case, New Holland Motor Graders
RS30225	Radial Seal Outer Air Element	New Holland 87741560; Fleetguard AF26345	International, New Holland Tractors
RS30226	Radial Seal Inner Air Element	New Holland 87741569; Fleetguard AF26346	International, New Holland Tractors
PA30228	Panel Air Element	Hyundai 11Q690510	Hyundai Excavators
PA30229	Panel Air Element	Hyundai 11N690760, AM880002002, XJAU0153; Donaldson P753339; Fleetguard AF26474	Hyundai Applications
RS30232	Radial Seal Outer Air Element with Blank Band	D.A.F. 1146384, 1525439; Massey Ferguson D46485500; Van Hool 20276708; Volvo 1155727, 41155727	Fendt Combines; Massey Ferguson Harvesters; Van Hool Buses
PA30233-FN	Air Element with Fins	Fiat 920007502; Manitou 710467; Donaldson P771511	Manitou Lift Trucks
RS30234	Radial Seal Inner Air Element	Bobcat 6983022; Donaldson P602427	Bobcat 5600 Turbo, 5610 Utility Vehicles
PA30235	Outer Air Element	Iveco 2996154, 41272534; Mercedes-Benz A0040945004	Claas, Liebherr, V.M.E., Volvo Equipment; Iveco, M.A.N., Mercedes-Benz Trucks
RS30236	Radial Seal Air Element	Renault 5001865724; Volvo 20732730	R.V.I., Mack Trucks
RS30237	Radial Seal Inner Air Element	Blue Bird 10004114	Blue Bird All-American Buses with Cummins ISB (5.9L) Engine
RS30242	Radial Seal Inner Air Element	Ingersoll-Rand 35393651	Ingersoll-Rand Applications
PA30243	Outer Air Element	Hitachi 4642122; Donaldson P789077	Hitachi, John Deere Excavators



WARNING: These products can expose you to chemicals, including Diisononyl Phthalate, Carbon black extracts, Nickel, 1,3 Butadiene, Ethylene Oxide, Epichlorohydrin, which are known to the State of California to cause cancer, and Bisphenol-A, Ethylene Glycol, Ethylene Oxide, 1,3 Butadiene, Epichlorohydrin, which are known to the State of California to cause birth defects or other reproductive harm. For more information go to www.P65Warnings.ca.gov.

BALDWIN NEW PRODUCTS

BALDWIN NUMBER	DESCRIPTION	REPLACES	APPLICATIONS
PA30244	Inner Air Element	Hitachi 4642117; Donaldson P788912	Hitachi, John Deere Excavators
PA30251	Cabin Air Filter	John Deere L156225, L209778	John Deere Tractors
PA30252	Cabin Air Filter	Kubota T185571600	Kubota Tractors
PA31000	Primary EnduraPanel Air	Cummins 5261250; Doosan 40050400029; Donaldson DBA5293; Fleetguard AF55015	Cummins QSB6.7 (Final Tier 4, Interim Tier 4), QSC, QSC9, QSL9 (Final Tier 4, Interim Tier 4) Engines
PA31001	Secondary EnduraPanel Air	Doosan 40050400048; Donaldson P633484; Fleetguard AF55309	Cummins QSB6.7 (Final Tier 4, Interim Tier 4), QSC, QSC9, QSL9 (Final Tier 4, Interim Tier 4) Engines
PA31002	Primary EnduraPanel Air	Cummins 5261249; Fleetguard AF55014; Donaldson DBA5292	Cummins QSB6.7 (Tier 4 Interim and Final), QSL9 (Tier 4 Interim and Final), QSX11.9, QSX15 (Interim Tier 4) Engines
PA31003	Secondary EnduraPanel Air	Cummins 5261251; Fleetguard AF55308; Donaldson P633483, X011872	Cummins QSB6.7 (Tier 4 Interim and Final), QSL9 (Tier 4 Interim and Final), QSX11.9, QSX15 (Interim Tier 4) Engines
PA31004	Primary EnduraPanel Air	Fleetguard AF55020; Doosan 46595499; JLG Industries 70024177	Cummins QSF3.8 (Final Tier 4), QSB4.5 (Final Tier 4), QSF2.8 Naturally Aspirated (Tier 4), QSF2.8 Turbo (Tier 3), QSF2.8 (Final Tier 4) Engines
PA31005	Secondary EnduraPanel Air	Agco 700738184; Fleetguard AF55312; JLG Industries 70024176	Cummins QSF3.8 (Final Tier 4), QSB4.5 (Final Tier 4), QSF2.8 Naturally Aspirated (Tier 4), QSF2.8 Turbo (Tier 3), QSF2.8 (Final Tier 4) Engines
PA31006	Primary EnduraPanel Air	Agco 700738183; Cummins 5288553; Fleetguard AF55021; JLG Industries 70024175	Cummins QSF3.8 (Final Tier 4), QSB4.5 (Final Tier 4), QSF2.8 Naturally Aspirated (Tier 4), QSF2.8 Turbo (Tier 3), QSF2.8 (Final Tier 4) Engines
PA31007	Secondary EnduraPanel Air	Cummins 5310325; Fleetguard AF55320	Cummins QSF3.8 (Final Tier 4), QSB4.5 (Final Tier 4), QSF2.8 Naturally Aspirated (Tier 4), QSF2.8 Turbo (Tier 3), QSF2.8 (Final Tier 4) Engines
PA31010	Primary EnduraPanel Air	Bobcat 7010030, 7286652	Bobcat Loaders, Telescopic Handlers with Doosan Engines
PA31011	Secondary EnduraPanel Air	Bobcat 7010031	Bobcat Loaders, Telescopic Handlers with Doosan Engines
C40004	By-Pass Lube Sock	Massey Ferguson 1013890M1	Massey Ferguson Applications
C40005	By-Pass Lube Sock	Massey Ferguson 1501049M91	Massey Ferguson Applications
BD40027	Lube Spin-on	John Deere RE530107, RE557343, RE561823, RE572785	John Deere Equipment
P40030	Lube Element	M.T.U. X57518300024; Fleetguard LF17485	M.T.U. Equipment
P40031-MPG	Maximum Performance Glass Lube Element	Case 2996570, 504179764, 84565867; Claas 11429540; Iveco 504179764; New Holland 2996570, 504179764, 84565867	Case Equipment; Iveco Trucks with Cursor 9, 11, 13 Engines
P40035	Lube Element	Porsche 95810722210; Volkswagen 3H115562	Porsche, Volkswagen Automotive
BT40038	Lube Spin-on	Case 84475542; New Holland 84475542; Donaldson P551132	Case Compaction Equipment, Loaders; New Holland Skid Steer Loaders
B40050	Lube Spin-on	Cummins 5262313; Fleetguard LF16352; Donaldson P556352	Cummins ISF3.8, QSF2.8 Naturally Aspirated (Tier 3), QSF2.8 Turbo (Tier 4 Final) Engines
B40053	Lube Spin-on	Navistar 1885920C1, 1885920C2	International MaxxForce 9 and 10 Engines, DuraStar, TranStar, WorkStar Trucks
B40054	Lube Spin-on	Caterpillar 32B4020100; Donaldson P502476; Fleetguard LF17507	Caterpillar, Mitsubishi Lift Trucks; Hyundai Excavators
B40056	Lube Spin-on	Ingersoll-Rand 23279078	Doosan Compressors
P40058	Lube Element	Fiat 55197218	Fiat Doblo I 1.3 Multijet 16V JTD (119/223) with 75 HP, 85 HP Engines (11/05-on) European Light-Duty Vehicles
P40061	Lube Element	Volkswagen 3N115562	Volkswagen Beetle, Jetta, Passat, Golf



WARNING: These products can expose you to chemicals, including Diisononyl Phthalate, Carbon black extracts, Nickel, 1,3 Butadiene, Ethylene Oxide, Epichlorohydrin, which are known to the State of California to cause cancer, and Bisphenol-A, Ethylene Glycol, Ethylene Oxide, 1,3 Butadiene, Epichlorohydrin, which are known to the State of California to cause birth defects or other reproductive harm. For more information go to www.P65Warnings.ca.gov.

BALDWIN NEW PRODUCTS

BALDWIN NUMBER	DESCRIPTION	REPLACES	APPLICATIONS
P40062	Lube Element	Case 5801592277; New Holland 5801592277; Iveco 50054654, 5801592277	New Holland Equipment
PF46009	Fuel Element	Racor R11T	Kool-Gen Auxillary Power Units
PF46010 KIT	Set of 2 Fuel Elements	Racor RK22610; Donaldson P551061; Fleetguard FS1107	Marine Engines
BF46013	Fuel Spin-on	Cim-Tek 70052, 70120	Fuel Dispensing Filter for Fuel Pumps (specifically for ethanol blended fuels up to E85)
PF46049	Fuel/Water Separator Element	Caterpillar 3635819	Caterpillar Excavators, Generators, Loaders
PF46056	Fuel Element	Isuzu 8982402790; Wacker 5200017728	Multiquip Generators and other Equipment with Isuzu 4LE2T, 4LE2X Engines
PF46057	Fuel Element	Isuzu 8982402800; Wacker 5200017727	Multiquip Generators and other Equipment with Isuzu 4LE2T, 4LE2X Engines
BF46065-SPS	Fuel/Water Separator with Drain, Sensor Port & Sensor	Volvo 43919935, 43802263	Volvo Compactors, Paving Equipment; Ingersoll-Rand PF6110 Paver
PF46077	Fuel Element	Kubota 1583143380; Fleetguard FF5468	Kubota Excavators, Tractors
BF46078-D	Primary Fuel Element with Drain & Tab Keys	Ingersoll-Rand 22926737	Ingersoll-Rand Compressors
BF46083-O	Fuel/Water Separator Spin-on with Open End for Bowl	Scania 1393640	Scania Trucks
BF46084	In-Line Fuel Filter	Caterpillar 3848512; Perkins T412017	Caterpillar Equipment
BF46085	Fuel Spin-on	John Deere LW10429946; Liebherr 10044303; Yanmar 12065155020; Fleetguard FF5856	John Deere Dozers; Liebherr Equipment
PF46086	Fuel Element	M.A.N. 51125030086	M.A.N. European Trucks
BF46087	Box-Style Element with Handle	M.T.U. 925105; Fleetguard FS19803	M.T.U. Engines
PF46088	Fuel Element	Toyota 1860400021, 2330087317, 233900L010; Isuzu 8981596930	Toyota, Isuzu Applications
PF46092	Fuel/Water Separator Element	Davco 382134; Donaldson P550853; Fleetguard FS19905G	International LoneStar Trucks
BF46098-O	Fuel/Water Separator Spin-on with Open End for Bowl	Alliance ABP/N122-R50419	Freightliner Century Class, Cargo FC80, Cascadia Trucks
BF46099-O	Fuel/Water Separator Spin-on with Open End for Bowl	John Deere AT365869; Racor RS51401	John Deere Equipment
PF46103	Fuel Strainer	John Deere CQ29104	John Deere Harvesters, Tractors
BF46111	Fuel Spin-on	Ingersoll-Rand 22226369; Donaldson P550127; Fleetguard FF253, FF5147	Bobcat, Doosan Compressors; Case Loaders; Hino Buses; Yanmar Marine Engines
PF46112	Fuel Element	Opel 4412830; Nissan 1640500QAC; Renault 7701475229	Nissan, Opel, Renault European Light-Duty Vehicles
BF46113-D	Fuel/Water Separator with Drain	Atlas Copco 1310072275; Bobcat 103761801CC; Case CLC103761801; Club Car 103761801	Gehl Loaders
BF46117	Fuel Spin-on	Racor RS250RCR01; Volvo 22094967, 22474709	Mack, Volvo Trucks
PF46119	Fuel Strainer	John Deere AH165504	John Deere Harvestors, Tractors
BF46122	Fuel/Water Separator Spin-on with Drain	Deutz 4504438; Racor R60THB1	Various Equipment with Deutz Engines
BF46125	Box-Style Element with Handle	Fendt F916200060010; Fleetguard FS19733	Fendt Tractors
BF46129	Fuel Spin-on	Cummins 5365988; Fleetguard FF5825NN; Donaldson DBF6776	Freightliner, Kenworth, Peterbilt, Volvo Trucks with Cummins ISX11.9, ISX15.0, QSX11.9, X15 Engines
PF46130	Fuel Element	Chrysler 68235275AA	RAM 1500 Pickups with V6-182 (3.0L) FI Turbo Diesel Engine



WARNING: These products can expose you to chemicals, including Diisononyl Phthalate, Carbon black extracts, Nickel, 1,3 Butadiene, Ethylene Oxide, Epichlorohydrin, which are known to the State of California to cause cancer, and Bisphenol-A, Ethylene Glycol, Ethylene Oxide, 1,3 Butadiene, Epichlorohydrin, which are known to the State of California to cause birth defects or other reproductive harm. For more information go to www.P65Warnings.ca.gov.

BALDWIN NEW PRODUCTS

BALDWIN NUMBER	DESCRIPTION	REPLACES	APPLICATIONS
BF46147-0	Fuel/Water Separator with Open Port for Bowl	Case 84211170; Ingersoll-Rand 13224043, 13224043IR; Donaldson P551853; Fleetguard FS1287	Freightliner FS-65 Buses; Ingersoll-Rand Equipment
OAS98061	Oil/Air Separator Spin-on	Ingersoll-Rand 54749247	Ingersoll-Rand Compressors



WARNING: These products can expose you to chemicals, including Diisononyl Phthalate, Carbon black extracts, Nickel, 1,3 Butadiene, Ethylene Oxide, Epichlorohydrin, which are known to the State of California to cause cancer, and Bisphenol-A, Ethylene Glycol, Ethylene Oxide, 1,3 Butadiene, Epichlorohydrin, which are known to the State of California to cause birth defects or other reproductive harm. For more information go to www.P65Warnings.ca.gov.

BALDWIN OBSOLETE PRODUCTS

OBSOLETE NUMBER	REPLACED BY	OBSOLETE NUMBER	REPLACED BY	OBSOLETE NUMBER	REPLACED BY	OBSOLETE NUMBER	REPLACED BY	OBSOLETE NUMBER	REPLACED BY
EHL		C-53-MJ.....	P53	PT119-HD5DL		PT-236		CU-406-B.....	CU406
B-1/2		C-54-M.....	P54	PT-119-TR.....	(3) PT119	P-237		CU-406-I.....	CU406
B-1/2-S		PT-55.....	T55-M*	PF-120		P-238		CU-406-WO.....	CU406
BO-1A		T55-M		B-121.....	B50	PF-239		P-406.....	CU406
B-1.....	B2	T-56-M.....	V835-M*	B-122		P-241.....	PT29	VCU-406.....	CU406
V-1-F.....	V2-F*	T57-M		PT123-5		PT-242		VCU-406-HD.....	CU406
DL2.....	B2	T58-M		B-127		PT-243.....	PT82-HD	SD407	
V-2-A.....	B9	C59-C		C130-C		P-244		VSD-407.....	SD407*
V2-F.....	B2	C-59-C3.....	C59-C*	C-132-C Series		B245		VDF-408.....	DF408
B-3.....	B9	P-59.....	C59-C*	C-134-EL		PT-245		T-409-PE	
V-3-A.....	B9	C-60-C.....	P60	BT136		PT-246		T-410-PE	
C-5-K.....	C-50-MH*	PT-61.....	PT61-HD	PT-139		V-247-M		TA410-CPE5	
E-5		T-62-P.....	PT62	B-140		B-249.....	B2 or V2-F*	T-411-PE	
ME-6-F		T-63-P.....	PT63-1	C-141-F		P250		TB411-CPE25	
V-6-A.....	B6	C64-P.....	P64*	B-142		PD-250		TC411-CPE2	
D-7		P64		B-145.....	B243	P-252		TC411-CPE5	
B-8.....	B27	BT65		PT147		B-254.....	B50	TC411-CPE10	
V-9-A.....	B9	C-65-P.....	T77-P*	P149		PT-255		TC411-OPE2	
B-10.....	B10-AL	P-65.....	T77-P*	T-153-M		V-261-A		TC411-OPE5	
B-10 Bowl.....	B10-AL BOWL	PT-66.....	PT66-HD	V-156-M		PT-262		P412-5	
B-10-HD.....	B10-AL	C-67-P.....	P67	PT-157.....	P80 or P80-HD	P-263		P412-5A	
B-10-HD Bowl.....	B10-AL BOWL	C-68-P.....	P68	PT158(2)		BT-266.....	B2 or V2-F*	P412-25	
B-13.....	B10-AL	C-69-P.....	P69*	PT-159.....	PT385	P270		P412-25A	
B-13 Bowl.....	B10-AL BOWL	P69		PT-159-E.....	PT385-E	BT272.....	B7082	T-412-PE	
P-13		T70-P.....	PT70	PT-160		P-272		TA412-CPE5	
P-14		T71-P.....	PT71	B-161.....	B161-S	P276 KIT		TA412-CPE10	
EO-16-A		T72-P.....	PT72	P165		B-278		TA412-CPE10A	
S-16.....	S16-1	C-73-P.....	P73	P-168		B-280.....	B39	TB412-CPE25	
P17		C-73-PS.....	P73	P169		BT-281.....	B975	TB412-OPE25	
C18-A.....	P18 or P18-HD	PT-73.....	P73	B-173.....	B173-S	BT282.....	BT8449	TC412-CPE2	
C-19-A.....	P19	T-73-P.....	P73	P-173		BT282-10.....	BT8449-10	TC412-CPE5	
P-20.....	P20-HD	C-74-P.....	P73	B175.....	B1422	PT-286		TC412-CPE10	
P-20-E.....	P20-HDE*	T-75-P.....	P73	P-175		PT-288.....	PT288-HD	TC412-CPE25	
P20-HDE.....	P20-HD	B76-B.....	B76	P-178		B-290		TC412-CPE25A	
C21-A		B76-HPG.....	B76-SS	P-179.....	P177	B291		TC412-CPE50	
P-21.....	C21-A*	PT-77.....	T77-P*	P180		PT-291		TC412-OPE5	
C22-A		T77-P		PT-182 Kit		PT293		TC412-OPE5A	
P-22.....	C22-A*	C78-P		C184-P.....	P184	PT-294		TC412-OPE10	
C23-A		C80-P.....	P80	P188		B297.....	B2	TS412-CPE50	
C24-A		C81-P.....	P81	T192-P		B-298.....	BT223	T-413-PE	
C25-A.....	P25	C-84-P1.....	C84-P2*	PT-195.....	P15	VT-299.....	V842-O*	TA413-CPE10	
C-26-A.....	P26	C84-P2.....	P84-2	B196-MPG		T-301-M.....	T300-M	TA413-CPE10S	
V-27-A.....	B27	P-84-1.....	P84-2	P-196		T-302-M.....	T303-M	TB413-CPE25	
C-28-A		T-85-P.....	PT85	B-197.....	B243	T304-M.....	PT304	TC413-CPE10	
C-30-B		PT-86.....	PT86-HD	P-197		T-305-M.....	T304-M*	TC413-CPE10AS	
C-31-B		PT-87.....	PT87-S	C200-K		T-306-M		TS413-CPE50	
C-32-B		PT-87-HD.....	PT87-S	P-200.....	C200-K*	T-307-M		TS413-CPE75	
PT32-H		PT88.....	PT88-HD	T-200-K.....	C200-K*	P315		F-414-B	
C-33-B		PT-90.....	PT90-10	B-201.....	B201-S	PT317.....	PT317-MPG	PF-414-10	
P-33.....	C-33-B*	PT92		C-201-K.....	P42	PT318.....	PT318-MPG	PF-414-15	
C-34-M		PT94		P-202.....	PT154	PT319.....	PT319-MPG	PF-414-25	
P-34		B95-B.....	B95	P-202-S		PT320.....	PT320-MPG	PF-415.....	P415-5
B-35.....	B35-S	B95-HPG.....	B95-SS	P-205		BD321.....	BD325	P-415-2A.....	P415-5A
C-35-M		C-95-IL		PT-208-10		BD322.....	BD232	S-416.....	PT416
C36-M		B96-B.....	B96	P-209		BD323.....	BD232	S417	
P-36.....	C36-M*	B96-HPG.....	B96-SS	PT-211		C327-O		S-418	
C-37-M		B-96 Kit.....	BK6311*	PT-212.....	PT212-5	B328.....	BT8417	S419	
P-37.....	C-37-M*	C-96-IL		PT-215.....	P41	BF335		PT-420	
B38		B97-B.....	B97	PT-216.....	P198	BT-344.....	BT344-S	S-421.....	PT435
V-39-A.....	B39	C-97-G		P-217		BT-352.....	BT486	S422	
C-40-F.....	P40	B99-HPG.....	B99-SS	C-218-A		BT-356.....	BT292	S-424	
C-41-F.....	P41	C-100-C		P219		BF362.....	BF7629	PT-425	
C-42-F.....	P42	C-101-W.....	T101-W* w/G115-A	V-220-R		BF363.....	BF984	S-426	
B43.....	B43-S	PT-101.....	T101-W*	V-221-R		PT384		S-427	
PT-43.....	PT29	T101-W		F-222-P		PT390.....	PT390-MPG	BT428.....	BT372-MPG
T44-M		C-102-W		P-223		PT391.....	PT391-MPG	V-428-B	
PT-45		T-103-W.....	P42 w/G143	F225-F.....	PF225	PT-394.....	P194-HD	V-428-FF	
T-45-F.....	PT-45*	P-105		F226-F.....	PF226	PT-394-5		V-429-BP.....	V429-B
PT46		P107		PT-227		PT399.....	P7003	PF-430	
T-46-F.....	PT46*	P-109		P-228.....	P190	WG-400		PT-430-B	
C-47-P.....	P47	C-229-A		C-229-A		PT401.....	PT401-MPG	PT432	
C-49-F		P-113		P-230		WG-401		S-433	
C-50-MH		V-117-F.....	PT117	B-232.....	B233	WG-402		PT-436-WO.....	PT436
PT-51.....	T51-M*	V-118-MN		B233-HPG		WG-403		S-438	
T51-M		PT-119-5DL.....	(2) PT119-5	V-233-F.....	B233	WG-404		PT-439-HD20	
C-52-MS.....	P52	PT-119-5TR.....	(3) PT119-5	B-234.....	B296	JC-405-B.....	JC405	PT-439-HD40.....	PT-439-HD20*

* These Part Numbers are also Obsolete.



WARNING: These products can expose you to chemicals, including Diisononyl Phthalate, Carbon black extracts, Nickel, 1,3 Butadiene, Ethylene Oxide, Epichlorohydrin, which are known to the State of California to cause cancer, and Bisphenol-A, Ethylene Glycol, Ethylene Oxide, 1,3 Butadiene, Epichlorohydrin, which are known to the State of California to cause birth defects or other reproductive harm. For more information go to www.P65Warnings.ca.gov.

BALDWIN OBSOLETE PRODUCTS

OBSOLETE NUMBER	REPLACED BY	OBSOLETE NUMBER	REPLACED BY	OBSOLETE NUMBER	REPLACED BY	OBSOLETE NUMBER	REPLACED BY	OBSOLETE NUMBER	REPLACED BY
S-440		PT-530	PT390* or PT391*	PA-661		C-750-EP		PF-853	
S-441		S-530		PA-663	PA675	C-750-L Poly	C750-L	PF-854	
PT442	PT442-MPG	PT531		PA-664	PA664-1*	C-750-LS	C750-L	V-854-O	V854-T*
S-442		S-531		PA664 Foam	PA664-1 FOAM*	F-750-L	P7500	V854-T	
S-443		PT-532-10	PT482*	PA664-1		PT754		PF-855	
S444		S-532		PA-664-1 Ele.		PT755		PF-856	PF859
PT445	PT445-MPG	PT533	PT8331-MPG	PA664-1 FOAM		PT756		PF-858	
S-445	S423	S-533		PA-664-1 Scr.		PT-757-5		F-861-C	
S-447	S444*	P540-S	P540	PA-665		BT758	BT8850-MPG	F-862-C	F924-C*
S448		PT542		PA-667		C759		F-863-C	
PT449		PT544		PA-668		PT-760	PT760-10 or PT760-25	PF-865	
PT-452		PT-544-10		PA-672		PT762		BF867	BF7713
BT453	BT260-10	PT-547		PA-673		PT769	PT8395 or PT8396	F-867-M	
PT-453		PT552		PA-674		BT770	BT8861	PF-867	
PT-454		PT-553-10		PA-676		BT771	BT8863	PF-868	
P457		BT-556		PA-679		PT773	PT773-MPG	PF870	PF7521*
PT457	PT457-MPG	PT557-10		PA-681		PT776	PT776-MPG	F871-F	
S458		PT559		PT681	PT23489-MPG	V-780-S		F-872-A	
T-460-PE		PT562		PA-682		BF785-MPG		PF-873	
TB460-CPE25		PT569-10		PA-682(2)		BF787	BF1280	BF875	
BT464	BT8860	P-570		PA-683		BF793		BF876-B	BF876
P-464		PT570-10		PA-684		BF796	BF7546	BF877-B	BF877
PT465		PT572-10		PT684	PT8400-MPG	BF799-D	BF7639-D	BF878-F	
P-466		PT574-10		PA-685		F800-A		BF880	BF880-FP
P-467		PT575		PT685	PT685-MPG	F801-P		PF-880	
PT467	PT467-MPG	B-576 Kit		PA-686		F-802-A	PF802	PF-881	
PT468	PT468-MPG	BF580	BF5800	PT686		F-803-A		PF-885	
T-468-R		BF580-B	BF5800-B*	PA-687		PF803		BF887	
P-470		BF581	BF5810	PT687		F-804-A	PF804	BF889	
PT-472 Kit		BF581-B	BF5810-B*	PA-689		F-805-A		PF-889	
S-473		PF589	PF7789*	PA-690		F-806-C		PF-893-GR	PF893
PT-474		PF589-10	PF7789-10*	PA-692		F808-A		PF-894-GR	PF894
PT478	PT478-MPG*	PF589-30	PF7789-30*	PA-694	PA642	F-808-P	PF828	BF895	
PT478-MPG		PF589-E		PA695		F-809-P	PF809	PF-895	
S-478		PF589-30E		PA-698		F-811-A		SF-898-GR	SF898
PT-481	P446	PF590	PF7790*	C701-L		PF-812	PF906	F901-C	
PT482	PT482-MPG*	PF590-10	PF7790-10*	C702-L		F813-F		F902-C1	
PT482-MPG	PT725-MPG	PF590-30	PF7790-30*	C703-L		PF-813	F813-F*	F-902-S	PF902-S
S-482		PF590-E		C-704-L Poly	C704-L	B-815-O		PF-902-3	
S-483		PF590-30E		C-704-LS	C704-L	BF815	BF7713	F-903-C	PF-903*
PT484		PA-601	PA602	F-704-L	P7040*	F-815-A		PF-903	
P-486		PF601		C705-L		F817-F		F-904-C	PF904*
PT487 KIT	PT487	PA-603		PV706-M	P706-M	F-818-A	F800-A*	PF904	
P-488		PA-605		PV-706-M Poly	PV706-M*	F-820-P	PF820-S	F905-C	
PT491(2)	(2) PT491	BT606	BT606-MPG	PT-707	PT707-HD	F-820-S		F-905-W	
BK495-A		PA-606		PT-707-10	PT707-HD10	PF-821	PF821-S	F906-C	
BK495-B		B608	B227	PT-707-HD5		F-823-P	PF823	PF-906-S	PF906
P-495		PA-608		VT-708		PF823(2)	(2) PF823-E w/5H-5601	F-910-C	PF910
PT-499	PT499-5	PA-609		C-709-L		PF823(3)	(3) PF823-E w/8M-7830	F911-C	PF926
T500-MD		BT610	BT610-MPG	VT-710		PF823(4)	(4) PF823-E w/7M-8286*	F911-DL	PF952
T502-AMD		PA-610		V-711		PF823(6)	(6) PF823-E w/G219, (2) 4L-8212-R	F-911-W	
T-503-MD		BT611	BT611-MPG	V-712		PF824(2)	(2) PF824	PF-911	F911-C* (Depth); PF926 (Paper)
V504-MD		PA-611		V-713		F828-F		V-911-C	F911-C*
P505		PA-614	PA650	P718		PF-830		F-912-W	
P-506		PA-619		V-718-FF	P718*	BF832	BF7713	PF-914	
PT508	PT508-MPG	PA-620		P-719		PF-832		R915	BF915
P-509		PA-622		P-720		F-833-P		F917-C	
PT509 Kit	PT509-MPG Kit	PA-623	PA602	PT-727	PT727-HD	F-835-M		BF918	BF918-K
T-509-E		SA-624		PT-727-10	PT727-HD10	V835-M		PT-918	
F-510-S		PA-626		PT-727-HD5		F-836-F		F-919-A6	(6) F919-C
V-510-S		PA-627		PT728	PT728-MPG	PF-837		w/(2) 7B-7635	
P-511		PA-628	PA634	V-728-O		BF-839	BT839	F-919-A9	(9) F919-C
P-511-HD		PA-629		PT730	PT8361	BF-840-K2	BF833-K2	w/2F-9341*, 2F-9342*	
F-515-O		PA-630		BT731 Kit	BT8308-MPG Kit	BF-840-K3	BF836-K3	(17) F919-C	
EL-518		PA-635	PA-603*	BT734	BT8851-MPG	BF-840-K4	BF836-K4	w/9F-1805*, 9F-1806*	
F-518-O		PA-636		V736-O		BF-841		(9) F919-C	
V-518-O		PA-637		PT-737-5		BT841		w/1H-4511*, 1H4514-R*	
B519	B1400	PA-640-HD		BT742	BT8870-MPG	V842-O	VT842-O	(3) F919-C	
P-519		PA-646	PA2007	V-743-O		F848-A		w/5B-1581, 7B-8037	
PT520-10		PA647		V743-T		PF-849	PT849	(4) F919-C	
BT523	BT8803-MPG	PA656 FOAM		BT744	BT8862	BF850		w/(2) 7B-7635	
PT-523	PT561	PA659		BT745	BT8844	BF850-K		(5) F919-C	
BT-524	B2	BF660	BF1179	BT746	BT8845	BF851	BF833	w/3H-5671*, 3H5673*	
P524	P294	PA-660		BT747	BT8846	PF-851		(6) F919-C	
EL-527		T-660-P		BT748	BT8840-MPG	PF-852		w/(2) 7B-7999*	
B530	B1402	BF661		BT749	BT8852-MPG				

* These Part Numbers are also Obsolete.



WARNING: These products can expose you to chemicals, including Diisononyl Phthalate, Carbon black extracts, Nickel, 1,3 Butadiene, Ethylene Oxide, Epichlorohydrin, which are known to the State of California to cause cancer, and Bisphenol-A, Ethylene Glycol, Ethylene Oxide, 1,3 Butadiene, Epichlorohydrin, which are known to the State of California to cause birth defects or other reproductive harm. For more information go to www.P65Warnings.ca.gov.

BALDWIN OBSOLETE PRODUCTS

OBSOLETE NUMBER	REPLACED BY	OBSOLETE NUMBER	REPLACED BY	OBSOLETE NUMBER	REPLACED BY	OBSOLETE NUMBER	REPLACED BY	OBSOLETE NUMBER	REPLACED BY
F-919-C9	(9) F919-C w/(2) 7B-7664	B-1003-N		BF1212-W		P1573		PA1729	
F-919-C10	(10) F919-C w/8F-7715*, 8F-7716*	BF1003		BF1229	BF1230*	P1574		PA-1730	
F-919-C12	(12) F919-C w/6B-2955*, 7B-8017	B-1004-N		BF1230	BF1222 or BF1222-SP	P1579		PA-1731	
F-919-C17	(17) F919-C w/2F-9228*, 2F-9231*	BF1004		BF1234	BF1205 or BF1205-SP	PF1580		PA-1732	
P-920		B1005-N		BF1235	BF1257	PF1581		PA-1733	
F921-C		BF1006		BF1236	BF7673*	PF1582		PA-1734	
F922-C		B-1007-N		BF1237	BF7674*	PF1583		PA-1736	
F923-C		BF1007		BF1238	BF7672*	PF1586		PA-1737	
F924-C	PF924	B-1008-N		F-1240-C		PF1588		PA-1738	
F-925-C		P-1010-L	P-1010-L*	V1240-O		PF1590		PA-1738(3)	
F927-C		PV-1010-L		BF1241	BF7679*	PA-1601		PA1739	
PF-928		F-1030-C		F-1241-C		PA-1604		PA-1740	
PF-929		V-1030-C		V-1241-C		PA-1605		PA-1741	
F-930-C		B1031		V-1250-O		PA-1611		PA-1741 Foam	
PF-930		B-1032		V-1251-O		PA-1612		PA-1741-WPC	
T931-3T		F-1033-O		BF1254	BF7681*	PA1616		PA-1742	
V931-W(8)		V-1033-O		BF1255	BF7677*	PA-1617		PA-1743	
V-931-W(57)	V931-W(8)*	F-1035-C		BF1259-W		PA1622		PA-1744	
F-932-C		V-1035-C		BF1260	BF1283	PA-1623-S		PA-1744-FN	
F-933-C		T-1036-B		BF1260-SP	BF1283-SP	PA-1624		PA-1744-K	
BF934		V-1037-A		BF1263-SP	BF1272-SP*	PA-1628		PA-1745	
F-934-C		V-1038-T		BF1264-SP	BF1274-SP	PA1632 FOAM		PA-1746	
P-937-C8		F-1040-O			or BF1274-SPS	PA-1638		PA-1747	
F-941-C		V1040-C		BF1272-SP	BF1272-SPS	PA-1640	PA2007	PA-1751	
BF944		F-1050-O			or BF1293-SPS	V1650-O		PA-1752	
PF-944	PF947	BF1051		F-1280-C		PA-1651(2)		PA-1753	
BF948-B	BF948	V-1055-O		BF1284-SP	BF1399-SP	PA-1652		PA-1756	
BF948-D		BF1058		CK1300	FB1301, FB1302, OB1303	PA-1654		PA-1759	
BF-948-D Kit	BF948-D*	V-1060-O				PA-1655		PA-1760	
F-949-F	PF949	V-1074-O		BF1321	BF1212	PA-1656	PA2140 (Cars) PA2139 (Comp.)	PA-1761	
P-951	PT951	BF1103		BF1322	BF5813	V-1657-O		PA-1762	
BF-953		BF1106	BF1100	BF1323	BF1214	PA1658		PA-1764	
F-954-F		BF1107	BF1155*	BF1324	BF1220	PA-1659		PA-1766	
PF-956		BF1108	BF1179	BK1327	B7577, OB1308	PA-1659		PA-1767	
BF957-B	BF957	BF1109	BF1108*	BK1328	B95, OB1303	PA-1660		PA1770	
BF-957-D Kit	BF957-D	BF1111		BF1329-O	BF46083-O	PA-1660 Special	PA2698	PA-1785	
B-958	BT839-10	BF1116	BF1120*	BF1341	BF1212	PA-1662		PA-1791	
BT-958	BT839-10	BF1117		BF1342	BF5813	PA-1665		PA-1792	
F-959-C		BF1118		BF1343	BF1214	PA-1668		PA-1793	
PF-960	P960	BF1120		BF1344	BF1220	PA-1671		PA-1796	PA1815
F961-C		BF1121	BF1123	BF1351-SP	BF9811-SP	PA-1672		PA-1796-K	PA1815
F-964-C		BF1126		BF1352-SP	BF1352-SPS	PA-1676	PA1863	PA-1799	PA1848
BF965		BF1127		BF1354-SP	BF1354-SPS	PA-1677		PA1800 FOAM	
PF-965		BF1128		BF1366	BF1366-O	PA-1678(2)		PA-1801	
PF-966		BF1129		BF1383	BF1383-O	PA-1685		PA-1803	
F-969-M		BF1130		B1401	B1400	PA-1690		PA1804	
BF972		BF1131		B1403	BD1403	PA-1691		PA1807	
BF-973	BF970	BF1133		B1404	B245*	PA-1693		PA-1808	
PF-973 Kit	PF-973*	BF1135	BF1100	B1408		PA-1694		SA-1809	
BF976-B	BF976	BF1136	BF1100	B1412	B33	PA-1695		PA1810-WPC	
F-976-W		V-1136-O		B1415		PA-1700 Ele.		PA-1811	
B-977 Kit	BK6710	BF1137	BF1100	B1420	B173-S	PA1700 FOAM		PA-1812	
BF-977		BF1138		B1423	B113	PA-1700 Scr.		PA-1813-FN	
PF-980		BF1139	BF1105	B1424		PA-1701 Scr.		PA-1820	
BF-981		BF1144	BF1100	B1427	B421	PA1702 Ele.		PA-1822	
BF982		BF1145		HC-1430		PA-1702 Scr.		PA-1829	
BF-983	BF970	BF1149	BF1191	P1439	P1445	PA-1703 Ele.		PA-1833	
BF-985	BF991	BF1152	BF1100	B1442	B1429	PA1703 FOAM		PA-1835	
PF-988		BF1153	BF1100	P1445	P7442	PA-1703 Scr.		PA-1837	
BF-989 Kit		BF1155		V1500-R		PA-1708-FN	PA2657-FN	PA-1838	
BF990		V-1155-C		V1506-FF		PA-1711		PA-1838-K	
BF-993	BF988	BF1156		V1506-R		PA1713		PA1839-FN	
PF994		BF1157	BF1100	V-1507-R		PA-1714 Ele.		PA-1842	
P-997		BF1158	BF1100	V1509-R		PA-1714 Foam		PA-1843	
P999	P999-HD	BF1162		V-1510-R	P1510	PA-1714 Scr.		PA-1844	
P-999 Kit		BF1165		PF-1510	P1510	PA-1715		LL1847-FN	
P-999-B Kit		BF1167	BF1057	V-1510-R	P1510	PA-1716		PA-1847	
B1000-CD	P996	BF1168	BF1057	V-1515-R		PA-1716-FN		PA-1850	
B1001-N		BF1169		V-1530-FF		PA-1717		PA-1853	
B-1002-CD	B1000-CD*	BF1175		V1530-R		PA-1720		PA1853-FN	
F1002-C		BF1183		F-1540-C		PA-1722		PA-1853-K	
		BF1192		P1564		PA-1723		PA-1854	
		BF1196		P1569		PA-1724		PA1855	
		BF1202	BF1237*	P1570		PA-1725		PA-1856	PA-2000*
		BF1203	BF1236*	P1571		PA-1727		PA-1862	PA1885
		BF1212-HP	BF1212	P1572		PA-1728		LL1864-FN	

* These Part Numbers are also Obsolete.



WARNING: These products can expose you to chemicals, including Diisononyl Phthalate, Carbon black extracts, Nickel, 1,3 Butadiene, Ethylene Oxide, Epichlorohydrin, which are known to the State of California to cause cancer, and Bisphenol-A, Ethylene Glycol, Ethylene Oxide, 1,3 Butadiene, Epichlorohydrin, which are known to the State of California to cause birth defects or other reproductive harm. For more information go to www.P65Warnings.ca.gov.

BALDWIN OBSOLETE PRODUCTS

OBSOLETE NUMBER	REPLACED BY	OBSOLETE NUMBER	REPLACED BY	OBSOLETE NUMBER	REPLACED BY	OBSOLETE NUMBER	REPLACED BY	OBSOLETE NUMBER	REPLACED BY
PA-1869		PA-2013	PA1802	PA2165		LL2531	PA2531	PA2941	
PA-1870		PA2014		PA2166		LL2532	PA2532	PA2965	
PA-1871		PA2015		PA2170		LL2533	PA2533	PA2966	
PA-1872		PA-2016		PA2172		PA-2537		PA2969	PA2689
PA-1874	PA1884	PA-2017		PA2173		PA2543		PA2972-FN	
PA-1876		PA-2018		PA2174		LL2555	PA2555	PA2974	
PA-1878		PA-2019		PA2175		LL2556	PA2556	PA2975	
PA-1879		PA-2020		PA2176		LL2558	PA2558	PA2983	
PA-1883		PA-2021		PA2177		PA2560		PA2985	
PA1887		PA-2022		PA2179		PA2561		PA2986	
PA-1890		PA2025		PA2180		PA2565		PA2987	
PA-1902		PA-2026		PA2184		PA2584		AD2990	
PA-1903		PA-2028		PA2185		PA2590		AK2990	
PA-1908		PA-2029		PA2187		PA2594		AD2991	
PA-1910		PA-2030		PA2188		LL2596	PA2596	AK2991	AD2991* & PA2735
PA-1914		PA-2032		PA2190		PA2597		AD2992	
PA-1917		PA-2033		PA2195		PA2603		AK2992	AD2992* & PA2737
PA-1918		PA2034		PA2197		PA-2627 Ele.		AD2993	
PA-1918-K	PA1667-FN	PA2035		PA2198		PA2639		AK2993	AD2993* & PA2625
LL1922-FN	PA1922-FN	SA-2038	SA2045 (Pad Only)	PA2199		LL2641		AD2994	
PA-1923		SA2040		PA2202		LL2641		AK2994	AD2994* & PA2738
PA-1924		PA-2043		PA2203		LL2656	PA2656	AD2995	
PA1925		SA2045		PA2205		LL2659	PA2659	AK2995	
LL1926	PA1926	SA2046		PA2206		LL2663-FN	PA2663-FN	AD2997	
PA-1927		PA-2047		PA2209		PA2671		AK2997	AD2997* & PA2739
PA-1927-FN		PA-2048	PA648	PA2210		LL2675	PA2675	AD2998	
PA-1928	PA1848	SA2048		PA2211		LL2679	PA2679	AK2998	
PA-1929		PA-2049		PA2213		PA2681		AD2999	
PA-1930-FN		PA2054		PA2217		PA2682-FN		AK2999	
PA-1931(2)		PA2055		PA2219		PA2683		AD3000	
PA-1933		PA-2056		PA2220		PA2685	LL2685	AK3000	
PA-1935		PA2057		PA2227		PA2686		HSG3000	
PA-1938		PA-2058		PA2228		PA2695		AD3001	
PA-1939		PA2059		PA2236		PA2697		AK3001	
PA-1939-FN		PA-2060		PA2238		PA2698-K		HSG3001	
PA-1939-K		PA2062		PA2239		PA2720		AD3002	
PA1942		PA2066		PA2242		LL2734	PA2734	AK3002	
PA1943		PA2078		PA2245	PA2243	PA2741	PA3467	HSG3002	
PA-1944		PA-2080		PA2246		LL2749	PA2749	HSG3003	
PA-1947		PA2082		PA2259		PA2760		HSG3004	
PA-1948		SA2086		PA2309		PA2770		HSG3005	
F-1950-O		SA2087		PA-2311-FN		LL2780	LL2503	HSG3006	
PA-1950		PA2088		LL2316	PA2316	PA2780	PA2503	HSG3007	
V1950-O		PA2089		PA-2324	PA-2324-1*	LL2783		HSG3008	
PA1954		PA2090		PA-2324-K	PA-2324-1*	PA2795		HSG3009	
PA-1955		PA-2098		PA2325		PA2802	PA3499	HSG3010	
PA-1958		PA-2101	PA2101A	PA-2326-WO	PA2326	PA2804 KIT	PA2804	HSG3011	
PA-1959		PA2105		PA2327		PA2808		HSG3012	
PA-1962		PA2108		PA-2334		PA2809		HSG3013	
PA-1964		PA2111		PA-2336		PA2810		HSG3014	
PA-1965		PA2112		PA-2324-1		PA2811		HSG3015	
PA-1966		PA2115 FOAM		PA2348-FN		PA2841		HSG3016	
PA-1968-FN		PA2118		PA-2355		PA2850		HSG3017	
PA-1968-K		PA2119		LL2357	PA2357	PA2859	PA2859-FN	HSG3018	
PA-1970		PA2120		PA-2365	PA2546	PA2863	RS2863	HSG3019	
PA1971		PA2122		PA-2366	PA2547	PA2868-FN	PA2778-FN	HSG3020	
PA1974		PA2123		PA2373		PA2879-FN		HSG3021	
LL1979-FN	PA1979-FN	PA2126		LL2382	PA2382	PA2882		HSG3022	
LL1980-FN		PA2128		LL2389-FN	PA2389-FN	PA2893	PA3477	HSG3023	
PA1983		PA2129		C2400-A		PA2894-FN		HSG3024	
PA-1986 Kit	PA1986-K	PA2130		V-2400-A	C2400-A*	PA2898		HSG3025	
PA-1987 Kit	PA-1987-K*	PA2131		PA2416	PA2845	PA2901		HSG3026	
PA-1987-K		PA2132		LL2438	PA2438	PA2907		HSG3027	
PA-1990		PA2133		PA2449-K		PA2910		HSG3028	
PA-1991-FN		PA2137		LL2461	PA2461	PA2911		HSG3029	
LL1992-FN		PA2141		LL2465	PA2465	PA2916-FN	PA3664-FN	HSG3030	
PA1992	LL1992	PA2142		PA-2470	PA2667	PA2919		HSG3031	
PA-1993	PA2546	PA2143		PA-2471	PA2668	PA2920		HSG3032	
PA-1994	PA2547	SA2144		PA2492		PA2926-FN		HSG3033	
PA-1999		PA2145		LL2494	PA2494	PA2927-FN		HSG3034	
PA-2000		PA2146		PA2501	PA3951	PA2929		HSG3035	
PA-2003		PA2151		PA-2505		PA2929-FN		HSG3036	
PA2004		PA2155		PA2506		PA2934	PA3445*	HSG3037	
PA2008 FOAM		PA2157		LL2515		PA2937	PA2698	HSG3038	
PA-2011		V-2160-O		LL2516	PA2516	PA2939	PA2855	HSG3039	
PA-2012		PA2161		LL2520	PA2520	PA2940		HSG3040	

* These Part Numbers are also Obsolete.



WARNING: These products can expose you to chemicals, including Diisononyl Phthalate, Carbon black extracts, Nickel, 1,3 Butadiene, Ethylene Oxide, Epichlorohydrin, which are known to the State of California to cause cancer, and Bisphenol-A, Ethylene Glycol, Ethylene Oxide, 1,3 Butadiene, Epichlorohydrin, which are known to the State of California to cause birth defects or other reproductive harm. For more information go to www.P65Warnings.ca.gov.

BALDWIN OBSOLETE PRODUCTS

OBSOLETE NUMBER	REPLACED BY	OBSOLETE NUMBER	REPLACED BY	OBSOLETE NUMBER	REPLACED BY	OBSOLETE NUMBER	REPLACED BY	OBSOLETE NUMBER	REPLACED BY
HSG3041	HSG3069*	AH3240		AV3316		PA3594		SA4143	
HSG3042		AH3241		AV3317		PA3599		PA4155 KIT	
HSG3043		AH3242		AV3318		PA3603		PA4186	
HSG3044		AH3243		AV3319		PA3634		OAS4200	
HSG3045		AH3244		AC3320		PA3639		OAS4201	
HSG3046		AH3245		AC3321		PA3646-FN		OAS4202	
HSG3047		AH3246		AC3322		PA3647		OAS4203	
HSG3048		AH3247		AR3323		PA3648		OAS4204	
HSG3049		AH3248		AR3324		PA3659		OAS4205	
HSG3050		AH3249		AR3325		PA3662		OAS4206	
HSG3051		AH3250		AR3326		PA3663		OAS4207	
HSG3052		AH3251		AR3327		PA3665		OAS4208	
HSG3053		AH3252		AR3328		PA3666-FN		OAS4209	
HSG3054		AH3253		AR3329		PA3673		OAS4210	
HSG3055		AH3254		AR3330		PA3677		OAS4211	
HSG3056		AH3255		AW3332		RS3702	RS3988	OAS4212	
HSG3057	HSG3070*	AH3256		AW3333		PA3751-FN		OAS4213	
HSG3058		AH3257		AW3334		PA3762		OAS4214	
HSG3059		AH3258		AW3335		PA3769		OAS4215	
HSG3060		AH3259		AW3336		PA3770		OAS4216	
HSG3061		AH3260		AW3337		PA3771		OAS4217	
HSG3062		AH3261		AW3338		PA3776		OAS4218	
HSG3063		AS3262		AW3339		PA3784		OAS4219	
HSG3064		AS3263		AW3340		PA3845		OAS4220	
HSG3065	HSG3064*	AS3264		AW3341		PA3858		OAS4221	
HSG3066	HSG3059*	AS3265		AS3343		PA3866	PA2489	OAS4222	
HSG3067	HSG3068*	AS3266		AS3344		PA3962		OAS4223	
HSG3068		AS3267		AD3345		BF-4000		OAS4224	
HSG3069		AS3268		AS3346		PF4001		OAS4225	
HSG3070		AS3269		AD3347		WF4002-M		OAS4226	
HSG3072		AS3270	AS3269*	AS3348		WF4003-M		OAS4227	
HSG3073		AS3271		PA3400		PA4004		OAS4228	
HSG3074		AS3272		PA3401		BF-4010		OAS4229	
HSG3075		AS3273		PA3402		PF4011		OAS4230	
HSG3076		AS3274		PA3403		WF4012-A		OAS4231	
AE3200		AS3275		PA3407		WF4013-A		OAS4232	
AS3200		AB3276		PA3409		PA4014		OAS4233	
AE3201		AB3277		PA3410	PA3410-FN*	PA4019		OAS4234	
AE3202		AB3278		PA3410-FN		PA4020		OAS4235	
AE3203		AB3279		PA3413		PA4026		OAS4236	
AE3204		AB3280	AB3312*	PA3418		WG-4033		OAS4237	
AE3205		AB3281	AB3314*	PA3423-FN		PA4034		OAS4238	
AE3206		AB3282		PA3424-FN		PA4036		OAS4239	
AE3207		AB3283		PA3425		PA4038		OAS4240	
AE3208		AB3284		PA3441		PA4039		OAS4241	
AE3209		AB3285		PA3445		PA4040		OAS4242	
AE3210		AC3286		PA3450		PA4047		OAS4243	
AE3211		AC3287		PA3451		PA4051		OAS4244	
AE3212		AC3288		PA3454		PA4052		OAS4245	
AE3213		AC3289		PA3459		PA4053		OAS4246	
AE3214		AC3290		PA3462		PA4054		OAS4247	
AE3215		AC3291		PA3465		PA4058		OAS4248	
AE3216		AC3292		PA3468		PA4061		OAS4249	
AE3217		AC3293		AD3522		PA4064		OAS4250	
AE3218		AC3294		AD3523		PA4067		OAS4251	
AE3219		AC3295		AD3524		PA4068		OAS4252	
AE3220		AC3296		AD3525		PA4074	PA3763	OAS4253	
AE3221		AC3297		AD3526		PA4083	PA4081	OAS4254	
AE3222		AC3298		AD3527		PA4086	PA4416 KIT	OAS4255	
AE3223		AC3299		RS3546	RS3954	PA4087		OAS4256	
AE3224		AC3300		PA3552		PA4090		OAS4257	
AE3225		AC3301		PA3561		PA4095		OAS4258	
AE3226		AH3302		PA3564	PA3606	PA4097		OAS4259	
AE3227		AH3303		PA3567		PA4098		OAS4260	
AE3228		AH3304		PA3570	PA3691	PA4101		OAS4261	
AE3229		AS3305		PA3571		PA4115	PA4154	OAS4262	
AE3230		AS3306		PA3574		PA4116		OAS4263	
AE3231		AB3307		PA3577		PA4117		OAS4264	
AE3232		AB3308		PA3582-FN	PA3671-FN	PA4122	PA4163	OAS4265	
AE3233		AB3309		PA3583	PA3672	PA4125		OAS4266	
AE3234		AB3310		PA3586		PA4135		OAS4267	
AE3235		AB3311	AB3278*	PA3589		PA4136	PA4155 KIT	OAS4268	
AE3236		AB3312		PA3590		SA4137		OAS4269	
AE3237		AB3313		PA3591		SA4139		OAS4270	
AE3238		AB3314		PA3592		PA4140		OAS4271	
AH3239		AB3315		PA3593		SA4142		OAS4272	

* These Part Numbers are also Obsolete.



WARNING: These products can expose you to chemicals, including Diisononyl Phthalate, Carbon black extracts, Nickel, 1,3 Butadiene, Ethylene Oxide, Epichlorohydrin, which are known to the State of California to cause cancer, and Bisphenol-A, Ethylene Glycol, Ethylene Oxide, 1,3 Butadiene, Epichlorohydrin, which are known to the State of California to cause birth defects or other reproductive harm. For more information go to www.P65Warnings.ca.gov.

BALDWIN OBSOLETE PRODUCTS

OBSOLETE NUMBER	REPLACED BY	OBSOLETE NUMBER	REPLACED BY	OBSOLETE NUMBER	REPLACED BY	OBSOLETE NUMBER	REPLACED BY	OBSOLETE NUMBER	REPLACED BY
OAS4273		PA4765 FOAM		PA4927		PA5307		BK6371	
OAS4274		PA4767		PA4933		RS5362.....RS30065, RS30065 KIT		BK6374	
OAS4275		PA4768		PA4936		PA5394		BK6381	
OAS4276		PA4770		PA4937		PA5402		BK6384	
OAS4277		PA4771.....PA4689		PA4940		PA5501.....RS5782		BK6385	
OAS4278		PA4774		PA4943		PA5502.....RS5783		BK6386	
OAS4279		PA4776		PA4944		RS5542.....RS30142, RS30142 KIT		BK6388	
OAS4280		PA4779		PA4946.....PA4938		RS5591.....RS5591XP		BK6389	
OAS4281		PA4780		PA4948		RS5593.....RS5593XP		BK6395	
OAS4282		PA4780 FOAM		PA4949		RS5671		BK6398	
OAS4283		PA4782		PA4950		BF5800-B.....BF5800		BK6400	
OAS4284		PA4783		PA4951.....PA4947		BF5810-B.....BF5810		BK6401	
OAS4285		PA4784		PA4952		6010		BK6404	
OAS4286		PA4786		PA4953		6011		BK6411	
OAS4287		PA4787		PA4958		6012		BK6413	
OAS4288		PA4788.....PA4389		PA4964-FN		6013		BK6416	
OAS4289		PA4789		PA4965		6014		BK6418	
OAS4290		PA4791		PA4974		6015		BK6419	
OAS4291		PA4792		PA4976.....PA3872		6016		BK6420	
OAS4292		PA4796		PA4980		6017		BK6421	
OAS4293		PA4797		PA4981		6018		BK6423	
OAS4294		PA4798		PA4982		6019		BK6430	
OAS4295		PA4799		PA4998.....PA4820		BK6200		BK6431	
OAS4296		PA4800		CS-5001		BK6203		BK6432	
OAS4297		PA4805		CS-5002.....CS5008		BK6206		BK6433	
OAS4298		PA4808		CS-5003.....CS5009		BK6209		BK6435	
OAS4299		PA4811		CS-5004.....CS5011		BK6210		BK6439	
OAS4300		PA4812.....PA3672		CS-5005.....CS5010		BK6211		BK6456	
OAS4301		PA4815		CK5006B		BK6212		BK6471	
OAS4302		PA4816		CT5006A		BK6217		BK6475	
PA4354		PA4817		CTK5006.....CTK5029		BK6220		BK6479	
PA4369		PA4818		CSC5014		BK6221		BK6481	
PA4396		PA4821		CT5026A		BK6223		BK6485	
PA4406 KIT		PA4822		CT5026B		BK6226		BK6496	
PA4407		PA4826		CTK5026.....CTK5029		BK6227		BK6498	
PA4408		PA4828		CTK5027.....CTK5029		BK6229		BK6500	
PA4415		PA4835		LB-5100 Kit		BK6230		BK6504	
PA4420		PA4836		WF5100		BK6231		BK6509	
PA4424		PA4837		WF5101		BK6233		BK6510	
RS4584.....RS4634		PA4838		BW-5120		BK6236		BK6511	
PA4640.....PA4640-FN		PA4839		BWC-5120		BK6237		BK6514	
PA4670		PA4840		BW-5121		BK6238		BK6516	
PA4684		PA4841		BWC-5121		BK6239		BK6520	
PA4685		PA4842		C5130-P		BK6240		BK6523	
RS4686.....RS4678		PA4843		CW5130-P		BK6243		BK6526	
RS4687.....RS4679		PA4844		CW-5130-PWP.....CW5130-P* & WF4002-M*		BK6247		BK6530	
PA4689 FOAM		PA4845		CWC-5130-P		BK6254		BK6531	
PA4690		PA4846		CWC-5130-PWP		BK6259		BK6534	
PA4691		PA4847		CW5131-P		BK6260		BK6537	
PA4699		PA4850		CWC-5131-P		BK6261		BK6540	
PA4710		PA4851		CW-5132-P.....(2) CW5131-P*		BK6266		BK6547	
PA4712		PA4854 FOAM		CW5132-PWP.....(2) CW5131-P* & WF4003-M*		BK6269		BK6553	
PA4717		PA4856		CWC-5132-P		BK6271		BK6555	
PA4718		PA4868-FN		BW-5133.....BW5139		BK6284		BK6556.....BK6575*	
PA4719		PA4869		BW-5133-A.....BW-5133*		BK6289		BK6557	
PA4721		PA4875		BW-5133-Z.....BW-5133*		BK6300		BK6558	
PA4722-FN		PA4880		BWC-5133		BK6301		BK6565	
PA4724-FN		PA4882		BW-5133-Z.....BW-5133*		BK6302		BK6573	
PA4725		PA4884		BWC-5133		BK6303		BK6575	
PA4726		PA4892		BWC-5133-Z		BK6310		BK6580	
PA4728		PA4894		BW-5134.....BW5137		BK6311		BK6582	
PA4739		PA4898		BW-5134-Z.....BW-5134*		BK6312		BK6584	
PA4742		PA4901		BWC-5134		BK6313		BK6585	
PA4744		PA4904		BW-5135.....BW5136		BK6314		BK6588	
PA4745		PA4909		CW5150-L		BK6316		BK6589	
PA4746		PA4913		BW5170.....BW5070		BK6317		BK6590	
PA4747		PA4914		BW5171.....BW5071		BK6318		BK6592	
PA4748		PA4915		BW5173.....BW5073		BK6321		BK6593	
PA4748 FOAM		PA4916		BW5174.....BW5074		BK6327		BK6594	
PA4749		PA4917		BW-5176.....BW5178		BK6342		BK6596	
PA4751		PA4920		BW-5177.....BW5179		BK6348		BK6602	
PA4752		PA4921		BW5180		BK6350.....BK6371*		BK6603	
PA4757		PA4922		BW5181		BK6351		BK6604	
PA4759		PA4923				BK6352		BK6605	
PA4761		PA4924				BK6355		BK6606	
PA4762 FOAM		PA4926				BK6370		BK6609	

* These Part Numbers are also Obsolete.



WARNING: These products can expose you to chemicals, including Diisononyl Phthalate, Carbon black extracts, Nickel, 1,3 Butadiene, Ethylene Oxide, Epichlorohydrin, which are known to the State of California to cause cancer, and Bisphenol-A, Ethylene Glycol, Ethylene Oxide, 1,3 Butadiene, Epichlorohydrin, which are known to the State of California to cause birth defects or other reproductive harm. For more information go to www.P65Warnings.ca.gov.

BALDWIN OBSOLETE PRODUCTS

OBSOLETE NUMBER	REPLACED BY	OBSOLETE NUMBER	REPLACED BY	OBSOLETE NUMBER	REPLACED BY	OBSOLETE NUMBER	REPLACED BY	OBSOLETE NUMBER	REPLACED BY
BK6611		P7254		BF7673	BF7673-D	H8044	H9044	H8120	
BK6612		P7257		BF7674	BF7674-D	H8045	H9045	H8121	
BK6614		P7258		BF7675	BF7675-D	H8046	H9046	H8122	
BK6660		P7266		BF7677	BF7677-D	H8047	H9047	H8123	H9123
BK6669		B7272	B7402	BF7679	BF7679-D	H8048	H9048	BT8300	BT8871-MPG*
BK6671		B7278		BF7681	BF7681-D	H8049	H9049	BT8303	BT8304
BK6674		B7279		BF7682	BF7682-D	H8050	H9050	BT8311	BT8873
BK6701		B7282		PF7688	PF7688	H8051	H9051	BT8313	BT8874-MPG
BK6708		B7284		BF7689	BF7689	H8052	H9052	BT8315	BT8512
BK6709		B7288	B7217	BF7710	BF7765	H8053	H9053*	PT8321	PT8378-MPG
BK6712		B7296		BF7723		H8054	H9054	BT8324	
BK6718		P7300	P1562	BF7724		H8055	H9055	BT8325	
BK6742		P7301		BF7727	BF7827*	H8056	H9056	BT8327	BT8856-MPG
BK6788		C7304		BF7739	BF7801	H8057	H9057	PT8336	
BK6792		BT7339	BT7349	PF7789	PF7889	H8058	H9058	PT8337	
BK6793		BD7353	BD40027	PF7789-10	PF7889-10	H8059	H9059	BT8340-MPG	BT8876-MPG
BK6800		P7354	P40019	PF7789-30	PF7889-30	H8060	H9060	C8342	
BK6802		P7371		PF7790	PF7890	H8061	H9061	PT8343	
BK6804		P7405	P7505	PF7790-10	PF7890-10	H8062	H9062	PT8358	
BK6806		B-7500	B7500A*	PF7790-30	PF7890-30	H8063	H9063	BT8360	BT8871-MPG
BK6807		B-7500 Kit		BF7827	BF9882	H8064	H9064	PT8362	
BK6808		B7500A		PF7831		H8065	H9065	PT8364	PT8370-MPG
BK6810		B7500A-CH		PF7835		H8066	H9066	PT8374-MPG	
BK6811		B-7500-CH	B7500A-CH*	BF7846		H8067	H9067	PT8377-MPG	BT8853-MPG
BK6818		B-7500-PR	B7500A*	BF7856		H8068	H9068	BT8379	BT8437
BK6826		BF7500	BF7500-A*	BF7858	BF7693	H8069	H9069	BT8380	PT8380
BK6829		BF7500-A		BF7867		H8070	H9070	BT8399	BT8444
BK6830		BH-7500	B7500A*	BF7868		H8071	H9071	PT8405-MPG KIT	PT8515-MPG KIT*
BK6831		BH-7500-CH	B7500A-CH*	PF7902	FD7926 & BF7925	H8072	H9072	PT8406-MPG KIT	PT8516-MPG KIT*
BK6832		BH-7500-PR	B7500A*	BF7918	BF7972	H8073	H9073	BT8434	B114
BK6834		C-7500-M	P7500	BF7933 KIT	BF9918 KIT	H8074	H9074	BT8454	BT9422
BK6838		P7500 POLY	P7500	BF7953-D	BF7951-D	H8075	H9075	PT8469-MPG	
BK6839		P7500 SINGLE	P7500	H8000		H8076	H9076	PT8515-MPG KIT	PT9415-MPG KIT
BK6900		EL7518		H8001	H9001	H8077	H9077	PT8516-MPG KIT	PT9416-MPG KIT
BK6901		PF7520	PF7799	H8002		H8078	H9078	OS8702	
BK6902		PF7521	PF7655	H8003		H8079	H9079	OS8718	
BK6906		BF7523		H8004		H8080	H9080	OB8726	
BK6907		BF7524	BF788	H8005		H8081	H9081	OB8740	
BK6908		BF7525	BF970	H8006	H9006*	H8082	H9082	OB8746	
BK6939		BF7526	B605	H8007	H9007	H8083	H9083	OB8781	
BK6940		BF7530-MPG	BF7632	H8008		H8084	H9084	OB8783	
BK6941		BF7533	BF7535	H8009		H8085	H9085	BT8806-MPG	
B7006		BF7539	BF7644	H8010	H9010*	H8086	H9086	BT8807-MPG	BT8800-MPG
B7008-D	B7019	BF7542		H8011		H8087	H9087	BT8860	BT8861
B7026	B7026-MPG	BF7543		H8012		H8088	H9088	BT8871-MPG	BT8876-MPG
B7027	B7085*	PF7547		H8013	H9013	H8089	H9089	BT8923	
B7032	B7130	PF7548	PF7620* (Cat, Cummins)	H8014	H9014	H8090	H9090	BT8924	
B7040	B7040-A*		PF7621* (Detroit)	H8015		H8091	H9091	BT8925	
B7040-A		K-7550 Kit	BK6355*	H8016		H8092	H9092	BT8929	
B7040-CH	B7040-A*	BF7557-B	BF7557	H8017		H8093	H9093	BT8932	
B7040-PR	B7040-A*	B7575	B7577	H8018	H9018	H8094	H9094	BT8933	
BF7040		B7577-B	B7577	H8019		H8095	H9095*	BT8934	
BH7040	B7040-A*	K-7577 Kit	BK6401	H8020	H9020	H8096	H9096	BT8936	
BH7040-CH	B7040-A*	PF7578	PF7678	H8021	H9021	H8097	H9097	PT8942-MPG	
BH7040-PR	B7040-A*	BF7581	BF7646*	H8022		H8098	H9098	PT8944-MPG	
F7040		BF7582	BF7647*	H8023		H8099	H9099	PT8949-MPG	
P7040	C704-L	K-7596 Kit	BK6350*	H8024	H9024	H8100	H9100	PT8953-MPG	
P7040 POLY	P7040*	P7599		H8025		H8101	H9101	PT8961-MPG	PT9337-MPG
BD7041	BD7166	BF7601	BF954	H8026		H8102	H9102	PT8964-MPG	PT9403-MPG
B7043		PF7610	PF7651*	H8027		H8103	H9103	PT8965-MPG	
B7046		PF7611		H8028		H8104	H9104	PT8966-MPG	
B7085	B7144	PF7620	PF7680	H8029	H9029*	H8105	H9105	PT8968-MPG	
P7087		PF7621	PF7680	H8030		H8106	H9106	PT8973-MPG	PT8458-MPG
P7088		P7642		H8031		H8107	H9107	PT8976-MPG	
B7079		BF7643	BF7682*	H8032		H8108	H9108	PT8977-MPG	
BD7100		BF7646	BF7674*	H8033		H8109	H9109	PT8979-MPG	
B7108	B7004	BF7647	BF7681*	H8034		H8110	H9110	PT8983-MPG	
B7109	B7585	BF7649	BF7672*	H8035		H8111	H9111	PT8988-MPG	
B7118	B7144	BF7650	BF7679*	H8036	H9036	H8112	H9112	PT9000-MPG	
BC7140	BC7194	PF7651	PF7751	H8037	H9037	H8113	H9113	H9006	
B7149		BF7652	BF7674-D	H8038		H8114	H9114	H9010	
B7150	B7180	PF7654	PF7777	H8039	H9039	H8115	H9115	H9015	
P7198	P1443	BF7660	BF1163	H8040	H9040	H8116	H9116	H9018	
BT7237-MPG	BT7237	BF7662		H8041	H9041	H8117	H9117	H9029	
BD7244	BD7105	BF7665	BF7675*	H8042	H9042	H8118	H9118	H9040	
C7253		BF7672	BF7672-D	H8043	H9043	H8119	H9119	H9042-V	

* These Part Numbers are also Obsolete.



WARNING: These products can expose you to chemicals, including Diisononyl Phthalate, Carbon black extracts, Nickel, 1,3 Butadiene, Ethylene Oxide, Epichlorohydrin, which are known to the State of California to cause cancer, and Bisphenol-A, Ethylene Glycol, Ethylene Oxide, 1,3 Butadiene, Epichlorohydrin, which are known to the State of California to cause birth defects or other reproductive harm. For more information go to www.P65Warnings.ca.gov.

BALDWIN OBSOLETE PRODUCTS

OBSOLETE NUMBER	REPLACED BY	OBSOLETE NUMBER	REPLACED BY	OBSOLETE NUMBER	REPLACED BY	OBSOLETE NUMBER	REPLACED BY	OBSOLETE NUMBER	REPLACED BY
H9053		18005		19861		100-MPC		300-DR5220	
H9095		18006	18033	19879		100-W/O		300-DRA	
PT9124-MPG		18008	18022	19887		100-W/OBP		300-MBP	
PT9125		18009		19895		101-A		300-MF	
PT9128		18011		19909		140 KIT		300-MF3	
PT9133		18012		19917		140-12		300-MM	
PT9138		18013		19925		140-25 KIT		300-MM30	
PT9141		18014		19933		143-6L KIT		300-MMV3-30	
PT9146		18016		19941		143-6L9 KIT		300-MMV3BP	
PT9151		18017		19950	18032	150-10		300-MMV30	
PT9156		18018		19968	18032	150-14		300-MPC	
PT9160		18019		19976		150-15	150-GK	300-SB	
PT9166		18020		19984		150-16		300-SB5	
PT9173		18021		19993		150-17	150-GK	300-SB12V	
PT9177		18023		19994		150-22	150-GK	300-SB22	
PT9184		18026		19995		150-24		300-SBBP	
PT9192		18028		19997		150-32	150-GK	300-SR	
PT9194		18030		19998	18010	150-35		300-W	
PT9201		18031		20006		150-AL		500-BK1	
PT9204		18040		20007		150-BP		500-MFVBP	500-MFVBP22
BT9211	BT8474	18058		20018		150-HBP		500-SBBP W/O	
PT9216		18066	18155	PT23268-MPG	H9001	150-MFV		1010-6x4	
PT9218		18074		PT23466	PA4876	150-W		1010-6x4DTD	
PT9219		18082		OAS98051	OAS98057	186-11		1010-6x6	
PT9220		18091		PT23466	PA4876	186-12		1010-6x6DTC	
PT9226		18112		OAS98055	OAS98010	186-21		1010-6x6DTD	
H9229		18121		OAS99000		186-22		1010-10x8	
H9230		18139		OAS99007		200-10P		1010-10x8DTA	
H9232		18147		OAS99009		200-11	200-GK	1010-10x8DTB	
H9233	PT320-MPG	18163		OAS99012		200-12	200-GK	1010-10x8DTC	
H9234		18180	18025	OAS99013		200-13	200-GK	1010-10x8DTD	
PT9235-MPG	PT9350-MPG	18201		OAS99022		200-14		1010-10x10	
PT9241		18210		OAS99026		200-16		1010-10x10DTB	
PT9243		18228		OAS99027		200-17	200-GK	1010-12x10	
PT9249		18253		OAS99030		200-18		1010-12x10DTB	
PT9252		18254	18264	OAS99033		200-19A	200-GK	1010-12x12	
PT9253-MPG		18255	18265	OAS99036		200-20		1010-12x12DTB	
PT9262-MPG		18256		OAS99039		200-22	200-GK	1015-DDT	
PT9263		18257		OAS99041		200-23	200-GK	1015-F	
PT9265		18258		OAS99044		200-24	200-DEPR KIT	1020-6x4	
PT9269		18261		OAS99045		200-25,26,27	200-DEPR KIT	1020-6x6	
PT9270		18262		85-VK6x6		200-30T		1020-10x8	
PT9271		18266		85-VK10x8		200-32	100-GK, 150-GK, 200-GK	1020-10x10	
PT9273		18268		85-VK10x10				1020-12x10	
PT9274		18269		85-VK12x10		200-33		1020-12x12	
PT9275		18270		85-VK12x12		200-34		1028-F	
PT9276		18273		100-10	100-MNTG KIT	200-AL		1030-4x4	
PT9280		18274		100-11	100-MNTG KIT	200-BP		1030-6x6	
PT9281		18275		100-13		200-CUT		1030-8x8	
PT9292-MPG		18277		100-14		200-DGK		1030-10x10	
PT9294-MPG		18278		100-15	100-GK	200-HBP		1030-12x12	
PT9298-MPG		18281		100-16		200-HN		1040-6x4	
PT9299-MPG		18283		100-17	100-GK	200-M30		1040-6x4B	
PT9301-MPG	PT9359-MPG	18284		100-19	100-GK, 150-GK	200-MBP		1040-6x6	
H9305		18286		100-20		200-MMV30		1040-10x6	
PT9314-MPG		18287		100-21H		200-MPC		1040-10x8	
PT9317-MPG	PT8975-MPG	18288	18024	100-21HBP		200-SR		1040-10x12	
BT9319-MPG		18289		100-22	100-GK, 150-GK, 100-DEPR KIT	200-W		1040-12x8	
BT9322		18290		100-23	100-GK, 150-GK, 100-DEPR KIT	300-14		1040-12x12	
BT9323		18291		100-24	100-GK, 150-GK, 100-DEPR KIT	300-16		1063-BK1	
BT9325		19551		100-25,26,27	100-DEPR KIT	300-35		1063-BK2	
PT9333		19569		100-33		300-AL		1063-BK3	
PT9334-MPG		19577		100-35		300-BP		1063-D	
PT9336		19585		100-36		300-DB		1063-F	
PF9806 KIT	PF9924 KIT	19607	18112	100-33		300-DB W/O		1072-B	
CA9872		19615	19739	100-35		300-DB5		DEMO-100 MINI	
V-1240-O1		19623		100-36		300-DB5 W/O		EA-002	
PF-1510-7		19631		100-AL		300-DB5220		EC-005	
PA-1612-1A	PA1754	19640		100-BMK		300-DBA		EC-112	
PA-1620-2S	PA1620-S	19658		100-BMKBP		300-DBA5		EM-03D11	
PA-1636-2		19666		100-BMKH		300-DBA220		EM-05D11	
PA-1636-2K		19674		100-CUT		300-DR		HH4	
PA-1728-1		19682		100-DGK		300-DR W/O		HH6	
18000		19691		100-HBP		300-DR5		HH8	
18001		19801		100-M30		300-DR5 W/O		HH10	
18002		19852		100-MMV30		300-DR220		HH12	
				100-MMVBP					

* These Part Numbers are also Obsolete.



WARNING: These products can expose you to chemicals, including Diisononyl Phthalate, Carbon black extracts, Nickel, 1,3 Butadiene, Ethylene Oxide, Epichlorohydrin, which are known to the State of California to cause cancer, and Bisphenol-A, Ethylene Glycol, Ethylene Oxide, 1,3 Butadiene, Epichlorohydrin, which are known to the State of California to cause birth defects or other reproductive harm. For more information go to www.P65Warnings.ca.gov.

ABBREVIATIONS USED ANYWHERE IN OUR CATALOGS

2WD2-Wheel Drive	EHSSElectro-Hydraulic Shuttle Shift	J.C.W.John Cooper Works	PSRPost Seal Required
4WD4-Wheel Drive	Ele.Element	JDJohn Deere	Pt.Pint
A. Gskt.Attached Gasket(s)	Elec.Electric	JICJoint Industry Conference	PTOPower Take-Off
ABSAnti-Lock Braking System	E.M.D.Electro-Motive Division	Jr.Junior	PZEVPartial Zero Emissions Vehicle
ADAnti-Drainback Valve	Eng(s)Engine(s)	KHDKlockner-Humboldt-Deutz	QR/SRQuad Range or Syncro Range
ADPAnti-Drainback Pipe	Equip.Equipment	KwKilowatt	Qt.Quart
AirCond.Air Conditioned or Air Conditioner	Etc.Et cetera (and so forth)	LLiters	Qty.Quantity
Alum.Aluminum	EUJElectronic Unit Injector	LBPLow Pressure By-Pass Valve (2-7 PSID)	RCReinforced Centertube
AMCAmerican Motors	Exc.Except	Lb(s)Pound(s)	Recirc.Recirculation
AmpAmpere	ExHiPres.Extra High Pressure	LGPLow Ground Pressure	Rect.Rectangular
App.Approved	ExpHsg.Exposed Housing	L.H.Left Hand	Res.Reservoir
Approx.Approximately	ExpTankExpansion Tank	LoPres.Low Pressure	RetLineReturn Line
Arr.Arrangement	Ext.Extended	LPGLiquefied Petroleum Gas	R.H.Right Hand
A.T.Automatic Transmission	FFahrenheit	LPHLiters per Hour	ROPSRoll Over Protection System
ATAACAir-to-Air Aftercooling	F. DriveFinal Drive	Ltd.Limited	Rpl.Replaced, Replacement
Attach.Attachment	F. FuelFinal Fuel	M-FMassey Ferguson	rpmRevolutions per Minute
AutoTrans.Automatic Transmission	F. Gskt.Furnished Gasket(s)	MBPMedium Pressure By-Pass Valve (11-17 PSID)	R.R.Railroad
Aux.Auxiliary	FECVFront-End Check Valve	Mfg.Manufacturing	RWDRear Wheel Drive
AWDAll Wheel Drive	F-FFull-Flow	Mfr.Manufacturer	S. Eng.Starter Engine
Bbl.Barrel	FFVFlex Fuel Vehicle	MichFIPow.Michigan Fluid Power	S. FuelSecondary Fuel
BPBy-Pass Valve (8-10 PSID)	FlFuel Injection	Min.Minimum Order Quantity	S. PanShallow Pan
B-PBy-Pass	FidC/OField Change-Over	mmMillimeter	SCASupplemental Coolant Additive
BPSBy-Pass Screen	FidInst.Field Installation	M-MMinneapolis-Moline	SCRSelective Catalytic Reduction
BSPBritish Standard Pipe Thread	FPFill Port	MOMetering Orifice	Sec.Secondary
BSP-PLBritish Standard Pipe Parallel Thread	FRMFlame Retardant Media	M.T.Manual Transmission	Sgl.Single
BTA PLUSBalanced Treatment Additive Plus	Ft.Foot	Mtd.Mounted	SHBPSuper High Pressure By-Pass Valve (30-45 PSID)
BTEBalanced Treatment for Ethylene Glycol Antifreeze	FWDFront Wheel Drive	Mtr.Motor	SHOSuper High Output
BTUBritish Thermal Unit	FWSFuel/Water Separator	NPSFNational Pipe Straight Fine	SintBronzeSintered Bronze
CCelsius, Centigrade	ⓂGasket	NPTNational Pipe Thread	S/NSerial Number(s)
Calif.California	Gal.Gallon(s)	N/RNot Required	SOHCSingle Overhead Cam
Carb.Carburetor, Carbureted	GM, GMCGeneral Motors Corporation	N/SNon-Serviceable	SPSensor Port
CatCaterpillar	gphGallons per Hour	O. AirOuter Air	Spd.Speed
ccCubic Centimeters	gpmGallons per Minute	O. Gskt.Optional Gasket(s)	Spec(s)Specification(s)
CCLSClosed Center Load Sensing	Gskt.Gasket(s)	OBSObsolete	SPISequential Port Injection
CESClosed Emission System	GVWGross Vehicle Weight	O.D.Outside Diameter	Sr.Senior
CFMCubic Feet per Minute	Hgt.Height	OEOriginal Equipment	SSSSynchro Shuttle Shift
CIDCubic Inch Displacement	[H]Base or Housing Number	OEMOriginal Equipment Manufacturer	Std.Standard
CLN&RClean & Reuse Present Filter	HBPHigh Pressure By-Pass Valve (18-25 PSID)	OESOpen Emission System	Steer.Steering
CNGCompressed Natural Gas	HEUIHydraulic Electronic Unit Injector	Off-HwyOff-Highway	Sub.Substitute
Co.Company	HiHigh	OHOverhead Cam	SubLineSuction Line
COECab Over Engine	HiPerf.High Performance	OHVOverhead Valve	Sys.System
Comp.Compressor	HiPres.High Pressure	OldsOldsmobile	TBATo Be Announced
Cont'd.Continued	HLTHigh-Low Transmission	Opt.Optional	TBIThrottle Bodied Injection
Corp.Corporation	HOHigh Output	ozOunce(s)	Temp.Temperature
CPICenter Port Injection	HPHorsepower	P. CabPressurized Cab	Thd.Thread
CSCCoolant System Cleaner	Hsg.Housing	P. FuelPrimary Fuel	THMTurbo-Hydrumatic
Cu.Cubic	HVACHeating, Ventilation and Air Conditioning	Perf.Performance	TorqConv.Torque Converter
CVTContinuously Variable Transmission	HvyDty.Heavy-Duty	PCVPositive Crankcase Ventilation	Trans.Transmission
Cyl.Cylinder	Hyd.Hydraulic	PEECProgrammable Electronic Engine Control	TurboTurbocharger, Turbocharged
D. PanDeep Pan	HzHertz	Pkg.Package	UKUnited Kingdom
Dbl.Double	I. AirInner Air	Plt.Pleated	UL, U.L.Underwriters Lab Listed
DCDirect Current	I. Gskt.Integral Gasket(s)	PowBrakesPower Brakes	UNFUniversal National Fine
DDADetroit Diesel Allison	I.D.Inside Diameter	PowDr.Power Drive	U.S.United States
DEFDiesel Exhaust Fluid	IH, IHCInternational Harvester, International Navistar	PowQuadPower Quad	U.S.C.G.U.S. Coast Guard Accepted
DIDirect Injection	In.Inch(es)	PowShiftPower Shift	VVolt
Div.Division	Inc.Incorporated	PowSteer.Power Steering	VapDiv.Vapor Diverter
DOHCDual Overhead Cam	Incl.Included	Pri.Primary	Veh.Vehicle
Don.Donaldson	Ind.Industrial	PRWDPower Rear Wheel Drive	Vers.Version
ea.Each	InfoInformation	PSIntegral Post Seal Gasket	VINVehicle Identification Number
EFIElectronic Fuel Injection	Int.International	PSIPounds per Square Inch	VWVolkswagen
EGRExhaust Gas Recirculation	ISOInside-Out Flow Direction	PSIDPounds per Square Inch Displacement	w/With
	IVTInfinitely Variable Transmission		w/oWithout
			W.B.Wheel Base
			XHBPExtra High Pressure By-Pass Valve (50+ PSID)
			XPExtreme Performance
			Yd.Yard(s)

本公司目录中出现的缩写词

2WD.....二轮驱动	Exc.....例外,除了...	LPG.....液化石油气	R.R.....铁路
4WD.....四轮驱动	ExHiPres.....超高压	LPH.....每小时公升	RWD.....后轮驱动
A. Gskt.....附加垫圈	ExpHsg.....暴露外壳	Ltd.....有限	S. Eng.....起动机引擎
ABS.....防抱死制动系统	ExpTank.....膨胀容箱	M-F.....Massey Ferguson	S. Fuel.....次要燃油
AD.....防回流阀	Ext.....扩展的,伸长的	MBP.....中压旁通阀(11-17 PSI)	S. Pan.....浅油盘
ADP.....防回流管	F.....华氏	Mfg.....制造	SCA.....补充冷却剂添加剂
AirCond.....空调	F. Drive.....主减速器	Mfr.....制造厂(商)	SCR.....选择性催化减少
Alum.....铝	F. Fuel.....最终燃油	MichFIPOw.....Michigan Fluid Power	Sec.....次要的,二次的
AMC.....美国汽车公司	F. Gskt.....提供的垫圈	Min.....最低订购量	Sgl.....单
Amp.....安培	FECV.....F 前端出油阀	mm.....毫米	SHBP.....超高压旁通阀(30-45 PSI)
App.....批准	F-F.....全流式	M-M.....Minneapolis-Moline	SHO.....超高输出
Approx.....大约	FFV.....灵活燃油车辆	MO.....量孔	SintBronze.....粉末青铜
Arr.....安排	FI.....燃油喷射	M.T.....手动变速器	S/N.....系列号
A.T.....自动变速器	FIdC/O.....现场转换	Mtd.....安装的	SOHC.....单顶置凸轮轴
ATAAC.....增压中冷	FIdInst.....现场安装	Mtr.....马达	SP.....传感器端口
Attach.....附件	FP.....加油孔	NPSF.....National Pipe Straight Fine	Spd.....速度
AutoTrans.....自动变速器	FRM.....阻燃剂	NPT.....国家管材螺纹规范	Spec(s).....规格
Aux.....辅助的,辅机	Ft.....呎	N/R.....不要求的	SPI.....顺序端口喷射
AWD.....全轮驱动	FWD.....前轮驱动	N/S.....不可修复的	Sr.....高级,资深
Bbl.....桶	FWS.....燃油/水分离器	O. Air.....外部空气	SSS.....同步梭行换挡
BP.....旁通阀(8-10 PSI)	[G].....垫圈	O. Gskt.....可选垫圈	Std.....标准
B-P.....旁通	Gal.....加仑	OBS.....过时	Steer.....转向
BPS.....旁通滤网	GM, GMC.....通用汽车公司	O.D.....外径	Sub.....代替,取代
BSP.....英国标准管材螺纹	gph.....每小时加仑	OE.....原始设备	SuctLine.....进(吸)气管道
BSP-PL.....英国标准管材平行螺纹	gpm.....每分钟加仑	OEM.....原车设备生产厂	Sys.....系统
BTA PLUS.....增效平衡处理添加剂	Gskt.....垫圈	OES.....开放式排放系统	TBA.....待宣布
BTE.....乙二醇防冻剂平衡处理	GVW.....车辆最大总质量,总车重	Off-Hwy.....越野	TBI.....节气体喷射
BTU.....英国热量单位	[H].....底盘或外壳编号	OHC.....顶置凸轮轴	Temp.....温度
C.....摄氏,摄氏度	HBP.....高压旁通阀(18-25 PSI)	OHV.....顶置式气门	Thd.....螺纹
Calif.....加利福尼亚	Hgt.....高度	Olds.....Oldsmobile	THM.....涡轮增压和液压自动变速
Carb.....化油器,汽化的	HEUI.....液电电子控制泵-喷嘴	Opt.....可选,选项	TorqConv.....变矩器
Cat.....卡特彼勒	Hi.....高	oz.....盎司	Trans.....变速器,传动
cc.....立方厘米	HiPerf.....高性能	P. Cab.....密封驾驶室	Turbo.....涡轮增压器,涡轮增压的
CES.....闭路排放系统	HiPres.....高压	P. Fuel.....主要燃料	UK.....英国
CFM.....每分钟立方呎	HLT.....双(高/低)传动	PCV.....曲轴箱强制通风	UL, U.L.....安全检测实验室(美国)登记
CID.....立方吋排量	HO.....高输出	PEEC.....编程电子引擎控制	UNF.....Universal National Fine
Cin&R.....清洁后重新使用	HP.....马力	Perf.....性能	U.S.....美国
CNG.....压缩天然气	Hsg.....外壳	Pkg.....包,成套	U.S.C.G.....美国海岸警卫队接受
Co.....公司	HVAC.....取暖、通风及空调	Pltd.....边的	V.....伏,伏特
COE.....平头汽车驾驶室	HvyDty.....重型	PowBrakes.....助力制动,动力刹车	VapDiv.....蒸汽分流器
Comp.....压缩机	Hyd.....液压	PowDr.....动力驱动	Veh.....车辆
Cont'd.....续	I. Air.....内部空气	PowQuad.....PowerQuad	Vers.....版本
Corp.....公司	I. Gskt.....整体式垫圈	PowShift.....传动轴,动力换挡	VIN.....车辆识别代号
CPI.....中央端口喷射	I.D.....内径	PowSteer.....动力转向	VW.....大众牌汽车
CSC.....冷却系统清洁剂	IH, IHC.....International Harvester, International Navistar	Pri.....主要的	w/.....带有...
Cu.....立方	In.....吋	PRWD.....动力后轮驱动	w/o.....不带有...
CVT.....无级变速	Inc.....公司	PS.....整体式端口密封垫圈	W.B.....轴距
Cyl.....汽缸	Incl.....包括	PSI.....每平方吋磅	XHBP.....超高压旁通阀(50+ PSI)
D. Pan.....深油盘	Ind.....工业	PSID.....每平方英寸排量磅	XP.....极端性能
Dbl.....双	Info.....信息,资料	PSR.....要求端口密封:必须在端口安装 松弛O型环以求密封	Yd.....码
DC.....直流电	Int.....国际	Pt.....品脱	
DDA.....Detroit Diesel Allison	ISO.....内-外流方向	PTO.....取力器,动力输出装置	
DEF.....柴油机排液	IVT.....无限变速传动	PZEV.....部分零排放车辆	
DI.....直接喷射	J.C.W.....John Cooper Works	QR/SR.....Quad Range or Syncro Range	
Div.....部门	JD.....John Deere	Qt.....夸特	
DOHC.....双顶置凸轮轴	JIC.....联合工业会议	Qty.....数量	
Don.....唐纳逊(人名)	Jr.....之子	RC.....强化中央脊梁管	
ea.....每个	KHD.....Klockner-Humboldt-Deutz	Recirc.....再循环	
EFI.....电子燃油喷射	Kw.....千瓦	Rect.....矩形	
EGR.....废气再循环	L.....公升	Res.....储罐	
EHSS.....电液梭行变速器	LBP.....低压旁通阀(2-7 PSI)	RetLine.....回流管路	
Ele.....构件,元件	Lb(s).....磅	R.H.....右手,右方	
Elec.....电器,电动	LGP.....低对地压力	ROPS.....滚翻防护系统	
E.M.D.....电动汽车部	L.H.....左手,左方	Rpl.....更换,替换	
Eng(s).....引擎	LoPres.....低压	rpm.....每分钟转数	
Equip.....设备			
Etc.....等等			
EUI.....电子控制泵-喷嘴			

ABREVIATIONS UTILISEES DANS NOS CATALOGUES

2WD.....2 Roues motrices
4WD.....4 Roues motrices

A. Gskt......Joint(s) attaché(s)
ABS...système de freinage antibloquant
AD.....Clapet anti-retour
ADP.....Conduit anti-retour
AirCond......Avec air conditionné ou climatiseur

Alum......Aluminium
AMC.....American Motors
Amp.....Ampère
App......Approuvé
Approx......Environ
Arr......Arrangement
A.T....Boîte de vitesses automatique
ATAAC.....Refroidissement secondaire Air-Air
Attach......Accessoire
AutoTrans......Boîte de vitesses automatique

Aux......Auxiliaire
AWD.....Toutes roues motrices

Bbl......Corps
BP...Vanne de dérivation (55 à 69 kPa)
B-P.....Dérivation
BPS.....Crépine de dérivation
BSP...Normes britanniques de tuyaux
BSP-PL.....Filetage droit de tuyauterie aux normes britanniques
BTA PLUS.....Additif de traitement équilibré Plus
BTE.....Traitement équilibré pour antigel éthylène glycol
BTU.....British Thermal Unit

C.....Celsius
Calif......Californie
Carb....Carburateur, avec carburateur
Cat.....Caterpillar
cc.....Centimètres cubes
CCLS.....Détection de charge à fermeture centrale
CES.....Système fermé d'émissions
CFM.....Pied cube par minute
CID.....Cylindrée, en pouces cubes
CLN&R.....Nettoyer et ré-utiliser le filtre existant
CNG.....Gaz naturel comprimé
Co......Compagnie
COE.....Cabine avancée
Comp......Compresseur
Cont'd......A suivre, suite
Corp......Corporation
CPI.....Injection d'orifice centrale
CSC.....Produit de nettoyage de circuit de refroidissement
Cu......cube
CVT.....Transmission à variation continue
Cyl......Cylindre

D. Pan.....Cuvette profonde
Dbl......Double
DC.....Courant continu
DDA.....Detroit Diesel Allison
DEF.....Fluide d'échappement des diesels
DI.....Injection Directe
Div......Division
DOHC...Double arbre à cames en tête

Don......Donaldson

ea......Chacun
EFI...Injection de carburant électronique
EGR.....Recirculation des gaz d'échappement
EHSS.....Transmission électro-hydraulique automatique
Ele......Elément
Elec......Electrique
E.M.D......Electro-Motive Division
Eng(s)......Moteur(s)
Equip......Equipement
Etc......Et cetera
EUI.....Injecteur électronique
Exc......excepté
ExHiPres......Pression très élevée
ExpHsg......Carter exposé
ExpTank.....Vase d'expansion
Ext......Prolongé

F.....Fahrenheit
F. Drive.....Entraînement final
F. Fuel.....Carburant final
F. Gskt......Joint(s) fourni(s)
FECV...Clapet antiretour d'extrémité avant
F-F.....A plein débit
FFV.....Véhicule polycarburant
FI.....Injection de carburant
FidC/O.....Changement sur chantier
FidInst......Montage sur le chantier
FP.....Orifice de remplissage
FRM.....Média ignifuge
Ft......Pied
FWD.....Traction avant
FWS.....Séparateur carburant / eau

[G].....Joint
Gal......Gallon
GM, GMC...General Motors Corporation
gph.....Gallons par heure
gpm.....Gallons par minute
Gskt.....Joint(s)
GVW.....Poids Total Brut

[H].....Numéro de boîtier (Notre remplacement n'est que le filtre)
HBP.....Vanne de dérivation haute pression (124 à 138 kPa)
HEUI.....Injecteur électronique unité hydraulique

Hgt......Hauteur
Hi.....Haut
HiPerf......Haute performance
HiPres......Pression élevée
HLT...Boîte de vitesses hautes-basses
HO.....Puissance élevée
HP.....Puissance
Hsg......Carter
HVAC.....Chauffage, ventilation et conditionnement d'air
HvyDty......Service sévère
Hyd......Hydraulique
Hz.....Hertz

I. Air.....Air interne (sécurité)
I. Gskt......Joint intégral
I.D......Diamètre interne
IH, IHC.....International Harvester, International Navistar
In......Pouce
Inc......Incorporated, incorporé

Incl......Inclus, compris
Ind......Industriel
Info.....Renseignements
Int......International
ISO.....Direction d'écoulement intérieur vers extérieur
IVT...Transmission à variation infinie
J.C.W......John Cooper Works
JD.....John Deere
JIC.....Joint Industry Conference
Jr......Junior

KHD.....Klockner-Humboldt-Deutz
Kw.....Kilowatt, kW
L.....Litres
LBP.....Vanne de dérivation basse pression (14 à 20 kPa)
Lb(s)......Livre(s)
LGP.....Pression au sol faible
L.H......Gauche
LoPres......Basse Pression
LPG.....Gaz de pétrole liquéfié
LPH.....Litres par heure
Ltd......Limited, Limité
M-F.....Massey Ferguson
MBP...Valve de dérivation moyenne pression (76 à 117 kPa)
Mfg......Fabrication
Mfr......Fabricant
MichFIPow......Michigan Fluid Power
Min....Quantité minimum de la commande
mm.....Millimètre
M-M.....Minneapolis-Moline
MO.....Orifice de mesure
M.T......Boîte de vitesse manuelle
Mtd......Monté
Mtr......Moteur
NPSF...Filetage tuyauterie NPT droit fin
NPT.....National Pipe Thread
N/R.....Non requis
N/S.....Non remplaçable
O. Air.....Air extérieur
O. Gskt......Joint(s) en option
OBS.....Plus en usage
O.D......Diamètre extérieur
OE.....Equipement d'origine
OEM.....Fabricant d'équipement d'origine
OES.....Système ouvert d'émissions
Off-Hwy.....Hors route, de chantier
OHC.....Arbre à cames en tête
OHV.....Soupapes en tête
Olds.....Oldsmobile
Opt......En option
oz.....Once
P. Cab.....Cabine pressurisée
P. Fuel.....Carburant primaire
PCV...Réaspiration des gaz du carter
PEEC.....Contrôleur moteur électronique programmable
Perf......Performance
Pkg......Paquet
Pld......Plissé
PowBrakes.....Freins assistés
PowDr......Motorisation
PowQuad.....Power Quad
PowShift.....Servo commande des vitesses
PowSteer......Direction assistée
Pri......Primaire, principal
PRWD.....Roue motrice arrière
PS.....Joint intégral de montant

PSID.....Livres par pouce carré
PSR.....Joint de montant nécessaire
Pt.....Pinte
PTO.....Prise de force
PZEV...Véhicule à émissions quasi-nulles
QR/SR...Gamme quad ou gamme Syncro
Qt......Quart
Qty......Quantité
RC.....Tube central renforcé
Recirc......Recirculation
Rect......De forme rectangulaire
Res......Réservoir
RetLine.....Conduite de retour
R.H.....Droit(e)
ROPS.....Système de protection en cas de renversement
Rpl......Remplacé, Remplacement
rpm.....Tours par minute, tr/min
R.R......Train, ferroviaire
RWD.....Traction arrière
S. Eng......Moteur de démarrage
S. Fuel.....Carburant secondaire
S. Pan.....Bac peu profond
SCA.....Aditivo Suplementar para Refrigerante (ASR)
SCR...Réduction sélective catalytique
Sec......Secondaire
Sgl......Unique
SHBP.....Vanne de dérivation super haute pression (207 à 276 kPa)
SHO.....Rendement super élevé
SintBronze.....Bronze fritté
S/N.....Numéro de série
SOHC.....à cames en tête unique
SP.....Orifice de capteur
Spd......Vitesse
Spec(s)......Spécification(s)
SPI...Injection séquentielle par orifice
Sr......Senior
SSS.....Transmission synchro
Std......Standard
Steer......Direction
Sub......Remplacement
SuctLine.....Conduite d'aspiration
Sys.....Système
TBA.....À déterminer
TBI.....injection à étranglement
Temp......Température
Thd.....Pas de vis
THM.....Turbo-Hydrématique
TorqConv...Convertisseur de couple
Trans....Transmission, boîte de vitesses
Turbo.....Turbo-compresseur
UK.....Royaume-Uni
UL, U.L....Homologué Underwriters Lab
UNF.....Universal National Fine
U.S......Etats-Unis
U.S.C.G......Accepté par U.S. Coast Guard, Garde Côtière Américaine
V.....Volt
VapDiv......Dérivation de vapeur
Veh......Véhicule
Vers......Version
VIN...Numéro d'identification du véhicule
VW.....Volkswagen
w/.....Avec
w/o.....Sans
W.B......Empattement
XHBP.....Vanne de dérivation extra haute pression (plus de 345 kPa)
XP.....Ultra-performant
Yd......Yard

ABKÜRZUNGEN, DIE IN UNSEREM KATALOG VERWENDET WERDEN

2WD2-Rad-Antrieb	EHSSElektrohydraulische Wendschaltung	IVTStufenloses Getriebe	QR/SRAllradbetrieb oder Syncrobetrieb
4WD4-Rad-Antrieb	EleEinsatz	J.C.W.John Cooper Works	QtViertel Gallone
A. Gsktbeigefügte Dichtung(en)	ElecElektrik	JDJohn Deere	QtyAnzahl
ABSAntiblockiersystem	E.M.D.Electro-Motive Division	JICJoint Industry Conference	
ADRücklaufsperrventil	EngMotor	Jr.Junior	
ADPRücklaufsperrrohr	EquipAusrüstung		
AirCond.Klimaanlage	Etc.usw.	KHDKlöckner-Humboldt-Deutz	RCVerstärktes Mittelrohr
Alum.Aluminium	EU1elektronische Einspritzeinheit	KwKilowatt	Recirc.Rezirkulation
AMCAmerican Motors	Exc.außer		Rect.Rechteckig
AmpAmpere	ExHiPres.sehr hoher Druck	LLiter	Res.Behälter
Appzugelassen	ExpHsg.offenes Gehäuse	Lb(s)Pound(s)	RetLineRückfuhrleitung
Approx.ungefähr	ExpTankAusdehnungstank	LGPgeringer Bodendruck	R.H.rechts
Arr.Anordnung	Ext.erweitert	L.H.links	ROPSÜberrollkäftig
A.T.Automobilgetriebe		LoPres.Niedrigdruck	Rpl.ersetzt, Austausch
ATAACLuft-Luft-Nachkühlung	FFahrenheit	LPHLiter pro Std.	rpmUPM
Attach.Befestigung	F. DriveEndantrieb	Ltd.begrenzt	R.R.Eisenbahn
AutoTrans.automatisches Getriebe	F. FuelEndbrennstoff	M-FMassey Ferguson	RWDHinterradantrieb
Aux.Zusatz	F. Gskt.mit Dichtung ausgestattet	MBPBypass-Ventil für mittelhohen Druck (11-17 PSID)	
AWDAllradantrieb	FECVvorderes Rückschlagventil	Mfg.Herstellung	S. Eng.Anlaßmotor
	F-FHauptstrom	Mfr.Hersteller	S. Fuelsekundäres Brennstoffsystem
Bbl.Vergaser-Venturi	FFVMehrkraftstoff-Fahrzeug	MichFIPow.Michigan Fluid Power	S. PanFlache Wanne
BPBypass-Ventil (8-10 PSID)	FIEinspritzung	Min.Mindestbestellmenge	SCAErgänzende Kühlmittel-Additive
B-PBypass	FidC/OFeldwechsel	mmMillimeter	SCRSelektive katalytische Reduktion
BPSBypass-Sieb	FidInst.Feldeinbau	M-MMinneapolis-Moline	Sec.sekundär
BSPbritisches Standardrohrgewinde	FPFüllanschluß	MOkalibrierte Bohrung	Sgl.einzeil
BSP-PLbritisches Zylinderrohrgewinde	FRMSchwer entflammbares Filtermedium	M.T.Schaltgetriebe	SHBPExtremdruck-Bypass-Ventil (30-45 PSID)
BTA PLUSabgestimmter Pflegezusatz Plus	Ft.Fuß (Foot)	Mtd.befestigt	SHOSuper hohe Leistung
BTEAusgleichsbehandlung für Ethylenglykol-Frostschutz	FWDVorderradantrieb	Mtr.Motor	SintBronzeSinterbronze
BTUBritish Thermal Unit (brit. Kalorie)	FWSKraftstoff-Wasserabscheider	NPSFUS-Rohrgewindenorm NPSF	S/NSeriennummer(n)
		NPTNPT-Gewinde	SOHCeine obenliegende Nockenwelle
CGrad Celsius	[G]Dichtung	N/RNicht benötigt	SPFühreranschluß
Calif.Kalifornien	Gal.Gallone	N/SNicht wartbar	Spd.Geschwindigkeit
Carb.Vergaser, Vergaserausführung	GM, GMCGeneral Motors Corporation		Spec(s)Spezifikation
CatCaterpillar	gphGallonen pro Std.	O. Airäußere Luft	SPIsequentielle Kraftstoffeinspritzung
ccKubikzentimeter	gpmGallonen pro Min.	O. Gskt.zusätzliche Dichtung(en)	Sr.Senior
CCLSSpeicher-Lasterfassung	Gskt.Dichtung(en)	O.BSVeraltet	SSSSynchrongetriebe-Wendschaltung
CESgeschlossenes Emissionssystem	GVWBrutto Fahrzeug Gewicht	O.D.äußerer Durchmesser	Std.Standard
CFMKubikfuß pro Minute (ca. 28,317 l/min)		OEOriginalausstattung	Steer.Lenkung
CIDHubraum in Kubikzoll	[H]Gehäusenummer (unser Ersatz ist nur der Einsatz)	OEMErstausruher	Sub.Ersatz
CLN&Rderzeitigen Filter reinigen und wieder verwenden	HBPHochdruck-Bypass-Ventil (18-25 PSID)	OESoffenes Emissionssystem	SuctLineAnsaugleitung
CNGkomprimiertes Erdgas	HEUIhydraulisch-elektronische Einspritzeinheit	Off-HwyGelände	SysSystem
Co.Firma	Hgt.Höhe	OHCobenliegende Nockenwelle	TBAWird noch bekannt gegeben
COEFrontlenker	HiHoch	OHVhängende Ventile	TBIZentraleinspritzung (GM)
Comp.Kompressor	HiPerf.Hochleistung	OldsOldsmobile	Temp.Temperatur
Cont'dfortgesetzt	HiPres.Hochdruck	Opt.wahlweise	Thd.Gewinde
Corp.Gesellschaft	HLTGetriebe mit zusätzlicher Geländeübersetzung	oz.Unze	THMTurbo-Hydramatik
CPIZentraleinspritzung	HOhohe Leistung	P. CabFahrerhaus unter Druck	TorqConv.Drehmomentwandler
CSCKühlungssystemreiniger	HPPS	P. FuelPrimär-Brennstoffsystem	Trans.Getriebe
Cu.Kubik	Hsg.Gehäuse	PCVpositive Kurbelgehäuseentlüftung	Turbo[mit] Turbolader
CVTstufenloses Getriebe	HVACKlimatechnik	PEECprogrammierbare elektronische Motorsteuerung	
Cyl.Zylinder	HvyDty.hohe Beanspruchung	Perf.Leistung	UKGroßbritannien
	Hyd.Hydraulik	Pkg.Packung	UL, U.L.von Underwriters Lab aufgeführt
	HzHertz	Pitd.gefaltet	UNFUNF-Gewinde
D. Pantiefe Wanne	I. Airinnere (Sicherheits-) Luft	PowBrakesBremskraftverstärker	U.S.Vereinigte Staaten
DbI.doppelt	I. Gskt.Integraldichtung(en)	PowDr.Kraftantrieb	U.S.C.G.akzeptiert von der U.S. Küstenwache
DCGleichstrom	I.D.innerer Durchmesser	PowShiftLastschaltgetriebe	
DDADetroit Diesel Allison	I.H, IHCInternational Harvester, International Navistar	PowSteer.Servolenkung	VVolt
DEFDieselabgas-Reinigungsflüssigkeit	In.Inch (Zoll)	Priprimär	VapDiv.Dampfableiter
DIDirekte Einspritzung	Inc.eingebaut	PRWDHinterrad-Kraftantrieb	Veh.Fahrzeug
Div.Geschäftsbereich	Incl.beinhaltet	PSDichtung mit integrierter Stütze	Vers.Version
DOHCzwei obenliegende Nockenwellen	Ind.industriell	PSIDPounds pro Quadrat Zoll	VINFahrgestellnummer
Don.Donaldson	InfoInformation	PSRDichtung mit Stütze erforderlich	VVTVariable Ventilsteuerung
	Int.international	Pt.Pint	VWVolkswagen
ea.jedes	ISOStrömungsrichtung von innen nach Außen	PTOZapfwellenantrieb	w/mit
EFIElektronisch gesteuerte Kraftstoffeinspritzung		PZEVPartial Zero Emissions Vehicle (US-Standard für abgasarme Fahrzeuge)	w/oohne
EGRAbgasrückführung			W.B.Achsenabstand
			XPExtreme Performance
			XHBPExtremdruck-Bypass-Ventil (>50 PSID)
			Yd.Yard(s)

ABBREVIAZIONI USATE NEL NOSTRO CATALOGO

2WDTrazione su 2 ruote	EHSS ...Cambio shuttle elettroidraulico	JICJoint Industry Conference	PZEVPartial Zero Emissions Vehicle
4WDTrazione integrale	EleElemento	JrJunior	QR/SRRange quadrato o range sincronizzato
A. GsktGuarnizioni incluse	ElecElettrico	KHDKlockner-Humboldt-Deutz	Qt ...Quart (Misura di capacità uguale a 1,1365 litri (ingl.) e 0,9463 (am.)
ABSSistema di frenata antibloccaggio (ABS)	E.M.D.Electro-Motive Division	KwKilowatt	QtyQuantità
ADValvola di non ritorno	Eng(s)Motore/i	LLitri	RCTubo centrale rinforzato
ADPTubatura di non ritorno	EquipAttrezzatura	LBPValvola di by-pass a bassa pressione (2-7 PSID)	RecircRicircolo
AirCondAd aria condizionata oppure Condizionatore dell'aria	EtcEccetera	Lb(s)Libbre	RectForma rettangolare
AlumAlluminio	ExcEccetto	LGPPressione litostatica bassa	ResSerbatoio
AMCAmerican Motors	ExHiPresPressione altissima	L.H.Sinistra	RetLineRitorno
AmpAmpere	ExpHsgAlloggiamento esposto	LoPresBassa pressione	R.HDestra
AppApprovato	ExpTankSerbatoio di espansione	LPGGasolio liquido	ROPS ...Roll Over Protection System
ApproxCirca	ExtEsteso	LPHLitri all'ora	RplSostituito, sostituzione
ArrDisposizione	FFahrenheit	Ltd ...Società a responsabilità limitata	rpmGiri al minuto
A.TTrasmissione automatica	F. DriveCoppia al ponte	M-FMassey Ferguson	R.RLinea ferroviaria
ATAAC ...Postrefrigerazione aria-aria	F. FuelCarburante finale	MBPValvola di by-pass a media pressione (11-17 PSID)	RWDTrazione su ruote posteriori
AttachAccessorio	F. GsktGuarnizioni fornite	MfgProduzione	S. Eng.Motore aviatore
AutoTrans ...Trasmissione automatica	FECVValvola di ritegno di testa	MfrProduttore	S. FuelCarburante secondario
AuxAusiliario	F-FFlusso totale	MichFIPowMichigan Fluid Power	S. PanVaschetta poco profonda
AWDTrazione integrale	FFVFlex Fuel Vehicle	MinOrdine minimo	SCA ...Supplemental Coolant Additive
BblCilindro	FIIniezione del carburante	mmMillimetro	SCR ...Riduzione catalitica selettiva
BPValvola di bypass (8-10 PSID)	FidC/OCambiamento di campo	M-MMinneapolis-Moline	SecSecondario
B-PSchermo di bypass	FidInstInstallazione campo	MOOrifizio dosatore	SglSingolo
BSPFilettatura passo gas	FPPorta di riempimento	M.T.Trasmissione manuale	SHBPValvola di by-pass a pressione molto alta (30-45 PSID)
BSP-PL ...Filettatura passo gas parallela	FRMMezzi antifiamma	MtdMontato	SHOPotenza molto elevata
BTA PLUSAdditivo per trattamento bilanciato PLUS	FtPiede	MtrMotore	SintBronzeBronzo sinterizzato
BTETrattamento bilanciato per anticongelante a base di glicole etilenico	FWDTrazione anteriore	NPSFFilettatura per tubi nazionale dritta fine	S/NNumero di serie
BTUBritish Thermal Unit	FWS ...Separatore carburante/acqua	NPT ...Filettatura passo gas nazionale	SOHCSingolo albero a camma in testa
CCelsius, Centigrado	[G]Guarnizione	N/RNon richiesto	SPPorta sensore
CalifCalifornia	GalGallone	N/SNon idoneo al servizio	SpdVelocità
CarbCarburatore, carburato	GM, GMC ...General Motors Corporation	O. AirAria esterna	SpecSpecifica
CatCaterpillar	gphGalloni all'ora	O. GsktGuarnizioni opzionali	Spec(s)Specifiche
ccCentimetri cubi	gpmGalloni al minuto	OBSObsoleto	SPIIniezione porta sequenziale
CCLS ...Sensore di carico a centro chiuso	GsktGuarnizioni	O.D.Diametro esterno	SrSenior
CESSistema di emissione chiuso	GVWPeso lordo del veicolo	OEAttrezzatura originale	SSSCambio shuttle sincronizzato
CFMPiedi cubi al minuto	[H]Codice base o alloggiamento	OEM ...Produttore di attrezzatura originale	StdStandard
CIDPortata in pollici cubi	HBPValvola di by-pass ad alta pressione (18-25 PSID)	OESSistema di emissione aperto	SteerSterzo
CLN&R ...Pulire e riutilizzare il filtro in uso	HEUI ...Iniettore idraulico unità elettronica	Off-HwyVeicoli off-highway	SubSostituto
CNGCompressed Natural Gas	HgtHeight	OHCAlbero a camme in testa	SuctLineLinea d'aspirazione
CCoSocietà	[HiAlto	OHVValvola in testa	SysSystem
COEAutoveicolo con cabina sopra al motore	HiPerfAlta prestazione	OldsOldsmobile	TBADa comunicare
CompCompressore	HiPresAlta pressione	OptOpzionale	TBIIniezione farfalla incorporata
Cont'dContinuo	HLTTrasmissione alto-basso	ozOncia	TempTemperatura
CorpSocietà per azioni	HOAlta potenza	P. CabCabina pressurizzata	ThdFilettatura
CPIIniezione porta centrale	HPCavallo vapore	P. FuelCarburante primario	THMTurbo-Hydratic
CSCDepuratore sistema refrigerante	HsgAlloggiamento	PCV ...Ventilazione basamento positiva	TorqConvConvertitore di coppia
CuCubico	HVACHeating, Ventilation and Air Conditioning	PEECControllo motore programmabile elettronico	TransTrasmissione
CVTContinuously Variable Transmission	HvyDtyServizio pesante	PerfPerformance	TurboTurbocompressore a gas di scarico, sovralimentato con turbocompressore a gas di scarico
CylCilindro	HydIdraulico	PkgImballaggio	UKRegno Unito
D. PanVaschetta profonda	HZHertz	PitdPieghettato	UL, U.L. ...Riportato in Underwriters Lab
DbfDoppio	I. AirAria interna	PowBrakesServofreni	UNFFilettatura universale fine
DCCorrente continua	I. GsktGuarnizioni integrali	PowDrPower Drive	U.SStati Uniti
DDADetroit Diesel Allison	I.D.Diametro interno	PowQuadPower Quad	U.S.C.G. ...Accettato da U.S. Coast Guard
DEFDiesel Exhaust Fluid	IH, IHCInternational Harvester, International Navistar	PowShiftPower Shift	VVolt
DIIniezione diretta	InPollice	PowSteerServosterzo	VapDivDivertore vapore
DivDivisione	IncIncorporato	PriPrimario	VehVehicle
DOHC ...Doppio albero a camme in testa	InclIncluso	PRWD ...Trazione su ruote posteriori	VersVersion
DonDonaldson	IndIndustriale	PS ...Guarnizione integrale supporto filtro	VVIN Numero di identificazione del veicolo
eaCiascuno	InfoInformazione	PSILibbre per pollice quadrato	VVTVariable Valve Timing
EFI ...Iniezione elettronica del carburante	IntInternazionale	PSIDLibbre per pollice quadrato	VWVolkswagen
EGRRicircolo gas esausti	ISO ...Direzione flusso interno-esterno	PSRÈ necessario ermetizzare il supporto	w/Con
	IVT ...Trasmissione a variazione infinita	PtPinta	w/oSenza
	J.C.W.John Cooper Works	PTOPresenza di forza	W.BInterasse ruote
	JDJohn Deere		XHBPValvola di bypass a pressione altissima (50+ PSID)
			XPExtreme Performance
			YdIarda

ABREVIATURAS UTILIZADAS NOS NOSSOS CATÁLOGOS

2WDtração em duas rodas	EGRRecirculação de Gases de Descarga	IntInternacional	QR/SRTransmissão com relações Quad, ou Sincronizada
4WDtração nas quatro rodas	EHSSTransmissão Automática Contínua Eletrohidráulica	ISO ..Semtido do fluxo de dentro para fora	QtUm Quarto
A. GsktAcompanha Junta(s)	EleElemento	IVT ...Transmissão Infinitamente Variável	QtyQuantidade
ABS ...Sistema de Freio Antitravamento	ElecEléctrico	J.C.W.John Cooper Works	RCTubo central reforçado
ADVálvula anti-retorno	E.M.D.Divisão eletro-motiva	JDJohn Deere	Recirc.Recirculações
ADPTubo anti-retorno	Eng.Motor	JICJoint Industry Conference	Rect.Rectangular
AirCond.Ar Condicionado	Equip.Equipamento	Jr.Júnior	ResReservatório
Alum.Alumínio	EtcEtcetera	KHDKlockner-Humbold-Deutz	RetLineLinha de Retorno
AMCAmerican Motors	EUIInjetor de Unidade Eletrónica	KwQuilowatt	R.HDireita
AmpAmpere	ExcExceto	LLitros	ROPSSistema de Proteção contra Capotagem
AppAprovado	ExHiPres.Alta Pressão Extra	LBPVálvula de Contorno de Baixa Pressão (2-7 PSID)	Rpl.Substituído, Substituição
Approx.Aproximadamente	ExpHsg.Carcaça exposta	Lb(s)Libra(s)	rpmRotações Por Minuto
Arr.Arranjo	ExpTankTanque de expansão	LGPBaixa Pressão do solo	R.R.Ferrovias
A.T.Transmissão automática	ExtExtensão	L.H.Esquerda	RWDTração Traseira
ATAACPós-resfriamento ar - ar	FFahrenheit	LoPres.Presao Barxa	S. Eng.Motor de Partida
Attach.Fixação	F. Drive ...Última marcha da transmissão	LPGGás Liquefeito de Petróleo	S. FuelCombustível Secundário
AutoTrans. ...transmissão automática	F. Fuelcombustível, final	LPHLitros por Hora	S. PanCarter Raso
Aux.Auxiliar	F. Gskt.Junta(s) fornecidas	Ltd.Limitado	SCAAditivo Suplementar para Refrigerante
AWDTração em Todas as Rodas	FECVVálvula de verificação frente e verso	M-FMassey Ferguson	SCRRedução Catalítica Seletiva
BblBarril	F-FFluxo total	MBPVálvula de Contorno de Média Pressão (11-17 PSID)	Sec.Secundário
BP ..Válvula de Contorno (8-10 PSID)	FFV ..Veículo de Combustível Flexível	Mfg.Produção	Sgl.Único, Individual
B-PDesvio	FIInjeção de combustível	Mfr.Fabricante	SHBPVálvula de Contorno de Pressão Super Alta (30-45 PSID)
BPSTela de contorno	FidC/OTroca no campo	MichFIPowMichigan Fluid Power	SHOAlta Saída
BSPRosca norma Inglesa	FidInst.Instalação no campo	Min. ..Quantidade mínima de pedido	SintBronzeBronze Sinterizado
BSP-PLRosca Paralela de Tubos da Norma Britânica	FPEntrada para abastecimento	mmMilímetros	S/NNumero(s) de Série
BTA PLUSAditivo Plus para Tratamento Balanceado	FRMMeio retardante do fogo	M-MMinneapolis-Moline	SOHCComando de válvulas simples na cabeça
BTETratamento balanceado para anti-congelante Etileno Glicol	Ft.Pé	MOfuro para medição	SPSuporte do Sensor
BTUUnidade Térmica Britânica	FWDTração dianteira	M.T.Transmissão Manual	SpdVelocidade
CCelsius, Centígrado	FWSSeparador Combustível/Água	Mtd.Montado	Spec(s)Especificações
Calif.California	[G]Junta	Mtr.Motor	SPIInjeção sequencial
Carb.Carburador, Carburado	Gal.Galão	NPSFTubo Reto Fino Nacional	SrSenior
CatCaterpillar	GM, GMC ..General Motors Corporation	NPT ..Rosca para tubos, padrão USA	SSSTransmissão Automática Contínua Sincronizada
ccCentímetros Cúbicos	gphGalões por hora	N/RNão Requerido	Std.Estandar
CCLSSensor de Carga de Centro Fechado	gpmGalões por minuto	N/SNão Sujeito a Manutenção	Steer.Direção
CES ...Sistema de Emissões Fechado	GsktJunta(s)	O. AirSaída de Ar	SubSubstituto
CFMPés cúbicos por minuto	GVWPeso Bruto Vehicular	OBSObsoleto	SuctLineLinha de Sucção
CID ...Capacidade Cúbica em Polegadas	[H]Numero da carcaça (somente troca do elemento)	O.D.Diâmetro Externo	SysSistema
CLN&RLimpe e reuse o filtro	HBPVálvula de Contorno de Alta Pressão (18-25 PSID)	OEEquipamento Original	TBAA Ser Anunciado
CNGGás Natural Comprimido	HEUIInjetor Hidráulico de Unidade Eletrónica	OEMFabricante de equipamento Original	TBIInjeção de ponto simples
Co.Companhia	HgtAltura	OESSistema de Emissões Aberto	TempTemperatura
COECabina acima do motor	HiAlto	Off-HwyFora de estrada	ThdRosca
Comp.Compressor	HiPerf.Alto desempenho	OHC ...Comando de válvulas na Cabeça	THMTurbo Hidramático
Cont'd.Continuação	HiPres.Alta pressão	OHVVálvulas na Cabeça	TorqConv.Conversor de Torque
Corp.Corporação	HLTTransmissão alta e baixa	OldsOldsmobile	Trans.Transmissão
CPICorpo de injeção central	HOAlta capacidade	Opt.Opcional	TurboTurbocarregador
CSCLimpador do sistema de refrigeração	HPCavalo Vapor	ozOnças	UKUnited Kingdon
CuCúbico	Hsg.Carcaça	P. CabCabina Pressurizada	UL, U.LRegistrado pelo laboratório Underwrites
CVTTransmissão Continuamente Variável	HvyDty.Serviço pesado	P. FuelCombustível Primário	UNF ..Rosca Fina Universal Americana
Cyl.Cilindro	Hyd.Hidráulico	P.VEECControle de Motor Eletrónico Programável	U.S.Estados Unidos
D. PanCuba profunda	HVACAquecimento, Ventilação e Ar Condicionado	Perf.Desempenho	U.S.C.G.Aceito pela Guarda Costeira Americana
DblDuplo	HzHertz	Pkg.Embalagem	VVolt
DCCorrente Direta	I. AirEntrada de Ar	Plt.Plissado	VapDiv.Derivação de Vapor
DDADetroit Diesel Allison	I. Gskt.Junta inteira	PowBrakes ..Freios servo-assistidos	Veh.Veículo
DEFFluido Para a Descarga de Motores Diesel	I.D.Diâmetro Interno	PowDr.Unidade Propulsora	Vers.Versões
DIInj. Directa	IH, IHCInternational Harvester, International Navistar	PowShift ...Transmissão Automática	VIN ...Numero de Identificação do Veículo
Div.Divisão	InPolegada	PowSteer.Direção Hidráulica	VTTemporização Variável de Válvula
DOHCCame Dupla no Cabeçote	Inc.Incorporado	PriPrimário	VWVolkswagen
DonDonaldson	Incl.Incluso	PRWDTração traseira	w/Com
eacada	Ind.Industrial	PSJunta integral	w/oSem
EFI ..Injeção eletrónica de combustível	InfoInformação	PSID ..Libras por Polegada Quadrada	W.B.Distancia Entre Eixos
		PSRJunta necessária	XHBPVálvula de Contorno de Pressão Extra Alta (50+ PSID)
		Pt.Pintas	XPDesempenho Extremo
		PTOTomada de Força	Yd.Jarda(s)
		PZEV ..Veículo de Emissão Zero Parcial	

СОКРАЩЕНИЯ, ИСПОЛЬЗУЕМЫЕ В НАШИХ КАТАЛОГАХ

2WDПривод на 2 колеса	EHSSЭлектрогидравлическая передача с сервоуправлением	JICОбщая конференция представителей промышленности	RCУжесточенная центральная труба
4WDПривод на 4 колеса	Ele.Элемент	Jr.Младший	Recirc.Повторное использование
A. Gskt.Устанавливаемая прокладка (прокладки)	Elec.Электрический	KHDКомпания "Klockner-Humboldt-Deutz"	RectПрямоугольная
ABSАнтиблокировочная тормозная система	E.M.D.Отделение по работе с электрооборудованием	KwКиловатт	Res.Емкость
ADКлапан, предотвращающий слив в бак	Eng.Двигатель	LЛитры	RetLineМагистраль возврата
ADPТруба для предотвращения слива в бак	Equip.Оборудование	LBPПерепускной клапан низкого давления (2 - 7 фунт-сил на кв. дюйм)	R.H.Правосторонний
AirCond.С кондиционированием воздуха или кондиционер	Etc.И т. д.	Lb(s)Фунт(ы)	ROPSСистема защиты пассажиров при переворачивании автомобиля
Alum.Алюминий	EUIЭлектронная насос-форсунка	LGPНизкое давление на грунт	Rpl.Заменяемый, замена
AMCКомпания "American Motors"	Exc.За исключением	L.H.Левосторонний	rpmОборотов в минуту
AmpАмпер	ExHiPres.Сверхвысокое давление	L.Pres.Низкое давление	R.R.Железная дорога
App.Утвержденный	ExpHsg.Открытый корпус	LoG.Жидкий нефтяной газ	RWDПривод на задние колеса
Approx.Приблизительно	ExpTankРасширительный бачок	LPHЛитры в час	S. Eng.Двигатель стартера
Arg.Компоновка, расположение	FФаренгейт	Ltd.Ограниченный или Лимитед (составляющая названий компаний)	S. FuelВторичное топливо
A.T.Автоматическая коробка передач	F. DriveГлавная передача	M-FКомпания "Massey Ferguson"	S. PanНеглубокий поддон
ATAACВоздушное последовательное охлаждение	F. FuelТопливо после тонкой очистки	MBPПерепускной клапан среднего давления (11 - 17 фунт-сил на кв. дюйм)	SCAПрисадка для системы охлаждения (ICO)
Attach.Приложение, приспособление	F. Gskt.Поставляемая в комплекте прокладка (прокладки)	Mfg.Производственный, производство	SCRСелективное каталитическое восстановление
AutoTransАвтоматическая коробка передач	FECVПередний запорный клапан	Mfr.Производитель	Sec.Вторичный, второстепенный
Aux.Дополнительный, вспомогательный	F-FПолный расход	MichFlPow.Компания "Michigan Fluid Power"	Sgl.Одиночный
AWDПолный привод	FFVТранспортное средство, работающее на нескольких видах топлива	Min.Минимальный объем заказа	SHBPПерепускной клапан сверхвысокого давления (30 - 45 фунт-сил на кв. дюйм)
Bbl.Баррель	FlВыпуск топлива	mmМиллиметр	SHOСо сверхвысокой производительностью
BPПерепускной клапан (8 - 10 фунт-сил на кв. дюйм)	FidC/OЗамена в полевых условиях	M-MКомпания "Minneapolis-Moline"	SintBronzeСпеченная бронза
B-PСетчатый фильтр перепускного канала	FidInst.Монтаж в полевых условиях	MOКалиброванное отверстие	S/NСерийный номер (номера)
BSPБританская стандартная трубная резьба	FPЗаливное отверстие	M.T.Ручная коробка передач	SOHCОдинарный верхний распределительный вал
BSP-PLБританская трубная цилиндрическая резьба	FRMОгнезащитные средства	Mtd.Установленный	SPОтверсти датчика
BTA PLUSПрисадка Plus со сбалансированным составом	FtФут	Mtr.Двигатель	Spd.Скорость
BTEДобавка со сбалансированным составом для антифриза на основе этиленгликоля	FWDПередний привод	NPSFСтандарт США для труб NPSF	Spec(s)Характеристика (-ки)
BTUБританская тепловая единица (БТЕ)	FWSТопливный фильтр с вододелителем	NPTНормальная трубная резьба	SPIПоследовательный вырыск во впускные каналы
CЦельсий	[G]Прокладка	N/RНе требуется	Sr.Старший
Calif.Калифорния	Gal.Галлон	N/SНеобслуживаемый	SSSПередача с сервоуправлением и синхронизатором
Carb.Карбюратор, карбюрированный	GM, GMCКомпания "General Motors"	O. AirВоздух вне системы	Std.Стандарт, стандартный
CatГусеница, гусеничный ход	gphГаллоны в час	O. Gskt.Дополнительная прокладка (прокладки)	Steer.Рулевое управление
ccКубически сантиметры	gpmГаллоны в минуту	Obs.Устаревший	Sub.Заменяющий, заменитель
CCLSРаспределитель с перекрытой золотником средней частью рабочего отверстия, работающий в зависимости от нагрузки	Gskt.Прокладка (прокладки)	O.D.Внешний диаметр	SuctLineЛиния всасывания
CESЗамкнутая система выпуска отработавших газов	GVWПолная масса автомобиля	OEКомплектное оборудование	Sys.Система (Сист.)
CFMКубически футы в минуту	[H]Номер на основании или корпусе	OEMИзготовитель комплектного оборудования	TBAДолжно быть сообщено
CIDОбъем двигателя в кубических дюймах	HBPПерепускной клапан высокого давления (18 - 25 фунт-сил на кв. дюйм)	OESОткрытая система выпуска отработавших газов	TBIВырыск топлива в корпусе дроссельных заслонок
CLN&RОчистить и повторно использовать имеющийся фильтр	HEUIГидравлическая электронная насос-форсунка	Off-HwyИспользуемый вне автомобильных дорог	Temp.Температура
CNGСжатый природный (СПГ)	Hgt.Высота	ONCВерхний распределительный вал	Thd.Резьба
Co.Компания	HiВысокий	OHVКлапан верхнего расположения	THMФирменное название коробок передач "Turbo-Hydrumatic"
COEКабина над двигателем	HiPerf.Высокие эксплуатационные характеристики	OldsМарка автомобилей "Oldsmobile"	TorqConv.Гидротрансформатор
Comp.Компрессор	HiPres.Высокое давление	Opt.Дополнительный	Trans.Коробка передач
Cont'd.Продолжающийся, продолжение	HLTКоробка передач с демультипликатором	oz.Унция (унции)	TurboТурбокомпрессор, оборудованный турбокомпрессором
Corp.Корпорация	HOВысокопроизводительный	P. CabКабина с наддувом	UKСоединенное королевство (Великобритания и Северная Ирландия)
CPIВырыск в центральный канал	HPЛошадиная сила	P. FuelПервичное топливо	UL, U.L.Включенный в перечень лаборатории "Underwriters Lab"
CSCСредство очистки системы охлаждения	Hsg.Корпус	Perf.Производительность (Произв.)	UNFСтандартная мелкая резьба (UNF)
Cu.Кубический	HVACсистемы обогрева, вентиляции и кондиционирования воздуха (ОВКВ)	PCVПринудительная вентиляция картера	U.S.Соединенный Штаты Америки
CVTбесступенчатая коробка передач (БКП)	HvyDty.Предназначенный для эксплуатации в тяжелом режиме	PEECПрограммируемая электронная система управления двигателем	U.S.C.G.Принятый Службой береговой охраны США
Cyl.Цилиндр	Hyd.Гидравлический	Pkg.Комплект	VВольт
D. PanГлубокий поддон	Hz.Гц Hertz - герц	Pitd.Гофрированный, плиссированный	VapDiv.Устройство отвода паров
Dbl.Двойной	I. AirВоздух внутри системы	PowBrakesТормоза с усилителем	Veh.Транспортное средство (ТС)
DCПостоянный ток	I. Gskt.Встроенная прокладка	PowDr.Силовой привод	Vers.Версия (Верс.)
DDAКомпания "Detroit Diesel Allison"	I.D.Внутренний диаметр	PowShiftПереключение (передач) при помощи усилителя	VINИдентификационный номер автомобиля
DEFВодный раствор мочевины (BPM)	IH, IHCКомпании "International Harvester" и "International Navistar"	PriОсновной	VVTРегулирование фаз газораспределения
DIНепосредственный вырыск	In.Дюйм(ы)	PRWDСиловой привод на задние колеса	VWКомпания "Volkswagen"
Div.Отделение	Inc.Инкорпорейтид (составляющая названий корпораций)	PSВстроенная прокладка стойки	w/С (предлог)
DONCДвойной верхний распределительный вал	Incl.Включенный в комплект	PSIDФунтов на квадратный дюйм	w/oБез
Don.Компания "Donaldson"	Ind.Промышленный	PSRТребуется прокладка стойки	W.B.Колесная база
eaКаждый	InfoИнформация	Pt.Пинта	XHBPПерепускной клапан максимального сверхвысокого давления (50 и более фунт-сил на кв. дюйм)
EFIЭлектронный вырыск топлива	Int.Международный	PTOОтбор мощности	XPДля эксплуатации в сложных условиях (ЗСУ)
EGRСистема повторного сжигания отработанных газов	ISOНаправление потока "изнутри наружу"	PZEVАвтомобиль с частично нулевыми выбросами	Yd.Ярд(ы)
	IVTВариатор	QR/SRДиапазон четырехскоростной передачи или синхронизатора	
	J.C.W.John Cooper Works	Qt.Кварта	
	JDКомпания "John Deere"	Qty.Количество	

ABREVIATURAS USADAS EN CUALQUIER PARTE DE NUESTROS CATALOGOS

02WD ... Tracción sencilla a 2 ruedas	EHSS Cambio de sentido de desplazamiento electrohidráulico	JD John Deere	Qt Un cuarto
4WD Tracción doble a 4 ruedas	Ele Cartucho de repuesto	JIC Joint Industrial Conference	Qty La cantidad
A. Gskt Empaque(s) adjunto(s)	Elec Eléctrico	Jr Junior	RC Tubo central reforzado
ABS ... Sistema de frenos antibloqueo	E.M.D. División electromotriz	KHD Klockner-Humboldt-Deutz	Recirc. Recirculación
AD Válvula anti-retorno	Eng(s) Motor(es)	Kw Kilovatios	Rect. Rectangular
ADP Tubo anti-retorno	Equip. Equipo	L Litros	Res. Depósito
AirCond. Climatizado o acondicionador de aire	Etc Etcétera	LBP Válvula de desviación de baja presión (2-7 PSID)	RetLine Línea de retorno
Alum. Aluminio	EUI Inyector de unidad electrónica	Lb(s) Libra(s)	R.H. Lado derecho
AMC American Motors	Exc. Excepto	LGP Presión baja del terreno	ROPS Sistema de protección contra vuelcos
Amp Amperio	ExHiPres. Muy alta presión	L.H. Lado izquierdo	Rpl. Reemplazado, reemplazo
App Aprobado	ExpHsg. Cáster abierto	L.Pres. Presión Baja	rpm Revoluciones por minuto
Approx. Aproximadamente	ExpTank Tanque de expansión	LPG Gas de petróleo licuado	R.R. Ferrocarril
Arr. Arreglo, disposición	Ext. Extendido	LPH Litros por hora	RWD Tracción trasera
A.T. Transmisión Automotriz	F Fahrenheit	Ltd. Limitado	S. Eng. Motor de arranque
ATAAC Postrefrigeración de aire a aire	F. Drive ... Tracción de transmisión final	M-F Massey Ferguson	S. Fuel Combustible secundario
Attach. Accesorio	F. Fuel Filtro final (último)	MBP Válvula de desviación de presión intermedia (11-17 PSID)	S. Pan Un carter llano
AutoTrans. ... Transmisión automática	F. Gskt. Empaque(s) surtido(s)	Mfg. Producción	SCA Aditivo de refrigerante suplementario
Aux. Auxiliar	FECV ... Válvula de no retorno al frente	Mfr. Fabricante	SCR ... Reducción catalítica selectiva
AWD Tracción de cuatro ruedas	F-F Flujo de combustible	MichFIPow. Michigan Fluid Power	Sec. Secundario
Bbl. Barril, tambor	FFV ... Vehículo de combustible flexible	Min. Cantidad mínima a pedir	SFI Inyección secuencial de combustible
BP ... Válvula de desviación (8-10 PSID)	FI Inyección de combustible	mm Milímetro	Sgl. Sencillo
B-P Desviación	FldC/O Conversión en el campo	M-M Minneapolis-Moline	SHBP Válvula de desviación de super alta presión (30-45 PSID)
BPS Tamiz de desvío	FldInst. Instalación en el campo	MO Orificio de medición	SHO Rendimiento superalto
BSP Rosca de tubería británica estándar	FP Puerto de llenado	M.T. Transmisión automática	SintBronze Bronce sinterizado
BSP-PL Rosca paralela de tubería británica estándar	FRM Medio ignifugo	Mtd. Montado	S/N Número(s) de serie
BTA PLUS Aditivo de tratamiento equilibrado Plus	Ft. Pie	Mtr. Motor	SOHC Arbol de levas único sobre la culata
BTE Tratamiento balanceado para anticongelante de etileno glicol	FWD Tracción delantera	NPSF ... Tubería nacional recta angosta	SP Puerto del sensor
BTU Unidad térmica británica	FWS ... Separador de combustible/agua	NPT ... National Pipe Thread (Rosca nacional para tubería EE.UU.)	Spd. La velocidad
C Celsius, centígrado	[G] Empaque	N/R No se requiere	Spec(s) Especificación(es)
Calif. California	Gal. Galón	N/S No se puede reparar	SPI ... Inyección Secuencial por Puertos
Carb. Carburador, carburador	GM, GMC ... General Motors Corporation	O. Air Aire exterior	Sr. Senior
Cat Caterpillar	gph Galones por hora	O. Gskt. ... Empaque(s) opcional(es)	SSS Cambio de sentido de desplazamiento sincronizado
cc Centímetros cúbicos	gpm Galones por minuto	OBS Obsoleto	Std. Estándar
CCLS Detección de carga en posición de cierre	Gskt. Empaque(s)	O.D. Diámetro exterior	Steer. Dirección
CES Sistema de escape cerrado	GVW Peso Bruto Vehicular	OE Equipo original	Sub Sustituto
CFM Pie cúbico por minuto	[H] Número de cáster (Nuestro repuesto es sólo el cartucho)	OEM ... Fabricante de equipo original	SuctLine Línea de succión
CID ... Cilindrada en pulgada cuadradas	HBP Válvula de desviación de alta presión (18-25 PSID)	OES Sistema de escape abierto	Sys Sistema
CLN&R Limpie y reutilice el filtro instalado	HEUI Inyector de unidad hidráulica-electrónica	Off-Hwy Todo terreno	TBA A anunciarse
CNG Gas natural comprimido	Hgt. Altura	OHC Arbol de levas a la cabeza	TBI Inyección por el Cuerpo del Estrangulador
Co. Compañía	Hi Alto	OHV Válvulas a la cabeza	Temp. Temperatura
COE ... Cabina montada arriba del motor	HiPerf. Alto rendimiento	Olds Oldsmobile	Thd. Rosca
Comp. Compresor	HiPres. Alta presión	Opt. Opcional	THM Turbo-hydrumatic
Cont'd. Continua	HLT Transmisión alta-baja	oz Onza	TorqConv. Convertidor de torsión
Corp. S.A.	HO Alta capacidad	P. Cab Cabina a presión	Trans. Transmisión
CPI Inyección por Puerto Central	HP Caballaje	P. Fuel Combustible primario	Turbo Turboalimentado
CSC Limpiador del sistema de refrigeración	Hsg. Cáster del cigüeñal	PCV Ventilación positiva de cáster del cigüeñal	UK Reino Unido
Cu. Cúbico	HvyDty. Servicio pesado	PEEC Control de motor electrónico programable	UL, U.L. Registrado por Underwriters Laboratories
CVT ... Transmisión variable continua	Hyd. Hidráulico	Perf. Rendimiento	UNF ... Universal National Fine (Rosca fina nacional universal-EE.UU.)
Cyl. Cilindro	HVAC Calefacción, ventilación y aire acondicionado	Pkg. Paquete promocional	U.S. Estados Unidos
D. Pan Colector profundo	Hz Hertzio	Phtd. Plegado	U.S.C.G. Aceptado por los Guardacostas de los EE.UU.
Dbi Doble	I. Air Aire interior (forma tapón de seguridad)	PowBrakes Frenos de potencia	V Voltio
DC Corriente directa	I. Gskt. Empaque(s) integral(es)	PowDr. Unidad impulsora	VapDiv. Desviador de vapores
DDA Detroit Diesel Allison	I.D. Diámetro interior	PowQuad Power Quad	Veh. Vehículo
DEF ... Fluido para el flujo de escape de vehículos diesel	IH, IHC International Harvester, International Navistar	PowShift Velocidades hidráulicas	Vers. Versión
DI Inj. Directa	In. Pulgada	PowSteer. Dirección hidráulica	VIN Número de identificación de vehículo
Div. División	Inc. Incorporado	Pri. Primario	VW Volkswagen
DOHC ... Árbol de levas doble en la culata	Incl. Incluido	PRWD ... Tracción Trasera de Potencia	w/ Con
Don. Donaldson	Ind. Industrial	PS ... Empaque integral de sello de poste	w/o Sin
ea. Cada uno	Info Información	PSID ... Libras por pulgada cuadrada	W.B. La distancia entre ejes
EFI ... Inyección electrónica de combustible	Int. Internacional	PSR Se requiere sello de poste	XHBP Válvula de desviación de extra alta presión (50+ PSID)
EGR ... Recirculación de gas de escape	ISO Dirección de flujo de adentro hacia afuera	Pt. Pinta	XP Rendimiento extremo
	IVT Transmisión variable sin fin	PTO Toma de fuerza	Yd. Yarda(s)
	J.C.W. John Cooper Works	PZEV Vehículo de cero emisiones parciales	
		QR/SR Transmisión Quad Range o Synchro Range	

NOTES

PREFIXES AND SUFFIXES

PREFIXES

AB	Air Housing Mounting Band	H	Pall-Type Hydraulic Element
AC	Air Housing Accessory - Air Inlet Hoods or Clamps	HH	Hose
AD	Air Housing Dust Bowl, Air Filter Adapter	HSG	Air Filter Housing
AE	Air Housing Elbow	LL	Long Life Air Filter Element
AFG	Air Filter Restriction Gauge	OAS	Oil/Air Separator
AH	Air Housing Hump Hose	OB	Lube or Hydraulic Filter Base
AR	Air Housing O-Ring	OP	Plug
AS	Air Housing Sleeve, Stack Cap	OS	Electrical Indicator
AV	Air Housing Dust Ejector Valve	OTK	Oil Test Kit
AW	Air Housing Wing or Metric Nut	OV	Visual Indicator
B	Spin-on or Bag-Type Filter *	P	Paper Lube or Hydraulic Element
BA	Bag Air or Air Dryer	PA	Paper Air Element
BC	Centrifugal Element	PF	Paper Fuel Element
BD	Dual-Flow Lube Spin-on	PG	Pressure Gauge
BF	Spin-on, Can-Type or In-Line Fuel Filter	PKG	Package, Premium Item
BK	Baldwin Kit	PT	Paper Lube or Hydraulic Element
BT	Spin-on Lube or Hydraulic/Transmission Filter	PV	Paper and Vac-Cel Element *
BW	Coolant Spin-on with Chemicals	RS	Radial Seal Air Filter
C	Cotton Lube Element	S, SA, SF	Special Material *
CA	Channel Flow® Air Filter	T	Cotton Lube Element *
CFB	Coolant Filter Base	TA	Acrylic and Other Synthetic Fibers for Most Fluids; Medium Flow; 5 or 10 Micron Retention (Peco Prefix AF)
CS	Chemical Supplement	TB	Blend of Cotton and Sisal for Non-Acid Fluids; Medium to High Flow; 25 to 40 Micron Retention (Peco Prefix FTE)
CSC	Coolant System Cleaner	TC	All Cotton for Non-Acid Fluids; Low Flow Rates; 2, 5, or 10 Micron Retention (Peco Prefix FT)
CTK	Coolant Test Kit	V	Vac-Cel (Cotton) Lube Element *
CV	Crankcase Ventilation Breather	VG	Vacuum Gauge
CW	Coolant Sock-Type Element with Chemicals	VT	Vac-Cel (Cotton) Lube Element *
ES	End Seal		
F	Cotton Fuel Element		
FB	Fuel Filter Base		
FD	Fuel Filter Adapter		
G	Gasket		

SUFFIXES

Multiple letter suffixes may need to be read as single letters. Suffixes often indicate the maker of the filter housing in which the element fits. When the suffix is not used for this purpose, it most often indicates the following:

-1	Specification Change	-FN	Air Filter with Fins
-2	Double Length or Air Element with 2 Inch Pleats	-FP	Contains Fill Port
(2), (3), (4)	Number of Elements in a Kit	-H	Hydraulic Element
-3, -5, -10, -25, -30	Nominal Micron Retention	-HD	Heavy-Duty or Hydraulic
-A	Closed End, Conversion Kit, Aluminum, Version # *	-HPG	High Performance Glass Media
-AF	Normally on Air Filters	-K	Kit, Includes Reusable Parts, Fittings *
-AL	Can be Used with Fluids Containing Alcohol	-M	Magnesium, Mason Jar Screw Neck *
-B	By-Pass Lube, Boxed, Version # *	-MPG	Maximum Performance Glass Media
-BSP	British Standard Pipe	-O	Open End *
-CPE	Cotton Sock for Use with Non-Acid Fluids Flowing at Moderate Temperatures	-OPE	Orlon Sock for Use with Most Fluids; Particularly Recommended for High Heat or Acid-Content Fluids
-CS	Water Absorbent Media	-OW	Orlon Wrap
-D	Drain, Direct Mount *	-RV	Roll-Over Valve
-DL	Double Length	-S	Specification Change on Liquid Filters; Smaller, Solid Lid on Air Filters *
-DM	Drain - Marine Applications	-SP	With Sensor Port
-E	Economy or Fleet Pack *	-SPS	With Reusable Sensor Port
-F	Wound Cotton or Felt Media	-SS	Filter for Severe Service
-FF	Full-Flow Lube Element	-T	Sisal Sock for High Flow Applications *
		-V	Viton O-Ring
		-W	With Wrap, Winter - Cold Weather Applications *
		-WO	Without - See Specifications
		-WPC	With Pre-Cleaner
		XP	Extreme Performance

* See Specific Number in Product Guide for Details and Exceptions.

الحروف البادئة واللاحقة

الحروف البادئة	
AB	طوق تحميل مبييت الهواء
AC	مستلزمات مبييت الهواء - أغطية أو قاطمات مدخل الهواء
AD	مهاين مرشح الهواء
AE	كوع مبييت الهواء
AFG	مقياس تقييد مرشح الهواء
AH	خرطوم بحدبة لمبييت الهواء
AR	حلقة سد مستديرة لمبييت الهواء
AS	أغطية علوية وسفلية لجلبة مبييت الهواء
AV	صمام طرد التراب لمبييت الهواء
AW	صامولة مجنحة أو مترية لمبييت الهواء
B	مرشح لف أو مرشح جرابي *
BA	جراب الهواء
BC	جزء الطرد المركزي
BD	وسيلة التزييت بالسريان الثنائي والتركييب باللف
BF	مرشح الزيت بتركييب اللف، من نوع العلبة أو نوع التحاذي
BK	عُدّة بولدوين Baldwin Kit
BT	فلتر بتركييب اللف لنظام التزليق أو لمجموعة النقل الهيدرولي
BW	وسيلة تبريد بتركييب اللف مع المواد الكيماوية
C	عنصر تزليق قطن
CA	مرشح هواء Channel Flow®
CFB	قاعدة مرشح التبريد
CS	مضافات كيماوية
CSC	منظف نظام التبريد
CTK	عدة اختبار التبريد
CV	فتحة التهوية الخاصة بعلبة المرافق
CW	عنصر مرشح التبريد من نوع الجورب مع المواد الكيماوية
ES	مانع للتسرب عند الطرف
F	عنصر من القطن لترشيح الوقود
FB	قاعدة مرشح الوقود
FD	مهاين مرشح الوقود
G	حشوة (لمنع التسرب)
H	عنصر هيدرولي من نوع Paul-Type
HH	خرطوم
HSG	مبييت مرشح الهواء
LL	عنصر مرشح هواء طويل العمر
OAS	عازل الزيت/الهواء
OB	قاعدة مرشح الزيت أو مرشح النظام الهيدرولي
OP	توصيل
OS	المؤشرات الكهربائية
OTK	عدة اختبار الزيت
OV	المؤشرات المرئية
P	عنصر ورقي لمرشح نظام التزليق أو النظام الهيدرولي
PA	عنصر ورقي لترشيح الهواء
PF	عنصر ورقي لترشيح الوقود
PG	مقياس الضغط
PKG	عبوة، منتج ممتاز
PT	عنصر ورقي لمرشح نظام التزليق أو النظام الهيدرولي
PV	عنصر من الورق والخلايا المفرغة *
RS	مرشح هواء ذو منع تسرب قطري
S, SA, SF	مواد خاصة *
T	عنصر تزليق قطن *
TA	أكريليك وألياف اصطناعية أخرى لأكثر أنواع السوائل، تدفق متوسط، مقياس الاحتفاظ ٥ أو ١٩ ميكرون (بادئ بيكو AF)
TB	خليط من القطن والسيزال للسوائل غير الحامضية، تدفق متوسط إلى عالي، مقياس الاحتفاظ ٢٥ إلى ٤٠ ميكرون (بادئ بيكو FTE)
TC	قطن خالص للسوائل غير الحامضية، تدفق منخفض، مقياس الاحتفاظ ٢ أو ٥ أو ١٠ ميكرون (بادئ بيكو FT)
V	عنصر تزليق بخلايا مفرغة (قطن) *
VG	مقياس التفريغ
VT	عنصر تزليق بخلايا مفرغة (قطن) *

اللاحق	
-FP	يحتوي على مدخل التعبئة
-H	عنصر هيدرولي
-HD	تحميل ثقيل أو هيدرولي
-HPG	وسيط زجاجي ذو أداء عالي
-K	عُدّة، تشمل أجزاء قابلة لإعادة الاستخدام، توصيلات *
-M	مغنسيوم، مرطبان جيسون بالرقبة الملولة *
-MPG	وسيط زجاجي ذو أداء عالي
-O	نهاية مفتوحة *
-OPE	جورب من الأورلون للاستخدام مع أكثر السوائل، يفضل خاصة في حالة سخونة العالبة أو السوائل التي تحتوي على حامض.
-OW	لثيف من الأورلون
-RV	صمام انقلاب
-S	تغيير مواصفات مرشحات السوائل، أصغر، غطاء مصمت لمرشحات الهواء *
-SP	مع المدخل الاستشعاري
-SPS	مع مدخل استشعاري قابل لإعادة الاستخدام
-SS	مرشح للخدمة الشاقة
-T	جورب من السيزال لاستخدامات التدفق العالي *
-V	حلقة سد مستديرة من نوع قيتون.
-W	مع الغلاف، استخدامات الشتاء و الطقس البارد *
-WO	بدون - أنظر المواصفات
-WPC	مع مادة التنظيف الأولي
XP	الأداء الأمثل
1-2	تغيير في المواصفات
1-2	طول مضاعف أو عنصر ترشيح هواء بطيات فئة ٢ بوصة
(2), (3), (4)	عدد عناصر الترشيح في العُدّة
3-5, 10, 25, 30	المقياس المسمى للاحتفاظ بوحدة الميكرون
-A	طرف مغلق أو عدة تحويل أو ألومنيوم أو نسخة رقم *
-AF	يظهر عادة على مرشحات الهواء
-AL	يمكن استخدامه مع سوائل تحتوي على الكحول
-B	تجاوزي لنظام التزليق، في إطار، نسخة رقم *
-BSP	الأنابيب القياسية البريطانية
-CPE	جورب قطن (عنصر ترشيح) للاستخدام مع السوائل غير الحامضية المتدفقة في درجات حرارة متوسطة
-CS	وسائط ماصة للماء
-D	تصفية، تحميل مباشر *
-DL	طول مزدوج
-DM	تطبيقات الصرف - التطبيقات البحرية
-E	عبوة اقتصادية أو عبوة أسطول *
-F	وسط من قطن ملفوف أو اللباد
-FF	عنصر لنظام التزييت كالم التدفق
-FN	مرشح هواء بزعايف

* انظر الرقم المعين في دليل المنتجات للحصول على التفاصيل والاستثناءات

前缀和后缀

前缀

AB	空气滤清器外壳安装环
AC	空气滤清器外壳附件-空气进口罩或夹具
AD	空气滤清器接头
AE	空气滤清器外壳弯管
AFG	空气滤清器限流表
AH	空气滤清器外壳驼峰软管
AK	含空气滤清器接头和内空气滤芯的工具包
AR	空气滤清器 O型环
AS	空气滤清器外壳护套, 叠盖
AV	空气滤清器外壳 去尘器阀e
AW	空气滤清器外壳翼形螺母或公制螺母
B	旋装式或袋式滤清器*
BA	袋式空气滤清器
BC	离心滤芯
BD	双向流润滑油旋装式
BF	旋装式, 罐式或直列式燃油滤清器
BK	Baldwin 工具包
BT	旋装式润滑油或液压/变速滤清器
BW	冷却剂旋装式滤清器 (带化学品)
C	棉质润滑油滤芯
CA	Channel Flow® 空气滤清器
CFB	冷却剂过滤器底座
CS	化学补充剂
CSC	冷却剂系统清洁剂
CTK	冷却剂测试包
CW	冷却剂袜式滤芯 (带化学品)
ES	端密封
F	棉质燃油滤芯

FB	燃油滤清器底座
G	垫圈
H	罩式液压滤芯
HH	软管
HSG	空气滤清器外壳
LL	长寿命空气滤清器滤芯
OB	润滑油或液压滤清器底座
OTK	油测试包
P	纸质润滑油或液压滤芯
PA	纸质空气滤芯
PF	纸质燃油滤芯
PG	压力表
PKG	套装, 优质品
PT	纸质润滑油或液压滤芯
PV	纸质及 Vac-Cel 滤芯*
RS	径向密封空气滤清器
S, SA, SF	特殊材料 *
T	棉织润滑油滤芯*
TA	用于大多数丙烯酸及其它合成纤维; 5 或 10微米积垢 (Peco Prefix AF)
TB	用于非酸性液体的棉与剑麻混合物; 25或40 微米积垢 (Peco Prefix FTE)
TC	用于非酸性液体的全棉, 低流量; 2, 5, 或10微米积垢(Peco Prefix FT)
V	Vac-Cel (棉质) 润滑油滤芯 *
VG	真空表
VT	Vac-Cel (棉质) 润滑油滤芯 *

后缀

多字母组成的后缀可能需要读为单一字母。后缀往往表示滤清器外壳的制造厂商。如果不是这种情况, 则大多数表示以下意义:

-1	规格改变
-2	双倍长度或有2吋摺边的滤芯
(2), (3), (4)	工具包中的滤芯数
-3, -5, -10, -25, -30	标定微米积垢
-A	封口, 转换包, 铝质, 型号*
-AF	一般用于空气滤清器
-AL	可用于含酒精的液体
-B	旁通润滑油, 盒装, 型号*
-CPE	用于中等温度下流动非酸性液体的棉质袜式滤芯
-CS	吸水介质
-D	排放, 直接安装*
-DL	双倍长度
-E	经济型或车队包装
-F	织棉或毛毡介质
-FF	全流式润滑油滤芯
-FN	带肋片的空气滤清器
-FP	带加油端口

-H	液压滤芯
-HD	重型或液压
-HPG	高性能玻璃介质
-K	工具包, 包括可重新使用的零配件和紧固件 *
-M	镁, Mason Jar 螺旋颈 *
-MPG	最高性能玻璃介质
-O	开口 *
-OPE	用于大多数液体的奥纶袜式滤芯; 尤其推荐用于搞热或含酸的液体
-OW	奥纶匝环
-RV	翻车安全阀
-S	液体滤清器规格变化; 空气滤清器上较小的实心盖子*
-SP	带传感器出口
-SS	严酷服务条件下使用的滤清器
-SPS	带可重新使用的传感器端口
-T	高流量应用的剑麻袜式滤芯 *
-V	Viton O型环
-W	带匝环, 冬季 - 寒冷天气应用 *
-WO	不带 - 参见规格
-WPC	带预清洁剂
XP	超级性能

* 详情及例外情况请参阅产品指导中的特别编号。

PREFIXES ET SUFFIXES

PREFIXES

AB	Bande de montage de boîtier d'air	H	Cartouche hydraulique
AC	Accessoire de boîtier d'air - capots ou colliers d'entrée d'air	HH	Flexible
AD	Adaptateur de filtre à air	HSG	Boîtier de filtre à air
AE	Coude de boîtier d'air	LL	Cartouche de filtre à air longue durée
AFG	Indicateur de colmatage de filtre à air	OAS	Séparateur huile / air
AH	Flexible de bosse de boîtier d'air	OB	Base de filtre à huile de lubrification ou hydraulique
AR	Joint torique de boîtier d'air	OP	Obturateur
AS	Manchon de boîtier d'air, capuchon cheminée	OS	Indicateur électrique
AV	Valve d'éjection de poussière du boîtier d'air	OTK	Nécessaire de contrôle d'huile
AW	Ecrou papillon ou métrique du boîtier d'air	OV	Indicateur visuel
B	Filtre de type vissable ou en ligne *	P	Cartouche en papier pour filtre à huile de lubrification ou hydraulique
BA	Élément sac ou sécheur d'air	PA	Cartouche en papier pour filtre à air
BC	Cartouche centrifuge	PF	Cartouche en papier pour filtre à carburant
BD	Lubrification, flux double, vissable	PG	Manomètre
BF	Filtre à carburant vissable, type bidon ou sur conduite	PKG	Paquet, article de qualité supérieure
BK	Jeu Baldwin	PT	Cartouche en papier pour filtre à huile de lubrification ou hydraulique
BT	Filtre à huile de lubrification ou hydraulique/de transmission vissable	PV	Cartouche Papier et Vac-Cel *
BW	Liquide de refroidissement avec produits chimiques, vissable	RS	Filtre à air à joint radial
C	Cartouche coton pour lubrification	S, SA, SF	Matériau spécial *
CA	Filtre à air Channel Flow®	T	Cartouche coton pour lubrification *
CFB	Base de filtre à liquide de refroidissement	TA	Fibres acryliques et autres fibres synthétiques pour la plupart des fluides; flux moyen; rétention 5 ou 10 microns (Préfixe peco AT)
CS	Supplément chimique	TB	Mélange de coton et sisal pour fluides non acides; flux moyen à élevé; rétention 25 à 40 microns (Préfixe peco FTE)
CSC	Produit de nettoyage de circuit de refroidissement	TC	Tout coton pour fluides non acides; débits faibles; rétention 2, 5 ou 10 microns (Préfixe peco TT)
CTK	Jeu de test de liquide de refroidissement	V	Cartouche pour lubrification Vac-Cel (coton) *
CV	Reniflard de carter	VG	Déprimomètre
CW	Élément de type chaussette pour liquide de refroidissement avec produits chimiques	VT	Cartouche pour lubrification Vac-Cel (coton) *
ES	Joint d'extrémité		
F	Cartouche en coton pour carburant		
FB	Base de filtre à carburant		
FD	Adaptateur pour filtre à carburant		
G	Joint		

SUFFIXES

Les suffixes à lettres multiples doivent parfois être lus comme lettres individuelles. Les suffixes indiquent souvent le fabricant du boîtier du filtre dans lequel s'ajuste la cartouche. Lorsque le suffixe n'est pas utilisé dans ce but, il indique le plus souvent ce qui suit:

-1	Changement de spécification	-FN	Filtre à air avec ailettes
-2	Double longueur ou cartouche air avec plis de 2 pouces (5 cm)	-FP	Contient orifice de remplissage
(2), (3), (4)	Nombre d'éléments dans un nécessaire	-H	Cartouche hydraulique
-3, -5, -10, -25, -30	Rétention nominale en microns	-HD	Usage intensif ou hydraulique
-A	Version extrémité fermée, nécessaire de conversion, aluminium *	-HPG	En verre haute performance
-AF	Normalement sur filtres à air	-K	Nécessaire, comprend pièces réutilisables, garnitures *
-AL	Peut être utilisé avec des fluides contenant de l'alcool	-M	Tubulure filetée, magnésium, récipient maçon *
-B	Version en boîte, dérivation, lubrification *	-MPG	En verre performance maximum
-BSP	British Standard Pipe	-O	Extrémité ouverte *
-CPE	Chaussette coton pour utiliser avec les fluides non acides s'écoulant à températures modérées	-OPE	Chaussette Orlon pour utiliser avec la plupart des fluides; particulièrement recommandée pour la chaleur élevée ou les fluides acides
-CS	Milieu averse d'eau	-OW	Enveloppe Orlon
-D	Montage direct, vidange *	-RV	Vanne de reuversement
-DL	Double longueur	-S	Changement de spécification sur filtres à liquide; Couvreplein, plus petit sur filtres à air *
-DM	Scarico - Applicazioni marine	-SP	Avec orifice de capteur
-E	Paquet économie ou flotte *	-SPS	Avec orifice de capteur réutilisable
-F	En coton enroulé ou feutre	-SS	Filtre SS pour les utilisations intensives
-FF	Cartouche pour lubrification à passage intégral	-T	Chaussette sisal pour applications de bit élevé *
		-V	Joint torique en Viton
		-W	Avec enveloppe, Hiver - Applications pour temps froid *
		-WO	Sans - Voir les spécifications
		-WPC	Avec préfiltre
		XP	Performances extrêmes

* Voir le numéro spécifique dans le Guide des Produits pour les détails et exceptions.

PRÄFIXE UND SUFFIXE

PRÄFIXE (VORSILBEN)

AB	Luftgehäuse Halteklammer
AC	Luftgehäuse Zubehör - Ansaugkappe oder Klammern
AD	Luftfilteradapter
AE	Luftgehäuse Kniestück
AFG	Luftfilter Drosselungsanzeige
AH	Luftgehäuse Buckelverbindungsstück
AR	Luftgehäuse Dichtungsring
AS	Luftgehäuse Verbindungsstück, Kappe
AV	Luftgehäuse Staubausstoßventil
AW	Luftgehäuse Flügelmutter
B	Dreh- oder Beutel-Filter *
BA	Taschenluftfilter oder Lufttrockner
BC	Zentrifugen Einsatz
BD	Öl doppelter Durchfluß Drehfilter
BF	Brennstoff Dreh-, Topf-, oder Durchfluß-Filter
BK	Baldwin Satz
BT	Drehfilter für Öl oder Hydraulik/Getriebe
BW	Kühlung, Dreh mit Chemikalien
C	Öl Baumwolle Einsatz
CA	Channel Flow®-Luftfilter
CFB	Kühlungfiltergehäuse
CS	Chemikalien Ergänzungssatz
CSC	Kühlungssystemreiniger
CTK	Kühlungsprüfungssatz
CV	Kurbelgehäuseentlüftung
CW	Kühlungs Einsatz, Sockeu-typ, mit Chemikalien
ES	Abschlußdichtung
F	Treibstoff Baumwolle Einsatz
FB	Ölfiltergehäuse
FD	Kraftstofffilter-Adapter
G	Dichtung
H	Hydraulik Pall-typ Einsatz

HH	Schlauch
HSG	Luftfiltergehäuse
LL	Langlebiger Luftfilter Einsatz
OAS	Öl-Luft-Abscheider
OB	Öl- oder Hydraulikfiltergehäuse
OP	Verschlussstopfen
OS	Elektrische Anzeige
OTK	Öltestsatz
OV	Visuelle Anzeige
P	Öl- oder Hydraulik Papier Einsatz
PA	Luftfilter Papier Einsatz
PF	Brennstoff Papier Einsatz
PG	Druckanzeigerät
PKG	Packung, gehobenes Modell
PT	Öl- oder Hydraulik Papier Einsatz
PV	Papier und Vac-Cel *
RS	Kreisartige Dichtung Luftfilter
S, SA, SF	Sondermaterial *
T	Öl Baumwolle Einsatz *
TA	Acrylik und andere synthetischen Faserstoffe für die meisten Flüssigkeiten; mittlerer Durchfluß 5 oder 10 Mikron Auffang (Peco Vorsatz AF)
TB	Mischung von Baumwolle und Sisal for nicht-sauere Flüssigkeiten; mittlerer bis hoher Durchfluß; 25 bis 40 Mikron Auffang (Peco Vorsatz FTE)
TC	Reine Baumwolle für nicht-sauere Flüssigkeiten; kleine Durchflußgeschwindigkeiten; 2, 5 oder 10 Mikron Auffang (Peco Vorsatz FT)
V	Öl Vac Cel (Baumwolle) Einsatz *
VG	Manometer
VT	Öl Vac Cel (Baumwolle) Einsatz *

SUFFIXE (NACHSILBEN)

Suffixe mit mehreren Buchstaben dürfen unter Umständen nur als ein einzelner Buchstabe gelesen werden. Suffixe geben oft den Hersteller des Filtergehäuses an in welches das Filter paßt. Falls der Zusatz nicht zu diesem Zweck gebraucht ist, dann bedeutet er meist wie folgt:

-1	Änderung der Spezifikationen
-2	Doppelte Länge oder Luft Einsatz mit 2-inch Falten
(2), (3), (4)	Anzahl der Einsätze in einem Satz
-3, -5, -10, -25, -30	Nominaler Auffang in Mikron
-A	Abschließendes Ende, Konversionssatz, Aluminium, Ausführung *
-AF	Normalerweise bei Luftfiltern
-AL	Kann mit alkoholischen Flüssigkeiten verwendet werden
-B	Öl By-Pass, Schachtel, Ausführung *
-BSP	British Standard Pipe (Gewindetyp)
-CPE	Baumwolle Socken-typ zum Gebrauch für nicht-sauere Flüssigkeiten bei mittleren Temperaturen
-CS	Wasseraufnahmefähiger Inhalt
-D	Abfluß, direkter Anbau *
-DL	Doppelte Länge
-DM	Abläss – Wasserfahrzeuge
-E	Spar-oder Mengenpackung *
-F	Gespulte Baumwolle oder Filzmaterial
-FF	Öl Hoher Durchfluß Einsatz

-FN	Luftfilter mit Finnen
-FP	Einschließlich Einfüllstutzen
-H	Hydraulik Einsatz
-HD	Schwere Belastung oder Hydraulik
-HPG	Glasinhalt für hohe Ansprüche
-K	Satz, einschließlich wiederverwendbarer Teile, Verbindungsstücke *
-M	Magnesium, Mason-Jar Schraubgewinde *
-MPG	Glasinhalt für höchste Ansprüche
-O	Offenes Ende *
-OPE	Orlon Socken-typ für die meisten Flüssigkeiten; besonders empfohlen bei hoher Hitze oder sauren Flüssigkeiten
-OW	Orlon Wickel
-RV	Roll-over Ventil
-S	Änderung der Spezifikationen für Filter für Flüssigkeiten; kleinerer harter Deckel für Luftfilter *
-SP	mit Sensoröffnung
-SPS	Mit wiederverwendbarer Sensoröffnung
-SS	SS-Filter für Schwerstbetrieb
-T	Sisalsocken für Anwendungen mit hohem Durchfluß *
-V	Viton Dichtungsring
-W	Mit Umschlag, Winter Anwendungen bei niedrigen Temperaturen *
-WO	Ohne, bitte Spezifikationen beachten
-WPC	Mit Vorreiniger
XP	Höchstleistungsfilter

* Beachten Sie die Einzelheiten und Ausnahmen in der, Produktaufzeichnung.

PREFISSI E SUFFISSI

PREFISSI

AB	Fascetta di montaggio alloggiamento aria
AC	Accessorio alloggiamento aria – Cappucci o morsetti entrata aria
AD	Adattatore filtro aria
AE	Gomito alloggiamento aria
AFG	Indicatore di restrizione filtro aria
AH	Tubo flessibile alloggiamento aria
AR	O-Ring alloggiamento aria
AS	Manicotto alloggiamento aria, cappuccio pila
AV	Valvola estrattore polvere alloggiamento aria
AW	Ala alloggiamento aria oppure dado metrico
B	Filtro spin-on oppure filtro a sacco *
BA	Sacco aria
BC	Elemento centrifugo
BD	Filtro spin-on lubrificante a doppio flusso
BF	Filtro spin-on, filtro carburante a barattolo o in linea
BK	Kit Baldwin
BT	Filtro spin-on lubrificante oppure filtro idraulico/di trasmissione
BW	Filtro spin-on refrigerante con sostanze chimiche
C	Elemento di cotone lubrificante
CA	Filtro dell'aria Channel Flow®
CFB	Base filtro refrigerante
CS	Supplemento chimico
CSC	Depuratore sistema refrigerante
CTK	Kit di prova refrigerante
CV	Crankcase Ventilation Breather
CW	Elemento a sacco refrigerante con sostanze chimiche
ES	Guarnizione finale
F	Elemento di cotone carburante
FB	Base filtro carburante
FD	Fuel Filter Adapter

G	Guarnizione
H	Elemento idraulico di tipo Pall
HH	Tubo flessibile
HSG	Alloggiamento filtro aria
LL	Elemento filtro aria a lunga durata
OAS	Oil/Air Separator
OB	Base filtro idraulico o lubrificante
OP	Plug
OS	Electrical Indicator
OTK	Kit di prova olio
OV	Visual Indicator
P	Elemento di carta lubrificante o idraulico
PA	Elemento di carta aria
PF	Elemento di carta carburante
PG	Manometro
PKG	Confezione, articolo di qualità superiore
PT	Elemento di carta lubrificante o idraulico
PV	Elemento di carta e Vac-cel *
RS	Filtro aria guarnizione radiale
S, SA, SF	Materiale speciale *
T	Elemento di cotone lubrificante *
TA	Acrilico e altre fibre sintetiche per grand parte dei fluidi; flusso medio; ritenzione 5 o 10 micron (Prefisso Peco AF)
TB	Miscela di cotone e sisal per fluidi non acidi; flusso medio-alta; ritenzione da 25 a 40 micron (Prefisso Peco FTE)
TC	Puro cotone per fluidi non acidi; flusso basso; ritenzione da 2, 5, o 10 micron (Prefisso Peco FT)
V	Elemento in Vac-cel (cotone) lubrificante *
VG	Vacuometro
VT	Elemento in Vac-cel (cotone) lubrificante *

SUFFISSI

Può essere necessario leggere i suffissi con più lettere come lettere singole. Spesso i suffissi indicano il produttore dell'alloggiamento del filtro in cui risiede l'elemento. Quando il suffisso non è utilizzato per questo scopo, esso spesso indica quanto segue:

-1	Modifica della specifica tecnica
-2	Lunghezza doppia oppure elemento aria con pieghettature da 2 pollici
(2), (3), (4)	Numero di elementi in un kit
-3, -5, -10, -25, -30	Ritenzione nominale in micron
-A	Estremità chiusa, kit di conversione, alluminio, versione # *
-AF	Normalmente su filtri aria
-AL	Può essere utilizzato con fluidi contenenti alcol
-B	Bypass lubrificante, incassato, versione # *
-BSP	British Standard Pipe
-CPE	Sacco in cotone per uso con fluidi non acidi a temperature moderate
-CS	Mezzi assorbenti acqua
-D	Scarico, montaggio diretto *
-DL	Lunghezza doppia
-DM	Drain - Marine Applications
-E	Economia oppure fleet pack *
-F	Cotone avvolto oppure mezzo di feltro
-FF	Elemento lubrificante per flusso totale
-FN	Filtro aria con alette

-FP	Contiene porta di riempimento
-H	Elemento idraulico
-HD	Servizio pesante oppure idraulico
-HPG	Mezzi di vetro per alte prestazioni
-K	Kit, include parti riutilizzabili, accessori *
-M	Magnesio, vite Mason Jar *
-MPG	Mezzi di vetro per prestazioni massime
-O	Estremità aperta *
-OPE	Sacco di orlon per uso con gran parte dei fluidi; particolarmente consigliata per fluidi altamente riscaldati o acidi
-OW	Copertura di orlon
-RV	Valvola "roll-over"
-S	Modifica della specifica tecnica per filtri di liquidi; più piccolo; coperchio solido su filtri aria *
-SP	Con porta sensore
-SPS	Con porta sensore riutilizzabile
-SS	Filtro per servizio pesante
-T	Sacco in sisal per applicazioni con flusso elevato *
-V	O-Ring in Viton
-W	Con copertura, applicazioni inverno-tempo freddo *
-WO	Senza – Vedere specifiche tecniche
-WPC	Con pre-depuratore
XP	Prestazioni estreme

* Per dettagli ed eccezioni, vedere il numero specifico nella guida prodotto.

PREFIXOS E SUFIXOS

PREFIXOS

AB	Tira de montagem para carcaça de filtro de ar	FD	Adaptador do Filtro de Combustível
AC	Acessórios da carcaças dos filtros de ar - Chapéu ou abraçadeiras	G	Junta
AD	Adaptador do filtro de ar	H	Elemento de filtro hidráulico
AE	Cotovelo da carcaça do filtro de ar	HH	mangueira
AFG	Mostrador de restrição do filtro de ar	HSG	Carcaça de filtro de ar
AH	Mangueira curva da caixa de ar	LL	Elemento de filtro de ar de longa vida
AR	Anel "O" da caixa de ar	OAS	Separador de Óleo e Água
AS	Bucha e tampa da chaminé	OB	Base de filtro lubrificante ou hidráulico
AV	Válvula para retirar excesso de poeira da caixa de ar	OP	Bujão
AW	Porca métrica ou tipo borboleta da caixa de ar	OS	Indicador Elétrico
B	Filtro selado ou tipo bolsa *	OTK	Kit de teste de óleo
BA	Ar do Saco ou Secador de Ar	OV	Indicador Visual
BC	Elemento de centrifugação	P	Elemento de papel para lubrificante ou hidráulico
BD	Filtro selado de dois fluxos	PA	Elemento de papel para ar
BF	Filtro selado, tipo caneca, ou filtro de linha	PF	Elemento de papel para combustível
BK	Kit Baldwin	PG	Indicador de pressão
BT	Filtro selado para lubrificante ou transmissão hidráulica	PKG	Embalagem, artigo "premium"
BW	Filtro selado para sistema de refrigeração com substancias químicas	PT	Elemento de papel para lubrificante ou hidráulico
C	Elemento de algodão	PV	Elemento de papel e Vac-Cel *
CA	Filtro de Ar Channel Flow®	RS	Elemento de filtro de ar tipo Selo radial
CFB	Base do filtro para sistemas de refrigeração	S, SA, SF	Material especial *
CS	Suplemento de substancias químicas	T	Elemento de algodão para lubrificante
CSC	Limpador do sistema de refrigeração	TA	Acrílico ou outras fibras sintéticas para a maioria dos fluidos; Vazão média; retenção de 5 a 10 microns (Prefixo Peco AF)
CTK	Kit do teste do líquido refrigerante	TB	Mistura de algodão e sisal para fluidos não ácidos; Vazão de média para alta; Retenção de 25 a 40 microns (Prefixo Peco FTE)
CV	Suspiro de Ventilação do Câter	TC	Totalmente algodão para fluidos não ácidos; Baixas relações de vazão; retenção de 2, 5, ou 10 microns (Prefixo Peco FT)
CW	Elemento de filtro tipo meia para sistemas de refrigeração, com substancias químicas	V	Elemento lubrificante de Vac-Cel (algodão) *
ES	Selo	VG	Indicados de vácuo - Vacuômetro
F	Elemento de filtro de algodão	VT	Elemento lubrificante de Vac-Cel (algodão) *
FB	Base do filtro de combustível		

SUFIXOS

Sufixos com muitas letras devem ser lidos como se fossem letras simples. Normalmente o sufixo indica o fabricante da carcaça do filtro, na qual o elemento se encaixa. Quando o sufixo não se utiliza para este propósito, na maioria das vezes indica o seguinte:

-1	Mudança de especificações	-FN	Filtro de ar com aletas
-2	Comprimento duplo, ou elemento de filtro de ar com plissado de duas polegadas	-FP	Contém orifício de entrada
(2), (3), (4)	Número de elemento no Kit	-H	Elemento hidráulico
-3, -5, -10, -25, -30	Retenção nominal em microns	-HD	Elemento hidráulico ou serviço pesado
-A	Fechamento externo, Kit de conversão, Alumínio, Versão # *	-HPG	Meio filtrante de alto desempenho de fibra de vidro
-AF	Normalmente em filtros de ar	-K	Kit, Inclui peças reutilizáveis, acessórios
-AL	Poderá ser utilizado em fluidos que contém álcool	-M	Magnésio, Jarra hermética com rosca
-B	Lubrificante tipo derivação, fechado, versão # *	-MPG	Meio filtrante de máximo desempenho de fibra de vidro
-BSP	British Standard Pipe	-O	Final aberto
-CPE	Tipo meia de algodão para utilização em fluidos não ácidos e temperaturas moderadas	-OPE	Meia de orlón para ser utilizado na maioria dos fluidos; particularmente recomendado para altas temperaturas ou fluidos que contem ácidos
-CS	Meio filtrante absorvente de água	-OW	Revestimento de orlón
-D	Drenagem, Montagem direta *	-RV	Válvula de rotação
-DL	Comprimento duplo	-S	Modificação das especificações dos filtros para líquidos, Menores, Tampa sólida nos filtros de ar
-DM	Dreno DM - Aplicações Marítimas	-SP	Com tomada para sensor
-E	Embalagem econômica ou para transporte	-SPS	Com tomada de sensor reutilizável
-F	Meio filtrante em algodão ou feltro	-SS	Filtros para serços severos
-FF	Elemento de fluxo total	-T	Meia de sisal para aplicações de altas vazões *
		-V	Anel "O" de viton
		-W	Com revestimento, Inverno - para aplicações em baixas temperaturas
		-WO	Sem - Verifique as especificações
		-WPC	Com o Pré-limpador
		XP	Desempenho Extremo

* Veja o Numero Especifico No Catalogo Produtos, com Relação aos Detalhes.

ПРИСТАВКИ И СУФФИКСЫ

ПРИСТАВКИ

AB	Лента крепления воздухозаборной коробки
AC	Принадлежности воздухозаборной коробки: предохранительный колпак на впуске воздуха или хомуты
AD	Переходник воздушного фильтра
AE	Колено воздухозаборной коробки
AFG	Указатель сопротивления воздушного фильтра
AH	Сортировочный шланг воздухозаборной коробки
AR	Уплотнительное кольцо воздухозаборной коробки
AS	Рукав воздухозаборной коробки, крышка выводного патрубка
AV	Клапан пылеэжектора воздухозаборной коробки
AW	Крыльчатая барашковая или метрическая гайка воздухозаборной коробки
B	Навинчиваемый или рукавный фильтр *
BA	Баллон с воздухом или осушитель воздуха
BC	Элемент центробежного фильтра
BD	Двухпоточный навинчиваемый масляный фильтр
BF	Навинчиваемый, стаканый или встраиваемый топливный фильтр
BK	Комплект принадлежностей фирмы "Болдуин"
BT	Навинчиваемый масляный фильтр или фильтр гидравлической системы или коробки передач
BW	Навинчиваемый фильтр охлаждающей жидкости с присадками
C	Хлопчатобумажный элемент масляного фильтра
CA	Воздушный фильтр с разделенными каналами (Channel Flow®)
CFB	Корпус фильтра охлаждающей жидкости
CS	Химическая добавка
CSC	Фильтр системы охлаждения
CTK	Набор принадлежностей для контроля качества охлаждающей жидкости
CV	Сапун вентиляции картера
CW	Рукавный элемент фильтра охлаждающей жидкости с присадками
ES	Торцевое уплотнение
F	Хлопчатобумажный элемент топливного фильтра
FB	Корпус топливного фильтра
FD	Переходной патрубок топливного фильтра
G	Уплотнительная прокладка

H	Элемент Полла для фильтра гидравлической системы
HH	Шланг
HSG	Корпус воздушного фильтра
LL	Элемент воздушного фильтра с длительным сроком службы
OAS	Устройство для центробежной очистки моторного масла
OB	Корпус масляного фильтра или фильтра гидравлической системы
OP	Заглушка
OS	Электрический индикатор
OTK	Набор принадлежностей для контроля качества масла
OV	Индикатор визуального контроля
P	Бумажный элемент масляного фильтра или фильтра гидравлической системы
PA	Бумажный элемент воздушного фильтра
PF	Бумажный элемент топливного фильтра
PG	Манометр
PKG	Комплектное изделие высшего сорта
PT	Бумажный элемент масляного фильтра или фильтра гидравлической системы
PV	Бумажный фильтрующий элемент со структурой Vac-Cel *
RS	Воздушный фильтр с радиальным уплотнением
S, SA, SF	Специальный материал *
T	Хлопчатобумажный элемент масляного фильтра *
TA	Акриловое или иное синтетическое волокно для большинства рабочих сред; для средних значений расхода; степень фильтрации 5 или 10 мкм (для серии Peco - приставка AF)
TB	Материал из смеси хлопка с сизалем для неагрессивных рабочих сред; для средних и высоких значений расхода; степень фильтрации 25 - 40 мкм (для серии Peco - приставка FTE)
TC	Чисто хлопчатобумажный материал; для низких значений расхода; степень фильтрации 2, 5 или 10 мкм (для серии Peco - приставка FT)
V	Элемент со структурой Vac-Cel (хлопчатобумажный) для масляного фильтра
VG	Вакуумметр
VT	Элемент со структурой Vac-Cel (хлопчатобумажный) для масляного фильтра

СУФФИКСЫ

Некоторые суффиксы из нескольких букв могут потребовать их чтения как суффиксов, состоящих из единственной буквы. Во многих случаях суффиксом обозначается предприятие-изготовитель корпуса фильтра, в который может быть установлен данный фильтрующий элемент. Если суффикс используется с иной целью, то им часто обозначаются следующие характеристики:

-1	Изменение технических данных
-2	Элемент воздушного фильтра, имеющий двойную длину или 2-дюймовый гофр
(2), (3), (4)	Число фильтрующих элементов в комплекте
-3, -5, -10, -25, -30	Номинальная удерживающая способность фильтра в микрометрах
-A	С закрытым торцом, комплектом для переоборудования, алюминиевое исполнение, модификация № *
-AF	Стандартно устанавливаемый на воздушных фильтрах
-AL	Может применяться с жидкостями, содержащими спирт
-B	Обводная линия смазки, коробчатое исполнение, модификация № *
-BSP	британская стандартная трубная [резьба]
-CPE	Хлопчатобумажный, в рукавном исполнении для применения с неагрессивными текучими средами при умеренных температурах
-CS	Материал, впитывающий воду *
-D	Выпуск, непосредственный монтаж
-DL	Двойная длина
-DM	Слив - для использования на судах
-E	Экономичный вариант или для автохозяйств *
-F	Навитой хлопчатобумажный или фетровый материал
-FF	Полнопоточный элемент смазочного фильтра

-FN	Воздушный фильтр с ребрами
-FP	Содержит заправочную горловину
-H	Элемент для гидравлических систем
-HD	Для тяжелых машин или гидравлических систем
-HPG	Высокоэффективный материал на основе стекла
-K	Комплект, содержащий детали повторного использования, элементы арматуры *
-M	Магний, керамическая резьбовая горловина *
-MPG	Предельно эффективный материал на основе стекла
-O	Открытый торец *
-OPE	Рукавное исполнение из полиакрилонитрильного волокна "орлон", для использования с большинством текучих сред; особенно рекомендуется для сильно нагретых или содержащих кислоты жидкостей
-OW	Витая оболочка из полиакрилонитрильного волокна "орлон"
-RV	Клапан, срабатывающий при переворачивании
-S	Изменение технических характеристик жидкостных фильтров; уменьшенная сплошная крышка на воздушных фильтрах *
-SP	С каналом для датчика
-SPS	С каналом для повторно используемого датчика
-SS	Фильтр для особо тяжелых условий эксплуатации
-T	Рукавное исполнение из сизаля для применения в устройствах с высоким расходом
-V	Кольцевое уплотнение из сополимера прфторпропилена с винилиденфторидом "вайтон"
-W	С витой оболочкой, для применения в условиях низких температур
-WO	Без - см. технические данные
-WPC	С предварительным очистителем
XP	Высокая производительность

* См. подробные сведения и исключения в разделе "Справочника по продукции", посвященном индивидуальным номерам.

PREFIJOS Y SUFIJOS

PREFIJOS

AB	Banda de montaje para la caja de aire	H	Elemento hidráulico
AC	Accesorio de caja de aire - Capucha o abrazador de la toma de aire	HH	Manguera
AD	Adaptador del filtro de aire	HSG	Caja de filtro de aire
AE	Codo de la caja de aire	LL	Elemento de filtro de aire de larga duración
AFG	Indicador de restricción del filtro de aire	OAS	Separador de aceite/aire
AH	Manguera encorvada de la caja de aire	OB	Base del filtro hidráulico o del lubricante
AR	Anillo "O" de la caja de aire	OP	Tapón
AS	Manga de unidad de aire, tapón de escape	OS	Indicador eléctrico
AV	Válvula eyectora de polvo de la caja de aire	OTK	Kit de comprobación del aceite
AW	Tuerca métrica o tuerca de orejetas de la caja de aire	OV	Indicador visual
B	Filtro de rosca o tipo-bolsa *	P	Elemento de papel para lubricantes o hidráulicos
BA	Aire en bolsa o secadora de aire	PA	Elemento de papel para aire
BC	Elemento de centrifugación	PF	Elemento de papel para combustible
BD	Filtro de lubricante de rosca de corriente dual	PG	Indicador de presión
BF	Filtro de combustible de rosca, tipo-lata o de línea	PKG	Paquete, artículo de primera
BK	Kit de Baldwin	PT	Elemento de papel para lubricantes o hidráulicos
BT	Filtro de lubricante de rosca o de sistema de transmisión hidráulica	PV	Papel y Vac-Cel *
BW	Filtro de refrigerante de rosca con químicos	RS	Filtro de aire de sellado radial
C	Elemento de algodón para lubricación	S, SA, SF	Material especial *
CA	Filtro de aire Channel Flow®	T	Elemento de algodón para lubricante *
CFB	Base del filtro de refrigerante	TA	Acrílicos y otras fibras sintéticas para la mayoría de los fluidos; caudal medio; 5 ó 10 micrometros de retención (Prefijo Peco AF)
CS	Suplemento químico	TB	Derivados de algodón y fibra de para fluidos sin contenido de acidos; caudal medio a alto; de 25 a 40 micrometros de retención (Prefijo Peco FTE)
CSC	Limpiador del sistema de refrigeración	TC	Puro algodón para fluidos sin contenido de acidos; Porcentajes de caudal bajo; 2, 5, ó 10 micrometros de retención (Prefijo Peco FT)
CTK	Kit de comprobación del refrigerante	V	Elemento de lubricación de Vac-Cel (algodón) *
CV	Respiradero de ventilación del cárter	VG	Vaciómetro
CW	Elemento de refrigeración tipo calcetín con químicos	VT	Elemento de lubricación de Vac-Cel (algodón) *
ES	Sello de extremo		
F	Elemento de algodón para combustible		
FB	Base del filtro para combustible		
FD	Adaptador para filtro de combustible		
G	Empaque		

SUFIJOS

Puede que los sufijos de múltiples letras necesiten leerse como letras simples. Los sufijos a menudo indican el fabricante de la caja de filtro en la que el elemento encaja. Cuando el sufijo no se utiliza para este propósito, la mayoría de las veces indica lo siguiente:

-1	Cambio de especificación	-FP	Contiene orificio de entrada
-2	Doble longitud o elemento de aire con 2 pulgadas de pliegues	-H	Elemento hidráulico
(2), (3), (4)	Número de elementos en un kit	-HD	Trabajos pesados o hidráulicos
-3, -5, -10, -25, -30	Retención nominal de micrometros	-HPG	Medio de cristal de alto rendimiento
-A	Versión de extremo cerrado, de kit de conversión, Aluminio *	-K	Kit, incluye piezas reutilizables, accesorios *
-AF	Normalmente en filtros de aire	-M	Magnesio, bote hermético con cuello de rosca *
-AL	Puede usarse junto con fluidos que contengan alcohol	-MPG	Medio de cristal de máximo rendimiento
-B	Versión de lubricación por derivación en caja	-O	Extremo abierto *
-BSP	Tubería estándar británica	-OPE	Calcetín de Orlón a utilizar con la mayoría de los fluidos; Recomendado particularmente en fluidos de temperaturas elevadas o en fluidos conteniendo acidos
-CPE	Calcetín de algodón para el uso en fluidos sin contenido de ácidos corriendo a temperaturas moderadas	-OW	Envoltura de Orlón
-CS	Medio de fécula de maíz	-RV	Válvula de rotación
-D	Desagüe, montaje directo *	-S	Cambio de especificación en los filtros de líquidos; más pequeños, tapadera sólida en filtros de aire *
-DL	Doble longitud	-SP	Con lumbrera sensora
-DM	Drenaje – Aplicaciones marinas	-SPS	Con lumbrera sensora reutilizable
-E	Paquete económico o de carga	-SS	Filtro SS para servicio severo
-F	Medio de algodón en ovillo o fieltro	-T	Calcetín de fibra de para aplicaciones de alta corriente *
-FF	Elemento de lubricación de flujo pleno	-V	Anillo-O de Vitón
-FN	Filtro de aire con aletas	-W	Con envoltura, aplicaciones de temperaturas frías - Invierno
		-WO	Sin - Veáse las especificaciones
		-WPC	Con Pre-limpiador
		XP	Rendimiento extremo

* Veáse el número específico en la Guía de Productos para observar los detalles y excepciones.

HOW PRODUCT GUIDE IS ARRANGED

PRODUCT GUIDE

Filter Master List
Gasket Master List
Air Filter Housings
DAHL Filters
Filter Size Charts

All products are arranged in numerical order, ignoring prefixes and suffixes in the arrangement. The Filter Master List is first, followed by Gaskets, DAHL Filters and Filter Size Charts.

MEASUREMENTS ARE TIP-TO-TIP

We use overall measurements unless stated otherwise. Some catalogs show size of element only. We show overall size including gaskets and other protrusions that extend the farthest. You can then make sure there is sufficient clearance when this is a critical factor. Measurements are shown in inches and millimeters.

IMPORTANT NOTICE

All specifications in this catalog are based on the latest authoritative information available at press time. However, changes are made by equipment manufacturers without notice, which necessitates changes in our product. Keep your stock rotated so that you always use your oldest stock first. If a filter does not seal when installed, it should not be used. We cannot be responsible for misapplications.

Original equipment manufacturer's tradenames or trademarks are for identification purposes only. There is no affiliation, sponsorship or connection with the original equipment parts or manufacturer.

العربية / Arabic

كيفية تنظيم دليل المنتجات

دليل المنتجات

قائمة المرشحات الرئيسي
قائمة حشو منع التسرب الرئيسي
مبايت مرشحات الهواء
مرشحات DAHL
جدول سعة المرشحات

المرشح إذا وجد أنه يسمح بالتسرب بعد تركيبه. نحن لا يمكن أن نتحمل مسؤولية الأخطاء في الاستخدام.

الأسماء التجارية والعلامات التجارية الخاصة بمنتجات المعدات الأصلية واردة للتعريف فقط. لا يوجد ارتباط أو انتساب أو علاقة مع منتج قطع الغيار الأصلية أو الشركة المصنعة الأصلية.

ترتب جميع المنتجات بترتيب الأرقام بدون اعتبار الزوائد البادئة واللاحقة. تأتي قائمة المرشحات الرئيسية في البداية، وتتبعها قائمة الحشو المانع للتسرب، ثم مبايت مرشحات الهواء، ثم مرشحات DAHL، وجدول سعة المرشحات.

الأبعاد من الطرف إلى الطرف

نحن نستخدم الأبعاد الكلية إلا عند ذكر خلاف ذلك. تظهر بعض الكتلوجات مقاييس العناصر فقط. ولكننا نظهر الأبعاد الكلية ويدخل فيها الحشو المانع للتسرب وغير ذلك من البروزات التي تمتد إلى أقصى بُعد. ويمكنك ذلك التحقق من وجود خلوص كاف حين يكون ذلك عاملاً حيوياً. تعرض جميع الأبعاد بالبوصة والمليمتر.

تنبيه هام

وردت جميع المواصفات في هذه الكتلوج على أحدث معلومات موثوق بها متوفرة في وقت النشر. ولكن كثيراً ما يقوم منتج المعدات بتعديلات بدون إنذار مما يلزم إجراء تعديلات على منتجنا. حافظ على تسلسل استخدام مخزونك بحيث تستخدم المخزون الأقدم أولاً. يجب ألا يستخدم

产品指导

滤清器总清单
垫圈总清单
空气滤清器外壳
DAHL滤清器
滤清器尺寸表

所有产品均按数字顺序排列，排列时不考虑前缀和后缀。首先是滤清器总清单，然后是垫圈总清单、空气滤清器外壳、DAHL滤清器和滤清器尺寸表。

端到端的尺寸

我们使用的是总体尺寸，除非另有说明。有些目录只给出部件本身的大小。我们提供总体尺寸，包括垫圈和其它伸出之部分。如果大小是一个重要的问题，您就可以确定是否有足够的空间来安装滤清器。尺寸以英寸和毫米表示。

重要通知

本目录中的所有规格均根据付印时能够搜集到的最新权威资料。然而，设备厂商会不经通知而作出改变，迫使我们相应改动我们的产品。请保持您的库存周转，总是先用最老的库存品。如果滤清器安装时不能密封，就不应使用。本公司不能对误用负责。

原设备生产厂的商品名或商标仅用于识别之目的，与原始设备零件或厂商并无附属、资助或其它关系。

ORGANISATION DU GUIDE DES PRODUITS

Tous les produits sont classés par ordre numérique, sans tenir compte des préfixes ni des suffixes. La liste principale des filtres est la première, suivie des tableaux de dimensions des joints, des filtres DAHL et des filtres.

LES DIMENSIONS SONT MESURÉES D'EXTRÉMITÉ À EXTRÉMITÉ

Nous utilisons les dimensions hors tout, sauf indication contraire. Certains catalogues montrent les dimensions de l'élément uniquement. Nous montrons les dimensions hors tout, y compris les joints et autres protubérances. Vous pouvez alors vérifier que le dégagement est suffisant quand c'est un facteur critique. Les dimensions sont données en pouces et en millimètres.

AVIS IMPORTANT

Les données de ce catalogue sont basées sur les informations les plus récentes disponibles à la mise sous presse. Cependant, les fabricants d'équipement font des changements sans préavis, et ces changements nécessitent des changements

GUIDE DES PRODUITS

Liste principale des filtres
Liste principale des joints
Boîtiers de filtres à air
Filtres DAHL
Tableaux des dimensions des filtres

de nos produits. Faites tourner votre stock pour utiliser d'abord votre stock le plus ancien. Si un filtre n'est pas étanche après installation, il ne doit pas être utilisé. Nous ne pouvons pas être tenus responsables des mauvaises applications.

Les marques et noms de fabricant d'équipement d'origine ne sont utilisés que pour des raisons d'identification. Il n'existe aucune affiliation, parrainage ou connexion avec le fabricant d'équipement d'origine ou ses pièces.

GLIEDERUNG DER PRODUKTÜBERSICHT**PRODUKT-
ÜBERSICHT**

Hauptliste Filter
 Hauptliste Dichtungen
 Luftfiltergehäuse
 DAHL-Filter
 Tabelle Filtergröße

Alle Produkte sind in numerischer Reihenfolge angeordnet, Vorangestellte und angehängte Zeichen bleiben dabei unberücksichtigt. Als erstes ist die Hauptliste Filter aufgeführt, gefolgt von der Hauptliste Dichtungen, de DAHL-Filtern und den Filter-Größentabellen.

DIE ABMESSUNGEN BEZIEHEN SICH AUF DIE GESAMTLÄNGE

Wenn nicht anders angegeben, beziehen sich unsere Abmessungen auf die Gesamtlänge. In manchen

Katalogen wird nur die Größe eines bestimmten Teils angegeben. Wir geben jedoch die Gesamtlänge an, einschließlich Dichtungen und anderer Teile, die am weitesten herausragen. Dadurch können Sie diesen Faktor berücksichtigen, falls er eine wichtige Rolle spielen sollte. Die Abmessungen sind in Zoll und Millimeter angegeben.

WICHTIGER HINWEIS

Alle technischen Daten in diesem Katalog basieren auf den neuesten zum Zeitpunkt des Drucks verfügbaren Informationen. Die Kfz-Teilehersteller nehmen jedoch bisweilen Änderungen ohne Vorankündigung vor, die auch zu Anpassungen unserer Produkte führen. Rotieren Sie ihre Lagerbestände, so dass die ältesten Teile zuerst verkauft werden. Schließt ein Filter nicht dicht ab, so verwenden Sie ihn nicht. Wir übernehmen keine Haftung für falsche Verwendung.

Die Handelsnamen oder Handelsmarken der Originalteilehersteller werden nur zu Identifikationszwecken angegeben. Es besteht keine Angliederung, Förderung oder Verbindung mit dem Originalteil oder dem Hersteller.

COM'È ORGANIZZATA LA GUIDA PRODOTTO**GUIDA
PRODOTTO**

Elenco generale filtri
 Elenco generale guarnizioni
 Alloggiamenti filtri aria
 Filtri DAHL
 Grafici delle dimensioni dei filtri

Tutti i prodotti sono elencati in ordine numerico, ignorando i prefissi e i suffissi. Viene prima l'elenco generale dei filtri, seguito da Guarnizioni, Filtri DAHL e Grafici delle dimensioni dei filtri.

LE DIMENSIONI SI INTENDONO DA ESTREMITÀ A ESTREMITÀ

A meno che non indicato diversamente, noi utilizziamo le dimensioni totali. Alcuni cataloghi riportano solo le dimensioni dell'elemento. Noi

indichiamo le dimensioni totali incluso guarnizioni e altre sporgenze massime. In tal modo è possibile verificare che vi sia gioco sufficiente quando questo è un fattore critico. Le dimensioni sono indicate in pollici e millimetri.

AVVISO IMPORTANTE

Tutte le specifiche tecniche riportate in questo catalogo si basano sulle informazioni più autorevoli disponibili al momento di andare in stampa. Tuttavia, i produttori delle apparecchiature apportano modifiche senza preavviso, rendendo necessario modificare il nostro prodotto. Fate ruotare le vostre scorte, in modo da utilizzare prima le scorte più vecchie. Non utilizzare filtri non a tenuta dopo l'installazione. Non siamo responsabili di usi impropri.

I nomi o i marchi di fabbrica del produttore di apparecchiature originali si intendono unicamente per scopi di identificazione. Non esistono affiliazioni, sponsorizzazioni né connessioni con i produttori né con i componenti di apparecchiature originali.

CONFIGURAÇÃO DESTE GUIA DE PRODUTOS

Todos os produtos estão dispostos em ordem numérica, sem levar em conta os prefixos e sufixos. A Lista Mestra de Filtros é a primeira, seguida das juntas, filtros DAHL e tabelas de tamanhos de filtros.

AS MEDIDAS SÃO DE PONTA A PONTA

Utilizamos as dimensões totais, salvo indicações em contrário. Alguns catálogos mostram somente o tamanho do elemento. Mostramos as dimensões totais, incluindo as juntas e outras protuberâncias que se estendam mais para fora. Desta forma, você pode se certificar de que haverá folga suficiente quando isto for um fator crítico. As medidas são mostradas em polegadas e milímetros.

AVISO IMPORTANTE

Todas as especificações neste catálogo têm por base as informações mais recentes disponíveis no momento da publicação. Contudo, os fabricantes dos equipamentos introduzem modificações sem aviso prévio, o que torna necessário alterar nossos

produtos. Mantenha a rotatividade do seu estoque de maneira que sempre se utilize primeiramente do produto mais antigo. Se um filtro não vedar ao ser instalado, não deve ser utilizado. Não nos responsabilizamos por aplicações incorretas.

Os nomes ou marcas comerciais dos fabricantes de equipamentos são apenas para fins de identificação. Não há relacionamento, patrocínio ou conexão com as peças dos equipamentos originais ou com o fabricante.

GUIA DE PRODUTOS

Lista principal de filtros
Lista principal de juntas
Carcaças de filtros de ar
Filtros DAHL
Tabelas de tamanhos de filtros

СХЕМА ОРГАНИЗАЦИИ СПРАВОЧНИКА ПО ПРО—УКЦИИ

Все изделия указываются в порядке нумерации - без учета приставок и суффиксов в обозначении. Первым приводится “Основной перечень фильтров”, за которым следуют “Основной перечень уплотнений”, “Корпуса воздушных фильтров”, “Фильтры серии DAHL” и “Таблицы выбора типоразмера фильтра”.

УКАЗАНИЕ РАЗМЕРОВ

За особо оговоренными исключениями, мы применяем габаритные размеры. В некоторых каталогах указывается только размер фильтрующего элемента. Мы сообщаем габаритный размер, которым охватываются уплотнения и прочие выступающие элементы, которые в наибольшей степени влияют на габаритный размер. Благодаря этому можно убедиться в наличии достаточного просвета, если он имеет существенное значение. Размеры указываются в дюймах и миллиметрах.

ВАЖНОЕ ПРИМЕЧАНИЕ

Все технические характеристики, содержащиеся в настоящем каталоге, основаны на последней версии сообщений из авторитетных источников, имевшихся во время печатания каталога. Однако изготовители оборудования не предупреждают о внесении изменений, делающих необходимыми изменения в нашей публикации. Схема

расходования инвентарных запасов должна быть построена таким образом, чтобы в первую очередь непременно использовались изделия из самой старой партии. Если после установки фильтра не достигается его герметичность, такой фильтр не следует применять. Мы не можем нести ответственность за неправильное использование.

Торговые арки и товарные знаки изготовителей комплектного оборудования приводятся исключительно в целях обозначения продукции. Отсутствует какая-либо принадлежность, поручительство или связь с элементами или изготовителями комплектного оборудования.

СПРАВОЧНИК ПО ПРО—УКЦИИ

Основной перечень фильтров
Основной перечень уплотнений
Корпуса воздушных фильтров
Фильтры серии DAHL
Таблицы выбора типоразмера фильтра

CONFIGURACIÓN DE LA GUÍA DE PRODUCTOS**GUÍA DE PRODUCTOS**

Lista maestra de filtros

Lista maestra de empaque

Envueltas de filtros de aire

Filtros DAHL

Tablas de tamaños de filtros

Todos los productos están dispuestos en orden numérico, sin tomar en cuenta los prefijos y sufijos. La lista maestra de filtros aparece primero, seguida por las tablas de empaques, filtros DAHL y tamaños de filtros.

MEDIDAS DE PUNTA A PUNTA

Utilizamos dimensiones totales salvo indicación contraria. Algunos catálogos muestran el tamaño del elemento solamente. Nosotros mostramos el

tamaño total incluyendo los empaques y otras protuberancias que sobresalgan más. De esa manera se tiene la seguridad de que hay espacio suficiente cuando éste es un factor crítico. Las medidas se muestran en pulgadas y en milímetros.

NOTA IMPORTANTE

Todas las especificaciones en este catálogo están basadas en la información más reciente disponible en el momento de la publicación. Sin embargo, los fabricantes de equipos a menudo hacen modificaciones a sus equipos sin previo aviso, lo que se traduce en cambios en nuestro producto. Rotar continuamente el stock de manera que siempre se use la mercancía más antigua primero. Si un filtro no cierra bien después de instalado, no usarlo. No podemos responsabilizarnos por aplicaciones incorrectas.

Los nombres comerciales o marcas registradas de los fabricantes de equipos se dan solamente para propósito de identificación. No existe ninguna afiliación, patrocinio o conexión con el fabricante o pieza de equipo original.

B2 Full-Flow Lube Spin-on (Also Used as Hydraulic or Transmission)



Contains: Anti-Drainback Valve
8 PSID By-Pass Valve
Front End By-Pass Valve
Fits: Chrysler, Ford, Mazda, Toyota Automotive, Light-Duty Trucks; Freightliner, International, Kenworth, Mack, Volvo Trucks; Allis Chalmers, Case, Caterpillar, Ford, John Deere, New Holland Equipment
Replaces: Allis Chalmers 7023700-0; Case A146696; Ford B7A-6714-A, C9NN-6714-A
Thread: 3/4 -16
O.D.: 3 11/16 (93.7)
Height: 5 13/32 (137.3)
I.Gskt: G381-A
Related To: B34 (Short Version)

B2-HPG High Performance Glass Full-Flow Lube Spin-on (Also Used as Hydraulic or Transmission)



Contains: Anti-Drainback Valve
8 PSID Front End By-Pass Valve
Fits: Antonio Carraro, Hagie, Hymac, Steyr-Daimler-Puch Equipment; Iveco, R.V.I. Trucks
Replaces: Allis Chalmers 7023700-0; Case A146696; Ford B7A-6714-A, C9NN-6714-A
Thread: 3/4 -16
O.D.: 3 11/16 (93.7)
Height: 5 13/32 (137.3)
I.Gskt: G381-A

B4 Full-Flow Lube Spin-on



Fits: Chevrolet Automotive
Replaces: GMC 5575425
Thread: 7/16 -20
O.D.: 3 7/16 (87.3)
Height: 4 13/16 (122.2)
I.Gskt: [1] Included
F. Gskt: ES1001

BT5 Full-Flow Lube Spin-on (Also Used as Hydraulic or Transmission)



Contains: Anti-Drainback Valve
8 PSID By-Pass Valve
Fits: Fiat Automotive; Ford, Massey Ferguson, Minneapolis-Moline, Same Equipment; Interceptor Marine; Iveco Trucks
Replaces: Ford B8NN-6714-A
Thread: 3/4 -16
O.D.: 4 1/4 (108.0)
Height: 3 15/16 (100.0)
I.Gskt: G381-A

B6 Full-Flow Lube Spin-on



Notes: 1 Quart Capacity
Fits: Chevrolet, GM Automotive, Light-Duty Trucks, Vans
Replaces: GMC 25013454
Thread: 13/16 -16
O.D.: 3 11/16 (93.7)
Height: 5 11/32 (135.7)
I.Gskt: [1] Included
Related To: B1428 (with Anti-Drainback Valve)

B6-HPG High Performance Glass Full-Flow Lube Spin-on



Notes: 1 Quart Capacity
Fits: Chevrolet, GM Automotive, Light-Duty Trucks, Vans
Replaces: GMC 25013454
Thread: 13/16 -16
O.D.: 3 11/16 (93.7)
Height: 5 11/32 (135.7)
I.Gskt: [1] Included
Related To: B1428 (with Anti-Drainback Valve)

B7 Full-Flow Lube Spin-on



Notes: 2 Quart Capacity
Fits: Chevrolet, GMC Trucks, Buses
Replaces: GMC 25010754
Thread: 13/16 -16
O.D.: 3 11/16 (93.7)
Height: 8 11/16 (220.7)
I.Gskt: [1] Included

B9 Full-Flow Lube Spin-on



Contains: Anti-Drainback Valve
Fits: Allis Chalmers, Case Equipment; Chrysler, GMC, International Light-Duty Trucks; Jeep; Crusader Marine
Replaces: GMC 5515104, 6435678
Thread: 13/16 -16
O.D.: 3 11/16 (93.7)
Height: 5 3/8 (136.5)
I.Gskt: [1] Included
Related To: B39 (Short Version)
BT112 (Turbo Version)

B10-AL Fuel Storage Tank Assembly with Drain



Notes: Removes damaging particles and water from fuels.
Easily installed on fuel tanks or pumps.
Gives effective filtration at flow rates to 25 gpm or gravity flow of 10 gpm with 30 In. head.
To convert to Spin-on, use FB1307 and BF915.
Contains: [1] B10-AL CAP
[1] B10-AL BOWL
[1] PF10 Element
Replaces: Fleetguard 3307454S
O.D.: 4 5/32 (105.6)
Inlet: 1 In. NPT
Outlet: 1 In. NPT
Height: 9 25/32 (248.4)
F. Gskt: G264-A

B10-AL BOWL Transparent Amber Bowl with Drain



Thread: 3 3/8 -12
O.D.: 3 7/8 (98.4)
Height: 8 1/8 (206.4)
F. Gskt: [1] Included

Measurements Are Shown In Inches And (Millimeters)

WARNING: These products can expose you to chemicals, including Diisononyl Phthalate, Carbon black extracts, Nickel, 1,3 Butadiene, Ethylene Oxide, Epichlorohydrin, which are known to the State of California to cause cancer, and Bisphenol, Ethylene Glycol, Ethylene Oxide, 1,3 Butadiene, Epichlorohydrin, which are known to the State of California to cause birth defects or other reproductive harm. For more information go to www.P65Warnings.ca.gov.

B10-AL BSP



Fuel Storage Tank Assembly with Drain
Notes: Removes damaging particles and water from fuels. Easily installed on fuel tanks or pumps. Gives effective filtration at flow rates to 25 gpm or gravity flow of 10 gpm with 30 In. head.
Contains: [1] CAP
 [1] B10-AL BOWL
 [1] PF10 Element
O.D.: 4 5/32 (105.6)
Inlet: 1 In. BSP
Outlet: 1 In. BSP
Length: 9 25/32 (248.4)
F. Gskt: G264-A

B10-AL BSPCS



Fuel Storage Tank Assembly with Water Absorbing Media and Drain
Notes: Removes damaging particles and water from fuels. Easily installed on fuel tanks or pumps. Gives effective filtration at flow rates to 25 gpm or gravity flow of 10 gpm with 30 In. head.
Contains: [1] CAP
 [1] B10-AL BOWL
 [1] PF10-CS Element
O.D.: 4 5/32 (105.6)
Inlet: 1 In. BSP
Outlet: 1 In. BSP
Height: 9 25/32 (248.4)
F. Gskt: G264-A

B10-AL CAP



Inlet-Outlet Cap for B10-AL Only
Inlet: 1 In. NPT
Outlet: 1 In. NPT

PF10



Fuel Storage Tank Element
Contains: 1 1/8-12 Mounting Stud
Fits Inside: B10-AL Assembly; B10-AL BOWL; B10-AL BSP Assembly
O.D.: 3 (76.2)
Height: 4 7/8 (123.8)
F. Gskt: G264-A
End Seals: [1] Attached
Related To: PF10-CS (Water Absorbing Media Version)

PF10-CS



Water Absorbing Fuel Storage Tank Element
Contains: 1 1/8-12 Mounting Stud
O.D.: 3 (76.2)
Height: 4 7/8 (123.8)
F. Gskt: G264-A
End Seals: [1] Attached
Related To: PF10 (Standard Version)

PT11



Full-Flow Lube Element
Fits: Detroit Diesel, GMC Engines
Replaces: GMC 5574978
O.D.: 4 7/16 (112.7)
I.D.: 1 17/32 (38.9)
Height: 5 3/4 (146.1)
F. Gskt: G115-MSB, G143
O. Gskt: G280
End Seals: [2] Attached

PT11-HD



Heavy-Duty Full-Flow Lube or Hydraulic Clutch Element
Fits: Detroit Diesel, GMC Engines
Replaces: GMC 5574978
O.D.: 4 7/16 (112.7)
I.D.: 1 17/32 (38.9)
Height: 5 3/4 (146.1)
F. Gskt: G115-MSB, G143
O. Gskt: G280
End Seals: [2] Attached

PT12



Full-Flow Lube Element
Fits: Claas, Ford, Perkins Engines; Hymac, Hyster, J.C. Bamford, Massey Ferguson, New Holland Equipment
Replaces: Perkins 1531639
O.D.: 3 3/4 (95.3)
I.D.: 1 5/16 (33.3)
Height: 4 11/16 (119.1)
F. Gskt: G168-B
O. Gskt: G140-A
End Seals: [2] Attached

BF13



Fuel Spin-on
Fits: Isuzu, Nissan Trucks
Replaces: Nissan 16403-Z9003
Thread: 3/4 -16
O.D.: 3 1/32 (77.0)
Height: 4 13/16 (122.2)
I.Gskt: [1] Included

P15



Full-Flow Lube Element
Fits: Ford, Perkins Engines
Replaces: Ford C2TZ-6714-A
O.D.: 3 3/4 (95.3)
I.D.: 1 5/16 (33.3)
Height: 3 13/16 (96.8)
F. Gskt: G168-B
End Seals: [2] Attached

S16-1



Transmission Element with Screen Reinforced Pleats
Fits: Allison Transmissions
Replaces: GMC 6437221
O.D.: 2 7/8 (73.0)
I.D.: 1 3/16 (30.2)
Height: 8 7/16 (214.3)
F. Gskt: [2] O-Rings, [1] Cork Gasket, [1] Copper Washer
End Seals: [2] Attached

Measurements Are Shown In Inches And (Millimeters)

! **WARNING:** These products can expose you to chemicals, including Diisononyl Phthalate, Carbon black extracts, Nickel, 1,3 Butadiene, Ethylene Oxide, Epichlorohydrin, which are known to the State of California to cause cancer, and Bisphenol, Ethylene Glycol, Ethylene Oxide, 1,3 Butadiene, Epichlorohydrin, which are known to the State of California to cause birth defects or other reproductive harm. For more information go to www.P65Warnings.ca.gov.

P18 Full-Flow Lube Element
Fits: Chevrolet, GMC Trucks; Crusader, Mercruiser Marine
Replaces: Chris-Craft 5574540; Cruisemaster 204; GMC 25010471
O.D.: 3 17/32 (89.7)
I.D.: 1 5/16 (33.3)
Height: 5 21/32 (143.7)
F. Gskt: G153
End Seals: [2] Attached



P18-HD Heavy-Duty Racing Lube or Hydraulic Element
Fits: Allison Transmissions; Joy Compressors; Volvo Trucks
Replaces: Joy 1224973; Volvo 1526895-6
O.D.: 3 17/32 (89.7)
I.D.: 1 5/16 (33.3)
Height: 5 21/32 (143.7)
F. Gskt: G153
End Seals: [2] Attached



P19 Full-Flow Lube Element
Fits: Chevrolet Trucks
Replaces: GMC 5573976
O.D.: 3 1/2 (88.9)
I.D.: 1 1/4 (31.8)
Height: 6 1/4 (158.8)
F. Gskt: G153



P20-HD Full-Flow Lube Element
Notes: To convert to spin-on, use OB1303 base and B95 filter.
 For copper bolt seal, use ES1071.
Fits: Allis Chalmers, Case, Clark, Euclid, Gardner Denver, Gradall, Terex Equipment; Detroit Diesel Engines; IHC, Iveco, Kenworth, Mack Trucks
Replaces: GMC 5573013, 25013194
O.D.: 4 7/16 (112.7)
I.D.: 1 1/2 (38.1)
Height: 9 1/16 (230.2)
F. Gskt: G115-MSB, G143A, ES1032
O. Gskt: G143, G280, G336, G340
End Seals: [2] Attached
Related To: PT159, PT159-E (Transmission Versions)



V24-A2 Vac-Cel By-Pass Lube Sock
Fits: Detroit Diesel Engines
Replaces: GMC 5571549, 5572394
O.D.: 4 5/8 (117.5)
I.D.: 5/8 (15.9)
Height: 18 1/8 (460.4)
F. Gskt: G140-A
O. Gskt: G363
End Seals: [2] Attached



P25 Full-Flow Lube Element
Contains: Reinforced Centertube
Fits: Buick, Oldsmobile, Pontiac Automotive; GMC Light-Duty Trucks; Crusader, GMC, Hyster, DAF Engines
Replaces: GMC 5572188
O.D.: 3 15/16 (100.0)
I.D.: 1 1/16 (27.0)
Height: 6 1/4 (158.8)
F. Gskt: [1] Included
End Seals: [2] Attached



P26 By-Pass Lube Element with Bail Handle
Fits: ACDelco Optional Filter Housings; Buick Automotive
Replaces: GMC 5572202
O.D.: 4 7/32 (107.2)
I.D.: 17/32 (13.5)
Height: 4 11/16 (119.1)
F. Gskt: G115-A
Grommets: [2] Attached



B27 Full-Flow Lube Spin-on
Fits: Buick, Chevrolet Automotive; GMC Light-Duty Trucks, Vans
Replaces: GMC 6437412
Thread: 13/16 -16
O.D.: 3 13/16 (96.8)
Height: 4 3/8 (111.1)
I.Gskt: [1] Included



BD28 Dual-Flow Lube Spin-on
Contains: Anti-Drainback Valve
 20 PSID By-Pass Valve
Fits: Ford Light-Duty Trucks
Replaces: Ford E5TZ-6731-A
Thread: M26 x 1.5
O.D.: 3 11/16 (93.7)
Height: 5 3/8 (136.5)
I.Gskt: G381-A



PT29 Full-Flow Lube Element
Fits: Caterpillar Lift Trucks; Ford (British) Tractors; Claas, Massey Ferguson, Timberjack Equipment
Replaces: Ford E1ADKN-18662-A, E1ADKN-18662-B
O.D.: 2 13/16 (71.4)
I.D.: 1 1/4 (31.8) & 1 5/16 (33.3)
Height: 5 17/32 (140.5)
F. Gskt: G147-A, G161, [2] Included
End Seals: [2] Attached



AFG30 Air Filter Restriction Gauge
Notes: Murphy switch gauge shows exact degree of air filter restriction at a glance. Mounts in dash (2 1/16 in. diameter hole) and shows both inches and cubic centimeters. Measures 0-30 inches water column vacuum.
Contains: Mounting bracket.
Replaces: Fleetguard 3826036S



B30 Full-Flow Lube Spin-on
Fits: GM Automotive
Replaces: GMC 25010324
Thread: 13/16 -16
O.D.: 3 (76.2)
Height: 5 1/8 (130.2)
A. Gskt: G449-B



B31 Full-Flow Lube Spin-on
Contains: Anti-Drainback Valve
Fits: AMC, GM Automotive, Light-Duty Trucks, Vans
Replaces: GMC 25010251
Thread: 13/16 -16
O.D.: 3 (76.2)
Height: 3 1/2 (88.9)
A. Gskt: G449-B



Measurements Are Shown In Inches And (Millimeters)

WARNING: These products can expose you to chemicals, including Diisononyl Phthalate, Carbon black extracts, Nickel, 1,3 Butadiene, Ethylene Oxide, Epichlorohydrin, which are known to the State of California to cause cancer, and Bisphenol, Ethylene Glycol, Ethylene Oxide, 1,3 Butadiene, Epichlorohydrin, which are known to the State of California to cause birth defects or other reproductive harm. For more information go to www.P65Warnings.ca.gov.

B33



Full-Flow Lube Spin-on

Contains: Anti-Drainback Valve
14 PSID By-Pass Valve
Fits: Daihatsu, GMC, Toyota Automotive,
Light-Duty Trucks; Generac Generators;
John Deere Equipment
Replaces: GMC 25161880; John Deere
AM107423; Toyota 90915-03001
Thread: 3/4 -16
O.D.: 2 11/16 (68.3)
Height: 3 (76.2)
I.Gskt: [1] Included

AFG38D



Direct Mount Air Filter Restriction Gauge

Notes: Mounts directly on air intake system.
Maintains the highest reading until it is reset,
which enables the gauge to be monitored
whether the engine is running or not. Allows
user to get maximum life of an air filter without
wasting fuel.
Contains: 2-piece, 90 degree brass 1/8 Inch
NPT fitting
Service decal
Installation instructions
Replaces: GMC 25095863; Fleetguard
3304584S

B34



Lube Spin-on

Contains: Anti-Drainback Valve
8 PSID By-Pass Valve
Fits: Chrysler, Mitsubishi, Volkswagen
Automotive, Light-Duty Trucks, Vans
Replaces: Chrysler 5281090
Thread: 3/4 -16
O.D.: 3 11/16 (93.7)
Height: 3 7/8 (98.4)
I.Gskt: G381-A
Related To: B2 (Long Version)

B39



Full-Flow Lube Spin-on

Contains: Anti-Drainback Valve
Fits: AMC, GM Automotive; GMC, International
Engines
Replaces: GMC 6437462
Thread: 13/16 -16
O.D.: 3 11/16 (93.7)
Height: 4 3/8 (111.1)
A. Gskt: G381-A
Related To: B9 (Long Version)

B35-S



Full-Flow Lube Spin-on

Contains: Anti-Drainback Valve
Fits: GM Automotive, Light-Duty Trucks, Vans
Replaces: GMC 25012760
Thread: M18 x 1.5
O.D.: 3 (76.2)
Height: 4 27/32 (123.0)
A. Gskt: G449-B
Related To: B43-S (Short Version)

P40



Full-Flow Lube Element with Bail Handle

Fits: Clark, Galion, Hyster in Fram F3 Series
Housings; Allis Chalmers, Bobcat, Case,
Caterpillar, Fiat, Onan, Massey Ferguson
Equipment
Replaces: Clark 604081; Hyster 60518-24;
Massey Ferguson 1014219-M91
O.D.: 3 23/32 (94.5)
I.D.: 1/2 (12.7)
Height: 4 7/16 (112.7)
F. Gskt: G105
O. Gskt: G115-A, G402
Grommets: [2] Attached

AFG37R



Remote Mount Air Filter Restriction Gauge

Notes: Mounts on instrument panel or firewall.
Maintains the highest reading until it is reset,
which enables the gauge to be monitored
whether the engine is running or not. Allows the
user to get maximum life of an air filter without
wasting fuel.
Contains: 10 foot rubber hose
Push-on brass 1/8 In NPT fitting with brass
coupling
Mounting screws
Service decal
Installation instructions
Replaces: GMC 25095861; Fleetguard
3303943S

P41



By-Pass Lube Element with Bail Handle

Fits: Allis Chalmers, Case, Clark, Continental,
Deutz, Ford, Huber Equipment; Hercules,
Mercedes-Benz Engines
Replaces: Allis Chalmers 4502495-4; Case
G54008; Clark 4502495; Ford C7NN-6N605-A
O.D.: 4 7/32 (107.2)
I.D.: 1/2 (12.7)
Height: 4 7/8 (123.8)
F. Gskt: G104
Grommets: [2] Attached
Related To: PF809 (Fuel Version)

B37



Full-Flow Lube Spin-on

Contains: Anti-Drainback Valve
14 PSID By-Pass Valve
Fits: GMC Imports, Suzuki, Toyota Automotive
Replaces: GMC 94848478; Toyota 90915-10004
Thread: 3/4 -16
O.D.: 2 9/16 (65.1)
Height: 3 1/2 (88.9)
I.Gskt: [1] Included

P42



By-Pass Lube Element with Bail Handle

Fits: Allis Chalmers, Case, Caterpillar,
Continental, Deutz Equipment; Mercedes-Benz
Engines
Replaces: Case A28008; Caterpillar 63-6372;
Deutz 1168469
O.D.: 4 7/32 (107.2)
I.D.: 1/2 (12.7)
Height: 7 3/4 (196.9)
F. Gskt: G104
O. Gskt: G103
Grommets: [2] Attached

Measurements Are Shown In Inches And (Millimeters)



WARNING: These products can expose you to chemicals, including Diisononyl Phthalate, Carbon black extracts, Nickel, 1,3 Butadiene, Ethylene Oxide, Epichlorohydrin, which are known to the State of California to cause cancer, and Bisphenol, Ethylene Glycol, Ethylene Oxide, 1,3 Butadiene, Epichlorohydrin, which are known to the State of California to cause birth defects or other reproductive harm. For more information go to www.P65Warnings.ca.gov.

B43-S Full-Flow Lube Spin-on
Contains: Anti-Drainback Valve
Fits: AMC, GM, Isuzu Automotive
Replaces: GMC 25010766
Thread: M18 x 1.5
O.D.: 2 29/32 (73.8)
Height: 3 1/2 (88.9)
A. Gskt: G449-B
Related To: B35-S (Long Version)



B45 Full-Flow Lube Spin-on
Fits: Nissan Engines, Trucks
Replaces: Nissan 15208-Z9003
Thread: 1 1/8 -16
O.D.: 4 5/16 (109.5)
Height: 9 5/32 (232.6)
I.Gskt: [1] Included



P47 Full-Flow Lube Element
Fits: Ford Equipment
Replaces: Ford B8QH-6714-A
O.D.: 4 1/2 (114.3)
I.D.: 13/16 (20.6)
Height: 4 15/16 (125.4)
F. Gskt: G164-A, [2] Included
End Seals: [1] Attached



PT48 Hydraulic or Transmission Element with Bail Handle
Fits: Allis Chalmers, Clark, Hyster Equipment; Iveco Trucks
Replaces: Allis Chalmers 618478; Fiat 70618478; Hyster 236093-12
O.D.: 2 7/8 (73.0)
I.D.: 25/32 (19.8) & 13/16 (20.6)
Height: 3 31/32 (100.8)
F. Gskt: [1] Included
End Seals: [2] Attached



B49 Full-Flow Lube Spin-on
Fits: Caterpillar Equipment
Replaces: Fleetguard LF691
Thread: 1 1/2 -16
O.D.: 4 21/32 (118.3)
Height: 11 1/4 (285.8)
I.Gskt: G498-A
Related To: B99 (Long Version)



B50 By-Pass Lube Spin-on
Notes: Can be used with OB1305 base.
Contains: Flow Control Orifice
Fits: Allis Chalmers, Caterpillar Engines, Equipment; Massey Ferguson, Oliver Equipment
Replaces: Allis Chalmers 4512207-3; Caterpillar 666-3172; Chrysler J0936407; Massey Ferguson 1069954-M91
Thread: 5/8 -18
O.D.: 3 11/16 (93.7)
Height: 5 3/8 (136.5)
I.Gskt: G381-A
Related To: B164 (Long Version) BT341 (Short Version)



P52 By-Pass Lube Element with Bail Handle
Fits: ACDelco S2 Military Senior Housing; Atlas Copco, Clark, Euclid, Grove, Link-Belt, Terex Equipment; Detroit Diesel, Deutz, GMC, Waukesha Engines
Replaces: GMC 5570092; ACDelco P117
O.D.: 4 7/32 (107.2)
I.D.: 1/2 (12.7)
Height: 8 (203.2)
F. Gskt: G115-A, G115-MSB
O. Gskt: G208-A, G280, ES1071
Grommets: [2] Attached



P53 By-Pass Lube Element with Bail Handle
Fits: Equipment, Trucks with Chevrolet, Continental, GMC, Hercules, Waukesha, White, Wisconsin Engines
Replaces: GMC 5570098
O.D.: 4 7/32 (107.2)
I.D.: 1/2 (12.7)
Height: 5 (127.0)
F. Gskt: G115-A
Grommets: [2] Attached



P54 By-Pass Shunt-Type Lube Ele w/Bail Handle (Also Used as Fuel or Power Steering)
Fits: Crane Carrier, Davey, Oliver Equipment; Ingersoll-Rand Compressors
Replaces: Davey M14402; Oliver AS5507B
O.D.: 3 23/32 (94.5)
I.D.: 1/2 (12.7)
Height: 6 23/32 (170.7)
F. Gskt: G123, [1] Included
Grommets: [2] Attached



B56 Lube Spin-on
Contains: 19 PSID By-Pass Valve
Fits: Onan Engines
Replaces: Onan 122-0602
Thread: M22 x 1.5
O.D.: 3 (76.2)
Height: 4 27/32 (123.0)
I.Gskt: G449-B



P60 Full-Flow Lube Element
Fits: Chrysler Industrial, Marine Engines; Purolator P800 Series Housings
Replaces: Purolator P82
O.D.: 3 5/16 (84.1)
I.D.: 1 1/4 (31.8)
Height: 6 3/4 (171.5)
F. Gskt: G106, G162, [1] Included



61 DAHL Fuel Element
Notes: 4 Micron Nominal (20 Absolute)
Fits: DAHL 60 Series Fuel Filter/Water Separator Unit
O.D.: 2 29/32 (73.8)
I.D.: 1/2 (12.7) & 23/32 (18.3)
Height: 1 23/32 (43.7)
A. Gskt: [1] Included
F. Gskt: [1] Included
Grommets: [1] Attached



Measurements Are Shown In Inches And (Millimeters)

WARNING: These products can expose you to chemicals, including Diisononyl Phthalate, Carbon black extracts, Nickel, 1,3 Butadiene, Ethylene Oxide, Epichlorohydrin, which are known to the State of California to cause cancer, and Bisphenol, Ethylene Glycol, Ethylene Oxide, 1,3 Butadiene, Epichlorohydrin, which are known to the State of California to cause birth defects or other reproductive harm. For more information go to www.P65Warnings.ca.gov.

61-W DAHL Fuel Element
Notes: 5 Micron Nominal (25 Absolute)
Fits: DAHL 60 Series Fuel Filter/Water Separator Unit
O.D.: 2 29/32 (73.8)
I.D.: 1/2 (12.7) & 23/32 (18.3)
Height: 1 23/32 (43.7)
A. Gskt: [1] Included
F. Gskt: [1] Included
Grommets: [1] Attached



66-W DAHL Fuel Element
Notes: 5 Micron Nominal (25 Absolute)
Fits: DAHL 65 and 75 Series Fuel Filter/Water Separator Units
O.D.: 2 15/16 (74.6)
I.D.: 13/32 (10.3) & 1/2 (12.7)
Height: 1 13/16 (46.0)
A. Gskt: [1] Included
O-Ring: [1] Included
Grommets: [1] Attached



PT61-HD Full-Flow Lube or Hydraulic Element
Contains: Reinforced Centertube
Fits: Caterpillar Engines, Equipment
Replaces: Caterpillar 5B8934, 8B5935
O.D.: 3 1/2 (88.9)
I.D.: 1 15/32 (37.3)
Height: 5 29/32 (150.0)
O. Gskt: G115-MSB, G171, G333



PT66-HD Full-Flow Lube or Hydraulic Element
Notes: Can be used independently or with PT88-HD as outer lube.
Contains: Reinforced Centertube
Fits: Caterpillar, Clark, Gardner Denver, LeRoi, Link-Belt Equipment
Replaces: Caterpillar 1S9150; LeRoi 24901-2, A43-208, A43-208-A
O.D.: 2 7/8 (73.0)
I.D.: 1 13/32 (35.7)
Height: 9 (228.6)
O. Gskt: G171, G270, G283, G376, G410, G432, G435, G436, G442
End Seals: [2] Attached



PT62 Full-Flow Lube Element
Fits: John Deere Equipment
Replaces: John Deere AH1081R
O.D.: 3 5/16 (84.1)
I.D.: 1 1/8 (28.6)
Height: 4 1/8 (104.8)
A. Gskt: [1] Attached
F. Gskt: G107



P67 By-Pass Lube Element with Bail Handle
Fits: Massey Ferguson Engines; Purolator N1600 Series Housings
Replaces: Case 10017-2; Chrysler 557218
O.D.: 3 23/32 (94.5)
I.D.: 21/32 (16.7)
Height: 5 1/4 (133.4)
F. Gskt: [1] Included
End Seals: [2] Attached



PT63-1 Full-Flow Lube Element
Fits: John Deere Equipment
Replaces: John Deere AT15088
O.D.: 3 9/32 (83.3)
I.D.: 1 19/32 (40.5)
Height: 6 1/2 (165.1)
O. Gskt: G220, G251



P68 By-Pass Lube or Torque Converter Element with Bail Handle
Fits: Caterpillar, International Engines; Purolator N1700 Series Housings
Replaces: Caterpillar 1L6946; International 259630-R91
O.D.: 3 23/32 (94.5)
I.D.: 25/32 (19.8)
Height: 5 7/8 (149.2)
F. Gskt: [1] Included
End Seals: [2] Included



66 DAHL Fuel Element
Notes: 4 Micron Nominal (20 Absolute)
Fits: DAHL 65 and 75 Series Fuel Filter/Water Separator Units
O.D.: 2 15/16 (74.6)
I.D.: 13/32 (10.3) & 1/2 (12.7)
Height: 1 13/16 (46.0)
A. Gskt: [1] Included
O-Ring: [1] Included
Grommets: [1] Attached



PT70 By-Pass Lube Element
Fits: International Engines
Replaces: International 360431-R91
O.D.: 3 1/2 (88.9)
I.D.: 1/2 (12.7) & 15/16 (23.8)
Height: 7 11/32 (186.5)
F. Gskt: G107



66-30 DAHL Fuel Element
Notes: 9 Micron Nominal (40 Absolute)
Fits: DAHL 65 and 75 Series Fuel Filter/Water Separator Units
O.D.: 2 15/16 (74.6)
I.D.: 13/32 (10.3) & 1/2 (12.7)
Height: 1 13/16 (46.0)
A. Gskt: [1] Included
O-Ring: [1] Included
Grommets: [1] Attached



PT71 By-Pass Lube Element
Fits: International Engines, Equipment
Replaces: International 376374-R91
O.D.: 3 15/32 (88.1)
I.D.: 17/32 (13.5) & 31/32 (24.6)
Height: 5 11/32 (135.7)
F. Gskt: G107



Measurements Are Shown In Inches And (Millimeters)

 **WARNING:** These products can expose you to chemicals, including Diisononyl Phthalate, Carbon black extracts, Nickel, 1,3 Butadiene, Ethylene Oxide, Epichlorohydrin, which are known to the State of California to cause cancer, and Bisphenol, Ethylene Glycol, Ethylene Oxide, 1,3 Butadiene, Epichlorohydrin, which are known to the State of California to cause birth defects or other reproductive harm. For more information go to www.P65Warnings.ca.gov.

PT72



By-Pass Lube Element

Fits: Galion, International, LeRoi, Link-Belt, Oliver Equipment; Hercules, International Engines
Replaces: International 257867-R91
O.D.: 3 15/16 (100.0)
I.D.: 5/8 (15.9) & 27/32 (21.4)
Height: 7 1/4 (184.2)
O. Gskt: G115-MSB, G280

P73



By-Pass Lube Element with Bail Handle

Fits: Lid-Type Remote-Mounted By-Pass Filter Housings on Caterpillar, Massey Ferguson, Oliver, Palmer, Pettibone Equipment
Replaces: Caterpillar A68660
O.D.: 3 15/32 (88.1)
I.D.: 9/16 (14.3) & 13/16 (20.6)
Height: 4 3/16 (106.4)
F. Gskt: G106
Grommets: [1] Attached
Related To: P81 (Shunt-Type Version)

B74



Lube Spin-on

Contains: Anti-Drainback Valve
 20 PSID By-Pass Valve
Fits: Caterpillar, Ford, New Holland Equipment; Land Rover Light-Duty Trucks
Replaces: Ford E8NN-6714-AA
Thread: 3/4 -16
O.D.: 3 3/4 (95.3)
Height: 3 31/32 (100.8)
I.Gskt: G381-A

B75



Full-Flow Lube Spin-on

Fits: Caterpillar, Iveco, J.C. Bamford, Kawasaki, Kobelco, Koehring, Link-Belt, MDI/Yutani, New Holland, Tamrock, White Equipment; Caterpillar, Isuzu Engines; Chevrolet, GMC, Isuzu, Iveco, Mitsubishi Trucks
Replaces: Caterpillar 9N6007; Isuzu 1-13240-122-0
Thread: 1 1/8 -16
O.D.: 4 1/4 (108.0)
Height: 5 27/32 (148.4)
I.Gskt: [1] Included

B76



Full-Flow Lube Spin-on

Fits: Akerman, Mack, V.M.E., Volvo, R.V.I. Engines, Equipment
Replaces: Mack 485GB3191
Thread: 1 1/8 -16
O.D.: 4 1/4 (108.0)
Height: 10 7/16 (265.1)
I.Gskt: [1] Included
Related To: B76-MPG (Maximum Performance Glass Version)
 B76-SS (Severe Service Version)
 BT556-10 (Hydraulic Version)
 B7225 (Media Difference)
 B7600, B7600-SS (Short Versions)
 B7700 (High Performance, Short Version)

B76-MPG



Maximum Performance Glass Full-Flow Lube Spin-on

Fits: Akerman, Mack, V.M.E., Volvo, R.V.I. Engines, Equipment
Replaces: Mack 485GB3191
Thread: 1 1/8 -16
O.D.: 4 1/4 (108.0)
Height: 10 7/16 (265.1)
I.Gskt: [1] Included
Related To: B76 (Standard Version)
 B76-SS (Severe Service Version)
 BT556-10 (Hydraulic Version)
 B7225 (Media Difference)
 B7600, B7600-SS (Short Versions)
 B7700 (High Performance, Short Version)

B76-SS



Severe Service Lube Spin-on

Fits: Akerman, Mack, V.M.E., Volvo, R.V.I. Engines, Equipment
Replaces: Mack 485GB3191
Thread: 1 1/8 -16
O.D.: 4 1/4 (108.0)
Height: 10 7/16 (265.1)
I.Gskt: [1] Included
Related To: B76 (Standard Version)
 B76-MPG (Maximum Performance Glass Version)
 BT556-10 (Hydraulic Version)
 B7225 (Media Difference)
 B7600, B7600-SS (Short Versions)
 B7700 (High Performance, Short Version)

PT79



Full-Flow Lube Element

Fits: Galion, International Equipment; Ingersoll-Rand, Joy, LeRoi Compressors
Replaces: International 262146-R91
O.D.: 4 9/16 (115.9)
I.D.: 1 1/4 (31.8) & 1 11/16 (42.9)
Height: 9 (228.6)
F. Gskt: [1] Included
End Seals: [1] Attached

P80



Full-Flow Lube Element

Fits: Allis Chalmers, Case, Grove, New Holland Equipment
Replaces: Ford CPN-6731-A; Fuller A2007, 12039
O.D.: 3 15/16 (100.0)
I.D.: 23/32 (18.3)
Height: 4 13/16 (122.2)
F. Gskt: G132, G208-A, [2] Included
O. Gskt: G171
Grommets: [2] Attached

P80-HD



Heavy-Duty Full-Flow Lube or Hydraulic Element

Fits: Various Equipment with Dana, Fuller Transmissions
Replaces: Ford CPN-6731-A; Fuller A2007, 12039
O.D.: 3 15/16 (100.0)
I.D.: 23/32 (18.3)
Height: 4 13/16 (122.2)
F. Gskt: G132, G208-A, [2] Included
O. Gskt: G171
Grommets: [2] Attached

Measurements Are Shown In Inches And (Millimeters)

WARNING: These products can expose you to chemicals, including Diisononyl Phthalate, Carbon black extracts, Nickel, 1,3 Butadiene, Ethylene Oxide, Epichlorohydrin, which are known to the State of California to cause cancer, and Bisphenol, Ethylene Glycol, Ethylene Oxide, 1,3 Butadiene, Epichlorohydrin, which are known to the State of California to cause birth defects or other reproductive harm. For more information go to www.P65Warnings.ca.gov.

P81



Shunt-Type Lube Element
Fits: Purolator P704 Shunt-Type Filter Housing on Chrysler Engines
Replaces: Chrysler 1123151
O.D.: 3 5/16 (84.1)
I.D.: 15/16 (23.8)
Height: 4 1/16 (103.2)
F. Gskt: G106
Related To: P73 (By-Pass Version)

PT84-2



Full-Flow Lube Element
Fits: Chrysler Engines; Link-Belt, Massey Ferguson, Oliver Equipment
Replaces: Chrysler 1557376
O.D.: 3 5/16 (84.1)
I.D.: 15/16 (23.8)
Height: 4 1/16 (103.2)
F. Gskt: [5] Included

P82



Full-Flow Lube Element
Fits: Allis Chalmers, Case, Caterpillar, Deutz Equipment; Chrysler, Hercules Engines
Replaces: Allis Chalmers 73035376; Case D45338; Caterpillar 5B5935; Clark 957577
O.D.: 3 15/16 (100.0)
I.D.: 1 1/16 (27.0)
Height: 5 15/16 (150.8)
F. Gskt: G106, [2] Included
O. Gskt: G219, G222-B
Related To: PF822 (Fuel Version)

PT85



Full-Flow Lube Element
Fits: Cleveland, Hough, International, Link-Belt Equipment
Replaces: International 323863-R91
O.D.: 4 5/8 (117.5)
I.D.: 1 5/16 (33.3)
Height: 5 1/8 (130.2)
O. Gskt: G203
End Seals: [1] Attached

PT82-HD



Heavy-Duty Lube or Hydraulic Element
Fits: Akerman, Allis Chalmers, Case, Caterpillar, Clark, Deutz, Link-Belt Equipment
Replaces: Allis Chalmers 4513108-2; Case D45338; Caterpillar 3K5487; Clark 957572
O.D.: 3 15/16 (100.0)
I.D.: 1 1/16 (27.0)
Height: 5 15/16 (150.8)
F. Gskt: [4] Included
O. Gskt: G219, G222-B
Related To: PF822 (Fuel Version)

PT86-HD



Full-Flow Lube or Hydraulic Element
Fits: Dresser, Galion, Hough, International, LeRoi, Link-Belt Equipment
Replaces: International 346609-R91
O.D.: 4 1/2 (114.3)
I.D.: 1 25/32 (45.2)
Height: 8 15/16 (227.0)
F. Gskt: [2] Included
O. Gskt: G280
End Seals: [2] Attached

PT82-HD10



Hydraulic Element
Fits: Case, Ingersoll-Rand Equipment
Replaces: Allis Chalmers 4513108-2; Case D45338; Caterpillar 3K5487; Clark 957572
O.D.: 3 15/16 (100.0)
I.D.: 1 1/16 (27.0)
Height: 5 15/16 (150.8)
F. Gskt: [4] Included
O. Gskt: G219, G222-B
Related To: PF822 (Fuel Version)

PT87-S



Full-Flow Lube, Hydraulic or Transmission Element
Fits: John Deere Equipment
Replaces: John Deere AR28271, AR75603, AT34670
O.D.: 4 9/16 (115.9)
I.D.: 2 1/4 (57.2)
Height: 5 1/2 (139.7)
F. Gskt: G307, G397
End Seals: [2] Attached

PT83



Hydraulic Element
Notes: Inside-Out Flow Direction. Use ES4008 for stacked elements.
Contains: Reinforced Centertube
Fits: Caterpillar Equipment
Replaces: Caterpillar 9J5461
O.D.: 5 1/16 (128.6)
I.D.: 3 11/32 (84.9)
Height: 11 (279.4)
O. Gskt: G247, G263, G416, G433, ES4008
Related To: PT83-MPG

PT88-HD



Full-Flow Lube or Hydraulic Element
Notes: Use ES4008 for stacked elements. Can be used independently or with PT66-HD as inner lube.
Fits: Caterpillar, Clark, Hyster, Komatsu, LeRoi Equipment
Replaces: Caterpillar 5S485, 5S0485
O.D.: 5 1/8 (130.2)
I.D.: 3 3/8 (85.7)
Height: 8 15/16 (227.0)
F. Gskt: G196-B
O. Gskt: G303, G304, G306, G354, ES4008

PT83-MPG



Maximum Performance Glass Hydraulic Element
Notes: Inside-Out Flow Direction. Use ES4008 for stacked elements.
Contains: Reinforced Centertube
Fits: Caterpillar Equipment
Replaces: Caterpillar 9J5461
O.D.: 5 1/16 (128.6)
I.D.: 3 11/32 (84.9)
Height: 11 (279.4)
O. Gskt: G247, G263, G416, G433, ES4008

PT89



Hydraulic Steering or Power Control Element
Fits: Allis Chalmers Tractors; Caterpillar Equipment
Replaces: Caterpillar 5J8877
O.D.: 5 1/8 (130.2)
I.D.: 3 3/8 (85.7)
Height: 6 (152.4)
O. Gskt: G265

Measurements Are Shown In Inches And (Millimeters)

WARNING: These products can expose you to chemicals, including Diisononyl Phthalate, Carbon black extracts, Nickel, 1,3 Butadiene, Ethylene Oxide, Epichlorohydrin, which are known to the State of California to cause cancer, and Bisphenol, Ethylene Glycol, Ethylene Oxide, 1,3 Butadiene, Epichlorohydrin, which are known to the State of California to cause birth defects or other reproductive harm. For more information go to www.P65Warnings.ca.gov.

PT90-10



Hydraulic Element

Notes: Use ES4008 for stacked elements.
Contains: Reinforced Centertube
Fits: Allis Chalmers, Caterpillar, Fiat-Allis, Komatsu Equipment
Replaces: Caterpillar 4J806, 4J6064
O.D.: 5 1/8 (130.2)
I.D.: 3 3/8 (85.7)
Height: 9 (228.6)
O. Gskt: G196-B, G265, G347, G360, ES4008
Related To: PT568 (as Specified in Applications)

PT90-MPG



Maximum Performance Glass Hydraulic Element

Notes: Use ES4008 for stacked elements.
Contains: Reinforced Centertube
Fits: Caterpillar Equipment
Replaces: Caterpillar 4J806, 4J6064
O.D.: 5 1/8 (130.2)
I.D.: 3 3/8 (85.7)
Height: 9 (228.6)
O. Gskt: G196-B, G265, G347, G360, ES4008
Related To: PT568 (as Specified in Applications)

PT91



Hydraulic Element

Notes: Inside-Out Flow Direction
Contains: Reinforced Centertube
Fits: Caterpillar Equipment
Replaces: Caterpillar 4T0522
O.D.: 5 1/8 (130.2)
I.D.: 3 3/8 (85.7)
Height: 7 (177.8)

PT93



Full-Flow Lube or Hydraulic Element

Contains: Reinforced Centertube
Fits: Caterpillar Equipment
Replaces: Caterpillar 4J816
O.D.: 3 1/8 (79.4)
I.D.: 1 7/8 (47.6)
Height: 8 31/32 (227.8)
O. Gskt: G162, G323, G434

PT93-MPG



Maximum Performance Glass Hydraulic Element

Contains: Reinforced Centertube
Fits: Caterpillar Equipment
Replaces: Caterpillar 4J816
O.D.: 3 1/8 (79.4)
I.D.: 1 7/8 (47.6)
Height: 8 31/32 (227.8)
O. Gskt: G162, G323, G434

B95



Full-Flow Lube Spin-on

Notes: Can be used with OB1303 base.
Contains: Integral Post Seal
Fits: Detroit Diesel Engines
Replaces: GMC 25010495
Thread: 1 1/2 -12
O.D.: 4 21/32 (118.3)
Height: 9 15/16 (252.4)
I.Gskt: [1] Included
Related To: B105 (Short Version)

B95-MPG



Maximum Performance Glass Full-Flow Lube Spin-on

Notes: Can be used with OB1303 base.
Contains: Integral Post Seal
Fits: Detroit Diesel Engines
Replaces: GMC 25010495
Thread: 1 1/2 -12
O.D.: 4 21/32 (118.3)
Height: 9 15/16 (252.4)
I.Gskt: [1] Included

B95-SS



Severe Service Full-Flow Lube Spin-on

Notes: Can be used with OB1303 base.
Contains: Integral Post Seal
Fits: Detroit Diesel Engines
Replaces: GMC 25010495
Thread: 1 1/2 -12
O.D.: 4 21/32 (118.3)
Height: 9 15/16 (252.4)
I.Gskt: [1] Included

B96



Full-Flow Lube Spin-on

Notes: Can be used with OB1368, OB1369 bases.
Contains: Integral Post Seal
Fits: Cummins Engines
Replaces: Cummins 3313287
Thread: 1 1/2 -12
O.D.: 4 11/16 (119.1)
Height: 11 9/32 (286.5)
I.Gskt: [1] Included
Related To: B196, B205 (Short Versions)

B96-MPG



Maximum Performance Glass Full-Flow Lube Spin-on

Notes: Can be used with OB1368, OB1369 bases.
Contains: Integral Post Seal
Fits: Cummins Engines
Replaces: Cummins 3313287
Thread: 1 1/2 -12
O.D.: 4 11/16 (119.1)
Height: 11 9/32 (286.5)
I.Gskt: [1] Included
Related To: B196, B205 (Short Versions)

B96-SS



Severe Service Lube Spin-on

Notes: Can be used with OB1368, OB1369 bases.
Contains: Integral Post Seal
Fits: Cummins Engines
Replaces: Cummins 3313287
Thread: 1 1/2 -12
O.D.: 4 11/16 (119.1)
Height: 11 9/32 (286.5)
I.Gskt: [1] Included
Related To: B196, B205 (Short Versions)

B97



Full-Flow Lube Spin-on

Fits: Hough, International Equipment
Replaces: International 684206-C1
Thread: 1 1/2 -16
O.D.: 4 21/32 (118.3)
Height: 9 29/32 (251.6)
I.Gskt: G498-A

Measurements Are Shown In Inches And (Millimeters)

WARNING: These products can expose you to chemicals, including Diisononyl Phthalate, Carbon black extracts, Nickel, 1,3 Butadiene, Ethylene Oxide, Epichlorohydrin, which are known to the State of California to cause cancer, and Bisphenol, Ethylene Glycol, Ethylene Oxide, 1,3 Butadiene, Epichlorohydrin, which are known to the State of California to cause birth defects or other reproductive harm. For more information go to www.P65Warnings.ca.gov.

PT98-10



Hydraulic Element

Notes: Use ES4008 for stacked elements.
Contains: Reinforced Centertube
Fits: Caterpillar Equipment
Replaces: Caterpillar 7J670, 7J0670
O.D.: 6 25/32 (172.2)
I.D.: 3 15/16 (100.0)
Height: 9 (228.6)
O. Gskt: G412, G438, ES4008

PT98-MPG



Maximum Performance Glass Hydraulic Element

Notes: Use ES4008 for stacked elements.
Contains: Reinforced Centertube
Fits: Caterpillar Equipment
Replaces: Caterpillar 7J670, 7J0670
O.D.: 6 25/32 (172.2)
I.D.: 3 15/16 (100.0)
Height: 9 (228.6)
O. Gskt: G412, G438, ES4008

B99



Full-Flow Lube Spin-on

Fits: Atlas Copco, Demag, Caterpillar Equipment
Replaces: Caterpillar 1R0716
Thread: 1 1/2 -16
O.D.: 5 3/8 (136.5)
Height: 12 3/32 (307.2)
I.Gskt: [1] Included
Related To: B49 (Short Version)
 B7249-MPG (High Efficiency Version)
 B7299 (High Efficiency Version)

B99-MPG



Maximum Performance Glass Full-Flow Lube Spin-on

Fits: Atlas Copco, Demag, Caterpillar Equipment
Replaces: Caterpillar 1R0716
Thread: 1 1/2 -16
O.D.: 5 3/8 (136.5)
Height: 12 3/32 (307.2)
I.Gskt: [1] Included
Related To: B49 (Short Version)
 B7249-MPG (High Efficiency Version)
 B7299 (High Efficiency Version)

B99-SS



Severe Service Lube Spin-on

Fits: Atlas Copco, Demag, Caterpillar Equipment
Replaces: Caterpillar 1R0716
Thread: 1 1/2 -16
O.D.: 5 3/8 (136.5)
Height: 12 3/32 (307.2)
I.Gskt: [1] Included
Related To: B49 (Short Version)
 B7249-MPG (High Efficiency Version)
 B7299 (High Efficiency Version)

101



DAHL Fuel Element

Notes: 4 Micron Nominal (20 Absolute)
Fits: DAHL 100 Series Fuel Filter/Water Separator Units
O.D.: 4 7/32 (107.2)
I.D.: 5/8 (15.9) & 1 11/16 (42.9)
Height: 2 5/16 (58.7)
A. Gskt: [1] Included
F. Gskt: [1] Included
Grommets: [1] Attached

101-30



DAHL Fuel Element

Notes: 9 Micron Nominal (40 Absolute)
Fits: DAHL 100 Series Fuel Filter/Water Separator Units
O.D.: 4 7/32 (107.2)
I.D.: 5/8 (15.9) & 1 11/16 (42.9)
Height: 2 5/16 (58.7)
A. Gskt: [1] Attached
F. Gskt: [1] Included
Grommets: [1] Attached

101-W



DAHL Fuel Element

Notes: 5 Micron Nominal (25 Absolute)
Fits: DAHL 100 Series Fuel Filter/Water Separator Units
O.D.: 4 7/32 (107.2)
I.D.: 5/8 (15.9) & 1 11/16 (42.9)
Height: 2 5/16 (58.7)
A. Gskt: [1] Included
F. Gskt: [1] Included
Grommets: [1] Attached

P102



2-Section Full-Flow/By-Pass Lube Element with Bail Handle

Contains: Grommet Seal Between Sections
Fits: Mercedes-Benz Buses, Trucks
Replaces: Mercedes-Benz 6171840025, 6171840125
O.D.: 3 15/32 (88.1)
I.D.: 7/16 (11.1) & 31/32 (24.6)
Height: 7 5/8 (193.7)
F. Gskt: [1] Included
Grommets: [3] Attached

BD103



Dual-Flow Lube Spin-on

Fits: Cummins Engines
Replaces: Cummins 3318853; Fleetguard LF3000
Thread: 2 1/4 -12
O.D.: 4 21/32 (118.3)
Height: 11 13/32 (289.7)
I.Gskt: G293-B
Related To: BD103-MPG (Maximum Performance Glass Version)
 BD103-SS (Severe Service Version)
 BD324 (Short Version)
 BD7309 (High Velocity Version)

BD103-MPG



Maximum Performance Glass Dual-Flow Lube Spin-on

Fits: Cummins Engines
Replaces: Cummins 3318853; Fleetguard LF3000
Thread: 2 1/4 -12
O.D.: 4 21/32 (118.3)
Height: 11 13/32 (289.7)
I.Gskt: G293-B
Related To: BD103 (Standard Version)
 BD103-SS (Severe Service Version)
 BD324 (Short Version)
 BD7309 (High Velocity Version)

Measurements Are Shown In Inches And (Millimeters)

WARNING: These products can expose you to chemicals, including Diisononyl Phthalate, Carbon black extracts, Nickel, 1,3 Butadiene, Ethylene Oxide, Epichlorohydrin, which are known to the State of California to cause cancer, and Bisphenol, Ethylene Glycol, Ethylene Oxide, 1,3 Butadiene, Epichlorohydrin, which are known to the State of California to cause birth defects or other reproductive harm. For more information go to www.P65Warnings.ca.gov.

BD103-SS



Severe Service Dual-Flow Lube Spin-on
Fits: Cummins Engines
Replaces: Cummins 3318853; Fleetguard LF3000
Thread: 2 1/4 -12
O.D.: 4 21/32 (118.3)
Height: 11 13/32 (289.7)
I.Gskt: G293-B
Related To: BD103 (Standard Version)
 BD103-MPG (Maximum Performance Glass Version)
 BD324 (Short Version)
 BD7309 (High Velocity Version)

P104



Full-Flow Lube Element
Fits: Rolls-Royce Engines
Replaces: Rolls-Royce OE12448
O.D.: 3 15/16 (100.0)
I.D.: 19/32 (15.1) & 1 15/32 (37.3)
Height: 5 23/32 (145.3)
F. Gskt: [1] Included
End Seals: [1] Attached

B105



Full-Flow Lube Spin-on
Notes: Can be used with OB1303 base.
Fits: Detroit Diesel Engines
Replaces: GMC 25014120
Thread: 1 1/2 -12
O.D.: 4 21/32 (118.3)
Height: 6 9/32 (159.5)
I.Gskt: [1] Included
Related To: B95 (Long Version)

P106



Full-Flow Lube Element
Notes: Outside-In Flow Direction
Fits: Iveco Engines
Replaces: Mercedes-Benz 11507425104
O.D.: 2 5/16 (58.7)
I.D.: 11/16 (17.5)
Height: 3 31/32 (100.8)
F. Gskt: [1] Included
O. Gskt: G232

P106-HD



Power Steering Element
Notes: Inside-Out Flow Direction
Fits: DAF, Iveco, M.A.N., Mercedes-Benz, R.V.I. Trucks
Replaces: Mercedes-Benz 11507425104
O.D.: 2 5/16 (58.7)
I.D.: 11/16 (17.5)
Height: 3 31/32 (100.8)
F. Gskt: [1] Included
O. Gskt: G232

PT108



Full-Flow Lube Element
Fits: Allis Chalmers, Caterpillar, Ford, Hyster, Massey Ferguson, Perkins, Timberjack Engines, Equipment
Replaces: Hyster 156952; Massey Ferguson 1851766-M1; Perkins 26540132
O.D.: 2 29/32 (73.8)
I.D.: 27/32 (21.4)
Height: 4 1/2 (114.3)
F. Gskt: G147-A

PT108-HD



Heavy-Duty Lube or Hydraulic Element
Fits: Massey Ferguson Equipment
Replaces: Hyster 156952; Massey Ferguson 1851766-M1; Perkins 26540132
O.D.: 2 29/32 (73.8)
I.D.: 27/32 (21.4)
Height: 4 1/2 (114.3)
F. Gskt: G147-A

B109



Full-Flow Lube Spin-on
Contains: Anti-Drainback Valve
 20 PSID By-Pass Valve
Fits: Caterpillar, Kobelco, Mustang Equipment; GMC, Isuzu Automotive
Replaces: GMC 94428931
Thread: M20 x 1.5
O.D.: 3 3/4 (95.3)
Height: 5 5/16 (134.9)
I.Gskt: [1] Included

BC110



Centrifugal By-Pass Lube Element
Fits: Mack Engines
Replaces: Mack 57GC286, 236GB244
O.D.: 3 27/32 (97.6)
I.D.: 9/16 (14.3) & 5/8 (15.9)
Height: 4 1/2 (114.3)
F. Gskt: G118
End Seals: ES3012 Included

BT111



Lube Spin-on
Contains: 20 PSID By-Pass Valve
Fits: Ford Tractors; New Holland Equipment
Replaces: Bosch 451-203-059; New Holland 86546614
Thread: 3/4 -16
O.D.: 3 11/16 (93.7)
Height: 5 3/8 (136.5)
I.Gskt: G381-A

BT112



Turbocharger Lube Spin-on
Contains: 8 PSID By-Pass Valve
Fits: Cummins Engines; Euclid Equipment
Replaces: Cummins 152499
Thread: 13/16 -16
O.D.: 3 11/16 (93.7)
Height: 5 3/8 (136.5)
I.Gskt: G381-A
Related To: B9 (Lube Version)

B113



Full-Flow Lube Spin-on
Contains: Anti-Drainback Valve
Fits: Ford Vans; Nissan, Subaru, Volkswagen Automotive, Light-Duty Trucks; Kubota Lift Trucks
Replaces: Nissan 15208-H8916; Subaru 15208-AA001
Thread: 3/4 -16
O.D.: 3 1/32 (77.0)
Height: 4 1/16 (103.2)
I.Gskt: [1] Included

Measurements Are Shown In Inches And (Millimeters)

WARNING: These products can expose you to chemicals, including Diisononyl Phthalate, Carbon black extracts, Nickel, 1,3 Butadiene, Ethylene Oxide, Epichlorohydrin, which are known to the State of California to cause cancer, and Bisphenol, Ethylene Glycol, Ethylene Oxide, 1,3 Butadiene, Epichlorohydrin, which are known to the State of California to cause birth defects or other reproductive harm. For more information go to www.P65Warnings.ca.gov.

B114

Full-Flow Lube Spin-on



Contains: Anti-Drainback Valve
30 PSID By-Pass Valve
Fits: Audi, Volkswagen, Volvo Automotive,
Light-Duty Trucks; R.V.I. Trucks
Replaces: Volkswagen 68115561;
Volvo 13281611
Thread: 3/4 -16
O.D.: 3 3/4 (95.3)
Height: 5 9/32 (134.1)
I.Gskt: G381-A

B118

Full-Flow Lube Spin-on



Contains: Anti-Drainback Valve
Fits: Ford, Isuzu, Nissan Engines
Replaces: Isuzu 8-94414-778
Thread: 3/4 -16
O.D.: 3 11/16 (93.7)
Height: 5 3/8 (136.5)
I.Gskt: G381-A

PT115

Full-Flow Lube Element



Fits: Allis Chalmers Equipment
Replaces: Allis Chalmers 4349986
O.D.: 4 7/16 (112.7)
I.D.: 1 17/32 (38.9)
Height: 7 7/8 (200.0)
F. Gskt: [1] Included
End Seals: [2] Attached

PT119

Hydraulic Sump Element



Notes: Used in Fram FH58PL or FH258PL housings.
Fits: Clark Equipment
Replaces: Clark 943559
O.D.: 6 (152.4)
I.D.: 3 1/2 (88.9)
Height: 14 1/2 (368.3)
A. Gskt: [2] Attached
O. Gskt: G210

P116

By-Pass Lube Element with Bail Handle



Notes: Used in Fram F43P housing.
Fits: Cummins, Deutz Engines
Replaces: Cummins 151858; Deutz P4H4120
O.D.: 5 27/32 (148.4)
I.D.: 31/32 (24.6)
Height: 9 13/16 (249.2)
F. Gskt: G102-A
Grommets: [2] Attached

PT119-5

Special Fluid Element



Notes: Used in Bowser-Briggs 845, 852 housings.
Fits: Clark Equipment
Replaces: Clark 943559
O.D.: 6 (152.4)
I.D.: 3 1/2 (88.9)
Height: 14 1/2 (368.3)
A. Gskt: [2] Attached
O. Gskt: G210

PF116

Fuel Element with Bail Handle



Notes: Used in Fram F1143PBM housing.
Optional gasket G356 used in Fleetguard housing.
Fits: Cummins Engines
Replaces: Cummins 139097
O.D.: 5 27/32 (148.4)
I.D.: 31/32 (24.6)
Height: 9 13/16 (249.2)
F. Gskt: G102-A, [1] Included
O. Gskt: G356
Grommets: [2] Attached

PT119-HD

Heavy-Duty Hydraulic Sump Element



Fits: Clark Equipment
Replaces: Clark 943559
O.D.: 6 (152.4)
I.D.: 3 1/2 (88.9)
Height: 14 1/2 (368.3)
A. Gskt: [2] Included
O. Gskt: G210

PT117

By-Pass Lube Element with Bail Handle



Fits: Equipment with Fram F54 Series Housings
Replaces: Fram C54
O.D.: 6 (152.4)
I.D.: 1 1/8 (28.6)
Height: 14 1/2 (368.3)
O. Gskt: G102-A
End Seals: [2] Attached

PT119-HD5

Heavy-Duty Hydraulic Sump Element



Fits: Clark Equipment
Replaces: Clark 943559
O.D.: 6 (152.4)
I.D.: 3 1/2 (88.9)
Height: 14 1/2 (368.3)
A. Gskt: [2] Attached
O. Gskt: G210

PT117-25

Full-Flow Lube Element with Bail Handle



Fits: Equipment with Fram F54 Series Housings
Replaces: Fram C54
O.D.: 6 (152.4)
I.D.: 1 1/8 (28.6)
Height: 14 1/2 (368.3)
O. Gskt: G102-A
End Seals: [2] Attached

B120

Full-Flow Lube Spin-on



Contains: Anti-Drainback Valve
Fits: Nissan Automotive, Engines
Replaces: Nissan 15208-W1116
Thread: 3/4 -16
O.D.: 3 11/16 (93.7)
Height: 3 7/8 (98.4)
I.Gskt: G381-A

Measurements Are Shown In Inches And (Millimeters)



WARNING: These products can expose you to chemicals, including Diisononyl Phthalate, Carbon black extracts, Nickel, 1,3 Butadiene, Ethylene Oxide, Epichlorohydrin, which are known to the State of California to cause cancer, and Bisphenol, Ethylene Glycol, Ethylene Oxide, 1,3 Butadiene, Epichlorohydrin, which are known to the State of California to cause birth defects or other reproductive harm. For more information go to www.P65Warnings.ca.gov.

PF121



Fuel Element

Replaces: John Deere TY5029, TY15218
O.D.: 3 9/32 (83.3)
I.D.: 1 1/4 (31.8) One End
Height: 5 1/8 (130.2)
O. Gskt: G229
End Seals: [1] Attached

B128



By-Pass Lube Spin-on

Fits: Thermo King Refrigeration Units
Replaces: Thermo King 11-3746
Thread: 3/4 -20
O.D.: 4 1/4 (108.0)
Height: 7 3/8 (187.3)
I.Gskt: G401

PT122-5



Hydraulic Element

Fits: Peco Housings
Replaces: Peco PP618-5
O.D.: 6 (152.4)
I.D.: 3 1/2 (88.9)
Height: 18 (457.2)
A. Gskt: [2] Attached

B129



Full-Flow Lube Spin-on

Fits: Thermo King Refrigeration Units
Replaces: Thermo King 11-3871
Thread: 1 -12
O.D.: 4 1/4 (108.0)
Height: 7 3/8 (187.3)
I.Gskt: G401

BT124



Full-Flow Lube Spin-on

Contains: Anti-Drainback Valve
 20 PSID By-Pass Valve
Fits: Oliver, White Equipment
Replaces: White 40-0000406
Thread: 7/8 -16
O.D.: 4 1/4 (108.0)
Height: 7 11/32 (186.5)
I.Gskt: G381-A

B131



Full-Flow Lube Spin-on

Contains: Anti-Drainback Valve
 8 PSID By-Pass Valve
Fits: Chevrolet, Toyota Automotive; Datsun,
 Nissan Lift Trucks; John Deere Lawn & Garden
 Equipment; Northern Lights Equipment
Replaces: Nissan 31725-L1000; Toyota
 11501-01270
Thread: 3/4 -16
O.D.: 3 1/32 (77.0)
Height: 3 7/16 (87.3)
I.Gskt: [1] Included

P125



Full-Flow Lube Element with 2 Bail Handles

Fits: Mercedes-Benz Automotive
Replaces: Mercedes-Benz 11849925
O.D.: 3 1/4 (82.6)
I.D.: 7/16 (11.1) & 1 13/32 (35.7)
Height: 4 3/4 (120.7)
F. Gskt: [3] Metal Washers
O-Ring: [1] Included
Grommets: [2] Attached

B132



Full-Flow Lube Spin-on

Contains: Anti-Drainback Valve
 8 PSID By-Pass Valve
Fits: AMC, Chrysler, Renault Automotive;
 Volvo Engines
Replaces: Chrysler 4419970, 4419970-0;
 Renault 7701348028
Thread: 3/4 -16
O.D.: 3 11/16 (93.7)
Height: 3 1/4 (82.6)
I.Gskt: G381-A

BT126



Full-Flow Lube Spin-on

Contains: Anti-Drainback Valve
 8 PSID By-Pass Valve
Fits: Minneapolis-Moline, Oliver, White
 Equipment
Replaces: Oliver 169019-A
Thread: 7/8 -14
O.D.: 3 11/16 (93.7)
Height: 7 1/8 (181.0)
I.Gskt: G381-A
Related To: BT264 (Short Version)

C133-OW



Wound Cotton Full-Flow Lube Orlon Sock

Notes: For use with high heat applications.
Fits: Waukesha Engines
Replaces: Waukesha 168660, 168660B
O.D.: 4 3/8 (111.1)
I.D.: 1 1/16 (27.0) & 1 5/8 (41.3)
Height: 31 (787.4)
End Seals: [1] Attached
Related To: V1656-O, V1656-T (Single-Length
 Versions)

P127



Full-Flow Lube Element

Replaces: Leyland 801779
O.D.: 3 31/32 (100.8)
I.D.: 1 5/8 (41.3)
Height: 5 1/32 (127.8)
End Seals: [2] Attached

C133-W



Wound Cotton Full-Flow Lube Cotton Sock

Fits: Waukesha Engines
Replaces: Waukesha 168660, 168660B
O.D.: 4 3/8 (111.1)
I.D.: 1 1/16 (27.0) & 1 5/8 (41.3)
Height: 31 (787.4)
End Seals: [1] Attached
Related To: V1656-O, V1656-T (Single-Length
 Versions)

Measurements Are Shown In Inches And (Millimeters)

WARNING: These products can expose you to chemicals, including Diisononyl Phthalate, Carbon black extracts, Nickel, 1,3 Butadiene, Ethylene Oxide, Epichlorohydrin, which are known to the State of California to cause cancer, and Bisphenol, Ethylene Glycol, Ethylene Oxide, 1,3 Butadiene, Epichlorohydrin, which are known to the State of California to cause birth defects or other reproductive harm. For more information go to www.P65Warnings.ca.gov.

B134 Full-Flow Lube Spin-on
Fits: Ford Automotive, Light-Duty Trucks, Vans; Ford, International Equipment
Replaces: Ford E3TZ-6731-A; International 1804442-C1
Thread: 1 1/2 -16
O.D.: 4 1/4 (108.0)
Height: 5 7/8 (149.2)
I.Gskt: [1] Included



P140 Full-Flow Lube Element
Fits: GM Automotive
Replaces: GMC 25012305
O.D.: 2 29/32 (73.8)
I.D.: 11/16 (17.5) One End
Height: 2 3/4 (69.9)
O-Ring: [1] Attached
Grommets: [1] Attached



PT135 By-Pass Lube Element
Fits: Eaton, International, Universal Equipment
Replaces: International 251404-R91
O.D.: 2 9/16 (65.1)
I.D.: 7/16 (11.1) & 17/32 (13.5)
Height: 4 5/8 (117.5)
O. Gskt: G379



B141 Full-Flow Lube Spin-on
Contains: Anti-Drainback Valve
 20 PSID By-Pass Valve
Fits: Buick, Chevrolet, Chrysler, Eagle, Jeep, Peugeot Automotive
Replaces: GMC 6439354
Thread: M20 x 1.5
O.D.: 3 11/16 (93.7)
Height: 3 7/8 (98.4)
I.Gskt: G381-A



PT137 Full-Flow Lube Element
Fits: Allis Chalmers, Oliver Equipment
Replaces: Hercules 380221
O.D.: 4 7/16 (112.7)
I.D.: 1 1/2 (38.1)
Height: 7 (177.8)
F. Gskt: [1] Included
End Seals: [2] Attached



BD142 Dual-Flow Lube Spin-on
Contains: Anti-Drainback Valve
 Integral Post Seal
 Standpipe
Fits: GMC, Isuzu, Nissan Automotive
Replaces: Isuzu 8-94143-205-0
Thread: 1 -12
O.D.: 4 7/32 (107.2)
Height: 5 1/8 (130.2)
I.Gskt: [1] Included



PT138-10 Hydraulic Element
Fits: Case Equipment
Replaces: Case D45378, G33058 Element in A61235 Kit
O.D.: 3 15/16 (100.0)
I.D.: 1 1/16 (27.0)
Height: 6 1/16 (154.0)
F. Gskt: G376, [1] Included
End Seals: [2] Attached



B143 Full-Flow Lube Spin-on
Contains: Anti-Drainback Valve
Fits: Toyota Automotive, Lift Trucks
Replaces: Toyota 15601-33020
Thread: 3/4 -16
O.D.: 3 (76.2)
Height: 5 3/32 (129.4)
I.Gskt: [1] Included
Related To: B295 (Long Version)



PT138-25 Hydraulic, Power Steering or Brake Element
Fits: Case Equipment
Replaces: Case A60524, A61234
O.D.: 3 15/16 (100.0)
I.D.: 1 1/16 (27.0)
Height: 6 1/16 (154.0)
F. Gskt: G376, [1] Included
End Seals: [2] Attached



P144 Full-Flow Lube Element
Replaces: Citroen N223/1; Purflux L108
O.D.: 3 3/16 (81.0)
I.D.: 1 1/16 (27.0)
Height: 2 9/16 (65.1)
End Seals: [2] Attached



PT139-10 Pressure-Type Hydraulic Element with Exposed Pleats
Fits: Caterpillar Lift Trucks; Marvel TB578366 Housing
Replaces: Marvel 578366-5110
O.D.: 4 1/2 (114.3)
I.D.: 2 1/4 (57.2) One End
Height: 9 3/4 (247.7)
A. Gskt: [1] Attached



BT146 Full-Flow Lube Element
Contains: Reinforced Centertube
Fits: Komatsu Equipment
Replaces: Komatsu 6610-50-5100, 6610-51-4400
O.D.: 5 (127.0)
I.D.: 2 3/16 (55.6)
Height: 9 5/16 (236.5)
O. Gskt: G164-A
End Seals: [2] Attached



Measurements Are Shown In Inches And (Millimeters)

 **WARNING:** These products can expose you to chemicals, including Diisononyl Phthalate, Carbon black extracts, Nickel, 1,3 Butadiene, Ethylene Oxide, Epichlorohydrin, which are known to the State of California to cause cancer, and Bisphenol, Ethylene Glycol, Ethylene Oxide, 1,3 Butadiene, Epichlorohydrin, which are known to the State of California to cause birth defects or other reproductive harm. For more information go to www.P65Warnings.ca.gov.

P148 Full-Flow Lube Element
Fits: Honda, Kawasaki, Yamaha Motorcycles
Replaces: Honda 15412-300-024
O.D.: 3 1/32 (77.0)
I.D.: 7/8 (22.2)
Height: 2 1/4 (57.2)
F. Gskt: [2] Included
Grommets: [2] Attached



PT152 Full-Flow Lube Element
Fits: Minneapolis-Moline, Oliver Tractors
Replaces: Minneapolis-Moline 10A10423, 10R1323
O.D.: 4 17/32 (115.1)
I.D.: 7/8 (22.2)
Height: 6 1/4 (158.8)
O. Gskt: G380



P150 Full-Flow Lube Element with Bail Handle
Fits: Isuzu Engines; Komatsu, TCM Lift Trucks
Replaces: Isuzu 13240-045; Komatsu 13240045
O.D.: 2 7/8 (73.0)
I.D.: 9/16 (14.3)
Height: 6 5/8 (168.3)
Grommets: [2] Attached



PT153 Full-Flow Lube Element
Fits: International Light-Duty Trucks; Nissan Lift Trucks
Replaces: Nissan 15208-61525
O.D.: 3 15/16 (100.0)
I.D.: 19/32 (15.1) & 1 5/8 (41.3)
Height: 6 3/8 (161.9)
F. Gskt: [2] Included
End Seals: [1] Attached



151 DAHL Fuel Element
Notes: 4 Micron Nominal (20 Absolute)
Fits: DAHL 150 Series Fuel Filter/Water Separator Unit
O.D.: 4 7/32 (107.2)
I.D.: 27/32 (21.4) & 1 11/16 (42.9)
Height: 4 9/32 (108.7)
A. Gskt: [1] Included
O-Ring: [1] Included
Grommets: [1] Attached



PT154 Full-Flow Lube Element
Contains: Reinforced Centertube
Fits: Case, Grove, International Engines
Replaces: Case A20822; International 193187-R91
O.D.: 4 17/32 (115.1)
I.D.: 1/2 (12.7) & 1 25/32 (45.2)
Height: 7 1/16 (179.4)
F. Gskt: G184-A
O. Gskt: G115-MSB, G280
End Seals: [1] Attached
Grommets: [1] Attached



151-30 DAHL Fuel Element
Notes: 9 Micron Nominal (40 Absolute)
Fits: DAHL 150 Series Fuel Filter/Water Separator Unit
O.D.: 4 7/32 (107.2)
I.D.: 27/32 (21.4) & 1 11/16 (42.9)
Height: 4 9/32 (108.7)
F. Gskt: 150-15
O-Ring: [1] Included
Grommets: [1] Attached



PF155 Fuel Element
Notes: Used in Luber-finer F155C, F170 housings.
Fits: Cummins Engines
Replaces: Cummins 130909
O.D.: 4 1/2 (114.3)
I.D.: 7/8 (22.2)
Height: 8 3/16 (208.0)
O. Gskt: G169, G363, ES1066, ES1074
End Seals: [2] Attached



151-W DAHL Fuel Element
Notes: 5 Micron Nominal (25 Absolute)
Fits: DAHL 150 Series Fuel Filter/Water Separator Unit
O.D.: 4 7/32 (107.2)
I.D.: 27/32 (21.4) & 1 11/16 (42.9)
Height: 4 9/32 (108.7)
A. Gskt: [1] Included
O-Ring: [1] Included
Grommets: [1] Attached



B156 Full-Flow Lube Spin-on
Contains: Anti-Drainback Valve
20 PSID By-Pass Valve
Fits: Honda Automotive
Replaces: Honda 15400-689-004
Thread: M22 x 1.5
O.D.: 3 11/16 (93.7)
Height: 3 1/4 (82.6)
I.Gskt: G324-A



PT151 Full-Flow Lube Element with Bail Handle
Fits: Minneapolis-Moline Tractors
Replaces: LeTourneau 10P732, 10R1322
O.D.: 3 23/32 (94.5)
I.D.: 9/16 (14.3)
Height: 4 13/32 (111.9)
F. Gskt: G123
Grommets: [2] Attached



B157 Full-Flow Lube Spin-on
Notes: 1 1/2 Quart Capacity
Contains: 20 PSID By-Pass Valve
Fits: Ford Engines, Trucks
Replaces: Ford E7HZ-6731-A
Thread: 1 -12
O.D.: 4 1/4 (108.0)
Height: 7 3/8 (187.3)
I.Gskt: G401



Measurements Are Shown In Inches And (Millimeters)

WARNING: These products can expose you to chemicals, including Diisononyl Phthalate, Carbon black extracts, Nickel, 1,3 Butadiene, Ethylene Oxide, Epichlorohydrin, which are known to the State of California to cause cancer, and Bisphenol, Ethylene Glycol, Ethylene Oxide, 1,3 Butadiene, Epichlorohydrin, which are known to the State of California to cause birth defects or other reproductive harm. For more information go to www.P65Warnings.ca.gov.

B159 Full-Flow Lube Spin-on
Contains: Anti-Drainback Valve
 8 PSID By-Pass Valve
Fits: GMC Imports, Suzuki Automotive
Replaces: GMC 96058042; Suzuki 16510-83011
Thread: 3/4 -16
O.D.: 3 (76.2)
Height: 4 1/16 (103.2)
I.Gskt: [1] Included



B166 Full-Flow Lube Spin-on
Contains: Anti-Drainback Valve
 20 PSID By-Pass Valve
Fits: Honda Automotive; Ford Tractors
Replaces: Honda 15400-634-003
Thread: M20 x 1.5
O.D.: 3 25/32 (96.0)
Height: 3 1/4 (82.6)
I.Gskt: [1] Included



B160 Full-Flow Lube Spin-on
Contains: Anti-Drainback Valve
 20 PSID By-Pass Valve
Fits: Cadillac, GMC Light-Duty Trucks;
 VM Engines
Replaces: GMC 89017524; VM Engines
 4115031
Thread: M22 x 1.5
O.D.: 3 (76.2)
Height: 3 1/2 (88.9)
I.Gskt: G449-B



B167 Full-Flow Lube Spin-on
Notes: 1 1/2 Quart Capacity
Contains: Anti-Drainback Valve
 8 PSID By-Pass Valve
Fits: Dresser, Hough, International Engines,
 Equipment
Replaces: International 427207-C3,
 528250-R91, 3059246-R91, 3059247-R91
Thread: 1 -12
O.D.: 3 11/16 (93.7)
Height: 7 1/8 (181.0)
I.Gskt: G381-A



B161-S Full-Flow Lube Spin-on
Contains: Anti-Drainback Valve
 20 PSID By-Pass Valve
Fits: Acura, Ford, Honda, Mazda Automotive;
 Kubota Engines
Replaces: Ford D87Z-6731-A; Mazda
 8173-23-802
Thread: M20 x 1.5
O.D.: 3 1/32 (77.0)
Height: 4 1/16 (103.2)
I.Gskt: [1] Included



B168 Full-Flow Lube Spin-on
Contains: Anti-Drainback Valve
 8 PSID By-Pass Valve
Fits: Takeuchi Equipment; Yanmar Engines
Replaces: John Deere CH10467; Thermo King
 11-4928; Yanmar 124550-35110
Thread: M20 x 1.5
O.D.: 3 (76.2)
Height: 5 3/32 (129.4)
I.Gskt: [1] Included



P162 Full-Flow Lube Element
Fits: Lamborghini, Maserati Automotive
Replaces: Lamborghini 11880; Maserati
 421242874
O.D.: 2 5/8 (66.7)
I.D.: 1 7/32 (31.0)
Height: 8 11/16 (220.7)
End Seals: [2] Attached



P170 Full-Flow Lube Element
Fits: Komatsu Lift Trucks; Nissan Engines
Replaces: Nissan 15208-32225, 15208-43800
O.D.: 2 13/16 (71.4)
I.D.: 1 5/16 (33.3)
Height: 5 13/32 (137.3)
End Seals: [2] Attached



B163 Full-Flow Lube or Transmission Spin-on
Contains: Anti-Drainback Valve
 8 PSID By-Pass Valve
Fits: Allis Chalmers, Atlas Copco, Bolens,
 Case, Ford, International, John Deere, Oliver,
 Onan, White Equipment; Ford, Volvo
 Automotive
Replaces: Ford E8NN-6714-CA; Mack
 6432PER17; Onan 122-0185; White 156513A
Thread: 3/4 -16
O.D.: 3 11/16 (93.7)
Height: 3 7/8 (98.4)
I.Gskt: G381-A



P171 Full-Flow Lube Element
Fits: J.C. Bamford Equipment; Leyland
 Engines
Replaces: Chrysler 2067263; Nissan
 15208-31300
O.D.: 2 7/8 (73.0)
I.D.: 1 5/16 (33.3)
Height: 4 1/4 (108.0)
F. Gskt: G147-A, G161
O. Gskt: G183
Related To: P172 (with End Seals)



B164 By-Pass Lube Spin-on
Notes: Can be used with OB1305 base.
Contains: Flow Control Orifice
Fits: Carrier Refrigeration Units
Replaces: Carrier-Transicold 30-00304-00
Thread: 5/8 -18
O.D.: 3 11/16 (93.7)
Height: 6 5/8 (168.3)
I.Gskt: G381-A
Related To: B50, BT341 (Short Versions)



P172 Full-Flow Lube Element
Fits: Leyland Engines, Equipment
Replaces: Leyland 162429
O.D.: 2 29/32 (73.8)
I.D.: 1 5/16 (33.3)
Height: 4 7/16 (112.7)
F. Gskt: G147-A, G165, [1] Included
End Seals: [2] Attached
Related To: P171 (without End Seals)



Measurements Are Shown In Inches And (Millimeters)

! **WARNING:** These products can expose you to chemicals, including Diisononyl Phthalate, Carbon black extracts, Nickel, 1,3 Butadiene, Ethylene Oxide, Epichlorohydrin, which are known to the State of California to cause cancer, and Bisphenol, Ethylene Glycol, Ethylene Oxide, 1,3 Butadiene, Epichlorohydrin, which are known to the State of California to cause birth defects or other reproductive harm. For more information go to www.P65Warnings.ca.gov.

B173-S Full-Flow Lube Spin-on
Contains: Anti-Drainback Valve
 20 PSID By-Pass Valve
Fits: AMC, Chrysler, Eagle, Hyundai, Isuzu,
 Mitsubishi Automotive, Light-Duty Trucks
Replaces: Chrysler 4186267
Thread: M20 x 1.5
O.D.: 3 11/16 (93.7)
Height: 3 1/4 (82.6)
A. Gskt: G381-A



P174 Full-Flow Lube Element
Fits: International, Leyland, Lister, Petter
 Engines
Replaces: International 3043283-R91; Leyland
 ABU8912; Lister 419-3265; Nissan 15208-32200
O.D.: 2 7/8 (73.0)
I.D.: 1 5/16 (33.3)
Height: 5 9/16 (141.3)
F. Gskt: G147-A, G165, [2] Included
O. Gskt: G161, G239
End Seals: [2] Attached



P176 Full-Flow Lube Element
Fits: Lister Engines
Replaces: Lister 419-3038, 201-26020
O.D.: 2 7/8 (73.0)
I.D.: 1 5/16 (33.3)
Height: 3 15/32 (88.1)
F. Gskt: G239
O. Gskt: G402
Related To: PF820-S (Fuel Version)



P177 Full-Flow Lube Element
Fits: Coventry Climax Engines, Lift Trucks;
 Perkins Engines
Replaces: Perkins 26540055
O.D.: 2 7/8 (73.0)
I.D.: 1 5/16 (33.3)
Height: 6 (152.4)
F. Gskt: G161, [2] Included
O. Gskt: G147-A
End Seals: [2] Attached



B178 Full-Flow Lube Spin-on
Contains: Anti-Drainback Valve
 30 PSID By-Pass Valve
Fits: Audi, BMW, Dodge, Porsche, Volkswagen
 Automotive; Bobcat, Deutz, Ingersoll-Rand,
 Vermeer Equipment
Replaces: Chrysler J3232126; Volkswagen
 56115561G
Thread: 3/4 -16
O.D.: 2 15/16 (74.6)
Height: 4 27/32 (123.0)
I.Gskt: G449-B
Related To: B228 (Short Version)



B179 Full-Flow Lube Spin-on
Contains: Anti-Drainback Valve
 8 PSID By-Pass Valve
Fits: Honda Automotive; Kubota, Yanmar
 Engines
Replaces: Kubota 70000-15241; Transcold
 2535206; Yanmar 124450-35100
Thread: M20 x 1.5
O.D.: 3 (76.2)
Height: 2 27/32 (72.2)
I.Gskt: [1] Included



PT181 KIT 3-Part Hydraulic Kit
Contains: Reinforced Centertube
 [2] Elements
 [1] S423 Resin Ribbon Spacer Element
 [2] Gaskets
Fits: Allis Chalmers Crawler Tractors,
 Excavators, Loaders
Replaces: Allis Chalmers 3019695, 3033507
Larger Element
O.D.: 3 5/16 (84.1)
I.D.: 1 1/8 (28.6)
Height: 8 7/8 (225.4)
F. Gskt: [2] Included
Smaller Element
O.D. 3 5/16 (84.1)
I.D. 1 5/32 (29.4)
Height 4 13/32 (111.9)



P183 Power Steering or Hydraulic Element
Fits: Case, Caterpillar, Ford, International,
 Massey Ferguson Equipment; Chrysler, Ford
 Automotive
Replaces: Case A22279; International
 133205-R91
O.D.: 3 3/16 (81.0)
I.D.: 1 1/16 (27.0)
Height: 1 9/16 (39.7)
End Seals: [2] Attached



P184 Full-Flow Lube Element
Fits: Ford, Iveco Engines, Trucks
Replaces: Ford B8C-6731-A
O.D.: 3 5/16 (84.1)
I.D.: 15/16 (23.8)
Height: 4 27/32 (123.0)
F. Gskt: G132, G268, [2] Included



PT185 Full-Flow Lube Element
Fits: Dresser, Drott, Galion, Gradall, Hough,
 International Equipment; International Engines
Replaces: International 279994-R91
O.D.: 3 15/16 (100.0)
I.D.: 1 19/32 (40.5)
Height: 5 9/16 (141.3)
F. Gskt: G273
End Seals: [2] Attached



P186 Power Steering Element
Fits: Allis Chalmers, Massey Ferguson
 Equipment
Replaces: Allis Chalmers 79170-7;
 International 168743-R91
O.D.: 3 17/32 (89.7)
I.D.: 1 1/8 (28.6)
Height: 2 1/2 (63.5)



P187 Transmission or Air Shift Breather Element
Fits: Dana, Fuller Transmissions; Euclid,
 Massey Ferguson, WABCO Equipment;
 GMC Trucks
Replaces: GMC 2354770
O.D.: 2 7/8 (73.0)
I.D.: 1 1/16 (27.0)
Height: 3 (76.2)
F. Gskt: [1] Included



Measurements Are Shown In Inches And (Millimeters)

WARNING: These products can expose you to chemicals, including Diisononyl Phthalate, Carbon black extracts, Nickel, 1,3 Butadiene, Ethylene Oxide, Epichlorohydrin, which are known to the State of California to cause cancer, and Bisphenol, Ethylene Glycol, Ethylene Oxide, 1,3 Butadiene, Epichlorohydrin, which are known to the State of California to cause birth defects or other reproductive harm. For more information go to www.P65Warnings.ca.gov.

PT189



Hydraulic or Transmission Element
Notes: Use ES4007 for stacked elements.
Contains: Reinforced Centertube
Fits: Caterpillar Equipment
Replaces: Caterpillar 2M3943
O.D.: 3 15/16 (100.0)
I.D.: 2 9/32 (57.9)
Height: 9 3/16 (233.4)
O. Gskt: G229, G310, G315, G333, G342, G376, G403, G433, G445, G447, ES1049, ES1074, ES4007

PT193



Hydraulic or Full-Flow Lube Element
Fits: Euclid, Terex Equipment
Replaces: Euclid 9190077
O.D.: 6 (152.4)
I.D.: 3 17/32 (89.7)
Height: 8 17/32 (216.7)
O. Gskt: G289

PT189-MPG



Maximum Performance Glass Hydraulic or Transmission Element
Notes: Use ES4007 for stacked elements.
Contains: Reinforced Centertube
Fits: Caterpillar Equipment
Replaces: Caterpillar 2M3943
O.D.: 3 15/16 (100.0)
I.D.: 2 9/32 (57.9)
Height: 9 3/16 (233.4)
O. Gskt: G229, G310, G315, G333, G342, G376, G403, G433, G445, G447, ES1049, ES1074, ES4007

PT193 KIT



Hydraulic Element Plus Gaskets
Contains: [1] PT193
 [2] G253-A
 [1] G288
 [1] G289
Fits: Euclid, Terex Equipment
Replaces: Euclid 9190077
O.D.: 6 (152.4)
I.D.: 3 17/32 (89.7)
Height: 8 17/32 (216.7)
F. Gskt: [4] Included

P190



Full-Flow Lube Element
Fits: Case, David Brown Equipment; Ford Buses, Trucks
Replaces: David Brown 902125; Ford 528E-6731-A
O.D.: 3 3/4 (95.3)
I.D.: 1 5/16 (33.3)
Height: 2 7/8 (73.0)
F. Gskt: G168-B
End Seals: [2] Attached

PT193-3



Hydraulic Element
Notes: For Terex Kit 9038953, Add Optional Gaskets [2] G253-A and [1] G289
Fits: Euclid, Terex Equipment
Replaces: Euclid 9190077
O.D.: 6 (152.4)
I.D.: 3 17/32 (89.7)
Height: 8 17/32 (216.7)
O. Gskt: G289

PT191



Hydraulic Sump Element
Fits: Clark, Euclid, Gradall Equipment; Sullair Compressors
Replaces: Clark 141676; Euclid 4008687
O.D.: 6 (152.4)
I.D.: 3 17/32 (89.7)
Height: 8 (203.2)
O. Gskt: G253-A, G314, G359

P194



Full-Flow Lube Element
Fits: Caterpillar, Quincy Equipment; Mack Engines
Replaces: Allis Chalmers 3010360-0; Case A26984; Euclid 9029081
O.D.: 6 1/32 (153.2)
I.D.: 1 23/32 (43.7)
Height: 7 5/8 (193.7)
O. Gskt: G193
End Seals: [2] Attached
Related To: PT394-5, PT394-15 (Different Microns)

PT191-10



Hydraulic Element
Fits: Clark, Euclid, Gradall Equipment; Sullair Compressors
Replaces: Clark 141676; Euclid 4008687
O.D.: 6 (152.4)
I.D.: 3 17/32 (89.7)
Height: 8 (203.2)
O. Gskt: G253-A, G314, G359

P194-HD



Hydraulic Element
Fits: Allis Chalmers, Case, Euclid, Gradall, John Deere, Koehring Equipment
Replaces: Allis Chalmers 3010360-0; Case A26984; Euclid 9029081
O.D.: 6 1/32 (153.2)
I.D.: 1 23/32 (43.7)
Height: 7 5/8 (193.7)
O. Gskt: G193
End Seals: [2] Attached
Related To: PT394-5, PT394-15 (Different Microns)

PT191-5



Hydraulic Element
Fits: Clark, Euclid, Gradall Equipment; Sullair Compressors
Replaces: Clark 141676; Euclid 4008687
O.D.: 6 (152.4)
I.D.: 3 17/32 (89.7)
Height: 8 (203.2)
O. Gskt: G253-A, G314, G359

Measurements Are Shown In Inches And (Millimeters)

 **WARNING:** These products can expose you to chemicals, including Diisononyl Phthalate, Carbon black extracts, Nickel, 1,3 Butadiene, Ethylene Oxide, Epichlorohydrin, which are known to the State of California to cause cancer, and Bisphenol, Ethylene Glycol, Ethylene Oxide, 1,3 Butadiene, Epichlorohydrin, which are known to the State of California to cause birth defects or other reproductive harm. For more information go to www.P65Warnings.ca.gov.

P194-HD10

Hydraulic Element



Fits: CMC, Gardner Denver, Ingersoll-Rand Equipment
Replaces: Caterpillar 6B8217; Ingersoll-Rand 35252154
O.D.: 6 1/32 (153.2)
I.D.: 4 23/32 (43.7)
Height: 7 5/8 (193.7)
O. Gskt: G193
End Seals: [2] Attached
Related To: PT394-5, PT394-15 (Different Microns)

PF194

Fuel Element



Fits: Caterpillar Engines
Replaces: Caterpillar 2H7254
O.D.: 6 1/32 (153.2)
I.D.: 4 23/32 (43.7)
Height: 7 5/8 (193.7)
O. Gskt: G193
End Seals: [2] Attached
Related To: PT394-5, PT394-15 (Different Microns)

B195

Full-Flow Lube Spin-on



Contains: Anti-Drainback Valve
Fits: Peugeot Automotive, Light-Duty Trucks
Replaces: Peugeot 1109-35,-59
Thread: M18 x 1.5
O.D.: 3 1/8 (79.4)
Height: 3 1/2 (88.9)
I.Gskt: [1] Included

B196

Full-Flow Lube Spin-on



Notes: Can be used with OB1368, OB1369 bases.
Contains: Integral Post Seal
Fits: Cummins Engines
Replaces: Fleetguard LF670SC
Thread: 1 1/2 -12
O.D.: 4 21/32 (118.3)
Height: 9 15/16 (252.4)
I.Gskt: [1] Included
Related To: B96, B96-MPG (Long Versions)

P198

Full-Flow Lube or Transmission Element



Fits: Broom & Wade Compressors; Dorman, Lister, Petter Engines
Replaces: Broom & Wade A1413302; Dorman L111/4, Q429/4; Lister 291-40910
O.D.: 3 1/2 (88.9)
I.D.: 2 (50.8)
Height: 6 15/16 (176.2)
F. Gskt: [1] Included
O. Gskt: G202

B199

Full-Flow Lube Spin-on



Contains: Anti-Drainback Valve
8 PSID By-Pass Valve
Fits: Ford, Mercury Automotive
Replaces: Ford D2PJ-6714-AA
Thread: M20 x 1.5
O.D.: 3 (76.2)
Height: 5 1/8 (130.2)
I.Gskt: G449-B

201

DAHL Fuel Element



Notes: 4 Micron Nominal (20 Absolute)
Fits: DAHL 200 Series Fuel Filter/Water Separator Units
O.D.: 6 1/16 (154.0)
I.D.: 1 15/32 (37.3) & 3 9/32 (83.3)
Height: 4 5/8 (117.5)
A. Gskt: [1] Included
F. Gskt: 200-15A
O-Ring: [1] Attached

201-30

DAHL Fuel Element



Notes: 9 Micron Nominal (40 Absolute)
Fits: DAHL 200 Series Fuel Filter/Water Separator Units
O.D.: 6 1/16 (154.0)
I.D.: 1 15/32 (37.3) & 3 9/32 (83.3)
Height: 4 5/8 (117.5)
A. Gskt: [1] Attached
F. Gskt: 200-15A
O-Ring: [1] Attached

201-W

DAHL Fuel Element



Notes: 4 Micron Nominal (20 Absolute)
Fits: DAHL 200 Series Fuel Filter/Water Separator Units
O.D.: 6 1/16 (154.0)
I.D.: 1 15/32 (37.3) & 3 9/32 (83.3)
Height: 4 5/8 (117.5)
A. Gskt: [1] Included
F. Gskt: 200-15A
O-Ring: [1] Attached

B201-S

By-Pass Lube Spin-on



Fits: Ford, Mazda Automotive, Light-Duty Trucks
Replaces: Ford E3TZ-6731-B; Mazda 8259-23-802,-0
Thread: M20 x 1.5
O.D.: 4 1/4 (108.0)
Height: 3 3/16 (81.0)
I.Gskt: [1] Included

B202

Full-Flow Lube Spin-on



Contains: Anti-Drainback Valve
20 PSID By-Pass Valve
Fits: Chrysler, Ford, Mazda, Mitsubishi Automotive, Light-Duty Trucks
Replaces: Ford E37A-6714-BA; Mazda S213-23-802
Thread: M20 x 1.5
O.D.: 3 11/16 (93.7)
Height: 5 3/8 (136.5)
I.Gskt: G381-A

P203

Full-Flow Lube Element



Contains: Reinforced Centertube
Fits: Austin-Western Equipment; International Engines, Equipment
Replaces: Chrysler 2647018; Ford C5R-6731-A; International 213388-R91
O.D.: 4 17/32 (115.1)
I.D.: 1/2 (12.7) & 2 9/32 (57.9)
Height: 5 1/16 (128.6)
F. Gskt: [2] Included
O. Gskt: G115-MSB, G280
End Seals: [1] Attached
Grommets: [1] Attached

Measurements Are Shown In Inches And (Millimeters)

WARNING: These products can expose you to chemicals, including Diisononyl Phthalate, Carbon black extracts, Nickel, 1,3 Butadiene, Ethylene Oxide, Epichlorohydrin, which are known to the State of California to cause cancer, and Bisphenol, Ethylene Glycol, Ethylene Oxide, 1,3 Butadiene, Epichlorohydrin, which are known to the State of California to cause birth defects or other reproductive harm. For more information go to www.P65Warnings.ca.gov.

P203-HD

Hydraulic Element



Contains: Reinforced Centertube
Fits: Dresser, International, Racine Equipment
Replaces: Chrysler 2647018; Ford C5R-6731-A; International 213388-R91
O.D.: 4 17/32 (115.1)
I.D.: 1/2 (12.7) & 2 9/32 (57.9)
Height: 5 1/16 (128.6)
F. Gskt: [1] Included
O. Gskt: G115-MSB, G280
End Seals: [1] Attached
Grommets: [1] Attached

P203-HD10

Hydraulic Element



Contains: Reinforced Centertube
Fits: Cessna, Challenger Equipment
Replaces: Chrysler 2647018; Ford C5R-6731-A; International 213388-R91
O.D.: 4 17/32 (115.1)
I.D.: 1/2 (12.7) & 2 9/32 (57.9)
Height: 5 1/16 (128.6)
O. Gskt: G115-MSB, G280
End Seals: [1] Attached
Grommets: [1] Attached

P204

Full-Flow Lube Element



Contains: Reinforced Centertube
Fits: Clark, Crane Carrier, Galion, Gradall, Grove, Hough, International Equipment
Replaces: Caterpillar 63-6083; International 213445-R91
O.D.: 4 17/32 (115.1)
I.D.: 1/2 (12.7) & 2 9/32 (57.9)
Height: 7 1/16 (179.4)
O. Gskt: G184-A, G211, G280, G362
End Seals: [1] Attached
Grommets: [1] Attached

P204-HD

Hydraulic Element



Contains: Reinforced Centertube
Fits: Case, Caterpillar, Dresser, International Equipment
Replaces: Caterpillar 63-6083; International 213445-R91
O.D.: 4 17/32 (115.1)
I.D.: 1/2 (12.7) & 2 9/32 (57.9)
Height: 7 1/16 (179.4)
O. Gskt: G184-A, G211, G280, G362
End Seals: [1] Attached
Grommets: [1] Attached

P204-HD10

Hydraulic Element



Contains: Reinforced Centertube
Fits: Case, Michigan, P&H Harnischfeger, Vickers Equipment
Replaces: Caterpillar 63-6083; International 213445-R91
O.D.: 4 17/32 (115.1)
I.D.: 1/2 (12.7) & 2 9/32 (57.9)
Height: 7 1/16 (179.4)
O. Gskt: G184-A, G211, G280, G362
End Seals: [1] Attached
Grommets: [1] Attached

B205

Full-Flow Lube Spin-on



Notes: Can be used with OB1368, OB1369 bases.
Contains: Integral Post Seal
Fits: Ag-Chem, Case, Case-International, Champion, Daewoo, Dresser, Fiat-Allis, Gradall, Grove, Hyster, Hyundai, Ingersoll-Rand, Kawasaki, Link-Belt, Rickel, Steiger, Timberjack, White Equipment; Cummins Engines
Replaces: Case A77537; Cummins 3313281
Thread: 1 1/2 -12
O.D.: 4 21/32 (118.3)
Height: 8 3/32 (205.6)
I.Gskt: [1] Included
Related To: B96 (Long Version)

P206

Full-Flow Lube Element



Fits: International Engines, Trucks
Replaces: International 236649-R91, 871867-R91, 871868-R91
O.D.: 4 17/32 (115.1)
I.D.: 1/2 (12.7) & 2 1/4 (57.2)
Height: 3 3/4 (95.3)
F. Gskt: G115-MSB
O. Gskt: G280
End Seals: [1] Attached
Grommets: [1] Attached

PT207

Hydraulic Element



Notes: Use in Gresen line-type housing.
Fits: Allis Chalmers, Case, Caterpillar, John Deere, Massey Ferguson, New Holland, Oliver, Steiger, Versatile Equipment
Replaces: Gresen 1509, 1567, 3143, 3144
O.D.: 4 1/2 (114.3)
I.D.: 1 7/8 (47.6)
Height: 6 31/32 (177.0)
F. Gskt: [2] ES1092
O. Gskt: G236-A, G385, G386, G292, ES3029
Related To: PT554, PT573 (Long Versions)

PT207-10

Hydraulic Element



Notes: Use in Gresen line-type housing.
Fits: Allis Chalmers, Case, Caterpillar, John Deere, Massey Ferguson, New Holland, Oliver, Steiger, Versatile Equipment
Replaces: Gresen 1509, 1567, 3143, 3144
O.D.: 4 1/2 (114.3)
I.D.: 1 7/8 (47.6)
Height: 6 31/32 (177.0)
F. Gskt: [2] ES1092
O. Gskt: G236-A, G385, G386, G292, ES3029
Related To: PT554, PT573 (Long Versions)

PT207-HD

Heavy-Duty Hydraulic Element



Notes: Use in Gresen in-line housing.
Fits: Allis Chalmers, Case, Caterpillar, John Deere, Massey Ferguson, New Holland, Oliver, Steiger, Versatile Equipment
Replaces: Gresen 1509, 1567, 3143, 3144
O.D.: 4 1/2 (114.3)
I.D.: 1 7/8 (47.6)
Height: 6 31/32 (177.0)
F. Gskt: [2] ES1092
O. Gskt: G236-A, G385, G386, G292, ES3029
Related To: PT554, PT573 (Long Versions)

Measurements Are Shown In Inches And (Millimeters)



WARNING: These products can expose you to chemicals, including Diisononyl Phthalate, Carbon black extracts, Nickel, 1,3 Butadiene, Ethylene Oxide, Epichlorohydrin, which are known to the State of California to cause cancer, and Bisphenol, Ethylene Glycol, Ethylene Oxide, 1,3 Butadiene, Epichlorohydrin, which are known to the State of California to cause birth defects or other reproductive harm. For more information go to www.P65Warnings.ca.gov.

PT207-HD10 Heavy-Duty Hydraulic Element
Notes: Use in Gresen in-line housing.
Fits: Allis Chalmers, Case, Caterpillar, John Deere, Massey Ferguson, New Holland, Oliver, Steiger, Versatile Equipment
Replaces: Gresen 1509, 1567, 3143, 3144
O.D.: 4 1/2 (114.3)
I.D.: 1 7/8 (47.6)
Height: 6 31/32 (177.0)
F. Gskt: [2] ES1092
O. Gskt: G236-A, G385, G386, G292, ES3029
Related To: PT554, PT573 (Long Versions)



PT208 Hydraulic Reservoir Element
Fits: Clark Lift Trucks
Replaces: Clark 733289, 883687, 1810143
O.D.: 6 (152.4)
I.D.: 3 1/2 (88.9)
Height: 4 3/16 (106.4)
O. Gskt: G314
End Seals: [2] Attached



PT210 Hydraulic Element
Fits: Minneapolis-Moline Equipment
Replaces: White 10A23992, 10P1851
O.D.: 2 15/32 (62.7)
I.D.: 1 1/16 (27.0)
Height: 7 25/32 (197.6)
F. Gskt: G274
End Seals: [2] Attached



B211 Full-Flow Lube Spin-on
Contains: 20 PSID By-Pass Valve
Fits: Hyster Lift Trucks
Replaces: Hyster 360974
Thread: M20 x 1.5
O.D.: 4 1/4 (108.0)
Height: 5 27/32 (148.4)
I.Gskt: [1] Included



PT212-5 Hydraulic Element
Notes: Inside-Out Flow Direction
Fits: Hough, International Wheel Loaders; Lorain Equipment
Replaces: International 176028-H2
O.D.: 6 (152.4)
I.D.: 2 5/8 (66.7)
Height: 18 1/16 (458.8)
End Seals: [2] Attached
Related To: PT499-5 (Single-Length Version)



PT213 Hydraulic Element
Fits: Atlas Copco, Compair Compressors; Volvo Equipment
Replaces: Atlas Copco 1619-0355; Volvo 4786319
O.D.: 3 17/32 (89.7)
I.D.: 2 1/32 (51.6)
Height: 10 (254.0)
F. Gskt: G202



PT214(2) Set of 2 Hydraulic Elements
Fits: International Crawler, Wheel Tractors
Replaces: International 375085-R91
O.D.: 2 7/8 (73.0)
I.D.: 1 1/16 (27.0)
Height: 1 17/32 (38.9)
F. Gskt: [2] Included



BT215 Full-Flow Lube Spin-on
Contains: Anti-Drainback Valve
 8 PSID By-Pass Valve
 Standpipe
Fits: Allis Chalmers, Compair, Eicher, Landini, Massey Ferguson Equipment; Perkins Engines
Replaces: Perkins 2654408
Thread: 3/4 -16
O.D.: 3 (76.2)
Height: 5 1/8 (130.2)
I.Gskt: G449-B



BT216 Full-Flow Lube Spin-on
Contains: Anti-Drainback Valve
 8 PSID By-Pass Valve
 Standpipe
Fits: Allis Chalmers, Bobcat, Caterpillar, Claas, J.C. Bamford, Landini, Massey Ferguson, New Holland, Vermeer, Volvo Equipment; Perkins Engines
Replaces: Perkins 2654403
Thread: 3/4 -16
O.D.: 3 11/16 (93.7)
Height: 5 3/8 (136.5)
I.Gskt: G381-A
Related To: BT237 (Long Version)



BT217 Full-Flow Lube Spin-on
Contains: Anti-Drainback Valve
 8 PSID By-Pass Valve
 Standpipe
Fits: Hanomag, Hyster Equipment; Transicold Refrigeration Units
Replaces: Transicold 3000323, 3000323-00
Thread: 3/4 -16
O.D.: 3 11/16 (93.7)
Height: 7 1/8 (181.0)
I.Gskt: G381-A



B218 Full-Flow Lube Spin-on
Contains: Anti-Drainback Valve
 30 PSID By-Pass Valve
Fits: Agco, Liebherr, O & K, Poclain Equipment; Deutz Engines
Replaces: Deutz 1173765
Thread: 1 1/8 -16
O.D.: 4 1/4 (108.0)
Height: 10 7/16 (265.1)
I.Gskt: [1] Included



B220 Full-Flow Lube Spin-on
Fits: Hitachi Equipment
Replaces: Hitachi 4192527
Thread: 1 3/8 -16
O.D.: 4 21/32 (118.3)
Height: 9 7/8 (250.8)
I.Gskt: G498-A



Measurements Are Shown In Inches And (Millimeters)

WARNING: These products can expose you to chemicals, including Diisononyl Phthalate, Carbon black extracts, Nickel, 1,3 Butadiene, Ethylene Oxide, Epichlorohydrin, which are known to the State of California to cause cancer, and Bisphenol, Ethylene Glycol, Ethylene Oxide, 1,3 Butadiene, Epichlorohydrin, which are known to the State of California to cause birth defects or other reproductive harm. For more information go to www.P65Warnings.ca.gov.

BT221 Full-Flow Lube Spin-on
Contains: 32 PSID By-Pass Valve
Fits: Toyota Lift Trucks
Replaces: Toyota 15601-68010
Thread: M30 x 1.5
O.D.: 4 1/4 (108.0)
Height: 5 5/8 (142.9)
I.Gskt: [1] Included



B222 By-Pass Lube Spin-on
Fits: Isuzu Engines
Replaces: Isuzu 8-94169-779-0, 8-94169-779-1, 8-94169-779-2
Thread: 5/8 -18
O.D.: 4 1/4 (108.0)
Height: 3 3/16 (81.0)
I.Gskt: [1] Included



BT223 Full-Flow Lube Spin-on
Contains: Anti-Drainback Valve
 8 PSID By-Pass Valve
Fits: BMW, Chrysler, Dodge, GMC, Saab, Saturn, Suzuki, Toyota Automotive; Bobcat, Cub Cadet, Interceptor, John Deere Equipment
Replaces: Chrysler 2647020; Lister 201-55370; Onan 122-0645; Toyota 15601-13051
Thread: 3/4 -16
O.D.: 2 29/32 (73.8)
Height: 3 1/2 (88.9)
A. Gskt: G449-B



PF224 Fuel Element
Fits: Ensign Carburetors; International Engines, Equipment
Replaces: Ensign 6261B; International 64400-DC
O.D.: 1 7/8 (47.6)
I.D.: 23/32 (18.3)
Height: 2 15/32 (62.7)
F. Gskt: [2] Included
O. Gskt: G204-A
End Seals: [2] Attached



PF225 Fuel Element
Fits: Dresser, Galion, Hough Equipment; International Engines, Equipment, Trucks
Replaces: International 266840-R91
O.D.: 4 7/32 (107.2)
I.D.: 13/16 (20.6) & 1 (25.4)
Height: 6 3/4 (171.5)
O. Gskt: G104, G115-MSB, G240, G302
End Seals: [1] Attached



PF226 Secondary Fuel Element
Fits: Adams, Austin-Western, Galion, International, Link-Belt Equipment; International Engines, Equipment
Replaces: International 266839-R91
O.D.: 3 15/32 (88.1)
I.D.: 9/16 (14.3) & 1 (25.4)
Height: 6 3/4 (171.5)
O-Ring: [1] Attached
O. Gskt: G241
Grommets: [1] Attached



B227 Full-Flow Lube Spin-on
Contains: Anti-Drainback Valve
 20 PSID By-Pass Valve
Fits: Chrysler, Ford, GMC, Honda, Isuzu, Mitsubishi Automotive; Kubota, Yanmar Engines
Replaces: Kubota 15241-39092; Yanmar 1196-6035150
Thread: M20 x 1.5
O.D.: 3 (76.2)
Height: 2 27/32 (72.2)
I.Gskt: [1] Included



B228 Full-Flow Lube Spin-on
Contains: Anti-Drainback Valve
 30 PSID By-Pass Valve
Fits: Atlas Copco Compressors; Audi, BMW, GM Automotive; Bobcat, Claas, Gehl Equipment; Deutz Engines
Replaces: Deutz 1163420; GMC 6696776
Thread: 3/4 -16
O.D.: 3 (76.2)
Height: 3 1/2 (88.9)
I.Gskt: G449-B
Related To: B178 (Long Version)



B229 Full-Flow Lube Spin-on
Contains: Anti-Drainback Valve
 20 PSID By-Pass Valve
Fits: Case Equipment; David Brown, Isuzu Engines; Toyota Automotive, Light-Duty Trucks
Replaces: Case A46158; Isuzu X13201-001; Toyota 15601-44011
Thread: 3/4 -16
O.D.: 3 11/16 (93.7)
Height: 4 3/8 (111.1)
I.Gskt: G381-A



BT230 Full-Flow Lube Spin-on
Fits: Ag-Chem, Caterpillar, Grove, Hitachi, New Holland, Takeuchi, White Equipment; Hino, International, Mack, Volvo Trucks
Replaces: Caterpillar 8N9586
Thread: 1 1/8 -16
O.D.: 3 11/16 (93.7)
Height: 5 3/8 (136.5)
I.Gskt: G381-A
Related To: BT260, BT260-10 (Transmission Versions)



PF231 Fuel Element
Fits: Deutz, International, Mercedes-Benz Engines; M.A.N., R.V.I. Buses, Trucks
Replaces: Deutz R1H4155,-H; International 3029244-R91; Mercedes-Benz 4773515
O.D.: 2 7/8 (73.0)
I.D.: 9/16 (14.3)
Height: 5 27/32 (148.4)
Grommets: [2] Attached



BD232 Dual-Flow Lube Spin-on
Contains: 36 PSID By-Pass Valve
 Standpipe
Fits: Allis Chalmers, Fiat Equipment; Iveco, R.V.I. Trucks
Replaces: Fiat 1902076, 4787410, 5983900
Thread: 3/4 -16
O.D.: 4 1/4 (108.0)
Height: 5 11/16 (144.5)
I.Gskt: [1] Included



Measurements Are Shown In Inches And (Millimeters)

WARNING: These products can expose you to chemicals, including Diisononyl Phthalate, Carbon black extracts, Nickel, 1,3 Butadiene, Ethylene Oxide, Epichlorohydrin, which are known to the State of California to cause cancer, and Bisphenol, Ethylene Glycol, Ethylene Oxide, 1,3 Butadiene, Epichlorohydrin, which are known to the State of California to cause birth defects or other reproductive harm. For more information go to www.P65Warnings.ca.gov.

B233 Full-Flow Lube Spin-on
Contains: Anti-Drainback Valve
 8 PSID By-Pass Valve
Fits: Chrysler, Ford, Toyota, Volkswagen Automotive, Light-Duty Trucks, Vans
Replaces: Chrysler 3549957; Ford C5ZZ-6731-A
Thread: 3/4 -16
O.D.: 3 11/16 (93.7)
Height: 4 3/8 (111.1)
A. Gskt: G381-A



BT238 Full-Flow Lube Spin-on
Contains: Anti-Drainback Valve
 20 PSID By-Pass Valve
Fits: Kubota, Thomas Equipment
Replaces: Kubota 70000-15451
Thread: 3/4 -16
O.D.: 4 1/4 (108.0)
Height: 7 11/32 (186.5)
I.Gskt: G381-A



BT234 Full-Flow Lube Spin-on
Fits: Nissan Engines
Replaces: Nissan 15274-99186, 15274-99626
Thread: 1 1/8 -16
O.D.: 4 9/32 (108.7)
Height: 8 1/32 (204.0)
I.Gskt: [1] Included



B239 Full-Flow Lube Spin-on
Contains: 30 PSID By-Pass Valve
Fits: John Deere Equipment
Replaces: John Deere AZ36942
Thread: 1 1/2 -16
O.D.: 5 3/8 (136.5)
Height: 12 3/32 (307.2)
I.Gskt: [1] Included



P235 Full-Flow Lube Element
Fits: DAF, Iveco, M.A.N., R.V.I, Volvo Trucks; Deutz Engines; Fiat Equipment
Replaces: Deutz 1168446; Fiat 1909123
O.D.: 3 17/32 (89.7)
I.D.: 1 5/16 (33.3)
Height: 7 13/16 (198.4)
F. Gskt: G202
End Seals: [2] Attached



P240 Full-Flow Lube Element
Fits: David Brown Equipment
Replaces: Ford 105E-6731-A
O.D.: 2 7/8 (73.0)
I.D.: 27/32 (21.4)
Height: 3 5/32 (80.2)
F. Gskt: [1] Included



B236 Full-Flow Lube or Hydraulic Spin-on
Contains: Anti-Drainback Valve
 30 PSID By-Pass Valve
Fits: Atlas Copco Compressors; Bomag, Case, Caterpillar, Demag, Deutz, Drott, Fendt, John Deere, Liebherr Equipment; Deutz Engines
Replaces: Case A44081; Deutz 1173430; John Deere AZ22878
Thread: 1 -12
O.D.: 3 11/16 (93.7)
Height: 8 1/8 (206.4)
I.Gskt: G381-A
Related To: B7031 (Short Version)



BT241 Full-Flow Lube Spin-on
Contains: Anti-Drainback Valve
 8 PSID By-Pass Valve
Fits: Wisconsin Engines
Replaces: Wisconsin RV51
Thread: 13/16 -16
O.D.: 3 13/16 (96.8)
Height: 4 3/8 (111.1)
I.Gskt: [1] Included



BT237 Full-Flow Lube Spin-on
Contains: Anti-Drainback Valve
 8 PSID By-Pass Valve
 Standpipe
Fits: Bobcat, Caterpillar, Hymac, Hyster, J.C. Bamford, Komatsu, Landini, Massey Ferguson Equipment; Perkins Engines
Replaces: Perkins 2654407
Thread: 3/4 -16
O.D.: 3 11/16 (93.7)
Height: 7 1/8 (181.0)
I.Gskt: G381-A
Related To: BT216 (Short Version)



P242 Full-Flow Lube Element
Contains: Reinforced Centertube
Fits: Mercedes-Benz Engines, Equipment
Replaces: Mercedes-Benz 4011800009
O.D.: 4 25/32 (121.4)
I.D.: 17/32 (13.5) & 2 5/32 (54.8)
Height: 7 13/32 (188.1)
F. Gskt: [3] Washers
O-Ring: [1] Included
Spring: [1] Attached



B243 Full-Flow Lube Spin-on
Contains: Anti-Drainback Valve
 8 PSID By-Pass Valve
Fits: Chrysler, Ford, Mazda, Toyota, Volkswagen Automotive, Light-Duty Trucks, Vans; Ford, Gehl, Kubota Equipment; Kohler, Onan Engines
Replaces: Ford E4FZ-6731-AB; Kohler 277233; Onan 122-0680
Thread: 3/4 -16
O.D.: 3 (76.2)
Height: 4 27/32 (123.0)
A. Gskt: G449-B



Measurements Are Shown In Inches And (Millimeters)

WARNING: These products can expose you to chemicals, including Diisononyl Phthalate, Carbon black extracts, Nickel, 1,3 Butadiene, Ethylene Oxide, Epichlorohydrin, which are known to the State of California to cause cancer, and Bisphenol, Ethylene Glycol, Ethylene Oxide, 1,3 Butadiene, Epichlorohydrin, which are known to the State of California to cause birth defects or other reproductive harm. For more information go to www.P65Warnings.ca.gov.

B244 Full-Flow Lube Spin-on
Contains: Anti-Drainback Valve
 20 PSID By-Pass Valve
Fits: GMC, Isuzu Engines, Trucks
Replaces: GMC 94169778; Isuzu 8-94169-778-0,
 8-94169-778-1, 8-94169-778-2
Thread: 3/4 -16
O.D.: 3 11/16 (93.7)
Height: 5 3/8 (136.5)
I.Gskt: G324-A



B252 Transmission Spin-on
Contains: Anti-Drainback Valve
 20 PSID By-Pass Valve
Fits: Allison Transmissions
Replaces: GMC 25010441
Thread: 3/4 -16
O.D.: 3 11/16 (93.7)
Height: 5 15/32 (138.9)
I.Gskt: G401



B246 Lube Spin-on
Contains: Anti-Drainback Valve
Replaces: Nissan 15208-W3401
Thread: 3/4 -16
O.D.: 3 3/4 (95.3)
Height: 5 9/32 (134.1)
I.Gskt: G381-A



B253 Full-Flow Heavy-Duty Lube Spin-on
Notes: Can be used in racing applications.
Contains: Anti-Drainback Valve
 20 PSID By-Pass Valve
 Standpipe
Fits: Ferrari, Porsche Automotive
Replaces: Ferrari 45384000; Lancia 2220425;
 Porsche 901-107-203-02
Thread: 3/4 -16
O.D.: 3 11/16 (93.7)
Height: 5 15/32 (138.9)
I.Gskt: G401



B247 Full-Flow Lube Spin-on
Contains: Anti-Drainback Valve
 8 PSID By-Pass Valve
Fits: Komatsu Equipment; Thermo King
 Refrigeration Units
Replaces: Thermo King 11-5522
Thread: M20 x 1.5
O.D.: 3 (76.2)
Height: 4 13/16 (122.2)
I.Gskt: [1] Included



P254 Lube Element
Fits: Bray Construction Equipment with
 Leyland-DAF Engines
Replaces: Leyland 602426
O.D.: 3 1/8 (79.4)
I.D.: 15/32 (11.9) & 3/4 (19.1)
Height: 9 3/8 (238.1)
F. Gskt: [3] Included
End Seals: [1] Attached



BT248 Full-Flow Lube Spin-on
Contains: Anti-Drainback Valve
 8 PSID By-Pass Valve
Fits: New Holland Equipment; Wisconsin
 Engines
Replaces: Wisconsin RV38-S
Thread: 5/8 -18
O.D.: 3 11/16 (93.7)
Height: 5 13/32 (137.3)
I.Gskt: G381-A



B255 Full-Flow Lube Spin-on
Fits: Sullair Compressors
Replaces: Sullair 408107
Thread: 1 -12
O.D.: 3 11/16 (93.7)
Height: 5 15/32 (138.9)
I.Gskt: G401



P249 Full-Flow Lube Element
Fits: Caterpillar, Kobelco Equipment;
 Mitsubishi Engines
Replaces: Mitsubishi ME034611
O.D.: 4 11/32 (110.3)
I.D.: 3/4 (19.1)
Height: 7 5/8 (193.7)
A. Gskt: [1] Attached
F. Gskt: [1] Included
O-Ring: [1] Included
Grommets: [2] Attached



PT256 Hydraulic Element
Contains: Reinforced Centertube
Fits: Army-Navy Hydraulic Systems
Replaces: Army-Navy AN6235-2A; Bendix
 572760
O.D.: 1 5/32 (29.4)
I.D.: 5/8 (15.9) One End
Height: 4 11/16 (119.1)
O-Ring: [1] Attached



BT251 Full-Flow Lube Spin-on
Contains: Anti-Drainback Valve
 8 PSID By-Pass Valve
Fits: Ford, Oliver Tractors
Replaces: Ford D2NN-6714-C
Thread: 3/4 -16
O.D.: 3 11/16 (93.7)
Height: 7 1/8 (181.0)
I.Gskt: G381-A



PT257 Hydraulic Element
Contains: Reinforced Centertube
Fits: Caterpillar Excavators; Army-Navy
 Hydraulic Systems
Replaces: Army-Navy AN6235-3A; Vickers
 62343
O.D.: 1 21/32 (42.1)
I.D.: 7/8 (22.2) One End
Height: 3 1/2 (88.9)
O-Ring: [1] Attached



Measurements Are Shown In Inches And (Millimeters)

WARNING: These products can expose you to chemicals, including Diisononyl Phthalate, Carbon black extracts, Nickel, 1,3 Butadiene, Ethylene Oxide, Epichlorohydrin, which are known to the State of California to cause cancer, and Bisphenol, Ethylene Glycol, Ethylene Oxide, 1,3 Butadiene, Epichlorohydrin, which are known to the State of California to cause birth defects or other reproductive harm. For more information go to www.P65Warnings.ca.gov.

PT258



Hydraulic Element

Contains: Reinforced Centertube
Fits: Army-Navy Hydraulic Systems; International Combines; Massey Ferguson Tractors; Vickers Optional Filter Housings
Replaces: Army-Navy AN6235-4A; Bendix 572759; International 573201-R91
O.D.: 1 25/32 (45.2)
I.D.: 1 (25.4) One End
Height: 4 1/2 (114.3)
O-Ring: [1] Attached

B263



Full-Flow Lube Spin-on

Fits: Mercedes-Benz Engines
Replaces: Mercedes-Benz 31841701
Thread: 1 -12
O.D.: 4 1/4 (108.0)
Height: 9 1/8 (231.8)
I.Gskt: G401

BT259



Full-Flow Lube or Hydraulic Spin-on

Contains: 20 PSID By-Pass Valve
Fits: Blaw Knox, Caterpillar, Ditch Witch, Dynapac, John Deere, Rayco, Vermeer, Zetor Equipment; Ingersoll-Rand Compressors
Replaces: John Deere AR58956, T19044
Thread: 13/16 -16
O.D.: 3 11/16 (93.7)
Height: 5 13/32 (137.3)
I.Gskt: G401

BT264



Full-Flow Lube Spin-on

Contains: Anti-Drainback Valve
 8 PSID By-Pass Valve
Fits: Caterpillar Engines, Equipment
Replaces: Caterpillar 2S5262, 2S9969
Thread: 7/8 -14
O.D.: 3 11/16 (93.7)
Height: 4 3/8 (111.1)
I.Gskt: G381-A
Related To: BT126 (Long Version)

BT260



Hydraulic or Transmission Spin-on

Fits: Cessna Hydraulic Systems; International, John Deere, New Holland, Yale & Towne Equipment
Replaces: Cessna 60187-6
Thread: 1 1/8 -16
O.D.: 3 11/16 (93.7)
Height: 5 3/8 (136.5)
I.Gskt: G381-A
Related To: BT230 (Lube Version)

PT265

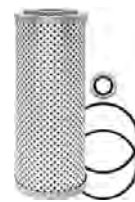

Transmission Element

Fits: Allis Chalmers, Fiat-Allis Equipment
Replaces: Allis Chalmers 631828, 4995265
O.D.: 3 (76.2)
I.D.: 1 1/16 (27.0)
Height: 7 23/32 (196.1)
F. Gskt: G270, ES1030, [1] Included
O. Gskt: G133
End Seals: [2] Attached

BT260-10



Hydraulic or Transmission Spin-on

Fits: Cessna Hydraulic Systems; Bobcat, Case, Ford, John Deere, Kobelco, Massey Ferguson, New Holland Equipment
Replaces: Cessna 60187-6
Thread: 1 1/8 -16
O.D.: 3 11/16 (93.7)
Height: 5 3/8 (136.5)
I.Gskt: G381-A
Related To: BT230 (Lube Version)

P266



Full-Flow Lube Element

Fits: Isuzu Engines; Kobelco, Koehring, Multiquip Equipment
Replaces: Isuzu 9-88513-106-1
O.D.: 3 9/32 (83.3)
I.D.: 23/32 (18.3) & 1 5/8 (41.3)
Height: 5 11/16 (144.5)
F. Gskt: [4] Included
End Seals: [1] Attached
Grommets: [1] Attached

BT261



Full-Flow Lube Spin-on

Contains: Anti-Drainback Valve
 Standpipe
Fits: Case, Dresser, Drott, Galion, Hough, International, John Deere Equipment
Replaces: Case A58672, A75294
Thread: 1 -12
O.D.: 3 11/16 (93.7)
Height: 7 1/8 (181.0)
I.Gskt: G381-A
Related To: B299 (High Performance Version)

BT267



Full-Flow Lube Spin-on

Contains: Anti-Drainback Valve
 20 PSID By-Pass Valve
Fits: Allis Chalmers, Fiat-Allis, Ford, Hanomag, Iveco Equipment
Replaces: Allis Chalmers 2089505; Ford D5NN-6714-A
Thread: 3/4 -16
O.D.: 4 1/4 (108.0)
Height: 5 13/16 (147.6)
I.Gskt: G381-A

B262



Full-Flow Lube Spin-on

Contains: 30 PSID By-Pass Valve
Fits: Atlas Copco Compressors; Gardner Denver Drills; Yanmar Engines
Replaces: Atlas Copco 1619-3771
Thread: 1 -12
O.D.: 3 11/16 (93.7)
Height: 8 23/32 (221.5)
I.Gskt: G381-A

PT268



Hydraulic Element

Fits: Case, Dresser, International Equipment
Replaces: International 390560-R91, 528507-R91
O.D.: 5 (127.0)
I.D.: 2 13/16 (71.4)
Height: 6 1/8 (155.6)
F. Gskt: G261, G307, G360, G368
O. Gskt: G260, G362, G382
End Seals: [2] Attached

Measurements Are Shown In Inches And (Millimeters)

WARNING: These products can expose you to chemicals, including Diisononyl Phthalate, Carbon black extracts, Nickel, 1,3 Butadiene, Ethylene Oxide, Epichlorohydrin, which are known to the State of California to cause cancer, and Bisphenol, Ethylene Glycol, Ethylene Oxide, 1,3 Butadiene, Epichlorohydrin, which are known to the State of California to cause birth defects or other reproductive harm. For more information go to www.P65Warnings.ca.gov.

PT269



Full-Flow Lube Element

Fits: Deutz, Hyster Equipment
Replaces: Deutz 150154012; Hyster 136853
O.D.: 3 5/16 (84.1)
I.D.: 15/16 (23.8)
Height: 4 5/8 (117.5)

P276



Full-Flow Lube Element

Fits: Ag-Chem Fertilizer Applicators, Sprayers; International Buses, Engines, Trucks
Replaces: International 244572-R92, 313117-C92
O.D.: 4 1/2 (114.3)
I.D.: 1 1/16 (27.0)
Height: 6 5/8 (168.3)
Grommets: [2] Attached

P271



Full-Flow Lube Element

Fits: OMC Engines
Replaces: Ford 113E-6731-A
O.D.: 2 7/8 (73.0)
I.D.: 27/32 (21.4)
Height: 4 3/16 (106.4)
F. Gskt: [1] Included

PT277



Hydraulic Element

Notes: Inside-Out Flow Direction
Fits: Massey Ferguson Equipment
Replaces: Massey Ferguson 228529-M1; Timberjack 101465
O.D.: 3 15/16 (100.0)
I.D.: 2 (50.8)
Height: 7 1/2 (190.5)

PT273



Hydraulic Element

Replaces: Allis Chalmers 631827
O.D.: 2 7/8 (73.0)
I.D.: 1 1/16 (27.0)
Height: 4 15/16 (125.4)
F. Gskt: G270, ES1030, [1] Included
End Seals: [2] Attached

B279



Full-Flow Lube Spin-on

Notes: Can be used in racing applications.
Contains: Anti-Drainback Valve
 20 PSID By-Pass Valve
Fits: Mercruiser Marine
Replaces: GMC 6438868
Thread: 13/16 -16
O.D.: 3 11/16 (93.7)
Height: 5 11/32 (135.7)
I.Gskt: [1] Included

BT274



Hydraulic Spin-on

Contains: 10 PSID By-Pass Valve
Fits: Case, International, Wayne Equipment
Replaces: Case A32297
Thread: 1 -12
O.D.: 3 11/16 (93.7)
Height: 5 3/8 (136.5)
I.Gskt: G381-A

P280



Full-Flow Lube Element

Fits: Isuzu Engines; John Deere Loaders
Replaces: Isuzu 9-88513-107-01; John Deere GV10805
O.D.: 2 7/8 (73.0)
I.D.: 1 5/16 (33.3)
Height: 5 15/32 (138.9)
F. Gskt: [3] Included
End Seals: [2] Attached

PT275



Transmission Element

Contains: Reinforced Centertube
Fits: FWD, Racine, Wagner, Yale & Towne Equipment
Replaces: Racine 493144
O.D.: 4 17/32 (115.1)
I.D.: 1/2 (12.7) & 2 9/32 (57.9)
Height: 9 1/16 (230.2)
O. Gskt: G211
End Seals: [1] Attached
Grommets: [1] Attached

B281



Full-Flow Lube Spin-on

Contains: Anti-Drainback Valve
 20 PSID By-Pass Valve
Fits: Komatsu, New Holland Equipment; Onan Generators; VM Engines
Replaces: Onan 122-0550; VM Engines 4115030
Thread: M22 x 1.5
O.D.: 3 11/16 (93.7)
Height: 5 3/8 (136.5)
I.Gskt: G381-A

PT275-10



Transmission Element

Contains: Reinforced Centertube
Fits: Dresser, International, Racine Equipment
Replaces: Eaton 493144
O.D.: 4 17/32 (115.1)
I.D.: 1/2 (12.7) & 2 9/32 (57.9)
Height: 9 1/16 (230.2)
O. Gskt: G211
End Seals: [1] Attached
Grommets: [1] Attached

PT283



Hydraulic Element

Fits: Barber-Greene Loaders with International Engines
Replaces: Bendix 47177
O.D.: 1 1/16 (27.0)
I.D.: 5/8 (15.9)
Height: 3 5/32 (80.2)

Measurements Are Shown In Inches And (Millimeters)

WARNING: These products can expose you to chemicals, including Diisononyl Phthalate, Carbon black extracts, Nickel, 1,3 Butadiene, Ethylene Oxide, Epichlorohydrin, which are known to the State of California to cause cancer, and Bisphenol, Ethylene Glycol, Ethylene Oxide, 1,3 Butadiene, Epichlorohydrin, which are known to the State of California to cause birth defects or other reproductive harm. For more information go to www.P65Warnings.ca.gov.

PT284



Hydraulic Element

Fits: Barber-Greene Loaders with International Engines
Replaces: Bendix 47198
O.D.: 1 3/8 (34.9)
I.D.: 7/8 (22.2)
Height: 4 1/32 (102.4)

BT287-3



High Efficiency Hydraulic Spin-on

Notes: Can be used with OB1313, OB1314, OB1315, OB1316 bases (requires optional G286-C gasket).
Fits: Agco Combines
Replaces: Gresen K23020; Zinga SE3
Thread: 1 1/2 -16
O.D.: 5 1/16 (128.6)
Height: 7 (177.8)
F. Gskt: G369-B (Blue Striped)
O. Gskt: G286-C, G369-V, G372, G447, G483, G704, G710

PT285



Hydraulic Element

Fits: International Equipment
Replaces: International 613788-C91
O.D.: 5 (127.0)
I.D.: 2 13/16 (71.4)
Height: 11 1/16 (281.0)

PT288-HD



Hydraulic Element

Fits: Case Loaders, Optional Equipment; Link-Belt Backhoes
Replaces: Case D35995; Ford D3NN-F882-A; John Deere AT45811; Link-Belt 20P14
O.D.: 4 1/2 (114.3)
I.D.: 2 7/32 (56.4)
Height: 7 7/16 (188.9)
I.Gskt: [2] Included
O. Gskt: G307, G397
Related To: PT550-10 (Double-Length Version)

BT287



Full-Flow Lube or Hydraulic Spin-on

Notes: CAUTION: Use G372 (yellow striped) gasket ONLY on Case and G369-B (blue striped) gasket on John Deere. Installing wrong gasket prevents seal. Can use with OB1313, OB1314, OB1315, OB1316 bases (requires optional G286-C gasket).
Fits: Ag-Chem, Bobcat, Case, Demag, Hydra-Mac, Hyster, John Deere, Manitowoc, Michigan Fluid Power, Steiger Equipment
Replaces: Bobcat 6552507, Case A57857; Demag 25577440; Hydra-Mac 3401-307; John Deere AR43261
Thread: 1 1/2 -16
O.D.: 5 1/32 (127.8)
Height: 7 (177.8)
F. Gskt: G369-B (Blue Striped), G372 (Yellow Striped)
O. Gskt: G286-C, G369-V, G447, G483, G704, G710

PT288-HD10



Hydraulic Element

Fits: Ford Loaders; John Deere Equipment
Replaces: Case D35995; Ford D3NN-F882-A; John Deere AT45811; Link-Belt 20P14
O.D.: 4 1/2 (114.3)
I.D.: 2 7/32 (56.4)
Height: 7 7/16 (188.9)
I.Gskt: [2] Included
O. Gskt: G307, G397
Related To: PT550-10 (Double-Length Version)

BT287-10



Hydraulic Spin-on

Notes: CAUTION: Use furnished G369-B (blue striped) gasket on John Deere. Use optional G372 (yellow striped) gasket ONLY on Case. Installing wrong gasket prevents seal. Can use with OB1313, OB1314, OB1315, OB1316 bases (requires opt. G286-C gasket).
Fits: Case, Case-International, Caterpillar, Champion, Ditch Witch, Dynamic Industries, Ford, Gehl, Hesston, John Deere, Manitou, Michigan Fluid Power, New Holland, Steiger Equipment
Replaces: Case 87027972; Caterpillar 9T5664; Champion 13028; Ditch Witch 155-954; Dynamic 1H1234; John Deere AT58368; Michigan Fluid Power 200-0600; New Holland 86542664
Thread: 1 1/2 -16
O.D.: 5 1/32 (127.8)
Height: 7 (177.8)
F. Gskt: G369-B (Blue Striped)
O. Gskt: G286-C, G369-V, G372, G447, G483, G704, G710

PT289



Hydraulic Element

Fits: Austin-Western, Case Equipment
Replaces: Case D43567, D75831
O.D.: 2 5/8 (66.7)
I.D.: 1 1/4 (31.8) One End
Height: 7 5/16 (185.7)
I.Gskt: [1] Included
F. Gskt: G247

PT289-10



Hydraulic Element

Fits: Agco, Franklin Equipment
Replaces: Franklin 1503007
O.D.: 2 5/8 (66.7)
I.D.: 1 1/4 (31.8) One End
Height: 7 5/16 (185.7)
I.Gskt: [1] Included
F. Gskt: G247

PT290



Hydraulic Element

Fits: Allis Chalmers Equipment
Replaces: Marvel 5602065125
O.D.: 2 5/8 (66.7)
I.D.: 1 1/4 (31.8) One End
Height: 7 5/16 (185.7)
F. Gskt: G247
O-Ring: [1] Attached

Measurements Are Shown In Inches And (Millimeters)

WARNING: These products can expose you to chemicals, including Diisononyl Phthalate, Carbon black extracts, Nickel, 1,3 Butadiene, Ethylene Oxide, Epichlorohydrin, which are known to the State of California to cause cancer, and Bisphenol, Ethylene Glycol, Ethylene Oxide, 1,3 Butadiene, Epichlorohydrin, which are known to the State of California to cause birth defects or other reproductive harm. For more information go to www.P65Warnings.ca.gov.

BT292



Full-Flow Lube Spin-on
Contains: Anti-Drainback Valve
 30 PSID By-Pass Valve
Fits: Atlas Copco Compressors; Blaw-Knox, Bomag, Caterpillar, Claas, Demag, Deutz, Ditch Witch, Dynapac, Fendt, Hanomag, Komatsu, Liebherr, New Holland, Nissan, Poclain, Vermeer Equipment
Replaces: Atlas Copco 9712540103; Deutz 150157510
Thread: 1 -12
O.D.: 3 11/16 (93.7)
Height: 5 3/8 (136.5)
I.Gskt: G381-A

T300-M



Vac-Cel By-Pass Lube Spin-on with Mason Jar Screw Neck
Fits: Allis Chalmers, Case, Clark, Hyster, Kohler, Massey Ferguson, New Holland, Oliver Equipment
Replaces: Allis Chalmers 70240912; Case A36136; Clark 872790; Hyster 28714; Kohler 270197; Massey Ferguson 835652-M91; White TO11663
Thread: 2 3/4 -4
O.D.: 3 17/32 (89.7)
Height: 4 27/32 (123.0)
F. Gskt: [1] Included

P294



Full-Flow Lube Element
Contains: Reinforced Centertube
Fits: M.A.N., Mercedes-Benz, R.V.I. Buses, Engines, Trucks
Replaces: Mercedes-Benz 4031840025
O.D.: 4 25/32 (121.4)
I.D.: 17/32 (13.5) & 2 5/32 (54.8)
Height: 10 13/32 (264.3)
F. Gskt: [1] Included
O-Ring: [1] Included
End Seals: [1] Attached
Grommets: [2] Attached

301



DAHL Fuel Element
Notes: 5 Micron Nominal (25 Absolute)
Fits: DAHL 300 Series Fuel Filter/Water Separator Units
O.D.: 6 1/16 (154.0)
I.D.: 1 15/32 (37.3) & 3 1/4 (82.6)
Height: 9 11/16 (246.1)
A. Gskt: [1] Included
F. Gskt: 200-15A
O-Ring: [1] Attached

B295



Full-Flow Lube Spin-on
Contains: Anti-Drainback Valve
Fits: Mercedes-Benz, Nissan, Toyota Automotive; Ford, Hitachi, International Equipment; Komatsu, Nissan Lift Trucks
Replaces: GMC 25011623; Nissan 15209-J1800; Toyota 15601-22010
Thread: 3/4 -16
O.D.: 3 1/32 (77.0)
Height: 5 27/32 (148.4)
I.Gskt: [1] Included
Related To: B143 (Short Version)

301-30



DAHL Fuel Element
Notes: 9 Micron Nominal (40 Absolute)
Fits: DAHL 300 Series Fuel Filter/Water Separator Units
O.D.: 6 1/16 (154.0)
I.D.: 1 15/32 (37.3) & 3 1/4 (82.6)
Height: 9 11/16 (246.1)
A. Gskt: [1] Included
F. Gskt: 200-15A
O-Ring: [1] Attached

B296



By-Pass Lube Spin-on
Contains: Flow Control Orifice
Fits: Clark Lift Trucks; Ingersoll-Rand Compressors
Replaces: Clark 906540
Thread: 5/8 -18
O.D.: 3 11/16 (93.7)
Height: 3 7/8 (98.4)
I.Gskt: G381-A

301-CS



DAHL Fuel Element with Water Absorbing Media
Contains: Water Absorbent Media
Fits: DAHL 300 Series Fuel Filter/Water Separator Units
O.D.: 6 1/16 (154.0)
I.D.: 1 15/32 (37.3) & 3 1/4 (82.6)
Height: 9 11/16 (246.1)
A. Gskt: [1] Included
F. Gskt: 200-15A
O-Ring: [1] Attached

PT298-10



Transmission Element
Fits: Gomaco Paving Equipment
Replaces: Marvel 676366-7110
O.D.: 4 1/2 (114.3)
I.D.: 2 1/4 (57.2)
Height: 7 3/8 (187.3)
I.Gskt: [2] Included

301-MPG



Maximum Performance Glass DAHL Fuel Element
Fits: DAHL 300 Series Fuel Filter/Water Separator Units
O.D.: 6 1/16 (154.0)
I.D.: 1 15/32 (37.3) & 3 1/4 (82.6)
Height: 9 11/16 (246.1)
A. Gskt: [1] Included
F. Gskt: 200-15A
O-Ring: [1] Attached

B299



High Performance Full-Flow Lube Spin-on
Contains: Anti-Drainback Valve Standpipe
Fits: Case, International Equipment
Replaces: International 1808896-C1
Thread: 1 -12
O.D.: 3 11/16 (93.7)
Height: 7 5/32 (181.8)
I.Gskt: G401
Related To: BT261 (Standard Version)













301-W



DAHL Fuel Element
Notes: 3 Micron Nominal (9 Absolute)
Fits: DAHL 300 Series Fuel Filter/Water Separator Units
O.D.: 6 1/16 (154.0)
I.D.: 1 15/32 (37.3) & 3 1/4 (82.6)
Height: 9 11/16 (246.1)
A. Gskt: [1] Included
F. Gskt: 200-15A
O-Ring: [1] Attached

Measurements Are Shown In Inches And (Millimeters)

! **WARNING:** These products can expose you to chemicals, including Diisononyl Phthalate, Carbon black extracts, Nickel, 1,3 Butadiene, Ethylene Oxide, Epichlorohydrin, which are known to the State of California to cause cancer, and Bisphenol, Ethylene Glycol, Ethylene Oxide, 1,3 Butadiene, Epichlorohydrin, which are known to the State of California to cause birth defects or other reproductive harm. For more information go to www.P65Warnings.ca.gov.

<p>B301 Lube Spin-on Contains: 8 PSID By-Pass Valve Fits: Subaru Automotive Replaces: Subaru 15208-AA021 Thread: M20 x 1.5 O.D.: 3 (76.2) Height: 2 27/32 (72.2) I.Gskt: [1] Included</p> 	<p>T308-M Vac-Cel By-Pass Lube Spin-on with Mason Jar Screw Neck Fits: Bobcat, Case, Ditch Witch, Gehl, John Deere, New Holland, Vermeer Equipment; Wisconsin Engines Replaces: Wisconsin RV40 Thread: 2 3/4 -5 1/2 O.D.: 3 17/32 (89.7) Height: 4 27/32 (123.0) F. Gskt: [1] Included</p> 
<p>PT302 By-Pass Lube Spin-on with Mason Jar Screw Neck Fits: Oliver, White Equipment Replaces: Oliver 100126ASA; White 1LA5507 Thread: 2 3/4 -4 O.D.: 3 7/8 (98.4) Height: 6 3/8 (161.9) F. Gskt: [1] Included</p> 	<p>B309 High Performance Full-Flow Lube Spin-on Fits: Case, International Equipment Replaces: International 1811953-C1 Thread: 1 -12 O.D.: 4 1/4 (108.0) Height: 7 3/8 (187.3) I.Gskt: G401</p> 
<p>T303-M Vac-Cel By-Pass Lube Spin-on with Mason Jar Screw Neck Fits: Allis Chalmers Engines; Joy Compressors; Oliver Equipment Replaces: Allis Chalmers 8009129; Joy 202317; Oliver 100929ASA Thread: 2 3/4 -4 O.D.: 3 7/8 (98.4) Height: 6 13/32 (162.7) F. Gskt: [1] Included</p> 	<p>BT310 Full-Flow Lube Spin-on Contains: Anti-Drainback Valve 2 PSID By-Pass Valve Fits: Yale Equipment Replaces: Yale 1500176-00 Thread: M20 x 1.5 O.D.: 3 (76.2) Height: 3 17/32 (89.7) I.Gskt: G449-B</p> 
<p>PT304 By-Pass Lube Spin-on with Mason Jar Screw Neck Fits: Kohler, Link-Belt, Oliver Equipment; Waukesha Engines Replaces: Oliver 250046, 100125ASA; Waukesha 119390A, K5507 Thread: 2 3/4 -4 O.D.: 3 7/8 (98.4) Height: 7 5/8 (193.7) F. Gskt: [1] Included</p> 	<p>PF311 Fuel Element Fits: Daewoo, Hitachi Equipment; Hino, Isuzu Trucks; Kawasaki Loaders Replaces: Isuzu 9-88511-191-1 O.D.: 2 7/8 (73.0) I.D.: 9/16 (14.3) Height: 4 11/32 (110.3) F. Gskt: ES1036, [2] Included Grommets: [2] Attached</p> 
<p>BT305 Hydraulic Spin-on Fits: Caterpillar Equipment Replaces: Caterpillar 93-7521 Thread: 1 1/8 -16 O.D.: 3 11/16 (93.7) Height: 7 1/8 (181.0) A. Gskt: G381-A</p> 	<p>PF312 Primary Fuel Element Fits: Allis Chalmers, Fiat-Allis, New Holland Equipment; Iveco Trucks Replaces: Allis Chalmers 4964323; Fiat 1902096; Iveco 1902096 O.D.: 3 23/32 (94.5) I.D.: 1/2 (12.7) & 1 1/32 (26.2) Height: 7 17/32 (191.3) F. Gskt: G480 End Seals: [1] Attached Grommets: [1] Attached</p> 
<p>B307 Full-Flow Lube or Hydraulic Spin-on Contains: Anti-Drainback Valve 8 PSID By-Pass Valve Fits: R.V.I. Trucks Replaces: Renault 5000791145 Thread: M20 x 1.5 O.D.: 3 (76.2) Height: 2 7/8 (73.0) I.Gskt: G449-B</p> 	<p>PF313 Fuel Element Fits: Isuzu Engines, Trucks Replaces: Isuzu 5-87810-050-0 O.D.: 2 7/8 (73.0) I.D.: 9/16 (14.3) Height: 3 5/16 (84.1) F. Gskt: [1] Included Grommets: [2] Attached</p> 
<p>PF314 Fuel Element Fits: Ford Light-Duty Trucks, Vans Replaces: Ford E6TZ-9365-A O.D.: 2 3/4 (69.9) I.D.: 9/16 (14.3) One End Height: 1 1/2 (38.1) F. Gskt: [1] Included Grommets: [1] Attached</p> 	

Measurements Are Shown In Inches And (Millimeters)

WARNING: These products can expose you to chemicals, including Diisononyl Phthalate, Carbon black extracts, Nickel, 1,3 Butadiene, Ethylene Oxide, Epichlorohydrin, which are known to the State of California to cause cancer, and Bisphenol, Ethylene Glycol, Ethylene Oxide, 1,3 Butadiene, Epichlorohydrin, which are known to the State of California to cause birth defects or other reproductive harm. For more information go to www.P65Warnings.ca.gov.

PF316



Fuel/Water Separator Element with Bail Handle
Fits: Caterpillar, Cummins, Detroit Diesel, M.A.N. Engines; Grove Cranes
Replaces: Caterpillar 8N0205; Cummins 256559
O.D.: 5 27/32 (148.4)
I.D.: 31/32 (24.6)
Height: 8 3/4 (222.3)
A. Gskt: [1] Attached
F. Gskt: ES1036, [1] Included
Grommets: [2] Attached

BD325



Dual-Flow Lube Spin-on
Contains: 35 PSID By-Pass Valve
Fits: Allis Chalmers, Fiat-Allis, New Holland Equipment; Iveco Buses, Trucks
Replaces: Iveco 1903715
Thread: M30 x 2.0
O.D.: 4 1/4 (108.0)
Height: 8 7/16 (214.3)
I.Gskt: [1] Included

PT317-MPG



Maximum Performance Glass Hydraulic Element
Fits: Allison Transmissions
Replaces: GMC 23018850
O.D.: 3 3/32 (78.6)
I.D.: 1 11/16 (42.9) One End
Height: 12 7/8 (327.0)
O-Ring: [1] Attached

B326



Lube Spin-on
Contains: Anti-Drainback Valve
Fits: Volvo Loaders
Replaces: Volvo 4804406-9
Thread: 7/8 -16
O.D.: 4 1/4 (108.0)
Height: 7 3/8 (187.3)
I.Gskt: G401

PT318-MPG



Maximum Performance Glass Hydraulic Element
Fits: Allison Transmissions
Replaces: GMC 23018851
O.D.: 3 3/32 (78.6)
I.D.: 1 11/16 (42.9) One End
Height: 12 7/8 (327.0)
O-Ring: [1] Attached

B329



Lube Spin-on
Contains: Anti-Drainback Valve
 20 PSID By-Pass Valve
Fits: Chrysler, Ford, Mazda Automotive, Light-Duty Trucks, Vans
Replaces: Ford F1AZ-6731-A
Thread: M22 x 1.5
O.D.: 3 11/16 (93.7)
Height: 3 7/8 (98.4)
I.Gskt: G381-A

PT319-MPG



Maximum Performance Glass Hydraulic Element
Fits: Allison Transmissions
Replaces: GMC 23018852
O.D.: 3 25/32 (96.0)
I.D.: 2 3/16 (55.6) One End
Height: 16 13/16 (427.0)

BF330



Fuel Spin-on
Fits: Cummins, Komatsu Engines, Equipment
Replaces: Komatsu 6136-71-6120
Thread: 3/4 -16
O.D.: 3 1/32 (77.0)
Height: 5 7/8 (149.2)
I.Gskt: G449-B

PT320-MPG



Maximum Performance Glass Hydraulic Element
Fits: Allison Transmissions
Replaces: GMC 23018853
O.D.: 3 25/32 (96.0)
I.D.: 2 3/16 (55.6) One End
Height: 16 13/16 (427.0)
O-Ring: [1] Attached

PF332



Fuel Element
Fits: Hitachi Equipment; Isuzu, Yanmar Engines
Replaces: Hitachi 4514801
O.D.: 3 19/32 (91.3)
I.D.: 9/16 (14.3)
Height: 5 1/2 (139.7)
F. Gskt: [2] Included
Grommets: [2] Attached

BD324



Dual-Flow Lube Spin-on
Fits: Agco, Case, Fiat-Allis, Grove, Ingersoll-Rand, Komatsu, Link-Belt Equipment
Replaces: Case J919562
Thread: 2 1/4 -12
O.D.: 4 21/32 (118.3)
Height: 9 5/8 (244.5)
I.Gskt: G293-B
Related To: BD103 (Long Version)

B333



Full-Flow Lube Spin-on
Fits: Engines originally equipped with the BD103, which have since added an optional remote mount by-pass filter such as the Baldwin B7577 or BC110 centrifuge filter.
Thread: 2 1/4 -12
O.D.: 4 21/32 (118.3)
Height: 11 13/32 (289.7)
I.Gskt: G293-B

Measurements Are Shown In Inches And (Millimeters)

! **WARNING:** These products can expose you to chemicals, including Diisononyl Phthalate, Carbon black extracts, Nickel, 1,3 Butadiene, Ethylene Oxide, Epichlorohydrin, which are known to the State of California to cause cancer, and Bisphenol, Ethylene Glycol, Ethylene Oxide, 1,3 Butadiene, Epichlorohydrin, which are known to the State of California to cause birth defects or other reproductive harm. For more information go to www.P65Warnings.ca.gov.

BT334 Hydraulic or Lube Spin-on
Fits: Case, Hyundai, J.C. Bamford, Link-Belt, Volvo Equipment
Replaces: Link-Belt KNJ0288
Thread: 1 1/8 -16
O.D.: 3 11/16 (93.7)
Height: 5 3/8 (136.5)
I.Gskt: G381-A



B336 Lube Spin-on
Contains: Anti-Drainback Valve
 14 PSID By-Pass Valve
 Standpipe
Fits: Ford, New Holland, Versatile Tractors; Timberjack Equipment
Replaces: Ford E8NN-6714-BA
Thread: 3/4 -16
O.D.: 3 11/16 (93.7)
Height: 5 3/8 (136.5)
I.Gskt: G381-A



B337 By-Pass Lube Spin-on
Fits: Isuzu Engines; Link-Belt Equipment
Replaces: Isuzu 1-13240-123-0
Thread: M20 x 1.5
O.D.: 4 1/4 (108.0)
Height: 5 27/32 (148.4)
I.Gskt: [1] Included



BT338 By-Pass Lube Spin-on
Contains: Integral Post Seal
Fits: Caterpillar, Kobelco, MDI-Yutani Excavators; Mitsubishi Engines
Replaces: Mitsubishi ME014838
Thread: M18 x 1.5
O.D.: 3 11/16 (93.7)
Height: 3 7/8 (98.4)
I.Gskt: G324-A



BT339 Full-Flow Lube Spin-on
Notes: BT7349 may be used in place of BT339. Do NOT substitute BT339 for BT7349.
Fits: Ag-Chem, Case, Champion, Dresser, Dynapac, Fiat-Allis, Grove, Ingersoll-Rand, J.C. Bamford, Komatsu, Timberjack, Vermeer, White Equipment; Case, Cummins, DAF Engines
Replaces: Case J903264; Consolidated Diesel 3903264; Cummins 3914395
Thread: 1 -16
O.D.: 3 11/16 (93.7)
Height: 7 1/8 (181.0)
I.Gskt: G381-A
Related To: BT427 (Short Version)



BT340 By-Pass Lube Spin-on
Fits: Allis Chalmers Equipment
Replaces: Allis Chalmers 4036791
Thread: 1 1/8 -16
O.D.: 4 1/4 (108.0)
Height: 10 7/16 (265.1)
I.Gskt: [1] Included



BT341 By-Pass Lube Spin-on
Notes: Can be used with OB1305 base.
Contains: Flow Control Orifice
Fits: Bobcat, Case, Grove, International, Vermeer Equipment; Wisconsin Engines
Replaces: Wisconsin RV52
Thread: 5/8 -18
O.D.: 3 11/16 (93.7)
Height: 4 3/8 (111.1)
I.Gskt: G381-A
Related To: B50, B164 (Long Versions)



BT342 Hydraulic Spin-on
Contains: 20 PSID By-Pass Valve
Fits: Ford Tractors
Replaces: Ford C7NN-F933-A
Thread: 1 -12
O.D.: 3 11/16 (93.7)
Height: 6 5/8 (168.3)
I.Gskt: G381-A



BT343 Full-Flow Lube Spin-on
Contains: Anti-Drainback Valve
 18-20 PSID By-Pass Valve
Fits: Ford Equipment
Replaces: Ford D8NN-6714-DA
Thread: 1 1/8 -16
O.D.: 5 3/8 (136.5)
Height: 6 1/32 (153.2)
I.Gskt: [1] Included



BT344-S Hydraulic Spin-on
Contains: 20 PSID By-Pass Valve
Fits: Caterpillar, Daewoo Equipment
Replaces: Caterpillar 4T7948
Thread: 13/16 -16
O.D.: 3 23/32 (94.5)
Height: 4 15/32 (113.5)
I.Gskt: G401



BT345 KIT Set of 2 Hydraulic Spin-ons
Contains: 20 PSID By-Pass Valve
Fits: Case Tractors
Replaces: Case A161846 KIT
Thread: 1 1/2 -16
O.D.: 5 1/16 (128.6)
Height: 10 25/32 (273.8)
F. Gskt: [2] G483 (One Per Filter)
O. Gskt: G286-C, G369-V, G447, G483, G704, G710



BT346 Hydraulic Spin-on
Contains: 8 PSID By-Pass Valve
Fits: CMI Equipment; Mahindra Tractors
Replaces: Racine 493308
Thread: 1 -12
O.D.: 3 11/16 (93.7)
Height: 3 1/4 (82.6)
I.Gskt: G381-A



Measurements Are Shown In Inches And (Millimeters)

WARNING: These products can expose you to chemicals, including Diisononyl Phthalate, Carbon black extracts, Nickel, 1,3 Butadiene, Ethylene Oxide, Epichlorohydrin, which are known to the State of California to cause cancer, and Bisphenol, Ethylene Glycol, Ethylene Oxide, 1,3 Butadiene, Epichlorohydrin, which are known to the State of California to cause birth defects or other reproductive harm. For more information go to www.P65Warnings.ca.gov.

BT347



Full-Flow Lube Spin-on
Contains: Anti-Drainback Valve
 30 PSID By-Pass Valve
 Standpipe
Fits: Allis Chalmers, Antonio Carraro, Fiat,
 Ford, Hesston, New Holland Equipment;
 Iveco Engines, Trucks
Replaces: Fiat 1909101
Thread: 3/4 -16
O.D.: 4 1/4 (108.0)
Height: 7 11/32 (186.5)
I.Gskt: G381-A

BT348



Full-Flow Lube Spin-on
Contains: Anti-Drainback Valve
 30 PSID By-Pass Valve
 Standpipe
Fits: Allis Chalmers, Caterpillar, Fiat, Ford,
 Hesston, New Holland Equipment
Replaces: Fiat 1909102
Thread: 3/4 -16
O.D.: 4 1/4 (108.0)
Height: 5 13/16 (147.6)
I.Gskt: G381-A

BT349



Full-Flow Lube Spin-on
Contains: Anti-Drainback Valve
 20 PSID By-Pass Valve
Fits: Allis Chalmers, Astra, Case Equipment;
 Fiat, Iveco Engines
Replaces: Fiat 1909137
Thread: 1 -12
O.D.: 4 1/4 (108.0)
Height: 9 1/8 (231.8)
I.Gskt: G401

BT350



Hydraulic Spin-on
Fits: Allis Chalmers Equipment
Replaces: Allis Chalmers 267600
Thread: 13/16 -16
O.D.: 4 1/4 (108.0)
Height: 7 11/32 (186.5)
I.Gskt: G381-A

BT351



Hydraulic Spin-on
Notes: Can be used with OB1313, OB1314,
 OB1315 and OB1316 bases.
Fits: Aveling-Barford, Braud, J.C. Bamford,
 Liebherr, New Holland Equipment
Replaces: J.C. Bamford 32/901401
Thread: 1 1/4 -11 BSP-PL
O.D.: 5 (127.0)
Height: 7 3/32 (180.2)
I.Gskt: [1] Included
Related To: BT8450 (with Anti-Drainback
 Valve, 15 PSID By-Pass Valve)

BT351-MPG



Maximum Performance Glass Hydraulic Spin-on
Replaces: U.C.C. UCMXR9550; Fleetguard
 HF7980; Woodgate WGUC9550
Thread: 1 1/4 -11 BSP-PL
O.D.: 5 (127.0)
Height: 7 (177.8)
I.Gskt: [1] Included

P352



Lube Element
Fits: ERF Trucks; Leyland Buses, Trucks
Replaces: Leyland GL21779
O.D.: 3 3/16 (81.0)
I.D.: 7/16 (11.1)
Height: 8 9/16 (217.5)
Spring: [1] Attached
Grommets: [1] Attached

BT353



Full-Flow Lube Spin-on
Contains: Anti-Drainback Valve
 20 PSID By-Pass Valve
Fits: Allis Chalmers, Massey Ferguson
 Tractors
Replaces: Allis Chalmers 20797690-8;
 Massey Ferguson 3280185-M91
Thread: 3/4 -16
O.D.: 3 1/32 (77.0)
Height: 5 27/32 (148.4)
I.Gskt: [1] Included

BT354



Transmission Spin-on
Contains: 8 PSID By-Pass Valve
Fits: Ford, Massey Ferguson, New Holland
 Equipment
Replaces: Ford D8NN-B486-EA
Thread: 1 1/8 -16
O.D.: 3 11/16 (93.7)
Height: 5 3/8 (136.5)
I.Gskt: G381-A

BT355



Full-Flow Lube Spin-on
Contains: 20 PSID By-Pass Valve
Fits: Ford, New Holland Equipment
Replaces: Ford D8NN-6714-AA
Thread: 1 -12
O.D.: 4 1/4 (108.0)
Height: 5 7/8 (149.2)
I.Gskt: G401

P356



Lube Element
Fits: Bedford Buses, Trucks; Hymac, J.C.
 Bamford Equipment; Perkins Engines
Replaces: Perkins 26560076
O.D.: 3 21/32 (92.9)
I.D.: 1 11/32 (34.1)
Height: 6 (152.4)
F. Gskt: [1] Included
End Seals: [2] Attached

BT357



Hydraulic Spin-on
Contains: 2 PSID By-Pass Valve
Fits: International, New Holland Equipment
Replaces: International 404886-R1, 404886-R91
Thread: 1 -12
O.D.: 3 11/16 (93.7)
Height: 3 1/4 (82.6)
I.Gskt: G381-A

B358



Power Steering Spin-on
Contains: 2 PSID By-Pass Valve
Replaces: International 995285-C1
Thread: 13/16 -16
O.D.: 3 11/16 (93.7)
Height: 4 3/8 (111.1)
I.Gskt: G381-A

Measurements Are Shown In Inches And (Millimeters)



WARNING: These products can expose you to chemicals, including Diisononyl Phthalate, Carbon black extracts, Nickel, 1,3 Butadiene, Ethylene Oxide, Epichlorohydrin, which are known to the State of California to cause cancer, and Bisphenol, Ethylene Glycol, Ethylene Oxide, 1,3 Butadiene, Epichlorohydrin, which are known to the State of California to cause birth defects or other reproductive harm. For more information go to www.P65Warnings.ca.gov.

BT359

Transmission Spin-on



Fits: Allison Transmissions
Replaces: GMC 25010335
Thread: 1 5/16 -12
O.D.: 4 5/8 (117.5)
Height: 10 9/32 (261.1)
I.Gskt: [1] Included

BT366-10

Hydraulic Spin-on



Fits: Bedford, J.C. Bamford, New Holland, Thwaites Equipment; U.C.C. Hydraulic Systems
Replaces: U.C.C. UC-MS1518-4-10
Thread: 3/4 -14 BSP-PL
O.D.: 3 11/16 (93.7)
Height: 5 13/32 (137.3)
I.Gskt: G401

B360

Full-Flow Lube Spin-on



Contains: Anti-Drainback Valve
Fits: Mercruiser Marine Engines
Replaces: Quicksilver 14957
Thread: 13/16 -16
O.D.: 3 13/16 (96.8)
Height: 4 3/8 (111.1)
I.Gskt: [1] Included

BT366-MPG

Maximum Performance Glass Hydraulic Spin-on



Replaces: U.C.C. UCMXR8550; Fleetguard HF7983; Woodgate WGUC8550
Thread: 3/4 -14 BSP-PL
O.D.: 3 25/32 (96.0)
Height: 5 23/32 (145.3)
I.Gskt: [1] Included

BT361

Hydraulic Spin-on



Contains: 8 PSID By-Pass Valve
Fits: Cessna Hydraulic Systems; Owatonna Equipment
Replaces: Cessna Fluid Power 62200G
Thread: 7/8 -14
O.D.: 3 11/16 (93.7)
Height: 5 3/8 (136.5)
I.Gskt: G381-A

BT367

Air Breather Spin-on



Fits: Steiger Equipment
Replaces: Steiger 18-1633
Thread: 1 1/8 -16
O.D.: 3 11/16 (93.7)
Height: 4 11/32 (110.3)
O. Gskt: ES3028

BT364

Full-Flow Lube or Hydraulic Spin-on



Contains: 20 PSID By-Pass Valve
Fits: Ag-Chem, Caterpillar, CMI, Dynapac, Grove, New Holland, White Equipment; Caterpillar Engines; Ford, GMC, International, Mack, WhiteGMC Trucks
Replaces: Caterpillar 9N5680, 1R0734
Thread: 1 -12
O.D.: 3 11/16 (93.7)
Height: 5 3/8 (136.5)
I.Gskt: G381-A

BT367-S

Air Breather Spin-on



Fits: Liebherr, McNeilus, Vermeer Equipment
Replaces: Schroeder ABF3/10 (without Adapter)
Thread: 1 1/8 -16
O.D.: 3 11/16 (93.7)
Height: 3 7/32 (81.8)
O. Gskt: ES3028
Related To: B7024 (with Adapter)

BT365

Lube or Hydraulic Spin-on



Fits: Case, Hydra-Mac, Perkins Engines, Equipment; Thermo King Refrigeration Units
Replaces: Hydra-Mac 3408-305; Thermo King 11-3712
Thread: 1 -12
O.D.: 3 11/16 (93.7)
Height: 7 3/16 (182.6)
I.Gskt: G401

BT368

Air Breather Spin-on



Fits: Allis Chalmers Optional Equipment
Replaces: Allis Chalmers 4835378
Thread: 3/4 -14 BSP-PL
O.D.: 3 11/16 (93.7)
Height: 3 7/32 (81.8)

BT365-10

Lube or Hydraulic Spin-on



Fits: Hydra-Mac Equipment
Replaces: Hydra-Mac 1309-108
Thread: 1 -12
O.D.: 3 11/16 (93.7)
Height: 7 3/16 (182.6)
I.Gskt: G401

B369

Air Breather Spin-on



Replaces: Mack 2MD3131
Thread: 3/4 -20
O.D.: 3 11/16 (93.7)
Height: 4 3/8 (111.1)
I.Gskt: G381-A

PT370

Hydraulic Element



Fits: Massey Ferguson Industrial Equipment
Replaces: Massey Ferguson 1430492-M92
O.D.: 6 25/32 (172.2)
I.D.: 4 7/32 (107.2)
Height: 15 5/16 (388.9)
A. Gskt: [2] Attached

Measurements Are Shown In Inches And (Millimeters)

WARNING: These products can expose you to chemicals, including Diisononyl Phthalate, Carbon black extracts, Nickel, 1,3 Butadiene, Ethylene Oxide, Epichlorohydrin, which are known to the State of California to cause cancer, and Bisphenol, Ethylene Glycol, Ethylene Oxide, 1,3 Butadiene, Epichlorohydrin, which are known to the State of California to cause birth defects or other reproductive harm. For more information go to www.P65Warnings.ca.gov.

BT371-10



Hydraulic or Transmission Spin-on
Fits: Case, International, John Deere, New Holland Equipment
Replaces: Hyster 27749012; John Deere AE37594; Pall HC9540SUJ4H
Thread: 1 1/2 -16
O.D.: 3 13/16 (96.8)
Height: 5 13/32 (137.3)
I.Gskt: [1] Included
Related To: BT372-10, BT372-MPG (Long Versions)

BT371-5



Hydraulic Spin-on
Replaces: Woodgate WGH6606
Thread: 1 1/2 -16
O.D.: 3 25/32 (96.0)
Height: 5 23/32 (145.3)
I.Gskt: [1] Included

BT371-MPG



Maximum Performance Glass Hydraulic or Transmission Spin-on
Fits: Case, International, John Deere, New Holland Equipment
Replaces: Pall HC7400SUT4H
Thread: 1 1/2 -16
O.D.: 3 13/16 (96.8)
Height: 5 13/32 (137.3)
I.Gskt: [1] Included
Related To: BT372-10, BT372-MPG (Long Versions)

BT372-10



Hydraulic or Transmission Spin-on
Fits: Caterpillar, Dresser, Galion, Gehl, International Equipment
Replaces: Caterpillar 3T8642; Galion 149661; International 562871-C91; John Deere AT63557
Thread: 1 1/2 -16
O.D.: 3 11/16 (93.7)
Height: 8 1/16 (204.8)
I.Gskt: [1] Included
Related To: BT371-10, BT371-MPG (Short Versions)

BT372-MPG



Maximum Performance Glass Hydraulic or Transmission Spin-on
Fits: International, John Deere, Mustang, Owatonna Equipment
Replaces: John Deere AT69852, AT73307
Thread: 1 1/2 -16
O.D.: 3 11/16 (93.7)
Height: 8 1/16 (204.8)
I.Gskt: [1] Included
Related To: BT371-10, BT371-MPG (Short Versions)

PT373



Hydraulic Element
Fits: Massey Ferguson Equipment
Replaces: Massey Ferguson 516069-M94
O.D.: 4 1/2 (114.3)
I.D.: 1 29/32 (48.4)
Height: 7 (177.8)
F. Gskt: G236-A, G292, [2] ES1092
O. Gskt: ES3029

PT374



Hydraulic Element
Contains: 20 PSID By-Pass Valve
Fits: Allison Transmissions; Versatile Equipment
Replaces: Versatile SW6502
O.D.: 3 15/32 (88.1)
I.D.: 1 11/32 (34.1) One End
Height: 4 23/32 (119.9)
F. Gskt: [2] Included

PT375



Hydraulic Element
Contains: 20 PSID By-Pass Valve
Fits: New Holland, Versatile Equipment
Replaces: Versatile 36169
O.D.: 3 15/32 (88.1)
I.D.: 1 11/32 (34.1) One End
Height: 9 3/16 (233.4)
F. Gskt: [2] Included

PT376



Transmission Element
Contains: Reinforced Centertube
Fits: Dresser, Hough, International Equipment
Replaces: International 1140079-C1
O.D.: 4 1/2 (114.3)
I.D.: 2 1/4 (57.2)
Height: 9 3/16 (233.4)
O. Gskt: G211
End Seals: [2] Attached

PT377



Hydraulic Element
Fits: Michigan Fluid Power Systems
Replaces: Michigan Fluid Power C69
O.D.: 3 1/32 (77.0)
I.D.: 1 1/4 (31.8) One End
Height: 6 15/32 (164.3)
F. Gskt: G458
End Seals: [1] Attached

PT377-10



Hydraulic Element
Fits: Michigan Fluid Power Systems
Replaces: Michigan Fluid Power C68
O.D.: 3 1/32 (77.0)
I.D.: 1 1/4 (31.8) One End
Height: 6 15/32 (164.3)
F. Gskt: G458
End Seals: [1] Attached

B378



Full-Flow Lube Spin-on
Fits: Gardner Denver, Ingersoll-Rand, LeRoi Compressors; Volvo, Yanmar Equipment
Replaces: Ingersoll-Rand 35296920
Thread: 1 1/4 -12
O.D.: 3 11/16 (93.7)
Height: 8 23/32 (221.5)
I.Gskt: G381-A
O. Gskt: G401

Measurements Are Shown In Inches And (Millimeters)

WARNING: These products can expose you to chemicals, including Diisononyl Phthalate, Carbon black extracts, Nickel, 1,3 Butadiene, Ethylene Oxide, Epichlorohydrin, which are known to the State of California to cause cancer, and Bisphenol, Ethylene Glycol, Ethylene Oxide, 1,3 Butadiene, Epichlorohydrin, which are known to the State of California to cause birth defects or other reproductive harm. For more information go to www.P65Warnings.ca.gov.

B378-10



Full-Flow Lube or Hydraulic Spin-on
Fits: Gardner Denver, Ingersoll-Rand, LeRoi Compressors; Volvo, Yanmar Equipment
Replaces: Gardner Denver 2109412; Ingersoll-Rand 39138433
Thread: 1 1/4 -12
O.D.: 3 11/16 (93.7)
Height: 8 23/32 (221.5)
I.Gskt: G381-A
O. Gskt: G401

PT379 KIT



Set of 2 Hydraulic Elements
Fits: International Tractors
Replaces: International 133736-C1
O.D.: 5 (127.0)
I.D.: 2 15/16 (74.6)
Height: 3 (76.2)
F. Gskt: G368

PT380 KIT



Set of 2 Hydraulic Elements
Contains: Reinforced Centertube
Fits: Case Tractors
Replaces: Case A46403 Kit
O.D.: 4 1/2 (114.3)
I.D.: 2 9/32 (57.9)
Height: 7 1/8 (181.0)
F. Gskt: [1] Included for Stacked Elements
O. Gskt: G305 for Side-By-Side Elements
End Seals: [2] Attached to Each Element

PT381



Hydraulic Element
Notes: Inside-Out Flow Direction
Fits: Caterpillar Lift Trucks
Replaces: Towmotor 349804
O.D.: 4 1/2 (114.3)
I.D.: 2 1/4 (57.2)
Height: 9 (228.6)

PT382



Hydraulic Element
Replaces: Tennant 51885
O.D.: 2 7/8 (73.0)
I.D.: 1 5/16 (33.3) One End
Height: 4 3/8 (111.1)
End Seals: [1] Attached

PT383



Hydraulic Element
Fits: John Deere Equipment
Replaces: John Deere AH91274
O.D.: 5 (127.0)
I.D.: 2 13/16 (71.4)
Height: 6 3/16 (157.2)
O. Gskt: G263
End Seals: [2] Attached

PT385



Transmission Element with Gaskets
Fits: ACDelco Housings; Allis Chalmers, Case, Euclid, Steiger, Terex, Volvo, WABCO Equipment
Replaces: Euclid 6439400; Fiat 70197121; Volvo 66175068; WABCO PB5038
O.D.: 4 7/16 (112.7)
I.D.: 1 1/2 (38.1)
Height: 9 1/16 (230.2)
F. Gskt: G115-MSB, G211, ES1071
End Seals: [2] Attached
Related To: P20-HD (Lube Version)

PT385-E



Transmission Element without Gaskets
Fits: Allis Chalmers, Case, Galion, Grove, Hough, Letourneau, Link-Belt, Michigan, Terex, WABCO Equipment
Replaces: Euclid 6439400; Fiat 70197121; Volvo 66175068; WABCO PB5038
O.D.: 4 7/16 (112.7)
I.D.: 1 1/2 (38.1)
Height: 9 1/16 (230.2)
End Seals: [2] Attached
Related To: P20-HD (Lube Version)

PT386



Hydraulic Element
Contains: Reinforced Centertube
Fits: Hough Equipment
Replaces: International 927535-C91
O.D.: 4 1/2 (114.3)
I.D.: 1 25/32 (45.2)
Height: 11 (279.4)
F. Gskt: [3] Included
End Seals: [2] Attached

BT387



Hydraulic Spin-on
Notes: Can be used with OB1313, OB1314, OB1315, OB1316 bases.
Fits: Gresen Hydraulic Systems; Sellick, Toro Equipment
Replaces: Gresen 7521001
Thread: 1 1/2 -16
O.D.: 5 1/32 (127.8)
Height: 7 (177.8)
F. Gskt: G286-C
O. Gskt: G369-B, G369-V, G372, G447, G483, G704, G710
Related To: BT388, BT388-10 (Long Versions)

BT387-10



Hydraulic Spin-on
Notes: Can be used with OB1313, OB1314, OB1315, OB1316 bases.
Fits: Gresen Hydraulic Systems; Sellick, Toro Equipment
Replaces: Cross 1A9251; Gresen 7521001
Thread: 1 1/2 -16
O.D.: 5 1/32 (127.8)
Height: 7 (177.8)
F. Gskt: G286-C
O. Gskt: G369-B, G369-V, G372, G447, G483, G704, G710
Related To: BT388, BT388-10 (Long Versions)

Measurements Are Shown In Inches And (Millimeters)

WARNING: These products can expose you to chemicals, including Diisononyl Phthalate, Carbon black extracts, Nickel, 1,3 Butadiene, Ethylene Oxide, Epichlorohydrin, which are known to the State of California to cause cancer, and Bisphenol, Ethylene Glycol, Ethylene Oxide, 1,3 Butadiene, Epichlorohydrin, which are known to the State of California to cause birth defects or other reproductive harm. For more information go to www.P65Warnings.ca.gov.

BT388



Hydraulic Spin-on

Notes: Can be used with OB1313, OB1314, OB1315, OB1316 bases.
Fits: Champion, Rexworks Equipment; Cross Hydraulic Systems
Thread: 1 1/2 -16
O.D.: 5 1/32 (127.8)
Height: 10 3/4 (273.1)
F. Gskt: G286-C
O. Gskt: G369-B, G369-V, G372, G447, G483, G704, G710
Related To: BT387, BT387-10 (Short Versions)

BT388-10



Hydraulic Spin-on

Notes: Can be used with OB1313, OB1314, OB1315, OB1316 bases.
Fits: Cross Hydraulic Systems
Replaces: Cross 1A9253
Thread: 1 1/2 -16
O.D.: 5 1/32 (127.8)
Height: 10 3/4 (273.1)
F. Gskt: G286-C
O. Gskt: G369-B, G369-V, G372, G447, G483, G704, G710
Related To: BT387, BT387-10 (Short Versions)

BT389



Hydraulic Spin-on

Fits: Bandit, Case, Koehring Equipment; Special AMBAC Base
Replaces: Zinga LE10
Thread: 1 1/2 -16
O.D.: 5 1/16 (128.6)
Height: 10 3/4 (273.1)
F. Gskt: G372
O. Gskt: G286-C, G369-B, G369-V, G372, G447, G483, G704, G710, G725

BT389-10



Hydraulic Spin-on

Fits: Bandit, Case, Koehring Equipment; Special AMBAC Base
Replaces: Zinga LE10
Thread: 1 1/2 -16
O.D.: 5 1/16 (128.6)
Height: 10 3/4 (273.1)
F. Gskt: G369-B
O. Gskt: G286-C, G369-B, G369-V, G372, G447, G483, G704, G710, G725

PT390-MPG



Maximum Performance Glass Hydraulic Element

Contains: Reinforced Centertube
Fits: John Deere Equipment
Replaces: John Deere AR94510
O.D.: 4 9/16 (115.9)
I.D.: 2 7/32 (56.4)
Height: 7 31/32 (202.4)
O. Gskt: G397
End Seals: [2] Attached

PT391-MPG



Maximum Performance Glass Hydraulic Element

Contains: Reinforced Centertube
Fits: John Deere Equipment
Replaces: John Deere AR98098
O.D.: 4 9/16 (115.9)
I.D.: 2 7/32 (56.4)
Height: 7 31/32 (202.4)
O. Gskt: G397
End Seals: [2] Attached

PT392



Differential Element

Fits: Allis Chalmers Tractors
Replaces: Allis Chalmers 270781
O.D.: 5 (127.0)
I.D.: 2 13/16 (71.4)
Height: 6 1/8 (155.6)
F. Gskt: [2] Included
End Seals: [2] Attached

PT393



Hydraulic Element

Fits: Allis Chalmers Tractors
Replaces: Allis Chalmers 270782
O.D.: 5 (127.0)
I.D.: 2 15/16 (74.6)
Height: 9 (228.6)
F. Gskt: [2] Included

PT394-15



Hydraulic Element

Replaces: Ingersoll-Rand 39101704
O.D.: 6 1/32 (153.2)
I.D.: 1 23/32 (43.7)
Height: 7 5/8 (193.7)
O. Gskt: G193
End Seals: [2] Attached
Related To: P194 Series (Micron Difference)

PT394-5



Hydraulic Element

Replaces: Ingersoll-Rand 39101704
O.D.: 6 1/32 (153.2)
I.D.: 1 23/32 (43.7)
Height: 7 5/8 (193.7)
O. Gskt: G193
End Seals: [2] Attached
Related To: P194 Series (Micron Difference)

BT395



Hydraulic Spin-on

Contains: 20 PSID By-Pass Valve
Fits: Dresser, International Equipment
Replaces: International 709014-C1
Thread: 7/8 -14
O.D.: 3 11/16 (93.7)
Height: 5 3/8 (136.5)
I.Gskt: G381-A

PT396



Hydraulic Element

Contains: Spring Reinforced Centertube
Fits: Komatsu Equipment
Replaces: Komatsu 101-60-15171
O.D.: 2 9/16 (65.1)
I.D.: 1 3/32 (27.8)
Height: 5 5/8 (142.9)

Measurements Are Shown In Inches And (Millimeters)



WARNING: These products can expose you to chemicals, including Diisononyl Phthalate, Carbon black extracts, Nickel, 1,3 Butadiene, Ethylene Oxide, Epichlorohydrin, which are known to the State of California to cause cancer, and Bisphenol, Ethylene Glycol, Ethylene Oxide, 1,3 Butadiene, Epichlorohydrin, which are known to the State of California to cause birth defects or other reproductive harm. For more information go to www.P65Warnings.ca.gov.

PT397

Hydraulic Element



Fits: Kobelco, Komatsu Equipment
Replaces: Komatsu 195-60-16320
O.D.: 5 29/32 (150.0)
I.D.: 4 11/32 (110.3)
Height: 11 13/16 (300.0)

B404

Full-Flow Lube Spin-on



Fits: Hino Trucks
Replaces: Hino 15607-1670
Thread: 1 1/2 -12
O.D.: 4 21/32 (118.3)
Height: 6 1/4 (158.8)
I.Gskt: G498-A

BT398

Hydraulic Spin-on



Fits: Komatsu Equipment; Nissan Trucks
Replaces: Komatsu 113-60-23160
Thread: 1 1/8 -16
O.D.: 4 1/4 (108.0)
Height: 9 1/8 (231.8)
I.Gskt: [1] Included

JC405

Cotton and Fiber By-Pass Lube Sock with Pull-Out Bail Handle



Fits: Clark Lift Trucks; Dodge Trucks; Hercules Engines
Replaces: Chrysler 1504092; Clark 955290
O.D.: 4 (101.6)
I.D.: 9/16 (14.3) & 1 5/16 (33.3)
Height: 5 1/4 (133.4)
F. Gskt: G127
End Seals: [1] Attached

PT400

Hydraulic Element



Fits: J.C. Bamford, Kobelco, Komatsu, Takeuchi Equipment
Replaces: Komatsu 198-49-11440
O.D.: 4 13/32 (111.9)
I.D.: 2 3/4 (69.9)
Height: 11 9/16 (293.7)

CU406

Cotton and Fiber By-Pass Lube Sock with Pull-Out Bail Handle



Fits: ACF-Brill, Aero Coach, Beaver, Brockway, Duplex Buses; International, WhiteGMC Trucks; Allis Chalmers, Barber-Greene, Bucyrus-Erie, Clark, Grove, Hough, International, Link-Belt Equipment
Replaces: ACF-Brill 275633; Beaver 70609H; Brockway 106704; International 649729-R93; White 1267529
O.D.: 4 1/8 (104.8)
I.D.: 9/16 (14.3) & 1 13/16 (46.0)
Height: 5 1/2 (139.7)
F. Gskt: [1] Included
O. Gskt: G127
End Seals: [1] Attached

PT401-MPG

Maximum Performance Glass Hydraulic Element



Fits: Case Dozers; Dresser Loggers, Pay Loaders; Hough Wheel Loaders
Replaces: Case D83130; International 930654-C1
O.D.: 4 1/2 (114.3)
I.D.: 1 25/32 (45.2)
Height: 9 1/8 (231.8)
O. Gskt: G292
End Seals: [2] Attached

DF408

Cotton and Fiber By-Pass Lube Sock with Pull-Out Bail Handle



Fits: Oshkosh Trucks; Adams, Bucyrus-Erie, Euclid, Ingersoll-Rand, Schramm Equipment; Allis Chalmers, Waukesha Engines
Replaces: Allis Chalmers 4041082; Bucyrus-Erie P70162; Euclid 9045063
O.D.: 5 3/4 (146.1)
I.D.: 7/8 (22.2) & 1 9/16 (39.7)
Height: 10 (254.0)
F. Gskt: G148
End Seals: [1] Attached

BT402

Full-Flow Lube Spin-on



Contains: 30 PSID By-Pass Valve
Replaces: Mitsubishi 3254001600; Onan 1220774
Thread: 1 1/8 -16
O.D.: 4 1/4 (108.0)
Height: 9 1/8 (231.8)
I.Gskt: [1] Included

TC413-CPE5

All Cotton Sock Element with Bail Handle



Notes: Cotton sock for most non-acid fluids, flowing at moderate temperatures.
Contains: Spring Reinforced Centertube
Replaces: Peco FT318C5, FTE318C5
O.D.: 3 (76.2)
I.D.: 3/4 (19.1) & 1 11/16 (42.9)
Height: 19 1/2 (495.3)

B403

Full-Flow Lube Spin-on



Contains: Anti-Drainback Valve
50 PSID By-Pass Valve
Fits: R.V.I., Volvo Buses, Trucks; Renault Engines
Replaces: Renault 5000670670
Thread: 1 -12
O.D.: 3 11/16 (93.7)
Height: 8 1/8 (206.4)
I.Gskt: G381-A

V414-B

Vac-Cel By-Pass Lube Sock



Fits: Bowser-Briggs Housings
Replaces: Bowser-Briggs A414 with A413 Holder
O.D.: 6 3/16 (157.2)
I.D.: 2 7/32 (56.4)
Height: 15 1/2 (393.7)

Measurements Are Shown In Inches And (Millimeters)

WARNING: These products can expose you to chemicals, including Diisononyl Phthalate, Carbon black extracts, Nickel, 1,3 Butadiene, Ethylene Oxide, Epichlorohydrin, which are known to the State of California to cause cancer, and Bisphenol, Ethylene Glycol, Ethylene Oxide, 1,3 Butadiene, Epichlorohydrin, which are known to the State of California to cause birth defects or other reproductive harm. For more information go to www.P65Warnings.ca.gov.

V414-FF



Vac-Cel Dual-Stage Full-Flow Lube Sock
Fits: Bowser-Briggs Housings
Replaces: Bowser-Briggs A414 with A413 Holder
O.D.: 6 3/16 (157.2)
I.D.: 2 7/32 (56.4)
Height: 15 1/2 (393.7)

F415-B



Special Vac-Cel Fuel Sock
Notes: Use ONLY as a fuel filter on Bowser-Briggs, Commercial, Hilco, Nugent, Winslow applications.
O.D.: 6 3/16 (157.2)
I.D.: 2 13/32 (61.1)
Height: 18 (457.2)

P415-10



Full-Flow Lube Element with Bail Handle
Replaces: Commercial D4674
O.D.: 6 (152.4)
I.D.: 2 1/8 (54.0)
Height: 18 (457.2)
O. Gskt: G309-B
End Seals: [2] Attached

P415-10A



Full-Flow Lube Element with Bail Handle
Replaces: Large Center Hole Bowser-Briggs BP718
O.D.: 6 (152.4)
I.D.: 2 5/8 (66.7)
Height: 18 (457.2)
O. Gskt: G309-B
End Seals: [2] Attached

P415-25



Full-Flow Lube Element with Bail Handle
Replaces: Commercial D4674
O.D.: 6 (152.4)
I.D.: 2 1/8 (54.0)
Height: 18 (457.2)
O. Gskt: G309-B
End Seals: [2] Attached

P415-25A



Full-Flow Lube Element with Bail Handle
Replaces: Large Center Hole Bowser-Briggs BP718
O.D.: 6 (152.4)
I.D.: 2 5/8 (66.7)
Height: 18 (457.2)
O. Gskt: G309-B
End Seals: [2] Attached

P415-5



Full-Flow Lube Element with Bail Handle
Replaces: Commercial D4674
O.D.: 6 (152.4)
I.D.: 2 1/8 (54.0)
Height: 18 (457.2)
O. Gskt: G309-B
End Seals: [2] Attached

P415-5A



Full-Flow Lube Element with Bail Handle
Replaces: Large Center Hole Bowser-Briggs BP718
O.D.: 6 (152.4)
I.D.: 2 5/8 (66.7)
Height: 18 (457.2)
O. Gskt: G309-B
End Seals: [2] Attached

P415-5AN



Full-Flow Lube Element with Neoprene End Seals and Bail Handle
Replaces: Bowser-Briggs BP718
O.D.: 6 (152.4)
I.D.: 2 5/8 (66.7)
Height: 17 3/4 (450.9)
O. Gskt: G309-B
End Seals: [2] Attached

P415-GM



GM Version Full-Flow Lube Element with Bail Handle
Contains: Spring Reinforced Centertube
Replaces: Large Center Hole Bowser-Briggs BP718
O.D.: 6 17/32 (165.9)
I.D.: 2 17/32 (64.3)
Height: 18 (457.2)
O. Gskt: G309-B
End Seals: [2] Attached

V415-B



Vac-Cel By-Pass Lube Sock
Fits: Bowser-Briggs, Commercial, Hilco, Winslow Housings
O.D.: 6 3/16 (157.2)
I.D.: 2 13/32 (61.1)
Height: 18 (457.2)

V415-FF



Vac-Cel Dual-Stage Full-Flow Lube Sock
Fits: Bowser-Briggs, Commercial, Hilco, Winslow Housings
Replaces: Allis Chalmers 4369208, 4369208-8; Bowser-Briggs A418; Fiat 74369208; General Motors 6438006; White A014040
O.D.: 6 3/16 (157.2)
I.D.: 2 13/32 (61.1)
Height: 18 (457.2)

Measurements Are Shown In Inches And (Millimeters)



WARNING: These products can expose you to chemicals, including Diisononyl Phthalate, Carbon black extracts, Nickel, 1,3 Butadiene, Ethylene Oxide, Epichlorohydrin, which are known to the State of California to cause cancer, and Bisphenol, Ethylene Glycol, Ethylene Oxide, 1,3 Butadiene, Epichlorohydrin, which are known to the State of California to cause birth defects or other reproductive harm. For more information go to www.P65Warnings.ca.gov.

PT416

Hydraulic Element

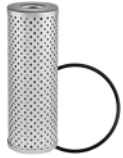

Fits: Oliver Tractors; White Equipment
Replaces: Oliver 165442-A
O.D.: 1 31/32 (50.0)
I.D.: 29/32 (23.0) One End
Height: 5 9/16 (141.3)
F. Gskt: G247
End Seals: [1] Attached

BT425

Hydraulic Spin-on



Contains: 9 PSID By-Pass Valve
 By-Pass Screen
Fits: Ford Tractors
Replaces: Ford D8NN-M903-EA,
 D8NN-F914-AA
Thread: 1 1/2 -16
O.D.: 5 1/16 (128.6)
Height: 8 15/16 (227.0)
I.Gskt: [1] Included

PT418

Hydraulic Element



Notes: Inside-Out Flow Direction
Fits: International Equipment
Replaces: International 666220-C1
O.D.: 6 1/2 (165.1)
I.D.: 5 1/2 (139.7)
Height: 15 3/32 (383.4)

PT426

Hydraulic Element



Fits: John Deere Equipment
Replaces: Marvel M3401-5110
O.D.: 4 1/2 (114.3)
I.D.: 2 1/4 (57.2) One End
Height: 7 1/4 (184.2)
I.Gskt: [1] Included
F. Gskt: G397

BT420

Transmission Spin-on



Contains: Anti-Drainback Valve
 8 PSID By-Pass Valve
Fits: Hyster Lift Trucks
Replaces: Hyster 309112
Thread: 3/4 -16
O.D.: 3 11/16 (93.7)
Height: 4 15/32 (113.5)
I.Gskt: G401

BT427

Full-Flow Lube Spin-on



Fits: Agco, Bandit, Bomag, Case, Dresser,
 Dynapac, Grove, Komatsu, MacDon, Vermeer
 Equipment; Cummins Engines
Replaces: Cummins 3903224
Thread: 1 -16
O.D.: 3 11/16 (93.7)
Height: 5 3/8 (136.5)
I.Gskt: [1] Included
Related To: BT339 (Long Version)

B421

Lube Spin-on



Contains: Anti-Drainback Valve
 14 PSID By-Pass Valve
Fits: Isuzu Automotive
Replaces: Isuzu 8-94430-411-1
Thread: M20 x 1.5
O.D.: 3 (76.2)
Height: 2 27/32 (72.2)
I.Gskt: [1] Included

V429-B

Vac-Cel Standard-Flow Lube Sock



Replaces: Michiana 12900, 17800, 17900
O.D.: 6 3/16 (157.2)
I.D.: 2 1/2 (63.5)
Height: 29 1/4 (743.0)

S423

Resin Ribbon Hydraulic Breather Element



Notes: Element is also in PT181 KIT.
Fits: Bantam Carriers, Cranes; Case Loaders,
 Tractors; LeRoi Compressors; McCoy Dump
 Boxes
Replaces: Bendix R32-20; Case A10059;
 Hyster 78122
O.D.: 2 (50.8)
I.D.: 1 5/8 (41.3)
Height: 1 1/4 (31.8)

V429-FF

Vac-Cel Dual-Stage Fast-Flow Lube Sock



Replaces: Michiana 12900, 17800, 17900
O.D.: 6 3/16 (157.2)
I.D.: 2 1/2 (63.5)
Height: 29 1/4 (743.0)

BT424

Hydraulic Spin-on



Contains: 10 PSID By-Pass Valve
 By-Pass Screen
Fits: Ford Tractors
Replaces: Ford D8NN-F914-BA,
 D8NN-F914-CA, D8NN-M903-AA,
 D8NN-M903-FA
Thread: 1 1/2 -16
O.D.: 5 1/32 (127.8)
Height: 6 31/32 (177.0)
F. Gskt: G369
O. Gskt: G369-V, G704, G710

PT430-FF

All Fluids Element



Fits: Bowser-Briggs Optional Filter Housings;
 Hill Diesel Engines
Replaces: Bowser-Briggs BP518-1;
 Commercial 100257
O.D.: 4 1/2 (114.3)
I.D.: 1 25/32 (45.2)
Height: 18 1/8 (460.4)
End Seals: [2] Attached

PT431

All Fluids Element



Fits: Nugent Optional Filter Housings
Replaces: Nugent 1555D1R
O.D.: 4 31/32 (126.2)
I.D.: 1 9/16 (39.7)
Height: 9 1/16 (230.2)
F. Gskt: G164-A
O-Ring: [2] Included
Related To: PT490 (Double-Length Version)

Measurements Are Shown In Inches And (Millimeters)

WARNING: These products can expose you to chemicals, including Diisononyl Phthalate, Carbon black extracts, Nickel, 1,3 Butadiene, Ethylene Oxide, Epichlorohydrin, which are known to the State of California to cause cancer, and Bisphenol, Ethylene Glycol, Ethylene Oxide, 1,3 Butadiene, Epichlorohydrin, which are known to the State of California to cause birth defects or other reproductive harm. For more information go to www.P65Warnings.ca.gov.

PT433

Hydraulic Element



Fits: John Deere Equipment
Replaces: John Deere AT79080
O.D.: 4 1/2 (114.3)
I.D.: 1 25/32 (45.2)
Height: 7 1/8 (181.0)
O. Gskt: G236-A, G385, G386, G292
End Seals: [2] Attached

BT438

Hydraulic Spin-on



Fits: Case, Hesston Equipment
Replaces: Hesston 8040461
Thread: 13/16 -16
O.D.: 3 23/32 (94.5)
Height: 5 15/32 (138.9)
I.Gskt: G401

PT434

Hydraulic Element



Notes: NOT interchangeable with PT477 or PT492.
Fits: Case, Hough, International Equipment
Replaces: Case D71352; International 185531-H1
O.D.: 2 5/8 (66.7)
I.D.: 1 7/32 (31.0) One End
Height: 4 13/16 (122.2)
F. Gskt: G247
End Seals: [1] Attached

PT439

Hydraulic Element



Contains: Reinforced Centertube
Fits: Joy Compressors
Replaces: Joy 1139451; Parker 862F
O.D.: 2 3/4 (69.9)
I.D.: 1 1/4 (31.8)
Height: 8 5/8 (219.1)
F. Gskt: [2] Included

PT434-10

Hydraulic Element



Notes: NOT interchangeable with PT477 or PT492.
Fits: Case, Hough, International Equipment
Replaces: Case D71352; International 185531-H1
O.D.: 2 5/8 (66.7)
I.D.: 1 7/32 (31.0) One End
Height: 4 13/16 (122.2)
F. Gskt: G247
End Seals: [1] Attached

BT440

Full-Flow Lube Spin-on



Fits: Allis Chalmers Engines, Equipment
Replaces: Allis Chalmers 4037047
Thread: 1 -16
O.D.: 4 1/4 (108.0)
Height: 7 11/32 (186.5)
I.Gskt: G381-A
Related To: BT564 (Short Version)

PT435

Hydraulic Element



Fits: Case, International Equipment
Replaces: Case G13113
O.D.: 2 5/16 (58.7)
I.D.: 1 11/32 (34.1)
Height: 6 (152.4)
O. Gskt: G173-C

PT441

Hydraulic Element



Contains: Spring Reinforced Centertube
Fits: Fai, Komatsu Equipment
Replaces: Komatsu 130-60-48210
O.D.: 2 9/16 (65.1)
I.D.: 1 3/32 (27.8)
Height: 10 29/32 (277.0)

PT436

Hydraulic or Lube Element



Contains: Reinforced Centertube
Fits: Bowser-Briggs Optional Housings; Allis Chalmers, Fiat-Allis, International Equipment
Replaces: Allis Chalmers 6407803; Bowser-Briggs BP509-2; International 172595-H1
O.D.: 4 1/2 (114.3)
I.D.: 1 25/32 (45.2)
Height: 9 1/16 (230.2)
F. Gskt: [3] Included
End Seals: [2] Attached

PT442-MPG

Maximum Performance Glass Hydraulic Element



Notes: Inside-Out Flow Direction
Fits: John Deere Equipment
Replaces: John Deere AT78414
O.D.: 4 17/32 (115.1)
I.D.: 2 1/4 (57.2)
Height: 8 3/32 (205.6)
End Seals: [2] Attached

PT437

Hydraulic Element



Fits: Cessna Hydraulic Systems; New Holland, Oliver, White Equipment
Replaces: Cessna 62300S; New Holland 86546065; White 197650AS
O.D.: 3 15/16 (100.0)
I.D.: 1/2 (12.7) & 2 1/4 (57.2)
Height: 5 1/16 (128.6)
F. Gskt: G310, ES1036
End Seals: [1] Attached
Grommets: [1] Attached

BT443

Hydraulic Spin-on



Contains: Integral Post Seal
Fits: Massey Ferguson Wheel Tractors
Replaces: Massey Ferguson 3322234-M2
Thread: 1 1/4 -12
O.D.: 4 21/32 (118.3)
Height: 8 3/32 (205.6)
I.Gskt: [1] Included

Measurements Are Shown In Inches And (Millimeters)

! **WARNING:** These products can expose you to chemicals, including Diisononyl Phthalate, Carbon black extracts, Nickel, 1,3 Butadiene, Ethylene Oxide, Epichlorohydrin, which are known to the State of California to cause cancer, and Bisphenol, Ethylene Glycol, Ethylene Oxide, 1,3 Butadiene, Epichlorohydrin, which are known to the State of California to cause birth defects or other reproductive harm. For more information go to www.P65Warnings.ca.gov.

PT445-MPG

Maximum Performance Glass Hydraulic Element



Fits: John Deere Equipment
Replaces: John Deere AT67960
O.D.: 2 7/8 (73.0)
I.D.: 1 1/8 (28.6)
Height: 7 1/2 (190.5)
End Seals: [2] Attached

P454

Power Steering Element



Notes: Inside-Out Flow Direction
Fits: Ford, Peterbilt, White/GMC Trucks; International-Harvester Planters
Replaces: Ford D0HZ-3C602-B; International 507809-C91
O.D.: 2 15/32 (62.7)
I.D.: 1 1/16 (27.0) One End
Height: 3 9/16 (90.5)

P446

Power Steering Element



Notes: Inside-Out Flow Direction
Fits: Case, Caterpillar Equipment; International Trucks
Replaces: Case A18061; Caterpillar 32-1504; Ford C5TZ-3C602-A; International 974707-R92
O.D.: 2 15/32 (62.7)
I.D.: 1 3/32 (27.8)
Height: 3 9/16 (90.5)
F. Gskt: G296

S455

Resin Ribbon Fuel Element or Hydraulic Breather



Fits: Austin-Western, Bendix, Case, Franklin, Raygo Equipment
Replaces: Bendix 479135; Case A40314
O.D.: 1 1/2 (38.1)
I.D.: 1 1/8 (28.6)
Height: 1 3/8 (34.9)

B447

Full-Flow Lube Spin-on



Contains: Anti-Drainback Valve
 20 PSID By-Pass Valve
Fits: Volvo Marine Engines
Replaces: Volvo 471034, 471034-9
Thread: 1 -12
O.D.: 4 1/4 (108.0)
Height: 4 11/16 (119.1)
I.Gskt: G381-A

S456

Resin Ribbon Hydraulic Breather Element



Fits: Link-Belt Equipment
Replaces: Link-Belt 1PX316
O.D.: 2 (50.8)
I.D.: 1 5/8 (41.3)
Height: 5 (127.0)

P450

Power Steering Element



Fits: International Balers, Combines
Replaces: International 276259-C91
O.D.: 2 15/32 (62.7)
I.D.: 1 1/16 (27.0)
Height: 1 9/16 (39.7)
O. Gskt: G296

PT457-MPG

Maximum Performance Glass Hydraulic Element



Contains: Reinforced Centertube
Fits: John Deere Tractors
Replaces: John Deere AR99661
O.D.: 5 1/2 (139.7)
I.D.: 2 5/8 (66.7)
Height: 7 7/8 (200.0)
O-Ring: [2] Attached

S451

Resin Ribbon Power Steering Element



Fits: FWD Corporation, Patrick Equipment; Mack Trucks
Replaces: FWD Corporation 7D213984; Mack 63SL12; Vickers 213984
O.D.: 2 1/4 (57.2)
I.D.: 1 7/8 (47.6)
Height: 1 13/16 (46.0)

PT459

Hydraulic Element



Fits: Cessna Hydraulic Systems; Massey Ferguson, New Holland Equipment
Replaces: Cessna 20416-43; Massey Ferguson 1023057-M1; New Holland 167495
O.D.: 2 3/32 (53.2)
I.D.: 23/32 (18.3)
Height: 2 1/16 (52.4)

BT452

Hydraulic Spin-on



Contains: 20 PSID By-Pass Valve
Fits: Daewoo Lift Trucks; Case, International, Steiger Equipment
Replaces: Daewoo D141099; International 70203-C1
Thread: 1 -12
O.D.: 3 11/16 (93.7)
Height: 5 13/32 (137.3)
I.Gskt: G401
Related To: BT839 (without By-Pass Valve)

PT461

Transmission Element



Contains: 20 PSID By-Pass Valve
Fits: Allis Chalmers, Clark, International, Minneapolis-Moline, Oliver Equipment
Replaces: Allis Chalmers 1137201, 1137201-8; Clark 891105; International 392532-R91
O.D.: 1 11/16 (42.9)
I.D.: 1 1/32 (26.2) One End
Height: 4 3/16 (106.4)
F. Gskt: [1] Included
End Seals: [1] Attached

Measurements Are Shown In Inches And (Millimeters)

WARNING: These products can expose you to chemicals, including Diisononyl Phthalate, Carbon black extracts, Nickel, 1,3 Butadiene, Ethylene Oxide, Epichlorohydrin, which are known to the State of California to cause cancer, and Bisphenol, Ethylene Glycol, Ethylene Oxide, 1,3 Butadiene, Epichlorohydrin, which are known to the State of California to cause birth defects or other reproductive harm. For more information go to www.P65Warnings.ca.gov.

PT462 Hydraulic Element
Fits: Ford Equipment
Replaces: Ford C5NN-F882-B, C7NN-F882-A
O.D.: 6 (152.4)
 Bottom 6 1/2 (165.1)
I.D.: 2 13/32 (61.1) & 3 1/2 (88.9)
Height: 6 (152.4)
End Seals: [1] Attached



BT470 Hydraulic Spin-on
Fits: Fiat, Ford, Hesston, New Holland Equipment
Replaces: Fiat 1909130
Thread: 1 1/8 -16
O.D.: 4 1/4 (108.0)
Height: 7 3/8 (187.3)
I.Gskt: [1] Included



PT463 Hydraulic Element
Fits: Nicholson Equipment with Purolator Hydraulic Filters
Replaces: Purolator 7500501
O.D.: 2 1/32 (51.6)
I.D.: 1 7/32 (31.0) One End
Height: 7 1/16 (179.4)
O-Ring: [1] Attached



PT471 Hydraulic Element
Notes: Inside-Out Flow Direction
Fits: John Deere, Minneapolis-Moline Equipment
Replaces: John Deere AT45422
O.D.: 4 3/8 (111.1)
I.D.: 1 11/16 (17.5) & 3 5/8 (92.1)
Height: 9 9/16 (242.9)
End Seals: [1] Attached



PT466 Hydraulic Element
Contains: Reinforced Centertube
Fits: Hitachi, Isuzu, TCM Equipment
Replaces: Hitachi 4505384
O.D.: 4 1/4 (108.0)
I.D.: 9/16 (14.3) & 1 15/16 (49.2)
Height: 9 15/16 (252.4)
A. Gskt: [1] Attached
F. Gskt: [2] Included
Grommets: [1] Attached



BT472 Full-Flow Lube Spin-on
Contains: Anti-Drainback Valve
 20 PSID By-Pass Valve
Fits: Allis Chalmers, Fiat-Allis Equipment
Replaces: Fiat-Allis 4744707
Thread: M30 x 2.0
O.D.: 4 1/4 (108.0)
Height: 9 1/8 (231.8)
I.Gskt: [1] Included



PT467-MPG Maximum Performance Glass Hydraulic Element
Fits: White Equipment; Agco Tractors
Replaces: White 30-3343111B
O.D.: 4 1/2 (114.3)
I.D.: 1 7/8 (47.6)
Height: 6 31/32 (177.0)
F. Gskt: [4] Included



B474 Full-Flow Lube Spin-on
Contains: 8 PSID By-Pass Valve
Replaces: Quincy 110814
Thread: M16 x 1.5
O.D.: 3 (76.2)
Height: 3 17/32 (89.7)
I.Gskt: G449-B



PT468-MPG Maximum Performance Glass Hydraulic Element
Fits: Massey Ferguson Equipment
Replaces: Massey Ferguson 535040-M1
O.D.: 3 3/4 (95.3)
I.D.: 1 1/8 (28.6) One End
Height: 5 (127.0)



PT475 Power Steering Element
Fits: Dresser Industrial Equipment; Galion Rollers
Replaces: Galion D98524; GMC 6439020
O.D.: 4 1/2 (114.3)
I.D.: 1 23/32 (43.7)
Height: 8 15/16 (227.0)
O. Gskt: G252
End Seals: [2] Attached



PT469 Hydraulic Element
Fits: Galion Equipment
Replaces: Galion D67373A
O.D.: 5 (127.0)
I.D.: 2 1/2 (63.5)
Height: 11 7/8 (301.6)
End Seals: [2] Attached



P476 Full-Flow Lube Element
Fits: GM Automotive, Engines, Trucks
Replaces: GMC 6437562
O.D.: 3 1/2 (88.9)
I.D.: 1 5/16 (33.3)
Height: 8 7/16 (214.3)
F. Gskt: G153



Measurements Are Shown In Inches And (Millimeters)

 **WARNING:** These products can expose you to chemicals, including Diisononyl Phthalate, Carbon black extracts, Nickel, 1,3 Butadiene, Ethylene Oxide, Epichlorohydrin, which are known to the State of California to cause cancer, and Bisphenol, Ethylene Glycol, Ethylene Oxide, 1,3 Butadiene, Epichlorohydrin, which are known to the State of California to cause birth defects or other reproductive harm. For more information go to www.P65Warnings.ca.gov.

PT477



Hydraulic Element

Notes: NOT interchangeable with PT434, PT434-10 or PT492.
Fits: Case, Hough Equipment; Marvel Hydraulic Systems
Replaces: Case D51411; Marvel 529206-5125
O.D.: 2 5/8 (66.7)
I.D.: 1 7/32 (31.0) One End
Height: 4 13/16 (122.2)
O-Ring: [1] Attached

PT483



Hydraulic Element

Fits: Daewoo, Fiat, Hokuetsu, Komatsu Equipment
Replaces: Komatsu 205-60-51430
O.D.: 5 29/32 (150.0)
I.D.: 4 11/32 (110.3)
Height: 17 23/32 (450.1)

S479



Resin Ribbon Breather Element

Fits: LeRoi Compressors
Replaces: LeRoi 43-356
O.D.: 2 (50.8)
I.D.: 1 5/8 (41.3)
Height: 6 1/2 (165.1)

S485

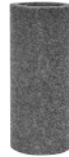

Resin Ribbon Full-Flow Lube Element

O.D.: 1 1/2 (38.1)
I.D.: 1 1/8 (28.6)
Height: 3 1/2 (88.9)

PT480



Hydraulic Element

Contains: Reinforced Centertube
Fits: Allis Chalmers, Case, Caterpillar, Minneapolis-Moline, Nicholson Equipment
Replaces: Allis Chalmers 2460855; Case A20902
O.D.: 3 (76.2)
I.D.: 1 1/16 (27.0) One End
Height: 5 21/32 (143.7)
O. Gskt: G366
Grommets: [1] Attached

BT486



Full-Flow Lube Spin-on

Fits: Ag-Chem, Bandit, John Deere Equipment
Replaces: John Deere AR98329, AR101278
Thread: 1 1/2 -12
O.D.: 5 1/16 (128.6)
Height: 6 31/32 (177.0)
F. Gskt: [1] Included

PT480-10



Hydraulic Element

Contains: Reinforced Centertube
Fits: Allis Chalmers, Case, Caterpillar, Minneapolis-Moline, Nicholson Equipment
Replaces: Allis Chalmers 2460855; Case A20902
O.D.: 3 (76.2)
I.D.: 1 1/16 (27.0) One End
Height: 5 21/32 (143.7)
O. Gskt: G366
Grommets: [1] Attached

PT487



Hydraulic Element

Contains: Reinforced Centertube
Fits: Allis Chalmers, Case, Fiat-Allis Equipment
Replaces: Allis Chalmers 647256; Fiat Fiat 70647256; GMC 25012559
O.D.: 3 15/16 (100.0)
I.D.: 1 5/8 (41.3)
Height: 9 1/4 (235.0)
O. Gskt: G368, ES3012

PT480-MPG



Maximum Performance Glass Hydraulic Element

Contains: Reinforced Centertube
Fits: Allis Chalmers, Case, Caterpillar, Minneapolis-Moline, Nicholson Equipment
Replaces: Allis Chalmers 2460855; Case A20902
O.D.: 3 (76.2)
I.D.: 1 1/16 (27.0) One End
Height: 5 21/32 (143.7)
O. Gskt: G366
Grommets: [1] Attached

B488



Lube Spin-on

Contains: Anti-Drainback Valve
20 PSID By-Pass Valve
Fits: Daewoo, John Deere, Komatsu, Yanmar Equipment
Replaces: John Deere M801209
Thread: M20 x 1.5
O.D.: 3 11/16 (93.7)
Height: 3 1/4 (82.6)
I.Gskt: G324-A

B481



Full-Flow Lube Spin-on

Contains: 50 PSID By-Pass Valve
Replaces: Worthington FLR412
Thread: 3/4 -16
O.D.: 3 11/16 (93.7)
Height: 6 5/8 (168.3)
I.Gskt: G381-A

S489



Felt Disk Turbocharger Lube Element

Fits: International, John Deere Equipment; M & W Gear Co. Supercharger
Replaces: M & W Gear Co. 4E005
O.D.: 3 1/4 (82.6)
I.D.: 3/4 (19.1)
Height: 4 11/16 (119.1)
F. Gskt: G105, [2] Included

Measurements Are Shown In Inches And (Millimeters)

WARNING: These products can expose you to chemicals, including Diisononyl Phthalate, Carbon black extracts, Nickel, 1,3 Butadiene, Ethylene Oxide, Epichlorohydrin, which are known to the State of California to cause cancer, and Bisphenol, Ethylene Glycol, Ethylene Oxide, 1,3 Butadiene, Epichlorohydrin, which are known to the State of California to cause birth defects or other reproductive harm. For more information go to www.P65Warnings.ca.gov.

PT490 Hydraulic Element
Fits: Nugent Optional Filter Housings
Replaces: Gardner Denver 5E14; Nugent 1555D1S
O.D.: 4 15/16 (125.4)
I.D.: 1 17/32 (38.9)
Height: 18 (457.2)
End Seals: [2] Attached
Related To: PT431 (Single-Length Version)



B495 Full-Flow Lube Spin-on
Fits: Detroit Diesel Engines
Replaces: Detroit Diesel 23518480
Thread: 1 5/8 -12
O.D.: 4 21/32 (118.3)
Height: 9 15/16 (252.4)
I.Gskt: [1] Included



PT491 Hydraulic Element
Notes: Inside-Out Flow Direction
Contains: Reinforced Centertube
Fits: Michigan Equipment
Replaces: Clark 1530600
O.D.: 6 (152.4)
I.D.: 2 23/32 (69.1)
Height: 18 (457.2)
O. Gskt: G382
End Seals: [1] Attached



B495-MPG Maximum Performance Glass Lube Spin-on
Fits: Detroit Diesel Engines
Replaces: Detroit Diesel 23518480
Thread: 1 5/8 -12
O.D.: 4 21/32 (118.3)
Height: 9 15/16 (252.4)
I.Gskt: [1] Included



PT491-10 Hydraulic Element
Notes: Inside-Out Flow Direction
Contains: Reinforced Centertube
Fits: Austin, Western, Clark, Michigan, V.M.E., Volvo Equipment
Replaces: Clark 1530600
O.D.: 6 (152.4)
I.D.: 2 23/32 (69.1)
Height: 18 (457.2)
O. Gskt: G382
End Seals: [1] Attached



B495-SS Severe Service Lube Spin-on
Fits: Detroit Diesel Engines
Replaces: Detroit Diesel 23518480
Thread: 1 5/8 -12
O.D.: 4 21/32 (118.3)
Height: 9 15/16 (252.4)
I.Gskt: [1] Included



PT492 Hydraulic Element
Notes: NOT interchangeable with PT434, PT434-10 or PT477.
Replaces: Marvel 629206-5110
O.D.: 2 5/8 (66.7)
I.D.: 1 7/32 (31.0)
Height: 5 (127.0)
O-Ring: [2] Attached



P496 Full-Flow Lube Element
Fits: Toyota Lift Trucks
Replaces: Toyota 4152-21010, 4152-40010, 4512-40011
O.D.: 2 7/8 (73.0)
I.D.: 21/32 (16.7)
Height: 4 3/8 (111.1)
F. Gskt: ES1049, [1] Included
End Seals: [2] Attached



PT493 Hydraulic Element
Notes: Inside-Out Flow Direction
Fits: Gardner Denver Compressors
Replaces: Gardner Denver 5E30
O.D.: 4 31/32 (126.2)
I.D.: 1 3/16 (30.2)
Height: 18 5/8 (473.1)
F. Gskt: [1] Included
End Seals: [2] Attached



P497 Full-Flow Lube Element
Fits: Toyota Lift Trucks, Light-Duty Trucks
Replaces: Toyota 4152-40020, 4152-40030, 15600-40012
O.D.: 2 7/8 (73.0)
I.D.: 21/32 (16.7)
Height: 5 1/16 (128.6)
F. Gskt: G233-A, ES1049
End Seals: [2] Attached



B494 By-Pass Lube Spin-on
Fits: GMC Trucks; Isuzu Engines
Replaces: GMC 94360419; Isuzu 8-94360-419-0
Thread: 5/8 -18
O.D.: 4 1/4 (108.0)
Height: 3 3/16 (81.0)
I.Gskt: [1] Included



PT498 Hydraulic Element
Fits: Austin-Western, Dynahoe, Nicholson Equipment
Replaces: Allis Chalmers 706795132; Clark 993611; Ford 3900612; International 8968811-C1; John Deere AT45810
O.D.: 4 1/2 (114.3)
I.D.: 2 1/4 (57.2) One End
Height: 7 1/4 (184.2)
I.Gskt: [1] Included
O. Gskt: G307, G397



Measurements Are Shown In Inches And (Millimeters)

 **WARNING:** These products can expose you to chemicals, including Diisononyl Phthalate, Carbon black extracts, Nickel, 1,3 Butadiene, Ethylene Oxide, Epichlorohydrin, which are known to the State of California to cause cancer, and Bisphenol, Ethylene Glycol, Ethylene Oxide, 1,3 Butadiene, Epichlorohydrin, which are known to the State of California to cause birth defects or other reproductive harm. For more information go to www.P65Warnings.ca.gov.

PT498-10



Hydraulic Element

Fits: Allis Chalmers, Fiat-Allis, Ford, Hough Equipment
Replaces: Allis Chalmers 706795132; Clark 993611; Ford 3900612; International 8968811-C1; John Deere AT45810
O.D.: 4 1/2 (114.3)
I.D.: 2 1/4 (57.2) One End
Height: 7 1/4 (184.2)
I.Gskt: [1] Included
O. Gskt: G307, G397

PT503



Hydraulic Element

Fits: Dresser, International Equipment
Replaces: International 666219-C1
O.D.: 6 1/2 (165.1)
I.D.: 5 1/2 (139.7)
Height: 12 3/16 (309.6)

PT499-5



Hydraulic Element

Fits: Gradall, Hough, International Equipment
Replaces: International 26328-M1, 878015-C3
O.D.: 6 (152.4)
I.D.: 2 5/8 (66.7)
Height: 9 (228.6)
End Seals: [2] Attached
Related To: PT212 (Double-Length Version)

PF506



Fuel Element

Fits: Ford Light-Duty Trucks
Replaces: Ford E5TZ-9365-B
O.D.: 2 3/4 (69.9)
I.D.: 9/16 (14.3) One End
Height: 2 9/16 (65.1)
F. Gskt: [1] Included
Grommets: [1] Attached

501



DAHL Fuel Element

Notes: 4 Micron Nominal (20 Absolute)
Fits: DAHL 500 Series Fuel Filter/Water Separator Units
O.D.: 6 1/16 (154.0)
I.D.: 1 15/32 (37.3)
Height: 9 23/32 (246.9)
O-Ring: [2] Attached

P507



Full-Flow Lube Element

Contains: Reinforced Centertube
Fits: Mercedes-Benz Engines, Trucks, Vans
Replaces: Mercedes-Benz 11843925
O.D.: 4 3/4 (120.7)
I.D.: 2 1/4 (57.2)
Height: 8 31/32 (227.8)
A. Gskt: [2] Included
O. Gskt: G439

501-30



DAHL Fuel Element

Notes: 9 Micron Nominal (40 Absolute)
Fits: DAHL 500 Series Fuel Filter/Water Separator Units
O.D.: 6 1/16 (154.0)
I.D.: 1 15/32 (37.3)
Height: 9 23/32 (246.9)
O-Ring: [2] Attached

PT508-MPG



Maximum Performance Glass Hydraulic Element

Fits: John Deere Equipment
Replaces: John Deere RE11889
O.D.: 4 9/16 (115.9)
I.D.: 2 7/32 (56.4)
Height: 5 15/32 (138.9)
End Seals: [2] Attached

501-W



DAHL Fuel Element

Notes: 5 Micron Nominal (25 Absolute)
Fits: DAHL 500 Series Fuel Filter/Water Separator Units
O.D.: 6 1/16 (154.0)
I.D.: 1 15/32 (37.3)
Height: 9 23/32 (246.9)
O-Ring: [2] Attached

PT509-MPG KIT



Kit of 2 Maximum Performance Glass Hydraulic Elements

Contains: Reinforced Centertube
Fits: Case Tractors
Replaces: Case A176593 KIT
O.D.: 4 1/2 (114.3)
I.D.: 2 1/4 (57.2)
Height: 7 5/32 (181.8)
A. Gskt: [2] Attached on Each Element

F501-MD



Cotton Batting Fuel Sock

Fits: Murphy Diesel Engines; Northwest Equipment
Replaces: Murphy MD13924A
Thread: 1/4 -18 NPT
O.D.: 2 3/8 (60.3)
Height: 36 3/4 (933.5)
F. Gskt: [1] Included

PT510



Hydraulic Element

Contains: Reinforced Centertube
Fits: Komatsu Equipment
Replaces: Komatsu 424-16-11140, 385-10100021, 385-10100022
O.D.: 4 1/2 (114.3)
I.D.: 1 23/32 (43.7)
Height: 8 15/16 (227.0)
A. Gskt: [2] Attached

Measurements Are Shown In Inches And (Millimeters)

WARNING: These products can expose you to chemicals, including Diisononyl Phthalate, Carbon black extracts, Nickel, 1,3 Butadiene, Ethylene Oxide, Epichlorohydrin, which are known to the State of California to cause cancer, and Bisphenol, Ethylene Glycol, Ethylene Oxide, 1,3 Butadiene, Epichlorohydrin, which are known to the State of California to cause birth defects or other reproductive harm. For more information go to www.P65Warnings.ca.gov.

PT512 Full-Flow Lube Element
Fits: E.M.D. Locomotives
Replaces: E.M.D. 8322064
O.D.: 4 1/2 (114.3)
I.D.: 1 23/32 (43.7) One End
Height: 20 (508.0)
A. Gskt: [1] Attached



PT518 Hydraulic Element
Fits: American Hoist & Derrick Backhoes;
 Ingersoll-Rand Compressors
Replaces: American Hoist & Derrick 9832252;
 Ingersoll-Rand 35222981
O.D.: 7 7/16 (188.9)
I.D.: 4 3/4 (120.7) One End
Height: 22 (558.8)
End Seals: [1] Attached



PT513 Full-Flow Lube Element
Fits: E.M.D. Locomotives
Replaces: E.M.D. 83240000
O.D.: 2 29/32 (73.8)
I.D.: 1 (25.4) One End
Height: 7 7/16 (188.9)
A. Gskt: [1] Attached



PT518-10 Hydraulic Element
Fits: American Hoist & Derrick, Insley
 Backhoes
Replaces: American Hoist & Derrick 9832252;
 Ingersoll-Rand 35222981
O.D.: 7 7/16 (188.9)
I.D.: 4 3/4 (120.7) One End
Height: 22 (558.8)
End Seals: [1] Attached



PT514 Differential Element
Fits: Allis Chalmers Equipment
Replaces: Allis Chalmers 267300
O.D.: 5 (127.0)
I.D.: 2 13/16 (71.4)
Height: 6 1/8 (155.6)
F. Gskt: [2] Included
End Seals: [2] Attached



PT520 Hydraulic Element
Fits: Gradall Construction Equipment; Marvel
 Hydraulic Systems
Replaces: Marvel M25415125, M25415140
O.D.: 6 1/2 (165.1)
I.D.: 3 15/32 (88.1)
Height: 7 1/2 (190.5)
I.Gskt: [2] G366



PT515 Hydraulic Element
Fits: Case Equipment
Replaces: Case L50384
O.D.: 6 15/32 (164.3)
I.D.: 1 27/32 (46.8)
Height: 9 23/32 (246.9)
O-Ring: [2] Attached



BT521 Full-Flow Lube Spin-on
Notes: CAUTION: Use ONLY on Case
 applications.
 Contains NO by-pass valve.
 Do NOT substitute for any other filter.
Contains: Anti-Drainback Valve
Fits: Case Tractors
Replaces: Case A62423
Thread: 7/8 -16
O.D.: 4 1/4 (108.0)
Height: 7 11/32 (186.5)
I.Gskt: G381-A



PT516 Hydraulic Element
Fits: Bobcat Excavators; Komatsu Equipment
Replaces: Komatsu 1546-01-2170
O.D.: 3 15/16 (100.0)
I.D.: 2 11/32 (59.5)
Height: 8 5/16 (211.1)



PT522 Hydraulic Element
Fits: John Deere Equipment
Replaces: John Deere AH76668
O.D.: 3 3/4 (95.3)
I.D.: 2 9/16 (65.1)
Height: 8 (203.2)



PT517 Hydraulic Element
Fits: Komatsu Equipment
Replaces: Komatsu 1446-01-1160
O.D.: 3 15/16 (100.0)
I.D.: 2 11/32 (59.5)
Height: 11 1/16 (281.0)



Measurements Are Shown In Inches And (Millimeters)

 **WARNING:** These products can expose you to chemicals, including Diisononyl Phthalate, Carbon black extracts, Nickel, 1,3 Butadiene, Ethylene Oxide, Epichlorohydrin, which are known to the State of California to cause cancer, and Bisphenol, Ethylene Glycol, Ethylene Oxide, 1,3 Butadiene, Epichlorohydrin, which are known to the State of California to cause birth defects or other reproductive harm. For more information go to www.P65Warnings.ca.gov.

BT525

Hydraulic Spin-on



Contains: Anti-Drainback Valve
Fits: Allis Chalmers Equipment
Replaces: Allis Chalmers 253952
Thread: 13/16 -16
O.D.: 3 11/16 (93.7)
Height: 8 23/32 (221.5)
I.Gskt: G381-A

PT534

Hydraulic Element



Fits: International Wheel Tractors
Replaces: International 113618-C1
O.D.: 5 (127.0)
I.D.: 2 29/32 (73.8)
Height: 2 9/16 (65.1)

BT526

Hydraulic Spin-on



Fits: Allis Chalmers, Char-Lynn, Ingersoll-Rand, Massey Ferguson Equipment
Replaces: Char-Lynn 5604
Thread: 1 1/4 -12
O.D.: 3 11/16 (93.7)
Height: 5 3/8 (136.5)
I.Gskt: G381-A

PT535

Hydraulic Element



Fits: Caterpillar Equipment
Replaces: Caterpillar 9T9054
O.D.: 3 (76.2)
I.D.: 1 1/16 (27.0) One End
Height: 8 3/16 (208.0)
Grommets: [1] Attached

BT526-10

Hydraulic Spin-on



Fits: Allis Chalmers, Blaw-Knox, Bobcat, Case, Char-Lynn, Gehl, Ingersoll-Rand, Massey Ferguson, New Holland Equipment
Replaces: Char-Lynn 5610
Thread: 1 1/4 -12
O.D.: 3 11/16 (93.7)
Height: 5 3/8 (136.5)
I.Gskt: G381-A

BT536

Full-Flow Lube Spin-on



Contains: 30 PSID By-Pass Valve
Fits: Case, International Equipment
Replaces: International 3136046-R93
Thread: 1 -12
O.D.: 3 11/16 (93.7)
Height: 4 3/8 (111.1)
I.Gskt: G381-A

PT527

Hydraulic Element



Contains: Spring Reinforced Centertube
Fits: Koehring Equipment
Replaces: Koehring 288B1212
O.D.: 6 1/2 (165.1)
I.D.: 2 31/32 (75.4)
Height: 18 5/8 (473.1)
I.Gskt: [2] Included

P537

Full-Flow Lube Element



Replaces: Bofors 91-471-068-01
O.D.: 6 (152.4)
I.D.: 3 17/32 (89.7)
Height: 13 (330.2)

P528

Hydraulic and Power Steering Element



Notes: Inside-Out Flow Direction
Fits: Freightliner, International, Kenworth, Mack, Peterbilt, Volvo Trucks
Replaces: White 3105264
O.D.: 4 3/4 (120.7)
I.D.: 15/16 (23.8) & 1 9/16 (39.7)
Height: 4 3/16 (106.4)
O. Gskt: G252, G356
End Seals: [2] Attached

PT538

Hydraulic Element



Fits: International Wheel Tractors
Replaces: International 113940-C1
O.D.: 4 27/32 (123.0)
I.D.: 2 7/8 (73.0)
Height: 9 (228.6)
F. Gskt: [1] Included
End Seals: [2] Attached

P529

Hydraulic Element with Handle



Fits: Marvel Hydraulic Systems; Rexworks Equipment
Replaces: Marvel M2801; Rex 298-00133-53
O.D.: 6 1/2 (165.1)
I.D.: 1 19/32 (40.5) One End
Height: 7 25/32 (197.6)
I.Gskt: [1] Included

PT539

Hydraulic Element



Contains: Reinforced Centertube
Fits: Komatsu, Samsung Equipment
Replaces: Komatsu 1756-02-7380
O.D.: 5 1/8 (130.2)
I.D.: 3 3/8 (85.7)
Height: 11 9/16 (293.7)

Measurements Are Shown In Inches And (Millimeters)

WARNING: These products can expose you to chemicals, including Diisononyl Phthalate, Carbon black extracts, Nickel, 1,3 Butadiene, Ethylene Oxide, Epichlorohydrin, which are known to the State of California to cause cancer, and Bisphenol, Ethylene Glycol, Ethylene Oxide, 1,3 Butadiene, Epichlorohydrin, which are known to the State of California to cause birth defects or other reproductive harm. For more information go to www.P65Warnings.ca.gov.

P540



Full-Flow Lube Element

Fits: Lister, Petter Engines
Replaces: Lister 268678; Petter 268378
O.D.: 1 31/32 (50.0)
I.D.: 29/32 (23.0)
Height: 2 1/8 (54.0)
O. Gskt: G431
End Seals: [2] Attached

PT549



Transmission Element

Fits: Allis Chalmers, Case, Fiat-Allis, Ford, Galion, International, John Deere, Massey Ferguson, Owatonna Equipment
Replaces: Allis Chalmers 10049229; Case D52932; International 630939-C91; Massey Ferguson 1088695-M91; Owatonna 42532521
O.D.: 3 7/16 (87.3)
I.D.: 1 3/16 (30.2) One End
Height: 5 11/16 (144.5)
A. Gskt: [1] Attached
F. Gskt: G402

BT541



Turbocharger Lube Spin-on

Notes: Tilt filter to let air out while you fill with oil before installing filter.
Contains: Flow Control Orifice
 8 PSID By-Pass Valve
Fits: International, John Deere, M & W Gear Co., Same Equipment
Replaces: M & W Gear Co. 4E023
Thread: 5/8 -18
O.D.: 3 11/16 (93.7)
Height: 5 3/8 (136.5)
I.Gskt: G381-A

PT550-10



Hydraulic Element

Fits: Insley Shovels
Replaces: Insley H8412; Marvel M3251-5110
O.D.: 4 1/2 (114.3)
I.D.: 2 1/4 (57.2)
Height: 15 (381.0)
I.Gskt: [2] Included
F. Gskt: G260
Related To: PT288-HD10 (Single-Length Version)

PT543 KIT



Kit of 2 Hydraulic Elements

Fits: Allis Chalmers Tractors; Gardner Denver Drills
Replaces: Allis Chalmers 647255; Gardner Denver 165335
O.D.: 2 7/8 (73.0)
I.D.: 1 1/16 (27.0)
Height: 9 5/8 (244.5)
A. Gskt: [2] Attached on Each Element
F. Gskt: [2] G366

PT551-10



Hydraulic Element

Fits: CMI, Driitech, Gomaco, LeRoi, Lorain Equipment
Replaces: Insley H8357, H8409; Schroeder BB10
O.D.: 5 (127.0)
I.D.: 3 1/4 (82.6)
Height: 18 5/16 (465.1)
End Seals: [2] Attached

P545



Power Steering Element

Fits: WhiteGMC Trucks
Replaces: White 3107499
O.D.: 3 15/16 (100.0)
I.D.: 1 1/8 (28.6)
Height: 5 1/8 (130.2)
A. Gskt: [2] Attached

BF553



Fuel Spin-on with Drain

Fits: Ryco Head #15
Replaces: Ryco R15
Thread: 1 -11 BSP-PL
O.D.: 3 13/16 (96.8)
Height: 5 1/4 (133.4)
F. Gskt: [1] Included

PT546



Hydraulic Element

Fits: International Equipment
Replaces: International 406669-R1, 406705-R91
O.D.: 2 7/8 (73.0)
I.D.: 1 3/16 (30.2) One End
Height: 5 19/32 (142.1)
A. Gskt: [1] Attached
F. Gskt: [1] Included

PT554



Hydraulic Element

Fits: Clark Lift Trucks
Replaces: Clark 1618480, 1810437
O.D.: 4 1/2 (114.3)
I.D.: 1 29/32 (48.4)
Height: 10 3/16 (258.8)
F. Gskt: [2] ES1092, [1] Included
O. Gskt: G236-A
Related To: PT207, PT207-10, PT207-HD, PT207-HD10 (Short Versions) PT573 (Long Version)

PT548



Steering Element

Notes: Inside-Out Flow Direction
Fits: Case, Ford, New Holland Equipment
Replaces: Ford EDPN-3K758-A
O.D.: 3 15/16 (100.0)
I.D.: 1 1/16 (27.0)
Height: 1 3/8 (34.9)
End Seals: [2] Attached

P555



Hydraulic Element

Notes: Inside-Out Flow Direction
Fits: Kobelco, LeTourneau-Westinghouse, WABCO Equipment
Replaces: LeTourneau DA2980; WABCO WA9652
O.D.: 5 1/8 (130.2)
I.D.: 3 3/8 (85.7)
Height: 9 1/4 (235.0)
A. Gskt: [1] Attached

Measurements Are Shown In Inches And (Millimeters)



WARNING: These products can expose you to chemicals, including Diisononyl Phthalate, Carbon black extracts, Nickel, 1,3 Butadiene, Ethylene Oxide, Epichlorohydrin, which are known to the State of California to cause cancer, and Bisphenol, Ethylene Glycol, Ethylene Oxide, 1,3 Butadiene, Epichlorohydrin, which are known to the State of California to cause birth defects or other reproductive harm. For more information go to www.P65Warnings.ca.gov.

BT556-10

Hydraulic Spin-on



Fits: John Deere, Owatonna Loaders
Replaces: John Deere GG17031266; Owatonna 17031266
Thread: 1 1/8 -16
O.D.: 4 1/4 (108.0)
Height: 10 7/16 (265.1)
I.Gskt: [1] Included
Related To: B76 (Lube Version)

BT564

Full-Flow Lube Spin-on



Fits: Allis Chalmers, Bantam, Bomag, Champion, Fiat-Allis, Freeman, New Idea Equipment
Replaces: Allis Chalmers 4023548-3; New Idea 731607
Thread: 1 -16
O.D.: 4 1/4 (108.0)
Height: 5 13/16 (147.6)
I.Gskt: G381-A
Related To: BT440 (Long Version)

PT558

Oval Hydraulic Element



Fits: International Wheel Tractors
Replaces: International 388080-R93, 388084-R93
O.D.: 4 5/8 (117.5) to 7 1/4 (184.2)
I.D.: 1 1/2 (38.1) & 2 7/8 (73.0)
Height: 2 17/32 (64.3)
A. Gskt: [1] Attached
F. Gskt: [2] Included

PT565

Hydraulic Element



Fits: Case, International Equipment
Replaces: International 530144-R92
O.D.: 5 (127.0)
I.D.: 2 13/16 (71.4)
Height: 3 (76.2)
A. Gskt: [2] Attached
F. Gskt: [1] Included
Related To: PT8907-MPG (Glass Media Version)

PT560 KIT

Kit of 2 Hydraulic Elements



Contains: Reinforced Centertube
Fits: Case Tractors
Replaces: Case A44012 KIT
O.D.: 4 17/32 (115.1)
I.D.: 1/2 (12.7) & 2 9/32 (57.9)
Height: 7 1/16 (179.4)
F. Gskt: [1] Included
End Seals: [1] Attached on Each Element
Grommets: [1] Attached to Each Element

PT566

Hydraulic Element



Notes: NOT interchangeable with PT563.
Fits: Case, Dresser, International Equipment
Replaces: International 623017-C1
O.D.: 5 (127.0)
I.D.: 2 13/16 (71.4)
Height: 9 (228.6)
A. Gskt: [2] Attached

PT561

Hydraulic Element



Notes: Inside-Out Flow Direction
Replaces: John Deere AT63548
O.D.: 4 1/2 (114.3)
I.D.: 2 1/4 (57.2)
Height: 8 1/16 (204.8)
O. Gskt: G400

PT567

Hydraulic Element



Fits: Equipment with Ripley Hydraulic Systems
Replaces: Ripley 4P13
O.D.: 3 3/4 (95.3)
I.D.: 1 31/32 (50.0) One End
Height: 7 13/16 (198.4)
A. Gskt: [1] Attached

PT562-10

Hydraulic Element



Fits: Insley Shovels
Replaces: Insley H5898
O.D.: 3 3/8 (85.7)
I.D.: 1 7/8 (47.6)
Height: 7 7/16 (188.9)
I.Gskt: [2] Included

PT567-10

Hydraulic Element



Fits: Equipment with Ripley Hydraulic Systems
Replaces: Ripley 8P13
O.D.: 3 3/4 (95.3)
I.D.: 1 31/32 (50.0) One End
Height: 7 13/16 (198.4)
A. Gskt: [1] Attached

PT563

Hydraulic Element



Notes: NOT interchangeable with PT566.
Fits: Allis Chalmers, John Deere Equipment
Replaces: Allis Chalmers 70269922; John Deere AH76991
O.D.: 5 (127.0)
I.D.: 2 13/16 (71.4)
Height: 9 (228.6)
F. Gskt: [2] Included
End Seals: [2] Attached

PT568

Hydraulic Element



Notes: Inside-Out Flow Direction
Fits: Timberjack Logging Equipment
Replaces: Timberjack 205882
O.D.: 5 1/8 (130.2)
I.D.: 13/32 (10.3) & 3 3/8 (85.7)
Height: 9 3/32 (231.0)
A. Gskt: [2] G120-A
Related To: PT90 (As Specified in Applications)

Measurements Are Shown In Inches And (Millimeters)

WARNING: These products can expose you to chemicals, including Diisononyl Phthalate, Carbon black extracts, Nickel, 1,3 Butadiene, Ethylene Oxide, Epichlorohydrin, which are known to the State of California to cause cancer, and Bisphenol, Ethylene Glycol, Ethylene Oxide, 1,3 Butadiene, Epichlorohydrin, which are known to the State of California to cause birth defects or other reproductive harm. For more information go to www.P65Warnings.ca.gov.

PT571 Hydraulic Element
Contains: Reinforced Centertube
Fits: Allis Chalmers, Fiat-Allis Equipment
Replaces: Allis Chalmers 669434 KIT, 676022 Element
O.D.: 4 7/16 (112.7)
I.D.: 1 3/4 (44.5)
Height: 12 3/4 (323.9)
A. Gskt: [2] Attached
F. Gskt: [3] Included

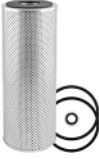

BF583 Fuel Spin-on
Contains: Integral Post Seal
Fits: Caterpillar, Oliver Engines; CMI, Dynapac, Gradall, International, New Holland, Steiger, Wiggins Equipment
Replaces: Caterpillar 1R0710
Thread: 15/16 -16
O.D.: 3 11/16 (93.7)
Height: 5 3/8 (136.5)
I.Gskt: G381-A



PT573 Hydraulic Element
Fits: Clark Lift Trucks, Loaders
Replaces: Clark 1810528, 1810889
O.D.: 4 1/2 (114.3)
I.D.: 1 29/32 (48.4)
Height: 12 1/4 (311.2)
F. Gskt: G417, [2] ES1092
Related To: PT207, PT207-10, PT207-HD, PT207-HD10, PT554 (Short Versions)

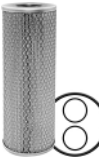

BF584 Fuel Spin-on
Contains: Integral Post Seal
Fits: Caterpillar Paving Equipment
Thread: 1 -14
O.D.: 4 1/4 (108.0)
Height: 10 7/16 (265.1)
I.Gskt: G381-A
Related To: BF1218 (Fuel/Water Separator Version)



BF577 Primary Fuel Spin-on
Contains: Integral Post Seal
Thread: 1 -14
O.D.: 3 11/16 (93.7)
Height: 8 25/32 (223.0)
I.Gskt: G401



BF584-B Fuel Spin-on (Boxed Version)
Contains: Integral Post Seal
Fits: Caterpillar Paving Equipment
Thread: 1 -14
O.D.: 4 1/4 (108.0)
Height: 10 7/16 (265.1)
I.Gskt: G381-A
Related To: BF1218 (Fuel/Water Separator Version)



PT578 Hydraulic Element
Fits: International Equipment
Replaces: International 541275-R1, 547412-R91
O.D.: 5 (127.0)
I.D.: 2 13/16 (71.4)
Height: 4 13/16 (122.2)
O-Ring: [1] Included



BF585 Fuel Spin-on
Fits: Ford, Ottawa Trucks
Replaces: Ford D3HZ-9155-A, D3HZ-9365-A
Thread: 1 -14
O.D.: 3 11/16 (93.7)
Height: 5 11/32 (135.7)
I.Gskt: [1] Included



PT579 Hydraulic Element
Fits: Gradall, LeRoi, Lorain, Northwest, Prentice Equipment
Replaces: Gradall 86671045; Lorain D87282A
O.D.: 4 1/4 (108.0)
I.D.: 3 1/8 (79.4)
Height: 9 23/32 (246.9)
A. Gskt: [2] Attached



BF586 Primary Fuel Spin-on
Fits: Atlas Copco Compressors; Deutz Engines; Deutz, Hanomag, International Equipment
Replaces: Deutz 2133558; International 3136187-R91
Thread: M16 x 1.5
O.D.: 3 1/32 (77.0)
Height: 5 27/32 (148.4)
I.Gskt: G449-B



BF582 Secondary Fuel Spin-on
Notes: CAUTION: Furnished O-Ring must be installed to seal. Part of BF897 KIT.
Fits: Allis Chalmers, Case, Fiat-Allis, Grimmer Schmidt Equipment
Replaces: Case A58713
Thread: 15/16 -16
O.D.: 3 11/16 (93.7)
Height: 5 13/32 (137.3)
I.Gskt: G401
O-Ring: ES24-B



BF586-D Primary Fuel Spin-on with Drain
Fits: Atlas Copco Compressors; Deutz Engines; Deutz, Hanomag, International Equipment
Replaces: Deutz 2133558; International 3136187-R91
Thread: M16 x 1.5
O.D.: 3 1/32 (77.0)
Height: 5 27/32 (148.4)
I.Gskt: G449-B



Measurements Are Shown In Inches And (Millimeters)

 **WARNING:** These products can expose you to chemicals, including Diisononyl Phthalate, Carbon black extracts, Nickel, 1,3 Butadiene, Ethylene Oxide, Epichlorohydrin, which are known to the State of California to cause cancer, and Bisphenol, Ethylene Glycol, Ethylene Oxide, 1,3 Butadiene, Epichlorohydrin, which are known to the State of California to cause birth defects or other reproductive harm. For more information go to www.P65Warnings.ca.gov.

BF587



Secondary Fuel Spin-on

Fits: Atlas-Copco Compressors; Deutz, Volvo-Penta Engines; Case, Deutz, Dresser, Fendt, Ford, Galion, Hough, International, John Deere, New Holland Equipment; Fiat, M.A.N. Trucks

Replaces: Deutz 2133943; International 3132428-R91; Volvo-Penta 8385932

Thread: M16 x 1.5
O.D.: 3 1/32 (77.0)
Height: 6 1/8 (155.6)
I.Gskt: G449-B

BF594-F



Fuel Element with Bail Handle

Replaces: Deutz R2H4115
O.D.: 4 5/32 (105.6)
I.D.: 3/4 (19.1)
Height: 6 23/32 (170.7)
A. Gskt: [2] Attached

BF587-D



Secondary Fuel Spin-on with Drain

Fits: Atlas-Copco Compressors; Deutz, Volvo-Penta Engines; Case, Deutz, Dresser, Fendt, Ford, Galion, Hough, International, John Deere, New Holland Equipment; Fiat, M.A.N. Trucks

Replaces: Deutz 2133943; International 3132428-R91; Volvo-Penta 8385932

Thread: M16 x 1.5
O.D.: 3 1/32 (77.0)
Height: 6 1/8 (155.6)
I.Gskt: G449-B
Related To: BF5587-D (with Trapped O-Ring)

PF594



Primary Fuel Element

Fits: Deutz Diesel Engines
Replaces: Deutz W2H4115
O.D.: 3 15/16 (100.0)
I.D.: 23/32 (18.3)
Height: 6 5/8 (168.3)
Grommets: [2] Attached

BF588



Secondary Fuel Spin-on

Notes: Use BF7629 on International Engines having a single fuel filter.

Contains: Integral Post Seal
Fits: Allis Chalmers, Case, Dresser, Galion, Hough, John Deere, Oliver Equipment; International Engines, Equipment

Replaces: International 672603-C2, 672603-C3
Thread: 7/8 -14
O.D.: 4 1/4 (108.0)
Height: 7 11/32 (186.5)
I.Gskt: G381-A

BT595



Full-Flow Lube or Hydraulic Spin-on

Fits: Caterpillar Lift Trucks; Cummins Engines
Replaces: Caterpillar 91-7336
Thread: 1 1/8 -16
O.D.: 3 11/16 (93.7)
Height: 7 3/16 (182.6)
I.Gskt: G401

BF591



Secondary Fuel Spin-on

Notes: CAUTION: Furnished O-Ring must be installed on post for seal.

Contains: Integral Post Seal
Fits: Case, Drott Equipment

Replaces: Case A77220
Thread: 15/16 -16
O.D.: 3 11/16 (93.7)
Height: 7 3/16 (182.6)
I.Gskt: G401
O-Ring: ES24-B

BF596



Fuel Spin-on

Contains: Integral Post Seal
Fits: Cummins Engines; Euclid, Komatsu Equipment; International, Kenworth, Mack Trucks

Replaces: Cummins 3313306
Thread: 1 1/4 -12
O.D.: 4 21/32 (118.3)
Height: 11 7/32 (285.0)
I.Gskt: G498-A
Related To: BF1216 (Fuel/Water Separator Version)

BF592



Primary Fuel Spin-on

Notes: Can be used with FB1301 base.

Fits: Detroit Diesel Engines
Replaces: Detroit Diesel 23518527
Thread: 1 -12
O.D.: 3 11/16 (93.7)
Height: 4 11/32 (110.3)
I.Gskt: [1] Included
Related To: BF5800 (Long Version)

BF597



Fuel Spin-on with Drain

Notes: CAUTION: Furnished O-Ring must be installed on post for seal.

Fits: Allis Chalmers, Fiat-Allis, New Idea Equipment
Replaces: Allis Chalmers 4321716, 4321716-5
Thread: 15/16 -16
O.D.: 3 11/16 (93.7)
Height: 7 17/32 (191.3)
I.Gskt: G401
O-Ring: ES24-B

BF593



Secondary Fuel Spin-on

Notes: Can be used with FB1302 base.

Contains: Integral Post Seal
Fits: Detroit Diesel Engines
Replaces: GMC 23518526, 23518669
Thread: 13/16 -12
O.D.: 3 23/32 (94.5)
Height: 4 13/32 (111.9)
I.Gskt: [1] Included

PF598



Fuel/Water Separator with Bail Handle

Fits: Racor 500 Series Housings
Replaces: Racor 2010 Series
O.D.: 3 7/32 (81.8)
I.D.: 5/8 (15.9)
Height: 2 3/4 (69.9)
F. Gskt: G458, [1] Included
Grommets: [2] Attached

Measurements Are Shown In Inches And (Millimeters)

WARNING: These products can expose you to chemicals, including Diisononyl Phthalate, Carbon black extracts, Nickel, 1,3 Butadiene, Ethylene Oxide, Epichlorohydrin, which are known to the State of California to cause cancer, and Bisphenol, Ethylene Glycol, Ethylene Oxide, 1,3 Butadiene, Epichlorohydrin, which are known to the State of California to cause birth defects or other reproductive harm. For more information go to www.P65Warnings.ca.gov.

PF598-10



Fuel/Water Separator with Bail Handle
Fits: Racor 500 Series Housings
Replaces: Racor 2010 Series
O.D.: 3 7/32 (81.8)
I.D.: 5/8 (15.9)
Height: 2 3/4 (69.9)
F. Gskt: G458, [1] Included
Grommets: [2] Attached

PF598-30



Fuel/Water Separator with Bail Handle
Fits: Racor 500 Series Housings
Replaces: Racor 2010 Series
O.D.: 3 7/32 (81.8)
I.D.: 5/8 (15.9)
Height: 2 3/4 (69.9)
F. Gskt: G458, [1] Included
Grommets: [2] Attached

PF599



Fuel/Water Separator Element
Fits: Racor 200 Series Housings
Replaces: Racor 2000 Series
O.D.: 1 3/4 (44.5)
I.D.: 15/32 (11.9) One End
Height: 2 27/32 (72.2)
I.Gskt: [1] Included
O. Gskt: G467, G468

PF599-10



Fuel/Water Separator Element
Fits: Racor 200 Series Housings
Replaces: Racor 2000 Series
O.D.: 1 3/4 (44.5)
I.D.: 15/32 (11.9) One End
Height: 2 27/32 (72.2)
I.Gskt: [1] Included
O. Gskt: G467, G468

PF599-30



Fuel/Water Separator Element
Fits: Racor 200 Series Housings
Replaces: Racor 2000 Series
O.D.: 1 3/4 (44.5)
I.D.: 15/32 (11.9) One End
Height: 2 27/32 (72.2)
I.Gskt: [1] Included
O. Gskt: G467, G468

PA602



Air Element
Fits: Chevrolet, Ford, Jeep Automotive;
 Continental, Hercules, Kohler Engines
Replaces: Continental RD6F453; Diamond Reo
 2325H2; Ford ECB-9601-A; Hercules 260820;
 International 863725-C91
O.D.: 9 1/16 (230.2)
I.D.: 6 3/4 (171.5)
Height: 3 5/8 (92.1)

PA604

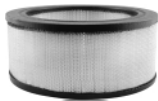

Air Element
Fits: International Engines
Replaces: International 118791-R91
O.D.: 9 1/16 (230.2)
I.D.: 6 3/4 (171.5)
Height: 3 7/8 (98.4)

B605



Full-Flow Lube Spin-on
Fits: Hitachi Equipment; Nissan, Volvo
 Engines, Trucks
Replaces: Nissan 15201-Z9007, FL201-Z9010;
 Volvo 422994
Thread: 1 1/8 -16
O.D.: 4 1/4 (108.0)
Height: 5 27/32 (148.4)
I.Gskt: [1] Included

BT606-MPG



Maximum Performance Glass Hydraulic Spin-on
Fits: Sullair Compressors
Replaces: Sullair 250025-524
Thread: 31/32 -20
O.D.: 3 21/32 (92.9)
Height: 5 5/8 (142.9)
I.Gskt: G381-A

PA607



Air Element
Fits: AMC, Chrysler Light-Duty Trucks
Replaces: AMC 3191205; Chrysler 8991451
O.D.: 10 (254.0)
 Top 10 1/4 (260.4)
I.D.: 7 5/8 (193.7)
Height: 3 1/4 (82.6)

BT610-MPG



Maximum Performance Glass Lube Spin-on
Contains: Integral Post Seal
Fits: Sullair Compressors
Replaces: Sullair 250025-526
Thread: 1 1/4 -11 BSP-PL
O.D.: 4 5/8 (117.5)
Height: 11 9/32 (286.5)
I.Gskt: G498-A

BT611-MPG



Maximum Performance Glass Lube Spin-on
Contains: Integral Post Seal
Fits: Sullair Compressors
Replaces: Sullair 250025-525
Thread: 1 1/4 -11 BSP-PL
O.D.: 4 5/8 (117.5)
Height: 6 9/32 (159.5)
I.Gskt: G498-A

PA612



Air Element
Fits: Chrysler Automotive
Replaces: Chrysler 1739549, 1739649
O.D.: 8 (203.2)
I.D.: 5 3/4 (146.1)
Height: 3 1/2 (88.9)

PA613



Oval Air Element
Fits: Chrysler Automotive
Replaces: Chrysler 1739546
O.D.: 6 3/8 (161.9)
 to 11 1/8 (282.6)
I.D.: 4 1/8 (104.8) & 8 7/8 (225.4)
Height: 3 1/2 (88.9)

Measurements Are Shown In Inches And (Millimeters)

! **WARNING:** These products can expose you to chemicals, including Diisononyl Phthalate, Carbon black extracts, Nickel, 1,3 Butadiene, Ethylene Oxide, Epichlorohydrin, which are known to the State of California to cause cancer, and Bisphenol, Ethylene Glycol, Ethylene Oxide, 1,3 Butadiene, Epichlorohydrin, which are known to the State of California to cause birth defects or other reproductive harm. For more information go to www.P65Warnings.ca.gov.

BF614



Fuel Spin-on

Fits: American Hoist & Derrick, Aveling-Barford, Caterpillar, CMI, Demag, Driltech, Grove, Steiger, Vermeer Equipment; Caterpillar Engines; Chevrolet, Ford, Freightliner, GMC, International, Kenworth, Mack Trucks
Replaces: Caterpillar 1R0712
Thread: 1 -14
O.D.: 3 11/16 (93.7)
Height: 10 1/2 (266.7)
I.Gskt: G381-A
Related To: BF7587 (High Efficiency Version)

PA615



Air Element

Fits: AMC, Chrysler, Jeep Automotive, Light-Duty Trucks
Replaces: Chrysler J8992661; Jeep 999103
O.D.: 10 1/16 (255.6)
I.D.: 7 21/32 (194.5)
Height: 2 3/4 (69.9)

PA616



Air Element

Contains: Integral Post Seal Flame Retardant Media
Fits: Cummins Engines; Hyster Equipment
Replaces: Cummins 3001690; Hyster 202951
O.D.: 10 7/32 (259.6)
I.D.: 7/16 (11.1) & 7 7/8 (200.0)
Height: 12 (304.8)
Related To: PA1913 (Closed End Version for Use in Donaldson Housing)

PA617



Air Element

Contains: Integral Post Seal Flame Retardant Media
Fits: Autocar Trucks; Cummins Engines; Gradall, Hyster Equipment
Replaces: Autocar 860393; Gradall 106338
O.D.: 9 (228.6)
I.D.: 7/16 (11.1) & 6 5/8 (168.3)
Height: 10 (254.0)
A. Gskt: [1] Attached
Related To: PA1700 (Heavy-Duty Version for Use in Fram Housing)

PA618



Air Element

Notes: Used as Cab Air on Massey Ferguson applications.
Fits: Caterpillar, Clark, Hough, Ingersoll-Rand, Marion, Massey Ferguson Equipment; Diamond Reo Trucks
Use With: PA618 FOAM
Replaces: Caterpillar 4L8465
O.D.: 10 7/32 (259.6)
I.D.: 5 1/2 (139.7)
Height: 12 (304.8)

PA618 FOAM



Foam Blanket for PA618

Use With: PA618
Length: 34 1/4 (870.0)
Width: 11 1/2 (292.1)

PA618-S



Air Element

Fits: Caterpillar, CMI, Grove Equipment
Replaces: Caterpillar 4L9852
O.D.: 10 7/32 (259.6)
I.D.: 6 1/16 (154.0) One End
Height: 12 (304.8)
A. Gskt: [1] Attached

PA621



Air Element

Contains: Flame Retardant Media
Fits: Chevrolet Trucks; EVO Trash Compactors
Replaces: GMC 5645166
O.D.: 10 1/32 (254.8)
I.D.: 8 17/32 (216.7)
Height: 3 (76.2)

PA625



Air Element

Fits: GMC Engines, Trucks
Replaces: GMC 25041181
O.D.: 11 5/16 (287.3)
I.D.: 8 17/32 (217.5)
Height: 3 1/16 (77.8)

PA631



Air Element

Fits: Buick, Cadillac, Chevrolet, Oldsmobile, Pontiac Automotive
Replaces: GMC 6421030
O.D.: 17 5/16 (439.7)
Flange: 18 5/16 (465.1)
I.D.: 14 15/16 (379.4)
Height: 2 3/16 (55.6)

PA632



Oval Air Element

Fits: Ford Automotive
Replaces: Ford EDK-9601-A
O.D.: 9 23/32 (246.9) to 20 23/32 (526.3)
I.D.: 7 5/16 (185.7) & 18 5/16 (465.1)
Height: 1 3/4 (44.5)

PA633(2)



Set of 2 Draft Tube Air Breathers

Fits: Ford Trucks; Clark, Grove, Seamaster Equipment
Replaces: Ford C2TZ-6768-A
O.D.: 3 7/8 (98.4)
I.D.: 2 1/2 (63.5)
Height: 1 5/8 (41.3)

PA634



Air Element

Contains: Flame Retardant Media
Fits: Caterpillar Lift Trucks; Continental, Kohler Engines; Divco Trucks
Replaces: Caterpillar 33-3660; Continental F600F428; Divco 6426
O.D.: 6 3/8 (161.9)
Flange: 6 5/8 (168.3)
I.D.: 5 (127.0)
Height: 3 (76.2)

Measurements Are Shown In Inches And (Millimeters)

WARNING: These products can expose you to chemicals, including Diisononyl Phthalate, Carbon black extracts, Nickel, 1,3 Butadiene, Ethylene Oxide, Epichlorohydrin, which are known to the State of California to cause cancer, and Bisphenol, Ethylene Glycol, Ethylene Oxide, 1,3 Butadiene, Epichlorohydrin, which are known to the State of California to cause birth defects or other reproductive harm. For more information go to www.P65Warnings.ca.gov.

PA638

Air Element



Fits: International Equipment
Replaces: International 204514-R91
O.D.: 9 1/8 (231.8)
I.D.: 6 7/8 (174.6)
Height: 6 5/8 (168.3)

PA644

Air Breather Element



Fits: Euclid, Hitachi, Terex Equipment; GMC Engines
Replaces: Euclid 9023871; GMC 6483993
O.D.: 3 1/16 (77.8)
I.D.: 1 9/16 (39.7)
Height: 3 5/8 (92.1)

PA639

Air Element



Fits: Allis Chalmers, Caterpillar, LeTourneau-Westinghouse Equipment; Gardner Denver Compressors
Replaces: Allis Chalmers 70622893; Caterpillar 5M4118; Gardner Denver 2010500
O.D.: 10 1/2 (266.7)
I.D.: 5 5/32 (131.0) & 7 3/4 (196.9)
Height: 10 1/2 (266.7)
A. Gskt: [2] Attached
O. Gskt: [2] G31-AF

PA645

Air Element



Fits: Allis Chalmers, Broyt, Caterpillar, Consolidated, Gardner Denver, Michigan Equipment
Replaces: Allis Chalmers 70620717; Caterpillar 7M2654; Gardner Denver 2008185
O.D.: 12 13/16 (325.4)
I.D.: 5 29/32 (150.0) & 8 11/32 (211.9)
Height: 11 17/32 (292.9)
A. Gskt: [2] Attached
O. Gskt: G34-AF

PA640

Air Element



Contains: Flame Retardant Media
Fits: Chevrolet Automotive; Clark, Eaton Lift Trucks; Ingersoll-Rand, Minneapolis-Moline Equipment; Thermo King Refrigeration Units
Replaces: Clark 668788; Thermo King 11-1282
O.D.: 4 13/32 (111.9)
I.D.: 2 15/16 (74.6)
Height: 7 1/32 (178.6)

PA648

Air Element



Fits: GM Automotive, Light-Duty Trucks, Vans
Replaces: GMC 5648003
O.D.: 9 3/4 (247.7)
I.D.: 7 15/16 (201.6)
Height: 3 (76.2)

PA641

Air Element



Contains: Integral Post Seal
Contains: Flame Retardant Media
Fits: Caterpillar Engines; Diamond Reo Trucks; Gradall, Link-Belt Equipment
Replaces: Caterpillar 5L5035; Diamond Reo 302106PS; White 884310
O.D.: 6 5/8 (168.3)
I.D.: 1/4 (6.4) & 4 1/4 (108.0)
Height: 7 7/8 (200.0)
A. Gskt: [1] Attached
End Seals: [1] Attached

PA649

Air Element



Fits: Cushman, GMC, Outboard Marine Corporation Engines
Replaces: Cushman 111316; GMC 6420249; Outboard Marine Corporation 111949
O.D.: 5 3/8 (136.5)
I.D.: 3 13/16 (96.8)
Height: 3 1/8 (79.4)

PA642

Air Element



Fits: AMC; Dodge, Ford Trucks, Vans; Jeep; Plymouth Voyager
Replaces: AMC 3190562; Ford 3CAZ-9601-A; International 332623-C91; Jeep J3190562
O.D.: 9 11/16 (246.1)
I.D.: 7 15/16 (201.6)
Height: 2 1/4 (57.2)

PA650

Air Element



Fits: Chrysler Automotive, Light-Duty Trucks, Vans
Replaces: Chrysler 2463980
O.D.: 8 (203.2)
Top 8 1/4 (209.6)
I.D.: 6 1/2 (165.1)
Height: 3 (76.2)

PA643

Air Breather Element



Fits: Adams, Clark, Euclid, Hymac, Koehring, LeTourneau-Marathon, LeTourneau-Westinghouse, Massey Ferguson, Michigan, Versatile, Yale Equipment; Kenworth, Mack Trucks
Replaces: Clark 945345; Euclid 123716; LeTourneau VF2049
O.D.: 2 7/8 (73.0)
I.D.: 1 3/8 (34.9)
Height: 2 11/16 (68.3)

PA651

Cab Air Element



Fits: Allis Chalmers, Case, Ford, Massey Ferguson, New Holland Equipment
Replaces: Allis Chalmers 11433412; Case F22437; Ford C7NN-19N551-A; Massey Ferguson 1032944-M1
O.D.: 9 1/8 (231.8)
I.D.: 6 7/8 (174.6)
Height: 7 7/32 (183.4)

PA652

Air Element



Contains: Flame Retardant Media
Fits: Allis Chalmers, Continental, Pettibone-Mulliken Equipment
Replaces: Allis Chalmers 49881320; Continental F600F432; Pettibone Y400F404; Worthington FLR218
O.D.: 6 (152.4)
I.D.: 4 5/8 (117.5)
Height: 3 7/8 (98.4)

Measurements Are Shown In Inches And (Millimeters)



WARNING: These products can expose you to chemicals, including Diisononyl Phthalate, Carbon black extracts, Nickel, 1,3 Butadiene, Ethylene Oxide, Epichlorohydrin, which are known to the State of California to cause cancer, and Bisphenol, Ethylene Glycol, Ethylene Oxide, 1,3 Butadiene, Epichlorohydrin, which are known to the State of California to cause birth defects or other reproductive harm. For more information go to www.P65Warnings.ca.gov.

PA653 Air Element
Fits: American LaFrance Trucks; International Engines
Replaces: American LaFrance 303E5852; Daimler 2732031; International 156073-C91
O.D.: 6 (152.4)
I.D.: 4 5/8 (117.5)
Height: 8 9/16 (217.5)



PA666 Outer Air Element
Fits: Case, Caterpillar, Clark, Galion Equipment
Use With: PA1726
Replaces: Case L32943; Caterpillar 4L4134; Clark 1566067; Galion D63931
O.D.: 12 1/16 (306.4)
I.D.: 7 11/16 (195.3)
Height: 15 (381.0)



PA654 Air Element
Fits: Ford Engines; FWD Corporation Trucks
Replaces: Ford C0TZ-9601-A
O.D.: 12 1/4 (311.2)
I.D.: 9 7/16 (239.7)
Height: 5 3/16 (131.8)



PA669 Air Element with Bail Handle
Contains: Integral Post Seal Flame Retardant Media
Fits: Hyster, Ingersoll-Rand, LeRoi Equipment
Replaces: Hyster 118643; LeRoi H43435; Pettibone 8326
O.D.: 5 15/16 (150.8)
I.D.: 1/4 (6.4) & 3 1/4 (82.6)
Height: 4 (101.6)
A. Gskt: [1] Attached
O. Gskt: G1086-AF



PA655 Air Element
Contains: Integral Post Seal Flame Retardant Media
Fits: International Buses, Engines, Trucks
Replaces: International 150868-R91
O.D.: 8 1/16 (204.8)
I.D.: 7/16 (11.1) & 5 3/4 (146.1)
Height: 7 5/8 (193.7)
A. Gskt: [1] Attached
End Seals: [1] Attached



PT670 Full-Flow Lube or Hydraulic Element with Furnished Gaskets
Contains: Reinforced Centertube
Fits: American Hoist & Derrick, Caterpillar, Clark, Gardner Denver, Koehring, Komatsu, LeRoi, Link-Belt Equipment
Replaces: Caterpillar 1R0659; Deutz 1161212; Komatsu 611-4505-100
O.D.: 3 15/16 (100.0)
I.D.: 1 19/32 (40.5)
Height: 9 9/32 (235.7)
F. Gskt: G171, G214, [1] Included
O. Gskt: G115-MSB, G342, G435
End Seals: [2] Attached
Related To: PT7332 (with Metal Wrapper)



PA656 Air Element
Fits: Athey, Bros Equipment; Cummins Engines; ERF Trucks
Replaces: Cummins 650051
O.D.: 8 7/8 (225.4)
I.D.: 4 11/32 (110.3)
Height: 10 (254.0)



PT670-E Full-Flow Lube or Hydraulic Element without Furnished Gaskets
Contains: Reinforced Centertube
Fits: Caterpillar, DMI, Komatsu, KW-Dart, Unit Rig, WABCO Equipment
Replaces: Caterpillar 1R0659; Deutz 1161212; Komatsu 611-4505-100
O.D.: 3 15/16 (100.0)
I.D.: 1 19/32 (40.5)
Height: 9 9/32 (235.7)
O. Gskt: G115-MSB, G342, G435
End Seals: [2] Attached



PA657 Air Element
Fits: Ford Light-Duty Trucks, Vans
Replaces: Ford C4OZ-9601-A
O.D.: 8 13/32 (213.5)
I.D.: 6 19/32 (167.5)
Height: 3 1/4 (82.6)
Related To: PA2107 (with Foam Wrap)



PA671 Air Element for Purolator Housing
Contains: Flame Retardant Media
Fits: Chrysler Trucks; Jeep
Replaces: Chrysler 2120933
O.D.: 10 7/32 (259.6)
I.D.: 5 1/2 (139.7)
Height: 6 (152.4)



PA658 Air Element
Fits: Chrysler Automotive; GMC Light-Duty Trucks, Vans; Jeep
Replaces: GMC 5648136
O.D.: 9 11/16 (246.1)
I.D.: 8 3/16 (208.0)
Height: 1 7/8 (47.6)
Related To: PA1680 (Long Version)

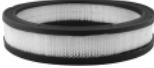

PA662 Air Element
Contains: Integral Post Seal Flame Retardant Media
Fits: Purolator Optional Filter Housings; Sullair Compressors
Replaces: Mack 81SD14
O.D.: 8 1/16 (204.8)
I.D.: 1/4 (6.4) & 5 3/4 (146.1)
Height: 4 (101.6)
A. Gskt: [1] Attached
F. Gskt: [1] Included



PA671-1 Air Element for Fram Housing
Fits: Chrysler, Mack Engines
Replaces: Mack 3076145756
O.D.: 10 1/4 (260.4)
I.D.: 7 3/8 (187.3)
Height: 6 (152.4)



Measurements Are Shown In Inches And (Millimeters)

WARNING: These products can expose you to chemicals, including Diisononyl Phthalate, Carbon black extracts, Nickel, 1,3 Butadiene, Ethylene Oxide, Epichlorohydrin, which are known to the State of California to cause cancer, and Bisphenol, Ethylene Glycol, Ethylene Oxide, 1,3 Butadiene, Epichlorohydrin, which are known to the State of California to cause birth defects or other reproductive harm. For more information go to www.P65Warnings.ca.gov.

PA675 Air Element
Contains: Flame Retardant Media
Fits: Clark Lift Trucks; Onan Engines, Generators
Replaces: Clark 1800562; Fiat 2019740; Onan 140B495
O.D.: 4 1/4 (108.0)
I.D.: 3 (76.2)
Height: 3 5/16 (84.1)



PT683 Wire Backed Hydraulic Element
Replaces: Fairey-Arlon 370L310
O.D.: 3 21/32 (92.9)
I.D.: 1 1/4 (31.8) & 1 7/8 (47.6)
Height: 12 15/32 (316.7)
I.Gskt: [1] Included
O-Ring: [1] Included
Spring: [1] Included



PT676 Hydraulic Element
Fits: Aveling-Barford, Hymac, Kalmar, Moxy Equipment
Replaces: Fairey-Arlon 370L210
O.D.: 3 11/16 (93.7)
I.D.: 1 7/8 (47.6)
Height: 7 27/32 (199.2)
F. Gskt: [1] Included
O-Ring: [1] Attached



PT685-MPG Hydraulic Element
Fits: Ford Loaders
O.D.: 3 3/32 (78.6)
I.D.: 1 11/16 (42.9)
Height: 8 3/16 (208.0)
O-Ring: [1] Attached



PA677 Air Element
Fits: Bolens, Briggs & Stratton, Kohler Engines
Replaces: Briggs & Stratton 296186; International 385163-R91; Kohler 236840
O.D.: 4 1/4 (108.0)
I.D.: 3 (76.2)
Height: 1 1/2 (38.1)



PA691 Air Element
Fits: AMC, Fiat, Lada, Renault Automotive
Replaces: Renault 8983500079
O.D.: 9 (228.6)
I.D.: 7 1/2 (190.5)
Height: 2 15/32 (62.7)



PA678 Air Element
Fits: Lawn & Garden Tractors with Kohler, Tecumseh Engines
Replaces: Kohler 235116, 4708302; Tecumseh 10059, 32008
O.D.: 6 1/16 (154.0)
I.D.: 4 5/8 (117.5)
Height: 1 15/16 (49.2)



PT691 Hydraulic Element
Fits: Iveco, Kassbohrer, M.A.N., Mercedes-Benz Buses; DAF, Iveco, M.A.N., Mercedes-Benz, R.V.I., Volvo Trucks
Replaces: Bosch 1-457-429-165; Deutz 1267900; Volvo 323139
O.D.: 3 9/32 (83.3)
I.D.: 17/32 (13.5)
Height: 4 9/16 (115.9)
Grommets: [2] Attached



PT679 Hydraulic Element
Fits: Aveling-Barford Equipment
Replaces: Aveling-Barford SWT603051; Fairey-Arlon 370L110
O.D.: 3 11/16 (93.7)
I.D.: 1 29/32 (48.4) One End
Height: 3 29/32 (99.2)
F. Gskt: [1] Included
O-Ring: [1] Attached



PA693 Air Element
Fits: Chrysler Automotive, Light-Duty Trucks, Vans
Replaces: Chrysler 2402677
O.D.: 12 3/4 (323.9)
I.D.: 11 (279.4)
Height: 3 1/2 (88.9)



PA680 Cab Air Element
Fits: Hough Loaders; International, John Deere, Massey Ferguson Equipment with Excello Cabs
Replaces: Case K963803; Hough 87924-C1; Wayne 6049133
O.D.: 7 (177.8)
I.D.: 4 7/8 (123.8)
Height: 4 7/16 (112.7)



PT694 Hydraulic Element
Notes: Inside-Out Flow Direction
Fits: John Deere Equipment
Replaces: John Deere AT78046
O.D.: 4 3/8 (111.1)
I.D.: 2 7/16 (61.9) One End
Height: 16 (406.4)



PT682 Hydraulic Element
Fits: Hymac Equipment
Replaces: Hymac 2700210
O.D.: 4 31/32 (126.2)
I.D.: 13/32 (10.3) & 3 5/8 (92.1)
Height: 8 9/32 (210.3)



PA696 Air Element
Fits: David Brown Tractors
Replaces: Davis 913601
O.D.: 5 3/4 (146.1)
I.D.: 3 1/2 (88.9)
Height: 2 9/16 (65.1)



Measurements Are Shown In Inches And (Millimeters)

! **WARNING:** These products can expose you to chemicals, including Diisononyl Phthalate, Carbon black extracts, Nickel, 1,3 Butadiene, Ethylene Oxide, Epichlorohydrin, which are known to the State of California to cause cancer, and Bisphenol, Ethylene Glycol, Ethylene Oxide, 1,3 Butadiene, Epichlorohydrin, which are known to the State of California to cause birth defects or other reproductive harm. For more information go to www.P65Warnings.ca.gov.

PA697 Air Element
Fits: BMW Motorcycles; Mercedes-Benz Trucks, Vans; Stihl Saws
Replaces: BMW 13720043524
O.D.: 3 7/8 (98.4)
I.D.: 2 11/32 (59.5)
Height: 2 3/4 (69.9)



PA699 Air Element
Fits: CompAir Compressors
Replaces: Joy RA221375
O.D.: 6 13/16 (173.0)
I.D.: 5 1/16 (128.6)
Height: 3 1/16 (77.8)



C704-L Vac-Cel By-Pass Lube Element with Bail Handle
Fits: Ag-Chem, Allis Chalmers, Fiat-Allis, Hymac, Versatile Equipment; Luber-finer Model 500 Housing
Replaces: GMC 25010761; Komatsu 667-150-5300; Mack 485GB3116P1; Volvo 1695007
O.D.: 7 11/16 (195.3)
I.D.: 7/8 (22.2)
Height: 10 (254.0)
O. Gskt: G155, G157, G238, G252, G309-B, ES1375, ES1376, ES1377



P706-M Dual-Flow Lube Element with Bail Handle
Notes: Inside-Out Flow Direction
Fits: Mack Trucks
Replaces: Mack 236GB311A; WGB S118CP
O.D.: 7 1/2 (190.5)
I.D.: 23/32 (18.3)
Height: 14 15/16 (379.4)
A. Gskt: [2] Attached
O. Gskt: G157



PT707-HD Hydraulic Element
Fits: Allis Chalmers, Big Bud, Schroeder, WABCO Equipment
Replaces: Allis Chalmers 1900201; Caterpillar 9Y4522; Komatsu 145-491-1580; Schroeder K-Series
O.D.: 3 15/16 (100.0)
I.D.: 1 19/32 (40.5)
Height: 9 9/32 (235.7)
O. Gskt: G417
Grommets: [2] Attached
Related To: PT757, PT757-10 (Double-Length Versions)



PT707-HD10 Hydraulic Element
Fits: Bantam, Caterpillar, Lorain, Massey Ferguson, Schroeder Equipment
Replaces: Allis Chalmers 1900201; Caterpillar 9Y4522; Komatsu 145-491-1580; Schroeder K-Series
O.D.: 3 15/16 (100.0)
I.D.: 1 19/32 (40.5)
Height: 9 9/32 (235.7)
O. Gskt: G417
Grommets: [2] Attached
Related To: PT757, PT757-10 (Double-Length Versions)



PT707-HD3 Hydraulic Element
Fits: Gardner Denver, Ingersoll-Rand, Timbco Equipment
Replaces: Allis Chalmers 1900201; Caterpillar 9Y4522; Komatsu 145-491-1580; Schroeder K-Series
O.D.: 3 15/16 (100.0)
I.D.: 1 19/32 (40.5)
Height: 9 9/32 (235.7)
O. Gskt: G417
Grommets: [2] Attached
Related To: PT757, PT757-10 (Double-Length Versions)



PT708-HD Hydraulic Element
Fits: Komatsu Equipment
Replaces: Komatsu 281-16-11290
O.D.: 3 15/16 (100.0)
I.D.: 1 5/8 (41.3)
Height: 9 1/4 (235.0)
End Seals: [2] Attached



PT714 Hydraulic Element
Fits: WABCO Earth Moving Equipment
Replaces: WABCO PB4545
O.D.: 5 1/8 (130.2)
I.D.: 3 3/8 (85.7)
Height: 18 5/8 (473.1)
End Seals: [2] Attached



PT716 In-Line Hydraulic Filter
Fits: Hyster, Toyota Lift Trucks
Replaces: Hyster 313796, 1360557; Toyota 67502-20540-71
O.D.: 4 13/16 (122.2)
Inlet: 1
Outlet: 1
Height: 7 7/8 (200.0)
Related To: PT8435-MPG (Maximum Performance Glass Version with 25 PSI By-Pass Valve)



PF717 Fuel Element
Fits: Daewoo, Ford, Gehl, John Deere, Kobelco, Komatsu, Kubota, Massey Ferguson, Mustang, New Holland, Takeuchi, Thomas, Yanmar Equipment
Replaces: Ford SBA130366060; John Deere T111383; Kubota 15521-43160
O.D.: 1 31/32 (50.0)
I.D.: 25/32 (19.8)
Height: 3 1/2 (88.9)



P718-5 Hydraulic Element
Fits: Hilco Optional Housings
O.D.: 6 (152.4)
I.D.: 2 5/8 (66.7)
Height: 16 (406.4)
End Seals: [2] Attached



Measurements Are Shown In Inches And (Millimeters)

WARNING: These products can expose you to chemicals, including Diisononyl Phthalate, Carbon black extracts, Nickel, 1,3 Butadiene, Ethylene Oxide, Epichlorohydrin, which are known to the State of California to cause cancer, and Bisphenol, Ethylene Glycol, Ethylene Oxide, 1,3 Butadiene, Epichlorohydrin, which are known to the State of California to cause birth defects or other reproductive harm. For more information go to www.P65Warnings.ca.gov.

BF719

Fuel Spin-on



Fits: Iveco, R.V.I. Trucks
Replaces: Renault 870175600, 947718018
Thread: 3/4 -16
O.D.: 3 11/16 (93.7)
Height: 4 3/8 (111.1)
I.Gskt: G324-A

BF720

Fuel Spin-on



Contains: Integral Post Seal
Fits: Caterpillar, Kobelco, MDI, Mitsubishi Equipment
Replaces: Caterpillar 96-6396; Kobelco 2451U-1722A; Mitsubishi ME035829
Thread: M20 x 1.5
O.D.: 3 11/16 (93.7)
Height: 4 3/8 (111.1)
I.Gskt: G324-A

P721

Full-Flow Lube Element



Fits: Claas Combines; M.A.N., R.V.I. Trucks; Mercedes-Benz Buses, Trucks; Zettelmeyer Equipment
Replaces: Claas 1334990; M.A.N. 81-05504-0025; Mercedes-Benz 3521800209; Zettelmeyer 2132170
O.D.: 4 1/2 (114.3)
I.D.: 2 1/4 (57.2)
Height: 7 11/16 (195.3)

PT722

Hydraulic Element



Fits: Broyt Excavators; Poclain, Volvo Loaders
Replaces: Volvo 6210359-3
O.D.: 4 31/32 (126.2)
I.D.: 13/32 (10.3) & 3 5/8 (92.1)
Height: 11 7/16 (290.5)
Grommets: [1] Attached
Related To: PT8414-MPG (Maximum Performance Glass Version)

P723

Full-Flow Lube Element



Contains: Reinforced Centertube
Fits: Furukawa, Hino, Hitachi, Kawasaki, Kobelco, Koehring, Link-Belt, Sakai Equipment; Hino, Nissan Trucks; Isuzu Engines
Replaces: Hino 15607-1410; Hitachi 4092039; Isuzu 1-87810-075-01; Nissan 15208-Z9025
O.D.: 3 15/16 (100.0)
I.D.: 1/2 (12.7) & 2 1/4 (57.2)
Height: 6 1/2 (165.1)
F. Gskt: [2] Included

PT725-MPG

Maximum Performance Glass Hydraulic Element



Fits: Barber-Greene, John Deere Equipment
Replaces: John Deere AT120544
O.D.: 4 1/2 (114.3)
I.D.: 2 1/4 (57.2) One End
Height: 9 11/16 (246.1)
I.Gskt: [1] Included

PT727-DL

Double-Length Hydraulic Element



Fits: Schroeder Equipment
Replaces: Schroeder AA25
O.D.: 3 (76.2)
I.D.: 1 (25.4)
Height: 9 13/16 (249.2)
O-Ring: [2] Included

PT727-HD

Hydraulic Element



Fits: Bomag, Schroeder Equipment
Replaces: Schroeder A25
O.D.: 3 (76.2)
I.D.: 1 (25.4)
Height: 4 7/8 (123.8)
O-Ring: [2] Attached

PT727-HD10

Hydraulic Element



Fits: Bomag, Schroeder Equipment
Replaces: Schroeder A10
O.D.: 3 (76.2)
I.D.: 1 (25.4)
Height: 4 7/8 (123.8)
O-Ring: [2] Attached

PT728-MPG

Maximum Performance Glass Hydraulic Element



Fits: John Deere Equipment
Replaces: John Deere AT67957
O.D.: 2 7/8 (73.0)
I.D.: 1 1/8 (28.6)
Height: 3 5/8 (92.1)
A. Gskt: [2] Attached

PT729

Transmission Element



Fits: Bobcat Loaders
Replaces: Clark 233333
O.D.: 6 (152.4)
I.D.: 2 5/32 (54.8)
Height: 17 5/32 (435.8)
I.Gskt: [2] Included
F. Gskt: G206, [1] Included

BT732

Glass Hydraulic Spin-on



Notes: Can be used with OB8711, OB8712, OB8720, OB8721, OB8722, OB8724, OB8731, OB8732, OB8741, OB8742, OB8743, OB8744, OB8745, OB8746 filter bases.
Fits: Caterpillar Paving Equipment
Replaces: Caterpillar 8T7478
Thread: 1 3/8 -12
O.D.: 3 3/4 (95.3)
Height: 6 1/8 (155.6)
I.Gskt: [1] Included

Measurements Are Shown In Inches And (Millimeters)



WARNING: These products can expose you to chemicals, including Diisononyl Phthalate, Carbon black extracts, Nickel, 1,3 Butadiene, Ethylene Oxide, Epichlorohydrin, which are known to the State of California to cause cancer, and Bisphenol, Ethylene Glycol, Ethylene Oxide, 1,3 Butadiene, Epichlorohydrin, which are known to the State of California to cause birth defects or other reproductive harm. For more information go to www.P65Warnings.ca.gov.

BT735



Hydraulic Spin-on

Contains: 30 PSID By-Pass Valve
Fits: Atlas-Weyhausen, Bomag, Demag, Kramer, Liebherr, Moxy, V.M.E., Volvo Equipment
Replaces: Volvo 4787923-4
Thread: 1 -12
O.D.: 3 23/32 (94.5)
Height: 8 7/32 (208.8)
I.Gskt: G401
Related To: BT739 (with Adapter)

PT737



Hydraulic Element

Fits: Ingersoll-Rand, Jaeger, Joy Equipment; Schroeder Hydraulic Systems
Replaces: Schroeder J25
O.D.: 3 17/32 (89.7)
I.D.: 1 5/8 (41.3)
Height: 9 1/4 (235.0)
End Seals: [2] Attached

PT737-10



Hydraulic Element

Fits: Ingersoll-Rand, Jaeger, Joy Equipment; Schroeder Hydraulic Systems
Replaces: Schroeder J10
O.D.: 3 17/32 (89.7)
I.D.: 1 5/8 (41.3)
Height: 9 1/4 (235.0)
End Seals: [2] Attached

V738-O



Vac-Cel Dual-Stage Full-Flow Lube Sock

Fits: Oliver, Winslow Equipment
Replaces: Joy 243211; Oliver 175526AS; Winslow CP738O
O.D.: 3 5/8 (92.1)
I.D.: 1 9/32 (27.1) & 1 1/16 (27.0)
Height: 7 3/16 (182.6)
F. Gskt: G127, [1] Included

BT739



Transmission Spin-on

Contains: 30 PSID By-Pass Valve
 Stud Thread: M24 x 1.5
Fits: Case, John Deere, Moxy Equipment
Replaces: John Deere AT102377, AT140030
Thread: 1 -12
O.D.: 3 23/32 (94.5)
Height: 8 7/8 (225.4)
I.Gskt: G401
Related To: BT735 (without Adapter)

C740-S



Wound Cotton Glycol Sock

Replaces: Stay Ready SRPSP68
O.D.: 3 1/16 (77.8)
I.D.: 1 11/16 (42.9)
Height: 7 9/32 (184.9)

C750-E



750 Size Depth-Pack By-Pass Lube Element with Bail Handle

Notes: To convert to spin-on, use OB1308 and B7577.
 C750-L has 1.5 pounds additional media.
Fits: Allis Chalmers, Clark, Demag, Fiat-Allis, Foden, Hymac, Komatsu, M.A.N., Steiger, Volvo Equipment; Luber-finer Model 750 Housing and All Model 750 Housings Except Stay Ready Housing
Replaces: Luber-finer 750, 750B, 750M1C, 2091, 3118, 3730
O.D.: 7 23/32 (196.1)
I.D.: 29/32 (23.0)
Height: 15 3/32 (383.4)
O. Gskt: G155, G157, G238, G252, G309-B, ES1375, ES1376, ES1377
Related To: C750-L (1.5 pounds more media) F7500 (Fuel Version) P7500 (Extended Life Version)

C750-L



750 Size Vac-Cel By-Pass Lube Element with Bail Handle

Notes: To convert to spin-on, use OB1308 and B7577.
 C750-L has 1.5 pounds additional media.
Fits: Allis Chalmers, Clark, Demag, Fiat-Allis, Foden, Hymac, Komatsu, M.A.N., Steiger, Volvo Equipment; Luber-finer Model 750 Housing and All Model 750 Housings Except Stay Ready Housing
Replaces: Luber-finer 750, 750B, 750M1C, 2091, 3118, 3730
O.D.: 7 23/32 (196.1)
I.D.: 29/32 (23.0)
Height: 15 3/32 (383.4)
O. Gskt: G155, G157, G238, G252, G309-B, ES1375, ES1376, ES1377
Related To: C750-E (Different amount of media) F7500 (Fuel Version) P7500 (Extended Life Version)

C750-L SINGLE Individually Boxed Version of C750-L



Notes: To convert to spin-on, use OB1308 and B7577.
Fits: Allis Chalmers, Clark, Demag, Fiat-Allis, Foden, Hymac, Komatsu, M.A.N., Steiger, Volvo Equipment; Luber-finer Model 750 Housing and All Model 750 Housings Except Stay Ready Housing
Replaces: Luber-finer 750, 750B, 750M1C, 2091, 3118, 3730
O.D.: 7 23/32 (196.1)
I.D.: 29/32 (23.0)
Height: 15 3/32 (383.4)
O. Gskt: G155, G157, G238, G252, G309-B, ES1375, ES1376, ES1377
Related To: F7500 (Fuel Version) P7500 (Extended Life Version)

PT751



Hydraulic Element

Notes: Inside-Out Flow Direction
Contains: Standpipe
Fits: Hyster Lift Trucks
Replaces: Hyster 190786
O.D.: 4 (101.6)
I.D.: 1 1/4 (31.8) & 1 9/16 (39.7)
Height: 14 7/8 (377.8)
I.Gskt: [1] Included

Measurements Are Shown In Inches And (Millimeters)

WARNING: These products can expose you to chemicals, including Diisononyl Phthalate, Carbon black extracts, Nickel, 1,3 Butadiene, Ethylene Oxide, Epichlorohydrin, which are known to the State of California to cause cancer, and Bisphenol, Ethylene Glycol, Ethylene Oxide, 1,3 Butadiene, Epichlorohydrin, which are known to the State of California to cause birth defects or other reproductive harm. For more information go to www.P65Warnings.ca.gov.

PT752



Hydraulic Element

Contains: Reinforced Centertube
Replaces: Clark 2526831
O.D.: 4 3/8 (111.1)
I.D.: 2 13/32 (61.1)
Height: 16 1/16 (408.0)
A. Gskt: [2] Attached

PT761

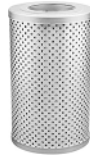

Hydraulic Element

Fits: Ingersoll-Rand, Massey Ferguson Equipment
Replaces: Ingersoll-Rand 35280825
O.D.: 4 3/8 (111.1)
I.D.: 2 7/16 (61.9)
Height: 8 1/16 (204.8)
A. Gskt: [2] Attached

PT753



Hydraulic Element

Fits: Case Equipment
Replaces: Fairey-Arlon TXX12-R-10
O.D.: 8 (203.2)
I.D.: 9/16 (14.3) & 6 3/16 (157.2)
Height: 21 1/2 (546.1)
I. Gskt: [1] Included
F. Gskt: [2] Included

PT763



Hydraulic Element

Notes: Inside-Out Flow Direction
Fits: Grove Cranes; Ingersoll-Rand Equipment
Replaces: Grove 9437100156; Ingersoll-Rand 35997352
O.D.: 4 3/8 (111.1)
I.D.: 23/32 (18.3) & 2 7/16 (61.9)
Height: 16 1/16 (408.0)
A. Gskt: [1] Attached
Grommets: [1] Attached

PT757



Hydraulic Element

Fits: Schroeder Hydraulic Systems
Replaces: Schroeder KK Series
O.D.: 3 15/16 (100.0)
I.D.: 1 19/32 (40.5)
Height: 18 1/2 (469.9)
Grommets: [2] Attached
Related To: PT707, PT707-10 (Single-Length Versions)

PT764



Hydraulic Element

Fits: Ingersoll-Rand Compressors
Replaces: Ingersoll-Rand 35280809
O.D.: 4 3/8 (111.1)
I.D.: 2 13/32 (61.1)
Height: 5 (127.0)
A. Gskt: [2] Attached

PT757-10



Hydraulic Element

Fits: Schroeder Hydraulic Systems
Replaces: Schroeder KK Series
O.D.: 3 15/16 (100.0)
I.D.: 1 19/32 (40.5)
Height: 18 1/2 (469.9)
Grommets: [2] Attached
Related To: PT707, PT707-10 (Single-Length Versions)

PT765



Hydraulic Element

Notes: Inside-Out Flow Direction
Fits: Ingersoll-Rand Compressors
Replaces: Ingersoll-Rand 50469055
O.D.: 4 3/8 (111.1)
I.D.: 23/32 (18.3) & 2 13/32 (61.1)
Height: 5 (127.0)
A. Gskt: [1] Attached
Grommets: [1] Attached

PT760-10



Hydraulic Element

Notes: Inside-Out Flow Direction
Fits: Allis Chalmers, Case, Dresser, Galion, Massey Ferguson Equipment
Replaces: Allis Chalmers 2698561; Case S232253; Galion D141064; Ingersoll-Rand 35290444
O.D.: 4 3/8 (111.1)
I.D.: 23/32 (18.3) & 2 7/16 (61.9)
Height: 8 (203.2)
O. Gskt: G439
Grommets: [1] Attached

PT766



Hydraulic Element

Notes: Inside-Out Flow Direction
Fits: Case, Drott Equipment
Replaces: Case S111605
O.D.: 4 3/8 (111.1)
I.D.: 23/32 (18.3) & 2 13/32 (61.1)
Height: 13 1/32 (331.0)
A. Gskt: [1] Attached
Grommets: [1] Attached

PT760-25



Hydraulic Element

Notes: Inside-Out Flow Direction
Fits: Allis Chalmers, Galion, Ingersoll-Rand, Massey Ferguson Equipment
Replaces: Galion D136601; Ingersoll-Rand 35328509; Massey Ferguson 1051399-M91
O.D.: 4 3/8 (111.1)
I.D.: 23/32 (18.3) & 2 7/16 (61.9)
Height: 8 (203.2)
O. Gskt: G439
Grommets: [1] Attached

PT767



Hydraulic Element

Notes: Inside-Out Flow Direction
Fits: Case Equipment; Ingersoll-Rand Compressors
Replaces: Ingersoll-Rand 50693886
O.D.: 4 3/8 (111.1)
I.D.: 23/32 (18.3) & 2 7/16 (61.9)
Height: 16 1/16 (408.0)
A. Gskt: [1] Attached
Grommets: [1] Attached

Measurements Are Shown In Inches And (Millimeters)



WARNING: These products can expose you to chemicals, including Diisononyl Phthalate, Carbon black extracts, Nickel, 1,3 Butadiene, Ethylene Oxide, Epichlorohydrin, which are known to the State of California to cause cancer, and Bisphenol, Ethylene Glycol, Ethylene Oxide, 1,3 Butadiene, Epichlorohydrin, which are known to the State of California to cause birth defects or other reproductive harm. For more information go to www.P65Warnings.ca.gov.

PT768

Hydraulic Element



Notes: Inside-Out Flow Direction
Fits: Case, New Holland, Versatile Tractors
Replaces: Versatile 63297
O.D.: 4 13/32 (111.9)
I.D.: 23/32 (18.3) & 2 7/16 (61.9)
Height: 16 1/16 (408.0)
A. Gskt: [1] Attached
Grommets: [1] Attached

PT777

Hydraulic Element



Notes: Inside-Out Flow Direction
Replaces: Ingersoll-Rand 39123211
O.D.: 4 3/8 (111.1)
I.D.: 5/8 (15.9) & 23/32 (18.3)
Height: 8 (203.2)
A. Gskt: [1] Attached
O-Ring: [1] Included
Grommets: [1] Attached

PT772

Hydraulic Element



Notes: Inside-Out Flow Direction
Fits: Case, Drott, Michigan Equipment
Replaces: Case S111118; Clark 960641
O.D.: 4 3/8 (111.1)
I.D.: 23/32 (18.3) & 2 13/32 (61.1)
Height: 13 1/32 (331.0)
A. Gskt: [1] Attached
Grommets: [1] Attached

BT778

Hydraulic Spin-on



Contains: 15 PSID Front-End Check Valve
 30 PSID By-Pass Valve
Fits: Allis Chalmers, Deutz Equipment
Replaces: Deutz 4305722
Thread: 1 -12
O.D.: 3 11/16 (93.7)
Height: 8 23/32 (221.5)
I.Gskt: G381-A

PT773-MPG

Maximum Performance Glass Hydraulic Element



Notes: Inside-Out Flow Direction
Replaces: Ingersoll-Rand 35330133
O.D.: 4 3/8 (111.1)
I.D.: 3/4 (19.1) & 2 7/16 (61.9)
Height: 16 1/16 (408.0)
A. Gskt: [1] Included
O-Ring: [1] Included
Grommets: [1] Attached

BT779

Transmission Spin-on



Fits: Caterpillar Equipment
Replaces: Caterpillar 9T1119
Thread: 13/16 -16
O.D.: 3 11/16 (93.7)
Height: 2 29/32 (73.8)
I.Gskt: G401

BT774

Hydraulic Spin-on



Fits: Dresser, Hough Equipment
Replaces: International 1106643-C1,
 1106643-C2
Thread: 3 -8
O.D.: 5 (127.0)
Height: 12 1/4 (311.2)

BF781

Primary Fuel Spin-on with Drain



Notes: Can be used with FB1301 base.
Contains: Drain Hose Adapter
Fits: GMC Buses, Light-Duty Trucks, Vans;
 Detroit Diesel Engines; Generac RV Generators
Replaces: GMC 25011285
Thread: 1 -12
O.D.: 3 11/16 (93.7)
Height: 6 1/8 (155.6)
I.Gskt: [1] Included

BT775

Hydraulic Spin-on



Fits: Dresser, Hough Equipment
Replaces: International 1103462-C1,
 1103462-C2
Thread: 3 -8
O.D.: 5 (127.0)
Height: 8 13/16 (223.8)

BF782

Secondary Fuel Spin-on



Contains: Integral Post Seal
Fits: GMC Buses, Light-Duty Trucks, Vans;
 Detroit Diesel Engines
Replaces: GMC 25011214
Thread: M16 x 1.5
O.D.: 3 (76.2)
Height: 4 27/32 (123.0)
I.Gskt: G449-B

PT776-MPG

Maximum Performance Glass Hydraulic Element



Notes: Inside-Out Flow Direction
Replaces: Gardner Denver 2109093
O.D.: 4 3/8 (111.1)
I.D.: 3/4 (19.1) & 2 7/16 (61.9)
Height: 8 1/16 (204.8)
A. Gskt: [1] Attached
F. Gskt: [1] Washer
O-Ring: [2] Included
Grommets: [1] Attached

BF783

Secondary Fuel Spin-on



Fits: Allis Chalmers, Astra, Benfra, Fiat-Allis,
 New Holland Equipment; Iveco Buses, Engines,
 Trucks
Replaces: Fiat 1909103
Thread: 3/4 -16
O.D.: 4 1/4 (108.0)
Height: 7 11/32 (186.5)
I.Gskt: G381-A

Measurements Are Shown In Inches And (Millimeters)

WARNING: These products can expose you to chemicals, including Diisononyl Phthalate, Carbon black extracts, Nickel, 1,3 Butadiene, Ethylene Oxide, Epichlorohydrin, which are known to the State of California to cause cancer, and Bisphenol, Ethylene Glycol, Ethylene Oxide, 1,3 Butadiene, Epichlorohydrin, which are known to the State of California to cause birth defects or other reproductive harm. For more information go to www.P65Warnings.ca.gov.

BF784



Primary Fuel Spin-on

Notes: Can be used with FB1309 base.
Contains: Integral Post Seal
Fits: American Hoist & Derrick, Demag, Dresser, Komatsu, Terex Equipment; Detroit Diesel Engines
Replaces: Detroit Diesel 23518528
Thread: 1 1/4 -12
O.D.: 4 21/32 (118.3)
Height: 9 1/2 (241.3)
I.Gskt: [1] Included

BF785



Secondary Fuel Spin-on

Notes: Can be used with FB1310 base.
Contains: Integral Post Seal
Fits: American Hoist & Derrick, Demag, Dresser, Komatsu, Terex Equipment; Detroit Diesel Engines
Thread: 1 1/16 -16
O.D.: 4 21/32 (118.3)
Height: 9 1/2 (243.7)
I.Gskt: [1] Included

BF786



Fuel Spin-on

Contains: Integral Post Seal
Fits: Ford Light-Duty Trucks, Vans; International Diesel Engines
Replaces: International 1804459-C1
Thread: 7/8 -14
O.D.: 4 1/4 (108.0)
Height: 4 11/16 (119.1)
I.Gskt: G381-A

BF788



Secondary Fuel Spin-on

Notes: CAUTION: Furnished O-Ring must be installed on post for seal.
Contains: Standpipe
Fits: Case, Consolidated Diesel, Cummins Engines; Komatsu Equipment
Replaces: Case J903640; Cummins 3903640
Thread: M16 x 1.5
O.D.: 3 1/32 (77.0)
Height: 4 27/32 (123.0)
I.Gskt: G449-B
O-Ring: [1] Included

BF789



Fuel Spin-on

Fits: Ford Light-Duty Trucks; Gehl, John Deere, Kohler, Thomas, Westerbeke Equipment
Replaces: Ford E3TZ-9155-B
Thread: M20 x 1.5
O.D.: 3 11/16 (93.7)
Height: 3 7/8 (98.4)
I.Gskt: G381-A

BF790



Fuel Spin-on

Fits: Atlas Copco, Bandit, Bobcat, Bomag, Case, Demag, Ditch Witch, Dynapac, Grove, International, Manitou, Vermeer, Volvo Equipment; Deutz, MWM Engines
Replaces: Bosch 1-457-434-069; Deutz 1161341; Melroe-Bobcat 4121609
Thread: M16 x 1.5
O.D.: 3 1/32 (77.0)
Height: 3 15/32 (88.1)
I.Gskt: G449-B
Related To: BF7915 Short Version

BF791



Fuel/Water Separator Spin-on

Fits: Crusader, Mercruiser, Volvo-Penta Engines
Replaces: Mercruiser 3560494
Thread: 11/16 -16
O.D.: 3 11/16 (93.7)
Height: 3 7/8 (98.4)
I.Gskt: G381-A

BF791-O



Fuel/Water Separator Spin-on with Open Port for Bowl

Contains: Port Thread: 3 1/4-10
Fits: Quicksilver Outboard Applications
Replaces: Racor S3213
Thread: 11/16 -16
O.D.: 3 25/32 (96.0)
Height: 4 1/32 (102.4)
F. Gskt: [2] Included
O-Ring: [1] Included

BF792



Fuel Spin-on

Contains: Integral Post Seal
Fits: Caterpillar, Kobelco, MDI, Mitsubishi Equipment
Replaces: Mitsubishi ME016823
Thread: M20 x 1.5
O.D.: 3 23/32 (94.5)
Height: 3 7/8 (98.4)
I.Gskt: G324-A

BF794



In-Line Fuel Filter

Fits: Chrysler Automotive, Vans
Replaces: Chrysler 4443462
O.D.: 2 5/32 (54.8)
Inlet: 5/16
Outlet: 5/16
Length: 4 (101.6)

BF795



In-Line Fuel Filter

Fits: Chrysler Automotive, Vans
Replaces: Chrysler 4443463
O.D.: 2 5/16 (58.7)
Inlet: 5/16
Outlet: 5/16
Length: 4 11/32 (110.3)

BF797



Fuel Spin-on

Fits: Iveco, R.V.I. Trucks
Replaces: Renault 3036404
Thread: 3/4 -16
O.D.: 3 11/16 (93.7)
Height: 5 3/8 (136.5)
I.Gskt: G381-A

BF798



Fuel Spin-on

Contains: Integral Post Seal
Fits: Case, Caterpillar, Hitachi, Kobelco, Link-Belt, Mitsubishi, Tadano Equipment
Replaces: Caterpillar 96-9625; Kobelco 2451U-2112; Mitsubishi ME056280
Thread: M24 x 1.5
O.D.: 3 11/16 (93.7)
Height: 6 9/16 (167.5)
I.Gskt: [1] Included

Measurements Are Shown In Inches And (Millimeters)

! WARNING: These products can expose you to chemicals, including Diisononyl Phthalate, Carbon black extracts, Nickel, 1,3 Butadiene, Ethylene Oxide, Epichlorohydrin, which are known to the State of California to cause cancer, and Bisphenol, Ethylene Glycol, Ethylene Oxide, 1,3 Butadiene, Epichlorohydrin, which are known to the State of California to cause birth defects or other reproductive harm. For more information go to www.P65Warnings.ca.gov.

BF799

Fuel Spin-on



Contains: Integral Post Seal
Fits: Caterpillar Equipment
Replaces: Caterpillar 1R0715, 8N3080
Thread: 1 3/8 -16
O.D.: 5 3/8 (136.5)
Height: 12 3/32 (307.2)
I.Gskt: [1] Included

PF809

Fuel Element with Bail Handle



Fits: Allis Chalmers, Case, Caterpillar, Continental, Euclid, Massey Ferguson, Oliver Equipment
Replaces: Allis Chalmers 43711640; Case 73220; Massey Ferguson 1006589-M92
O.D.: 4 7/32 (107.2)
I.D.: 1/2 (12.7)
Height: 4 7/8 (123.8)
F. Gskt: G104
Grommets: [2] Attached
Related To: P41 (By-Pass Lube Version)

PF802

Fuel Element



Fits: Allis Chalmers Tractors; Detroit Diesel Engines
Replaces: Allis Chalmers 853361; GMC 853695
O.D.: 2 7/8 (73.0)
I.D.: 1/2 (12.7) & 1 (25.4)
Height: 4 7/32 (107.2)
A. Gskt: [2] Attached
F. Gskt: [1] Included

PF810

Fuel Element



Fits: Allis Chalmers, Caterpillar, Clark, Waukesha Engines, Equipment
Replaces: Allis Chalmers 43711650; Clark 944475; Waukesha 151137
O.D.: 3 (76.2)
I.D.: 1 1/16 (27.0)
Height: 7 13/16 (198.4)
A. Gskt: [2] Attached
F. Gskt: [3] Included
O. Gskt: G344

PF804

Fuel Element



Fits: Detroit Diesel Engines; Gorman Rupp Pumps
Replaces: GMC 6438498
O.D.: 3 7/16 (87.3)
I.D.: 7/16 (11.1) & 1/2 (12.7)
Height: 5 23/32 (145.3)
F. Gskt: [1] Included
Grommets: [2] Attached

PF811

Fuel Element with Bail Handle



Fits: Kawasaki Loaders; Komatsu Equipment
Replaces: Komatsu 6610-72-8600
O.D.: 5 (127.0)
I.D.: 31/32 (24.6)
Height: 9 31/32 (253.2)
F. Gskt: [1] Included
Grommets: [2] Attached

BF805

In-Line Fuel Filter



Fits: Chevrolet, GEO, Isuzu, Subaru, Toyota Automotive, Light-Duty Trucks, Vans
Replaces: Toyota 23300-34100
O.D.: 3 1/8 (79.4)
Inlet: 5/16
Outlet: 5/16
Length: 2 1/4 (57.2)

BF812

Can-Type Fuel Filter



Fits: Massey Ferguson Equipment; Perkins Engines
Replaces: Massey Ferguson 1896202-M91; Perkins 26560097
O.D.: 3 15/32 (88.1)
I.D.: 3/4 (19.1)
Height: 5 13/32 (137.3)
F. Gskt: [2] Included
O-Ring: [2] Included
End Seals: [1] Attached
Related To: BF825, BF874, BF884 (Short Versions)

BF806

Box-Style Fuel/Water Separator



Fits: Buick, Cadillac, Chevrolet, Oldsmobile, Pontiac Diesel Automotive, Light-Duty Trucks, Vans; GMC Light-Duty Diesel Trucks
Replaces: GMC 25010487
Inlet: 3/8
Outlet: 1/4
Length: 4 3/8 (111.1)
Width: 3 9/32 (83.3)
Height: 2 5/8 (66.7)

PF814

Fuel Element



Fits: John Deere Equipment
Replaces: John Deere AR28611R, AR44077
O.D.: 3 7/16 (87.3)
I.D.: 23/32 (18.3) One End
Height: 4 3/16 (106.4)
F. Gskt: [1] Included
O. Gskt: G406
Grommets: [1] Attached

PF807

Fuel Element



Fits: John Deere Tractors
Replaces: John Deere AT11929T, AT20541T
O.D.: 3 1/32 (77.0)
I.D.: 23/32 (18.3) One End
Height: 4 (101.6)
F. Gskt: [1] Included
Grommets: [1] Attached

PF816

Fuel Element



Fits: Ford, Perkins, Westerbeke Marine Engines; J.C. Bamford, Landini, Massey Ferguson Equipment
Replaces: Ford EPN-99062-A; Massey Ferguson 1850450-M2
O.D.: 2 15/16 (74.6)
I.D.: 1 1/4 (31.8)
Height: 3 1/8 (79.4)
F. Gskt: G147-A, G161, [1] Included
End Seals: [2] Attached

Measurements Are Shown In Inches And (Millimeters)

WARNING: These products can expose you to chemicals, including Diisononyl Phthalate, Carbon black extracts, Nickel, 1,3 Butadiene, Ethylene Oxide, Epichlorohydrin, which are known to the State of California to cause cancer, and Bisphenol, Ethylene Glycol, Ethylene Oxide, 1,3 Butadiene, Epichlorohydrin, which are known to the State of California to cause birth defects or other reproductive harm. For more information go to www.P65Warnings.ca.gov.

PF816-S

Fuel Element



Fits: Atlas Copco Compressors; Ford, Perkins Engines; Hymac, Hyster, Massey Ferguson, Timberjack Equipment
Replaces: Ford E1ADDN-99162-B2; Hyster 985220; Perkins 30497; Timberjack 402540
O.D.: 2 7/8 (73.0)
I.D.: 15/16 (23.8)
Height: 3 1/16 (77.8)
F. Gskt: G147-A

PF818

Fuel Element



Fits: Bennett Fuel Pumps
Replaces: Bennett A3119
O.D.: 2 1/4 (57.2)
I.D.: 1 1/16 (27.0) One End
Height: 3 31/32 (100.8)
A. Gskt: [1] Attached

PF819

Fuel Element



Fits: Mack Engines, Trucks
Replaces: Mack 237GB13
O.D.: 3 15/16 (100.0)
I.D.: 7/8 (22.2)
Height: 6 7/32 (158.0)
A. Gskt: [2] Attached
F. Gskt: G106, [1] Included

PF819-HD

Heavy-Duty Fuel or Hydraulic Element



Fits: Koehring Equipment
Replaces: Mack 237GB13
O.D.: 3 15/16 (100.0)
I.D.: 7/8 (22.2)
Height: 6 7/32 (158.0)
A. Gskt: [2] Attached
F. Gskt: G106, [1] Included

PF820-S

Fuel Element



Fits: David Brown, Massey Ferguson Equipment; Dorman, Lister, Perkins, Petter Engines
Replaces: Dorman 73130020; Massey Ferguson 1845766-M1; Perkins 26540183
O.D.: 2 7/8 (73.0)
I.D.: 1 5/16 (33.3)
Height: 3 5/16 (84.1)
F. Gskt: G147-A, G161
Related To: P176 (Full-Flow Lube Version)

PF821-S

Fuel Element

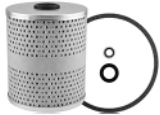

Fits: Fixible, Ford, International Trucks; Cummins Engines; Euclid, Hough, Michigan, Oliver Equipment
Replaces: Allis Chalmers BM33761; Cummins BM33761; Ford EDL-9176-A; International 3054750-R91
O.D.: 3 15/16 (100.0)
I.D.: 23/32 (18.3)
Height: 4 13/16 (122.2)
F. Gskt: G104
End Seals: [2] Included

PF822

Fuel Element



Fits: Cummins Engines; Euclid, P & H Harnischfeger Equipment
Replaces: Cummins C44758; Mack 236GB238; White 609673FS
O.D.: 3 15/16 (100.0)
I.D.: 1 1/16 (27.0)
Height: 5 31/32 (151.6)
F. Gskt: G106
End Seals: 2 Included
Related To: P82 (Lube Version) PT243, PT82-HD10 (Hydraulic Versions)

PF823

Fuel Element



Contains: Reinforced Centertube
Fits: Bucyrus-Erie, Caterpillar, Clark, Gardner Denver Equipment; Kenworth, Peterbilt Trucks
Replaces: Caterpillar 9H4729, 9H8792, 9M9641
O.D.: 3 5/16 (84.1)
I.D.: 1 1/16 (27.0)
Height: 6 1/2 (165.1)
A. Gskt: [2] Attached
F. Gskt: [2] 7B-7635
Related To: PF823(2) (without Furnished Gaskets) PF824 (Different Gasket)

PF823-E

Fuel Element



Contains: Reinforced Centertube
Fits: Caterpillar, DMI, Unit Rig, WABCO Equipment
Replaces: Caterpillar 4H8792
O.D.: 3 5/16 (84.1)
I.D.: 1 1/16 (27.0)
Height: 6 1/2 (165.1)
A. Gskt: [2] Attached
Related To: PF823 (with Furnished Gaskets)

PF824

Fuel Element



Contains: Reinforced Centertube
Fits: American Hoist & Derrick, Caterpillar, Gardner Denver, Gradall, Koehring, Link-Belt Equipment; Atlas Copco Compressors; Caterpillar Diesel Engines, Trucks; Clark Shovels
Replaces: Caterpillar 9H4729
O.D.: 3 5/16 (84.1)
I.D.: 1 1/16 (27.0)
Height: 6 1/2 (165.1)
A. Gskt: [2] Attached
F. Gskt: 5M-954
O. Gskt: 1S-9133 (For use with Stacked Elements)
Related To: PF823, PF823(2) (Different Gaskets)

Measurements Are Shown In Inches And (Millimeters)

WARNING: These products can expose you to chemicals, including Diisononyl Phthalate, Carbon black extracts, Nickel, 1,3 Butadiene, Ethylene Oxide, Epichlorohydrin, which are known to the State of California to cause cancer, and Bisphenol, Ethylene Glycol, Ethylene Oxide, 1,3 Butadiene, Epichlorohydrin, which are known to the State of California to cause birth defects or other reproductive harm. For more information go to www.P65Warnings.ca.gov.

BF825



Can-Type Fuel Filter

Fits: Agco, Akerman, Allis Chalmers, Bobcat, Case, Caterpillar, Fiat, Ford, Hesston, International, J.C. Bamford, John Deere, Kubota, Massey Ferguson, New Holland, Oliver, Perkins, White Equipment
Replaces: Allis Chalmers 1919100; Case K915319; Ford E7NN-9176-AA; International 757836-R91; Massey Ferguson 1013891-M1; New Holland 505776; Perkins 868014
O.D.: 3 7/16 (87.3)
I.D.: 3/4 (19.1)
Height: 2 13/16 (71.4)
F. Gskt: [2] G233-A, G233-B, ES1049
O-Ring: [1] Included
O. Gskt: ES3063 (IHC Installations)
Related To: BF812, BF874, BF884 (Long Versions)

BF830



In-Line Fuel Filter

Fits: Subaru Automotive
Replaces: Subaru 74207-2040
O.D.: 3 3/16 (81.0)
Inlet: 5/16
Outlet: 5/16
Length: 5 1/8 (130.2)

PF826



Fuel Element

Contains: Reinforced Centertube
Fits: Mack Trucks
Replaces: Mack 237GB29, 237GB29-A
O.D.: 3 15/16 (100.0)
I.D.: 1 1/16 (27.0)
Height: 6 1/4 (158.8)
A. Gskt: [2] Attached
F. Gskt: [1] Included

PF831



Fuel Element

Fits: ERF Trucks; Gardner Denver Compressors; Leyland Buses, Trucks; Lister, Rolls-Royce Diesel Engines
Replaces: Gardner Denver GFF310; Leyland GRS05516; Rolls-Royce OD3928; Transcold 25-50110-09
O.D.: 2 7/8 (73.0)
I.D.: 1 5/16 (33.3)
Height: 5 1/2 (139.7)
F. Gskt: [1] Included

PF827



Fuel Element

Fits: Chrysler, GM Automotive, Light-Duty Trucks; Ford, International Heavy-Duty Trucks; Hobart, Huber, Hyster, International, Lorain, New Holland Equipment; Waukesha Engines
Replaces: Clark 999478; GMC 854606; Hyster 97372; International 998429-R91; New Holland 500660; Versatile 608T119
O.D.: 2 1/16 (52.4)
I.D.: 7/16 (11.1)
Height: 3 15/32 (88.1)
F. Gskt: G204-A
Grommets: [1] Attached

BF833



In-Line Fuel Filter

Fits: Dodge, Jeep, Nissan Automotive; Bobcat, Case, Caterpillar, Gehl, Grove, John Deere, Mitsubishi, New Holland Equipment
Replaces: Case D59949; Caterpillar 9Y4444; Chrysler 2455808; GMC 25055223; John Deere AM116178, AM116304; Mitsubishi MB554970; New Holland 269212; Nissan 16400-A0600, 16400-A0601
O.D.: 1 29/32 (48.4)
Inlet: 1/4
Outlet: 1/4
Length: 4 1/16 (103.2)

PF828



Secondary Fuel Element

Fits: Clark, Galion, Hough, International, Massey Ferguson Equipment; International, Mack Engines
Replaces: Galion 85832; International 610309-C91; Mack 483GB215
O.D.: 3 3/16 (81.0)
I.D.: 1 1/16 (27.0)
Height: 4 1/2 (114.3)
A. Gskt: [2] Attached
F. Gskt: G106

BF833-K2



In-Line Fuel Filter with Clamps and Hoses

Contains: [4] Clamps
 [2] Hoses
Fits: Dodge, Jeep, Nissan Automotive; Bobcat, Case, Caterpillar, Gehl, Grove, John Deere, Mitsubishi, New Holland Equipment
Replaces: Case D59949; Caterpillar 9Y4444; Chrysler 2455808; GMC 25055223; John Deere AM116178, AM116304; Mitsubishi MB554970; New Holland 269212; Nissan 16400-A0600, 16400-A0601
O.D.: 1 29/32 (48.4)
Inlet: 1/4
Outlet: 1/4
Length: 4 1/16 (103.2)

PF829(2)



Set of 2 Fuel Elements

Contains: Reinforced Centertube
Fits: Caterpillar Equipment
Replaces: Caterpillar 9H1252
O.D.: 3 5/16 (84.1)
I.D.: 1 1/16 (27.0)
Height: 6 1/2 (165.1)
A. Gskt: [2] Attached on Each Element
F. Gskt: [1] Included

F834-F



Felt Fuel Element with Handle

Fits: Mercedes-Benz, R.V.I. Buses, Trucks
Replaces: Mercedes-Benz 3524700092
O.D.: 2 11/16 (68.3)
I.D.: 29/32 (23.0)
Height: 4 1/2 (114.3)
F. Gskt: [1] Included
Grommets: [2] Attached

Measurements Are Shown In Inches And (Millimeters)

WARNING: These products can expose you to chemicals, including Diisononyl Phthalate, Carbon black extracts, Nickel, 1,3 Butadiene, Ethylene Oxide, Epichlorohydrin, which are known to the State of California to cause cancer, and Bisphenol, Ethylene Glycol, Ethylene Oxide, 1,3 Butadiene, Epichlorohydrin, which are known to the State of California to cause birth defects or other reproductive harm. For more information go to www.P65Warnings.ca.gov.

PF834



Fuel Element with Bail Handle
Fits: Deutz, Mercedes-Benz Diesel Engines; M.A.N. Buses, Trucks
Replaces: Deutz Q05H4115; Mercedes-Benz 926901
O.D.: 2 9/16 (65.1)
I.D.: 1/2 (12.7)
Height: 4 9/32 (108.7)
F. Gskt: [2] Included
O. Gskt: G233-B
Grommets: [2] Attached

BF836



In-Line Fuel Filter
Fits: GMC Engines
Replaces: GMC 25055360
O.D.: 1 29/32 (48.4)
Inlet: 3/8
Outlet: 3/8
Length: 3 7/8 (98.4)

BF836-K3



In-Line Fuel Filter with Clamps and Hoses
Contains: [4] Clamps
 [2] Hoses
Fits: GMC Engines
Replaces: GMC 25055360
O.D.: 1 29/32 (48.4)
Inlet: 3/8
Outlet: 3/8
Length: 3 7/8 (98.4)

BF836-K4



In-Line Fuel Filter with Clamps
Contains: [4] Clamps
Fits: GMC Engines
Replaces: GMC 25055360
O.D.: 1 29/32 (48.4)
Inlet: 3/8
Outlet: 3/8
Length: 3 7/8 (98.4)

BF837



In-Line Fuel Filter
Fits: Ford, Honda, Mazda, Subaru, Toyota Automotive, Light-Duty Trucks
Replaces: Ford E8BZ-9155-A; GMC 25055660; Honda 16900-SA-5000; Mazda E508-13-470
O.D.: 4 1/16 (103.2)
Inlet: 5/16
Outlet: 5/16
Length: 2 5/16 (58.7)

BF838-F2



Can-Type Fuel Filter
Fits: Case, Ford, Minneapolis-Moline, Oliver, White Equipment
Replaces: Case A39937; Ford C3TZ-9365-B; Stanadyne 26001A; White 609689FS
O.D.: 3 7/16 (87.3)
I.D.: 3/4 (19.1)
Height: 2 13/16 (71.4)
F. Gskt: [2] Included
O-Ring: [1] Included

PF838



Fuel Element
Fits: Carrier-Transicold Refrigeration Units; David Brown, International, Massey Ferguson, Oliver Equipment; Perkins, Rolls-Royce Engines
Replaces: Carrier-Transicold 11649; David Brown 62594; International 844644-R91; Massey Ferguson 1021351-M1; Perkins 33425
O.D.: 3 5/16 (84.1)
I.D.: 5/8 (15.9) & 13/16 (20.6)
Height: 2 3/4 (69.9)
F. Gskt: G153
O-Ring: [2] Included

BT839



Hydraulic Spin-on
Notes: Can be used with OB1317, OB1318, OB1319, OB1320 bases.
Fits: Bobcat, Ford, Toro, Vermeer, Versatile Equipment; Cross, Gresen, Michigan Fluid Power Hydraulic Systems
Replaces: Cross 1A9023; Gresen 8057000; Michigan Fluid Power 201026
Thread: 1 -12
O.D.: 3 11/16 (93.7)
Height: 5 13/32 (137.3)
I.Gskt: G401
Related To: BT452 (with By-Pass Valve) BT8420 (Stainless Steel Mesh Version) BT8428-MPG (Maximum Performance Glass Version)

BT839-10



Hydraulic Spin-on
Notes: Can be used with OB1317, OB1318, OB1319, OB1320 bases.
Fits: Bobcat, Ford, Toro, Vermeer, Versatile Equipment; Cross, Gresen, Michigan Fluid Power Hydraulic Systems
Replaces: Cross 1A9023; Gresen 8057000; Michigan Fluid Power 201026
Thread: 1 -12
O.D.: 3 11/16 (93.7)
Height: 5 13/32 (137.3)
I.Gskt: G401
Related To: BT452 (with By-Pass Valve) BT8420 (Stainless Steel Mesh Version) BT8428-MPG (Maximum Performance Glass Version)

BF840



In-Line Fuel Filter
Fits: Chrysler, GMC Automotive; Case, International, Massey Ferguson Equipment
Replaces: Chrysler 5214626; Ford A780X-9155-AA; GMC 94020398; Isuzu 8-78107-910; Case D139225; Massey Ferguson 800848-M91
O.D.: 1 29/32 (48.4)
Inlet: 5/16
Outlet: 5/16
Length: 4 5/32 (105.6)
Related To: BF840-K1 (w/Clamps, Hoses) BF7736 (Plastic Version)

Measurements Are Shown In Inches And (Millimeters)

WARNING: These products can expose you to chemicals, including Diisononyl Phthalate, Carbon black extracts, Nickel, 1,3 Butadiene, Ethylene Oxide, Epichlorohydrin, which are known to the State of California to cause cancer, and Bisphenol, Ethylene Glycol, Ethylene Oxide, 1,3 Butadiene, Epichlorohydrin, which are known to the State of California to cause birth defects or other reproductive harm. For more information go to www.P65Warnings.ca.gov.

BF840-K1 In-Line Fuel Filter with Clamps and Hoses
Contains: [4] Clamps
 [2] Hoses
Fits: Chrysler, GMC Automotive; Case, International, Massey Ferguson Equipment
Replaces: Chrysler 5214626; Ford A780X-9155-AA; GMC 94020398; Isuzu 8-78107-910; Massey Ferguson 800848-M91
O.D.: 1 29/32 (48.4)
Inlet: 5/16
Outlet: 5/16
Length: 4 5/32 (105.6)
Related To: BF840 (Filter Only)
 BF7736 (Plastic Version)



PF845 Primary Fuel Element
Notes: To convert to spin-on, use FB1301 base and BF5800.
Contains: Reinforced Centertube
Fits: GMC, International, Mack, Peterbilt, Western Star Buses, Trucks
Replaces: GMC 9717391; International 998446-R91
O.D.: 2 7/8 (73.0)
I.D.: 13/32 (10.3) & 1 3/16 (30.2)
Height: 8 5/16 (211.1)
A. Gskt: [2] Attached
F. Gskt: [3] Included



BT841 Hydraulic Spin-on
Notes: OBSOLETE. Availability limited to dealer stock.
Fits: Ryco Head #14
Replaces: Ryco R14
Thread: 1 -11 BSP-PL
O.D.: 3 13/16 (96.8)
Height: 5 3/16 (132.0)
F. Gskt: [1] Included



PF846 Secondary Fuel Element
Notes: To convert to spin-on, use FB1310 base and BF785.
Fits: Detroit Diesel Engines
Replaces: GMC 6437284
O.D.: 4 17/32 (115.1)
I.D.: 11/16 (17.5)
Height: 8 1/4 (209.6)
A. Gskt: [1] Attached
F. Gskt: G143, ES1034
Grommets: [2] Attached



VT842-O Off-Highway Vac-Cel Full-Flow Lube Sock
Fits: Oliver, White Equipment; Waukesha Engines
Replaces: Oliver 156149AS; Waukesha 493009; White 872946
O.D.: 3 1/8 (79.4)
I.D.: 1 1/16 (27.0)
Height: 7 3/4 (196.9)
F. Gskt: G115-A, G243-A
O. Gskt: G127
Related To: V852-O (By-Pass Version)



PF847 Fuel Element
Fits: J.C. Bamford Equipment; Lister, Petter Engines
Replaces: J.C. Bamford S1246; Lister 201-13117; Petter 284539
O.D.: 2 1/4 (57.2)
I.D.: 9/32 (7.1) & 27/32 (21.4)
Height: 1 15/32 (37.3)
F. Gskt: G103, [3] Included



BF843 In-Line Fuel Filter
Fits: Ford Automotive; John Deere, Melroe Equipment
Replaces: Ford C0DZ-9155-A; John Deere T19743T
O.D.: 2 (50.8)
Inlet: 1/8-27
Outlet: 1/2-20
Length: 3 7/16 (87.3)



PT849 Hydraulic Element
Fits: Case, Caterpillar, Clark, Hough, International, John Deere, Michigan, New Holland Equipment
Replaces: Case F88379; Caterpillar 5J8879; Clark 789644; International 876949-C91; John Deere AE25453; New Holland 270565
O.D.: 2 7/8 (73.0)
I.D.: 7/16 (11.1) & 1 3/16 (30.2)
Height: 4 3/8 (111.1)
A. Gskt: [1] Attached
F. Gskt: G255
Grommets: [1] Attached



F844-A Cotton and Fiber Primary Fuel Sock
Notes: To convert to spin-on, use FB1309 base and BF784.
Fits: Detroit Diesel Engines
Replaces: GMC 5574980, 6438518
O.D.: 4 (101.6)
I.D.: 1 1/2 (38.1)
Height: 9 (228.6)
F. Gskt: G115-A, ES1001



PT849-10 Hydraulic Element
Fits: Case, Caterpillar, Clark, Hough, International, John Deere, Michigan, New Holland Equipment
Replaces: Case F88379; Caterpillar 5J8879; Clark 789644; International 876949-C91; John Deere AE25453; New Holland 270565
O.D.: 2 7/8 (73.0)
I.D.: 7/16 (11.1) & 1 3/16 (30.2)
Height: 4 3/8 (111.1)
A. Gskt: [1] Attached
F. Gskt: G255
Grommets: [1] Attached



F845-A Automatic Wound Sisal Primary Fuel Sock
Notes: To convert to spin-on, use FB1301 base and BF5800.
Contains: Reinforced Centertube
O.D.: 2 7/8 (73.0)
I.D.: 1 1/4 (31.8)
Height: 8 7/16 (214.3)
F. Gskt: ES1034, [2] Included



Measurements Are Shown In Inches And (Millimeters)

WARNING: These products can expose you to chemicals, including Diisononyl Phthalate, Carbon black extracts, Nickel, 1,3 Butadiene, Ethylene Oxide, Epichlorohydrin, which are known to the State of California to cause cancer, and Bisphenol, Ethylene Glycol, Ethylene Oxide, 1,3 Butadiene, Epichlorohydrin, which are known to the State of California to cause birth defects or other reproductive harm. For more information go to www.P65Warnings.ca.gov.

V852-O



Vac-Cel By-Pass Lube Sock
Fits: Oliver Equipment
Replaces: Oliver 165928AS
O.D.: 4 1/8 (104.8)
I.D.: 1 1/16 (27.0)
Height: 8 (203.2)
F. Gskt: G115-A
Related To: V842-O (Full-Flow Version)

BF853



In-Line Fuel Filter
Fits: GMC, Jaguar, Land Rover Automotive, Light-Duty Trucks
Replaces: GMC 25171792
O.D.: 2 5/16 (58.7)
Inlet: M16 x 1.5
Outlet: M16 x 1.5
Length: 4 7/16 (112.7)

BF855



Box-Style Secondary Fuel/Water Separator
Fits: GMC Light-Duty Trucks; Onan Engines
Replaces: GMC 25011763; Joy 19005224; Stanadyne 23248
Length: 4 5/8 (117.5)
Width: 2 27/32 (72.2)
Height: 2 15/32 (62.7)
F. Gskt: [1] Included

BF856



Box-Style Fuel/Water Separator
Fits: GMC Light-Duty Trucks with Diesel Engines
Replaces: GMC 10149549; Stanadyne 24262
Length: 6 11/32 (161.1)
Width: 3 9/32 (83.3)
Height: 2 21/32 (67.5)
Grommets: [4] Attached

PF857



Fuel Element
Fits: Ford, GMC Automotive, Light-Duty Trucks; Gray, Mercruiser Marine Engines
Replaces: Ford B5A-9365-A; GMC 854982; Gray G80084
O.D.: 1 3/4 (44.5)
I.D.: 15/32 (11.9)
Height: 1 1/16 (27.0)
F. Gskt: [1] Included

BF858



In-Line Fuel Filter
Fits: Cadillac Automotive
Replaces: GMC 5651944
O.D.: 2 9/32 (57.9)
Inlet: 5/8-18
Outlet: 3/8
Length: 4 3/4 (120.7)

PF859



Fuel Element
Fits: AMC, Dodge, Ford, International, Jeep Light-Duty Trucks; Interceptor, Mercruiser, Palmer Marine Engines; International Equipment
Replaces: Chrysler 3173674; Ford C3TA-9162-A; International 918472-R1; Jeep J8990953; Mercruiser B3549088
O.D.: 1 3/8 (34.9)
I.D.: 9/16 (14.3) One End
Height: 1 7/8 (47.6)
F. Gskt: [2] Included

PF860



Fuel Element
Fits: GMC, White Trucks
Replaces: GMC 854435; White 871646
O.D.: 2 7/8 (73.0)
I.D.: 17/32 (13.5)
Height: 2 1/8 (54.0)
A. Gskt: [2] Attached
F. Gskt: [1] Included

PF861



Fuel Element
Fits: Datsun, Nissan, TCM Lift Trucks; International Light-Duty Trucks
Replaces: Nissan 16403-37700
O.D.: 2 15/16 (74.6)
I.D.: 5/8 (15.9)
Height: 2 7/32 (56.4)
F. Gskt: ES1036, ES3063, [3] Included

BF862



Secondary Fuel Spin-on with Removal Nut
Notes: CAUTION: Furnished O-Ring must be installed on post for seal.
Fits: Case, Davis, Drott Equipment
Replaces: Case A39867
Thread: 15/16 -16
O.D.: 3 11/16 (93.7)
Height: 4 23/32 (119.9)
I.Gskt: G401
O-Ring: ES24-B

BF863



Primary Fuel Spin-on with Removal Nut
Fits: Case, Davis, Drott Equipment
Replaces: Case A39868
Thread: 13/16 -18
O.D.: 3 11/16 (93.7)
Height: 4 11/16 (119.1)
I.Gskt: G401

PF864



Fuel Element with 12 Bolt Holes on Flange
Fits: Cadillac, Chevrolet, Oldsmobile Automotive
Replaces: GMC 8449253
O.D.: 1 3/8 (34.9)
Flange: 1 13/16 (46.0)
I.D.: 15/32 (11.9) One End
Height: 1 5/16 (33.3)

BF865



In-Line Fuel Filter
Contains: 1/4 Inch Universal Vapor Diverter
Fits: Chrysler Automotive
Replaces: Chrysler 3870548, 4041540
O.D.: 1 31/32 (50.0)
Inlet: 5/16
Outlet: 5/16
Length: 3 15/16 (100.0)

BF865-K



In-Line Fuel Filter with Clamps and Hoses
Contains: 1/4 Inch Universal Vapor Diverter [5] Clamps [2] Hoses
Fits: Chrysler Automotive
Replaces: Chrysler 3870548, 4041540
O.D.: 1 31/32 (50.0)
Inlet: 5/16
Outlet: 5/16
Length: 3 15/16 (100.0)

Measurements Are Shown In Inches And (Millimeters)

WARNING: These products can expose you to chemicals, including Diisononyl Phthalate, Carbon black extracts, Nickel, 1,3 Butadiene, Ethylene Oxide, Epichlorohydrin, which are known to the State of California to cause cancer, and Bisphenol, Ethylene Glycol, Ethylene Oxide, 1,3 Butadiene, Epichlorohydrin, which are known to the State of California to cause birth defects or other reproductive harm. For more information go to www.P65Warnings.ca.gov.

PF866 Suction Side Fuel Element
Fits: Ferrari Automotive
Replaces: Alfa Romeo 105500460000
O.D.: 2 9/16 (65.1)
I.D.: 17/32 (13.5) & 11/16 (17.5)
Height: 2 31/32 (75.4)
A. Gskt: [2] Attached
F. Gskt: [1] Included



BF868 In-Line Fuel Filter
Fits: GMC Automotive
Replaces: GMC 250055481
O.D.: 2 5/32 (54.8)
Inlet: 3/8
Outlet: M16 x 1.5
Length: 4 7/8 (123.8)



PF869 Fuel Element
Fits: Purolator PAGR50 Through PAGR200 Housings
Replaces: Purolator 8001716, 8003100
O.D.: 3 15/16 (100.0)
I.D.: 1 21/32 (42.1)
Height: 12 1/4 (311.2)
A. Gskt: [2] Attached



PF872 Fuel Element
Fits: Bobcat, Hitachi, Kubota Equipment
Replaces: Kubota 15231-43560, 15231-43560-1, 15231-43560-2
O.D.: 1 1/8 (28.6)
I.D.: 1/2 (12.7) One End
Height: 3 7/16 (87.3)



BF873 In-Line Fuel Filter
Replaces: Toyota 23300-15010
O.D.: 3 1/8 (79.4)
Inlet: 9/32
Outlet: 9/32
Length: 2 9/32 (57.9)



BF874 Can-Type Fuel Filter
Fits: Hercules Engines; Oliver, Winpower Equipment; Quincy, Sullair Compressors
Replaces: Hercules 266536; Stanadyne 16637
O.D.: 3 15/32 (88.1)
I.D.: 3/4 (19.1)
Height: 3 13/16 (96.8)
I.Gskt: [1] Included
F. Gskt: [2] Included
O-Ring: [2] Included
Related To: BF812, BF884 (Long Versions) BF825 (Short Version)



BF876 Secondary Fuel Spin-on
Contains: Integral Post Seal
Fits: Iveco, Mack, Scania-Vabis Trucks; R.V.I. Buses, Trucks
Replaces: Iveco 4733112; Mack 483GB441
Thread: 7/8 -16
O.D.: 4 1/4 (108.0)
Height: 7 11/32 (186.5)
I.Gskt: G381-A



BF877 Primary Fuel Spin-on
Contains: Integral Post Seal
Fits: Mack, Scania-Vabis Trucks; R.V.I. Buses, Trucks
Replaces: Mack 483GB444
Thread: 13/16 -18
O.D.: 4 1/4 (108.0)
Height: 7 11/32 (186.5)
I.Gskt: G381-A
Related To: BF1219 (Fuel/Water Separator Version)



BF879 Screw-in Carburetor In-Line Fuel Filter
Contains: [1] Hose [1] Clamp
Fits: AMC, Ford Automotive, Trucks; Massey Ferguson, Ottawa Equipment; Onan Generators
Replaces: AMC 3193898, 8992430; Ford C7AE-9155-A; Jeep J8992430; Massey Ferguson 521248-M91; Onan 149-1353
O.D.: 1 (25.4)
Inlet: 3/8
Outlet: 1/8-27
Length: 2 5/8 (66.7)



BF880-FP Fuel Spin-on with Fill Port
Contains: Integral Post Seal
Port Thread: 1 1/4-10
Fits: Davco Fuel Pro 321 Housings
Replaces: Davco 4807329
Thread: 1 -14
O.D.: 4 1/4 (108.0)
Height: 7 29/32 (200.8)
I.Gskt: [1] Included



BF881 In-Line Fuel Filter
Fits: GMC Light-Duty Trucks
Replaces: GMC 25055032
O.D.: 1 7/16 (36.5)
Inlet: 5/16
Outlet: 5/16
Length: 3 15/32 (88.1)



PF882 Fuel Element
Fits: ACDelco Housings; Carrier Refrigeration Units; Perkins Engines
Replaces: Carrier 29-11705-80; Perkins 26560088
O.D.: 2 7/8 (73.0)
I.D.: 27/32 (21.4)
Height: 6 13/16 (173.0)
F. Gskt: G147-A



Measurements Are Shown In Inches And (Millimeters)

WARNING: These products can expose you to chemicals, including Diisononyl Phthalate, Carbon black extracts, Nickel, 1,3 Butadiene, Ethylene Oxide, Epichlorohydrin, which are known to the State of California to cause cancer, and Bisphenol, Ethylene Glycol, Ethylene Oxide, 1,3 Butadiene, Epichlorohydrin, which are known to the State of California to cause birth defects or other reproductive harm. For more information go to www.P65Warnings.ca.gov.

PF883



Fuel Element

Fits: Wix Housings
Replaces: Wix 24390
O.D.: 3 1/32 (77.0)
I.D.: 23/32 (18.3) One End
Height: 6 (152.4)
O. Gskt: G247
Grommets: [1] Attached

BF891



Primary Fuel/Water Separator Spin-on with Drain

Contains: Integral Post Seal
Fits: Dresser, Hough, International Equipment
Replaces: International 702255-C1
Thread: 1 -14
O.D.: 3 11/16 (93.7)
Height: 5 11/16 (144.5)
I.Gskt: G381-A

BF884



Can-Type Fuel Filter

Fits: Agco, Ford, Hanomag, J.C. Bamford, Massey Ferguson, New Holland, Same, Volvo Equipment; Bedford, Pegaso, R.V.I. Buses, Trucks
Replaces: Ford 78GB-9150-AA; Massey Ferguson 3621009-M1
O.D.: 3 15/32 (88.1)
I.D.: 3/4 (19.1)
Height: 4 7/16 (112.7)
F. Gskt: [2] Included
O-Ring: [2] Included
End Seals: [1] Attached
Related To: BF812 (Long Version) BF825, BF874 (Short Versions)

BF892



Primary Fuel/Water Separator Spin-on with Drain

Contains: Integral Post Seal
Fits: Agco, Allis Chalmers, Case-International, Fiat-Allis, International, White Equipment
Replaces: Allis Chalmers 74394407; International 702256-C1
Thread: 1 -14
O.D.: 3 11/16 (93.7)
Height: 9 1/32 (229.4)
I.Gskt: G381-A

BF885



In-Line Fuel Filter

Fits: Audi, Volkswagen, Volvo Automotive, Light-Duty Trucks
Replaces: Audi 441204511C; Fiat 82434499; Volkswagen 431133511D; Volvo 12760500
O.D.: 3 1/8 (79.4)
Inlet: M14 x 1.5
Outlet: M12 x 1.5
Length: 5 11/32 (135.7)
F. Gskt: [4] Copper Washers

PF893



Carburetor Fuel Element

Fits: GM Automotive, Gas Engines; Crusader, Flagship Marine Engines
Replaces: GMC 5651920
O.D.: 11/16 (17.5)
I.D.: 9/32 (7.1) One End
Height: 1 1/32 (26.2)

BF886



In-Line Fuel Filter

Contains: 1/4 Inch Universal Vapor Diverter [6] Clamps [2] Hoses
Fits: AMC, Chrysler, GMC, Jeep Automotive, Light-Duty Trucks
Replaces: Jeep J8121753
O.D.: 1 31/32 (50.0)
Inlet: 5/16
Outlet: 5/16
Length: 3 15/16 (100.0)

PF893-RV



Carburetor Fuel Element with Roll-Over Valve

Fits: GM Automotive, Gas Engines; Crusader, Flagship Marine Engines
Replaces: GMC 5651920
O.D.: 11/16 (17.5)
I.D.: 9/32 (7.1) One End
Height: 1 1/32 (26.2)

BF888



Secondary Fuel Spin-on

Contains: Integral Post Seal
Fits: Ag-Chem, Dresser, Galion, Hough, International, Thermo King Equipment
Replaces: Galion 120301; International 359251-C1, 674293-C1; Thermo King 11-3855
Thread: 7/8 -14
O.D.: 3 11/16 (93.7)
Height: 8 11/16 (220.7)
I.Gskt: G381-A

PF894



Carburetor Fuel Element

Fits: Buick, Chevrolet, Pontiac Automotive, Gas Engines; GMC Light-Duty Trucks
Replaces: GMC 5651921
O.D.: 11/16 (17.5)
I.D.: 9/32 (7.1) One End
Height: 2 1/32 (51.6)

BF890



In-Line Fuel Filter

Fits: AMC, Jeep, Renault Automotive
Replaces: AMC 8933000076
O.D.: 3 1/16 (77.8)
Inlet: 3/8
Outlet: 5/16
Length: 6 1/16 (154.0)

PF894-RV



Carburetor Fuel Element with Roll-Over Valve

Fits: Buick, Chevrolet, Pontiac Automotive, Gas Engines; GMC Light-Duty Trucks
Replaces: GMC 5651921
O.D.: 11/16 (17.5)
I.D.: 9/32 (7.1) One End
Height: 2 1/32 (51.6)

Measurements Are Shown In Inches And (Millimeters)

WARNING: These products can expose you to chemicals, including Diisononyl Phthalate, Carbon black extracts, Nickel, 1,3 Butadiene, Ethylene Oxide, Epichlorohydrin, which are known to the State of California to cause cancer, and Bisphenol, Ethylene Glycol, Ethylene Oxide, 1,3 Butadiene, Epichlorohydrin, which are known to the State of California to cause birth defects or other reproductive harm. For more information go to www.P65Warnings.ca.gov.

BF896



Primary Fuel Spin-on with Drain
Notes: Part of BF897 KIT.
Fits: Carrier Refrigeration Units; Case, Drott, Gimmer Schmidt Equipment
Replaces: Carrier 30-00301; Case A58712
Thread: 13/16 -18
O.D.: 3 11/16 (93.7)
Height: 5 21/32 (143.7)
I.Gskt: G401

BF897 KIT



Set of Primary and Secondary Fuel Spin-ons
Notes: On BF582 (Secondary), Furnished O-Ring must be installed on post for seal.
Contains: [1] BF896
 [1] BF582
Fits: Case, David Brown, Drott Equipment
Replaces: Case A41745
BF896 (Primary)
Thread: 13/16 -18
O.D.: 3 11/16 (93.7)
Height: 5 21/32 (143.7)
I.Gskt: G401
BF582 (Secondary)
O.D. 3 11/16
Thread: 15/16-16
Height 5 13/32
O-Ring G401

SF898



Sintered Bronze Fuel Element
Fits: Ford, GMC Automotive, Light-Duty Trucks
Replaces: Ford D9PZ-9155-A; GMC 5651924
O.D.: 5/8 (15.9)
I.D.: 7/32 (5.6) One End
Height: 25/32 (19.9)

PF899



Fuel Element
Contains: Reinforced Centertube
Replaces: GMC 3317990
O.D.: 3 15/16 (100.0)
I.D.: 7/8 (22.2)
Height: 6 7/32 (158.0)
A. Gskt: [2] Attached
F. Gskt: G257

BF900



Fuel Spin-on
Fits: Agco, Bomag, Case, Claas, Deutz-Allis, Iveco, Poclair, Terex Equipment; DAF Buses, Trucks
Replaces: Bomag N9675; Claas 1780340; DAF 247139; Deutz 1174422; Iveco 1902133; Poclair 1050595
Thread: M16 x 1.5
O.D.: 3 11/16 (93.7)
Height: 5 3/8 (136.5)
I.Gskt: G381-A

PF902

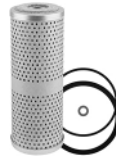

Secondary Fuel Element
Fits: Cummins, GMC Engines; Euclid Road Building Equipment
Replaces: Cummins 146823; Euclid 9044268; GMC 5574508
O.D.: 3 (76.2)
I.D.: 1 1/16 (27.0)
Height: 7 13/16 (198.4)
A. Gskt: [2] Attached
F. Gskt: [3] Included
O. Gskt: ES1032

PF902-S



Railroad Fuel Element
Fits: E.M.D. Locomotives
Replaces: Clark 60024229
O.D.: 3 (76.2)
I.D.: 1 1/16 (27.0)
Height: 7 13/16 (198.4)
A. Gskt: [2] Attached
O. Gskt: ES1032

PT903



Hydraulic Steering Element
Notes: Inside-Out Flow Direction.
 2 Quart Capacity
Fits: International, Kenworth, Mack, Peterbilt, Volvo Trucks
Replaces: Case 279294C92; International 379294-C92; Mack 9424LF634; Volvo 874487
O.D.: 3 15/32 (88.1)
I.D.: 29/32 (23.0) & 1 15/32 (37.3)
Height: 2 25/32 (70.6)
F. Gskt: G115-A
End Seals: [2] Attached
Related To: P951 (without Furnished Gasket)

PF906



Secondary Fuel Element
Notes: To convert to spin-on, use FB1302 and BF593.
Fits: Detroit Diesel Engines
Replaces: GMC 3290851
O.D.: 3 (76.2)
I.D.: 1 1/16 (27.0)
Height: 3 5/8 (92.1)
A. Gskt: [2] Attached
F. Gskt: [3] Included
O. Gskt: G344

PF907



Fuel Element
Fits: Allis Chalmers Equipment
Replaces: Allis Chalmers 59898
O.D.: 3 (76.2)
I.D.: 1 1/16 (27.0)
Height: 7 23/32 (196.1)
A. Gskt: [2] Attached
F. Gskt: [2] Included, [2] Loose Seals

F908-A



Wound Cotton Primary Fuel Sock
Fits: Detroit Diesel Engines
Replaces: GMC 6436839
O.D.: 5 1/2 (139.7)
I.D.: 2 15/32 (62.7)
Height: 10 (254.0)
F. Gskt: ES1066, [1] Included

Measurements Are Shown In Inches And (Millimeters)

WARNING: These products can expose you to chemicals, including Diisononyl Phthalate, Carbon black extracts, Nickel, 1,3 Butadiene, Ethylene Oxide, Epichlorohydrin, which are known to the State of California to cause cancer, and Bisphenol, Ethylene Glycol, Ethylene Oxide, 1,3 Butadiene, Epichlorohydrin, which are known to the State of California to cause birth defects or other reproductive harm. For more information go to www.P65Warnings.ca.gov.

BF909

Dual-Stage Box-Style Glass Fuel/Water Separator



Notes: BF959 may be used in place of BF909. Do NOT substitute BF909 for the metal version. Often a companion to BF912.
Contains: Air Bleed Vent
 Water Drain with Window
Fits: Allis Chalmers, Caterpillar, John Deere, Minneapolis-Moline, Oliver, Vermeer, White Equipment; Joy, Ingersoll-Rand Compressors
Replaces: Allis Chalmers 4024232; John Deere AR50041; Stanadyne 18786; White 20-0006803
Length: 4 15/16 (125.4)
Width: 3 11/16 (93.7)
Height: 3 11/32 (84.9)

PF910

Secondary Fuel Element



Fits: Allis Chalmers Equipment
Replaces: Allis Chalmers 4052172
O.D.: 3 (76.2)
I.D.: 1 1/16 (27.0)
Height: 7 13/16 (198.4)
A. Gskt: [2] Attached
F. Gskt: [3] Included

BF912

Box-Style Glass Fuel/Water Separator/Coalescer



Notes: Often a companion to BF909.
Fits: Ag-Chem, Allis Chalmers, Caterpillar, Dynapac, John Deere, Koehring, Link-Belt, New Holland Equipment; Ford, GMC, International, Kenworth, Mack, White Trucks
Replaces: Allis Chalmers 4024223; Caterpillar 6N7617; John Deere AR86755; Stanadyne 19797; White 40-0002519
Length: 4 15/16 (125.4)
Width: 3 11/16 (93.7)
Height: 3 11/32 (84.9)

PF913

Fuel Element



Fits: E.M.D. Locomotives
Replaces: GMC 8363264
O.D.: 2 1/2 (63.5)
 Flange 2 7/8 (73.0)
I.D.: 27/32 (21.4) One End
Height: 4 1/4 (108.0)
A. Gskt: [1] Attached

BF914

Set of Filter Base and Spin-on for Fuel Storage Tank



Contains: [1] BF915 Fuel Filter
 [1] FB1307 Base
BF915
Thread: 1 -12
O.D.: 3 11/16 (93.7)
Height: 7 7/16 (188.9)
FB1307
O.D. 3 3/4 (95.3)
Inlet 1 In. NPT
Height 2 21/32 (67.5)

BF915

Fuel Storage Tank Spin-on with Drain



Notes: Part of BF914.
 Can be used with FB1307 base.
Replaces: Cim-Tek 700-02
Thread: 1 -12
O.D.: 3 11/16 (93.7)
Height: 7 7/16 (188.9)
I.Gskt: G381-A
Related To: BF956 (with Water Absorbent Media)

F916-C

Wound Cotton Primary Fuel Sock



Notes: To convert to spin-on, use FB1301 base and BF592.
Fits: Allis Chalmers Equipment; Detroit Diesel Engines
Replaces: Allis Chalmers 4055533; Detroit Diesel 5192854
O.D.: 2 7/8 (73.0)
I.D.: 1 (25.4)
Height: 5 3/4 (146.1)
F. Gskt: [4] Included

PF916

Secondary Fuel or Hydraulic Element



Notes: To convert to spin-on, use FB1302 base and BF593.
Fits: AgChem, Allis Chalmers, Case, Fiat-Allis, Kato, Vermeer Equipment; Detroit Diesel Engines; Thermo King Refrigeration Units
Replaces: Case 9980AB; Detroit Diesel 5192845
O.D.: 3 (76.2)
I.D.: 1 1/16 (27.0)
Height: 5 5/8 (142.9)
A. Gskt: [2] Attached
F. Gskt: [4] Included
O. Gskt: ES1032

BF918-K

In-Line Fuel Filter with Clamps and Hoses



Contains: 1/4 Inch Universal Vapor Diverter
 [6] Clamps
 [3] Hoses
Fits: Dodge, Plymouth Automotive
Replaces: Chrysler 5214692
O.D.: 1 1/2 (38.1)
Inlet: 5/16
Outlet: 5/16
Length: 3 7/16 (87.3)

F919-C

Wound Cotton Fuel or Hydraulic Sock



Fits: Caterpillar Engines, Equipment
Replaces: Caterpillar 2A5886
O.D.: 1 3/4 (44.5)
I.D.: 7/16 (11.1)
Height: 7 7/8 (200.0)
O. Gskt: 7B-7635, 7B-8017

BF920

Nylon Screen Screw-in Carburetor Fuel Filter



Fits: Ford Automotive
Replaces: Ford E0ZE-9155-BA
O.D.: 1 11/32 (34.1)
Inlet: 1/2-20
Outlet: 1/8-27
Length: 1 15/16 (49.2)

Measurements Are Shown In Inches And (Millimeters)

WARNING: These products can expose you to chemicals, including Diisononyl Phthalate, Carbon black extracts, Nickel, 1,3 Butadiene, Ethylene Oxide, Epichlorohydrin, which are known to the State of California to cause cancer, and Bisphenol, Ethylene Glycol, Ethylene Oxide, 1,3 Butadiene, Epichlorohydrin, which are known to the State of California to cause birth defects or other reproductive harm. For more information go to www.P65Warnings.ca.gov.

PF924 Fuel Element
Fits: Purolator PAG25D Series Housings
Replaces: GMC 8164725, 8302891
O.D.: 2 7/8 (73.0)
I.D.: 1 13/32 (35.7)
Height: 10 (254.0)
End Seals: [2] Attached



BF933 In-Line Fuel Filter
Fits: Chevrolet, Mazda, Nissan, Toyota Automotive
Replaces: GMC 25175542; Nissan 16400-D0100; Toyota 23300-25020
O.D.: 4 1/16 (103.2)
Inlet: 9/32
Outlet: 9/32
Length: 2 1/4 (57.2)



BF925 In-Line Fuel Filter
Fits: Mazda Automotive
Replaces: Mazda B630-13-480A
O.D.: 2 13/16 (71.4)
Inlet: 5/16
Outlet: M12 x 1 1/4
Length: 5 3/16 (131.8)
F. Gskt: [2] Copper Washers



PF935 Primary Fuel Element
Fits: Caterpillar Equipment
Replaces: Caterpillar 5M7650, 9M2341
O.D.: 2 1/4 (57.2)
I.D.: 13/32 (10.3)
Height: 3 (76.2)
O. Gskt: G323, ES1030



PF926 Fuel or Hydraulic Element
Fits: Cooper-Bessemer
Replaces: Cooper-Bessemer P227815
O.D.: 2 9/16 (65.1)
I.D.: 1 1/16 (27.0)
Height: 9 3/4 (247.7)
A. Gskt: [2] Attached



PF936 2-Section Fuel/Water Separator Element
Contains: Grommet Seal Between Sections
Fits: Fram Housing FCS1136
Replaces: Fram CCS1136
O.D.: 3 3/32 (78.6)
I.D.: 9/16 (14.3)
Height: 3 13/16 (96.8)
A. Gskt: [2] Attached
F. Gskt: G344



BF928 In-Line Fuel Filter
Fits: Chrysler, Hyundai, Isuzu, Mitsubishi, Nissan Automotive; Nissan Lift Trucks
Replaces: Chrysler MB129591; Hyundai 3191021000; Isuzu 8-94250-176-1; Mitsubishi MB052676; Nissan 16400-C6400
O.D.: 2 3/4 (69.9)
Inlet: 11/32
Outlet: 11/32
Length: 3 19/32 (91.3)



PF937 Fuel Element
Fits: Bolens, Ford, John Deere, Komatsu, Massey Ferguson, Takeuchi, Yanmar Equipment
Replaces: Bolens 1862499; Ford SBA130366040; John Deere CH15553; Komatsu 104-500-5571; Massey Ferguson 3283343-M1; Yanmar 104500-55710
O.D.: 1 3/8 (34.9)
I.D.: 1/2 (12.7) One End
Height: 2 23/32 (69.1)
O-Ring: [1] Included



BF929 In-Line Fuel Filter
Fits: Mazda Automotive
Replaces: Mazda N326-20-490
O.D.: 2 13/16 (71.4)
Inlet: 5/16
Outlet: 5/16
Length: 6 17/32 (165.9)



BF938 Primary Fuel Spin-on with Drain
Fits: Allmand Equipment; Onan Engines
Replaces: Onan 122B325
Thread: 7/16 -20
O.D.: 3 7/16 (87.3)
Height: 4 13/16 (122.2)
I. Gskt: [1] Included
F. Gskt: ES1001



BF930 In-Line Fuel Filter
Contains: 1/4 Inch Universal Vapor Diverter [6] Clamps [3] Hoses
Fits: Chrysler Automotive
Replaces: Chrysler 4241824
O.D.: 1 1/4 (31.8)
Inlet: 5/16
Outlet: 5/16
Length: 3 15/32 (88.1)



BF939 Secondary Fuel Spin-on with Drain
Fits: Allmand Equipment; Onan Engines
Replaces: Onan 122B326
Thread: 3/8 -24
O.D.: 3 7/16 (87.3)
Height: 4 13/16 (122.2)
I. Gskt: [1] Included
A. Gskt: [1] Included
F. Gskt: ES1001



BF932 In-Line Fuel Filter
Fits: Nissan, Toyota Automotive; Nissan, TCM Lift Trucks
Replaces: Nissan 16400-E3001; TCM 16400-E3000; Toyota 23300-24050
O.D.: 1 7/8 (47.6)
Inlet: 9/32
Outlet: 9/32
Length: 3 17/32 (89.7)



Measurements Are Shown In Inches And (Millimeters)

WARNING: These products can expose you to chemicals, including Diisononyl Phthalate, Carbon black extracts, Nickel, 1,3 Butadiene, Ethylene Oxide, Epichlorohydrin, which are known to the State of California to cause cancer, and Bisphenol, Ethylene Glycol, Ethylene Oxide, 1,3 Butadiene, Epichlorohydrin, which are known to the State of California to cause birth defects or other reproductive harm. For more information go to www.P65Warnings.ca.gov.

BF940

Fuel Spin-on



Fits: Allis Chalmers, Kubota, Massey Ferguson Equipment; Yanmar Engines
Replaces: Allis Chalmers 2098616; Kubota 15221-43081
Thread: M20 x 1.5
O.D.: 3 (76.2)
Height: 2 27/32 (72.2)
I.Gskt: [1] Included

BF941

Fuel Spin-on



Replaces: Komatsu 600-311-8220
Thread: 3/4 -16
O.D.: 3 1/32 (77.0)
Height: 5 13/16 (147.6)
I.Gskt: [1] Included
Related To: BF954 (Short Version)

PF942

Fuel/Water Coalescer Element



Fits: Cerlist, Cruisair, Cummins Engines; Fram FCS1133PL Housing
Use With: PF943
Replaces: Cerlist 151222904; Cummins 136198
O.D.: 2 7/8 (73.0)
I.D.: 1 1/16 (27.0)
Height: 7 19/32 (192.9)
A. Gskt: [2] Attached
F. Gskt: G344, [1] Included

PF943

Fuel/Water Separator Element



Fits: Case, Cerlist, Cruisair, Cummins Engines; Fram FCS1133PL Housing
Use With: PF942
Replaces: Cerlist 1512903; Cummins 136197
O.D.: 2 7/8 (73.0)
I.D.: 1 1/16 (27.0)
Height: 4 13/16 (122.2)
A. Gskt: [2] Attached
F. Gskt: G344, [1] Included

PF945

Fuel or Hydraulic Element



Fits: Frigiking, Hyster, Michigan, Minneapolis-Moline Equipment; Fram FBM1110PL Housings
Replaces: Frigiking 5100154; Hyster 201641
O.D.: 2 7/8 (73.0)
I.D.: 9/16 (14.3) & 21/32 (16.7)
Height: 2 9/16 (65.1)
A. Gskt: [2] Attached
F. Gskt: [1] Included

PF946

Secondary Fuel Element with Bail Handle



Fits: Allis Chalmers, Ingersoll-Rand, International Equipment
Replaces: Allis Chalmers 138267; International 367378-R91
O.D.: 2 7/8 (73.0)
I.D.: 3/4 (19.1) & 13/16 (20.6)
Height: 4 1/16 (103.2)
F. Gskt: [3] Included

PF947

Primary Fuel Element with Bail Handle



Fits: Allis Chalmers, Ingersoll-Rand, International Equipment; Kohler Generators
Replaces: Allis Chalmers 40487894; International 368278-R91
O.D.: 2 7/8 (73.0)
I.D.: 9/16 (14.3) & 1/2 (12.7)
Height: 4 (101.6)
F. Gskt: [3] Included
Grommets: [2] Attached

BF948

Fuel Spin-on



Notes: CAUTION: Do NOT use for John Deere applications.
 CAUTION: Furnished D-Ring must be installed on post for seal.
 Can be used with FB1311 base.
Fits: Cummins Engines; Hino Trucks
Replaces: Cummins 154711; Fleetguard FF104
Thread: 1 -14
O.D.: 3 11/16 (93.7)
Height: 4 3/8 (111.1)
I.Gskt: G381-A
O-Ring: ES24-D
Related To: BF957 (Extended Life, Long Version)
 BF7557, BF7558 (Extended Life Versions)

BF948-JD

Fuel Spin-on with Drain



Notes: CAUTION: Furnished End Seal must be installed on post for seal.
Fits: John Deere Loaders, Tractors ONLY
Replaces: John Deere AR21627R
Thread: 1 -14
O.D.: 3 11/16 (93.7)
Height: 4 11/16 (119.1)
I.Gskt: G381-A
F. Gskt: [1] Included

PF949

Fuel or Lube Element with Bail Handle



Fits: Chicago-Pneumatic Compressors; Cooper-Bessemer Engines; Euclid, Hyster Equipment
Replaces: Euclid 9040974; Hyster 235872
O.D.: 6 1/32 (153.2)
I.D.: 1 (25.4)
Height: 14 1/2 (368.3)
F. Gskt: G102-A, G210
End Seals: [2] Attached

F950-F

Felt Fuel Element with Bail Handle



Fits: Akerman, Claas, Demag, Liebherr Equipment; Kassbohrer, Mercedes-Benz, Scania, Volvo Buses, Trucks
Replaces: Liebherr 550770208; Mercedes-Benz 4220920005
O.D.: 3 1/4 (82.6)
I.D.: 17/32 (13.5)
Height: 5 5/8 (142.9)
F. Gskt: [1] Included
Grommets: [2] Attached

F950-F WO

Felt Fuel Element with Bail Handle



Fits: Claas Combines; Iveco, M.A.N., R.V.I. Buses, Trucks
Replaces: Claas 133035
O.D.: 3 3/16 (81.0)
I.D.: 1/2 (12.7)
Height: 5 5/8 (142.9)
Grommets: [2] Attached

Measurements Are Shown In Inches And (Millimeters)

WARNING: These products can expose you to chemicals, including Diisononyl Phthalate, Carbon black extracts, Nickel, 1,3 Butadiene, Ethylene Oxide, Epichlorohydrin, which are known to the State of California to cause cancer, and Bisphenol, Ethylene Glycol, Ethylene Oxide, 1,3 Butadiene, Epichlorohydrin, which are known to the State of California to cause birth defects or other reproductive harm. For more information go to www.P65Warnings.ca.gov.

PF950



Fuel Element

Fits: Atlas Copco, Daewoo, Deutz, International, Michigan Equipment; Iveco, M.A.N., Mercedes-Benz, Scania-Vabis, Volvo Buses, Trucks
Replaces: Deutz 1289054; International 3059245-R91; Mercedes-Benz 4777901; Volvo 233239
O.D.: 2 7/8 (73.0)
I.D.: 7/16 (11.1)
Height: 5 9/16 (141.3)
F. Gskt: G332
Grommets: [2] Attached

PT951



Power Steering Element

Notes: Inside-Out Flow Direction
Fits: Galion Equipment; International, Mack Buses, Trucks
Replaces: Galion 255027; International 279294-C92; Mack 485GB3160
O.D.: 3 15/32 (88.1)
I.D.: 29/32 (23.0) & 1 15/32 (37.3)
Height: 2 25/32 (70.6)
O. Gskt: G115-A
End Seals: [2] Attached
Related To: PT903 (with Furnished Gasket)

PF952



Fuel Element

Replaces: Cuno CF31
O.D.: 2 7/8 (73.0)
I.D.: 1 1/16 (27.0)
Height: 19 1/2 (495.3)
F. Gskt: G237
End Seals: [2] Attached
Related To: F911-DL (Wound Cotton Version)

F953-F



Felt Fuel Element

Fits: Claas Combines; Iveco, M.A.N. Buses, Trucks; Deutz Engines
Replaces: Deutz 1168403
O.D.: 2 3/4 (69.9)
I.D.: 7/16 (11.1)
Height: 4 17/32 (115.1)
A. Gskt: [2] Attached
F. Gskt: [1] Included

BF954



Fuel Spin-on

Fits: Isuzu, Toyota Trucks; Case, Ford, Hitachi, John Deere, Kobelco, Komatsu Equipment; Isuzu Engines; Nissan Lift Trucks
Replaces: Isuzu 1-3240-018; John Deere GV10809; Nissan 16403-Z7000
Thread: 3/4 -16
O.D.: 3 1/16 (77.8)
Height: 3 7/16 (87.3)
I.Gskt: [1] Included
Related To: BF941 (Long Version)

BF955



Fuel Storage Tank Spin-on

Notes: Can be used with FB1307 base.
Fits: Purolator Optional Filter Housings
Replaces: Cim-Tek 700-10; Purolator F54725, F71601
Thread: 1 -12
O.D.: 3 11/16 (93.7)
Height: 5 3/8 (136.5)
I.Gskt: G381-A
Related To: BF971 (Long Version)

BF956



Fuel Storage Tank Spin-on

Notes: Can be used with FB1307 base.
Contains: Water Absorbent Media
Fits: Fuel Pumps; Fuel Storage Tanks
Replaces: Cim-Tek 700-14
Thread: 1 -12
O.D.: 3 11/16 (93.7)
Height: 5 3/8 (136.5)
I.Gskt: G381-A
Related To: BF915 (Standard Media Version)

BF957



Fuel Spin-on

Notes: CAUTION: Furnished D-Ring must be installed on post for seal.
 Can be used with FB1311 base.
Fits: Cummins Engines
Replaces: Cummins 158172
Thread: 1 -14
O.D.: 3 11/16 (93.7)
Height: 5 7/16 (138.1)
I.Gskt: G381-A
O-Ring: ES24-D
Related To: BF948 (Short Version)
 BF1212 (Fuel/Water Separator Version)
 BF7557, BF7558 (Extended Life Versions)

BF957-D



Fuel Spin-on with Drain

Notes: CAUTION: Furnished D-Ring must be installed on post for seal.
 Can be used with FB1311 base.
Fits: Cummins Engines
Replaces: Cummins 154789
Thread: 1 -14
O.D.: 3 11/16 (93.7)
Height: 5 7/16 (138.1)
I.Gskt: G381-A
O-Ring: ES24-D
Related To: BF948 (Short Version)
 BF1212 (Fuel/Water Separator Version)
 BF7557, BF7558 (Extended Life Versions)

BF958



Storage Tank Fuel/Water Separator Spin-on with Drain

Fits: Fuel Pumps, Fuel Storage Tanks
Replaces: Amoco A08, AO8; Cim-Tek 700-04
Thread: 1 3/8 -12
O.D.: 3 11/16 (93.7)
Height: 7 7/16 (188.4)
I.Gskt: [1] Included

BF959



Dual-Stage Box-Style Metal Fuel Filter

Notes: Heavy-duty metal version of BF909.
 Do NOT substitute BF909.
Contains: Air Bleed Vent
 Water Drain
Fits: Allis Chalmers, John Deere Equipment
Replaces: Allis Chalmers 4036432; John Deere AR86745, RE27091; Stanadyne 22177
Length: 5 1/8 (130.2)
Width: 3 11/16 (93.7)
Height: 3 7/32 (81.8)

Measurements Are Shown In Inches And (Millimeters)

WARNING: These products can expose you to chemicals, including Diisononyl Phthalate, Carbon black extracts, Nickel, 1,3 Butadiene, Ethylene Oxide, Epichlorohydrin, which are known to the State of California to cause cancer, and Bisphenol, Ethylene Glycol, Ethylene Oxide, 1,3 Butadiene, Epichlorohydrin, which are known to the State of California to cause birth defects or other reproductive harm. For more information go to www.P65Warnings.ca.gov.

P960

By-Pass Lube Element with Bail Handle



Fits: Deutz Engines
Replaces: Deutz 155150610
O.D.: 2 7/8 (73.0)
I.D.: 1/2 (12.7) & 9/16 (14.3)
Height: 4 1/4 (108.0)
F. Gskt: [1] Included
Grommets: [2] Attached

BF962

Fuel Spin-on



Notes: CAUTION: Furnished O-Ring must be installed on post for seal.
Fits: Allis Chalmers, Fiat-Allis Equipment
Replaces: Allis Chalmers 4025230; Fiat-Allis 40289456
Thread: 15/16 -16
O.D.: 3 11/16 (93.7)
Height: 5 3/8 (136.5)
I.Gskt: G381-A
O-Ring: [1] Included

PF963

Fuel Element



Fits: Komatsu Equipment
Replaces: Komatsu 611-073-6130
O.D.: 3 7/16 (87.3)
I.D.: 19/32 (15.1)
Height: 5 5/8 (142.9)
F. Gskt: [1] Included
Grommets: [2] Attached

BF964

In-Line Fuel Filter



Fits: Chrysler, Dodge, Plymouth Automotive, Light-Duty Trucks
Replaces: Chrysler MD026581
O.D.: 1 15/16 (49.2)
Inlet: 5/16
Outlet: 5/16
Length: 3 1/32 (77.0)
Grommets: [1] Attached

BF966

In-Line Fuel Filter



Contains: [2] Plastic Retainer Clips
Fits: Ford, Lincoln, Mercury Automotive
Replaces: Ford E9TZ-9B072-CA
O.D.: 3 1/8 (79.4)
Inlet: 5/16
Outlet: 5/16
Length: 5 13/16 (147.6)

PF967

Primary Fuel Element



Fits: Clark, Michigan Equipment
Replaces: Clark 945444, 945624
O.D.: 3 (76.2)
I.D.: 1 1/16 (27.0)
Height: 5 5/8 (142.9)
A. Gskt: [2] Attached
F. Gskt: G264-A, G299

BF968

Fuel Spin-on



Fits: International Engines
Replaces: International 392301-R91
Thread: 5/8 -11
O.D.: 3 11/16 (93.7)
Height: 5 3/8 (136.5)
I.Gskt: G381-A

BF970

Fuel Spin-on



Notes: Do NOT use on Cummins engines.
Contains: Integral Post Seal
Fits: Caterpillar, International, Link-Belt, New Holland Equipment
Replaces: Caterpillar 1P2299
Thread: 1 -14
O.D.: 3 11/16 (93.7)
Height: 7 1/8 (181.0)
I.Gskt: G381-A
Related To: BF1214 (Fuel/Water Separator Version)

BF971

Fuel Storage Tank Spin-on



Notes: Can be used with FB1307 base.
Fits: EMD Locomotive; Fuel Storage Tanks
Replaces: Cim-Tek 700-03
Thread: 1 -12
O.D.: 3 11/16 (93.7)
Height: 7 1/8 (181.0)
I.Gskt: G381-A
Related To: BF955 (Short Version)

BF974-D

Fuel Spin-on with Drain



Fits: Galion Graders
Replaces: Galion D73246
Thread: 13/16 -16
O.D.: 3 11/16 (93.7)
Height: 7 7/16 (188.9)
I.Gskt: G381-A

B975

Full-Flow Lube Spin-on



Notes: Do NOT use on Case, Deutz or International applications.
 See application sections and B167, B236, BT261, B262.
Contains: Anti-Drainback Valve
 8 PSID By-Pass Valve
Fits: Akerman, Broyt Equipment; Thermo King Refrigeration Units; Volvo Buses, Equipment, Trucks
Replaces: Carrier 70-000011; Thermo King 11-4565; Volvo 423135, 423135-3
Thread: 1 -12
O.D.: 3 11/16 (93.7)
Height: 7 1/8 (181.0)
I.Gskt: G381-A

Measurements Are Shown In Inches And (Millimeters)

WARNING: These products can expose you to chemicals, including Diisononyl Phthalate, Carbon black extracts, Nickel, 1,3 Butadiene, Ethylene Oxide, Epichlorohydrin, which are known to the State of California to cause cancer, and Bisphenol, Ethylene Glycol, Ethylene Oxide, 1,3 Butadiene, Epichlorohydrin, which are known to the State of California to cause birth defects or other reproductive harm. For more information go to www.P65Warnings.ca.gov.

BF976



Secondary Fuel Spin-on

Contains: Integral Post Seal
Fits: Mack Trucks
Replaces: Mack 483GB431
Thread: 1 1/16 -16
O.D.: 4 1/4 (108.0)
Height: 10 7/16 (265.1)
I.Gskt: [1] Included

PF986



Fuel Element with Bail Handle

Fits: Komatsu Equipment; Volvo-Penta, Yanmar Engines
Replaces: Volvo 6604946, 6643218
O.D.: 2 9/16 (65.1)
I.D.: 7/16 (11.1) & 1/2 (12.7)
Height: 2 5/8 (66.7)
Grommets: [2] Attached

BF978



Secondary Fuel Spin-on

Contains: Integral Post Seal
Fits: International Engines, Equipment
Replaces: International 702253-C1, 703419-C91
Thread: 1 -14
O.D.: 3 11/16 (93.7)
Height: 8 23/32 (221.5)
I.Gskt: G381-A

PF987



Fuel Element

Fits: Bennett Fuel Pumps
Replaces: Bennett 3112
O.D.: 3 15/16 (100.0)
I.D.: 1 5/8 (41.3) One End
Height: 4 1/2 (114.3)

BF979



Primary Fuel Spin-on

Contains: Integral Post Seal
Fits: International Engines
Replaces: International 702251-C1, 703420-C91
Thread: 1 -14
O.D.: 3 11/16 (93.7)
Height: 8 23/32 (221.5)
I.Gskt: G381-A
Related To: BF1225 (Fuel/Water Separator Version)

BF988



Fuel Spin-on

Fits: Deutz, Volvo Engines; R.V.I. Trucks
Replaces: Bosch 1-457-434-062; Deutz 1180597; Volvo 4669875
Thread: M16 x 1.5
O.D.: 3 1/32 (77.0)
Height: 4 27/32 (123.0)
I.Gskt: G449-B
Related To: BF1221 (Fuel/Water Separator Version)

BF980



Fuel Spin-on

Fits: DAF Buses, Trucks
Replaces: DAF 247138
Thread: M16 x 1.5
O.D.: 3 11/16 (93.7)
Height: 8 1/8 (206.4)
I.Gskt: G381-A

BF989



Nylon Screen In-Line Fuel Filter

Contains: [4] Clamps
 [2] Hoses
Fits: Ford Automotive, Light-Duty Trucks; International, Versatile, Wheel Horse Equipment
Replaces: Ford D1FZ-9155-A, D2RY-9155-A, D3FZ-9155-A; Motorcraft FG44A
O.D.: 15/16 (23.8)
Inlet: 5/16
Outlet: 5/16
Length: 3 1/32 (77.0)

PF981



Fuel Element

Fits: Case, Hitachi, John Deere, Komatsu, Kubota, Mustang, Takeuchi, Yanmar Equipment
Replaces: John Deere CH10479; Komatsu YM12455055700; Kubota 16271-43560; Yanmar 124550-55700
O.D.: 1 3/8 (34.9)
I.D.: 1/2 (12.7) One End
Height: 3 1/2 (88.9)
I.Gskt: [1] Included
O-Ring: [1] Included

BF991



Primary Fuel Spin-on

Contains: Integral Post Seal
Fits: Thermo King Refrigeration Units; International Equipment, Trucks
Replaces: Carrier 20-113692; International 702143-C1; Thermo King 11-3692
Thread: 1 -14
O.D.: 3 11/16 (93.7)
Height: 7 1/8 (181.0)
I.Gskt: G381-A

BF984



Primary Fuel Spin-on

Contains: Integral Post Seal
Fits: Hino, Nissan Trucks; International Engines
Replaces: International 625625-C1
Thread: 1 -14
O.D.: 3 11/16 (93.7)
Height: 5 5/16 (134.9)
I.Gskt: G381-A

BF992



Secondary Fuel Spin-on

Contains: Integral Post Seal
Fits: Thermo King Refrigeration Units
Replaces: Carrier 20-113693; Thermo King 11-3726
Thread: 7/8 -14
O.D.: 3 11/16 (93.7)
Height: 5 3/8 (136.5)
I.Gskt: [1] Included

Measurements Are Shown In Inches And (Millimeters)

WARNING: These products can expose you to chemicals, including Diisononyl Phthalate, Carbon black extracts, Nickel, 1,3 Butadiene, Ethylene Oxide, Epichlorohydrin, which are known to the State of California to cause cancer, and Bisphenol, Ethylene Glycol, Ethylene Oxide, 1,3 Butadiene, Epichlorohydrin, which are known to the State of California to cause birth defects or other reproductive harm. For more information go to www.P65Warnings.ca.gov.

BF995



Nylon Screen Screw-in Carburetor Fuel Filter
Fits: Ford Automotive
Replaces: Ford D7TE-9155-A
O.D.: 31/32 (24.6)
Inlet: 5/16
Outlet: 1/8-27
Length: 2 5/16 (58.7)

P996



Full-Flow Lube Element
Notes: If a conversion kit is already installed, or if originally equipped with element-type, use P999-HD.
Contains: Two-Way 8 PSID By-Pass Valve
Replaces: Nugent lube bag without a kit and without switching lines because of Baldwins two-way by-pass valve.
O.D.: 5 1/16 (128.6)
I.D.: 11/16 (17.5) & 1 1/4 (31.8)
Height: 12 5/32 (308.8)
A. Gskt: [1] Attached
Spring: [1] Attached
O. Gskt: G164-A, G263, G269, G281

PF997



Fuel Element
Fits: Lister Engines
Replaces: Lister 201-13116
O.D.: 2 5/32 (54.8)
I.D.: 9/32 (7.1) & 29/32 (23.0)
Height: 3 19/32 (91.3)
F. Gskt: [3] Included
O-Ring: [2] Included

P998



Full-Flow Lube Element
Contains: Reinforced Centertube
Fits: Cummins Engines
Replaces: Cummins 173174
O.D.: 4 3/4 (120.7)
I.D.: 11/16 (17.5) & 1 9/16 (39.7)
Height: 7 1/2 (190.5)
O. Gskt: G354
End Seals: [2] Attached

P999-HD



Heavy-Duty Full-Flow Lube Element
Notes: To convert to spin-on use OB1368 or OB1369 base and B96
CAUTION: When converting from bag-type with any conversion kit, lines must be switched so oil flows outside-in (see P996 for Baldwin solution)
Contains: Reinforced Centertube
Fits: Cummins Engines
Replaces: Cummins 256843
O.D.: 4 31/32 (126.2)
I.D.: 11/16 (17.5) & 1 9/16 (39.7)
Height: 9 11/16 (246.1)
O. Gskt: G164-A, G263, G269, G278, G336
End Seals: [2] Attached

BF1008



In-Line Fuel Filter
Fits: Dodge Dakota, Ramcharger
Replaces: Chrysler 52004611, 52018646
O.D.: 2 5/32 (54.8)
Inlet: 5/16
Outlet: 5/16
Length: 6 3/8 (161.9)

V1009-W



Cotton Full-Flow Lube Sock
Fits: LeRoi, Roiline Power Units; Waukesha Engines
Replaces: LeRoi 431002; Roiline 810079
O.D.: 4 3/4 (120.7)
I.D.: 13/16 (20.6) One End
Height: 10 (254.0)
F. Gskt: [1] Included

BF1010



In-Line Fuel Filter
Fits: Mazda Automotive
Replaces: Mazda JE49-20-490
O.D.: 2 13/16 (71.4)
Inlet: 5/16
Outlet: 5/16
Length: 5 5/32 (131.0)

V1044-O



Vac-Cel Dual-Stage Full-Flow Lube Sock
Fits: WhiteGMC Trucks
Replaces: White 883451
O.D.: 4 1/8 (104.8)
I.D.: 1 1/4 (31.8)
Height: 9 3/4 (247.7)
F. Gskt: G115-A

BF1045



In-Line Fuel Filter
Contains: [2] Plastic Retainer Clips
Fits: Buick Roadmaster, Cadillac Fleetwood Brougham, Chevrolet Caprice, Impala
Replaces: GMC 25121978
O.D.: 2 9/32 (57.9)
Inlet: 3/8
Outlet: 3/8
Length: 6 15/32 (164.3)

BF1046



In-Line Fuel Filter
Contains: [2] Plastic Retainer Clips
Fits: Chevrolet, Saturn Automotive; GMC Light-Duty Trucks, Express Vans
Replaces: GMC 25121468
O.D.: 2 9/32 (57.9)
Inlet: 3/8
Outlet: 3/8
Length: 6 13/32 (162.7)

BF1047



In-Line Fuel Filter
Notes: Reverse Flow
Fits: Volvo Trucks
Replaces: Volvo 3507416-0, 9142658
O.D.: 3 5/16 (84.9)
Inlet: 5/16
Outlet: 5/16
Length: 7 17/32 (191.3)

BF1048



In-Line Fuel Filter
Fits: Subaru Baja, Forester, Impreza, Legacy, SVX
Replaces: Subaru 42072-AA011, 42072-AA120, 42072-PA010
O.D.: 3 3/8 (85.7)
Inlet: 5/16
Outlet: 5/16
Length: 4 7/8 (123.8)

Measurements Are Shown In Inches And (Millimeters)

WARNING: These products can expose you to chemicals, including Diisononyl Phthalate, Carbon black extracts, Nickel, 1,3 Butadiene, Ethylene Oxide, Epichlorohydrin, which are known to the State of California to cause cancer, and Bisphenol, Ethylene Glycol, Ethylene Oxide, 1,3 Butadiene, Epichlorohydrin, which are known to the State of California to cause birth defects or other reproductive harm. For more information go to www.P65Warnings.ca.gov.

BF1049 In-Line Fuel Filter
Fits: Acura SLX; Chevrolet LUV; Honda Passport; Isuzu Amigo, Rodeo, Trooper
Replaces: Isuzu 8-25053-640, 8-25121-778-0
O.D.: 2 5/16 (58.7)
Inlet: 5/16
Outlet: 5/16
Length: 5 15/32 (138.9)



BF1050 In-Line Fuel Filter
Fits: Geo Prizm; Toyota Automotive
Replaces: Toyota 23300-19295
O.D.: 2 3/4 (69.9)
Inlet: M14 x 1.5
Outlet: M12 x 1 1/4
Length: 4 9/32 (108.7)
F. Gskt: [2] Copper Washers



BF1052 Wire Cloth In-Line Fuel Filter
Fits: Case Excavators, Loaders
Replaces: Case D145357
O.D.: 1 29/32 (48.4)
Inlet: 3/8
Outlet: 3/8
Length: 3 13/16 (96.8)



BF1053 In-Line Fuel Filter
Contains: 5/16 Inch Return Line
 Steel Braided Ground Wire
Fits: Chrysler Automotive
Replaces: Chrysler 4682370
O.D.: 1 29/32 (48.4)
Inlet: 3/8
Outlet: 5/16
Length: 36 (914.4)



BF1054 In-Line Fuel Filter
Contains: 5/16 Inch Return Line
Fits: Chrysler Cirrus; Dodge Stratus; Plymouth Breeze
Replaces: Chrysler 4695049
O.D.: 2 5/32 (54.8)
Inlet: 3/8
Outlet: 5/16
Length: 9 1/2 (241.3)



BF1056 Fuel Spin-on
Fits: Mercedes-Benz Buses, Trucks
Replaces: Mercedes-Benz 10920501
Thread: M14 x 1.5
O.D.: 3 1/32 (77.0)
Height: 3 15/32 (88.1)
I.Gskt: G449-B



BF1057 In-Line Fuel Filter
Fits: Chrysler Automotive
Replaces: Chrysler 4495780, 4495781, 4636686, 4636687
O.D.: 2 5/32 (54.8)
Inlet: 5/16
Outlet: 5/16
Length: 4 5/16 (110.0)



BF1059 In-Line Fuel Filter
Fits: Toyota Automotive
Replaces: Toyota 23300-74210, 23300-79425
O.D.: 2 9/16 (65.1)
Inlet: M14 x 1.5
Outlet: M12 x 1 1/4
Length: 4 (101.6)
F. Gskt: [2] Copper Washers



BF1061 In-Line Fuel Filter
Fits: Mitsubishi, Toyota Automotive
Replaces: Toyota 23300-74260, 23300-79495
O.D.: 2 9/16 (65.1)
Inlet: M14 x 1.5
Outlet: M12 x 1 1/4
Length: 4 1/32 (102.4)
F. Gskt: [2] Metal Washers



BF1100 In-Line Fuel Filter
Fits: Chrysler, Dodge, Geo, Hyundai, Mitsubishi, Suzuki, Toyota Automotive
Replaces: Chrysler MB504732, MB504750; Suzuki 15410-61A00; Toyota 23300-19175, 23300-49145, 23300-69025, 23300-79055
O.D.: 2 3/4 (69.9)
Inlet: M12 x 1 1/4
Outlet: M12 x 1 1/4
Length: 4 29/32 (124.6)
F. Gskt: [4] Metal Washers



BF1102 Fuel Spin-on
Contains: Anti-Drainback Valve Standpipe
Fits: ERF, Leyland Trucks; Rolls-Royce Engines
Replaces: Rolls-Royce OD19596
Thread: M24 x 1.5
O.D.: 3 11/16 (93.7)
Height: 7 3/16 (182.6)
I.Gskt: G401
O. Gskt: ES24-B



BF1104 In-Line Fuel Filter
Fits: Isuzu, Nissan Automotive
Replaces: Nissan 16400-F5100
O.D.: 2 17/32 (64.3)
Inlet: 5/16
Outlet: 5/16
Length: 4 11/16 (119.1)



BF1105 In-Line Fuel Filter
Fits: Ford, Isuzu, Jaguar, Nissan Automotive
Replaces: Ford F3XY-9155-F; Nissan 16400-N8601
O.D.: 3 1/8 (79.4)
Inlet: 5/16
Outlet: 5/16
Length: 5 3/8 (136.5)



BF1110 Fuel Spin-on
Contains: Integral Post Seal
Fits: Caterpillar, John Deere, Mitsubishi Equipment
Replaces: Mitsubishi 34462-00300
Thread: M20 x 1.5
O.D.: 3 1/32 (77.0)
Height: 4 3/32 (104.0)
I.Gskt: [1] Included



Measurements Are Shown In Inches And (Millimeters)

WARNING: These products can expose you to chemicals, including Diisononyl Phthalate, Carbon black extracts, Nickel, 1,3 Butadiene, Ethylene Oxide, Epichlorohydrin, which are known to the State of California to cause cancer, and Bisphenol, Ethylene Glycol, Ethylene Oxide, 1,3 Butadiene, Epichlorohydrin, which are known to the State of California to cause birth defects or other reproductive harm. For more information go to www.P65Warnings.ca.gov.

BF1112

In-Line Fuel Filter



Fits: Toyota Automotive, Vans
Replaces: Toyota 23300-29065, 23300-46060;
 GMC 25176332
O.D.: 2 9/16 (65.1)
Inlet: M14 x 1.5
Outlet: M12 x 1 1/4
Length: 3 31/32 (100.8)
F. Gskt: [2] Metal Washers

BF1123

In-Line Fuel Filter



Replaces: Isuzu 8-94125-784-0
O.D.: 2 7/16 (61.9)
Inlet: 5/16
Outlet: 5/16
Length: 4 13/16 (122.2)

BF1140

In-Line Fuel Filter



Fits: Subaru, Toyota Automotive
Replaces: Subaru 7420-23020
O.D.: 3 5/32 (80.2)
Inlet: 5/16
Outlet: 5/16
Length: 2 9/32 (57.9)

BF1148

In-Line Fuel Filter



Fits: Hyundai, Kia, Toyota Automotive
Replaces: Toyota 23300-65010
O.D.: 2 3/4 (69.9)
Inlet: M14 x 1.5
Outlet: M14 x 1.5
Length: 4 9/32 (108.7)

BF1150

In-Line Fuel Filter



Fits: Suzuki Automotive
Replaces: Suzuki 15410-80000
O.D.: 3 5/16 (84.1)
Inlet: 5/16
Outlet: 5/16
Length: 2 15/16 (74.6)

BF1160

Primary In-Line Fuel Filter



Fits: Honda Automotive
Replaces: Honda 16900-SE0-004
O.D.: 2 25/32 (70.6)
Inlet: 5/16
Outlet: 5/16
Length: 2 19/32 (65.9)

BF1163

In-Line Fuel Filter



Fits: Nissan Automotive
Replaces: Nissan 16400-72L00
O.D.: 2 17/32 (64.3)
Inlet: 5/16
Outlet: 5/16
Length: 5 (127.0)

BF1166

In-Line Fuel Filter



Contains: [2] Plastic Retainer Clips
Fits: Ford Pickups, Vans
Replaces: Ford F0TZ-9155-B
O.D.: 3 1/8 (79.4)
Inlet: 5/16
Outlet: 5/16
Length: 6 25/32 (172.2)

BF1170

In-Line Fuel Filter



Contains: [2] Plastic Retainer Clips
Fits: Ford Automotive
Replaces: Ford F1SZ-9155-A
O.D.: 2 7/32 (56.4)
Inlet: 5/16
Outlet: 3/8
Length: 6 3/8 (161.9)

BF1171

In-Line Fuel Filter



Contains: [1] Plastic Retainer Clip
Fits: GM Automotive
Replaces: GMC 25121293
O.D.: 2 5/32 (54.8)
Inlet: 3/8
Outlet: M16 x 1.5
Length: 5 3/8 (136.5)

BF1172

In-Line Fuel Filter



Contains: [1] 12 Inch Length of 3/8 Inch Fuel Line
 [1] Plastic Retainer Clip
Fits: Buick Century; Oldsmobile Cutlass Ciera;
 Pontiac Automotive
Replaces: GMC 10140514, 25121656
O.D.: 2 5/32 (54.8)
Inlet: 3/8
Outlet: 3/8
Length: 6 15/32 (164.3)

BF1173

Wire Cloth In-Line Fuel Strainer



Notes: Inside-Out Flow Direction
Fits: Cummins Engines; Case, Caterpillar,
 Gradall, New Holland, Vermeer, Volvo
 Equipment
Replaces: Cummins 3826094
O.D.: 1 29/32 (48.4)
Inlet: 3/8
Outlet: 3/8
Length: 3 13/16 (96.8)

BF1174

In-Line Fuel Filter



Contains: [2] Plastic Retainer Clips
Fits: Chevrolet, Pontiac Automotive
Replaces: GMC 10091791
O.D.: 2 5/32 (54.8)
Inlet: 3/8
Outlet: 3/8
Length: 6 5/16 (160.3)

BF1177

In-Line Fuel Filter



Fits: Mercedes-Benz Automotive
Replaces: Mercedes-Benz 24770701
O.D.: 3 13/32 (86.5)
Inlet: M12 x 1.5
Outlet: M14 x 1.5
Length: 5 23/32 (145.3)
F. Gskt: [2] Washers

Measurements Are Shown In Inches And (Millimeters)



WARNING: These products can expose you to chemicals, including Diisononyl Phthalate, Carbon black extracts, Nickel, 1,3 Butadiene, Ethylene Oxide, Epichlorohydrin, which are known to the State of California to cause cancer, and Bisphenol, Ethylene Glycol, Ethylene Oxide, 1,3 Butadiene, Epichlorohydrin, which are known to the State of California to cause birth defects or other reproductive harm. For more information go to www.P65Warnings.ca.gov.

BF1178

In-Line Fuel Filter



Fits: Chrysler, Mitsubishi Automotive
Replaces: Mitsubishi MB433774
O.D.: 2 1/8 (54.0)
Inlet: 5/16
Outlet: 5/16
Length: 2 15/16 (74.6)

BF1188

In-Line Fuel Filter



Fits: Honda Automotive
Replaces: Honda 16010-SM4-931, 16010-SM4-932
O.D.: 3 3/8 (85.7)
Inlet: M14 x 1.5
Outlet: M12 x 1 1/4
Length: 3 21/32 (92.9)
F. Gskt: [2] Metal Washers

BF1179

Universal In-Line Fuel Filter



Fits: Chrysler, Daihatsu, Mitsubishi, Toyota Automotive, Light-Duty Trucks
Replaces: Mitsubishi MB504753, MB658689; Toyota 23030-74020, 23300-19045
O.D.: 2 3/4 (69.9)
Inlet: M14 x 1.5
Outlet: M12 x 1 1/4
Length: 4 3/8 (111.1)
F. Gskt: [2] Metal Washers

BF1190

In-Line Fuel Filter



Fits: Ford, Suzuki Automotive
Replaces: Ford F4BZ-9155-A
O.D.: 2 3/4 (69.9)
Inlet: 5/16
Outlet: 5/16
Length: 5 3/4 (146.0)

BF1181

In-Line Fuel Filter



Fits: Chrysler Automotive
Replaces: Chrysler 4554040
O.D.: 2 5/32 (54.8)
Inlet: 3/8
Outlet: 5/16
Length: 6 13/32 (162.7)

BF1191

In-Line Fuel Filter



Fits: Toyota Automotive
Replaces: Toyota 23300-39035
O.D.: 2 3/4 (69.9)
Inlet: M12 x 1 1/4
Outlet: M12 x 1 1/4
Length: 4 13/32 (111.9)
F. Gskt: [4] Copper Washers

BF1182

In-Line Fuel Filter



Fits: Dodge Vans, Viper
Replaces: Chrysler 4708317, 52019023, 52020016
O.D.: 2 5/32 (54.8)
Inlet: 5/16
Outlet: 5/16
Length: 6 1/4 (158.8)

BF1193

In-Line Fuel Filter



Fits: Acura Integra, Honda Accord, Civic
Replaces: Honda 16010-ST5-931
O.D.: 2 15/16 (74.6)
Inlet: M14 x 1.5
Outlet: M12 x 1 1/4
Length: 4 7/16 (112.7)
F. Gskt: [2] Metal Washers

BF1184

In-Line Fuel Filter



Contains: [2] Plastic Retainer Clips
Fits: Ford Escort, Thunderbird; Mercury Cougar
Replaces: Ford E9SZ-9155-A; Motorcraft FG862
O.D.: 2 1/4 (57.2)
Inlet: 5/16
Outlet: 5/16
Length: 6 (152.4)

BF1194

In-Line Fuel Filter



Fits: Ford, Mazda Automotive
Replaces: Ford F32Z-9155-A; Mazda FS11-20-490A
O.D.: 3 1/8 (79.4)
Inlet: 5/16
Outlet: 5/16
Length: 5 31/32 (151.6)

BF1185

In-Line Fuel Filter



Contains: [2] Plastic Retainer Clips
Fits: Daewoo, GMC Automotive
Replaces: GMC 25121129
O.D.: 2 3/16 (55.6)
Inlet: 5/16
Outlet: 5/16
Length: 6 5/16 (160.3)

BF1195

In-Line Fuel Filter



Fits: Alfa Romeo, Audi, BMW, Land Rover, Mercedes-Benz, Renault, Volkswagen Automotive
Replaces: BMW 13321269231, 13321269548, 13321270038, 13329063165
O.D.: 3 3/16 (81.0)
Inlet: 5/16
Outlet: 5/16
Length: 6 1/4 (158.8)

BF1186

In-Line Fuel Filter



Fits: Geo, Isuzu Automotive
Replaces: GMC 25121141, 25121150, 25121160
O.D.: 2 5/32 (54.8)
Inlet: M14 x 1.5
Outlet: M14 x 1.5
Length: 4 7/16 (112.7)

BF1199

In-Line Fuel Filter



Fits: Dodge Monaco, Eagle Premier, Jeep Grand Cherokee
Replaces: Chrysler 33003007, 8933003007
O.D.: 2 5/8 (66.7)
Inlet: 3/8
Outlet: 5/16
Length: 6 9/16 (166.7)

Measurements Are Shown In Inches And (Millimeters)

WARNING: These products can expose you to chemicals, including Diisononyl Phthalate, Carbon black extracts, Nickel, 1,3 Butadiene, Ethylene Oxide, Epichlorohydrin, which are known to the State of California to cause cancer, and Bisphenol, Ethylene Glycol, Ethylene Oxide, 1,3 Butadiene, Epichlorohydrin, which are known to the State of California to cause birth defects or other reproductive harm. For more information go to www.P65Warnings.ca.gov.

BF1201



Fuel/Water Separator Element with Drain
Fits: GMC Trucks
Replaces: GMC 10154635
O.D.: 2 9/16 (65.1)
I.D.: 3/4 (19.1)
Height: 5 15/32 (138.9)
Grommets: [1] Attached

BF1204



Secondary Fuel/Water Separator Spin-on with Drain
Notes: Inside-Out Flow Direction
Contains: Integral Post Seal
 Sensor Port Thread: 1/2-20
Fits: Ford Diesel Engines
Thread: 1 -14
O.D.: 3 11/16 (93.7)
Height: 6 1/16 (154.0)
I.Gskt: [1] Included
Related To: BF1204-O (with Open Port)
 BF1204-SP (with Sensor Port)

BF1204-O



Fuel/Water Separator Spin-on with Open Port for Bowl
Contains: Port Thread: 1 1/4-10
 Integral Post Seal
Fits: Racor 225R Assembly
Replaces: Racor R26S
Thread: 1 -14
O.D.: 3 3/4 (95.3)
Height: 4 11/16 (119.1)
F. Gskt: [1] Included
O-Ring: [1] Included
Related To: BF1204 (with Drain)
 BF1204-SP (with Sensor Port)

BF1204-SP



Secondary Fuel/Water Separator Spin-on with Drain and Sensor Port
Notes: Inside-Out Flow Direction.
 May use OP8752 to plug Sensor Port.
Contains: Integral Post Seal
 Sensor Port Thread: 1/2-20
Fits: Ford Diesel Engines
Thread: 1 -14
O.D.: 3 11/16 (93.7)
Height: 6 1/16 (154.0)
I.Gskt: [1] Included
F. Gskt: [1] Included
Related To: BF1204 (with Drain)
 BF1204-O (with Open Port)

BF1205



Primary Fuel/Water Separator Spin-on with Drain
Notes: Inside-Out Flow Direction
Contains: Integral Post Seal
 Sensor Port Thread: 1/2-20
Fits: Ford, John Deere Engines
Replaces: Ford E7HZ-9N184-B,
 E8HT-9J288-AA
Thread: 1 -14
O.D.: 3 11/16 (93.7)
Height: 6 1/16 (154.0)
I.Gskt: [1] Included
Related To: BF1205-SP (with Sensor Port)

BF1205-SP



Primary Fuel/Water Separator Spin-on with Drain and Sensor Port
Notes: Inside-Out Flow Direction.
 May use OP8752 to plug Sensor Port.
Contains: Integral Post Seal
 Sensor Port Thread: 1/2-20
Fits: Ford, John Deere Engines
Replaces: Ford E7HZ-9N184-B,
 E8HT-9J288-AA
Thread: 1 -14
O.D.: 3 11/16 (93.7)
Height: 6 1/16 (154.0)
I.Gskt: [1] Included
F. Gskt: [1] Included
Related To: BF1205 (with Drain)

BF1210



Fuel/Water Separator Spin-on with Drain
Notes: Inside-Out Flow Direction
Fits: Cummins Engines
Replaces: Fleetguard FS19540;
 Luber-finer LFP2000C
Thread: 15/16 -16
O.D.: 4 1/4 (108.0)
Height: 11 11/32 (288.1)
I.Gskt: G401

BF1211



Fuel Spin-on with Drain
Notes: Inside-Out Flow Direction
Replaces: Luber-finer LFP2100C
Thread: 15/16 -16
O.D.: 4 1/4 (108.0)
Height: 8 17/32 (216.7)
I.Gskt: G401

BF1212



Fuel/Water Separator Spin-on with Drain
Notes: CAUTION: Furnished D-Ring must be installed on post for seal.
 Can be used with FB1311 base.
Fits: Cummins Engines
Use With: BF1212 FOAM
Replaces: Cummins 3308638
Thread: 1 -14
O.D.: 3 11/16 (93.7)
Height: 7 7/16 (188.9)
I.Gskt: G381-A
F. Gskt: ES24-D
Related To: BF957, BF957-D (Fuel Versions)







BF1212 FOAM



Foam Wrap for BF1212
Use With: BF1212
O.D.: 4 5/8 (117.5)
Height: 8 (203.2)

Measurements Are Shown In Inches And (Millimeters)

WARNING: These products can expose you to chemicals, including Diisononyl Phthalate, Carbon black extracts, Nickel, 1,3 Butadiene, Ethylene Oxide, Epichlorohydrin, which are known to the State of California to cause cancer, and Bisphenol, Ethylene Glycol, Ethylene Oxide, 1,3 Butadiene, Epichlorohydrin, which are known to the State of California to cause birth defects or other reproductive harm. For more information go to www.P65Warnings.ca.gov.

<p>BF1213</p>  <p>Fuel/Water Separator Spin-on with Drain Fits: Detroit Diesel Engines Replaces: ACDelco TP1009 Thread: 1 -12 O.D.: 3 11/16 (93.7) Height: 7 13/32 (188.1) I.Gskt: [1] Included</p>	<p>BF1219</p>  <p>Fuel/Water Separator Spin-on with Drain Contains: Integral Post Seal Fits: Mack Trucks Replaces: Mack 483GB433B Thread: 13/16 -18 O.D.: 4 1/4 (108.0) Height: 8 1/8 (206.4) I.Gskt: G381-A Related To: BF877 (Fuel Version)</p>
<p>BF1214</p>  <p>Fuel/Water Separator Spin-on with Drain Contains: Integral Post Seal Fits: Caterpillar Engines Replaces: Fleetguard FS1214 Thread: 1 -14 O.D.: 3 11/16 (93.7) Height: 7 13/32 (188.1) I.Gskt: G381-A Related To: BF970 (Fuel Version)</p>	<p>BF1220</p>  <p>Fuel/Water Separator Spin-on with Drain Notes: CAUTION: Furnished D-Ring must be installed on post for seal. Contains: Integral Post Seal Fits: Case, International Equipment Replaces: Racor B32004, S3204 Thread: 1 -14 O.D.: 3 11/16 (93.7) Height: 6 3/16 (157.2) I.Gskt: G381-A F. Gskt: ES24-D</p>
<p>BF1215</p>  <p>In-Line Fuel/Water Separator with Water Relief Valve Fits: Volkswagen Golf, Jetta Replaces: Volkswagen 191127401A O.D.: 3 3/8 (85.7) Inlet: 5/16 Outlet: 5/16 Length: 6 5/8 (168.3)</p>	<p>BF1221</p>  <p>Fuel/Water Separator Spin-on with Drain Contains: Standpipe Fits: Deutz, Volvo Engines Replaces: Fleetguard FS1221 Thread: M16 x 1.5 O.D.: 3 1/32 (77.0) Height: 6 21/32 (169.1) I.Gskt: G449-B Related To: BF988 (Fuel Version) BF1232 (Sensor Port Version)</p>
<p>BF1216</p>  <p>Fuel/Water Separator Spin-on with Drain Notes: Can be used with FB1306 base. Contains: Integral Post Seal Fits: Cummins Engines Replaces: Cummins 3309437 Thread: 1 1/4 -12 O.D.: 4 11/16 (119.1) Height: 12 3/32 (307.2) I.Gskt: [1] Included Related To: BF596 (Fuel Version)</p>	<p>BF1222</p>  <p>Fuel/Water Separator Spin-on with Drain Contains: Integral Post Seal Fits: Ford Engines Replaces: Ford E8TZ-9N184-A Thread: 1 -14 O.D.: 4 9/32 (108.7) Height: 5 1/4 (133.4) I.Gskt: [1] Included Related To: BF1222-O (with Open Port) BF1222-SP (with Sensor Port)</p>
<p>BF1217</p>  <p>Fuel/Water Separator Spin-on with Drain Fits: Iveco EuroCargo, EuroStar, EuroTech Series Trucks Replaces: Iveco 1907539 Thread: M14 x 1.5 O.D.: 3 11/16 (93.7) Height: 7 11/32 (186.5) I.Gskt: [1] Included</p>	<p>BF1222-O</p>  <p>Fuel/Water Separator Spin-on with Open Port for Bowl Contains: Port Thread: 3-12 Integral Post Seal Fits: Ford Engines Replaces: Ford F2TZ-9N-184-A; Motorcraft FD3375 Thread: 1 -14 O.D.: 4 1/4 (108.0) Height: 4 1/8 (104.8) I.Gskt: [1] Included Related To: BF1222 (with Drain) BF1222-SP (with Sensor Port)</p>
<p>BF1218</p>  <p>Fuel/Water Separator Spin-on with Drain Contains: Integral Post Seal Fits: Caterpillar Engines Replaces: Fleetguard FS1218 Thread: 1 -14 O.D.: 4 1/4 (108.0) Height: 11 5/16 (287.3) I.Gskt: G401 Related To: BF584 (Fuel Version)</p>	

Measurements Are Shown In Inches And (Millimeters)

WARNING: These products can expose you to chemicals, including Diisononyl Phthalate, Carbon black extracts, Nickel, 1,3 Butadiene, Ethylene Oxide, Epichlorohydrin, which are known to the State of California to cause cancer, and Bisphenol, Ethylene Glycol, Ethylene Oxide, 1,3 Butadiene, Epichlorohydrin, which are known to the State of California to cause birth defects or other reproductive harm. For more information go to www.P65Warnings.ca.gov.

BF1222-SP

Fuel/Water Separator Spin-on with Drain and Sensor Port



Notes: May use OP8751 to plug Sensor Port.
Contains: Integral Post Seal
Sensor Port Thread: 7/16-20
Fits: Ford Engines
Replaces: Ford E8TZ-9N184-A
Thread: 1 -14
O.D.: 4 9/32 (108.7)
Height: 5 1/4 (133.4)
I.Gskt: [1] Included
F. Gskt: [1] Included
Related To: BF1222 (with Drain)
 BF1222-O (with Open Port)

BF1223

Fuel/Water Separator Spin-on with Drain



Contains: Integral Post Seal
Fits: Carrier-Transcold, Ford, Hino Trucks;
 Ingersoll-Rand Compressors
Replaces: Carrier 30-01079; Ford F1HZ-9365-A
Thread: 1 -14
O.D.: 4 1/4 (108.0)
Height: 6 25/32 (172.2)
I.Gskt: [1] Included
Related To: BF1223-O (with Open Port for Bowl)
 BF1223-SP (with Sensor Port)
 BF1224 (without Drain or Sensor Port)

BF1223-O

Fuel/Water Separator Spin-on with Open Port for Bowl



Contains: Port Thread: 3 3/4-10
 Integral Post Seal
Fits: Ford Trucks
Replaces: Ford F1HZ-9365-A;
 Motorcraft FD3368
Thread: 1 -14
O.D.: 4 1/4 (108.0)
Height: 5 7/32 (132.6)
I.Gskt: [1] Included
F. Gskt: [1] Included
Related To: BF1223 (Drain Version)
 BF1223-SP (Sensor Port Version)

BF1223-SP

Fuel/Water Separator Spin-on with Drain and Sensor Port



Notes: May use OP8750 to plug Sensor Port.
Contains: Integral Post Seal
Sensor Port Thread: 9/16-18
Fits: Carrier-Transcold, Ford, Hino Trucks;
 Ingersoll-Rand Compressors
Replaces: Carrier 30-01079; Ford F1HZ-9365-A
Thread: 1 -14
O.D.: 4 1/4 (108.0)
Height: 6 25/32 (172.2)
I.Gskt: [1] Included
F. Gskt: [1] Included
Related To: BF1223-O (Open Port Version)
 BF1223 (Drain Version)

BF1224

Fuel/Water Separator Spin-on



Contains: Integral Post Seal
Fits: Carrier-Transcold Refrigeration Units
Replaces: Carrier 30-01090-00
Thread: 1 -14
O.D.: 4 1/4 (108.0)
Height: 5 29/32 (150.0)
I.Gskt: [1] Included
Related To: BF1223 (Drain Version)
 BF1223-O (Open End Version)
 BF1223-SP (Drain and Sensor Port Version)

BF1225

Fuel/Water Separator Spin-on with Drain



Contains: Integral Post Seal
Fits: Case Combines
Replaces: GMC 25011691
Thread: 1 -14
O.D.: 3 11/16 (93.7)
Height: 7 3/8 (187.3)
I.Gskt: G381-A
Related To: BF979 (Fuel Version)

BF1226

Fuel/Water Separator Spin-on with Drain



Notes: CAUTION: Furnished O-Ring must be installed on post for seal.
Contains: Standpipe
Fits: Cummins Engines
Replaces: Cummins 3903202
Thread: M16 x 1.5
O.D.: 3 1/32 (77.0)
Height: 5 11/16 (144.5)
I.Gskt: G449-B
O-Ring: [1] Included

BF1231

Fuel/Water Separator Spin-on with Drain



Contains: Integral Post Seal
Fits: Ford, New Holland Equipment
Replaces: Ford 87840136
Thread: 1 -14
O.D.: 4 5/16 (109.5)
Height: 6 25/32 (172.2)
I.Gskt: [1] Included

BF1232

Fuel/Water Separator Spin-on with Sensor Port



Contains: Integral Post Seal
Sensor Port Thread: 1 1/4-10
Fits: 1989-93 Dodge Pickup with 5.9L Diesel Engine
Replaces: Chrysler 4429107
Thread: M16 x 1.5
O.D.: 3 1/32 (77.0)
Height: 4 11/16 (119.1)
I.Gskt: G449-B
O-Ring: [2] Included
Related To: BF1221 (without Sensor Port)

BF1233

Fuel/Water Separator Spin-on with Sensor Port



Contains: Sensor Port Thread: 1 1/4-10
Fits: Dodge Light-Duty, Peterbilt Trucks
Replaces: Chrysler 4741689
Thread: M20 x 1.5
O.D.: 3 11/16 (93.7)
Height: 4 3/8 (111.1)
I.Gskt: G401
F. Gskt: [2] Included

BF1239

Fuel/Water Separator Spin-on



Contains: Water Absorbent Media
Fits: Various Fuel Islands
Replaces: Cim-Tek 700-23, 700-68
Thread: 1 1/2 -16
O.D.: 5 1/16 (128.6)
Height: 10 3/4 (273.1)
F. Gskt: G369-B
O. Gskt: G286-C, G369-V, G372, G447, G483, G704, G710

Measurements Are Shown In Inches And (Millimeters)

WARNING: These products can expose you to chemicals, including Diisononyl Phthalate, Carbon black extracts, Nickel, 1,3 Butadiene, Ethylene Oxide, Epichlorohydrin, which are known to the State of California to cause cancer, and Bisphenol, Ethylene Glycol, Ethylene Oxide, 1,3 Butadiene, Epichlorohydrin, which are known to the State of California to cause birth defects or other reproductive harm. For more information go to www.P65Warnings.ca.gov.

BF1240

Fuel/Water Separator Spin-on with Drain



Contains: Integral Post Seal
Fits: John Deere Scrapers
Replaces: John Deere AT77587
Thread: 1 -14
O.D.: 4 1/4 (108.0)
Height: 6 25/32 (172.2)
I.Gskt: G401

V1240-C

Vac-Cel By-Pass Lube Sock



Fits: Hall-Scott, Hercules Equipment; Waukesha Engines
Replaces: Hall-Scott 6412240A; Hercules 7611970
O.D.: 4 1/8 (104.8)
I.D.: 1 1/16 (27.0)
Height: 12 (304.8)
F. Gskt: G115-A

BF1248

Fuel/Water Separator Spin-on with Drain



Notes: CAUTION: Furnished O-Ring must be installed on post for seal.
Contains: Integral Post Seal
Fits: Komatsu Engines, Equipment
Replaces: Komatsu 600-311-8293
Thread: 1 -14
O.D.: 3 11/16 (93.7)
Height: 5 5/8 (142.9)
I.Gskt: G381-A
F. Gskt: ES3028

BF1249

Fuel/Water Separator Spin-on with Drain



Notes: CAUTION: Furnished D-Ring must be installed on post for seal.
 Can be used with FB1311 base.
Fits: Blue Bird, Ford, Freightliner, International Buses, Trucks; Hamm Rollers; Hyundai, Liebherr Equipment; Optional on Cummins Engines
Replaces: Alliance ABPN/N10G-FS1242; Bomag 31701061, 31701062; Cummins 3355903, 3353904; Hamm 1236385; John Deere RE61554; Kobelco YN02PU1004S002; Liebherr 7381816; Massey Ferguson 108615W1, 108614W91; Nissan FL6442N
Thread: 1 -14
O.D.: 3 11/16 (93.7)
Height: 8 29/32 (226.2)
I.Gskt: G381-A
F. Gskt: ES24-D
Related To: BF1249-O (Open Port Version)
 BF1249-SP (Sensor Port Version)
 BF1393-SP (High Efficiency Version)

BF1249-O

Fuel/Water Separator Spin-on with Open Port for Bowl



Notes: CAUTION: Furnished O-Ring must be installed on Post for Seal.
Contains: Integral Post Seal
 Port Thread: 1 1/4-10
Fits: Blue Bird, Ford, Freightliner, International Buses, Trucks; Hamm Rollers; Hyundai, Liebherr Equipment; Optional on Cummins Engines
Replaces: Nissan FL6442N
Thread: 1 -14
O.D.: 3 21/32 (92.9)
Height: 6 5/8 (168.3)
I.Gskt: ES24-D
F. Gskt: ES24D
O-Ring: [1] Included
Related To: BF1249 (Standard Version)
 BF1249-SP (Sensor Port Version)

BF1249-SP

Fuel/Water Separator Spin-on with Drain and Sensor Port



Notes: CAUTION: Furnished D-Ring must be installed on post for seal.
 Can be used with FB1311 base.
 May use OP8752 to plug Sensor Port.
Contains: Sensor Port Thread: 1/2-20
Fits: Blue Bird, Ford, Freightliner, International Buses, Trucks; Hamm Rollers; Hyundai, Liebherr Equipment; Optional on Cummins Engines
Replaces: Alliance ABPN/N10G-FS1242; Bomag 31701062; Cummins 3355903, 3353904; Hamm 1236385; John Deere RE61554; Kobelco YN02PU1004S002; Liebherr 7381816; Massey Ferguson 108615W1, 108614W91; Nissan FL6442N
Thread: 1 -14
O.D.: 3 11/16 (93.7)
Height: 8 29/32 (226.2)
I.Gskt: G381-A
F. Gskt: ES24-D
Related To: BF1249 (Standard Version)
 BF1249-O (Open Port Version)

BF1252

Primary Fuel/Water Separator Spin-on with Drain



Notes: CAUTION: Furnished D-Ring must be installed on post for seal.
 Can be used with FB1311 base.
Fits: Blue Bird Buses
Replaces: Racor S3230
Thread: 1 -14
O.D.: 3 11/16 (93.7)
Height: 7 13/32 (188.1)
I.Gskt: G381-A
F. Gskt: ES24-D
Related To: BF1366-O (Open Port Version)
 BF1384-SP (Sensor Port Version)

BF1253

Fuel/Water Separator Spin-on with Drain



Notes: Inside-Out Flow Direction
Fits: Racor 220 Series Fuel/Water Separators
Replaces: Racor R24S
Thread: 1 -14
O.D.: 3 11/16 (93.7)
Height: 5 7/32 (132.6)
I.Gskt: [1] Included

Measurements Are Shown In Inches And (Millimeters)

WARNING: These products can expose you to chemicals, including Diisononyl Phthalate, Carbon black extracts, Nickel, 1,3 Butadiene, Ethylene Oxide, Epichlorohydrin, which are known to the State of California to cause cancer, and Bisphenol, Ethylene Glycol, Ethylene Oxide, 1,3 Butadiene, Epichlorohydrin, which are known to the State of California to cause birth defects or other reproductive harm. For more information go to www.P65Warnings.ca.gov.

BF1256

Primary Fuel/Water Separator Spin-on with Drain



Contains: Integral Post Seal
Fits: Mack Trucks
Replaces: Mack 483GB472M
Thread: M22 x 1.5
O.D.: 4 1/4 (108.0)
Height: 9 15/16 (252.4)
I.Gskt: [1] Included

BF1265

Fuel/Water Separator Spin-on with Drain



Contains: Integral Post Seal
Fits: John Deere Combines, Loaders, Tractors
Replaces: Caterpillar 133-5673; John Deere RE502203
Thread: 1 -14
O.D.: 4 9/32 (108.7)
Height: 11 5/16 (287.3)
I.Gskt: [1] Included
Related To: BF1395-O (Open Port Version)
 BF1395-SP (Sensor Port Version)

BF1257

Fuel/Water Separator Spin-on with Drain



Contains: Integral Post Seal
Fits: Bobcat Loaders; Cummins Engines; Gehl Equipment
Replaces: Clark 6647773; Melroe-Bobcat 6667352
Thread: M16 x 1.5
O.D.: 3 (76.2)
Height: 4 7/32 (107.2)
I.Gskt: G449-B

BF1266

Fuel/Water Separator Spin-on with Drain



Notes: CAUTION: Furnished D-Ring must be installed on post for seal.
Fits: Detroit Diesel Engines
Replaces: GMC 12542374; Racor S3212
Thread: 1 -12
O.D.: 3 11/16 (93.7)
Height: 6 5/32 (156.4)
I.Gskt: [1] Included
F. Gskt: ES24-D
Related To: BF1278-O (Open Port Version)

BF1258

Fuel/Water Separator Spin-on with Drain



Notes: CAUTION: Furnished D-Ring must be installed on post for seal.
 Can be used with FB1311 base.
Contains: Standpipe
Fits: Case, Daewoo Equipment; Peterbilt Trucks; Cummins N14 Plus Engines
Replaces: Fleetguard FS1001
Thread: 1 -14
O.D.: 3 11/16 (93.7)
Height: 7 7/16 (188.9)
I.Gskt: G381-A
F. Gskt: ES24-D

BF1267

Fuel/Water Separator Spin-on with Drain



Fits: Onan Generators; Toro Greensmaster Mowers with Mitsubishi Engines
Replaces: Onan 149-2106; Toro 63-8300
Thread: M16 x 1.5
O.D.: 3 1/32 (77.0)
Height: 3 1/8 (79.4)
I.Gskt: [1] Included

BF1259

Fuel/Water Separator Spin-on with Drain



Notes: CAUTION: Furnished D-Ring must be installed on post for seal.
 Can be used with FB1311 base.
Contains: Standpipe
Fits: Caterpillar, Cummins Engines; Euclid Rear Dumps; Kenworth, Volvo Trucks; Versatile Tractors
Replaces: Cummins 3329289; Fleetguard FS1000
Thread: 1 -14
O.D.: 3 11/16 (93.7)
Height: 9 17/32 (242.1)
I.Gskt: G381-A
F. Gskt: ES24-D

BF1268

Suction Line Fuel/Water Separator Spin-on with Drain



Contains: Integral Post Seal
Fits: Chevrolet, Ford, Freightliner Trucks; Caterpillar Engines
Replaces: Caterpillar 175-2949
Thread: 1 -14
O.D.: 3 11/16 (93.7)
Height: 7 3/8 (187.3)
A. Gskt: G381-A

BF1269

Fuel/Water Separator Spin-on with Drain



Fits: DAF Trucks
Replaces: DAF 1319159
Thread: M16 x 1.5
O.D.: 3 1/32 (77.0)
Height: 5 7/32 (132.6)
I.Gskt: G449-B

BF1261

Fuel/Water Separator Spin-on with Drain



Fits: Lister-Petter Engines
Replaces: Lister-Petter 75118100
Thread: M16 x 1.5
O.D.: 3 (76.2)
Height: 4 7/32 (107.2)
I.Gskt: G449-B
F. Gskt: [1] Included

BF1270-SP

Fuel/Water Separator Spin-on with Drain and Sensor Port



Notes: CAUTION: Furnished O-Ring must be installed on post for seal.
Contains: Sensor Port Thread: 1/2-20
Replaces: Teledyne 504598
Thread: 1 -14
O.D.: 3 11/16 (93.7)
Height: 6 1/16 (154.0)
I.Gskt: [1] Included
O-Ring: [1] Included

BF1262

Fuel/Water Separator Spin-on with Drain



Contains: Integral Post Seal
Fits: Cummins Engines
Replaces: Cummins 3089916; Fleetguard FS1006
Thread: 1 1/4 -12
O.D.: 4 21/32 (118.3)
Height: 12 1/16 (306.4)
I.Gskt: [1] Included

Measurements Are Shown In Inches And (Millimeters)

WARNING: These products can expose you to chemicals, including Diisononyl Phthalate, Carbon black extracts, Nickel, 1,3 Butadiene, Ethylene Oxide, Epichlorohydrin, which are known to the State of California to cause cancer, and Bisphenol, Ethylene Glycol, Ethylene Oxide, 1,3 Butadiene, Epichlorohydrin, which are known to the State of California to cause birth defects or other reproductive harm. For more information go to www.P65Warnings.ca.gov.

BF1271 Fuel/Water Separator Spin-on with Sensor Port
Notes: CAUTION: Furnished O-Ring must be installed on post for seal.
Contains: Sensor Port Thread: 1 1/4-10 Integral Post Seal
Fits: Cummins ISB Series Engines
Replaces: Cummins 3942533
Thread: M20 x 1.5
O.D.: 3 11/16 (93.7)
Height: 5 3/8 (136.5)
I.Gskt: G401
O-Ring: [1] Included
End Seals: [1] Included



BF1275 Fuel/Water Separator Spin-on with Drain
Contains: Integral Post Seal
Fits: Equipment with Cummins B3.3 Engine Requiring a Fuel/Water Separator
Replaces: Fleetguard FS19594
Thread: 3/4 -16
O.D.: 3 1/32 (77.0)
Height: 5 11/16 (144.5)
I.Gskt: G449-B



BF1272-SPS Fuel/Water Separator Spin-on with Drain, Sensor Port and Reusable Sensor
Notes: CAUTION: Furnished D-Ring must be installed on post for seal.
 For use with Delphi oval sensor.
 Not interchangeable with BF1293-SPS.
Contains: Sensor Port Thread: M14 x 2.0 Standpipe
Fits: Cummins Engines
Replaces: Case J800394; Cummins 3800394; Donaldson P551022; Fleetguard FS1022
Thread: 1 -14
O.D.: 3 11/16 (93.7)
Height: 9 15/32 (240.5)
I.Gskt: G381-A
F. Gskt: ES24-D



BF1276 Fuel/Water Separator Spin-on with Drain
Notes: CAUTION: Furnished O-Ring must be installed on post for seal.
Fits: R.V.I. Trucks
Replaces: Renault 7701030546
Thread: M16 x 1.5
O.D.: 3 1/32 (77.0)
Height: 6 21/32 (169.1)
I.Gskt: G449-B
O-Ring: [1] Included



BF1273-SP Fuel/Water Separator Spin-on with Drain and Sensor Port
Contains: Integral Post Seal
 Sensor Port Thread: 1/2-20
Fits: Nissan UD Trucks
Replaces: Nissan 16400-Z5511
Thread: 1 -14
O.D.: 4 1/4 (108.0)
Height: 6 9/16 (167.5)
I.Gskt: G401
O-Ring: [1] Included



BF1277-SP Fuel/Water Separator Spin-on with Drain and Sensor Port
Notes: May use OP8753 to plug Sensor Port.
 For service, retain reusable sensor from BF1277-SPS, and attach to BF1277-SP.
Contains: Sensor Port Thread: M14 x 2.0
Fits: Cummins ISX, Signature 600 Engines
Replaces: Case 419858A1, 441701A1; Manitowoc A047930
Thread: M85 x 2.0
O.D.: 4 21/32 (118.3)
Height: 11 5/8 (295.3)
I.Gskt: [1] Included
O-Ring: [1] Included
Related To: BF1277-SPS (with Sensor Port and Reusable Sensor)



BF1274-SP Fuel/Water Separator Spin-on with Drain and Sensor Port
Notes: May use OP8753 to plug Sensor Port.
 For service, retain reusable sensor from BF1274-SPS, and attach to BF1274-SP.
Contains: Sensor Port Thread: M14 x 2.0
Fits: Cummins Signature 600 Engines
Replaces: Cummins 3331096; Fleetguard FS1007
Thread: M85 x 2.0
O.D.: 4 21/32 (118.3)
Height: 11 5/8 (295.3)
I.Gskt: [1] Included
O-Ring: [1] Included
Related To: BF1274-SPS (with Sensor Port and Reusable Sensor)



BF1277-SPS Fuel/Water Separator Spin-on with Drain, Sensor Port and Reusable Sensor
Notes: For service, retain reusable sensor from BF1277-SPS, and attach to BF1277-SP.
Contains: Sensor Port Thread: M14 x 2.0
Fits: Cummins ISX, Signature 600 Engines
Replaces: Caterpillar 3964605; Cummins 3101872, 4010651; Fleetguard FS1040
Thread: M85 x 2.0
O.D.: 4 21/32 (118.3)
Height: 11 5/8 (295.3)
I.Gskt: [1] Included
Related To: BF1277-SP (with Sensor Port)



BF1274-SPS Fuel/Water Separator Spin-on with Drain, Sensor Port and Reusable Sensor
Notes: For service, retain reusable sensor from BF1274-SPS, and attach to BF1274-SP.
Contains: Sensor Port Thread: M14 x 2.0
Fits: Cummins Signature 600 Engines
Replaces: Cummins 3331096; Fleetguard FS1007
Thread: M85 x 2.0
O.D.: 4 21/32 (118.3)
Height: 11 5/8 (295.3)
I.Gskt: [1] Included
Related To: BF1274-SP (with Sensor Port)



BF1278 Fuel/Water Separator Spin-on with Drain
Fits: Ingersoll-Rand Compressors
Replaces: Ingersoll-Rand 54468178
Thread: 1 -12
O.D.: 3 11/16 (93.7)
Height: 6 7/32 (158.0)
I.Gskt: [1] Included
Related To: BF1278-O (Open End)



Measurements Are Shown In Inches And (Millimeters)

WARNING: These products can expose you to chemicals, including Diisononyl Phthalate, Carbon black extracts, Nickel, 1,3 Butadiene, Ethylene Oxide, Epichlorohydrin, which are known to the State of California to cause cancer, and Bisphenol, Ethylene Glycol, Ethylene Oxide, 1,3 Butadiene, Epichlorohydrin, which are known to the State of California to cause birth defects or other reproductive harm. For more information go to www.P65Warnings.ca.gov.

BF1278-O

Fuel/Water Separator Spin-on with Open Port for Bowl



Contains: Port Thread: M80 x 2.5
Integral Post Seal
Fits: Ingersoll-Rand Compressors
Replaces: Ingersoll-Rand 54468178
Thread: 1 -12
O.D.: 3 11/16 (93.7)
Height: 4 1/8 (104.8)
I.Gskt: [1] Included
F. Gskt: [1] Included
O-Ring: [1] Included
Related To: BF1278 (Drain Version)

BF1279

Fuel/Water Separator Spin-on with Drain
Notes: CAUTION: Furnished O-Ring must be installed on post for seal.



Fits: Freightliner Argosy, Century Class, Condor
Replaces: Alliance ABP/32FRT02, RA1320RFT02; Racor RA132FRT02
Thread: 1 -14
O.D.: 3 23/32 (94.5)
Height: 7 15/16 (201.6)
I.Gskt: G381-A
O-Ring: [1] Included

BF1280

Fuel/Water Separator Spin-on with Drain
Notes: CAUTION: Furnished O-Ring must be installed on post for seal.



Fits: Cummins Engines
Replaces: Cummins 3925274
Thread: 13/16 -18
O.D.: 3 11/16 (93.7)
Height: 6 1/4 (158.8)
I.Gskt: G401
F. Gskt: [1] Included
Related To: BF7879 (without Drain)

BF1281

Primary Fuel/Water Separator Spin-on with Drain



Contains: Integral Post Seal
Fits: Primary Fuel for Racor 4120 Series Fuel/Water Separators
Replaces: Racor R120P
Thread: 1 -14
O.D.: 4 9/32 (108.7)
Height: 11 5/16 (287.3)
F. Gskt: [1] Included
Related To: BF1281-O (Open Port Version)

BF1281-O

Primary Fuel/Water Separator Spin-on with Open Port for Bowl



Contains: Port Thread: M95 x 2.5
Integral Post Seal
Fits: Primary Fuel for Racor 4120 Series Fuel/Water Separators
Replaces: Racor R120P; Donaldson P550177; Fleetguard FS19754
Thread: 1 -14
O.D.: 4 13/32 (111.9)
Height: 8 19/32 (218.3)
I.Gskt: [2] Included
F. Gskt: [1] Included
Related To: BF1281 (with Drain)

BF1282

Fuel/Water Separator Spin-on with Drain



Notes: CAUTION: Furnished D-Ring must be installed on post for seal.
Can be used with FB1311 base.
Fits: Cummins M11 Engines; Komatsu Equipment
Replaces: Cummins 3843447; Komatsu 1304800-H1
Thread: 1 -14
O.D.: 3 11/16 (93.7)
Height: 6 5/32 (156.4)
I.Gskt: G381-A
F. Gskt: ES24-D
Related To: BF1282-O (Open Port Version)

BF1282-O

Fuel/Water Separator Spin-on with Open Port for Bowl



Notes: CAUTION: Furnished D-Ring must be installed on post for seal.
Contains: Port Thread: 1 1/4-2B
Fits: Agco, Komatsu Equipment; Case Dump Trucks; Cummins Engines
Replaces: Fleetguard FS1241
Thread: 1 -14
O.D.: 3 21/32 (92.9)
Height: 4 19/32 (116.7)
I.Gskt: [1] Included
F. Gskt: ES24-D
O-Ring: [1] Included
Related To: BF1282 (with Drain)

BF1283

Fuel/Water Separator Spin-on with Drain



Contains: Integral Post Seal
Fits: Caterpillar Equipment, Industrial, Marine, Truck Engines; Racor 4120 Series
Replaces: Caterpillar 129-0373; Racor R120S
Thread: 1 -14
O.D.: 4 9/32 (108.7)
Height: 11 7/32 (285.0)
I.Gskt: [1] Included
Related To: BF1283-SP (Sensor Port Version)
BF1283-O (Open Port Version)

BF1283-O

Fuel/Water Separator Spin-on with Open Port for Bowl



Contains: Port Thread: M95 x 2.5
Integral Post Seal
Fits: Caterpillar Equipment, Industrial, Marine, Truck Engines; Racor 4120 Series
Replaces: Racor R120S; Donaldson P550175; Fleetguard FS1071
Thread: 1 -14
O.D.: 4 13/32 (111.9)
Height: 8 19/32 (218.3)
I.Gskt: [2] Included
F. Gskt: [1] Included
Related To: BF1283 (Drain Version)
BF1283-SP (Sensor Port Version)

Measurements Are Shown In Inches And (Millimeters)

WARNING: These products can expose you to chemicals, including Diisononyl Phthalate, Carbon black extracts, Nickel, 1,3 Butadiene, Ethylene Oxide, Epichlorohydrin, which are known to the State of California to cause cancer, and Bisphenol, Ethylene Glycol, Ethylene Oxide, 1,3 Butadiene, Epichlorohydrin, which are known to the State of California to cause birth defects or other reproductive harm. For more information go to www.P65Warnings.ca.gov.

BF1283-SP



Fuel/Water Separator Spin-on with Sensor Port and Drain

Notes: CAUTION: Furnished O-Ring must be installed on post for seal.
May use OP8752 to plug Sensor Port.
Contains: Sensor Port Thread: 1/2-20UNF-2B Integral Post Seal
Fits: Detroit Diesel Series 60 Engines
Replaces: Alliance ABP/N122-R50407
Thread: 1 -14
O.D.: 4 9/32 (108.7)
Height: 11 5/16 (287.3)
I.Gskt: [1] Included
O-Ring: [1] Included
Related To: BF1283 (Drain Version)
BF1283-O (Open Port Version)

BF1285-SP



Fuel/Water Separator Spin-on with Sensor Port and Drain

Contains: Integral Post Seal
Sensor Port Thread: 1/2-20
Fits: John Deere Equipment
Replaces: John Deere RE519608
Thread: 1 -12
O.D.: 4 9/32 (108.7)
Height: 11 7/32 (285.0)
I.Gskt: [1] Included

BF1286



Fuel/Water Separator Spin-on with Drain

Contains: Integral Post Seal
Fits: Mack Engines
Replaces: Mack 483GB477M
Thread: M30 x 1.5
O.D.: 4 1/4 (108.0)
Height: 8 11/32 (211.9)
I.Gskt: [1] Included

BF1287-O



Fuel/Water Separator Spin-on with Open Port for Bowl

Contains: Port Thread: M95 x 2.5
Integral Post Seal
Fits: Komatsu HD465-7, HD605-7 Dump Trucks
Replaces: Komatsu 600-311-3210,
600-319-3240
Thread: 1 1/4 -12
O.D.: 4 7/8 (123.8)
Height: 9 29/32 (251.6)
I.Gskt: [1] Included
A. Gskt: [1] Attached
F. Gskt: [1] Included
Related To: BF1357 (Drain Version)

BF1288-O



Fuel/Water Separator Spin-on with Open Port for Bowl

Contains: Port Thread: M95 x 2.5
Integral Post Seal
Fits: Komatsu Dump Trucks, Equipment
Replaces: Komatsu 600-311-4510,
600-319-4500
Thread: 1 1/4 -12
O.D.: 4 7/8 (123.8)
Height: 9 29/32 (251.6)
I.Gskt: [1] Included
F. Gskt: [1] Included
Related To: BF1357 (Drain Version)

BF1289-SP



Fuel/Water Separator Spin-on with Drain and Sensor Port

Contains: Sensor Port Thread: M12 x 1.75
Fits: Caterpillar, Challenger, Perkins Equipment
Replaces: Agco 529435D1; Caterpillar 2715076, 3087298; Perkins 2656F853
Thread: M22 x 1.5
O.D.: 3 11/16 (93.7)
Height: 7 15/16 (201.6)
I.Gskt: [1] Included
O-Ring: [1] Included

BF1290-O



Fuel/Water Separator Spin-on with Open Port for Bowl

Contains: Port Thread: B80 x 3 8A Metric Buttress
Replaces: CLARCOR Filtration (China) WBF219B; Foton Lovol 1307211500005
Thread: 1 -14
O.D.: 4 11/32 (110.3)
Height: 6 13/32 (162.7)
I.Gskt: [1] Included
O-Ring: [1] Included

PF1291



Water Sensor Element

Fits: Wix 24843 Assembly
Replaces: Cim-Tek EHS30, 300-07; Fleetguard FS1286; Wix 24844
O.D.: 4 17/32 (115.1)
I.D.: 1/2 (12.7) & 1 3/32 (27.8)
Height: 9 3/16 (233.4)
F. Gskt: [2] Included, [1] Metal Washer
Grommets: [1] Attached

BF1292-O



Fuel/Water Separator Spin-on with Open Port for Bowl

Contains: Port Thread: M95 x 2.5
Integral Post Seal
Fits: Deutz Engines; Deutz-Fahr, Fendt Tractors; Iveco Trucks
Replaces: Deutz 4291642; Fendt F339202060120; Iveco 42549295; Mercedes-Benz 4771602, A0004771602; Racor R90TDMAX
Thread: 1 -14
O.D.: 4 5/32 (105.6)
Height: 6 5/16 (160.3)
I.Gskt: [1] Included
O-Ring: [1] Included

BF1293-SPS



Fuel/Water Separator Spin-on with Drain, Sensor Port and Reusable Sensor

Notes: CAUTION: Furnished O-Ring must be installed on post for seal.
For use with Deutz square sensor.
NOT Interchangeable with BF1272-SPS.
Contains: Sensor Port Thread: M14 x 2.0 Standpipe
Fits: Cummins Engines
Replaces: Cummins 3406889; Donaldson P551003; Fleetguard FS1003
Thread: 1 -14
O.D.: 3 11/16 (93.7)
Height: 10 1/32 (254.8)
I.Gskt: G381-A
F. Gskt: ES24-D

Measurements Are Shown In Inches And (Millimeters)

WARNING: These products can expose you to chemicals, including Diisononyl Phthalate, Carbon black extracts, Nickel, 1,3 Butadiene, Ethylene Oxide, Epichlorohydrin, which are known to the State of California to cause cancer, and Bisphenol, Ethylene Glycol, Ethylene Oxide, 1,3 Butadiene, Epichlorohydrin, which are known to the State of California to cause birth defects or other reproductive harm. For more information go to www.P65Warnings.ca.gov.

BF1294-O

Fuel/Water Separator Spin-on with Open Port for Bowl



Contains: Port Thread: 3 3/4-10 2B
Integral Post Seal
Replaces: Scania 1518512; SF-Filter SK3360
Thread: 1 -14
O.D.: 4 1/4 (108.0)
Height: 7 5/32 (181.8)
I.Gskt: [1] Included
F. Gskt: [1] Included

BF1295-O

Fuel Spin-on with Open Port for Bowl



Contains: Port Thread: 3 3/4-10 2B
Replaces: CLARCOR Filtration (China)
CX1010; DCD 4102H1520
Thread: 1 -14
O.D.: 4 1/4 (108.0)
Height: 5 1/32 (127.8)
I.Gskt: [1] Included
F. Gskt: [1] Included

BF1296-O

Fuel Spin-on with Open Port for Bowl



Contains: Port Thread: B80 x 3 8A Metric
Buttress
Fits: Doosan Equipment
Replaces: CLARCOR Filtration (China)
WBF219B1; Sinotruk 13050733
Thread: 1 -14
O.D.: 4 1/4 (108.0)
Height: 6 13/32 (162.7)
I.Gskt: [1] Included
O-Ring: [1] Included

BF1297-O

Fuel Spin-on with Open Port for Bowl



Contains: Port Thread: B80 x 3 8A Metric
Buttress
Integral Post Seal
Replaces: CLARCOR Filtration (China)
WBF219H; Weichai Power 61230080088
Thread: 1 -14
O.D.: 4 9/32 (108.7)
Height: 9 3/32 (231.0)
I.Gskt: [1] Included
O-Ring: [1] Included

BF1298-O

Fuel/Water Separator Spin-on with Open Port for Bowl



Contains: Port Thread: M95 x 2.5
Integral Post Seal
Replaces: Foton Lovol 1105111500002; CAMC
1125A86D-010; CLARCOR Filtration (China)
CX1014A
Thread: 1 -14
O.D.: 4 1/4 (108.0)
Height: 6 5/32 (156.4)
I.Gskt: [1] Included
O-Ring: [1] Included

BF1299-O

Fuel/Water Separator Spin-on with Open Port for Bowl



Contains: Port Thread: 3 3/4-10 2B
Integral Post Seal
Replaces: Yuchai Watyuan 612630080205
Thread: 1 -14
O.D.: 4 1/4 (108.0)
Height: 7 13/16 (198.4)
I.Gskt: [1] Included
F. Gskt: [1] Included

FB1301

Primary Fuel Filter Base for Detroit Diesel Engines



Notes: Converts F845-A, PF845, F916-C or
PF916 from element to spin-on.
Contains: Threaded Stud: 1-12
Use With: BF592, BF781, BF5800, BF5813
O.D.: 4 11/16 (119.1)
Inlet: [1] 3/8-18 In. NPT
Outlet: [2] 3/8-18 In. NPT
Height: 3 3/32 (78.6)

FB1302

Secondary Fuel Filter Base for Detroit Diesel Engines



Notes: Converts PF906 from element to
spin-on.
Contains: Threaded Stud: 13/16-12
Use With: BF593, BF5810
O.D.: 4 11/16 (119.1)
Inlet: [1] 1/4-18 In. NPT
Outlet: [2] 1/4-18 In. NPT
Height: 3 3/32 (78.6)

OB1303

Full-Flow Lube Filter Base for Detroit Diesel Engines



Notes: Converts P20-HD from element to
spin-on.
Contains: Threaded Stud: 1 1/2-12
Lock Plate
Use With: B95, B96
O.D.: 5 1/32 (127.8)
Length: 3 1/2 (88.9)
F. Gskt: [4] Included

FK1304

Kit of 2 Fuel Filter Bases for Detroit Diesel Engines



Notes: Converts Detroit Diesel engines from
element to spin-on.
Contains: FB1301 Pri. Fuel base
FB1302 Sec. Fuel base
FB1301
Thread: 1-12 Stud
O.D.: 4 11/16 (119.1)
Inlet: [1] 3/8-18 In. NPT
Outlet: [2] 3/8-18 In. NPT
FB1302
O.D. 4 11/16 (119.1)
Inlet: 1/4-18 In. NPT
Height 3 3/32 (78.6)

OB1305

By-Pass Lube Filter Base



Contains: Threaded Stud: 5/8-18
Use With: B50, B164, BT341
O.D.: 4 1/4 (108.0)
Inlet: 1/8 In. NPT
Outlet: 1/8 In. NPT
Height: 2 3/4 (69.9)

FB1306

Fuel Filter Base



Contains: Threaded Stud: 1 1/4-12
Use With: BF1216
Replaces: Fleetguard 3302367S
Inlet: 7/8-14
Outlet: 7/8-14
Height: 5 7/32 (132.6)

Measurements Are Shown In Inches And (Millimeters)



WARNING: These products can expose you to chemicals, including Diisononyl Phthalate, Carbon black extracts, Nickel, 1,3 Butadiene, Ethylene Oxide, Epichlorohydrin, which are known to the State of California to cause cancer, and Bisphenol, Ethylene Glycol, Ethylene Oxide, 1,3 Butadiene, Epichlorohydrin, which are known to the State of California to cause birth defects or other reproductive harm. For more information go to www.P65Warnings.ca.gov.

FB1307

Fuel Storage Tank Filter Base



Notes: Part of BF914
Contains: Threaded Stud: 1-12
Use With: BF915, BF955, BF956, BF971
O.D.: 3 3/4 (95.3)
Inlet: 1 In. NPT
Outlet: 1 In. NPT
Height: 2 21/32 (67.5)

OB1308

By-Pass Lube Filter Base for Cummins and Other Engines



Notes: Converts element to spin-on, or can be installed as an auxiliary filter for additional protection.
Contains: Threaded Stud: 1 3/8-16
Use With: B7577
O.D.: 5 7/32 (132.6)
Inlet: 3/8 In. NPT
Outlet: 3/8 In. NPT
Height: 4 23/32 (119.4)

FB1309

Primary Fuel Filter Base for Detroit Diesel Engines



Notes: Converts F844-A from element to spin-on.
Contains: Threaded Stud: 1 1/4-12
Use With: BF784
O.D.: 5 1/2 (139.7)
Inlet: 1/2-14 NPSF
Outlet: [2] 1/2-14 NPSF
Height: 2 23/32 (69.1)

FB1310

Secondary Fuel Filter Base for Detroit Diesel Engines



Notes: Converts PF846 from element to spin-on.
Contains: Threaded Stud: 1 1/16-16
Use With: BF785
O.D.: 5 1/2 (139.7)
Inlet: 3/8-18 NPSF & 1/2-14 NPSF
Outlet: [4] 3/8-18 NPSF
Height: 2 13/16 (71.4)

FB1311

Fuel/Water Separator Base



Notes: This base requires the D-Ring, furnished with filter, for installation. Permits the addition of a remote mount fuel/water separator spin-on to most equipment. This is standard Cummins engine fuel filter mount.
Contains: Bracket Bolt Holes 3/8-16 UNC-2B
 Threaded Stud: 1-14
Use With: BF948, BF957, BF957-D, BF1212, BF1249, BF1252, BF1258, BF1259, BF1282, BF5801, BF5812, BF7557, BF7558
O.D.: 3 19/32 (91.3)
Inlet: 7/8-14 UNF
Outlet: 7/8-14 UNF
Height: 1 15/16 (49.2)

OB1313

Hydraulic Filter Base



Notes: This base requires the use of the G286-C gasket (furnished with BT387, BT387-10, BT388, BT388-10 and BT8424-MPG, optional on others) for installation of the filters listed below. For use on the suction side.
Contains: 3 PSID By-Pass valve
 Threaded Stud: 1 1/2-16
 Threaded Stud: 1 1/4-11 BSP
Use With: BT287, BT287-10, BT287-3, BT351, BT387, BT387-10, BT388, BT388-10, BT389, BT389-10, BT8368, BT8423
O.D.: 5 1/2 (139.7)
Inlet: 1 1/4-11 1/2 NPT
Outlet: 1 1/4-11 1/2 NPT
Height: 5 5/16 (134.9)

OB1314

Hydraulic Filter Base



Notes: This base requires the use of the G286-C gasket (furnished with BT387, BT387-10, BT388, BT388-10 and BT8424-MPG, optional on others) for installation of the filters listed below. For use on the return side.
Contains: 25 PSID By-Pass Valve
 Threaded Stud: 1 1/2-16
 Threaded Stud: 1 1/4-11 BSP
Use With: BT287, BT287-10, BT287-3, BT351, BT387, BT387-10, BT388, BT388-10, BT389, BT389-10, B7011, BT8307-MPG, BT8308-MPG, BT8308-MPG KIT, BT8309-MPG, BT8310-MPG, BT8368, BT8421-MPG, BT8422-MPG, BT8423
O.D.: 5 1/2 (139.7)
Inlet: 1 1/4 In. NPT
Outlet: 1 1/4 In. NPT
Height: 5 5/16 (134.9)

OB1315

Hydraulic Filter Base



Notes: This base requires the use of the G286-C gasket (furnished with BT387, BT387-10, BT388, BT388-10 and BT8424-MPG, optional on others) for installation of the filters listed below. For use on the suction side.
Contains: 5 PSID By-Pass Valve
 Threaded Stud: 1 1/2-16
 Threaded Stud: 1 1/4-11 BSP
Use With: BT287, BT287-10, BT287-3, BT351, BT387, BT387-10, BT388, BT388-10, BT389, BT389-10, B7011, BT8368, BT8423
O.D.: 5 13/32 (137.3)
Inlet: 1 5/8-12 In. SAE
Outlet: 1 5/8-12 In. SAE
Height: 5 5/16 (134.9)

OB1316

Hydraulic Filter Base



Notes: This base requires the use of the G286-C gasket (furnished with BT387, BT387-10, BT388, BT388-10 and BT8424-MPG, optional on others) for installation of the filters listed below. For use on the return side.
Contains: 25 PSID By-Pass Valve
 Threaded Stud: 1 1/2-16
 Threaded Stud: 1 1/4-11 BSP
Use With: BT287, BT287-10, BT287-3, BT351, BT387, BT387-10, BT388, BT388-10, BT389, BT389-10, B7011, BT8307-MPG, BT8308-MPG, BT8308-MPG KIT, BT8309-MPG, BT8310-MPG, BT8368, BT8421-MPG, BT8422-MPG, BT8423
O.D.: 5 13/32 (137.3)
Inlet: 1 5/8-12 In. SAE
Outlet: 1 5/8-12 In. SAE
Height: 5 5/16 (134.9)

Measurements Are Shown In Inches And (Millimeters)

WARNING: These products can expose you to chemicals, including Diisononyl Phthalate, Carbon black extracts, Nickel, 1,3 Butadiene, Ethylene Oxide, Epichlorohydrin, which are known to the State of California to cause cancer, and Bisphenol, Ethylene Glycol, Ethylene Oxide, 1,3 Butadiene, Epichlorohydrin, which are known to the State of California to cause birth defects or other reproductive harm. For more information go to www.P65Warnings.ca.gov.

OB1317

Hydraulic Filter Base



Notes: Has [2] 1/8 In. NPT indicator ports that are designed to accept the VG1325 vacuum gauge.
Top-mount bracket holes can be used for easy installation.
For use on suction side.
Contains: 5 PSID By-Pass Valve
Threaded Stud: 1-12
Use With: BT839, BT839-10, BT8420
O.D.: 3 3/4 (95.3)
Inlet: 3/4-14 NPT
Outlet: 3/4-14 NPT
Height: 3 (76.2)

OB1318

Hydraulic Filter Base



Notes: Has [2] 1/8 In. NPT indicator ports that are designed to accept the PG1326 pressure gauge.
Top-mount bracket holes can be used for easy installation. For use on return side.
Contains: 25 PSID By-Pass Valve
Threaded Stud: 1-12
Use With: BT839, BT839-10, BT8420, BT8428-MPG, BT8443
O.D.: 3 (76.2)
Inlet: 3/4 In. NPT
Outlet: 3/4 In. NPT
Height: 3 3/4 (95.3)

OB1319

Hydraulic Filter Base



Notes: Has [2] 1/8 In. NPT indicator ports that are designed to accept the VG1325 vacuum gauge.
Top-mount bracket holes can be used for easy installation.
For use on suction side.
Contains: 5 PSID By-Pass Valve
Threaded Stud: 1-12
Use With: BT839, BT839-10, BT8420
O.D.: 3 3/4 (95.3)
Inlet: 1 1/16-12 ORB
Outlet: 1 1/16-12 ORB
Height: 3 (76.2)

OB1320

Hydraulic Filter Base



Notes: Has [2] 1/8 In. NPT indicator ports that are designed to accept the PG1326 pressure gauge.
Top-mount bracket holes can be used for easy installation. For use on return side.
Contains: 25 PSID By-Pass Valve
Threaded Stud: 1-12
Use With: BT839, BT839-10, BT8420, BT8428-MPG, BT8443
O.D.: 3 3/4 (95.3)
Inlet: 1 1/16-12 ORB
Outlet: 1 1/16-12 ORB
Height: 3 (76.2)

VG1325

Vacuum Gauge



Notes: This 0-30 vacuum gauge is for use with a 3-5 PSI by-pass filter base.
Mounts directly to base with 1/8" In. NPT.
Replaces: Donaldson P777021

PG1326

Pressure Gauge



Notes: This pressure gauge is for use with a 25 PSI by-pass filter base.
Mounts directly to base with 1/8 Inch NPT.
The indicator is 2 inches in diameter and measures 0-60 psi.
Replaces: Donaldson P777004

BF1329

Fuel/Water Separator Spin-on with Drain



Contains: Integral Post Seal
Fits: Racor 690R Series Assemblies; Scania, Volvo Trucks
Replaces: Racor R90P; John Deere RE500186
Thread: 1 -14
O.D.: 4 9/32 (108.7)
Height: 8 1/8 (206.4)
I.Gskt: [1] Included
Related To: BF1329-SP (SP Thd. 9/16-18)
BF1339-SP (SP Thd. 1/2-20)
BF46072 (Bowl Version)
BF46083-O (Open Port Version)

BF1329-O

Fuel/Water Separator Spin-on with Open Port for Bowl



Notes: Not for use with Alliance ABP/N122-R50418
OBSOLETE Availability Limited to Dealer Stock.
Replaced by BF46083-O
Contains: Port Thread: 3 3/4-10 2B
Integral Post Seal
Fits: Blue Bird Buses; Racor 690R Series Filter Systems; Freightliner, Oshkosh, Scania, Volvo Trucks
Replaces: Scania 1393640; DAF 1296851; Racor R90P; Volvo 8159975
Thread: 1 -14
O.D.: 4 1/4 (108.0)
Height: 6 5/16 (160.3)
I.Gskt: [1] Included
O-Ring: [1] Included
Related To: BF1329 (Standard Version)
BF1329-SP (Sensor Port Version)

BF1329-SP

Fuel/Water Separator Spin-on with Drain and Sensor Port



Notes: May use OP8750 to plug Sensor Port.
Contains: Integral Post Seal
Sensor Port Thread: 9/16-18
Fits: Racor 690R Series Assemblies; Scania, Volvo Trucks
Replaces: Racor R90P; GMC 23514654; John Deere RE500186
Thread: 1 -14
O.D.: 4 9/32 (108.7)
Height: 8 1/8 (206.4)
I.Gskt: [1] Included
O-Ring: [1] Included
Related To: BF1329 (Drain Version)
BF1339-SP (SP Thd. 1/2-20)
BF46072 (Bowl Version)
BF46083-O (Open Port Version)

Measurements Are Shown In Inches And (Millimeters)

WARNING: These products can expose you to chemicals, including Diisononyl Phthalate, Carbon black extracts, Nickel, 1,3 Butadiene, Ethylene Oxide, Epichlorohydrin, which are known to the State of California to cause cancer, and Bisphenol, Ethylene Glycol, Ethylene Oxide, 1,3 Butadiene, Epichlorohydrin, which are known to the State of California to cause birth defects or other reproductive harm. For more information go to www.P65Warnings.ca.gov.

BF1330-SP

Fuel/Water Separator Spin-on with Drain and Sensor Port



Notes: CAUTION: Furnished O-Ring must be installed on post for seal.
Contains: Integral Post Seal
 Sensor Port Thread: 9/16-18
Fits: Detroit Diesel Engines
Replaces: Detroit Diesel 23514654
Thread: 1 -14
O.D.: 4 9/32 (108.7)
Height: 8 1/8 (206.4)
I.Gskt: [1] Included
O-Ring: [1] Included

BF1339-SP

Fuel/Water Separator Spin-on with Drain and Sensor Port



Notes: CAUTION: Furnished O-Ring must be installed on post for seal.
Contains: Integral Post Seal
 Sensor Port Thread: 1/2-20
Fits: Freightliner, Volvo Buses, Trucks; Racor 690R Series Assemblies
Replaces: Racor R90P
Thread: 1 -14
O.D.: 4 9/32 (108.7)
Height: 8 1/8 (206.4)
I.Gskt: [1] Included
O-Ring: [1] Included
Related To: BF1329-SP (SP Thd. 9/16-18)
 BF9898-O (Open Port Version)
 BF46083-O (Bowl Version)
 BF1329 (Drain Version)

BF1345

Fuel/Water Separator Spin-on with Drain



Contains: Integral Post Seal
Fits: International Engines
Replaces: International 1618385-C91, 1677004-C91
Thread: 1 -14
O.D.: 4 1/4 (108.0)
Height: 6 9/16 (166.7)
I.Gskt: [1] Included
Related To: BF1345-O (Open Port Version)
 BF1345-SP (Sensor Port Version)

BF1345-O

Fuel/Water Separator Spin-on with Open Port for Bowl



Contains: Port Thread: 3-12
Fits: International Engines, Trucks
Replaces: International 1618385-C91; Donaldson P550729
Thread: 1 -14
O.D.: 4 1/4 (108.0)
Height: 5 9/32 (134.1)
I.Gskt: [1] Included
O-Ring: [1] Included
Related To: BF1345 (Standard Version)
 BF1345-SP (Sensor Port Version)

BF1345-SP

Fuel/Water Separator Spin-on with Drain and Sensor Port



Notes: May use OP8751 to plug Sensor Port.
Contains: Integral Post Seal
 Sensor Port Thread: 7/16-20
Fits: International Engines
Replaces: International 1618385-C91, 1677004-C91
Thread: 1 -14
O.D.: 4 1/4 (108.0)
Height: 6 9/16 (166.7)
I.Gskt: [1] Included
F. Gskt: [1] Included
Related To: BF1345 (Drain Version)
 BF1345-O (Open Port Version)

BF1346

Fuel/Water Separator Spin-on with Drain



Contains: Integral Post Seal
Fits: Ford, Freightliner, International, Sterling, Western Star Trucks; Mercedes-Benz Engines; Racor Housings
Replaces: International 1685159-C91
Thread: 1 -14
O.D.: 4 1/4 (108.0)
Height: 8 9/32 (210.3)
I.Gskt: [1] Included
Related To: BF1346-SP (Sensor Port Version)
 BF1346-O (Open Port Version)

BF1346-O

Fuel/Water Separator Spin-on with Open Port for Bowl



Contains: Port Thread: M95 x 2.5
 Integral Post Seal
Fits: Ford, Freightliner, International, Sterling, Western Star Trucks; Mercedes-Benz Engines; Racor Housings
Replaces: Racor S3226P; Donaldson P550554; Fleetguard FS19593
Thread: 1 -14
O.D.: 4 1/4 (108.0)
Height: 6 5/16 (160.3)
I.Gskt: [1] Included
F. Gskt: [1] Included
Related To: BF1346 (Drain Version)
 BF1346-SP (Sensor Port Version)

BF1346-SP

Fuel/Water Separator Spin-on with Drain and Sensor Port



Notes: May use OP8752 to plug Sensor Port.
Contains: Integral Post Seal
 Sensor Port Thread: 1/2-20
Fits: Ford, Freightliner, International, Sterling, Western Star Trucks; Mercedes-Benz Engines; Racor Housings
Replaces: Alliance ABP/N122-S3226FL02; International 1685159-C91
Thread: 1 -14
O.D.: 4 1/4 (108.0)
Height: 8 9/32 (210.3)
I.Gskt: [1] Included
O-Ring: [1] Included
Related To: BF1346 (Drain Version)
 BF1346-O (Open Port Version)

Measurements Are Shown In Inches And (Millimeters)

WARNING: These products can expose you to chemicals, including Diisononyl Phthalate, Carbon black extracts, Nickel, 1,3 Butadiene, Ethylene Oxide, Epichlorohydrin, which are known to the State of California to cause cancer, and Bisphenol, Ethylene Glycol, Ethylene Oxide, 1,3 Butadiene, Epichlorohydrin, which are known to the State of California to cause birth defects or other reproductive harm. For more information go to www.P65Warnings.ca.gov.

BF1347



Fuel/Water Separator Spin-on with Drain
Contains: Integral Post Seal
Fits: Optional Fuel/Water Separator on Various Truck Engines with Maximum Flow Rate of 75 GPH (U.S.)
Replaces: Alliance ABP/N122-S3226FL01; Racor S3226T
Thread: 1 -14
O.D.: 4 1/4 (108.0)
Height: 8 9/32 (210.3)
I.Gskt: [1] Included
Related To: BF1347-O (Open Port Version)

BF1349



Fuel/Water Separator Spin-on with Drain
Contains: Integral Post Seal
Fits: Cummins Engines; Volvo Trucks
Replaces: Racor R90T
Thread: 1 -14
O.D.: 4 9/32 (108.7)
Height: 8 7/32 (208.8)
I.Gskt: [1] Included

BF1347-O



Fuel/Water Separator Spin-on with Open End
Contains: Port Thread 3.75-10 UNS-2B Integral Post Seal
Fits: Freightliner Chassis; Freightliner, International, Kenworth Trucks; Thomas Buses
Replaces: Racor S3226T; AC Delco TP1348; Donaldson P551034; Fleetguard FS19933, FS19798; Wix 33813
Thread: 1 -14 UNS-2B
O.D.: 4 3/8 (111.1)
Height: 6 7/32 (158)
F. Gskt: [2] Included
Related To: BF1347 (Drain Version)

BF1350-SP



Fuel/Water Separator Spin-on with Drain and Sensor Port
Notes: CAUTION: Furnished O-Ring must be installed on post for seal.
Contains: Sensor Port Thread: 1/2-20
Fits: Caterpillar Engines; Equipment
Replaces: Caterpillar 146-6695
Thread: 1 -14
O.D.: 3 11/16 (93.7)
Height: 7 13/16 (198.4)
I.Gskt: [1] Included
O-Ring: [1] Included
Related To: BF46030-O (Open Port Version)

BF1348



Fuel/Water Separator Spin-on with Drain
Contains: Integral Post Seal
Fits: Blue Bird Buses; Freightliner, Hino, Peterbilt Trucks; Racor 325 Series
Replaces: Racor S3225P
Thread: 1 -14
O.D.: 4 5/16 (109.5)
Height: 6 25/32 (172.2)
I.Gskt: [1] Included
Related To: BF1348-O (Open Port Version) BF1348-SP (Sensor Port Version)

BF1352-SPS



Fuel/Water Separator Spin-on with Drain, Sensor Port and Reusable Sensor
Notes: CAUTION: Furnished D-Ring must be installed on post for seal.
Contains: Sensor Port Thread: M14 x 2.0
Fits: Agco, Hesston, Hyundai, Massey Ferguson Equipment; Cummins B4.5, B5.9L, QSB4.5 Engines
Replaces: Cummins 3991498; Fleetguard FS19616
Thread: M20 x 1.5
O.D.: 3 11/16 (93.7)
Height: 7 3/8 (187.3)
I.Gskt: [1] Included
F. Gskt: [1] Included

BF1348-O



Fuel/Water Separator Spin-on with Open Port for Bowl
Contains: Port Thread: M95 x 2.5 Integral Post Seal
Fits: Blue Bird Buses; Freightliner, Hino, Peterbilt Trucks; Racor 325 Series
Replaces: Racor S3225P
Thread: 1 -14
O.D.: 4 1/4 (108.0)
Height: 5 3/16 (131.8)
I.Gskt: [1] Included
A. Gskt: [1] Included
O-Ring: [1] Included
Related To: BF1348 (Standard Version) BF1348-SP (Sensor Port Version)

BF1353-SPS



Fuel/Water Separator Spin-on with Drain, Sensor Port and Sensor
Contains: Integral Post Seal
Sensor Port Thread: M14 x 2.0
Fits: John Deere Engines, Equipment, Trucks
Replaces: John Deere RE522372; Fleetguard FS19688
Thread: 1 -12
O.D.: 4 1/4 (108.0)
Height: 11 11/16 (296.9)
I.Gskt: [1] Included

BF1348-SP



Fuel/Water Separator Spin-on with Drain and Sensor Port
Notes: May use OP8752 to plug Sensor Port.
Contains: Integral Post Seal
Sensor Port Thread: 1/2-20
Fits: Blue Bird Buses; Freightliner, Hino, Peterbilt Trucks; Racor 325 Series
Replaces: Racor S3225P
Thread: 1 -14
O.D.: 4 5/16 (109.5)
Height: 6 25/32 (172.2)
I.Gskt: [1] Included
F. Gskt: [1] Included
Related To: BF1348 (Drain Version) BF1348-O (Open Port Version)

BF1354-SPS



Primary Fuel/Water Separator Spin-on with Drain, Sensor Port and Reusable Sensor
Contains: Integral Post Seal
Sensor Port Thread: M14 x 2.0
Fits: John Deere Engines, Equipment, Trucks
Replaces: John Deere RE531703; Donaldson P550668; Fleetguard FS19701
Thread: 1 -14
O.D.: 4 1/4 (108.0)
Height: 11 11/16 (296.9)
I.Gskt: [1] Included

Measurements Are Shown In Inches And (Millimeters)

WARNING: These products can expose you to chemicals, including Diisononyl Phthalate, Carbon black extracts, Nickel, 1,3 Butadiene, Ethylene Oxide, Epichlorohydrin, which are known to the State of California to cause cancer, and Bisphenol, Ethylene Glycol, Ethylene Oxide, 1,3 Butadiene, Epichlorohydrin, which are known to the State of California to cause birth defects or other reproductive harm. For more information go to www.P65Warnings.ca.gov.

BF1355 Fuel/Water Separator Spin-on with Drain
Contains: Integral Post Seal
Fits: Thermo King Refrigeration Units; Volvo Trucks
Thread: 1 1/4 -12
O.D.: 4 11/16 (119.1)
Height: 8 29/32 (226.2)
I.Gskt: [1] Included
Related To: BF1355-SP (Sensor Port Version) BF1355-O (Open Port Version)



BF1358-O Fuel/Water Separator Spin-on with Open Port for Bowl
Contains: Integral Post Seal
 Port Thread: 3 3/4-10
Fits: Volvo Dump Trucks, Equipment
Replaces: Volvo 11110474, 11110668
Thread: 1 -14
O.D.: 4 13/32 (111.9)
Height: 8 19/32 (218.3)
I.Gskt: [1] Included
F. Gskt: [1] Included
Related To: BF1358-SP (Sensor Port Version)



BF1355-O Fuel/Water Separator Spin-on with Open Port for Bowl
Contains: Port Thread: M95 x 2.5
 Integral Post Seal
Fits: Volvo VN Series, VN730, VNL300, VNL430, VNL730 Trucks
Replaces: Racor S3238P; Thermo King 11-9982, Volvo 85104856
Thread: 1 1/4 -12
O.D.: 4 7/8 (123.8)
Height: 6 5/16 (160.3)
I.Gskt: [1] Included
F. Gskt: [1] Included
Grommets: [1] Included
Related To: BF1355 (Drain Version) BF1355-SP (Sensor Port Version)



BF1358-SP Fuel/Water Separator Spin-on with Drain and Sensor Port
Notes: CAUTION: Furnished O-Ring must be installed on post for seal.
Contains: Integral Post Seal
 Sensor Port Thread: 9/16-18
Fits: Volvo Dump Trucks, Equipment
Replaces: Volvo 11110474, 11110668
Thread: 1 -14
O.D.: 4 9/32 (108.7)
Height: 11 (279.4)
I.Gskt: [1] Included
O-Ring: [1] Included
Related To: BF1358-O (Open Port Version)



BF1355-SP Fuel/Water Separator Spin-on with Drain and Sensor Port
Notes: May use OP8752 to plug Sensor Port.
Contains: Integral Post Seal
 Sensor Port Thread: 1/2-20
Fits: Thermo King Refrigeration Units
 Volvo Trucks
Replaces: Racor S3238P; Thermo King 11-9982
Thread: 1 1/4 -12
O.D.: 4 11/16 (119.1)
Height: 8 7/8 (225.4)
I.Gskt: [1] Included
O-Ring: [1] Included
Related To: BF1355 (Drain Version) BF1355-O (Open Port Version)



BF1359-SP Fuel/Water Separator Spin-on with Drain and Sensor Port
Notes: CAUTION: Furnished O-Ring must be installed on post for seal.
Contains: Integral Post Seal
 Sensor Port Thread: 1/2-20
Fits: Volvo Dump Trucks, Loaders
Thread: 1 -14
O.D.: 4 1/4 (108.0)
Height: 11 1/8 (282.6)
I.Gskt: [1] Included
O-Ring: [1] Included
Related To: BF1391-O (Open Port Version)



BF1356 Fuel/Water Separator Spin-on with Drain
Fits: Cummins Engines
Replaces: Cummins 3991350; Fleetguard FS19608
Thread: M20 x 1.5
O.D.: 3 11/16 (93.7)
Height: 7 13/32 (188.1)
I.Gskt: G381-A
F. Gskt: [1] Included
End Seals: [1] Included



BF1360 Fuel/Water Separator Spin-on with Drain
Contains: Integral Post Seal
Fits: Hino Trucks
Replaces: Hino 23401-1700
Thread: 1 -14
O.D.: 4 9/32 (108.7)
Height: 8 7/32 (208.8)
I.Gskt: [1] Included
Related To: BF1360-O (Open Port Version) BF1360-SP (Sensor Port Version)



BF1357 Fuel/Water Separator Spin-on with Drain
Contains: Integral Post Seal
Fits: Komatsu Equipment
Replaces: Komatsu 600-311-3410, 600-319-3400
Thread: 1 1/4 -12
O.D.: 4 11/16 (119.1)
Height: 12 3/32 (307.2)
I.Gskt: [1] Included
Related To: BF1288-O (Open Port Version)



BF1360-O Fuel/Water Separator Spin-on with Open Port for Bowl
Contains: Port Thread: 3 3/4-10 Buttruss
Fits: Blue Bird All-American, Vision Buses
Replaces: Racor R90S; Donaldson P551854; Fleetguard FS20028
Thread: 1 -14
O.D.: 4 9/32 (108.7)
Height: 5 21/32 (143.7)
F. Gskt: [2] Included
Related To: BF1360 (Standard Version) BF1360-SP (Sensor Port Version)



Measurements Are Shown In Inches And (Millimeters)

WARNING: These products can expose you to chemicals, including Diisononyl Phthalate, Carbon black extracts, Nickel, 1,3 Butadiene, Ethylene Oxide, Epichlorohydrin, which are known to the State of California to cause cancer, and Bisphenol, Ethylene Glycol, Ethylene Oxide, 1,3 Butadiene, Epichlorohydrin, which are known to the State of California to cause birth defects or other reproductive harm. For more information go to www.P65Warnings.ca.gov.

BF1360-SP

Fuel/Water Separator Spin-on with Drain and Sensor Port



Notes: CAUTION: Furnished O-Ring must be installed on post for seal.
May use OP8752 to plug Sensor Port.
Contains: Integral Post Seal
Sensor Port Thread: 1/2-20
Fits: Blue Bird Buses; Caterpillar, Cummins Engines
Replaces: Racor R90S
Thread: 1 -14
O.D.: 4 9/32 (108.7)
Height: 8 1/8 (206.4)
I.Gskt: [1] Included
O-Ring: [1] Included
Related To: BF1360 (Standard Version)
BF1360-O (Open Port Version)

BF1366-O

Fuel/Water Separator Spin-on with Open Port for Bowl



Contains: Port Thread: M80 x 2.5
Integral Post Seal
Fits: R.V.I. Trucks; Volvo Trucks
Replaces: Volvo 20998367; Donaldson P559628; Fleetguard FS19735
Thread: 1 -14
O.D.: 3 21/32 (92.9)
Height: 5 5/8 (142.9)
I.Gskt: [1] Included
O-Ring: [1] Included
Related To: BF1384-SP (Sensor Port Version)
BF1252 (Standard Version)

BF1361

Fuel Spin-on with Drain



Fits: Case-International Tractors
Replaces: Case 47128205;
New Holland 19305811
Thread: M14 x 1.5
O.D.: 3 11/16 (93.7)
Height: 4 11/16 (119.1)
I.Gskt: G381-A

BF1367

Fuel/Water Separator Spin-on with Drain



Fits: Iveco Engines
Replaces: Iveco 504048025; New Holland 87803192, 87803196; Fleetguard FS19597
Thread: M16 x 1.5
O.D.: 3 1/32 (77.0)
Height: 6 21/32 (169.1)
I.Gskt: G449-B

BF1362

Fuel Spin-on with Drain



Fits: Freightliner, Sterling Trucks
Replaces: Alliance ABP/N122-R50404;
Fleetguard FS19807; Racor R50404
Thread: 1 -14
O.D.: 4 1/4 (108.0)
Height: 6 13/16 (173.0)
I.Gskt: [1] Included

OB1368

Full-Flow Lube Filter Base for Cummins Engines



Notes: Converts P999-HD from element to spin-on.
Contains: Threaded Stud: 1 1/2-12
[1] Instruction Sheet
Fits: 1968 and Earlier Cummins Engines
Use With: B96, B196, B205
O.D.: 6 5/8 (168.3)
Height: 4 1/4 (108.0)
F. Gskt: [3] Included, [2] Washers, [1] Capscrew

BF1363

Fuel Spin-on with Drain



Fits: Doppstadt AK430 Shredder with Mercedes-Benz OM501LA Engine
Replaces: Mercedes-Benz A0004771302, 4771302
Thread: 1 -14
O.D.: 4 1/4 (108.0)
Height: 11 7/32 (285.0)
I.Gskt: [1] Included

OB1369

Full-Flow Lube Filter Base for Cummins Engines



Notes: Converts P999-HD from element to spin-on.
Contains: Threaded Stud: 1 1/2-12
Fits: 1969-on Cummins Engines
Use With: B96, B196, B205
O.D.: 6 5/8 (168.3)
Height: 3 5/16 (84.1)
F. Gskt: [2] Included, [2] Washers

BF1365

Fuel/Water Separator Spin-on with Drain



Fits: Iveco Trucks
Replaces: Iveco 2992662;
Mann & Hummel WK950/19
Thread: M16 x 1.5
O.D.: 3 11/16 (93.7)
Height: 7 13/32 (188.1)
I.Gskt: G381-A

BF1370

Fuel/Water Separator Spin-on with Drain



Contains: Integral Post Seal
Fits: New Holland Equipment
Replaces: New Holland 8446332
Thread: 1 -14
O.D.: 4 5/16 (109.5)
Height: 6 25/32 (172.2)
I.Gskt: [1] Included

Measurements Are Shown In Inches And (Millimeters)



WARNING: These products can expose you to chemicals, including Diisononyl Phthalate, Carbon black extracts, Nickel, 1,3 Butadiene, Ethylene Oxide, Epichlorohydrin, which are known to the State of California to cause cancer, and Bisphenol, Ethylene Glycol, Ethylene Oxide, 1,3 Butadiene, Epichlorohydrin, which are known to the State of California to cause birth defects or other reproductive harm. For more information go to www.P65Warnings.ca.gov.

BF1371 Fuel/Water Separator Spin-on with Drain and Sensor Port
Notes: CAUTION: Furnished O-Ring must be installed on post for seal.
 Remove rubber paint plug before installation.
Contains: Sensor Port Thread: M10 x 1.5
Fits: Case Loaders, Tractors
Replaces: Case 87803182; Cummins 2830359; Fleetguard FS19772
Thread: M16 x 1.5
O.D.: 3 11/16 (93.7)
Height: 7 31/32 (202.4)
I.Gskt: G401
O-Ring: [1] Included



BF1376 Fuel Spin-on with Drain
Fits: Freightliner, Sterling Trucks with Caterpillar Engines
Replaces: Alliance ABP/N12232FRT02
Thread: 1 -14
O.D.: 3 11/16 (93.7)
Height: 7 13/32 (188.1)
I.Gskt: G381-A
O-Ring: [1] Included



BF1372 Fuel/Water Separator Spin-on with Drain
Contains: Integral Post Seal
Fits: Liebherr Equipment; M.A.N. Trucks
Replaces: Liebherr 7008775, 7382048; M.A.N 51.12503.0040; Donaldson P550498; Fleetguard FS19599
Thread: M16 x 1.5
O.D.: 3 1/32 (77.0)
Height: 5 29/32 (150.0)
I.Gskt: [1] Included



BF1377 Fuel/Water Separator Spin-on with Drain
Fits: Freightliner Coronado, CC132 with Detroit Diesel Series 60 Engine
Replaces: Alliance ABP/N122-R50416
Thread: 1 -14
O.D.: 4 1/4 (108.0)
Height: 9 31/32 (253.2)
I.Gskt: [1] Included



BF1373-SP Fuel/Water Separator Spin-on with Drain and Sensor Port
Contains: Integral Post Seal
 Sensor Port Thread: 1/2-20
Fits: Freightliner Trucks
Replaces: Alliance ABP/N122-R50419, ABP/N122-S3226FL01; Freightliner ABPS3226FL01
Thread: 1 -14
O.D.: 4 9/32 (108.7)
Height: 8 1/8 (206.4)
I.Gskt: [1] Included
O-Ring: [1] Included
Related To: BF46098-O (Open Port Version)



BF1378-SPS Fuel/Water Separator Spin-on with Sensor Port, Drain and Reusable Sensor
Notes: CAUTION: Furnished D-Ring must be installed on post for seal.
 May use OP8753 to plug Sensor Port.
Contains: Sensor Port Thread: M14 x 2.0
Fits: Cummins, Paccar Engines; Freightliner, Kenworth, Peterbilt Trucks
Replaces: Cummins 4934879; Fleetguard FS1065
Thread: 1 -14
O.D.: 3 23/32 (94.5)
Height: 10 1/32 (254.8)
I.Gskt: G381-A
O-Ring: ES24-D



BF1374-SP Fuel/Water Separator Spin-on with Drain and Sensor Port
Contains: Sensor Port Thread: 9/16-18
Fits: Caterpillar Excavators, Material Handlers
Replaces: Caterpillar 1R0781
Thread: 1 -14
O.D.: 4 1/4 (108.0)
Height: 9 7/32 (234.2)
I.Gskt: [1] Included
O-Ring: [1] Included



BF1379 Fuel/Water Separator Spin-on with Drain and Sensor Port
Notes: Inside-Out Flow Direction
Contains: Integral Post Seal
 Sensor Port Thread: 1/2-20
Fits: Next Generations UCM1 Generators; Truck Gen Hybrid, UCRV 1-3.5, UCT 1-3.5 Auxilliary Power Units
Replaces: Racor R12S; Fleetguard FS19628
Thread: M18 x 1.5
O.D.: 3 1/32 (77.0)
Height: 4 19/32 (116.7)
I.Gskt: [1] Included



BF1375 Fuel Spin-on with Drain
Contains: Integral Post Seal
Fits: Freightliner Coronado, CC132, FLD Trucks with Detroit Diesel Series 60 Engine
Replaces: Alliance ABP/N122-R50422
Thread: 1 -14
O.D.: 4 9/32 (108.7)
Height: 9 31/32 (253.2)
I.Gskt: [1] Included



BF1380 Fuel/Water Separator Spin-on with Drain and Sensor Port
Notes: Inside-Out Flow Direction
Contains: Integral Post Seal
 Sensor Port Thread: 1/2-20
Fits: Ampac P33/24 Compactor; Powerpac APUC, APUK, Power Tech Auxilliary Power Units; Toro Reelmaster Mowers
Replaces: Racor R12T; Fleetguard FS19802
Thread: M18 x 1.5
O.D.: 3 1/32 (77.0)
Height: 4 19/32 (116.7)
I.Gskt: [1] Included
Related To: BF1381-O (Open Port Version)
 BF1381 (Drain Version)



Measurements Are Shown In Inches And (Millimeters)

WARNING: These products can expose you to chemicals, including Diisononyl Phthalate, Carbon black extracts, Nickel, 1,3 Butadiene, Ethylene Oxide, Epichlorohydrin, which are known to the State of California to cause cancer, and Bisphenol, Ethylene Glycol, Ethylene Oxide, 1,3 Butadiene, Epichlorohydrin, which are known to the State of California to cause birth defects or other reproductive harm. For more information go to www.P65Warnings.ca.gov.

BF1381

Fuel/Water Separator Spin-on with Drain and Sensor Port



Notes: Inside-Out Flow Direction
Contains: Integral Post Seal
 Sensor Port Thread: 1/2-20
Fits: Genie S100, S105, S120, S125 Lifts;
 Volvo VHD430 Trucks
Replaces: Racor R12P; Donaldson P551768;
 Fleetguard FS19627
Thread: M18 x 1.5
O.D.: 3 1/32 (77.0)
Height: 4 19/32 (116.7)
I.Gskt: [1] Included
Related To: BF1381-O (Open Port Version)
 BF1380 (Sensor Port Version)

BF1381-O

Fuel/Water Separator Spin-on with Open Port for Bowl



Notes: Port Thread: 2 3/8
Fits: Genie S100, S105, S120, S125 Lifts;
 Volvo VHD430 Trucks
Replaces: Racor R12P; Donaldson P551768;
 Fleetguard FS19627
Thread: M18 x 1.5
O.D.: 3 3/32 (78.6)
Height: 2 15/32 (62.7)
F. Gskt: [1] Included
O-Ring: [1] Included
Related To: BF1381 (Drain Version)
 BF1380 (Sensor Port Version)

BF1382-SP

Fuel/Water Separator Spin-on with Drain and Sensor Port



Contains: Sensor Port Thread: 9/16-18
Fits: Challenger Tractors
Replaces: Caterpillar 1R0771
Thread: 1 -14
O.D.: 4 1/4 (108.0)
Height: 9 3/8 (238.1)
I.Gskt: [1] Included
O-Ring: [1] Included

BF1383-O

Fuel/Water Separator Spin-on with Open Port for Bowl



Contains: Port Thread: B80 x 3 8A Metric
 Buttress
Fits: DAF Engines, Trucks; Doosan, Terex
 Equipment
Replaces: M.A.N. 51.12501.7288,
 51.12503.0052; Daewoo K1006529;
 CLARCOR Filtration (China) WBF219
Thread: 1 -14
O.D.: 4 9/32 (108.7)
Height: 9 3/32 (231.0)
I.Gskt: [1] Included
O-Ring: [1] Included

BF1384-SP

Fuel/Water Separator Spin-on with Drain and Sensor Port



Notes: CAUTION: Furnished D-Ring must be
 installed on post for seal.
Contains: Sensor Port Thread: 1/2-20
Fits: Mack Trucks with MP7, MP8 Engines
Replaces: Mack 20539578
Thread: 1 -14
O.D.: 3 11/16 (93.7)
Height: 7 13/16 (198.4)
I.Gskt: [1] Included
F. Gskt: [1] Included
O-Ring: [1] Included
Related To: BF1366-O (Open Port Version)
 BF1252 (Standard Version)

BF1385-SPS

Fuel/Water Separator Spin-on with Drain,
 Sensor Port and Reusable Sensor



Contains: Sensor Port Thread: M14 x 2.0
Fits: Case Equipment; Cummins Engines
Replaces: Case 87356193; Cummins 3973233;
 Fleetguard FS19732; SF-Filter SK3183
Thread: 1 -14
O.D.: 3 11/16 (93.7)
Height: 7 3/8 (187.3)
I.Gskt: G381-A
F. Gskt: ES24-D

BF1386-O

Fuel/Water Separator Spin-on with Open Port
 for Bowl



Contains: Port Thread: M80 x 2.5
 Integral Post Seal
Fits: Mack, Volvo Engines, Trucks
Replaces: Mack 21017305; Volvo 20879806
Thread: 1 -14
O.D.: 4 1/4 (108.0)
Height: 5 3/16 (131.8)
I.Gskt: [1] Included
O-Ring: [1] Included

BF1387-O

Fuel/Water Separator Spin-on with Open Port
 for Bowl



Contains: Port Thread: M80 x 2.5
 Integral Post Seal
Fits: Volvo Engines, Trucks
Replaces: Volvo 20879812
Thread: 1 -14
O.D.: 4 1/4 (108.0)
Height: 6 5/16 (160.3)
I.Gskt: [1] Included
O-Ring: [1] Included

BF1388-O

Fuel/Water Separator Spin-on with Open Port
 for Bowl



Contains: Port Thread: M95 x 2.5
 Integral Post Seal
Fits: R.V.I., Volvo Trucks
Replaces: R.V.I., 7420851191; Volvo 20853583;
 Racor R60P-D-MAX; Fleetguard FS19895
Thread: 1 -14
O.D.: 4 1/4 (108.0)
Height: 5 1/8 (130.2)
I.Gskt: [1] Included
F. Gskt: [1] Included
O-Ring: [1] Included

BF1389-O

Fuel/Water Separator Spin-on with Open Port
 for Bowl



Contains: Port Thread: 3 3/4-10 2B Buttress
 Integral Post Seal
Fits: Volvo Engines, Trucks
Replaces: Volvo 20381204; Racor R45T;
 Donaldson P550746; Fleetguard FS19734
Thread: 1 -14
O.D.: 4 1/4 (108.0)
Height: 3 17/32 (89.7)
I.Gskt: [1] Included
F. Gskt: [1] Included

Measurements Are Shown In Inches And (Millimeters)

WARNING: These products can expose you to chemicals, including Diisononyl Phthalate, Carbon black extracts, Nickel, 1,3 Butadiene, Ethylene Oxide, Epichlorohydrin, which are known to the State of California to cause cancer, and Bisphenol, Ethylene Glycol, Ethylene Oxide, 1,3 Butadiene, Epichlorohydrin, which are known to the State of California to cause birth defects or other reproductive harm. For more information go to www.P65Warnings.ca.gov.

BF1390-O Fuel/Water Separator Spin-on with Open Port for Bowl



Contains: Port Thread: 3 3/4-10 2B Buttress Integral Post Seal
Fits: Volvo Trucks
Replaces: Racor R90T; Volvo 20450423; Fleetguard FS19551
Thread: 1 -14
O.D.: 4 11/32 (110.3)
Height: 6 3/16 (157.2)
I.Gskt: [1] Included
F. Gskt: [1] Included

BF1394-SP Fuel/Water Separator Spin-on with Drain and Sensor Port



Contains: Sensor Port Thread: M14 x 2.0
Fits: Komatsu Equipment
Replaces: Komatsu 600-311-3610, 600-311-3620, 600-319-3610, 600-319-3620
Thread: 1 -14
O.D.: 3 11/16 (93.7)
Height: 8 7/8 (225.4)
I.Gskt: G401

BF1391-O Fuel/Water Separator Spin-on with Open Port for Bowl



Contains: Port Thread: M95 x 2.5 Integral Post Seal
Fits: Mercedes-Benz Engines, Trucks
Replaces: Mercedes-Benz 4771302, A0004771302; Fleetguard FS19914
Thread: 1 -14
O.D.: 4 1/4 (108.0)
Height: 8 21/32 (219.9)
I.Gskt: [1] Included
F. Gskt: [1] Included
Related To: BF1359-SP (Sensor Port Version)

BF1395-O Fuel/Water Separator Spin-on with Open Port for Bowl



Contains: Port Thread: M95 x 2.5 Integral Post Seal
Fits: Freightliner Cascadia with Detroit Diesel Series 60 Engine
Replaces: Alliance ABPN122R50421; Racor R120T; Donaldson P551075
Thread: 1 -14
O.D.: 4 13/32 (111.9)
Height: 8 19/32 (218.3)
I.Gskt: [2] Included
F. Gskt: [1] Included
Related To: BF1395-SP (Sensor Port Version) BF1265 (Drain Version)

BF1392-SPS KIT Fuel/Water Separator Element with Drain, Sensor Port and Reusable Sensor



Notes: Replacement Element is PF1392.
Fits: Dodge Light-Duty Trucks, Sterling Bullet all with 6-408 (6.7L) Turbo Diesel Engine
Replaces: Chrysler 5183410AA; Mopar 4936025
O.D.: 4 15/32 (113.5)
I.D.: 3/4 (19.1) One End
Height: 9 3/16 (233.4)
O-Ring: [1] Included
Grommets: [1] Attached

BF1395-SP Fuel/Water Separator Spin-on with Drain and Sensor Port



Notes: CAUTION: Furnished O-Ring must be installed on post for seal.
Contains: Integral Post Seal Sensor Port Thread: 1/2-20
Fits: Freightliner Trucks
Replaces: Alliance ABP/N122R50421; Freightliner RD591300
Thread: 1 -14
O.D.: 4 9/32 (108.7)
Height: 11 7/32 (285.0)
I.Gskt: G579
O-Ring: [1] Included
Related To: BF1395-O (Open Port Version)

PF1392 Fuel Element



Fits Inside: BF1392-SPS KIT
Fits: Dodge Light-Duty Trucks, Sterling Bullet all with 6-408 (6.7L) Turbo Diesel Engine
Replaces: Chrysler 68061634AA; Cummins 5257768
O.D.: 3 27/32 (97.6)
I.D.: 1 3/16 (30.2) One End
Height: 5 29/32 (150.0)
O-Ring: [1] Included
Grommets: [1] Attached

BF1396 Fuel/Water Separator Spin-on with Drain



Fits: M.A.N. Engines
Replaces: M.A.N. 51.12503.0059, 51.12503.0060
Thread: M16 x 1.5
O.D.: 3 1/32 (77.0)
Height: 5 29/32 (150.0)
I.Gskt: [1] Included

BF1393-SP High Efficiency Fuel/Water Separator Spin-on with Drain and Sensor Port



Notes: CAUTION: Furnished O-Ring must be installed on post for seal. Can be used with FB1311 base.
Contains: Integral Post Seal Sensor Port Thread: 1/2-20
Replaces: Fleetguard FS1015
Thread: 1 -14
O.D.: 3 11/16 (93.7)
Height: 8 13/16 (223.8)
I.Gskt: G381-A
O-Ring: [2] Included
Related To: BF1249, BF1249-SP (Standard Versions)

BF1397-SP Fuel/Water Separator Spin-on with Drain and Sensor Port



Notes: CAUTION: Furnished O-Ring must be installed on post for seal.
Contains: Sensor Port Thread: 9/16-18 Standpipe
Fits: Caterpillar Equipment
Replaces: Caterpillar 326-1643
Thread: 1 -14
O.D.: 4 1/4 (108.0)
Height: 9 11/32 (237.3)
I.Gskt: [1] Included
O-Ring: [2] Included

Measurements Are Shown In Inches And (Millimeters)

WARNING: These products can expose you to chemicals, including Diisononyl Phthalate, Carbon black extracts, Nickel, 1,3 Butadiene, Ethylene Oxide, Epichlorohydrin, which are known to the State of California to cause cancer, and Bisphenol, Ethylene Glycol, Ethylene Oxide, 1,3 Butadiene, Epichlorohydrin, which are known to the State of California to cause birth defects or other reproductive harm. For more information go to www.P65Warnings.ca.gov.

BF1398-O

Fuel/Water Separator Spin-on with Open Port for Bowl



Notes: Inside-Out Flow Direction
Contains: Port Thread: M80 x 2.5
 Integral Post Seal
Fits: Volvo Trucks with D6B Engine
Replaces: Volvo 20386080; Racor R25P;
 Fleetguard FS19704
Thread: 1 -14
O.D.: 3 21/32 (92.9)
Height: 5 5/8 (142.9)
I.Gskt: [1] Included
O-Ring: [1] Included

BF1399-SP

Fuel/Water Separator Spin-on with Drain and Sensor Port



Notes: CAUTION: Furnished O-Ring must be installed on post for seal.
Contains: Sensor Port Thread: 9/16-18
 Standpipe
Fits: Caterpillar Equipment
Replaces: Caterpillar 326-1644
Thread: 1 -14
O.D.: 4 1/4 (108.0)
Height: 7 5/8 (193.7)
I.Gskt: [1] Included
O-Ring: [2] Included

B1400

Lube Spin-on



Contains: Anti-Drainback Valve
 14 PSID By-Pass Valve
Fits: Ford, Kia, Honda, Mazda, Nissan,
 Subaru Automotive, Light-Duty Trucks;
 Kawasaki Motorcycles
Replaces: Mazda B6Y1-14-302, FEY0-14-302
Thread: M20 x 1.5
O.D.: 2 21/32 (67.5)
Height: 2 5/8 (66.7)
I.Gskt: [1] Included
Related To: B1402, B1431 (Long Versions)

B1402

Lube Spin-on



Contains: Anti-Drainback Valve
 14 PSID By-Pass Valve
Fits: Dodge, Eagle, Ford, Honda, Infiniti,
 Mazda, Mitsubishi, Nissan, Plymouth
 Automotive
Replaces: Chrysler MD135737; Ford
 F32Z-6731-A; Mazda JEYO-14-302;
 Nissan 15208-31U00
Thread: M20 x 1.5
O.D.: 2 9/16 (65.1)
Height: 3 1/2 (88.9)
I.Gskt: [1] Included
Related To: B1400 (Short Version)
 B1431 (Long Version)

BD1403

Dual-Flow Lube Spin-on



Contains: Integral Post Seal
Fits: Caterpillar Excavators, Lift Trucks;
 Mitsubishi Engines, Excavators, Trucks; Nissan
 Trucks
Replaces: Mitsubishi ME074013, ME074235
Thread: M36 x 1.5
O.D.: 5 1/8 (130.2)
Height: 8 21/32 (219.9)
I.Gskt: [1] Included

B1405

Lube Spin-on



Contains: Anti-Drainback Valve
 20 PSID By-Pass Valve
Fits: Toyota Automotive
Replaces: Toyota 90915-20002
Thread: 3/4 -16
O.D.: 3 1/32 (77.0)
Height: 3 1/2 (88.9)
I.Gskt: G449-B

B1406

Lube Spin-on



Contains: Anti-Drainback Valve
Fits: Infiniti, Nissan Automotive
Replaces: Nissan 15208-53J00
Thread: 3/4 -16
O.D.: 2 11/16 (68.3)
Height: 3 1/2 (88.9)
I.Gskt: [1] Included

B1407

Lube Spin-on



Contains: Anti-Drainback Valve
Fits: Ford, Gehl, Snorkel Equipment
Replaces: Ford 77BM-6714-C1A;
 Toyota 90915-YZZB5
Thread: 3/4 -16
O.D.: 3 1/32 (77.0)
Height: 3 1/2 (88.9)
I.Gskt: G449-B

B1410

Lube Spin-on



Contains: Anti-Drainback Valve
 8 PSID By-Pass Valve
Fits: Cub Cadet, Ford, Grasshopper, John
 Deere Lawn Tractors with Kohler Engines
Replaces: Kohler 1205001
Thread: 3/4 -16
O.D.: 3 (76.2)
Height: 2 7/8 (73.0)
I.Gskt: G449-B

B1413

Lube Spin-on



Contains: 8 PSID By-Pass Valve
Fits: Harley-Davidson Motorcycles;
 Mazda Automotive
Replaces: Harley-Davidson 63805-80A
Thread: 3/4 -16
O.D.: 3 (76.2)
Height: 3 1/2 (88.9)
I.Gskt: G449-B

B1416

Lube Spin-on



Contains: Anti-Drainback Valve
 14 PSID By-Pass Valve
 Front End Check Valve
Fits: Ford, Mazda Automotive
Replaces: Ford F8CA-6731-AA
Thread: 3/4 -16
O.D.: 2 29/32 (73.8)
Height: 4 27/32 (123.0)
I.Gskt: [1] Included

P1418

Lube Element with Bail Handle



Fits: Mercedes-Benz Automotive
Replaces: Mercedes-Benz 11849125,
 1191800009
O.D.: 2 25/32 (70.6)
I.D.: 3/8 (9.5) & 27/32 (21.4)
Height: 6 1/32 (153.2)
F. Gskt: [3] Included
Grommets: [2] Attached

Measurements Are Shown In Inches And (Millimeters)

WARNING: These products can expose you to chemicals, including Diisononyl Phthalate, Carbon black extracts, Nickel, 1,3 Butadiene, Ethylene Oxide, Epichlorohydrin, which are known to the State of California to cause cancer, and Bisphenol, Ethylene Glycol, Ethylene Oxide, 1,3 Butadiene, Epichlorohydrin, which are known to the State of California to cause birth defects or other reproductive harm. For more information go to www.P65Warnings.ca.gov.

P1419

Lube Element



Fits: Mercedes-Benz Automotive
Replaces: Mercedes-Benz 1041800109, 1041840225, 1041840325, 1041840425
O.D.: 2 7/16 (61.9)
I.D.: 27/32 (21.4) One End
Height: 6 9/32 (159.5)
A. Gskt: [1] Attached
O-Ring: [1] Included

B1430

Lube Spin-on



Contains: Anti-Drainback Valve
 20 PSID By-Pass Valve
Fits: Geo Tracker
Replaces: GMC 2501441
Thread: 3/4 -16
O.D.: 3 (76.2)
Height: 4 1/16 (103.2)
I.Gskt: [1] Included

B1421

Lube Spin-on



Contains: Anti-Drainback Valve
 14 PSID By-Pass Valve
Fits: Acura, Honda Automotive
Replaces: Honda 15400-P0H-305, 15400-PR3-406
Thread: M20 x 1.5
O.D.: 3 1/32 (77.0)
Height: 3 7/16 (87.3)
I.Gskt: [1] Included

B1431

Lube Spin-on



Contains: Anti-Drainback Valve
 14 PSID By-Pass Valve
Fits: Mitsubishi Automotive
Replaces: Mitsubishi AW343979, MD352627
Thread: M20 x 1.5
O.D.: 2 21/32 (67.5)
Height: 4 (101.6)
I.Gskt: [1] Included
Related To: B1400, B1402 (Short Versions)

B1422

Lube Spin-on



Contains: Anti-Drainback Valve
 20 PSID By-Pass Valve
Fits: Acura Automotive
Replaces: Honda 15400-PL2-004, 15400-PL2-005, 15400-PL2-305
Thread: M22 x 1.5
O.D.: 3 1/32 (77.0)
Height: 3 1/2 (88.9)
I.Gskt: G449-B

B1432

Lube Spin-on



Contains: Anti-Drainback Valve
Fits: Chevrolet, GMC Light-Duty Trucks
Replaces: GMC 25014748
Thread: 13/16 -16
O.D.: 3 (76.2)
Height: 4 3/32 (104.0)
I.Gskt: G449-B

B1425

Lube Spin-on



Contains: Anti-Drainback Valve
 20 PSID By-Pass Valve
Fits: Acura, Honda, Isuzu Automotive, Light-Duty Trucks
Replaces: Isuzu 8-94456-741-1, 8-97140-666-0
Thread: M20 x 1.5
O.D.: 3 1/32 (77.0)
Height: 3 7/16 (87.3)
I.Gskt: [1] Included

P1433

Lube Element



Fits: Cadillac, Oldsmobile Automotive
Replaces: GMC 25177917
O.D.: 2 1/8 (54.0)
I.D.: 23/32 (18.3)
Height: 3 13/16 (96.8)
O-Ring: [1] Included
Grommets: [2] Attached

B1428

Lube Spin-on



Contains: Anti-Drainback Valve
Fits: Chevrolet, GM Automotive, Light-Duty Trucks
Replaces: GMC 25160561
Thread: 13/16 -16
O.D.: 3 11/16 (93.7)
Height: 5 11/32 (135.7)
I.Gskt: [1] Included
Related To: B6 (without Anti-Drainback Valve)

B1434

Lube Spin-on



Contains: Anti-Drainback Valve
 20 PSID By-Pass Valve
Fits: Volvo Automotive
Replaces: Volvo 35178573
Thread: 3/4 -16
O.D.: 3 11/16 (93.7)
Height: 3 1/4 (82.6)
I.Gskt: G381-A

B1429

Lube Spin-on



Contains: Anti-Drainback Valve
 30 PSID By-Pass Valve
Fits: Audi, Volkswagen Automotive
Replaces: Volkswagen 78115561J
Thread: 3/4 -16
O.D.: 3 11/16 (93.7)
Height: 4 7/16 (112.7)
I.Gskt: G401

B1435

Lube Spin-on



Contains: Anti-Drainback Valve
 20 PSID By-Pass Valve
Fits: Jaguar, Land Rover, Lincoln Automotive, Light-Duty Trucks
Replaces: Ford XW4Z-6731-BA
Thread: 1 -12
O.D.: 3 (76.2)
Height: 4 27/32 (123.0)
I.Gskt: G449-B

B1438







Lube Spin-on









Contains: Anti-Drainback Valve
Fits: Chevrolet, GMC Light-Duty Trucks with 7.4L, 8.1L Engines
Replaces: GMC 25324052
Thread: 13/16 -16
O.D.: 3 11/16 (93.7)
Height: 3 3/16 (81.0)
I.Gskt: [1] Included

Measurements Are Shown In Inches And (Millimeters)

WARNING: These products can expose you to chemicals, including Diisononyl Phthalate, Carbon black extracts, Nickel, 1,3 Butadiene, Ethylene Oxide, Epichlorohydrin, which are known to the State of California to cause cancer, and Bisphenol, Ethylene Glycol, Ethylene Oxide, 1,3 Butadiene, Epichlorohydrin, which are known to the State of California to cause birth defects or other reproductive harm. For more information go to www.P65Warnings.ca.gov.

<p>P1440</p> 	<p>Lube Element Fits: Cadillac, Saturn Automotive Replaces: GMC 90536362; Saturn 21018826 O.D.: 2 7/16 (61.9) I.D.: 1 7/32 (31.0) One End Height: 3 3/32 (78.6) A. Gskt: [1] Attached O-Ring: [1] Included</p>
<p>B1441</p> 	<p>Lube Spin-on Contains: Anti-Drainback Valve 15 PSID By-Pass Valve Fits: Chevrolet, GMC Light-Duty Trucks Replaces: GMC 97214983; Isuzu 8-97214-983-1 Thread: 13/16 -16 O.D.: 3 11/16 (93.7) Height: 5 5/16 (134.9) I.Gskt: [1] Included</p>
<p>P1443</p> 	<p>Lube Element Fits: Dodge, Freightliner Sprinter Vans; Mercedes-Benz Automotive, Light-Duty Trucks, Vans Replaces: Chrysler 5086301AA; Mann & Hummel HU7181, HU7181X, HU7184; Mercedes-Benz 1121800009, 1121840025, A1121840225 O.D.: 2 17/32 (64.3) I.D.: 1 1/4 (31.8) Height: 4 9/16 (115.9) O-Ring: [6] Included</p>
<p>B1444</p> 	<p>Lube Spin-on Contains: 8 PSID By-Pass Valve Fits: Subaru Outback, Outback Sport, Tribeca Replaces: Subaru SOA51-65109 Thread: M20 x 1.5 O.D.: 3 (76.2) Height: 2 27/32 (72.2) I.Gskt: [1] Included</p>
<p>B1446</p> 	<p>Lube Spin-on Contains: 20 PSID By-Pass Valve Fits: Chevrolet, Isuzu Light-Duty Trucks; Hitachi, Kobelco Equipment Replaces: Isuzu 8-97049-708-1, X132010140 Thread: M20 x 1.5 O.D.: 3 23/32 (94.5) Height: 3 27/32 (97.6) I.Gskt: [1] Included O-Ring: [3] Included</p>
<p>B1447</p> 	<p>Lube Spin-on Contains: 14 PSID By-Pass Valve Fits: Land Rover Freelander Replaces: Land Rover AHU2880, CDU1268, LPW100230 Thread: 13/16 -16 O.D.: 3 1/32 (77.0) Height: 4 1/8 (104.8) I.Gskt: G449-B</p>
<p>P1510</p> 	<p>Lube Element Fits: E.M.D. Cageless Series Replaces: E.M.D. 8345482 O.D.: 6 1/2 (165.1) I.D.: 1 15/32 (37.3) One End Height: 29 3/8 (746.1) End Seals: [1] Included</p>

<p>P1511</p> 	<p>Lube Element Fits: Industrial Engines Replaces: Alco 16011911 O.D.: 6 13/32 (162.7) I.D.: 1 15/32 (37.3) One End Height: 33 7/8 (860.4) F. Gskt: [1] Included Spring: [1] Attached</p>
<p>V1520-R</p> 	<p>Vac-Cel Lube Sock with Bail Pull Fits: Nugent Filter Housings Replaces: Alco 1601198 O.D.: 6 3/16 (157.2) I.D.: 1 23/32 (43.7) Height: 30 1/2 (774.7) I.Gskt: [2] Included</p>
<p>V1542-C</p> 	<p>Vac-Cel Full-Flow Lube Sock Fits: Winslow Filter Housings Replaces: Winslow 1542 Series O.D.: 3 3/4 (95.3) Height: 15 1/2 (393.7)</p>
<p>V1544-T</p> 	<p>Sisal Sock for Filtering Liquids at High Flow Rates Fits: Hyco, Winslow Filter Housings Replaces: Winslow 1544 Series O.D.: 3 3/4 (95.3) I.D.: 1 1/16 (27.0) Height: 15 (381.0)</p>
<p>V1560</p> 	<p>Crankcase Emission Absorber Fits: Various Oil Field Equipment Replaces: Nelson 88465A O.D.: 6 1/2 (165.1) I.D.: 3 3/4 (95.3) Height: 32 (812.8)</p>
<p>P1561</p> 	<p>Lube Element Replaces: Vokes 6360109, C6360229, C6370812 O.D.: 6 5/8 (168.3) I.D.: 3 13/32 (86.5) Height: 17 3/32 (434.2) O-Ring: [2] Attached</p>
<p>P1562</p> 	<p>Lube Element Replaces: Vokes C6360112, C6360232, C6370012 O.D.: 8 13/16 (223.8) I.D.: 4 1/16 (103.2) Height: 18 7/32 (462.8) O-Ring: [2] Attached</p>

Measurements Are Shown In Inches And (Millimeters)

! WARNING: These products can expose you to chemicals, including Diisononyl Phthalate, Carbon black extracts, Nickel, 1,3 Butadiene, Ethylene Oxide, Epichlorohydrin, which are known to the State of California to cause cancer, and Bisphenol, Ethylene Glycol, Ethylene Oxide, 1,3 Butadiene, Epichlorohydrin, which are known to the State of California to cause birth defects or other reproductive harm. For more information go to www.P65Warnings.ca.gov.

P1563

Lube Element



Replaces: Vokes B6352910
O.D.: 5 29/32 (150.0)
I.D.: 2 13/16 (71.4)
Height: 6 7/8 (174.6)
A. Gskt: [2] Attached

P1576

Lube Element



Notes: Inside-Out Flow Direction
Replaces: Vokes D6359325
O.D.: 3 11/16 (93.7)
I.D.: 5/8 (15.9) & 1 23/32 (43.7)
Height: 18 1/16 (458.8)
A. Gskt: [1] Attached

P1565

Lube Element



Notes: Inside-Out Flow Direction
Replaces: Vokes B62966
O.D.: 2 13/16 (71.4)
I.D.: 13/32 (10.3) & 1 5/16 (33.3)
Height: 6 5/32 (156.4)
A. Gskt: [1] Attached

P1577

Lube Element



Notes: Inside-Out Flow Direction
Replaces: Vokes B62982
O.D.: 3 21/32 (92.9)
I.D.: 21/32 (16.7) & 1 23/32 (43.7)
Height: 8 31/32 (227.8)
A. Gskt: [1] Attached

P1566

Lube Element



Notes: Inside-Out Flow Direction
Replaces: Vokes B60942
O.D.: 2 27/32 (72.2)
I.D.: 13/32 (10.3) & 1 11/32 (34.1)
Height: 3 29/32 (99.2)
A. Gskt: [1] Attached

P1578

Lube Element



Replaces: Vokes 6360106, C6360226, C6370051
O.D.: 4 9/32 (108.7)
I.D.: 2 3/32 (53.2)
Height: 14 7/16 (366.7)
A. Gskt: [2] Attached

P1567

Lube Element



Replaces: Vokes C6323149, C6370462
O.D.: 6 (152.4)
I.D.: 2 25/32 (70.6)
Height: 12 1/4 (311.2)
A. Gskt: [2] Attached

PF1584

Fuel Element



Replaces: Vokes C6360352
O.D.: 8 25/32 (223.0)
I.D.: 4 3/32 (104.0)
Height: 18 5/32 (461.2)
O-Ring: [2] Attached

P1568

Lube Element



Replaces: Vokes 6360110, C6360230, C6370064
O.D.: 8 13/16 (223.8)
I.D.: 4 1/16 (103.2)
Height: 13 7/32 (335.8)
O-Ring: [2] Attached

PF1585

Fuel Element



Replaces: Vokes B6436169
O.D.: 3 21/32 (92.9)
I.D.: 21/32 (16.7) & 2 5/32 (54.8)
Height: 8 31/32 (227.8)
A. Gskt: [1] Attached

P1575

Lube Element



Notes: Inside-Out Flow Direction
Replaces: Vokes B63331
O.D.: 3 21/32 (92.9)
I.D.: 5/8 (15.9) & 1 23/32 (43.7)
Height: 3 29/32 (99.2)
A. Gskt: [1] Attached

PF1587

Fuel Element



Replaces: Vokes B6436168
O.D.: 3 21/32 (92.9)
I.D.: 5/8 (15.9) & 1 23/32 (43.7)
Height: 3 7/8 (98.4)
A. Gskt: [1] Attached

Measurements Are Shown In Inches And (Millimeters)

 **WARNING:** These products can expose you to chemicals, including Diisononyl Phthalate, Carbon black extracts, Nickel, 1,3 Butadiene, Ethylene Oxide, Epichlorohydrin, which are known to the State of California to cause cancer, and Bisphenol, Ethylene Glycol, Ethylene Oxide, 1,3 Butadiene, Epichlorohydrin, which are known to the State of California to cause birth defects or other reproductive harm. For more information go to www.P65Warnings.ca.gov.

PF1589 Fuel Element

Replaces: Vokes D6357734
O.D.: 3 21/32 (92.9)
I.D.: 2 1/32 (16.7) & 1 23/32 (43.7)
Height: 17 15/16 (455.6)
A. Gskt: [1] Attached

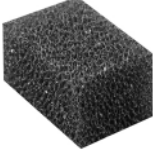
LL1608 Long Life Air Element

Notes: Inside-Out Flow Direction
Contains: Flame Retardant Media
Fits: Bray, Case, Galion, International Equipment
Replaces: Case L10327; International 124010-R1
O.D.: 6 5/8 (168.3)
I.D.: 4 1/4 (108.0) One End
Height: 9 (228.6)
Related To: PA1608 (Standard Media Version)

PA1600 Poly Foam Air Breather

Fits: GMC Buses, Trucks; Various Air Compressors
Replaces: Bendix 239262; Cummins 299365; GMC 9028042
Length: 2 1/2 (63.5)
Width: 1 3/4 (44.5)
Height: 1 3/8 (34.9)

PA1608 Air Element

Notes: Inside-Out Flow Direction
Contains: Flame Retardant Media
Fits: Bray, Case, Galion, International Equipment
Replaces: Case L10327; International 124010-R1
O.D.: 6 5/8 (168.3)
I.D.: 4 1/4 (108.0) One End
Height: 9 (228.6)
Related To: LL1608 (Long-Life Media Version)

PA1602 Air Element

Fits: Purolator AF100 Series Housings
Replaces: Deutz 3476295; GMC 1553686
O.D.: 6 5/8 (168.3)
I.D.: 4 1/4 (108.0)
Height: 7 7/8 (200.0)

PA1609 Outer Air Element with Lift Tabs

Fits: Allis Chalmers, Ford Equipment
Use With: PA2306
Replaces: Allis Chalmers 70630088; Ford C9NN-9601-A
O.D.: 6 (152.4)
I.D.: 3 5/8 (92.1) One End
Height: 14 3/16 (360.4)
A. Gskt: [1] Attached

PA1603 Air Breather Element

Fits: Chevrolet, GMC Trucks; Kohler Engines
Replaces: GMC 2325376; Kohler 24908
O.D.: 2 15/16 (74.6)
I.D.: 1 7/8 (47.6)
Height: 2 9/16 (65.1)

PA1610 Air Element with Lift Tabs

Fits: Drott, International Equipment
Replaces: Drott 76237; International 321595-R91
O.D.: 6 (152.4)
I.D.: 3 5/8 (92.1) One End
Height: 18 5/16 (465.1)
A. Gskt: [1] Attached

PA1606 Air Element

Contains: Flame Retardant Media
Replaces: GMC 6488318
O.D.: 10 7/32 (259.6)
I.D.: 7 7/8 (200.0)
Height: 7 1/2 (190.5)

PA1613 Air Element

Notes: Inside-Out Flow Direction
Fits: Allis Chalmers, International, Yale & Towne Equipment
Replaces: Allis Chalmers 630418; International D58575; White 866520
O.D.: 8 1/4 (209.6)
I.D.: 1/2 (12.7) & 5 3/4 (146.1)
Height: 9 (228.6)
F. Gskt: [1] Included

PA1607 Air Element

Replaces: GMC 6488322
O.D.: 10 7/32 (259.6)
I.D.: 7 7/8 (200.0)
Height: 11 15/32 (291.3)

PA1613-S Air Element

Notes: Inside-Out Flow Direction
Fits: Allis Chalmers, International, Yale & Towne Equipment
Replaces: International 968718-R91
O.D.: 8 1/4 (209.6)
I.D.: 5 3/4 (146.1) One End
Height: 9 (228.6)

Measurements Are Shown In Inches And (Millimeters)

 **WARNING:** These products can expose you to chemicals, including Diisononyl Phthalate, Carbon black extracts, Nickel, 1,3 Butadiene, Ethylene Oxide, Epichlorohydrin, which are known to the State of California to cause cancer, and Bisphenol, Ethylene Glycol, Ethylene Oxide, 1,3 Butadiene, Epichlorohydrin, which are known to the State of California to cause birth defects or other reproductive harm. For more information go to www.P65Warnings.ca.gov.

LL1614 Long Life Air Element
Notes: Inside-Out Flow Direction
Fits: Allis Chalmers, Caterpillar, Dynapac, Franklin, Galion, J.C. Bamford Equipment; Gardner Denver, Sullair Compressors
Replaces: Allis Chalmers 71132849; Continental SD802F546; Galion 79266
O.D.: 8 1/4 (209.6)
I.D.: 1/2 (12.7) & 5 3/4 (146.1)
Height: 11 (279.4)
F. Gskt: [1] Included
Related To: PA1614 (Standard Media Version)



PA1614 Air Element
Notes: Inside-Out Flow Direction
Fits: Allis Chalmers, Caterpillar, Dynapac, Franklin, Galion, J.C. Bamford Equipment; Gardner Denver, Sullair Compressors
Replaces: Allis Chalmers 71132849; Continental SD802F546; Galion 79266
O.D.: 8 1/4 (209.6)
I.D.: 1/2 (12.7) & 5 3/4 (146.1)
Height: 11 (279.4)
F. Gskt: [1] Included
Related To: LL1614 (Long-Life Media Version)



LL1615 Long Life Outer Air Element
Fits: Caterpillar Equipment
Use With: PA1647, PA2719, [PA2736]
Replaces: Caterpillar 4M8047, 8N5389
O.D.: 9 1/4 (235.0)
I.D.: 4 27/32 (123.0) One End
Height: 12 1/2 (317.5)
A. Gskt: [1] Attached
Related To: PA1615 (Standard Media Version) PA1615XP (Extreme Performance Nano Version)



PA1615 Outer Air Element
Fits: Caterpillar Equipment
Use With: PA1647, PA2719, PA2736
Replaces: Caterpillar 4M8047, 8N5389
O.D.: 9 1/4 (235.0)
I.D.: 4 27/32 (123.0) One End
Height: 12 1/2 (317.5)
A. Gskt: [1] Attached
Related To: LL1615 (Long-Life Media Version) PA1615XP (Extreme Performance Nano Version)



PA1615XP Extreme Performance Nano Outer Air Element
Fits: Caterpillar Equipment
Use With: PA1647, PA2719, PA2736
Replaces: Caterpillar 4M8047, 8N5389
O.D.: 9 1/4 (235.0)
I.D.: 4 27/32 (123.0) One End
Height: 12 1/2 (317.5)
A. Gskt: [1] Attached
Related To: LL1615 (Long-Life Media Version) PA1615 (Standard Media Version)



PA1618 Air Element
Fits: Hyster Lift Trucks; OBAC Optional Filter Housings
Replaces: GMC 6424682; OBAC HOB1004
O.D.: 10 7/32 (259.6)
I.D.: 5 1/2 (139.7)
Height: 4 (101.6)



PA1619 Air Element
Fits: Case Equipment; Ford Engines
Replaces: Case A15483
O.D.: 10 7/32 (259.6)
I.D.: 5 1/2 (139.7)
Height: 5 (127.0)
F. Gskt: [3] Included



PA1620 Air Element
Fits: Case Equipment
Replaces: Case A14956, A15903
O.D.: 10 7/32 (259.6)
I.D.: 5 1/2 (139.7)
Height: 8 3/16 (208.0)
A. Gskt: [2] Attached



PA1620-S Air Element
Fits: Caterpillar Engines
Replaces: Caterpillar 4L9851
O.D.: 10 7/32 (259.6)
I.D.: 6 1/16 (154.0) One End
Height: 7 27/32 (199.2)
A. Gskt: [1] Attached



LL1621-2 Long Life Air Element with 2-Inch Pleats
Notes: Inside-Out Flow Direction
Fits: Austin-Western, Aveling-Barford, Dresser, Euclid, Galion, Hancock, Hough, J.C. Bamford, Versatile, Washington Iron Works, Yale Equipment
Replaces: Versatile 6017725; Yale 512556805
O.D.: 10 7/32 (259.6)
I.D.: 1/2 (12.7) & 6 1/16 (154.0)
Height: 9 (228.6)
F. Gskt: [1] Included
Related To: PA1621-2 (Standard Media Version)



PA1621 Air Element
Notes: Inside-Out Flow Direction
Fits: Euclid, Hough, Versatile Equipment
Replaces: International 155209; White 882681
O.D.: 10 7/32 (259.6)
I.D.: 1/2 (12.7) & 7 7/8 (200.0)
Height: 9 (228.6)
F. Gskt: [1] Included



PA1621-2 Air Element with 2-Inch Pleats
Notes: Inside-Out Flow Direction
Fits: Austin-Western, Aveling-Barford, Dresser, Euclid, Galion, Hancock, Hough, J.C. Bamford, Versatile, Washington Iron Works, Yale Equipment
Replaces: Versatile 6017725; Yale 512556805
O.D.: 10 7/32 (259.6)
I.D.: 1/2 (12.7) & 6 1/16 (154.0)
Height: 9 (228.6)
F. Gskt: [1] Included
Related To: LL1621-2 (Long-Life Media Version)



Measurements Are Shown In Inches And (Millimeters)

WARNING: These products can expose you to chemicals, including Diisononyl Phthalate, Carbon black extracts, Nickel, 1,3 Butadiene, Ethylene Oxide, Epichlorohydrin, which are known to the State of California to cause cancer, and Bisphenol, Ethylene Glycol, Ethylene Oxide, 1,3 Butadiene, Epichlorohydrin, which are known to the State of California to cause birth defects or other reproductive harm. For more information go to www.P65Warnings.ca.gov.

PA1621-S

Air Element



Notes: Inside-Out Flow Direction
Fits: Euclid, Hough, Versatile Equipment
Replaces: GMC 25096131
O.D.: 10 7/32 (259.6)
I.D.: 7 7/8 (200.0) One End
Height: 9 (228.6)

PA1629-S

Air Element



Fits: Caterpillar Engines
Replaces: Caterpillar 4L9853
O.D.: 13 13/16 (350.8)
I.D.: 9 1/2 (241.3) One End
Height: 12 1/8 (308.0)
A. Gskt: [1] Attached

PA1625

Air Element



Fits: Caterpillar, Michigan Equipment
Replaces: Caterpillar 9M8373
O.D.: 11 21/32 (296.1)
I.D.: 6 1/8 (155.6) & 8 31/32 (227.8)
Height: 10 1/2 (266.7)
A. Gskt: [2] Attached
O. Gskt: [2] G37-AF

PA1630

Air Element



Notes: Inside-Out Flow Direction
Fits: Allis Chalmers, Euclid Equipment
Replaces: Allis Chalmers 43790692;
 Euclid 9175490
O.D.: 13 27/32 (351.6)
I.D.: 1/2 (12.7) & 11 1/8 (282.6)
Height: 14 (355.6)
F. Gskt: [1] Included
Related To: PA1706 (with Attached Gasket)

PA1626

Air Element



Notes: Inside-Out Flow Direction
Fits: Euclid, Hough Equipment
Replaces: Euclid 9228197;
 International 425970-R91
O.D.: 12 1/32 (305.6)
I.D.: 1/2 (12.7) & 9 1/4 (235.0)
Height: 10 (254.0)
F. Gskt: [1] Included

LL1630-2

Long Life Air Element with 2-Inch Pleats



Notes: Inside-Out Flow Direction
Fits: Caterpillar, Cummins Engines; Compair,
 Consolidated, Gardner Denver, Ingersoll-Rand,
 Joy Compressors
Replaces: Caterpillar 9L3420;
 Cummins 130752; GMC 247059
O.D.: 13 13/16 (350.8)
I.D.: 1/2 (12.7) & 9 1/2 (241.3)
Height: 14 (355.6)
F. Gskt: [1] Included
Related To: PA1630-2 (Standard Media
 Version)

LL1626-2

Long Life Air Element with 2-Inch Pleats



Notes: Inside-Out Flow Direction
Fits: Euclid, Hough Equipment
Replaces: Euclid 9038805;
 International 425615-R91
O.D.: 12 1/8 (308.0)
I.D.: 1/2 (12.7) & 7 11/16 (195.3)
Height: 10 (254.0)
F. Gskt: [1] Included
Related To: PA1626-2 (Standard Media
 Version)

PA1630-2

Air Element with 2-Inch Pleats



Notes: Inside-Out Flow Direction
Fits: Caterpillar, Cummins Engines; Compair,
 Consolidated, Gardner Denver, Ingersoll-Rand,
 Joy Compressors
Replaces: Caterpillar 9L3420;
 Cummins 130752; GMC 247059
O.D.: 13 13/16 (350.8)
I.D.: 1/2 (12.7) & 9 1/2 (241.3)
Height: 14 (355.6)
F. Gskt: [1] Included
Related To: LL1630-2 (Long-Life Media
 Version)

PA1626-2

Air Element with 2-Inch Pleats



Notes: Inside-Out Flow Direction
Fits: Euclid, Hough Equipment
Replaces: Euclid 9038805;
 International 425615-R91
O.D.: 12 1/8 (308.0)
I.D.: 1/2 (12.7) & 7 11/16 (195.3)
Height: 10 (254.0)
F. Gskt: [1] Included
Related To: LL1626-2 (Long-Life Media
 Version)

PA1631-S

Air Element



Fits: Caterpillar Engines
Replaces: Caterpillar 5L1203
O.D.: 13 13/16 (350.8)
I.D.: 9 1/2 (241.3) One End
Height: 18 1/8 (460.4)
A. Gskt: [1] Attached

PA1627

Rocker Arm Air Breather Element



Fits: Cummins Engines
Replaces: Cummins 255180
O.D.: 5 (127.0)
I.D.: 2 5/8 (66.7)
Height: 1 5/16 (33.3)

Measurements Are Shown In Inches And (Millimeters)

WARNING: These products can expose you to chemicals, including Diisononyl Phthalate, Carbon black extracts, Nickel, 1,3 Butadiene, Ethylene Oxide, Epichlorohydrin, which are known to the State of California to cause cancer, and Bisphenol, Ethylene Glycol, Ethylene Oxide, 1,3 Butadiene, Epichlorohydrin, which are known to the State of California to cause birth defects or other reproductive harm. For more information go to www.P65Warnings.ca.gov.

PA1632 Air Element
Fits: GMC Engines; Ingersoll-Rand Compressors
Replaces: GMC 6422964; Ingersoll-Rand 40070
O.D.: 16 5/8 (422.3)
I.D.: 12 (304.8)
Height: 16 (406.4)



PA1635 Air Element
Fits: Allis Chalmers, Case, Hough, John Bean Equipment
Replaces: Allis Chalmers 4824451; Case L48583
O.D.: 5 1/4 (133.4)
I.D.: 2 5/8 (66.7) One End
Height: 8 (203.2)



PA1633 Air Element
Fits: Caterpillar Equipment, Industrial, Marine, Starter Engines
Replaces: Caterpillar 8M3120
O.D.: 4 1/4 (108.0)
I.D.: 1 5/8 (41.3) One End
Height: 4 3/4 (120.7)
A. Gskt: [1] Attached



LL1636-FN Long Life Air Element with Fins
Fits: Allis Chalmers, Case, Caterpillar, Hitachi, Hough, Ingersoll-Rand, John Deere, Michigan Equipment; Mitsubishi Trucks
Replaces: Allis Chalmers 24472812; Case L35913; John Deere AR30644
O.D.: 7 15/16 (201.6)
 Fins 10 1/16 (255.6)
I.D.: 1/2 (12.7) & 3 9/16 (90.5)
Height: 10 1/4 (260.4)
A. Gskt: [1] Attached
F. Gskt: [1] Included
Related To: PA1636-FN (Standard Media Version)



LL1634 Long Life Outer Air Element
Fits: Caterpillar Truck Engines, Equipment
Use With: PA1675, PA2310, PA2737
Replaces: Caterpillar 4M9334, 8N5317; General Motors 6421540; Mitsubishi 4574070210; Poclair P2050509
O.D.: 11 1/8 (282.6)
I.D.: 6 23/32 (170.7) One End
Height: 13 1/2 (342.9)
A. Gskt: [1] Attached
Related To: PA1634 (Standard Media Version)
 PA1634XP (Extreme Performance Nano Version)



PA1636-FN Air Element with Fins
Fits: Allis Chalmers, Case, Caterpillar, Hitachi, Hough, Ingersoll-Rand, John Deere, Michigan Equipment; Mitsubishi Trucks
Replaces: Allis Chalmers 24472812; Case L35913; John Deere AR30644
O.D.: 7 15/16 (201.6)
 Fins 10 1/16 (255.6)
I.D.: 1/2 (12.7) & 3 9/16 (90.5)
Height: 10 1/4 (260.4)
A. Gskt: [1] Attached
F. Gskt: [1] Included
Related To: LL1636-FN (Long-Life Media Version)



PA1634 Outer Air Element
Fits: Caterpillar Truck Engines, Equipment
Use With: PA1675, PA2310, PA2737
Replaces: Caterpillar 4M9334, 8N5317; General Motors 6421540; Mitsubishi 4574070210; Poclair P2050509
O.D.: 11 1/8 (282.6)
I.D.: 6 23/32 (170.7) One End
Height: 13 1/2 (342.9)
A. Gskt: [1] Attached
Related To: LL1634 (Long-Life Media Version)
 PA1634XP (Extreme Performance Nano Version)



LL1637-FN Long Life Air Element with Fins
Fits: Clark, Euclid, Grove, Hitachi, Koehring, Link-Belt, Michigan, Vermeer Equipment; Hino, International, Kenworth, Mitsubishi Trucks
Replaces: Clark 941089; International 877600-C9; Kenworth 944809
O.D.: 11 1/8 (282.6)
 Fins 13 3/4 (349.3)
I.D.: 5/8 (15.9) & 6 23/32 (170.7)
Height: 12 1/2 (317.5)
A. Gskt: [1] Attached
F. Gskt: [1] Included
Related To: PA1637-FN (Standard Media Version)



PA1634XP Extreme Performance Nano Outer Air Element
Fits: Caterpillar Truck Engines, Equipment
Use With: PA1675, PA2310, PA2737
Replaces: Caterpillar 4M9334, 8N5317; General Motors 6421540; Mitsubishi 4574070210; Poclair P2050509
O.D.: 11 1/8 (282.6)
I.D.: 6 23/32 (170.7) One End
Height: 13 1/2 (342.9)
A. Gskt: [1] Attached
Related To: LL1634 (Long-Life Media Version)
 PA1634 (Standard Media Version)



PA1637-FN Air Element with Fins
Fits: Clark, Euclid, Grove, Hitachi, Koehring, Link-Belt, Michigan, Vermeer Equipment; Hino, International, Kenworth, Mitsubishi Trucks
Replaces: Clark 941089; International 877600-C9; Kenworth 944809
O.D.: 11 1/8 (282.6)
 Fins 13 3/4 (349.3)
I.D.: 5/8 (15.9) & 6 23/32 (170.7)
Height: 12 1/2 (317.5)
A. Gskt: [1] Attached
F. Gskt: [1] Included
Related To: LL1637-FN (Long-Life Media Version)



Measurements Are Shown In Inches And (Millimeters)

 **WARNING:** These products can expose you to chemicals, including Diisononyl Phthalate, Carbon black extracts, Nickel, 1,3 Butadiene, Ethylene Oxide, Epichlorohydrin, which are known to the State of California to cause cancer, and Bisphenol, Ethylene Glycol, Ethylene Oxide, 1,3 Butadiene, Epichlorohydrin, which are known to the State of California to cause birth defects or other reproductive harm. For more information go to www.P65Warnings.ca.gov.

PA1639

Air Element



Fits: Craftsman, John Deere, Lambert, Pennsylvania Lawn & Garden Equipment; Mercedes-Benz Trucks
Replaces: GMC 6486857; John Deere AM31000; Mercedes-Benz 942804
O.D.: 4 13/32 (111.9)
I.D.: 2 15/16 (74.6)
Height: 5 (127.0)

PA1641

Air Element



Fits: GMC Engines
Replaces: GMC 6484302
O.D.: 13 27/32 (351.6)
I.D.: 1/2 (12.7) & 11 1/8 (282.6)
Height: 7 1/2 (190.5)
A. Gskt: [1] Attached
F. Gskt: [1] Included

LL1642-2

Long Life Air Element with 2-Inch Pleats



Notes: Inside-Out Flow Direction
Fits: Austin-Western, Gardner Denver, KW-Dart Equipment; Kenworth Trucks
Replaces: Gardner Denver 5B345 GMC 6424683; Kenworth 461396
O.D.: 12 1/32 (305.6)
I.D.: 9/16 (14.3) & 7 11/16 (195.3)
Height: 13 (330.2)
F. Gskt: [1] Included
Related To: PA1642-2 (Standard Media Version)

PA1642-2

Air Element with 2-Inch Pleats



Notes: Inside-Out Flow Direction
Fits: Austin-Western, Gardner Denver, KW-Dart Equipment; Kenworth Trucks
Replaces: Gardner Denver 5B345; GMC 6424683; Kenworth 461396
O.D.: 12 1/32 (305.6)
I.D.: 9/16 (14.3) & 7 11/16 (195.3)
Height: 13 (330.2)
F. Gskt: [1] Included
Related To: LL1642-2 (Long-Life Media Version)

PA1643

Air Element



Replaces: Euclid 9192471; GMC 9038908
O.D.: 13 27/32 (351.6)
I.D.: 1/2 (12.7) & 11 1/8 (282.6)
Height: 14 (355.6)
F. Gskt: [1] Included

PA1644

Air Element with Lift Tab



Contains: Flame Retardant Media
Fits: Allis Chalmers, Caterpillar, Hyster, International Equipment
Replaces: Allis Chalmers 23589378; Hyster 23471906; International 391852-R92; Towmotor 343008
O.D.: 3 9/16 (90.5)
I.D.: 2 1/32 (51.6) One End
Height: 11 (279.4)
A. Gskt: [1] Attached

F1645-DS

Special Vac-Cel Fuel Sock



Fits: Winslow 1645 Series Housings
Replaces: Winslow W1645T
O.D.: 4 1/4 (108.0)
I.D.: 1 1/16 (27.0)
Height: 16 (406.4)
F. Gskt: G140-A Included with V1645-C Only

V1645-C

Vac-Cel Full-Flow Lube Sock



Fits: Winslow 1645 Series Housings
Replaces: Winslow W1645T
O.D.: 4 1/4 (108.0)
I.D.: 1 1/16 (27.0)
Height: 16 (406.4)
F. Gskt: G140-A

LL1646-FN

Long Life Air Element with Fins



Fits: Case, Caterpillar, Dresser, Drott, Galion, Grove, Hitachi, Hydro-Ax, Koehring, Michigan Equipment; Iveco, R.V.I. Trucks
Replaces: Case A60743; Caterpillar 9Y6834; Drott 221313; Galion D73499; Hitachi D911762; Iveco 9917881
O.D.: 9 7/32 (234.2)
 Fins 11 5/8 (295.3)
I.D.: 21/32 (16.7) & 4 27/32 (123.0)
Height: 10 1/2 (266.7)
A. Gskt: [1] Attached
F. Gskt: [1] Included
Related To: PA1646-FN (Standard Media Version)

PA1646

Air Element



Replaces: Donaldson P107643
O.D.: 9 7/32 (234.2)
I.D.: 21/32 (16.7) & 4 27/32 (123.0)
Height: 10 1/2 (266.7)
A. Gskt: [1] Attached
F. Gskt: [1] Included

PA1646-FN

Air Element with Fins



Fits: Case, Caterpillar, Dresser, Drott, Galion, Grove, Hitachi, Hydro-Ax, Koehring, Michigan Equipment; Iveco, R.V.I. Trucks
Replaces: Case A60743; Caterpillar 9Y6834; Drott 221313; Galion D73499; Hitachi D911762; Iveco 9917881
O.D.: 9 7/32 (234.2)
 Fins 11 5/8 (295.3)
I.D.: 21/32 (16.7) & 4 27/32 (123.0)
Height: 10 1/2 (266.7)
A. Gskt: [1] Attached
F. Gskt: [1] Included
Related To: LL1646-FN (Long-Life Media Version)

PA1647

Inner Air Element with 6 Bolts





Fits Inside: LL1615, PA1615, PA1615XP
Fits: Caterpillar Equipment
Replaces: Caterpillar 2S1285
O.D.: 4 3/4 (120.7)
 Flange 7 5/16 (185.7)
I.D.: 3 5/8 (92.1) One End
Height: 12 (304.8)
A. Gskt: [1] Attached
F. Gskt: [1] Included

Measurements Are Shown In Inches And (Millimeters)

WARNING: These products can expose you to chemicals, including Diisononyl Phthalate, Carbon black extracts, Nickel, 1,3 Butadiene, Ethylene Oxide, Epichlorohydrin, which are known to the State of California to cause cancer, and Bisphenol, Ethylene Glycol, Ethylene Oxide, 1,3 Butadiene, Epichlorohydrin, which are known to the State of California to cause birth defects or other reproductive harm. For more information go to www.P65Warnings.ca.gov.

PA1648 Air Element

Contains: Flame Retardant Media
Fits: Allis Chalmers Lift Trucks
Replaces: Allis Chalmers 49931583
O.D.: 6 13/32 (162.7)
Top: 6 21/32 (169.1)
I.D.: 4 3/32 (104.0)
Height: 3 (76.2)

LL1649 Long Life Air Element

Notes: Inside-Out Flow Direction
Fits: Caterpillar, Cummins Engines; Euclid, Terex, Volvo Equipment
Replaces: Caterpillar 6L3313; Cummins 707664; Euclid 9395885; Terex 9030854; Volvo 79230041
O.D.: 13 13/16 (350.8)
I.D.: 1/2 (12.7) & 9 1/2 (241.3)
Height: 16 (406.4)
F. Gskt: [1] Included
Related To: PA1649 (Standard Media Version)

PA1649 Air Element

Notes: Inside-Out Flow Direction
Fits: Caterpillar, Cummins Engines; Euclid, Terex, Volvo Equipment
Replaces: Caterpillar 6L3313; Cummins 707664; Euclid 9395885; Terex 9030854; Volvo 79230041
O.D.: 13 13/16 (350.8)
I.D.: 1/2 (12.7) & 9 1/2 (241.3)
Height: 16 (406.4)
F. Gskt: [1] Included
Related To: LL1649 (Long-Life Media Version)

PA1650-FN Air Element with Fins

Fits: Dresser, International Loaders, Tractors
Replaces: International 343731-R91
O.D.: 7 15/16 (201.6)
Fins: 10 1/16 (255.6)
I.D.: 1/2 (12.7) & 3 9/16 (90.5)
Height: 16 3/8 (415.9)
A. Gskt: [1] Attached
F. Gskt: [1] Included

PA1653 Air Compressor Element

Fits: Joy Compressors
Replaces: Joy 1222941
O.D.: 6 7/8 (174.6)
I.D.: 5 1/8 (130.2)
Height: 7 (177.8)
Related To: PA2102 (for Engine Air)

V1656-O Vac-Cel Dual-Stage Full-Flow Orlon Lube Sock

Notes: For use with high heat applications.
Fits: Clark, Gradall, Grove Equipment; Waukesha Engines
Replaces: Waukesha 167602B
O.D.: 4 1/2 (114.3)
I.D.: 1 1/16 (27.0)
Height: 16 (406.4)
F. Gskt: G144
Related To: C133-W, C133-OW (Double-Length Versions)

V1656-T Vac-Cel Dual-Stage Full-Flow Cotton Lube Sock

Notes: Use V1656-O for use with high heat applications.
Fits: Clark, Gradall, Grove Equipment; Waukesha Engines
Replaces: Waukesha 167602B
O.D.: 4 1/2 (114.3)
I.D.: 1 1/16 (27.0)
Height: 16 (406.4)
F. Gskt: G144
Related To: C133-W, C133-OW (Double-Length Versions)

PA1657 Air Element

Fits: GMC, Isuzu, Nissan Automotive, Light-Duty Trucks
Replaces: GMC 94213709; Isuzu 8-94206-007-0
O.D.: 10 1/8 (257.2)
I.D.: 7 15/16 (201.6)
Height: 2 3/8 (60.3)

PA1661(3) Set of 3 Air Elements

Fits: California Custom Accessories
Replaces: California Custom PC15658
O.D.: 4 (101.6)
I.D.: 2 3/4 (69.9)
Height: 2 1/32 (51.6)

PA1663 Outer Air Element

Fits: Case Equipment
Use With: PA1664
Replaces: Case A17741
O.D.: 12 1/16 (306.4)
I.D.: 7 13/16 (198.4)
Height: 10 7/16 (265.1)
A. Gskt: [2] Attached

PA1664 Inner Air Element

Fits Inside: PA1663
Fits: Case Equipment
Replaces: Case A17742
O.D.: 6 5/8 (168.3)
I.D.: 4 1/4 (108.0)
Height: 9 13/16 (249.2)
A. Gskt: [2] Attached

PA1666 Conical-Shaped Air Element

Fits: Ariens, Bush Hog, Craftsman, Cub Cadet, Ford, International, John Deere, Lambert, Lawn Boy Lawn & Garden Equipment
Replaces: International 488619-R1; John Deere AM30900; Lawn Boy 10063; Tecumseh 30727
O.D.: 2 31/32 (75.4) to 3 3/4 (95.3)
I.D.: 2 1/32 (51.6) One End
Height: 2 1/8 (54.0)

Measurements Are Shown In Inches And (Millimeters)

WARNING: These products can expose you to chemicals, including Diisononyl Phthalate, Carbon black extracts, Nickel, 1,3 Butadiene, Ethylene Oxide, Epichlorohydrin, which are known to the State of California to cause cancer, and Bisphenol, Ethylene Glycol, Ethylene Oxide, 1,3 Butadiene, Epichlorohydrin, which are known to the State of California to cause birth defects or other reproductive harm. For more information go to www.P65Warnings.ca.gov.

LL1667-FN



Long Life Outer Air Element with Fins
Fits: Allis Chalmers, Benford, Bobcat, Case, Ditch Witch, Fiat, Ford, Hesston, International, John Deere, Komatsu, Kubota, New Holland, Versatile Equipment
Use With: PA2489 on Melroe Equipment
Replaces: Allis Chalmers 74996245; Case A59998; International 204002-H1; John Deere AH19852
O.D.: 5 3/16 (131.8)
 Fins 6 3/8 (161.9)
I.D.: 2 1/32 (16.7) & 2 5/8 (66.7)
Height: 11 1/2 (292.1)
A. Gskt: [1] Attached
F. Gskt: G103-N
Related To: PA1667-FN (Standard Media Version)

PA1667-FN



Outer Air Element with Fins
Fits: Allis Chalmers, Benford, Bobcat, Case, Ditch Witch, Fiat, Ford, Hesston, International, John Deere, Komatsu, Kubota, New Holland, Versatile Equipment
Use With: PA2489 on Melroe Equipment
Replaces: Allis Chalmers 74996245; Case A59998; International 204002-H1; John Deere AH19852
O.D.: 5 3/16 (131.8)
 Fins 6 3/8 (161.9)
I.D.: 2 1/32 (16.7) & 2 5/8 (66.7)
Height: 11 1/2 (292.1)
A. Gskt: [1] Attached
F. Gskt: G103-N
Related To: LL1667-FN (Long-Life Media Version)

LL1669



Long Life Outer Air Element
Fits: Caterpillar Equipment
Use With: PA1670, PA2733, PA2739
Replaces: Caterpillar 7M9045, 8N5316
O.D.: 11 1/8 (282.6)
I.D.: 6 23/32 (170.7) One End
Height: 16 1/2 (419.1)
A. Gskt: [1] Attached
Related To: PA1669 (Standard Media Version)

PA1669



Outer Air Element
Fits: Caterpillar Equipment
Use With: PA1670, PA2733, PA2739
Replaces: Caterpillar 7M9045, 8N5316
O.D.: 11 1/8 (282.6)
I.D.: 6 23/32 (170.7) One End
Height: 16 1/2 (419.1)
A. Gskt: [1] Attached
Related To: LL1669 (Long-Life Media Version)

PA1670



Inner Air Element with 8 Bolts
Notes: On Caterpillar using a Fleetguard or Heavy Duty Air conversion bracket, use PA2739.
Fits Inside: LL1669, PA1669
Fits: Caterpillar Equipment
Replaces: Caterpillar 2S1287
O.D.: 6 1/4 (158.8)
 Flange 9 1/16 (230.2)
I.D.: 4 5/8 (117.5) One End
Height: 16 (406.4)
A. Gskt: [1] Attached
F. Gskt: G42-AF

PA1673



Outer Air Element
Fits: Caterpillar Equipment
Use With: PA1674, PA3471
Replaces: Caterpillar 4M9378, 7W3920
O.D.: 8 3/8 (212.7)
I.D.: 4 (101.6) One End
Height: 10 1/2 (266.7)
A. Gskt: [1] Attached

PA1674



Inner Air Element with 6 Bolts
Fits Inside: PA1673
Fits: Caterpillar Equipment
Replaces: Caterpillar 2S1288, 9M1829
O.D.: 3 3/4 (95.3)
 Flange 6 11/16 (169.9)
I.D.: 2 5/8 (66.7) One End
Height: 10 3/32 (256.4)
A. Gskt: [1] Attached
F. Gskt: [1] Included

PA1675



Inner Air Element with 8 Bolts
Fits Inside: LL1634, PA1634, PA1634XP
Fits: Caterpillar Equipment
Replaces: Caterpillar 2S1286
O.D.: 6 1/4 (158.8)
 Flange 9 1/16 (230.2)
I.D.: 4 5/8 (117.5) One End
Height: 13 3/32 (332.6)
A. Gskt: [1] Attached
F. Gskt: [1] Included

LL1676-FN



Long Life Air Element with Fins
Fits: Cummins, Waukesha Engines
Replaces: Cummins 156773; Waukesha 163631
O.D.: 12 1/32 (305.6)
 Fins 15 3/4 (400.1)
I.D.: 17/32 (13.5) & 7 11/16 (195.3)
Height: 14 1/2 (368.3)
A. Gskt: [1] Attached
F. Gskt: [1] Included
Related To: PA1676-FN (Standard Media Version)

PA1676-FN



Air Element with Fins
Fits: Cummins, Waukesha Engines
Replaces: Cummins 156773; Waukesha 163631
O.D.: 12 1/32 (305.6)
 Fins 15 3/4 (400.1)
I.D.: 17/32 (13.5) & 7 11/16 (195.3)
Height: 14 1/2 (368.3)
A. Gskt: [1] Attached
F. Gskt: [1] Included
Related To: LL1676-FN (Long-Life Media Version)

PA1679



Air Breather Element
Fits: Caterpillar Equipment, Starter Engines
Replaces: Caterpillar 8M3119
O.D.: 3 1/8 (79.4)
I.D.: 1 1/2 (38.1)
Height: 3 3/4 (95.3)
A. Gskt: [2] Attached

Measurements Are Shown In Inches And (Millimeters)

! **WARNING:** These products can expose you to chemicals, including Diisononyl Phthalate, Carbon black extracts, Nickel, 1,3 Butadiene, Ethylene Oxide, Epichlorohydrin, which are known to the State of California to cause cancer, and Bisphenol, Ethylene Glycol, Ethylene Oxide, 1,3 Butadiene, Epichlorohydrin, which are known to the State of California to cause birth defects or other reproductive harm. For more information go to www.P65Warnings.ca.gov.

PA1680 Air Element
Fits: GM Automotive, Light-Duty Trucks, Vans; Jeep Vehicles
Replaces: GMC 3902837; Jeep 948516
O.D.: 9 21/32 (245.3)
I.D.: 8 1/4 (209.6)
Height: 3 9/16 (90.5)
Related To: PA658 (Short Version)



PA1684 Outer Air Element
Contains: Flame Retardant Media
Fits: Allis Chalmers, Bobcat, Caterpillar, Hyster, International, John Deere Equipment; Bobcat Loaders
Use With: PA1809
Replaces: Allis Chalmers 235449; Case S63738; Caterpillar 65-6140; John Deere AH19853
O.D.: 4 1/2 (114.3)
I.D.: 2 1/4 (57.2) One End
Height: 12 5/8 (320.7)
A. Gskt: [1] Attached



LL1681-FN Long Life Outer Air Element with Fins
Fits: GMC, Mack Trucks; Allis Chalmers, Case, Caterpillar, John Deere Equipment
Use With: PA2321, PA2570
Replaces: GMC 6424690; Mack 2MD455AP2
O.D.: 6 3/32 (154.8)
 Fins 7 13/16 (198.4)
I.D.: 3/4 (19.1) & 3 15/32 (88.1)
Height: 12 3/8 (314.3)
A. Gskt: [1] Attached
F. Gskt: G103-N
Related To: PA1681-FN (Standard Media Version)



PA1686 Inner Air Element
Fits Inside: PA1687
Fits: Bobcat Loaders; Case Equipment
Replaces: Case L31277; Clark 1804278
O.D.: 8 1/16 (204.8)
I.D.: 5 3/4 (146.1)
Height: 15 1/4 (387.4)



PA1681-FN Outer Air Element with Fins
Fits: GMC, Mack Trucks; Allis Chalmers, Case, Caterpillar, John Deere Equipment
Use With: PA2321, PA2570
Replaces: GMC 6424690; Mack 2MD455AP2
O.D.: 6 3/32 (154.8)
 Fins 7 13/16 (198.4)
I.D.: 3/4 (19.1) & 3 15/32 (88.1)
Height: 12 3/8 (314.3)
A. Gskt: [1] Attached
F. Gskt: G103-N
Related To: LL1681-FN (Long-Life Media Version)



PA1687 Outer Air Element
Fits: Case Equipment
Use With: PA1686
Replaces: Case L31276; Clark 1805389
O.D.: 14 5/32 (359.6)
I.D.: 9 1/2 (241.3)
Height: 15 15/16 (404.8)



PA1682 Air Element with Lift Tab
Fits: Allis Chalmers Equipment
Replaces: Allis Chalmers 236650
O.D.: 5 1/2 (139.7)
I.D.: 3 1/8 (79.4) One End
Height: 14 1/4 (362.0)
A. Gskt: [1] Attached



PA1688 Air Element
Contains: Flame Retardant Media
Fits: Caterpillar Lift Trucks
Replaces: Caterpillar 35-8896; GMC 25041709
O.D.: 2 15/16 (74.6)
 Flange 3 1/4 (82.6)
I.D.: 2 (50.8) One End
Height: 3 15/16 (100.0)



PA1683 Outer Air Element with Lift Tab
Contains: Flame Retardant Media
Fits: Allis Chalmers, Ford, International, Massey Ferguson Equipment
Use With: PA1809
Replaces: Allis Chalmers 237395; Ford E6NN9B618AB; Massey Ferguson 1026191-M91
O.D.: 4 1/2 (114.3)
I.D.: 2 1/4 (57.2) One End
Height: 10 3/4 (273.1)
A. Gskt: [1] Attached



PA1689 Air Element
Replaces: White 3399-H2, 877834
O.D.: 7 5/16 (185.7)
I.D.: 5 5/16 (134.9)
Height: 6 1/2 (165.1)
A. Gskt: [2] Attached



Measurements Are Shown In Inches And (Millimeters)

 **WARNING:** These products can expose you to chemicals, including Diisononyl Phthalate, Carbon black extracts, Nickel, 1,3 Butadiene, Ethylene Oxide, Epichlorohydrin, which are known to the State of California to cause cancer, and Bisphenol, Ethylene Glycol, Ethylene Oxide, 1,3 Butadiene, Epichlorohydrin, which are known to the State of California to cause birth defects or other reproductive harm. For more information go to www.P65Warnings.ca.gov.

LL1690-FN

Long Life Air Element with Fins



Notes: Outer element on some applications.
Fits: Allis Chalmers, Benford, Bobcat, Case, Case-International, Clark, Ford, Gehl, John Deere, Komatsu, Kubota Equipment; Thermo King Refrigeration Units
Use With: PA2861, PA4740
Replaces: Allis Chalmers 2103129; Case 542276; Caterpillar 9Y6839; Clark 1642645
O.D.: 4 3/32 (104.0)
Fins: 5 1/8 (130.2)
I.D.: 25/32 (19.8) & 2 15/32 (62.7)
Height: 10 11/32 (262.7)
A. Gskt: [1] Attached
F. Gskt: G103-N
Related To: PA1690-FN (Standard Media Version)

PA1690-FN

Air Element with Fins



Notes: Outer element on some applications.
Fits: Allis Chalmers, Benford, Bobcat, Case, Case-International, Clark, Ford, Gehl, John Deere, Komatsu, Kubota Equipment; Thermo King Refrigeration Units
Use With: PA2861, PA4740
Replaces: Allis Chalmers 2103129; Case 542276; Caterpillar 9Y6839; Clark 1642645
O.D.: 4 3/32 (104.0)
Fins: 5 1/8 (130.2)
I.D.: 25/32 (19.8) & 2 15/32 (62.7)
Height: 10 11/32 (262.7)
A. Gskt: [1] Attached
F. Gskt: G103-N
Related To: LL1690-FN (Long-Life Media Version)

PA1692

Air Element with Lift Tab



Fits: Dresser, Drott, Elgin, International, Wayne Equipment
Replaces: Drott 71405; Elgin 7075795; International 338744-R91; Wayne 47180
O.D.: 5 1/2 (139.7)
I.D.: 3 1/8 (79.4) One End
Height: 17 1/4 (438.2)
A. Gskt: [1] Attached

PA1696

Air Element



Fits: Austin, MG Automotive
Replaces: Leyland 17H2538
O.D.: 5 (127.0)
I.D.: 3 9/16 (90.5)
Height: 3 11/16 (93.7)

PA1697

Air Element



Fits: MG Automotive
Replaces: Austin-Healey 37H732
O.D.: 4 5/16 (109.5)
I.D.: 2 7/8 (73.0)
Height: 3 11/16 (93.7)

PA1698

Air Element



Contains: Flame Retardant Media
Replaces: Donaldson P133672, P133708
O.D.: 8 1/16 (204.8)
I.D.: 5 3/4 (146.1)
Height: 4 (101.6)

PA1699-FN

Air Element with Fins



Fits: Allis Chalmers, Case Equipment
Replaces: Allis Chalmers 239622; Case A59586
O.D.: 6 3/32 (154.8)
Fins: 7 13/16 (198.4)
I.D.: 25/32 (19.8) & 3 15/32 (88.1)
Height: 14 15/32 (367.5)
A. Gskt: [1] Attached
F. Gskt: G103-N

PA1700

Dual-Stage Air Element with Blanket and Screen



Fits: Autocar, Brockway, Diamond Reo Trucks; Allis Chalmers, Caterpillar, Gradall, Hyster Equipment
Replaces: Allis Chalmers 4051919; Brockway 22115; Towmotor 633075
O.D.: 8 11/32 (211.9)
I.D.: 3 7/8 (98.4) One End
Height: 9 11/16 (246.1)
Related To: PA617 (Standard Version)

PA1701

Dual-Stage Air Element with Blanket and Screen



Fits: Diamond Reo Trucks; Allis Chalmers Equipment
Use With: PA1701 FOAM
Replaces: Allis Chalmers 4051918; Hough 165935-H1
O.D.: 9 9/16 (242.9)
I.D.: 5 1/8 (130.2) One End
Height: 11 19/32 (294.5)
Related To: PA1913 (Other Housings) PA2627 (Both Ends Open)

PA1701 ELE

Air Element



Fits: Diamond Reo Trucks; Allis Chalmers Equipment
Use With: PA1701 FOAM
Replaces: Allis Chalmers 4051918; Hough 165935-H1
O.D.: 9 9/16 (242.9)
I.D.: 5 1/8 (130.2) One End
Height: 11 19/32 (294.5)
Related To: PA1913 (Other Housings) PA2627 (Both Ends Open)

PA1701 FOAM

Foam Blanket for PA1701 ELE



Use With: PA1701 ELE
Length: 29 (736.6)
Width: 10 1/2 (266.7)
Height: 1 (25.4)

PA1702

Dual-Stage Air Element with Blanket and Screen



Fits: Cummins, Waukesha Engines; Ingersoll-Rand Compressors
Use With: PA1702 FOAM
Replaces: Allis Chalmers 4052520; Cummins 3001692; Waukesha 163972B
O.D.: 12 15/32 (316.7)
I.D.: 7 7/8 (200.0) One End
Height: 16 (406.4)

Measurements Are Shown In Inches And (Millimeters)

WARNING: These products can expose you to chemicals, including Diisononyl Phthalate, Carbon black extracts, Nickel, 1,3 Butadiene, Ethylene Oxide, Epichlorohydrin, which are known to the State of California to cause cancer, and Bisphenol, Ethylene Glycol, Ethylene Oxide, 1,3 Butadiene, Epichlorohydrin, which are known to the State of California to cause birth defects or other reproductive harm. For more information go to www.P65Warnings.ca.gov.

PA1702 FOAM Foam Blanket for PA1702
Use With: PA1702
Length: 37 1/2 (952.5)
Width: 15 3/4 (400.1)
Height: 1 (25.4)



PA1703 Dual-Stage Air Element with Blanket and Screen
Fits: Caterpillar Engines
Replaces: Caterpillar 4L8465
O.D.: 9 15/16 (252.4)
I.D.: 5 1/2 (139.7)
Height: 12 (304.8)



PA1704 Air Compressor Breather Element
Fits: Bendix-Westinghouse Air Compressors; Brockway, Caterpillar, GMC, Kenworth, Mack Trucks
Replaces: Bendix-Westinghouse 243009; Brockway 243009; Caterpillar 9L2169; GMC 2495698
O.D.: 3 (76.2)
I.D.: 1 5/8 (41.3)
Height: 1 3/8 (34.9)



PA1705-2 Air Element with 2-Inch Pleats
Fits: Dresser, Hough, International Equipment
Replaces: International 346777-R91
O.D.: 12 1/32 (305.6)
I.D.: 17/32 (13.5) & 7 11/16 (195.3)
Height: 10 3/8 (263.5)
A. Gskt: [1] Attached
F. Gskt: [1] Included
Related To: LL1626-2, PA1626-2 (without Attached Gasket)



PA1706 Air Element
Notes: Inside-Out Flow Direction
Fits: Atlas Copco, Hough, International Equipment
Replaces: Atlas Copco 16193784; International 346779-R91
O.D.: 13 25/32 (350.0)
I.D.: 1/2 (12.7) & 9 7/16 (239.7)
Height: 14 1/2 (368.3)
A. Gskt: [1] Attached
F. Gskt: [1] Included
Related To: PA1630 (without Attached Gasket) PA1706XP (Extreme Performance Nano Version)



PA1706XP Extreme Performance Nano Air Element
Notes: Inside-Out Flow Direction
Fits: Atlas Copco, Hough, International Equipment
Replaces: Atlas Copco 16193784; International 346779-R91
O.D.: 13 25/32 (350.0)
I.D.: 1/2 (12.7) & 9 7/16 (239.7)
Height: 14 1/2 (368.3)
A. Gskt: [1] Attached
F. Gskt: [1] Included
Related To: PA1630 (without Attached Gasket) PA1706 (Standard Media Version)



PA1707-FN Air Element with Fins
Fits: International, Minneapolis-Moline, Oliver, White Combines, Tractors
Replaces: International 399631-R91; Oliver 158613A5; White 20-7002170
O.D.: 5 1/4 (133.4)
Fins: 6 3/8 (161.9)
I.D.: 2 1/32 (16.7) & 2 5/8 (66.7)
Height: 14 1/4 (362.0)
A. Gskt: [1] Attached
F. Gskt: G103-N



PA1709 Cab Air Element
Fits: International, Steiger Equipment
Replaces: International 383711-R94; Steiger 64-084
O.D.: 6 3/32 (154.8)
I.D.: 3/4 (19.1) & 3 15/32 (88.1)
Height: 16 1/4 (412.8)
A. Gskt: [1] Attached
F. Gskt: G103-N



PA1710 Air Element
Fits: International Wheel Tractors
Replaces: International 383732-R93
O.D.: 6 3/32 (154.8)
I.D.: 3/4 (19.1) & 3 15/32 (88.1)
Height: 11 1/4 (285.8)
A. Gskt: [1] Attached
F. Gskt: G103-N



PA1712 Air Element
Fits: Burns, Cub Cadet, Ford, Gilson, Jacobsen, John Deere, Lambert, Massey Ferguson, Roper, Springfield Lawn & Garden Tractors; Kohler, Tecumseh Engines; Ingersoll-Rand Compressors
Replaces: John Deere AM30800; Kohler 231847; Tecumseh-Lauson 31925; Massey Ferguson 231847
O.D.: 4 13/32 (111.9)
I.D.: 2 15/16 (74.6)
Height: 2 3/8 (60.3)



PA1718 Air Element
Fits: Lister-Petter, Rolls-Royce Engines
Replaces: Lister-Petter 20126010
O.D.: 5 1/2 (139.7)
I.D.: 3 1/4 (82.6)
Height: 4 1/2 (114.3)



PA1719 Air Element
Fits: Case, David Brown, Eddison Equipment; Lister Engines
Replaces: Case K922630; David Brown 922630; Lister 194010
O.D.: 8 1/4 (209.6)
I.D.: 5 7/8 (149.2)
Height: 3 15/16 (100.0)



Measurements Are Shown In Inches And (Millimeters)

WARNING: These products can expose you to chemicals, including Diisononyl Phthalate, Carbon black extracts, Nickel, 1,3 Butadiene, Ethylene Oxide, Epichlorohydrin, which are known to the State of California to cause cancer, and Bisphenol, Ethylene Glycol, Ethylene Oxide, 1,3 Butadiene, Epichlorohydrin, which are known to the State of California to cause birth defects or other reproductive harm. For more information go to www.P65Warnings.ca.gov.

PA1721

Air Element



Replaces: Gardner Denver 2010265
O.D.: 5 3/4 (146.1)
I.D.: 4 1/8 (104.8)
Height: 5 31/32 (151.6)

PA1752-FN

Air Element with Fins



Fits: John Deere Tractors
Replaces: John Deere AH19848
O.D.: 5 1/4 (133.4)
 Fins 6 3/8 (161.9)
I.D.: 2 1/32 (16.7) & 2 5/8 (66.7)
Height: 9 3/8 (238.1)
A. Gskt: [1] Attached
F. Gskt: G103-N

PA1726

Inner Air Element



Fits Inside: PA666
Fits: Galion Graders; Optional Purolator Housings
Replaces: Purolator 6659367
O.D.: 6 5/8 (168.3)
I.D.: 4 1/4 (108.0)
Height: 14 1/2 (368.3)

PA1753-FN

Air Element with Fins



Fits: John Deere Equipment
Replaces: John Deere AH69798
O.D.: 6 3/32 (154.8)
 Fins 7 13/16 (198.4)
I.D.: 3/4 (19.1) & 3 15/32 (88.1)
Height: 10 13/32 (264.3)
A. Gskt: [1] Attached
F. Gskt: G103-N

PA1735

Air Element



Fits: AMC, Chrysler, Ford, International Automotive, Light-Duty Trucks
Replaces: Chrysler 8992873; Ford C7AF-9600-N
O.D.: 10 1/16 (255.6)
I.D.: 7 21/32 (194.5)
Height: 2 3/8 (60.3)

PA1754

Air Element with Lift Tab



Fits: Bantam, Bros, Dresser, Drott, International, Wayne Equipment
Replaces: GMC 6483853; International 603889-C91; White 1739647
O.D.: 7 (177.8)
I.D.: 4 13/32 (111.9) One End
Height: 20 1/4 (514.4)
A. Gskt: [1] Attached

PA1748

Air Element



Fits: Gravely Tractors
Replaces: Gravely L823D, L832E, 13042P1
O.D.: 3 11/16 (93.7)
I.D.: 2 3/16 (55.6)
Height: 4 1/8 (104.8)

PA1755-FN

Air Element with Fins



Fits: Allis Chalmers Equipment
Replaces: Allis Chalmers 3038732-9
O.D.: 7 15/16 (201.6)
 Fins 10 1/16 (255.6)
I.D.: 1/2 (12.7) & 3 9/16 (90.5)
Height: 13 3/8 (339.7)
A. Gskt: [1] Attached
F. Gskt: [1] Included

PA1749-FN

Air Element with Fins



Fits: GMC Trucks; Murphy Diesel Engines
Replaces: GMC 5197106; Murphy MD24618
O.D.: 7 15/16 (201.6)
 Fins 10 1/16 (255.6)
I.D.: 1/2 (12.7) & 3 9/16 (90.5)
Height: 12 1/4 (311.2)
A. Gskt: [1] Attached
F. Gskt: [1] Included

PA1757

Air Breather Element



Fits: Jay Tampers
Replaces: Davey 200595
O.D.: 3 7/16 (87.3)
I.D.: 2 3/8 (60.3)
Height: 2 1/16 (52.4)

PA1750-FN

Air Element with Fins



Fits: Hino, International, Mitsubishi Trucks
Replaces: GMC 6486936; Hino 17801-1150; International 381667-C91; Mitsubishi 30930-35100
O.D.: 9 7/32 (234.2)
 Fins 11 5/8 (295.3)
I.D.: 5/8 (15.9) & 4 27/32 (123.0)
Height: 10 3/8 (263.5)
A. Gskt: [1] Attached
F. Gskt: [1] Included

PA1758

Air Element



Contains: Flame Retardant Media
Fits: GM Automotive, Light-Duty Trucks
Replaces: GMC 6424140
O.D.: 13 7/8 (352.4)
I.D.: 11 5/8 (295.3)
Height: 3 (76.2)

Measurements Are Shown In Inches And (Millimeters)

WARNING: These products can expose you to chemicals, including Diisononyl Phthalate, Carbon black extracts, Nickel, 1,3 Butadiene, Ethylene Oxide, Epichlorohydrin, which are known to the State of California to cause cancer, and Bisphenol, Ethylene Glycol, Ethylene Oxide, 1,3 Butadiene, Epichlorohydrin, which are known to the State of California to cause birth defects or other reproductive harm. For more information go to www.P65Warnings.ca.gov.

PA1763

Air Breather Element



Fits: Galion Equipment
Replaces: Galion D59585
O.D.: 2 7/32 (56.4)
I.D.: 1 1/32 (26.2)
Height: 2 5/16 (58.7)

PA1772

Tube-Type Air Filter



Contains: 6 Tubes--2 x 3
Fits: Blaw-Knox, CMI Equipment;
Farr Optional Housings
Replaces: Farr P6
Length: 8 1/4 (209.6)
Width: 5 31/32 (151.6)
Height: 8 1/8 (206.4)

PA1765

Panel Air Element

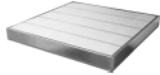

Notes: Do NOT use in cab air ventilation systems.
Fits: Atlas Copco Compressors; Caterpillar Industrial, Marine Engines
Use With: PA1765 FOAM
Replaces: Caterpillar 6L4714
Length: 24 (609.6)
Width: 24 (609.6)
Height: 2 9/16 (65.1)
A. Gskt: [1] Attached

PA1773

Tube-Type Air Filter



Contains: 9 Tubes--3 x 3
Fits: Farr Optional Housings
Replaces: Farr P9
Length: 8 5/16 (211.1)
Width: 8 5/16 (211.1)
Height: 8 1/16 (204.8)

PA1765 FOAM

Foam Blanket for PA1765



Use With: PA1765
Length: 26 (660.4)
Width: 24 (609.6)

PA1774

Tube-Type Air Filter



Contains: 12 Tubes--3 x 4
Fits: Dynahoe, Pettibone Equipment;
Farr Optional Housings
Replaces: Farr P12
Length: 10 9/16 (268.3)
Width: 8 1/4 (209.6)
Height: 8 1/16 (204.8)

PA1768

Air Element



Fits: Joy Compressors
Replaces: Joy 1224040
O.D.: 11 1/8 (282.6)
I.D.: 3/8 (9.5) & 6 3/16 (157.2)
Height: 18 1/8 (460.4)
A. Gskt: [1] Attached
F. Gskt: [1] Included, [1] Wing Bolt

PA1775

Tube-Type Air Filter



Contains: 12 Tubes--2 x 6
Fits: Allis Chalmers, Blaw-Knox Equipment;
Farr Optional Housings
Replaces: Farr P12-26
Length: 15 3/16 (385.8)
Width: 5 15/16 (150.8)
Height: 8 5/32 (207.2)

PA1769

Air Element with Lift Bar



Fits: International, Michigan Equipment
Replaces: Eaton 509081800
O.D.: 7 (177.8)
I.D.: 4 3/8 (111.1) One End
Height: 9 1/4 (235.0)
A. Gskt: [1] Attached

PA1776

Tube-Type Air Filter



Contains: 16 Tubes--4 x 4
Fits: Dresser, International, Taylor, Timberjack Equipment; Farr Optional Housings
Replaces: Farr P16
Length: 10 9/16 (268.3)
Width: 10 9/16 (268.3)
Height: 8 1/8 (206.4)

PA1771

Tube-Type Air Filter



Contains: 4 Tubes--2 x 2
Fits: Bobcat Loaders; Farr Optional Housings;
Lister Engines
Replaces: Farr P4
Length: 8 1/16 (204.8)
Width: 6 (152.4)
Height: 6 (152.4)

PA1777

Tube-Type Air Filter



Contains: 16 Tubes--2 x 8
Fits: Clark, Michigan Equipment; Farr Optional Housings
Replaces: Farr P16-28
Length: 19 27/32 (504.0)
Width: 5 31/32 (151.6)
Height: 8 5/32 (207.2)

PA1778

Tube-Type Air Filter

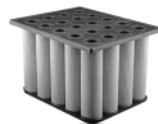

Contains: 20 Tubes--4 x 5
Fits: Farr Optional Housings;
Taylor Equipment
Replaces: Farr P20
Length: 12 13/16 (325.4)
Width: 10 9/16 (268.3)
Height: 8 5/32 (207.2)

Measurements Are Shown In Inches And (Millimeters)

WARNING: These products can expose you to chemicals, including Diisononyl Phthalate, Carbon black extracts, Nickel, 1,3 Butadiene, Ethylene Oxide, Epichlorohydrin, which are known to the State of California to cause cancer, and Bisphenol, Ethylene Glycol, Ethylene Oxide, 1,3 Butadiene, Epichlorohydrin, which are known to the State of California to cause birth defects or other reproductive harm. For more information go to www.P65Warnings.ca.gov.

PA1779



Tube-Type Air Filter

Contains: 24 Tubes--4 x 6
Fits: Allis Chalmers, Clark, Dresser, Euclid, International, Massey Ferguson Equipment; Farr Optional Housings
Replaces: Farr P24
Length: 15 3/16 (385.8)
Width: 10 9/16 (268.3)
Height: 8 5/32 (207.2)

PA1780

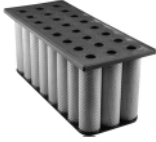

Tube-Type Air Filter

Contains: 24 Tubes--3 x 8
Fits: Dodge, Leyland Trucks; Farr Optional Housings; Rolls-Royce Engines
Replaces: Farr P24-38
Length: 19 7/8 (504.8)
Width: 8 1/4 (209.6)
Height: 8 5/32 (207.2)

PA1781



Tube-Type Air Filter

Contains: 32 Tubes--4 x 8
Fits: Allis Chalmers, International, Michigan, M-R-S Equipment; Farr Optional Housings; Ingersoll-Rand Compressors
Replaces: Farr P32
Length: 19 7/8 (504.8)
Width: 10 9/16 (268.3)
Height: 8 5/32 (207.2)

PA1782

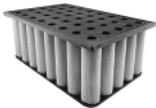

Tube-Type Air Filter

Contains: 40 Tubes--5 x 8
Fits: Allis Chalmers, International, Michigan, Equipment; Farr Optional Housings; Ingersoll-Rand, Sullair Compressors
Replaces: Farr P40
Length: 19 29/32 (505.6)
Width: 12 25/32 (324.6)
Height: 8 5/32 (207.2)

PA1783

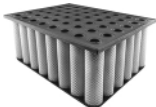

Tube-Type Air Filter

Contains: 48 Tubes--6 x 8
Fits: Allis Chalmers, Caterpillar, CMI, Michigan Equipment; Cummins Engines; Dodge Trucks; Farr Optional Housings
Replaces: Farr P48
Length: 19 7/8 (504.8)
Width: 15 7/32 (386.6)
Height: 8 5/32 (207.2)

PA1784

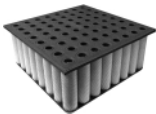

Tube-Type Air Filter

Contains: 64 Tubes--8 x 8
Fits: Euclid, International, Kawasaki, WABCO Equipment; Farr Optional Housings
Replaces: Farr P64
Length: 19 13/16 (503.2)
Width: 19 13/16 (503.2)
Height: 8 1/8 (206.4)

PA1786



Air Element

Fits: GMC, International Buses, Trucks
Replaces: GMC 3906250
O.D.: 12 15/16 (328.6)
I.D.: 10 7/16 (265.1)
Height: 3 (76.2)

PA1787



Air Element

Fits: Chrysler Industrial Engines; Cleveland Equipment
Replaces: GMC 6487076
O.D.: 6 3/32 (154.8)
I.D.: 7/16 (11.1) & 2 31/32 (75.4)
Height: 8 7/8 (225.4)
A. Gskt: [1] Attached
F. Gskt: [1] Included

PA1788



Air Element

Fits: Cummins Engines; Yale & Towne Cranes, Loaders
Replaces: Vortex VF120A; Yale 6952220
O.D.: 8 7/8 (225.4)
I.D.: 7/16 (11.1) & 5 (127.0)
Height: 10 1/8 (257.2)
A. Gskt: [1] Attached
F. Gskt: [1] Included

PA1789



Air Element

Fits: Mack Trucks
Replaces: GMC 6486928
O.D.: 10 3/8 (263.5)
I.D.: 1/2 (12.7) & 5 1/2 (139.7)
Height: 10 3/8 (263.5)
A. Gskt: [1] Included
F. Gskt: [1] Included

PA1790



Air Element

Fits: International Trucks
Replaces: GMC 6488334; International 397549-C91
O.D.: 11 7/8 (301.6)
I.D.: 7/16 (11.1) & 7 1/8 (181.0)
Height: 13 3/8 (339.7)
A. Gskt: [1] Attached
F. Gskt: [1] Included

PA1794-FN



Outer Air Element with Fins

Fits: John Deere Equipment
Use With: PA1921, PA2622
Replaces: John Deere AR39799
O.D.: 6 27/32 (173.8)
 Fins 8 13/16 (223.8)
I.D.: 21/32 (16.7) & 4 5/32 (105.6)
Height: 10 1/2 (266.7)
A. Gskt: [1] Attached
F. Gskt: G103-N

PA1795



Air Element

Fits: Air Refiner ARH27 Housing
Replaces: Air Refiner ARP27
O.D.: 9 1/8 (231.8)
I.D.: 6 7/8 (174.6)
Height: 12 (304.8)

Measurements Are Shown In Inches And (Millimeters)



WARNING: These products can expose you to chemicals, including Diisononyl Phthalate, Carbon black extracts, Nickel, 1,3 Butadiene, Ethylene Oxide, Epichlorohydrin, which are known to the State of California to cause cancer, and Bisphenol, Ethylene Glycol, Ethylene Oxide, 1,3 Butadiene, Epichlorohydrin, which are known to the State of California to cause birth defects or other reproductive harm. For more information go to www.P65Warnings.ca.gov.

PA1797 Inner Air Element with 18 Bolt Holes
Fits Inside: PA1815
Fits: Caterpillar Equipment
Replaces: Caterpillar 3S4745
O.D.: 8 5/8 (219.1)
 Flange 12 (304.8)
I.D.: 6 31/32 (177.0) One End
Height: 15 11/32 (389.7)
A. Gskt: [1] Attached



PA1810 Air Element
Replaces: Cummins 701645
O.D.: 9 5/8 (244.5)
I.D.: 5 3/8 (136.5)
Height: 12 3/16 (309.6)
A. Gskt: [2] Attached



PA1798 Air Element
Notes: Sometimes used as Cab Air on Steiger Tractors.
Fits: Chevrolet, GMC Buses, Trucks; Steiger Tractors
Replaces: GMC 6423239
O.D.: 11 5/16 (287.3)
I.D.: 8 17/32 (217.5)
Height: 5 9/16 (141.3)
Related To: PA1800 (with Foam Wrap)



PA1814 Air Element
Fits: Fiat, Triumph Automotive
Replaces: Fiat 4110530
O.D.: 6 7/8 (174.6)
I.D.: 5 1/8 (130.2)
Height: 2 (50.8)



PA1800 Air Element with Foam Wrap
Notes: Sometimes used as Cab Air on Ford, Steiger Equipment.
Fits: Ford, Steiger Equipment; GMC Buses, Trucks
Replaces: Ford SFD54304; GMC 8877141
O.D.: 12 (304.8)
I.D.: 8 17/32 (217.5)
Height: 5 9/16 (141.3)
Related To: PA1798 (without Foam Wrap)



PA1815 Outer Air Element with Lid
Fits: Caterpillar Equipment
Use With: PA1797, PA2625
Replaces: Caterpillar 5S4282
O.D.: 13 5/8 (346.1)
 Lid 16 7/16 (417.5)
I.D.: 15/16 (23.8) & 9 15/16 (252.4)
Height: 16 5/32 (410.4)
A. Gskt: [2] Attached



PA1802 Air Element
Fits: BMW, Ford Automotive, Light-Duty Trucks
Replaces: Ford E4TE-9601-AA
O.D.: 11 13/16 (300.0)
I.D.: 9 13/16 (249.2)
Height: 2 1/8 (54.0)
Related To: PA2119 (with Foam Wrap)



PA1816 Outer Air Element with Lid
Fits: Caterpillar Equipment
Use With: PA1817
Replaces: Caterpillar 4S8833
O.D.: 12 3/4 (323.9)
 Lid 14 17/32 (369.1)
I.D.: 15/16 (23.8) & 8 11/32 (211.9)
Height: 9 13/16 (249.2)
A. Gskt: [2] Attached
F. Gskt: [1] Included



PA1805 Air Element
Fits: Allmand Equipment with Optional United Housings
Replaces: United 250A13
O.D.: 6 11/32 (161.1)
I.D.: 4 5/32 (105.6)
Height: 3 1/32 (77.0)



PA1817 Inner Air Element with 8 Bolt Holes
Fits Inside: PA1816
Fits: Caterpillar Equipment
Replaces: Caterpillar 4S8834
O.D.: 7 5/8 (193.7)
 Flange 10 1/4 (260.4)
I.D.: 6 (152.4) One End
Height: 8 25/32 (223.0)
A. Gskt: [1] Attached



PA1806 Tube-Type Air Filter
Contains: 18 Tubes--3 x 6
Fits: Allis Chalmers Tractors; Farr Optional Housings
Replaces: Allis Chalmers 70644042; Farr P18
Length: 15 3/16 (385.8)
Width: 8 1/4 (209.6)
Height: 8 1/8 (206.4)



PA1818 Outer Air Element with Lid
Fits: Caterpillar Equipment
Use With: PA1819, PA2738
Replaces: Caterpillar 4S8337
O.D.: 12 3/4 (323.9)
 Lid 14 17/32 (369.1)
I.D.: 15/16 (23.8) & 8 3/8 (212.7)
Height: 14 1/2 (368.3)
A. Gskt: [2] Attached















PA1809 Inner Air Element
Fits Inside: PA1683, PA1684, PA2331, PA2431, PA2496
Fits: Caterpillar, Ford, Massey Ferguson Equipment
Replaces: Ford E6NN-9R500-DA
O.D.: 2 1/8 (54.0)
 Flange 2 11/32 (59.5)
I.D.: 5/8 (7.9) & 1 7/8 (47.6)
Height: 9 7/8 (250.8)
F. Gskt: [1] Included
O-Ring: [1] Attached



Measurements Are Shown In Inches And (Millimeters)

WARNING: These products can expose you to chemicals, including Diisononyl Phthalate, Carbon black extracts, Nickel, 1,3 Butadiene, Ethylene Oxide, Epichlorohydrin, which are known to the State of California to cause cancer, and Bisphenol, Ethylene Glycol, Ethylene Oxide, 1,3 Butadiene, Epichlorohydrin, which are known to the State of California to cause birth defects or other reproductive harm. For more information go to www.P65Warnings.ca.gov.

<p>PA1819</p> 	<p>Inner Air Element with 8 Bolt Holes Fits Inside: PA1818 Fits: Caterpillar Equipment Replaces: Caterpillar 4S8340 O.D.: 7 5/8 (193.7) Flange 10 1/4 (260.4) I.D.: 6 (152.4) One End Height: 13 15/32 (342.1) A. Gskt: [1] Attached</p>	<p>PA1826</p> 	<p>Inner Air Element with 8 Bolts Fits Inside: PA1827 Fits: International Equipment Replaces: International 390643-R91 O.D.: 4 9/16 (115.9) Flange 7 (177.8) I.D.: 3 3/8 (85.7) One End Height: 15 (381.0) A. Gskt: [1] Attached</p>
<p>PA1821</p> 	<p>Air Element Fits: Massey Ferguson Tractors Replaces: Massey Ferguson 1029945-M92 O.D.: 4 3/32 (104.0) I.D.: 3/8 (9.5) & 2 15/32 (62.7) Height: 9 3/8 (238.1) A. Gskt: [1] Attached F. Gskt: [1] Included, [1] Wing Bolt</p>	<p>PA1827</p> 	<p>Outer Air Element Fits: International Equipment Use With: PA1826 Replaces: International 390642-R91 O.D.: 9 7/32 (234.2) I.D.: 4 27/32 (123.0) One End Height: 16 3/8 (415.9) A. Gskt: [1] Attached</p>
<p>PA1822-FN</p> 	<p>Outer Air Element with Fins Fits: J.C. Bamford, Massey Ferguson, Oliver Equipment Use With: PA2305 Replaces: Massey Ferguson 726199-M1; Oliver 159089A O.D.: 6 3/32 (154.8) Fins 7 13/16 (198.4) I.D.: 3/4 (19.1) & 3 15/32 (88.1) Height: 15 5/16 (388.9) A. Gskt: [1] Attached F. Gskt: G103-N Related To: PA2418-FN (Different Gasket)</p>	<p>PA1828</p> 	<p>Air Element Fits: Ford Automotive Replaces: Ford C7SF-9601-A O.D.: 13 9/32 (337.3) I.D.: 11 9/32 (286.5) Height: 2 7/32 (56.4)</p>
<p>PA1823</p> 	<p>Air Element Fits: International Payhaulers Replaces: International 606029-C91 O.D.: 11 1/8 (282.6) I.D.: 5/8 (15.9) & 6 23/32 (170.7) Height: 18 1/2 (469.9) A. Gskt: [1] Attached F. Gskt: [1] Included</p>	<p>PA1830-FN</p> 	<p>Air Element with Fins Fits: International Tractors Replaces: International 381344-R91 O.D.: 5 1/4 (133.4) Fins 6 3/8 (161.9) I.D.: 2 1/32 (16.7) & 2 5/8 (66.7) Height: 10 1/4 (260.4) A. Gskt: [1] Attached F. Gskt: G103-N</p>
<p>PA1824</p> 	<p>Outer Air Element Fits: Dresser, International Equipment Use With: PA1825 Replaces: International 606860-C91 O.D.: 9 7/32 (234.2) I.D.: 4 27/32 (123.0) One End Height: 18 3/8 (466.7) A. Gskt: [1] Attached</p>	<p>PA1831</p> 	<p>Air Element Fits: Massey Ferguson Tractors; Perkins Engines Replaces: Massey Ferguson 1028094-M91 O.D.: 6 1/16 (154.0) I.D.: 3/8 (9.5) & 3 15/32 (88.1) Height: 15 1/2 (393.7) A. Gskt: [1] Attached F. Gskt: [1] Included, [1] Wing Bolt</p>
<p>PA1825</p> 	<p>Inner Air Element with 8 Bolts Fits Inside: PA1824 Fits: Dresser, International Equipment Replaces: International 606861-C91 O.D.: 4 9/16 (115.9) Flange 7 (177.8) I.D.: 3 3/8 (85.7) One End Height: 17 1/32 (432.6) A. Gskt: [1] Attached</p>	<p>PA1832</p> 	<p>Air Element Fits: Petter Engines; V.M.E. Loaders; Volvo Equipment Replaces: Petter ZFP35/6 O.D.: 5 1/2 (139.7) I.D.: 3 1/4 (82.6) Height: 2 5/16 (58.7)</p>
		<p>PA1834</p> 	<p>Air Element Fits: Benford Equipment; Petter Engines Replaces: Petter AAF449/6 O.D.: 3 17/32 (89.7) I.D.: 2 (50.8) Height: 2 (50.8)</p>

Measurements Are Shown In Inches And (Millimeters)

! **WARNING:** These products can expose you to chemicals, including Diisononyl Phthalate, Carbon black extracts, Nickel, 1,3 Butadiene, Ethylene Oxide, Epichlorohydrin, which are known to the State of California to cause cancer, and Bisphenol, Ethylene Glycol, Ethylene Oxide, 1,3 Butadiene, Epichlorohydrin, which are known to the State of California to cause birth defects or other reproductive harm. For more information go to www.P65Warnings.ca.gov.

PA1836

Inner Air Element



Fits Inside: PA1837-FN, PA2338-FN
Fits: International Equipment
Replaces: International 392516-R91
O.D.: 5 1/4 (133.4)
I.D.: 5/8 (15.9) & 4 1/8 (104.8)
Height: 13 3/8 (339.7)
A. Gskt: [1] Attached
F. Gskt: [1] Included

PA1846

Outer Air Element



Fits: Chevrolet, Ford, GMC, Nissan, R.V.I., Scania Trucks; Allis Chalmers, Euclid, Fiat-Allis, Grove, Koehring, Michigan, WABCO Equipment
Use With: PA1880
Replaces: Allis Chalmers 659386; Euclid 9232508; Fiat 70198780; Ford D0HZ-9601-H; GMC 6489643
O.D.: 12 1/8 (308.0)
I.D.: 5/8 (15.9) & 7 11/16 (195.3)
Height: 18 1/2 (469.9)
A. Gskt: [1] Attached
F. Gskt: G103-N
Related To: LL1846 (Long-Life Media Version)
 PA1846XP (Extreme Performance Nano Version)

PA1837-FN

Outer Air Element with Fins



Fits: International Equipment
Use With: PA1836
Replaces: International 392517-R91
O.D.: 7 15/16 (201.6)
 Fins 10 1/16 (255.6)
I.D.: 5 3/8 (136.5) One End
Height: 14 5/16 (363.5)
A. Gskt: [1] Attached

PA1846XP

Extreme Performance Nano Outer Air Element



Fits: Chevrolet, Ford, GMC, Nissan, R.V.I., Scania Trucks; Allis Chalmers, Euclid, Fiat-Allis, Grove, Koehring, Michigan, WABCO Equipment
Use With: PA1880
Replaces: Allis Chalmers 659386; Euclid 9232508; Fiat 70198780; Ford D0HZ-9601-H; GMC 6489643
O.D.: 12 1/8 (308.0)
I.D.: 5/8 (15.9) & 7 11/16 (195.3)
Height: 18 1/2 (469.9)
A. Gskt: [1] Attached
F. Gskt: G103-N
Related To: LL1846 (Long-Life Media Version)
 PA1846 (Standard Media Version)

PA1840

Air Element



Replaces: Ford C5TF-9600-Y
O.D.: 9 7/32 (234.2)
I.D.: 5/8 (15.9) & 4 27/32 (123.0)
Height: 10 3/32 (256.4)
A. Gskt: [1] Attached
F. Gskt: [1] Included
Related To: PA2412 (with Air Restriction Gauge Fitting)

PA1847-FN

Outer Air Element with Fins



Fits: Joy Compressors
Use With: PA1880
Replaces: Joy 1224974
O.D.: 12 (304.8)
 Fins 15 3/4 (400.1)
I.D.: 5/8 (15.9) & 7 11/16 (195.3)
Height: 18 9/16 (471.5)
A. Gskt: [1] Attached
F. Gskt: G103-N

PA1841

Air Element



Fits: Chevrolet, GMC Light-Duty Trucks
Replaces: GMC 6485194
O.D.: 10 1/8 (257.2)
I.D.: 7 1/2 (190.5)
Height: 3 1/8 (79.4)

PA1845

Air Element



Fits: Ford Trucks
Replaces: Ford C7TZ-9601-D
O.D.: 9 3/4 (247.7)
I.D.: 7/16 (11.1) & 5 1/4 (133.4)
Height: 13 29/32 (353.2)
A. Gskt: [1] Attached
F. Gskt: [1] Included, [1] Wing Bolt

PA1848

Air Element



Fits: Ford Trucks
Replaces: Ford C7TZ-9601-C
O.D.: 8 9/32 (210.3)
I.D.: 3/8 (9.5) & 4 7/16 (112.7)
Height: 11 1/2 (292.1)
A. Gskt: [1] Attached
F. Gskt: [1] Included, [1] Wing Bolt

LL1846

Long Life Outer Air Element



Fits: Chevrolet, Ford, GMC, Nissan, R.V.I., Scania Trucks; Allis Chalmers, Euclid, Fiat-Allis, Grove, Koehring, Michigan, WABCO Equipment
Use With: PA1880
Replaces: Allis Chalmers 659386; Euclid 9232508; Fiat 70198780; Ford D0HZ-9601-H; GMC 6489643
O.D.: 12 1/8 (308.0)
I.D.: 5/8 (15.9) & 7 11/16 (195.3)
Height: 18 1/2 (469.9)
A. Gskt: [1] Attached
F. Gskt: G103-N
Related To: PA1846 (Standard Version)
 PA1846XP (Extreme Performance Nano Version)

PA1849

Air Element with Lift Tab



Fits: Case Equipment
Replaces: Case D46062
O.D.: 7 (177.8)
I.D.: 4 13/32 (111.9) One End
Height: 12 5/8 (320.7)
A. Gskt: [1] Attached

Measurements Are Shown In Inches And (Millimeters)

WARNING: These products can expose you to chemicals, including Diisononyl Phthalate, Carbon black extracts, Nickel, 1,3 Butadiene, Ethylene Oxide, Epichlorohydrin, which are known to the State of California to cause cancer, and Bisphenol, Ethylene Glycol, Ethylene Oxide, 1,3 Butadiene, Epichlorohydrin, which are known to the State of California to cause birth defects or other reproductive harm. For more information go to www.P65Warnings.ca.gov.

PA1850-FN

Air Element with Fins



Fits: Clark, Huber Equipment
Replaces: Clark 1990272
O.D.: 6 3/32 (154.8)
 Fins 7 13/16 (198.4)
I.D.: 3/4 (19.1) & 3 15/32 (88.1)
Height: 16 1/4 (412.8)
A. Gskt: [1] Attached
F. Gskt: G103-N

PA1860

Air Element



Replaces: Worthington ELM13
O.D.: 7 15/16 (201.6)
I.D.: 6 9/32 (159.5)
Height: 4 3/16 (106.4)

PA1851

Air Element



Fits: Barber-Greene, Winpower Equipment;
 Hercules Engines
Replaces: GMC 6486930; White 40-0000619
O.D.: 7 5/16 (185.7)
I.D.: 7/16 (11.1) & 3 1/2 (88.9)
Height: 10 3/8 (263.5)
A. Gskt: [1] Attached
F. Gskt: G39-AF

PA1861

Air Element



Fits: Chicago-Pneumatic, Sullair Compressors
Replaces: Sullair 40099
O.D.: 9 3/4 (247.7)
I.D.: 6 1/16 (154.0)
Height: 3 11/16 (93.7)

PA1852

Air Element



Fits: Mercedes-Benz, Opel Automotive
Replaces: BMW 13720642102;
 Mercedes-Benz 947704; Opel 834252
O.D.: 5 7/8 (149.2)
 Top 6 1/2 (165.1)
I.D.: 3 1/2 (88.9)
Height: 4 9/32 (108.7)

PA1863

Air Element



Replaces: International 308504-C91
O.D.: 12 1/32 (305.6)
I.D.: 17/32 (13.5) & 7 11/16 (195.3)
Height: 14 1/2 (368.3)
A. Gskt: [1] Attached
F. Gskt: [1] Included
Related To: PA1676-FN (with Fins)

PA1857

Air Element



Fits: Worthington Compressors
Replaces: Worthington FLR313
O.D.: 5 3/4 (146.1)
I.D.: 4 1/4 (108.0)
Height: 4 1/8 (104.8)

PA1864-FN

Outer Air Element with Fins



Fits: Joy Compressors
Use With: PA2455
Replaces: Joy 519002
O.D.: 11 1/8 (282.6)
 Fins 13 3/4 (349.3)
I.D.: 5/8 (15.9) & 6 23/32 (170.7)
Height: 15 1/2 (393.7)
A. Gskt: [1] Attached
F. Gskt: G103-N

PA1858

Air Element



Fits: Bolens, Lockwood, Richmond
 Equipment; Wisconsin Engines
Replaces: Wisconsin LO175B
O.D.: 4 3/16 (106.4)
I.D.: 1 15/16 (49.2)
Height: 4 1/8 (104.8)

PA1865-FN

Air Element with Fins



Fits: Allis Chalmers, Bolens, Case, Ford, Gehl,
 John Deere, Kubota, Vermeer, Yanmar
 Equipment
Replaces: Allis Chalmers 70246364; Bolens
 1872002; Case D82571; John Deere M73009;
 Kubota 15227-87481
O.D.: 3 1/4 (82.6)
 Fins 4 1/4 (108.0)
I.D.: 13/32 (10.3) & 1 27/32 (46.8)
Height: 7 1/4 (184.2)
A. Gskt: [1] Attached
F. Gskt: [1] Included

PA1859

Air Element



Fits: Benford, Bolens, Midland Equipment;
 Wisconsin Engines
Replaces: Wisconsin LO173B
O.D.: 3 9/16 (90.5)
I.D.: 2 1/8 (54.0)
Height: 4 3/16 (106.4)

PA1866

Air Element



Contains: Flame Retardant Media
Fits: Cummins Engines
Replaces: Cummins 209892
O.D.: 9 5/8 (244.5)
I.D.: 5 (127.0)
Height: 6 9/16 (166.7)
A. Gskt: [2] Attached
Related To: PA1867 (Long Version)

PA1867

Air Element



Contains: Flame Retardant Media
Fits: Cummins Engines
Replaces: Cummins 209893
O.D.: 9 5/8 (244.5)
I.D.: 5 (127.0)
Height: 8 1/16 (204.8)
A. Gskt: [2] Attached
Related To: PA1866 (Short Version)

Measurements Are Shown In Inches And (Millimeters)

! **WARNING:** These products can expose you to chemicals, including Diisononyl Phthalate, Carbon black extracts, Nickel, 1,3 Butadiene, Ethylene Oxide, Epichlorohydrin, which are known to the State of California to cause cancer, and Bisphenol, Ethylene Glycol, Ethylene Oxide, 1,3 Butadiene, Epichlorohydrin, which are known to the State of California to cause birth defects or other reproductive harm. For more information go to www.P65Warnings.ca.gov.

PA1868

Air Element



Fits: Atlas Copco Compressors
Replaces: Atlas Copco 1619-1613
O.D.: 6 7/16 (163.5)
I.D.: 4 1/16 (103.2)
Height: 10 1/2 (266.7)
A. Gskt: [2] Attached

PA1881

Air Element



Fits: Diamond Reo Buses, Trucks
Replaces: Diamond Reo 3107361-H2
O.D.: 11 1/8 (282.6)
I.D.: 5/8 (15.9) & 6 23/32 (170.7)
Height: 13 3/8 (339.7)
A. Gskt: [1] Attached
F. Gskt: G103-N

PA1873

Air Element



Replaces: Worthington FLR319
O.D.: 7 7/8 (200.0)
I.D.: 6 1/8 (155.6)
Height: 5 3/16 (131.8)

PA1882

Outer Air Element



Fits: Iveco Trucks; Hitachi, John Deere, Massey Ferguson Equipment
Use With: PA2570
Replaces: Iveco 9985779; John Deere AT65088; Massey Ferguson 1030543-M91
O.D.: 6 3/32 (154.8)
I.D.: 3/4 (19.1) & 3 15/32 (88.1)
Height: 12 15/32 (316.7)
A. Gskt: [1] Attached
F. Gskt: G103-N

V1874-T

Vac-Cel Full-Flow Lube Sock



Fits: Waukesha Engines; Winslow Optional Filter Housings
Replaces: Winslow 1874 Series
O.D.: 6 1/2 (165.1)
I.D.: 2 3/4 (69.9)
Height: 17 (431.8)
O. Gskt: G206

PA1883-FN

Air Element with Fins



Fits: Case, John Deere Tractors
Replaces: Case D73225; John Deere AR44774
O.D.: 5 1/4 (133.4)
Fins: 6 3/8 (161.9)
I.D.: 21/32 (16.7) & 2 5/8 (66.7)
Height: 13 3/8 (339.7)
A. Gskt: [1] Attached
F. Gskt: G103-N

PA1875

Air Element



Fits: Master Equipment
Replaces: Master C6001
O.D.: 3 7/16 (87.3)
I.D.: 2 3/8 (60.3)
Height: 3 1/2 (88.9)

LL1884

Long Life Outer Air Element



Fits: Allis Chalmers, Case, Caterpillar, Daewoo, Doosan, Drott, Fiat-Allis, Grove, Hitachi, J.C. Bamford, Massey Ferguson, New Holland, Volvo Equipment; Foden, Ford Europe, Iveco, Leyland, R.V.I. Buses, Trucks
Use With: PA1911
Replaces: Ag-Chem 721237023A; Case S231996; Drott 609421; Fiat 1909136; J.C. Bamford 32/201602
O.D.: 9 7/32 (234.2)
I.D.: 21/32 (16.7) & 4 27/32 (123.0)
Height: 13 1/2 (342.9)
A. Gskt: [1] Attached
F. Gskt: G103-N
Related To: PA1941-FN (with Fins)
 PA1874 (Standard Media Version)
 PA1884XP (Extreme Performance Nano Version)

PA1877

Air Element



Replaces: Mack 2MD49303A; White 27-074455
O.D.: 12 1/32 (305.6)
I.D.: 17/32 (13.5) & 7 11/16 (195.3)
Height: 12 1/2 (317.5)
A. Gskt: [1] Attached
F. Gskt: [1] Included

PA1884

Outer Air Element



Fits: Allis Chalmers, Case, Caterpillar, Daewoo, Doosan, Drott, Fiat-Allis, Grove, Hitachi, J.C. Bamford, Massey Ferguson, New Holland, Volvo Equipment; Foden, Ford Europe, Iveco, Leyland, R.V.I. Buses, Trucks
Use With: PA1911
Replaces: Ag-Chem 721237023A; Case S231996; Drott 609421; Fiat 1909136; J.C. Bamford 32/201602
O.D.: 9 7/32 (234.2)
I.D.: 21/32 (16.7) & 4 27/32 (123.0)
Height: 13 1/2 (342.9)
A. Gskt: [1] Attached
F. Gskt: G103-N
Related To: PA1941-FN (with Fins)
 LL1884 (Long-Life Media Version)
 PA1884XP (Extreme Performance Nano Version)

PA1880

Inner Air Element



Fits Inside: LL1846, PA1846, PA1846XP, PA1847-FN, PA2478
Fits: Allis Chalmers, Euclid, Fiat-Allis, International, Kobelco, Komatsu, Terex Equipment; Gardner Denver, Ingersoll-Rand Compressors
Replaces: Allis Chalmers 1975888; International 511967-C91; Kobelco 2446U-212-S2
O.D.: 7 5/16 (185.7)
Flange Gasket: 8 15/32 (215.1)
I.D.: 11/16 (17.5) & 6 3/16 (157.2)
Height: 17 19/32 (446.9)
A. Gskt: [1] Attached
F. Gskt: G103-N

Measurements Are Shown In Inches And (Millimeters)

WARNING: These products can expose you to chemicals, including Diisononyl Phthalate, Carbon black extracts, Nickel, 1,3 Butadiene, Ethylene Oxide, Epichlorohydrin, which are known to the State of California to cause cancer, and Bisphenol, Ethylene Glycol, Ethylene Oxide, 1,3 Butadiene, Epichlorohydrin, which are known to the State of California to cause birth defects or other reproductive harm. For more information go to www.P65Warnings.ca.gov.

PA1884XP



Extreme Performance Nano Outer Air Element
Fits: Allis Chalmers, Case, Caterpillar, Daewoo, Doosan, Drott, Fiat-Allis, Grove, Hitachi, J.C. Bamford, Massey Ferguson, New Holland, Volvo Equipment; Foden, Ford Europe, Iveco, Leyland, R.V.I. Buses, Trucks
Use With: PA1911
Replaces: Ag-Chem 721237023A; Case S231996; Drott 609421; Fiat 1909136; J.C. Bamford 32/201602
O.D.: 9 7/32 (234.2)
I.D.: 21/32 (16.7) & 4 27/32 (123.0)
Height: 13 1/2 (342.9)
A. Gskt: [1] Attached
F. Gskt: G103-N
Related To: PA1941-FN (with Fins)
 LL1884 (Long-Life Media Version)
 PA1874 (Standard Media Version)

LL1886



Long Life Outer Air Element
Fits: Case, Drott, Liebherr Excavators; Champion Graders; Euclid Equipment; Hino, Iveco Trucks; Hough Loaders; Ingersoll-Rand Drills; New Holland, Versatile Tractors
Use With: PA1904, PA3832
Replaces: Allis Chalmers 663856; Euclid 4003970; International 619763-C91; Iveco 1901780; John Deere AT69308; Liebherr 5604682; New Holland V30924; Terex 9038899
O.D.: 12 1/8 (308.0)
I.D.: 29/32 (23.0) & 7 11/16 (195.3)
Height: 16 1/2 (419.1)
A. Gskt: [1] Attached
F. Gskt: [1] Included
O. Gskt: G225-AF
Related To: PA1886 (Standard Media Version)
 PA1886XP (Extreme Performance Nano Version)

LL1885



Long Life Outer Air Element
Fits: Ag-Chem, Allis Chalmers, Caterpillar, Fiat-Allis, Gradall, Hitachi, John Deere, Kobelco, Komatsu, Massey Ferguson, Mitsubishi, New Holland Equipment; Foden, Iveco, Leland, M.A.N., Mitsubishi, R.V.I. Buses, Trucks
Use With: PA1893
Replaces: Ag-Chem 702455; Case L56041; Fiat-Allis 70662618; Hitachi 4237663; Iveco 1901902; Komatsu 600-181-3800
O.D.: 11 1/8 (282.6)
I.D.: 5/8 (15.9) & 6 23/32 (170.7)
Height: 16 1/2 (419.1)
A. Gskt: [1] Attached
F. Gskt: G103-N
Related To: PA1862 (Standard Media Version)
 PA1885XP (Extreme Performance Nano Version)

PA1886



Outer Air Element
Fits: Case, Drott, Liebherr Excavators; Champion Graders; Euclid Equipment; Hino, Iveco Trucks; Hough Loaders; Ingersoll-Rand Drills; New Holland, Versatile Tractors
Use With: PA1904, PA3832
Replaces: Allis Chalmers 663856; Euclid 4003970; International 619763-C91; Iveco 1901780; John Deere AT69308; Liebherr 5604682; New Holland V30924; Terex 9038899
O.D.: 12 1/8 (308.0)
I.D.: 29/32 (23.0) & 7 11/16 (195.3)
Height: 16 1/2 (419.1)
A. Gskt: [1] Attached
F. Gskt: [1] Included
O. Gskt: G225-AF
Related To: LL1886 (Long-Life Media Version)
 PA1886XP (Extreme Performance Nano Version)

PA1885



Outer Air Element
Fits: Ag-Chem, Allis Chalmers, Caterpillar, Fiat-Allis, Gradall, Hitachi, John Deere, Kobelco, Komatsu, Massey Ferguson, Mitsubishi, New Holland Equipment; Foden, Iveco, Leyland, M.A.N., Mitsubishi, R.V.I. Buses, Trucks
Use With: PA1893
Replaces: Ag-Chem 702455; Case L56041; Fiat-Allis 70662618; Hitachi 4237663; Iveco 1901902; Komatsu 600-181-3800
O.D.: 11 1/8 (282.6)
I.D.: 5/8 (15.9) & 6 23/32 (170.7)
Height: 16 1/2 (419.1)
A. Gskt: [1] Attached
F. Gskt: G103-N
Related To: LL1885 (Long-Life Media Version)
 PA1885XP (Extreme Performance Nano Version)

PA1886XP



Extreme Performance Nano Outer Air Element
Fits: Case, Drott, Liebherr Excavators; Champion Graders; Euclid Equipment; Hino, Iveco Trucks; Hough Loaders; Ingersoll-Rand Drills; New Holland, Versatile Tractors
Use With: PA1904, PA3832
Replaces: Allis Chalmers 663856; Euclid 4003970; International 619763-C91; Iveco 1901780; John Deere AT69308; Liebherr 5604682; New Holland V30924; Terex 9038899
O.D.: 12 1/8 (308.0)
I.D.: 29/32 (23.0) & 7 11/16 (195.3)
Height: 16 1/2 (419.1)
A. Gskt: [1] Attached
F. Gskt: [1] Included
O. Gskt: G225-AF
Related To: LL1886 (Long-Life Media Version)
 PA1886 (Standard Media Version)

PA1885XP



Extreme Performance Nano Outer Air Element
Fits: Ag-Chem, Allis Chalmers, Caterpillar, Fiat-Allis, Gradall, Hitachi, John Deere, Kobelco, Komatsu, Massey Ferguson, Mitsubishi, New Holland Equipment; Foden, Iveco, Leyland, M.A.N., Mitsubishi, R.V.I.
Use With: PA1893
Replaces: Ag-Chem 702455; Case L56041; Fiat-Allis 70662618; Hitachi 4237663; Iveco 1901902; Komatsu 600-181-3800
O.D.: 11 1/8 (282.6)
I.D.: 5/8 (15.9) & 6 23/32 (170.7)
Height: 16 1/2 (419.1)
A. Gskt: [1] Attached
F. Gskt: G103-N
Related To: LL1885 (Long-Life Media Version)
 PA1862 (Standard Media Version)

PA1888



Air Element
Replaces: White 892007
O.D.: 7 (177.8)
I.D.: 4 3/8 (111.1)
Height: 6 (152.4)

Measurements Are Shown In Inches And (Millimeters)

WARNING: These products can expose you to chemicals, including Diisononyl Phthalate, Carbon black extracts, Nickel, 1,3 Butadiene, Ethylene Oxide, Epichlorohydrin, which are known to the State of California to cause cancer, and Bisphenol, Ethylene Glycol, Ethylene Oxide, 1,3 Butadiene, Epichlorohydrin, which are known to the State of California to cause birth defects or other reproductive harm. For more information go to www.P65Warnings.ca.gov.

PA1889 Air Element
Fits: Ingersoll-Rand Compressors
Replaces: Ingersoll-Rand 35103217
O.D.: 7 7/8 (200.0)
I.D.: 4 1/8 (104.8)
Height: 3 (76.2)



PA1891 Cab Air Element
Contains: Flame Retardant Media
Fits: Toyota Lift Trucks
Replaces: Toyota 17801-23020
O.D.: 7 (177.8)
I.D.: 4 7/8 (123.8)
Height: 4 5/8 (117.5)



PA1892-FN Air Element with Fins
Fits: Chevrolet, GMC Trucks; Cummins Engines
Replaces: GMC 8994738
O.D.: 11 1/8 (282.6)
Fins: 13 3/4 (349.3)
I.D.: 5/8 (15.9) & 6 23/32 (170.7)
Height: 8 1/2 (215.9)
A. Gskt: [1] Attached
F. Gskt: [1] Included



PA1893 Inner Air Element
Fits Inside: LL1885, PA1885, PA1885XP, PA1979-FN
Fits: Ag-Chem, Allis Chalmers, Broyt, Caterpillar, Fiat-Allis, Grove, Hitachi, John Deere, Komatsu, Massey Ferguson, Michigan, Vermeer Equipment
Replaces: Ag-Chem 702463; Fiat-Allis 70662618; John Deere AU43090; Massey Ferguson 1495414-M91
O.D.: 6 13/32 (162.7)
Flange: 7 1/2 (190.5)
I.D.: 5/8 (15.9) & 5 1/4 (133.4)
Height: 16 (406.4)
A. Gskt: [1] Attached
F. Gskt: [1] Included



LL1894 Long Life Outer Air Element
Fits: Caterpillar, Dresser, Euclid, Ingersoll-Rand, Kawasaki, Michigan, Steiger, Terex, Volvo, WABCO Equipment
Use With: PA1905
Replaces: Caterpillar 8L5897; Euclid 9035866; Gardner Denver 166392; Terex 9035992
O.D.: 13 13/16 (350.8)
I.D.: 15/16 (23.8) & 9 1/2 (241.3)
Height: 18 1/2 (469.9)
A. Gskt: [1] Attached
F. Gskt: [1] Included
Related To: PA1894 (Standard Media Version) PA1894XP (Extreme Performance Nano Version) PA2749 (with Boot and Bail Handle)



PA1894 Outer Air Element
Fits: Caterpillar, Dresser, Euclid, Ingersoll-Rand, Kawasaki, Michigan, Steiger, Terex, Volvo, Wabco Equipment
Use With: PA1905
Replaces: Caterpillar 8L5897; Euclid 9035866; Gardner Denver 166392; Terex 9035992
O.D.: 13 13/16 (350.8)
I.D.: 15/16 (23.8) & 9 1/2 (241.3)
Height: 18 1/2 (469.9)
A. Gskt: [1] Attached
F. Gskt: [1] Included
Related To: LL1894 (Long-Life Media Version) PA1894XP (Extreme Performance Nano Version) PA2749 (with Boot and Bail Handle)



PA1894XP Extreme Performance Nano Outer Air Element
Fits: Caterpillar, Dresser, Euclid, Ingersoll-Rand, Kawasaki, Michigan, Steiger, Terex, Volvo, Wabco Equipment
Use With: PA1905
Replaces: Caterpillar 8L5897; Euclid 9035866; Gardner Denver 166392; Terex 9035992
O.D.: 13 13/16 (350.8)
I.D.: 15/16 (23.8) & 9 1/2 (241.3)
Height: 18 1/2 (469.9)
A. Gskt: [1] Attached
F. Gskt: [1] Included
Related To: LL1894 (Long-Life Media Version) PA1894 (Standard Media Version) PA2749 (with Boot and Bail Handle)



LL1895 Long Life Outer Air Element
Fits: Euclid, Michigan, Poclain, Steiger, Terex, Vermeer Equipment
Use With: PA1906
Replaces: Clark 1564734; Euclid 4005113; Steiger 45-213; Terex 4001155
O.D.: 10 7/32 (259.6)
I.D.: 15/16 (23.8) & 6 1/16 (154.0)
Height: 14 1/2 (368.3)
A. Gskt: [1] Attached
F. Gskt: [1] Included
Related To: PA1895 (Standard Media Version)



PA1895 Outer Air Element
Fits: Euclid, Michigan, Poclain, Steiger, Terex, Vermeer Equipment
Use With: PA1906
Replaces: Clark 1564734; Euclid 4005113; Steiger 45-213; Terex 4001155
O.D.: 10 7/32 (259.6)
I.D.: 15/16 (23.8) & 6 1/16 (154.0)
Height: 14 1/2 (368.3)
A. Gskt: [1] Attached
F. Gskt: [1] Included
Related To: LL1895 (Long-Life Media Version)



PA1896 Air Element
Replaces: GMC 6487818
O.D.: 13 13/16 (350.8)
I.D.: 1/2 (12.7) & 9 1/2 (241.3)
Height: 8 7/8 (225.4)
A. Gskt: [1] Attached
F. Gskt: [1] Included



Measurements Are Shown In Inches And (Millimeters)

WARNING: These products can expose you to chemicals, including Diisononyl Phthalate, Carbon black extracts, Nickel, 1,3 Butadiene, Ethylene Oxide, Epichlorohydrin, which are known to the State of California to cause cancer, and Bisphenol, Ethylene Glycol, Ethylene Oxide, 1,3 Butadiene, Epichlorohydrin, which are known to the State of California to cause birth defects or other reproductive harm. For more information go to www.P65Warnings.ca.gov.

PA1897



Inner Air Element

Fits Inside: PA1898
Fits: International Wheel Tractors
Replaces: International 398519-R91
O.D.: 4 1/8 (104.8)
I.D.: 13/32 (10.3) & 3 (76.2)
Height: 14 5/8 (371.5)
A. Gskt: [1] Attached
F. Gskt: [1] Included, [1] Wing Nut

PA1898



Outer Air Element with Bail Handle

Fits: International Wheel Tractors
Use With: PA1897
Replaces: International 401270-R1
O.D.: 6 5/8 (168.3)
 Flange Gasket 6 7/8 (174.6)
I.D.: 4 1/4 (108.0) One End
Height: 15 7/16 (392.1)
A. Gskt: [1] Attached

PA1899



Inner Air Element

Fits Inside: PA1900
Fits: Elgin Sweepers; International Wheel Tractors
Replaces: International 398513-R91
O.D.: 4 1/8 (104.8)
I.D.: 13/32 (10.3) & 3 1/16 (77.8)
Height: 12 1/4 (311.2)
A. Gskt: [1] Attached
F. Gskt: [1] Included, [1] Wing Nut

PA1900



Outer Air Element with Bail Handle

Fits: Elgin Sweepers; International Wheel Tractors
Use With: PA1899
Replaces: International 401269-R1
O.D.: 6 5/8 (168.3)
 Flange Gasket 6 7/8 (174.6)
I.D.: 4 1/4 (108.0) One End
Height: 12 7/8 (327.0)
A. Gskt: [2] Attached

PA1901



Air Element

Fits: Mercedes-Benz, Porsche Automotive; Akerman Excavators; Volvo Loaders
Replaces: Volvo 7820580
O.D.: 6 (152.4)
I.D.: 3 1/2 (88.9)
Height: 8 5/8 (219.1)

LL1902-FN



Long Life Outer Air Element with Fins

Fits: Mercedes-Benz Trucks; Akerman, Allis Chalmers, Case, Daewoo, Dynapac, John Deere, Kawasaki, Komatsu, Michigan, White Equipment
Use With: PA1912, PA1981, PA1982
Replaces: Allis Chalmers 666432; Case R36360; Daewoo 24749020; John Deere AR45784
O.D.: 7 15/16 (201.6)
 Fins 10 (254.0)
I.D.: 11/16 (17.5) & 5 3/8 (136.5)
Height: 16 5/16 (414.3)
A. Gskt: [1] Attached
F. Gskt: G103-N
Related To: PA1902-FN (Standard Media Version)

PA1902-FN



Outer Air Element with Fins

Fits: Mercedes-Benz Trucks; Akerman, Allis Chalmers, Case, Daewoo, Dynapac, John Deere, Kawasaki, Komatsu, Michigan, White Equipment
Use With: PA1912, PA1981, PA1982
Replaces: Allis Chalmers 666432; Case R36360; Daewoo 24749020; John Deere AR45784
O.D.: 7 15/16 (201.6)
 Fins 10 (254.0)
I.D.: 11/16 (17.5) & 5 3/8 (136.5)
Height: 16 5/16 (414.3)
A. Gskt: [1] Attached
F. Gskt: G103-N
Related To: LL1902-FN (Long-Life Media Version)

PA1904



Inner Air Element

Fits Inside: LL1886, PA1886, PA1886XP
Fits: Allis Chalmers, Case, Dresser, Drott, Euclid, Hough, International, John Deere, Liebherr, New Holland, Terex, Vermeer, Versatile Equipment
Replaces: Euclid 4003970; Gardner Denver 175246; International 619763-C91; Versatile 30927
O.D.: 7 5/8 (193.7)
I.D.: 7/8 (22.2) & 6 1/16 (154.0)
Height: 15 13/32 (391.3)
A. Gskt: [1] Attached
F. Gskt: [1] Included

PA1905



Inner Air Element

Fits Inside: LL1894, PA1894, PA1894XP, PA2749
Fits: Caterpillar, Dresser, Euclid, Hitachi, Michigan, Steiger, Volvo, WABCO Equipment
Replaces: Caterpillar 8L5897; Euclid 4005102; Hitachi 4206273; Steiger 45-253
O.D.: 8 5/8 (219.1)
I.D.: 15/16 (23.8) & 7 1/32 (178.6)
Height: 17 1/32 (432.6)
A. Gskt: [1] Attached
F. Gskt: G110-AF

Measurements Are Shown In Inches And (Millimeters)

WARNING: These products can expose you to chemicals, including Diisononyl Phthalate, Carbon black extracts, Nickel, 1,3 Butadiene, Ethylene Oxide, Epichlorohydrin, which are known to the State of California to cause cancer, and Bisphenol, Ethylene Glycol, Ethylene Oxide, 1,3 Butadiene, Epichlorohydrin, which are known to the State of California to cause birth defects or other reproductive harm. For more information go to www.P65Warnings.ca.gov.

PA1906

Inner Air Element



Fits Inside: LL1895, PA1895
Fits: Euclid, Michigan, Poclain, Steiger, Terex, Vermeer Equipment
Replaces: Euclid 4000823; Terex 9038408
O.D.: 5 15/16 (150.8)
I.D.: 15/16 (23.8) & 4 27/32 (123.0)
Height: 12 1/2 (317.5)
A. Gskt: [1] Attached
F. Gskt: [1] Included

PA1913

Air Element



Fits: Donaldson EDG130010 Housing
Replaces: FWD Corporation 10175493; Oshkosh 17230F
O.D.: 10 3/8 (263.5)
I.D.: 7 13/16 (198.4) One End
Height: 12 (304.8)
Related To: PA616, PA1701 ELE (Other Housings)

PA1907-FN

Outer Air Element with Fins



Fits: John Deere, Massey Ferguson Equipment
Use With: PA2535
Replaces: John Deere AM102746; Massey Ferguson 103262-M91
O.D.: 4 3/32 (104.0)
Fins: 5 1/8 (130.2)
I.D.: 25/32 (19.8) & 2 15/32 (62.7)
Height: 9 5/16 (236.5)
A. Gskt: [1] Attached
F. Gskt: G103-N

PA1915

Air Breather Element for Hydraulic Reservoir



Fits: Mack Electra Haul
Replaces: International 427781
O.D.: 2 15/16 (74.6)
I.D.: 1 15/16 (49.2)
Height: 2 3/16 (55.6)

PA1909

Air Breather Element



Fits: Bendix, Midland Air Compressors; GMC, International Trucks
Replaces: Bendix 100783; GMC 2457476; Midland 100696A
O.D.: 2 13/16 (71.4)
I.D.: 1 5/16 (33.3)
Height: 1 (25.4)

PA1916

Air Compressor Element



Fits: Ingersoll-Rand, Joy, Sullair Compressors
Replaces: Ingersoll-Rand 35104793; Joy 1224813; Sullair 40899
O.D.: 9 3/4 (247.7)
I.D.: 6 1/16 (154.0)
Height: 5 13/32 (137.3)

PA1911

Inner Air Element



Fits Inside: LL1884, PA1844, PA1884XP, PA2788, PA3629
Fits: Ag-Chem, Allis Chalmers, Case, Caterpillar, Clark, Daewoo, Fiat-Allis, Hitachi, International, J.C. Bamford, Kobelco, Komatsu, Massey Ferguson, Mitsubishi, New Holland, Steiger Equipment
Replaces: Allis Chalmers 3053290; Case P850561; Caterpillar 616582; Clark 1518700; Daewoo 24746025; International 530751-R1; Massey Ferguson 1495439-M91; Steiger 9003
O.D.: 4 19/32 (116.7)
Flange: 5 3/4 (146.1)
I.D.: 5/8 (15.9) & 3 7/16 (87.3)
Height: 13 (330.2)
A. Gskt: [1] Attached
F. Gskt: G103-N

PA1919-FN

Air Element with Fins



Fits: Allis Chalmers Tractors
Replaces: Allis Chalmers 2565687
O.D.: 7 15/16 (201.6)
Fins: 10 1/16 (255.6)
I.D.: 1/2 (12.7) & 3 9/16 (90.5)
Height: 9 3/8 (238.1)
A. Gskt: [1] Attached
F. Gskt: [1] Included

PA1912

Inner Air Element



Fits Inside: LL1902-FN, PA1902-FN, PA2523, PA2641, PA4650-FN
Fits: Allis Chalmers, Case, Daewoo, Dynapac, Kobelco, Komatsu, White Equipment; Cummins, Detroit Diesel, Deutz, Fiat, International Engines
Replaces: Allis Chalmers 3053289; Case R36360; White 31-2755077
O.D.: 4 9/16 (115.9)
Flange: 5 3/4 (146.1)
I.D.: 21/32 (16.7) & 3 7/16 (87.3)
Height: 15 21/32 (397.7)
A. Gskt: [1] Attached
F. Gskt: G103-N

PA1920

Air Element



Replaces: Autocar 6GT0330; Diamond Reo 10392-H2
O.D.: 12 1/32 (305.6)
I.D.: 5/8 (15.9) & 7 11/16 (195.3)
Height: 13 3/8 (339.7)
A. Gskt: [1] Attached
F. Gskt: G103-N

PA1921

Inner Air Element





Fits Inside: PA1794-FN
Fits: John Deere Equipment
Replaces: John Deere AT25219
O.D.: 4 3/32 (104.0)
I.D.: 25/32 (19.8) & 2 15/32 (62.7)
Height: 7 5/16 (185.7)
A. Gskt: [1] Attached
F. Gskt: G103-N

Measurements Are Shown In Inches And (Millimeters)

WARNING: These products can expose you to chemicals, including Diisononyl Phthalate, Carbon black extracts, Nickel, 1,3 Butadiene, Ethylene Oxide, Epichlorohydrin, which are known to the State of California to cause cancer, and Bisphenol, Ethylene Glycol, Ethylene Oxide, 1,3 Butadiene, Epichlorohydrin, which are known to the State of California to cause birth defects or other reproductive harm. For more information go to www.P65Warnings.ca.gov.

PA1922 Air Element

Replaces: Blue Bird 2105773
O.D.: 9 7/32 (234.2)
I.D.: 21/32 (16.7) & 4 27/32 (123.0)
Height: 8 5/16 (211.1)
A. Gskt: [1] Attached
F. Gskt: G103-N
Related To: PA1922-FN (with Fins)

PA1937 Inner Air Element

Fits Inside: PA1936
Fits: Dresser, Hough, International Equipment; Quincy Compressors
Replaces: International 702673-C1; Quincy 21099
O.D.: 7 3/8 (187.3)
I.D.: 3/4 (19.1) & 6 1/8 (155.6)
Height: 25 7/8 (657.2)
A. Gskt: [1] Attached
F. Gskt: G103-N

PA1922-FN Air Element with Fins

Fits: Caterpillar Engines; Chevrolet, Ford, GMC Buses, Trucks
Replaces: Caterpillar 7W7419; Ford C8HZ-9601-A; GMC 8994760
O.D.: 9 7/32 (234.2)
I.D.: 21/32 (16.7) & 4 27/32 (123.0)
Height: 8 5/16 (211.1)
A. Gskt: [1] Attached
F. Gskt: G103-N
Related To: PA1922 (without Fins)

PA1940 Air Element

Fits: Iveco Trucks; John Deere Tractors
Replaces: Iveco 1902040; John Deere AR46976
O.D.: 6 7/8 (174.6)
I.D.: 21/32 (16.7) & 3 1/2 (88.9)
Height: 14 3/8 (365.1)
A. Gskt: [1] Attached
F. Gskt: G103-N

PA1926 Outer Air Element

Fits: John Deere Equipment
Use With: PA2413
Replaces: John Deere AR43605
O.D.: 6 7/8 (174.6)
I.D.: 3 1/2 (88.9) One End
Height: 12 3/8 (314.3)
A. Gskt: [1] Attached

PA1941-FN Outer Air Element with Fins

Fits: John Deere, Komatsu Equipment
Use With: PA1967
Replaces: John Deere AT27824; Komatsu 381-980-7031
O.D.: 9 7/32 (234.2)
I.D.: 21/32 (16.7) & 4 27/32 (123.0)
Height: 13 1/2 (342.9)
A. Gskt: [1] Attached
F. Gskt: G103-N
Related To: LL1884 , PA1874, PA1884XP (without Fins)

PA1932 Air Element

Replaces: Ford C8AZ-9601-C
O.D.: 9 7/32 (234.2)
I.D.: 21/32 (16.7) & 4 27/32 (123.0)
Height: 11 1/2 (292.1)
A. Gskt: [1] Attached
F. Gskt: G103-N

PA1945 Air Element with Lift Bar

Fits: International Wheel Tractors
Replaces: International 403889-R1
O.D.: 5 1/4 (133.4)
I.D.: 2 1/4 (57.2) One End
Height: 10 13/16 (274.6)
A. Gskt: [1] Attached

PA1934 Air Element

Fits: Joy Compressors; Perkins Engines
Replaces: Joy 1222940
O.D.: 7 7/8 (200.0)
I.D.: 6 1/8 (155.6)
Height: 8 1/32 (204.0)

PA1946 Air Element

Fits: WABCO AVC Compressors
Replaces: WABCO H43-534
O.D.: 4 3/16 (106.4)
I.D.: 1 15/16 (49.2)
Height: 5 3/4 (146.1)

PA1936 Outer Air Element

Fits: Dresser, Hough, International Equipment; Quincy Compressors
Use With: PA1937
Replaces: International 702672-C1; Quincy 21098
O.D.: 12 1/2 (317.5)
I.D.: 3/4 (19.1) & 7 1/2 (190.5)
Height: 27 1/2 (698.5)
A. Gskt: [1] Attached
F. Gskt: [1] Included

PA1949 Air Element

Fits: Joy, Sullair Compressors
Replaces: Sullair 40186
O.D.: 7 7/8 (200.0)
I.D.: 4 1/8 (104.8)
Height: 4 (101.6)

Measurements Are Shown In Inches And (Millimeters)

 **WARNING:** These products can expose you to chemicals, including Diisononyl Phthalate, Carbon black extracts, Nickel, 1,3 Butadiene, Ethylene Oxide, Epichlorohydrin, which are known to the State of California to cause cancer, and Bisphenol, Ethylene Glycol, Ethylene Oxide, 1,3 Butadiene, Epichlorohydrin, which are known to the State of California to cause birth defects or other reproductive harm. For more information go to www.P65Warnings.ca.gov.

PA1951

Air Element



Replaces: Joy 543048
O.D.: 5 11/16 (144.5)
I.D.: 2 (50.8)
Height: 3 1/4 (82.6)

PA1952

Air Element



Fits: Joy, Sullair Compressors
Replaces: Joy 1225150; Sullair 40406
O.D.: 12 1/16 (306.4)
I.D.: 3/8 (9.5) & 6 3/32 (154.8)
Height: 21 1/16 (535.0)
A. Gskt: [1] Attached
F. Gskt: [1] Included

PA1953

Air Element



Fits: Air Maze Housings; Joy Compressors
Replaces: Air Maze CD1623503-826
O.D.: 12 1/16 (306.4)
I.D.: 3/8 (9.5) & 6 3/32 (154.8)
Height: 21 1/16 (535.0)
A. Gskt: [1] Attached
F. Gskt: [1] Included

PA1956-FN

Outer Air Element with Fins



Fits: Case Loaders
Use With: PA1957
Replaces: Case L32512
O.D.: 11 1/8 (282.6)
Fins 13 3/4 (349.3)
I.D.: 5/8 (15.9) & 6 3/4 (171.5)
Height: 9 3/8 (238.1)
A. Gskt: [1] Attached
F. Gskt: G103-N

PA1957

Inner Air Element



Fits Inside: PA1956-FN
Fits: Case Loaders
Replaces: Case L32513
O.D.: 6 3/8 (161.9)
Flange Gasket 7 1/2 (190.5)
I.D.: 5/8 (15.9) & 5 1/4 (133.4)
Height: 9 (228.6)
A. Gskt: [1] Attached
F. Gskt: G103-N

PA1960

Panel Air Element

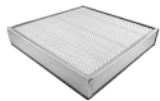

Notes: Sometimes used as Cab Air on John Deere Combines.
Fits: Caterpillar Engines, Equipment; John Deere Combines
Replaces: Caterpillar 6L8485
Length: 15 (381.0)
Width: 15 (381.0)
Height: 2 9/16 (65.1)
A. Gskt: [1] Attached

PA1961

Cab Air Element

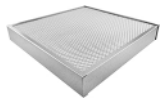

Fits: Allis Chalmers, John Deere Equipment
Replaces: John Deere AH66302
Length: 15 (381.0)
Width: 15 (381.0)
Height: 2 3/16 (55.6)

PA1963

Air Element



Contains: Flame Retardant Media
Fits: Datsun Lift Trucks
Replaces: Nissan 16546-48200
O.D.: 6 5/16 (160.3)
I.D.: 3 11/16 (93.7)
Height: 5 (127.0)
O. Gskt: [2] G120-A

PA1967

Inner Air Element



Fits Inside: PA1941-FN, PA2304-FN, PA2351, PA2421
Fits: Agco, Case, John Deere, Massey Ferguson, Vermeer, White Equipment
Replaces: Agco 72163296; Case A47136; John Deere AT34895; Massey Ferguson 3385734-M1; Vermeer 100489009; White 168698-AS
O.D.: 4 9/16 (115.9)
I.D.: 21/32 (16.7) & 3 7/16 (87.3)
Height: 11 1/4 (285.8)
A. Gskt: [1] Attached
F. Gskt: G103-N

PA1969

Air Element



Fits: Davis, Ditch Witch, International, John Deere, New Holland Equipment; Wisconsin Engines
Replaces: Ditch Witch 195352; International 405716-R1; Wisconsin LO185
O.D.: 4 3/16 (106.4)
I.D.: 1 15/16 (49.2)
Height: 6 1/8 (155.6)

PA1972

Air Element



Fits: International Equipment; Iveco Trucks
Replaces: International 529373-R1
O.D.: 6 7/8 (174.6)
I.D.: 21/32 (16.7) & 3 1/2 (88.9)
Height: 14 3/8 (365.1)
A. Gskt: [1] Attached
F. Gskt: G103-N

PA1973

Air Element



Contains: Flame Retardant Media
Fits: Datsun, Nissan, TCM Lift Trucks
Replaces: Nissan 16546-19900; TCM 20801-03121
O.D.: 5 23/32 (145.3)
I.D.: 3 1/16 (77.8)
Height: 3 1/8 (79.4)

PA1975

Outer Air Element



Fits: Case, Dresser, New Holland, Steiger, Versatile Tractors
Use With: PA1976, PA2672
Replaces: Steiger 13-898; Versatile 63971
O.D.: 13 13/16 (350.8)
I.D.: 15/16 (23.8) & 9 1/2 (241.3)
Height: 22 1/2 (571.5)
A. Gskt: [1] Attached
F. Gskt: [1] Included
O. Gskt: G285-AF
Related To: PA2675 (with Boot)

Measurements Are Shown In Inches And (Millimeters)

WARNING: These products can expose you to chemicals, including Diisononyl Phthalate, Carbon black extracts, Nickel, 1,3 Butadiene, Ethylene Oxide, Epichlorohydrin, which are known to the State of California to cause cancer, and Bisphenol, Ethylene Glycol, Ethylene Oxide, 1,3 Butadiene, Epichlorohydrin, which are known to the State of California to cause birth defects or other reproductive harm. For more information go to www.P65Warnings.ca.gov.

PA1976



Inner Air Element

Fits Inside: PA1975, PA2675
Fits: Allis Chalmers, Dresser, Euclid, Fiat Allis, Terex Equipment
Replaces: Allis Chalmers 70690304; Fiat Allis 70686821; Terex 9036293
O.D.: 8 5/8 (219.1)
I.D.: 15/16 (23.8) & 7 1/16 (179.4)
Height: 21 1/32 (534.2)
A. Gskt: [1] Attached
F. Gskt: [1] Included

PA1982



Inner Air Element

Fits Inside: LL1902-FN, PA1902-FN, PA1989-FN
Fits: Case, John Deere Equipment
Replaces: Case A62255; John Deere AR45785
O.D.: 5 1/4 (133.4)
I.D.: 5/8 (15.9) & 4 1/8 (104.8)
Height: 11 1/4 (285.8)
A. Gskt: [1] Attached
F. Gskt: G103-N

PA1977-FN



Air Element with Fins

Fits: Ford Buses, Trucks
Replaces: Ford D0HZ-9601-B
O.D.: 11 1/8 (282.6)
 Fins 13 3/4 (349.3)
I.D.: 5/8 (15.9) & 6 3/4 (171.5)
Height: 10 3/8 (263.5)
A. Gskt: [1] Attached
F. Gskt: G103-N

PA1985



Air Element

Fits: Jay Tamper; Wacker Equipment
Replaces: Wacker 2-5308
O.D.: 3 (76.2)
I.D.: 1 5/8 (41.3)
Height: 3 (76.2)

PA1978-FN



Air Element with Fins

Fits: Ford Trucks
Replaces: Ford D0HZ-9601-C
O.D.: 11 1/8 (282.6)
 Fins 13 3/4 (349.3)
I.D.: 5/8 (15.9) & 6 3/4 (171.5)
Height: 14 3/8 (365.1)
A. Gskt: [1] Attached
F. Gskt: G103-N

PA1986



Air Element

Fits: Ford Trucks
Replaces: Motorcraft FA1008
O.D.: 9 1/16 (230.2)
I.D.: 4 15/16 (125.4)
Height: 10 5/16 (261.9)
A. Gskt: [2] Included
F. Gskt: G39-AF

PA1979-FN



Outer Air Element with Fins

Fits: Ford Trucks
Use With: PA1893
Replaces: Ford D0HZ-9601-A
O.D.: 11 1/8 (282.6)
 Fins 13 3/4 (349.3)
I.D.: 5/8 (15.9) & 6 3/4 (171.5)
Height: 16 3/8 (415.9)
A. Gskt: [1] Attached
F. Gskt: G103-N

PA1986-K



Air Element with Reusable Lid-Fin Assembly

Replaces: Motorcraft FA1008
O.D.: 9 1/16 (230.2)
 Lid 12 3/8 (314.3)
I.D.: 3/8 (9.5) & 4 15/16 (125.4)
Height: 10 3/8 (263.5)
A. Gskt: [2] Attached
F. Gskt: G39-AF
Related To: PA1986 (Filter only)

PA1980-FN



Air Element with Fins

Fits: Ford Buses, Trucks
Use With: PA30026
Replaces: Ford D0HZ-9601-F
O.D.: 12 (304.8)
 Fins 15 3/4 (400.1)
I.D.: 5/8 (15.9) & 7 11/16 (195.3)
Height: 10 3/8 (263.5)
A. Gskt: [1] Attached
F. Gskt: G103-N

PA1987



Air Element

Replaces: Wix 42773
O.D.: 9 1/16 (230.2)
I.D.: 4 15/16 (125.4)
Height: 9 5/16 (236.5)
A. Gskt: [2] Attached
F. Gskt: G39-AF

PA1981



Inner Air Element

Fits Inside: LL1902-FN, PA1902-FN, PA3675, PA3849
Fits: Fiat-Allis, International, John Deere, Liebherr, Oliver, White Equipment
Replaces: International 920803-C91; John Deere T46317; White 166277-AS
O.D.: 4 9/16 (115.9)
I.D.: 21/32 (16.7) & 3 7/16 (87.3)
Height: 15 3/8 (390.5)
A. Gskt: [1] Attached
F. Gskt: G103-N

PA1989-FN



Outer Air Element with Fins

Fits: Case Tractors
Use With: PA1982
Replaces: Case A43264
O.D.: 7 15/16 (201.6)
 Fins 10 1/16 (255.6)
I.D.: 11/16 (17.5) & 5 3/8 (136.5)
Height: 13 1/4 (336.6)
A. Gskt: [1] Attached
F. Gskt: G103-N

Measurements Are Shown In Inches And (Millimeters)

WARNING: These products can expose you to chemicals, including Diisononyl Phthalate, Carbon black extracts, Nickel, 1,3 Butadiene, Ethylene Oxide, Epichlorohydrin, which are known to the State of California to cause cancer, and Bisphenol, Ethylene Glycol, Ethylene Oxide, 1,3 Butadiene, Epichlorohydrin, which are known to the State of California to cause birth defects or other reproductive harm. For more information go to www.P65Warnings.ca.gov.

LL1992



Long Life Air Element

Fits: Ford Trucks
Replaces: Ford D5HZ-9601-B
O.D.: 12 1/32 (305.6)
I.D.: 5/8 (15.9) & 7 11/16 (195.3)
Height: 16 3/8 (415.9)
A. Gskt: [1] Attached
F. Gskt: G103-N

PA2001



Air Element

Fits: Atlas Copco Compressors;
 Petter Engines
Use With: PA2001 FOAM
Replaces: Atlas Copco 16191269;
 Petter CF4223LT
O.D.: 5 1/2 (139.7)
I.D.: 3 1/4 (82.6)
Height: 4 23/32 (119.9)

PA1992-FN



Air Element with Fins

Replaces: International 407172-C91;
 White 27-074987
O.D.: 12 1/32 (305.6)
 Fins 15 3/4 (400.1)
I.D.: 5/8 (15.9) & 7 11/16 (195.3)
Height: 16 3/8 (415.9)
A. Gskt: [1] Attached
F. Gskt: G103-N

PA2001 FOAM



Foam Blanket for PA2001

Use With: PA2001
Length: 17 1/8 (435.0)
Width: 4 1/2 (114.3)
Height: 1/2 (12.7)

PA1995



Outer Air Element with Bail Handles and Lid

Fits: John Deere Tractors
Use With: PA1996
Replaces: John Deere AR51431
O.D.: 13 7/8 (352.4)
 Lid 15 1/16 (382.6)
I.D.: 11/16 (17.5) & 7 7/16 (188.9)
Height: 7 1/4 (184.2)
A. Gskt: [2] Attached
F. Gskt: G103-N

PA2002



Air Element

Fits: Ford Automotive, Light-Duty Trucks,
 Vans
Replaces: Ford E4TE-9601-EA
O.D.: 13 9/32 (337.3)
I.D.: 11 9/32 (286.5)
Height: 2 25/32 (70.6)

PA1996



Inner Air Element

Fits Inside: PA1995, PA2343
Fits: Case, John Deere, Oliver, White
 Equipment
Replaces: Case A44186; John Deere AR53502,
 AR64624
O.D.: 6 7/8 (174.6)
I.D.: 5/8 (15.9) & 4 3/16 (106.4)
Height: 6 3/16 (157.2)
A. Gskt: [1] Attached
F. Gskt: G103-N

PA2005



Air Element

Fits: Ford Automotive, Light-Duty Trucks
Replaces: Ford E4ZE-9601-AA
O.D.: 10 7/8 (276.2)
I.D.: 9 (228.6)
Height: 2 3/16 (55.6)

PA2006



Air Element

Fits: GM Automotive, Light-Duty Trucks
Replaces: GMC 6484963
O.D.: 11 13/16 (300.0)
I.D.: 9 13/16 (249.2)
Height: 2 1/2 (63.5)

PA1997



Outer Air Element

Fits: Massey Ferguson, Minneapolis-Moline,
 Oliver Equipment
Use With: PA1998, PA2469
Replaces: Massey Ferguson 1038944-M91
O.D.: 7 5/8 (193.7)
 Boot 8 5/8 (219.1)
I.D.: 4 1/4 (108.0) One End
Height: 16 3/8 (415.9)
A. Gskt: [1] Attached

PA2007



Air Element

Fits: GM Automotive
Replaces: GMC 6484294
O.D.: 10 3/4 (273.1)
I.D.: 8 5/8 (219.1)
Height: 2 9/16 (65.1)

PA2008



Air Element

Fits: GM Automotive, Light-Duty Trucks, Vans
Replaces: GMC 6484235
O.D.: 11 13/16 (300.0)
I.D.: 9 13/16 (249.2)
Height: 3 15/32 (88.1)

PA1998



Inner Air Element

Fits Inside: PA1997, PA2495, PA2523
Fits: Massey Ferguson, Minneapolis-Moline,
 Oliver, White Equipment
Replaces: Massey Ferguson 1038945-M91;
 White 20-7000316
O.D.: 4 1/8 (104.8)
 Flange 4 5/8 (117.5)
I.D.: 25/32 (19.8) & 3 11/16 (93.7)
Height: 14 27/32 (377.0)
A. Gskt: [1] Attached
F. Gskt: G103-N

PA2009



Air Element

Fits: Cadillac Automotive
Replaces: GMC 6483644
O.D.: 12 5/16 (312.7)
I.D.: 10 13/16 (274.6)
Height: 2 5/8 (66.7)

Measurements Are Shown In Inches And (Millimeters)

WARNING: These products can expose you to chemicals, including Diisononyl Phthalate, Carbon black extracts, Nickel, 1,3 Butadiene, Ethylene Oxide, Epichlorohydrin, which are known to the State of California to cause cancer, and Bisphenol, Ethylene Glycol, Ethylene Oxide, 1,3 Butadiene, Epichlorohydrin, which are known to the State of California to cause birth defects or other reproductive harm. For more information go to www.P65Warnings.ca.gov.

<p>PA2010 Air Element Fits: Chrysler Automotive, Light-Duty Trucks, Vans Replaces: Chrysler 2863349; Ford E3ZZ-9601-B O.D.: 12 3/4 (323.9) I.D.: 11 (279.4) Height: 2 3/4 (69.9)</p> 	<p>SA2039 Crankcase Breather Filter in Plastic Housing Contains: 9/16 Inch Fitting [1] Metal Clip Fits: Ford Automotive, Light-Duty Trucks, Vans Replaces: Ford D1AZ-6D695-A Length: 3 15/16 (100.0) Width: 1 23/32 (43.7)</p> 
<p>PA2023 Air Element Fits: Porsche, Saab Automotive Replaces: Saab-Scania 800181 O.D.: 6 7/32 (158.0) I.D.: 4 27/32 (123.0) Height: 3 1/32 (77.0)</p> 	<p>PA2041 Panel Air Element Fits: Geo, Toyota Automotive Replaces: GMC 25098522; Toyota 17801-74020 Length: 12 5/32 (308.8) Width: 6 1/8 (155.6) Height: 1 21/32 (42.1)</p> 
<p>PA2024 Air Element Fits: Ford Automotive, Light-Duty Trucks Replaces: Ford D0GY-9601-A O.D.: 13 (330.2) I.D.: 11 9/32 (286.5) Height: 2 1/2 (63.5)</p> 	<p>PA2042 Air Element Fits: Toyota Automotive, Light-Duty Trucks Replaces: Toyota 17801-60040 O.D.: 8 29/32 (226.2) I.D.: 4 9/32 (108.7) Height: 5 23/32 (145.3)</p> 
<p>SA2027 Poly Foam Oil Vapor Emission Filter Fits: GM Automotive, Light-Duty Trucks, Vans Replaces: GMC 6484966 Width: 1 25/32 (45.2) Height: 1 5/8 (41.3)</p> 	<p>PA2044 Air Element Fits: BMW Motorcycles Replaces: BMW 13721254382 O.D.: 5 1/16 (128.6) I.D.: 3 1/16 (77.8) Height: 4 1/2 (114.3)</p> 
<p>PA2031 Air Element Fits: Mazda, Nissan, Subaru Automotive; Nissan, TCM Lift Trucks Replaces: Nissan 16546-18000; Subaru 42145-4110; TCM 16546-L3200 O.D.: 9 (228.6) I.D.: 6 7/8 (174.6) Height: 1 15/16 (49.2)</p> 	<p>SA2047 Crankcase Breather Filter in Plastic Housing Contains: 5/8 Inch Fitting Fits: Ford Light-Duty Trucks, Vans Replaces: Ford F4TZ-9D695-A Width: 2 5/8 (66.7) Height: 1 1/4 (31.8)</p> 
<p>PA2036 Air Element O.D.: 6 11/16 (169.9) I.D.: 4 15/16 (125.4) Height: 2 3/8 (60.3)</p> 	<p>PA2050 Air Element Replaces: Imperial Machine Products FI-5 O.D.: 6 5/8 (168.3) I.D.: 5 (127.0) Height: 2 1/16 (52.4)</p> 
<p>PA2037 Air Element Fits: Toyota Automotive Replaces: Toyota 17801-22010 O.D.: 7 7/16 (188.9) I.D.: 4 9/32 (108.7) Height: 2 3/4 (69.9)</p> 	<p>PA2051 Air Element Fits: Ford Automotive, Light-Duty Trucks, Vans Replaces: Ford D2AZ-9601-A O.D.: 11 3/16 (284.2) I.D.: 9 1/16 (230.2) Height: 2 11/16 (68.3)</p> 
<p>PA2038 Air Element with Wire Reinforced Media Fits: Ingersoll-Rand Compressors Replaces: Ingersoll-Rand 32012957 O.D.: 4 13/32 (111.9) I.D.: 3 1/32 (77.0) Height: 4 25/32 (121.4)</p> 	<p>PA2052 Air Element Fits: Dodge, Plymouth Light-Duty Trucks, Vans Replaces: Chrysler 3614353; GMC 6487801 O.D.: 10 7/8 (276.2) I.D.: 9 (228.6) Height: 3 17/32 (89.7)</p> 

Measurements Are Shown In Inches And (Millimeters)

 **WARNING:** These products can expose you to chemicals, including Diisononyl Phthalate, Carbon black extracts, Nickel, 1,3 Butadiene, Ethylene Oxide, Epichlorohydrin, which are known to the State of California to cause cancer, and Bisphenol, Ethylene Glycol, Ethylene Oxide, 1,3 Butadiene, Epichlorohydrin, which are known to the State of California to cause birth defects or other reproductive harm. For more information go to www.P65Warnings.ca.gov.

PA2053 Air Element
Fits: GM Automotive
Replaces: GMC 7988027
O.D.: 5 3/4 (146.1)
I.D.: 3 1/2 (88.9)
Height: 2 5/32 (54.8)



PA2061 Air Element
Fits: International Trucks
Replaces: International 446661-C1, 446910-C1
O.D.: 12 5/8 (320.7)
I.D.: 9 3/4 (247.7)
Height: 5 (127.0)



PA2063 Air Element
Fits: John Deere Lawn & Garden Equipment; New Holland Loaders; Onan Engines
Replaces: John Deere AM106953; Onan 140-2628
O.D.: 7 29/32 (200.8)
I.D.: 6 1/2 (165.1)
Height: 2 1/8 (54.0)



PA2064 Air Element
Fits: Bolens, Ford, Husky, Hustler, Jacobsen Lawn & Garden Tractors, Mowers; Kohler Engines
Replaces: Kohler 277138
O.D.: 6 (152.4)
I.D.: 4 5/8 (117.5)
Height: 4 1/16 (103.2)
Related To: PA2067 (Short Version)



PA2065 Air Element
Fits: BMW, Toyota Automotive, Light-Duty Trucks
Replaces: Toyota 17801-41060
O.D.: 12 7/16 (315.9)
I.D.: 9 3/8 (238.1)
Height: 2 (50.8)



PA2067 Air Element
Fits: Allis Chalmers, Ariens, Case, Cub Cadet, Ford, Jacobsen, Power King, Simplicity Lawn & Garden Mowers, Tractors; Kohler, Onan Engines
Use With: PA2067 FOAM
Replaces: Allis Chalmers 2067783; Kohler 4508302; Onan 140-1216
O.D.: 6 (152.4)
I.D.: 4 5/8 (117.5)
Height: 3 1/8 (79.4)
Related To: PA2064 (Long Version)



PA2067 FOAM Foam Blanket for PA2067
Use With: PA2067
O.D.: 6 5/32 (156.4)
I.D.: 5 11/16 (144.5)
Height: 2 27/32 (72.2)



PA2068 Air Element
Fits: Allis Chalmers, Cub Cadet, Dixon, Ford, Power King Lawn & Garden Mowers, Tractors; International Wheel Tractors; Kohler Engines
Use With: PA2068 FOAM
Replaces: International 117210-C1; Kohler 4708301
O.D.: 7 (177.8)
I.D.: 5 9/16 (141.3)
Height: 1 25/32 (45.2)
Related To: PA2069 (Long Version)



PA2068 FOAM Foam Blanket for PA2068
Use With: PA2068
O.D.: 6 23/32 (170.7)
I.D.: 6 7/32 (158.0)
Height: 1 25/32 (45.2)



PA2069 Air Element
Fits: Bolens, Cub Cadet, Ford, John Deere Lawn & Garden Tractors; Kohler Engines
Use With: PA2069 FOAM
Replaces: John Deere M47494; Kohler 4708303
O.D.: 7 (177.8)
I.D.: 5 9/16 (141.3)
Height: 2 15/32 (62.7)
Related To: PA2068 (Short Version)



PA2069 FOAM Foam Blanket for PA2069
Use With: PA2069
O.D.: 6 5/8 (168.3)
I.D.: 6 7/32 (158.0)
Height: 2 3/16 (55.6)



PA2070 Air Element
Replaces: Atlas Copco 1503-0188
O.D.: 5 5/32 (131.0)
I.D.: 3 3/8 (85.7)
Height: 1 13/32 (35.7)
Related To: PA2071 (Long Version)



PA2071 Air Element
Fits: Atlas Copco Compressors
Replaces: Atlas Copco 1503-0189
O.D.: 5 5/32 (131.0)
I.D.: 3 3/8 (85.7)
Height: 1 15/16 (49.2)
Related To: PA2070 (Short Version)



PA2072 Air Element
Fits: Atlas Copco Compressors
Replaces: Atlas Copco 1503-0190
O.D.: 5 31/32 (151.6)
I.D.: 3 15/32 (88.1)
Height: 2 25/32 (70.6)



PA2073 Air Element with Foam Wrap
Fits: GMC Light-Duty Trucks, Vans
Replaces: GMC 8996118
O.D.: 13 7/8 (352.4)
I.D.: 11 5/8 (295.3)
Height: 4 (101.6)
Related To: PA2079 (without Foam Wrap)



PA2074 Air Element
Fits: Ford Automotive, Light-Duty Trucks
Replaces: Ford D7FZ-9601-A
O.D.: 11 7/32 (285.0)
I.D.: 9 3/8 (238.1)
Height: 1 23/32 (45.2)



PA2075 Air Element
Fits: Ford, Honda, Mazda Automotive, Light-Duty Trucks
Replaces: Ford D7ZZ-9601-A; Honda 17220-PC2611
O.D.: 11 3/32 (281.8)
I.D.: 8 1/2 (215.9)
Height: 2 3/16 (55.6)



Measurements Are Shown In Inches And (Millimeters)

WARNING: These products can expose you to chemicals, including Diisononyl Phthalate, Carbon black extracts, Nickel, 1,3 Butadiene, Ethylene Oxide, Epichlorohydrin, which are known to the State of California to cause cancer, and Bisphenol, Ethylene Glycol, Ethylene Oxide, 1,3 Butadiene, Epichlorohydrin, which are known to the State of California to cause birth defects or other reproductive harm. For more information go to www.P65Warnings.ca.gov.

PA2076

Oblong Air Element



Fits: GM Automotive
Replaces: GMC 8996555
O.D.: 9 3/8 (238.1) to 10 9/16 (268.3)
I.D.: 7 7/8 (200.0) to 9 1/16 (230.2)
Height: 2 1/8 (54.0)

PA2077

Air Element



Fits: GM Automotive, Light-Duty Trucks, Vans
Replaces: GMC 8996587
O.D.: 10 1/32 (254.8)
I.D.: 8 17/32 (216.7)
Height: 2 1/4 (57.2)

PA2079

Air Element



Fits: GM Automotive, Light-Duty Trucks
Replaces: GMC 8997189
O.D.: 13 7/8 (352.4)
I.D.: 11 5/8 (295.3)
Height: 4 (101.6)
Related To: PA2073 (with Foam Wrap)

PA2081

Air Element



Fits: Mercedes-Benz Automotive
Replaces: Mercedes-Benz 10949504
O.D.: 11 5/16 (287.3)
I.D.: 8 17/32 (217.5)
Height: 3 3/8 (85.7)

PA2083

Air Element



Fits: Dodge, Plymouth Automotive
Replaces: Chrysler 5240668
O.D.: 4 13/32 (111.9)
I.D.: 2 15/16 (74.6)
Height: 5 3/4 (146.1)

SA2084

Crankcase Breather Filter in Plastic Housing



Fits: Ford Automotive, Light-Duty Trucks, Vans
Replaces: Ford D7FZ-9D695-A
Width: 1 13/32 (35.7)
Height: 2 7/8 (73.0)

SA2085

Crankcase Breather Filter in Plastic Housing



Contains: 1/2 Inch Fitting
[1] Metal Clip
Fits: Ford Automotive, Light-Duty Trucks, Vans
Replaces: Ford D8AZ-9D695-A
Width: 1 31/32 (50.0)
F. Gskt: [1] Foam Washer

PA2091

Air Element



Fits: GMC Light-Duty Trucks, Vans
Replaces: GMC 8997890
O.D.: 11 13/16 (300.0)
I.D.: 9 13/16 (249.2)
Height: 5 7/16 (138.1)
Related To: PA2148 (with Foam Wrap)

PA2092

Air Element



Fits: Ford, International Light-Duty Trucks, Vans
Replaces: Ford E7TZ-9600-A; International 446661-C2
O.D.: 11 7/16 (290.5)
I.D.: 8 5/8 (219.1)
Height: 5 (127.0)
Related To: PA2115 (with Foam Wrap)

PA2093

Oblong Air Element

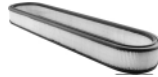

Replaces: Tecnicar A202
O.D.: 5 1/2 (139.7) to 24 1/4 (616.0)
I.D.: 4 1/16 (103.2) & 22 27/32 (580.2)
Height: 2 9/16 (65.1)

PA2094

Rectangular Air Element



Fits: Ferrari Automotive
Replaces: Ferrari 108545
O.D.: 12 3/8 (314.3) to 14 9/16 (369.9)
I.D.: 11 1/32 (281.0) & 13 1/4 (336.6)
Height: 2 1/8 (54.0)

PA2095

Air Element



Fits: Kellogg Compressors
Replaces: Kellogg 55669
O.D.: 9 3/4 (247.7)
I.D.: 7 1/4 (184.2)
Height: 4 (101.6)

PA2096

Air Element



Fits: Benford Equipment; Lister Engines
Replaces: Lister 366-6227; Rootes 5058925
O.D.: 5 19/32 (142.1)
I.D.: 4 (101.6)
Height: 2 15/32 (62.7)

PA2099

Air Element



Fits: Renault Automotive
Replaces: Renault 7701005514
O.D.: 4 31/32 (126.2)
I.D.: 3 11/32 (84.9)
Height: 6 11/16 (169.9)

PA2100

Air Element



Fits: Sullair Compressors
Replaces: Sullair 40187
O.D.: 8 1/32 (204.0)
I.D.: 5 5/16 (134.9)
Height: 4 3/16 (106.4)

PA2101A

Panel Air Element

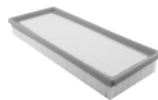

Fits: Audi, Chrysler, Eagle, Jeep Volkswagen Automotive, Light-Duty Trucks; Case-International, Liebherr Equipment; Volvo Trucks
Replaces: Chrysler 53006317; Volkswagen 34133837
Length: 13 3/16 (335.0)
Width: 5 11/32 (135.7)
Height: 1 21/32 (42.1)

Measurements Are Shown In Inches And (Millimeters)



WARNING: These products can expose you to chemicals, including Diisononyl Phthalate, Carbon black extracts, Nickel, 1,3 Butadiene, Ethylene Oxide, Epichlorohydrin, which are known to the State of California to cause cancer, and Bisphenol, Ethylene Glycol, Ethylene Oxide, 1,3 Butadiene, Epichlorohydrin, which are known to the State of California to cause birth defects or other reproductive harm. For more information go to www.P65Warnings.ca.gov.

PA2102 Air Element
Contains: Flame Retardant Media
Replaces: Impco F1-15
O.D.: 6 7/8 (174.6)
I.D.: 5 1/8 (130.2)
Height: 5 13/16 (147.6)
Related To: PA1653 (for Compressor Air)



PA2115 Air Element with Foam Wrap
Fits: Ford Light-Duty Trucks, Vans
Replaces: Ford E3TZ-9601-C
O.D.: 11 7/16 (290.5)
I.D.: 8 5/8 (219.1)
Height: 5 (127.0)
Related To: PA2092 (without Foam Wrap)



PA2103 Panel Air Element
Fits: Audi, Chrysler, Ford, Volkswagen Automotive, Light-Duty Trucks
Replaces: Chrysler 4342800; Ford E59Z-9601-A; Volkswagen 49133843
Length: 10 3/4 (273.1)
Width: 5 1/4 (133.4)
Height: 1 19/32 (40.5)

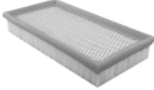

PA2116 Air Element
Fits: International Buses, Trucks
Replaces: International 588213-C1
O.D.: 11 7/16 (290.5)
I.D.: 8 5/8 (219.1)
Height: 7 (177.8)



PA2104 Panel Air Element
Fits: Chrysler Automotive, Light-Duty Trucks, Vans
Replaces: Chrysler 4227087, 4306113, 4342801
Length: 8 1/16 (204.8)
Width: 5 1/4 (133.4)
Height: 1 5/8 (41.3)



PA2117 Air Element
Fits: Chrysler, Mitsubishi Light-Duty Trucks
Replaces: Chrysler MD604880
O.D.: 10 1/4 (260.4)
I.D.: 8 (203.2)
Height: 2 7/16 (61.9)



PA2106 Air Element
Fits: GMC, Isuzu Automotive, Light-Duty Trucks
Replaces: GMC 25040929; Isuzu 8-25040-929-0
O.D.: 9 11/16 (246.1)
I.D.: 8 3/16 (208.0)
Height: 2 13/16 (71.4)
Related To: PA4135 (with Foam Wrap)



PA2121 Panel Air Element
Fits: Nissan, Subaru Automotive
Replaces: Nissan 16546-N4200; Subaru SOA51-65101
Length: 10 5/8 (269.9)
Width: 6 3/32 (154.8)
Height: 1 3/8 (34.9)

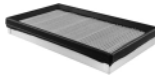

PA2107 Air Element with Foam Wrap
Fits: Ford Light-Duty Trucks, Vans
Replaces: Ford E0TZ-9601-B
O.D.: 9 (228.6)
I.D.: 6 1/2 (165.1)
Height: 3 1/4 (82.6)
Related To: PA657 (without Foam Wrap)



PA2124 Air Element
Fits: Chevrolet, Toyota Automotive
Replaces: GMC 94840272; Toyota 17801-15010
O.D.: 11 17/32 (292.9)
I.D.: 8 3/4 (222.3)
Height: 1 19/32 (40.5)



PA2109 Air Element
Fits: GM Automotive, Light-Duty Trucks
Replaces: GMC 25040881
O.D.: 8 1/2 (215.9)
I.D.: 6 15/16 (176.2)
Height: 2 7/16 (61.9)

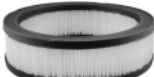

PA2125 Air Element
Fits: Toyota Automotive, Light-Duty Trucks, Lift Trucks
Replaces: Toyota 17801-25010, 17801-31010
O.D.: 9 23/32 (246.9)
I.D.: 6 7/8 (177.6)
Height: 2 1/4 (57.2)



PA2110 Air Element with Foam Wrap
Fits: GM Automotive
Replaces: GMC 25041208
O.D.: 13 7/8 (352.4)
I.D.: 11 5/8 (295.3)
Height: 2 5/8 (66.7)



PA2127 Panel Air Element
Fits: Ford, Mercury Automotive
Replaces: Ford E43Z-9601-C
Length: 7 7/8 (200.0)
Width: 7 (177.8)
Height: 1 19/32 (40.5)



PA2113 Air Element
Fits: GMC Light-Duty Trucks
Replaces: GMC 25041542
O.D.: 10 1/32 (254.8)
I.D.: 8 17/32 (216.7)
Height: 2 1/2 (63.5)



PA2134 Air Element
Fits: GM Automotive
Replaces: GMC 25043119
O.D.: 5 3/4 (146.1)
I.D.: 3 1/2 (88.9)
Height: 4 15/16 (125.4)



PA2114 Air Element
Fits: Ford Bronco, Ranger
Replaces: Ford E37E-9601-BB
O.D.: 9 11/16 (246.1)
I.D.: 7 15/16 (201.6)
Height: 2 3/32 (53.2)



Measurements Are Shown In Inches And (Millimeters)

WARNING: These products can expose you to chemicals, including Diisononyl Phthalate, Carbon black extracts, Nickel, 1,3 Butadiene, Ethylene Oxide, Epichlorohydrin, which are known to the State of California to cause cancer, and Bisphenol, Ethylene Glycol, Ethylene Oxide, 1,3 Butadiene, Epichlorohydrin, which are known to the State of California to cause birth defects or other reproductive harm. For more information go to www.P65Warnings.ca.gov.

PA2135

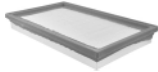

Panel Air Element

Fits: Isuzu, Nissan, Subaru Automotive, Trucks
Replaces: Isuzu 8-94132-678-0; Nissan 16546-V0100; Subaru 16546-AA020
Length: 11 1/16 (281.0)
Width: 6 9/16 (166.7)
Height: 1 5/16 (33.3)

PA2148



Air Element with Foam Wrap

Fits: GMC Light-Duty Trucks, Vans, Trucks
Replaces: GMC 25043585
O.D.: 11 13/16 (300.0)
I.D.: 9 13/16 (249.2)
Height: 5 7/16 (138.1)
Related To: PA2091 (without Foam Wrap)

PA2136



Air Element

Notes: Inside-Out Flow Direction
Fits: GM Automotive
Replaces: GMC 25043504
O.D.: 5 3/4 (146.1)
I.D.: 3 5/8 (92.1)
Height: 6 (152.4)

PA2149

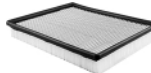

Panel Air Element

Fits: Ford Automotive
Replaces: Ford E6SZ-9601-B
Length: 11 9/32 (286.5)
Width: 8 29/32 (226.2)
Height: 1 19/32 (40.5)

PA2138



Panel Air Element

Fits: GM Automotive
Replaces: GMC 25043334
Length: 9 17/32 (242.1)
Width: 4 1/2 (114.3)
Height: 1 1/4 (31.8)

PA2150

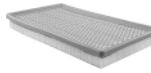

Panel Air Element

Fits: Ford, Mazda Automotive, Light-Duty Trucks
Replaces: Ford E6AZ-9601-B
Length: 11 7/32 (285.0)
Width: 6 1/8 (155.6)
Height: 1 7/32 (31.0)

PA2139



Air Element

Fits: Gardner Denver Compressors
Use With: PA2139 FOAM
Replaces: Gardner Denver 2008219
O.D.: 5 1/8 (130.2)
I.D.: 3 3/8 (85.7)
Height: 5 7/32 (132.6)

PA2152

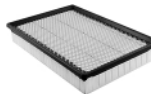

Panel Air Element

Fits: Ford Automotive, Light-Duty Trucks
Replaces: Ford E5TZ-9601-B
Length: 11 7/32 (285.0)
Width: 7 17/32 (191.3)
Height: 1 25/32 (45.2)

PA2153



Air Element

Fits: Chevrolet, Pontiac Automotive
Replaces: GMC 25095707
O.D.: 5 3/4 (146.1)
I.D.: 3 1/2 (88.9)
Height: 3 31/32 (100.8)

PA2139 FOAM



Foam Blanket for PA2139

Use With: PA2139
O.D.: 5 1/2 (139.7)
I.D.: 4 7/8 (123.8)
Height: 5 (127.0)

PA2154



Air Element

Replaces: Chrysler 4306393
O.D.: 9 11/16 (246.1)
I.D.: 7 1/2 (190.5)
Height: 2 15/16 (74.6)

PA2140



Air Element

Fits: GM Automotive
Replaces: GMC 8994941
O.D.: 5 (127.0)
I.D.: 3 9/16 (90.5)
Height: 5 5/16 (134.9)

PA2156



Air Element

Fits: Toyota Automotive, Light-Duty Trucks
Replaces: Toyota 17801-41110, 17801-54060
O.D.: 7 7/16 (188.9)
I.D.: 4 9/32 (108.7)
Height: 5 1/2 (139.7)

PA2147



Air Element

Fits: Honda Automotive
Replaces: Honda 17220-PEO-661
O.D.: 10 3/8 (263.5)
I.D.: 7 13/16 (198.4)
Height: 1 23/32 (43.7)

PA2157

















Oval Air Element

Notes: OBSOLETE. Availability Limited to Dealer Stock.
Fits: Chrysler Automotive
Replaces: Chrysler MD603340
O.D.: 4 15/16 (125.4) to 6 19/32 (167.5)
I.D.: 3 17/32 (89.7) & 5 3/16 (131.8)
Height: 8 3/8 (212.7)

Measurements Are Shown In Inches And (Millimeters)

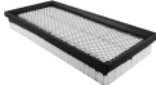

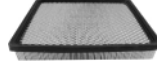
WARNING: These products can expose you to chemicals, including Diisononyl Phthalate, Carbon black extracts, Nickel, 1,3 Butadiene, Ethylene Oxide, Epichlorohydrin, which are known to the State of California to cause cancer, and Bisphenol, Ethylene Glycol, Ethylene Oxide, 1,3 Butadiene, Epichlorohydrin, which are known to the State of California to cause birth defects or other reproductive harm. For more information go to www.P65Warnings.ca.gov.

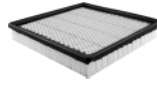
<p>PA2158 Oval Air Element Fits: Chrysler Automotive Replaces: Chrysler 4288009 O.D.: 7 9/32 (184.9) to 8 27/32 (224.6) I.D.: 5 23/32 (145.3) & 7 9/32 (184.9) Height: 2 7/32 (56.4)</p> 	<p>PA2169 Panel Air Element Fits: Daihatsu Charade; Toyota Camry, Corolla Replaces: Daihatsu 17801-87104-000; Toyota 17801-01020, 17801-74010 Length: 8 13/16 (223.8) Width: 6 5/8 (168.3) Height: 1 31/32 (50.0)</p> 
<p>SA2159 Crankcase Breather Filter Contains: [1] Metal Clip Fits: Ford Automotive, Light-Duty Trucks, Vans Replaces: Ford E5TZ-9D695-A Width: 2 3/8 (60.3) Height: 1 1/4 (31.8) F. Gskt: [1] Included</p> 	<p>PA2171 Air Element Fits: Toyota Automotive, Light-Duty Trucks Replaces: Toyota 17801-70020 O.D.: 8 19/32 (218.3) Height: 2 23/32 (69.1)</p> 
<p>PA2160 Panel Air Element Fits: GM Automotive, Light-Duty Trucks, Vans Replaces: GMC 25095333 Length: 7 5/8 (193.7) Width: 6 1/32 (150.8) Height: 1 17/32 (38.9)</p> 	<p>PA2178 Panel Air Element Fits: GM Automotive Replaces: GMC 25042562 Length: 15 7/8 (403.2) Width: 7 27/32 (199.2) Height: 1 19/32 (40.5)</p> 
<p>PA2162 Air Element Fits: GM Automotive Replaces: GMC 25096829 O.D.: 5 3/8 (136.5) I.D.: 3 13/16 (96.8) Height: 4 15/16 (125.4)</p> 	<p>PA2181 Panel Air Element Fits: Volvo Automotive Replaces: Volvo 463505, 463505-8 Length: 13 1/16 (331.8) Width: 6 15/32 (164.3) Height: 1 15/32 (37.3)</p> 
<p>PA2163 Panel Air Element Fits: Dodge Light-Duty Trucks; Jeep Briarwood, Cherokee; Mitsubishi Automotive Replaces: AMC 8953004383; Chrysler 53004383 Length: 13 17/32 (343.7) Width: 6 21/32 (169.1) Height: 1 19/32 (40.5)</p> 	<p>PA2182 Air Element Fits: Isuzu Impulse Replaces: Isuzu 5-14215-023-0 O.D.: 6 13/32 (162.7) I.D.: 3 1/32 (77.0) Height: 4 1/8 (104.8)</p> 
<p>PA2164 Panel Air Element Fits: Ford Light-Duty Trucks, Vans Replaces: Ford E7TZ-9601-B Length: 12 27/32 (326.2) Width: 5 7/8 (149.2) Height: 1 21/32 (42.1)</p> 	<p>PA2183 Air Element Fits: Chrysler Light-Duty Trucks Replaces: Chrysler 4428325 O.D.: 7 15/16 (201.6) I.D.: 7/16 (11.1) & 4 5/8 (117.5) Height: 9 9/16 (242.9) A. Gskt: [1] Attached F. Gskt: [1] Included</p> 
<p>PA2167 Air Element Fits: Toyota Automotive Replaces: Toyota 17801-22000-71 O.D.: 7 3/8 (187.3) I.D.: 4 5/16 (109.5) Height: 3 1/2 (88.9)</p> 	<p>PA2189 Panel Air Element Fits: Buick, Cadillac, Chevrolet, Oldsmobile, Pontiac Automotive Replaces: GMC 25096932 Length: 10 19/32 (269.1) Width: 7 7/8 (200.0) Height: 1 21/32 (42.1)</p> 
<p>PA2168 Panel Air Element Fits: Toyota Automotive, Light-Duty Trucks, Vans Replaces: Toyota 17801-70010 Length: 10 1/4 (260.4) Width: 6 3/4 (171.5) Height: 2 (50.8)</p> 	<p>PA2191 Panel Air Element Fits: Ford Thunderbird; Mercury Cougar Replaces: Ford E9SE-9601-AB Length: 9 17/32 (242.1) Width: 9 17/32 (242.1) Height: 1 9/16 (39.7)</p> 

Measurements Are Shown In Inches And (Millimeters)

 **WARNING:** These products can expose you to chemicals, including Diisononyl Phthalate, Carbon black extracts, Nickel, 1,3 Butadiene, Ethylene Oxide, Epichlorohydrin, which are known to the State of California to cause cancer, and Bisphenol, Ethylene Glycol, Ethylene Oxide, 1,3 Butadiene, Epichlorohydrin, which are known to the State of California to cause birth defects or other reproductive harm. For more information go to www.P65Warnings.ca.gov.

PA2192 Oblong Air Element
Fits: Chrysler Light-Duty Trucks
Replaces: Chrysler 4300787
O.D.: 9 3/16 (233.4)
to 12 15/16 (328.6)
I.D.: 6 1/16 (154.0) & 9 13/16 (249.2)
Height: 3 3/16 (81.0)



PA2193 Air Element
Fits: GM Automotive
Replaces: GMC 25096763
O.D.: 5 (127.0)
I.D.: 3 9/16 (90.5)
Height: 6 13/16 (173.0)



PA2194 Oval Air Element
Fits: Chrysler, Eagle, Hyundai, Mitsubishi Automotive
Replaces: Hyundai 28177-32520; Mitsubishi MD603932
O.D.: 7 13/16 (198.4)
Flange 8 1/16 (204.8)
I.D.: 5 9/32 (134.1) & 4 3/8 (111.1)
Height: 6 7/8 (174.6)
A. Gskt: [1] Attached



PA2196 Panel Air Element
Fits: Buick, Oldsmobile, Pontiac, Cadillac, Chevrolet Automotive
Replaces: GMC 25097453
Length: 11 1/2 (292.1)
Width: 7 1/32 (178.6)
Height: 1 21/32 (42.1)

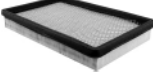

PA2200 Panel Air Element
Fits: Ford Automotive
Replaces: Ford F5RZ-9601-B
Length: 12 19/32 (319.9)
Width: 5 29/32 (150.0)
Height: 1 5/8 (41.3)

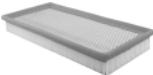

PA2201 Panel Air Element
Fits: Ford, Mazda Automotive
Replaces: Ford F92Z-9601-A; Mazda F201-13Z-409-A
Length: 10 3/32 (256.4)
Width: 7 (177.8)
Height: 1 5/16 (33.3)

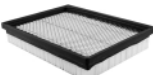

PA2204 Panel Air Element
Fits: Honda Accord
Replaces: Honda 17220-PT2-000
Length: 9 21/32 (245.3)
Width: 5 7/16 (138.1)
Height: 1 9/16 (39.7)



PA2207 Air Element
Fits: Toyota Tercel
Replaces: Toyota 17801-10030
O.D.: 10 3/32 (256.4)
Height: 1 13/16 (46.0)



PA2208 Panel Air Element
Fits: Audi, Jaguar, Porsche, Volkswagen, Volvo Automotive, Light-Duty Trucks
Replaces: Audi 21129620; Porsche 29129620A; Volkswagen 39129620A; Volvo 12573051
Length: 8 3/8 (212.7)
Width: 8 3/8 (212.7)
Height: 2 7/32 (56.4)

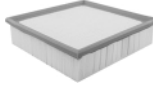

PA2212 Panel Air Element
Fits: Mazda Light-Duty Trucks, Vans
Replaces: Mazda JF01-13-Z00
Length: 9 9/32 (235.7)
Width: 7 15/16 (201.6)
Height: 1 9/16 (39.7)



PA2214 Panel Air Element
Fits: Isuzu, Mazda, Toyota Automotive, Light-Duty Trucks, Vans
Replaces: Isuzu 8-94376-353-0; Mazda JE48-13-Z50; Toyota 17801-35020
Length: 9 27/32 (250.0)
Width: 6 11/16 (169.9)
Height: 2 (50.8)



PA2215 Air Element
Fits: Suzuki Samurai
Replaces: Suzuki 13780-83000
O.D.: 7 9/32 (184.9)
I.D.: 4 21/32 (118.3)
Height: 4 13/32 (111.9)
A. Gskt: [2] Attached



PA2216 Air Element
Fits: Chevrolet, Geo, Pontiac, Suzuki Automotive
Replaces: GMC 96055471; Suzuki 13780-860A0
O.D.: 9 5/8 (244.5)
Height: 1 5/8 (41.3)



PA2218 Panel Air Element
Fits: GM Automotive
Replaces: GMC 25097917
Length: 13 3/4 (349.3)
Width: 4 5/32 (105.6)
Height: 1 19/32 (40.5)



PA2221 Panel Air Element
Fits: Clark Lift Trucks
Replaces: Clark 2373789
Length: 8 1/2 (215.9)
Width: 8 1/2 (215.9)
Height: 1 5/8 (41.3)

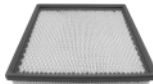

PA2222 Panel Air Element
Fits: Briggs & Stratton Engines; Cub Cadet Mowers; John Deere Lawn & Garden Tractors
Replaces: Briggs & Stratton 491588
Length: 5 5/32 (131.0)
Width: 4 7/16 (112.7)
Height: 25/32 (19.8)



Measurements Are Shown In Inches And (Millimeters)

! **WARNING:** These products can expose you to chemicals, including Diisononyl Phthalate, Carbon black extracts, Nickel, 1,3 Butadiene, Ethylene Oxide, Epichlorohydrin, which are known to the State of California to cause cancer, and Bisphenol, Ethylene Glycol, Ethylene Oxide, 1,3 Butadiene, Epichlorohydrin, which are known to the State of California to cause birth defects or other reproductive harm. For more information go to www.P65Warnings.ca.gov.

PA2223 Air Element
Fits: Briggs & Stratton Engines
Use With: PA2223 FOAM
Replaces: Briggs & Stratton 393957
O.D.: 4 1/4 (108.0)
I.D.: 2 (50.8)
Height: 3 3/4 (95.3)



PA2223 FOAM Foam Blanket for PA2223
Use With: PA2223
O.D.: 4 1/32 (102.4)
I.D.: 3 17/32 (89.7)
Length: 3 23/32 (94.5)



PA2224 Air Element
Fits: Briggs & Stratton Engines
Replaces: Briggs & Stratton 390492
O.D.: 3 13/16 (96.8)
I.D.: 1 5/16 (33.3)
Height: 2 7/8 (73.0)



PA2225 Air Element
Fits: Briggs & Stratton Engines
Replaces: Briggs & Stratton 396424
O.D.: 2 3/4 (69.9)
I.D.: 3/16 (4.8) & 1 1/4 (31.8)
Height: 2 3/4 (69.9)



PA2226 Air Element
Fits: Briggs & Stratton Engines; Cub Cadet, John Deere, Simplicity, Toro Lawn & Garden Tractors
Replaces: Briggs & Stratton 394018
O.D.: 6 29/32 (175.4)
I.D.: 5 9/16 (141.3)
Height: 2 1/4 (57.2)



PA2227 Panel Air Element
Notes: OBSOLETE. Availability Limited to Dealer Stock.
Fits: Ford Automotive
Replaces: Ford F5RZ-9601-C
Length: 15 5/8 (396.9)
Width: 5 29/32 (150.0)
Height: 1 19/32 (40.5)



PA2229 Panel Air Element
Fits: Ford, Mazda Automotive
Replaces: Ford F32Z-9601-A; Mazda FS11-13-Z40
Length: 10 11/32 (262.7)
Width: 6 13/32 (162.8)
Height: 1 19/32 (40.5)

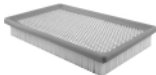

PA2230 Panel Air Element
Fits: Chrysler, Eagle Automotive
Replaces: Chrysler 4573031
Length: 12 7/16 (315.9)
Width: 7 1/32 (178.6)
Height: 1 7/16 (36.5)

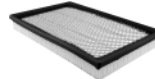

PA2231 Panel Air Element
Fits: GM, Saturn Automotive, Vans
Replaces: GMC 25099149
Length: 9 5/16 (236.5)
Width: 7 3/32 (180.2)
Height: 1 19/32 (40.5)

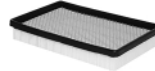

PA2232 Panel Air Element with Foam Pad
Fits: GMC Light-Duty Trucks, Vans
Replaces: GMC 25099849
Length: 15 31/32 (405.6)
Width: 7 29/32 (200.8)
Height: 2 5/32 (54.8)



PA2233 Oval Air Element with Foam Wrap
Fits: Ford Light-Duty Trucks
Replaces: Ford F5TZ-9601-A
O.D.: 6 7/32 (158.0) to 12 31/32 (329.4)
I.D.: 3 5/32 (80.2) & 9 7/8 (250.8)
Height: 6 1/32 (153.2)



PA2234 Panel Air Element
Fits: Dodge Light-Duty Trucks
Replaces: Chrysler 53040025
Length: 13 3/4 (349.3)
Width: 5 3/16 (131.8)
Height: 2 5/16 (58.7)

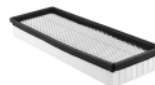

PA2235 Panel Air Element
Fits: BMW Automotive
Replaces: BMW 13721726916
Length: 13 (330.2)
Width: 5 7/8 (149.2)
Height: 2 3/16 (55.6)



PA2237 Panel Air Element
Notes: Uses 2 filters per application.
Fits: Ford Vans
Replaces: Ford F5UZ-9601-A
Length: 11 1/4 (285.8)
Width: 6 19/32 (167.5)
Height: 1 21/32 (42.1)



PA2240 Air Element
Fits: Ford, Mazda Light-Duty Trucks, Vans
Replaces: Ford F57Z-9601-A; Mazda ZZM2-23-603
O.D.: 6 1/2 (165.1)
 Flange 6 29/32 (175.4)
I.D.: 3 3/32 (78.6) One End
Height: 7 15/32 (189.7)



PA2241 Panel Air Element
Fits: Chevrolet Automotive
Replaces: GMC 25096933
Length: 17 5/16 (439.7)
Width: 10 19/32 (269.1)
Height: 1 17/32 (38.9)

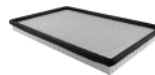

Measurements Are Shown In Inches And (Millimeters)

WARNING: These products can expose you to chemicals, including Diisononyl Phthalate, Carbon black extracts, Nickel, 1,3 Butadiene, Ethylene Oxide, Epichlorohydrin, which are known to the State of California to cause cancer, and Bisphenol, Ethylene Glycol, Ethylene Oxide, 1,3 Butadiene, Epichlorohydrin, which are known to the State of California to cause birth defects or other reproductive harm. For more information go to www.P65Warnings.ca.gov.

PA2243



Panel Air Element

Fits: Chevrolet, Mazda, Toyota Automotive
Replaces: Mazda KJ01-13-A40, KJ01-13-Z40;
 Toyota 17801-02030, 17801-15070
Length: 10 1/2 (266.7)
Width: 6 23/32 (170.7)
Height: 1 21/32 (42.1)

PA2244

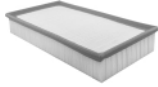

Panel Air Element

Fits: Volvo Automotive
Replaces: Volvo 9186262-3
Length: 13 13/16 (350.8)
Width: 7 9/32 (184.9)
Height: 2 3/16 (55.6)

PA2256



Air Breather Element

Fits: Midland Compressors
Replaces: Midland 100696E
O.D.: 4 (101.6)
I.D.: 1 11/32 (34.1)
Height: 1 3/8 (34.9)

PA2257



Panel Air Element

Fits: Chevrolet, GMC, Isuzu Automotive,
 Light-Duty Trucks, Vans
Replaces: GMC 25098463
Length: 11 17/32 (292.9)
Width: 6 1/32 (153.2)
Height: 1 5/8 (41.3)

PA2258



Oval Air Element

Fits: Lauson-Tecumseh Engines
Replaces: Tecumseh 33268
O.D.: 2 23/32 (69.1) to 4 15/32 (113.5)
I.D.: 1 15/32 (37.3) & 3 7/32 (81.8)
Height: 2 5/16 (58.7)

PA2260



Air Element

Replaces: Vortex VF57
O.D.: 5 3/4 (146.1)
I.D.: 4 7/32 (107.2)
Height: 12 3/32 (307.2)

PA2300



Outer Air Element

Fits: Dresser, International, John Deere
 Equipment
Use With: PA2301
Replaces: International 624977-C91;
 John Deere AE30508
O.D.: 10 3/8 (263.5)
 Boot 11 (279.4)
I.D.: 15/16 (23.8) & 6 1/32 (153.2)
Height: 16 1/2 (419.1)
A. Gskt: [2] Attached
F. Gskt: [1] Included

PA2301



Inner Air Element

Fits Inside: PA2300
Fits: Dresser, International, John Deere
 Equipment
Replaces: International 624978-C91;
 John Deere AE30507
O.D.: 5 3/4 (146.1)
I.D.: 15/16 (23.8) & 4 13/16 (122.2)
Height: 14 5/16 (363.5)
A. Gskt: [1] Attached
F. Gskt: [1] Included

PA2302-FN



Outer Air Element with Fins

Fits: Dresser, International Equipment
Use With: PA2303
Replaces: International 622036-C91
O.D.: 6 7/8 (174.6)
 Fins 8 3/4 (222.3)
I.D.: 2 1/32 (16.7) & 4 3/16 (106.4)
Height: 14 5/16 (363.5)
A. Gskt: [1] Included
F. Gskt: G103-N

PA2303



Inner Air Element

Fits Inside: PA2302-FN
Fits: Dresser, International Equipment
Replaces: International 622041-C91
O.D.: 4 3/32 (104.0)
I.D.: 3/4 (19.1) & 2 15/32 (62.7)
Height: 13 7/16 (341.3)
A. Gskt: [1] Attached
F. Gskt: G103-N

PA2304-FN



Outer Air Element with Fins

Fits: John Deere, Minneapolis-Moline, Oliver,
 White Equipment
Use With: PA1967
Replaces: John Deere AT43867;
 Oliver 303002128
O.D.: 7 31/32 (202.4)
 Fins 9 29/32 (251.6)
I.D.: 1 1/16 (17.5) & 5 3/8 (136.5)
Height: 12 1/2 (317.5)
A. Gskt: [1] Attached
F. Gskt: G103-N
Related To: PA2351 (without Fins)

PA2305



Inner Air Element

Fits Inside: PA1822-FN, LL2418-FN, PA2418-FN
Fits: Case, Daewoo, Hough, John Deere,
 Komatsu Equipment
Replaces: Daewoo 24749014; John Deere
 TH106446; Komatsu 300-181-9500
O.D.: 3 3/8 (85.7)
I.D.: 1 1/16 (17.5) & 2 1/4 (57.2)
Height: 13 1/4 (336.6)
A. Gskt: [1] Attached
F. Gskt: G103-N

PA2306



Inner Air Element

Fits Inside: PA1609
Fits: Ford Tractors
Replaces: Ford C9NN-9R500-A
O.D.: 3 17/32 (89.7)
I.D.: 7/16 (11.1) & 2 3/8 (60.3)
Height: 14 (355.6)
F. Gskt: [1] Included, [1] Wing Nut

Measurements Are Shown In Inches And (Millimeters)



WARNING: These products can expose you to chemicals, including Diisononyl Phthalate, Carbon black extracts, Nickel, 1,3 Butadiene, Ethylene Oxide, Epichlorohydrin, which are known to the State of California to cause cancer, and Bisphenol, Ethylene Glycol, Ethylene Oxide, 1,3 Butadiene, Epichlorohydrin, which are known to the State of California to cause birth defects or other reproductive harm. For more information go to www.P65Warnings.ca.gov.

PA2307



Outer Air Element with Lift Bar
Notes: Reuse OEM boot.
Fits: Ford Tractors
Use With: PA2308
Replaces: Ford D0NN-9601-A
O.D.: 7 (177.8)
I.D.: 4 19/32 (116.7) One End
Height: 14 7/16 (366.7)
A. Gskt: [1] Attached

PA2314



Outer Air Element with Bail Handle
Fits: Elgin, Hough, International Equipment
Use With: PA2332
Replaces: Elgin 7072935;
 International 529851-R2
O.D.: 6 3/32 (154.8)
I.D.: 3 15/32 (88.1) One End
Height: 15 5/16 (388.9)
A. Gskt: [1] Attached
Related To: PA2392 (Short Version)

PA2308



Inner Air Element
Fits Inside: PA2307, PA2433
Fits: Ford, Versatile Tractors
Replaces: Ford D2NN-9R500-B;
 Versatile 24574
O.D.: 4 17/32 (115.1)
I.D.: 7/16 (11.1) & 3 7/16 (87.3)
Height: 13 9/16 (344.5)
F. Gskt: [1] Included, [1] Wing Nut

PA2315

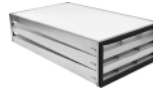

DynaCell Panel Air Element
Replaces: GMC 8469003
Length: 22 15/16 (582.6)
Width: 14 (355.6)
Height: 5 5/16 (134.9) to 6 7/32 (158.0)

PA2310



Inner Air Element with 8 Bolt Holes
Fits Inside: LL1634, PA1634, PA1634XP
Fits: Caterpillar Equipment
Replaces: Caterpillar 9S9972
O.D.: 6 1/4 (158.8)
 Flange 9 1/16 (230.2)
I.D.: 4 5/8 (117.5) One End
Height: 13 3/32 (332.6)
A. Gskt: [1] Attached
F. Gskt: [1] Included

PA2316



Air Element
Fits: Chevrolet, GMC Trucks
Replaces: GMC 684743716
O.D.: 12 1/16 (306.4)
I.D.: 5/8 (15.9) & 6 3/32 (154.8)
Height: 14 1/4 (362.0)
A. Gskt: [1] Attached
F. Gskt: G103-N

LL2312



Long Life Air Element
Notes: Inside-Out Flow Direction
Fits: Kenworth, Mack, Peterbilt, R.V.I. Trucks
Replaces: GMC 15586905; Kenworth KW853M;
 Mack 2MD2147
O.D.: 10 3/8 (263.5)
I.D.: 6 1/32 (153.2) One End
Height: 22 13/16 (579.4)
A. Gskt: [2] Attached
F. Gskt: G21-AF
O. Gskt: G499-AF
Related To: PA2312 (Standard Media Version)

LL2317



Long Life Air Element
Notes: Inside-Out Flow Direction
Fits: Brockway, Freightliner, GMC, Kenworth,
 Mack, Peterbilt Trucks
Replaces: Brockway 534564; Caterpillar
 7W7422; GMC 15529143; Mack 2MD2153
O.D.: 12 3/4 (323.9)
I.D.: 8 11/32 (211.9) One End
Height: 23 (584.2)
A. Gskt: [2] Attached
F. Gskt: G25-AF
Related To: PA2317 (Standard Media Version)

PA2312



Air Element
Notes: Inside-Out Flow Direction
Fits: Kenworth, Mack, Peterbilt, R.V.I. Trucks
Replaces: GMC 15586905; Kenworth KW853M;
 Mack 2MD2147
O.D.: 10 3/8 (263.5)
I.D.: 6 1/32 (153.2) One End
Height: 22 13/16 (579.4)
A. Gskt: [2] Attached
F. Gskt: G21-AF
O. Gskt: G499-AF
Related To: LL2312 (Long-Life Media Version)

PA2317



Air Element
Notes: Inside-Out Flow Direction
Fits: Brockway, Freightliner, GMC, Kenworth,
 Mack, Peterbilt Trucks
Replaces: Brockway 534564; Caterpillar
 7W7422; GMC 15529143; Mack 2MD2153
O.D.: 12 3/4 (323.9)
I.D.: 8 11/32 (211.9) One End
Height: 23 (584.2)
A. Gskt: [2] Attached
F. Gskt: G25-AF
Related To: LL2317 (Long-Life Media Version)

PA2313



DynaCell Panel Air Element
Replaces: White 27-074049
Length: 22 3/4 (577.9)
Width: 20 1/4 (514.4)
Height: 3 9/32 (83.3) to 4 1/4 (108.0)

LL2318



Long Life Outer Air Element
Fits: International Equipment
Use With: PA2319
Replaces: International 537337-R1
O.D.: 8 15/32 (215.1)
 Boot 9 7/16 (239.7)
I.D.: 4 17/32 (115.1) One End
Height: 15 1/2 (393.7)
A. Gskt: [2] Attached
Related To: PA2318 (Standard Media)

Measurements Are Shown In Inches And (Millimeters)

WARNING: These products can expose you to chemicals, including Diisononyl Phthalate, Carbon black extracts, Nickel, 1,3 Butadiene, Ethylene Oxide, Epichlorohydrin, which are known to the State of California to cause cancer, and Bisphenol, Ethylene Glycol, Ethylene Oxide, 1,3 Butadiene, Epichlorohydrin, which are known to the State of California to cause birth defects or other reproductive harm. For more information go to www.P65Warnings.ca.gov.

PA2318



Outer Air Element

Fits: International Equipment
Use With: PA2319
Replaces: International 537337-R1
O.D.: 8 15/32 (215.1)
 Boot 9 7/16 (239.7)
I.D.: 4 17/32 (115.1) One End
Height: 15 1/2 (393.7)
A. Gskt: [2] Attached
Related To: LL2318 (Long-Life Media)

PA2319



Inner Air Element

Fits Inside: LL2318, PA2318
Fits: International Equipment
Replaces: International 537338-R2
O.D.: 4 15/32 (113.5)
I.D.: 3/8 (9.5) & 3 7/16 (87.3)
Height: 14 (355.6)
A. Gskt: [1] Attached
F. Gskt: [1] Included, [1] Wing Nut

PA2320-FN



Outer Air Element with Fins

Fits: Minneapolis-Moline, Oliver Tractors
Use With: PA2321
Replaces: International 3115560-R91
O.D.: 6 3/32 (154.8)
 Fins 7 13/16 (198.4)
I.D.: 3/4 (19.1) & 3 15/32 (88.1)
Height: 13 1/2 (342.9)
A. Gskt: [1] Attached
F. Gskt: G103-N

PA2321



Inner Air Element

Fits Inside: LL1681-FN, PA1681-FN, PA2320-FN
Fits: Case Equipment; Oliver Tractors
Replaces: Case D78336; White 30-3003477
O.D.: 3 3/8 (85.7)
 Flange 3 25/32 (96.0)
I.D.: 21/32 (16.7) & 2 7/8 (73.0)
Height: 11 1/16 (281.0)
A. Gskt: [1] Attached
F. Gskt: G103-N

PA2322



Outer Air Element with Lift Bar

Fits: Massey Ferguson Wheel Tractors
Use With: PA2323
Replaces: Massey Ferguson 1039044-M91
O.D.: 5 5/16 (134.9)
I.D.: 3 13/32 (86.5) One End
Height: 14 3/16 (360.4)
A. Gskt: [1] Attached

PA2323



Inner Air Element

Fits Inside: PA2322, PA2486
Fits: Massey Ferguson Wheel Tractors
Replaces: Massey Ferguson 1039045-M91
O.D.: 3 5/16 (84.1)
I.D.: 5/8 (7.9) & 2 1/4 (57.2)
Height: 13 21/32 (346.9)

LL2326



Long Life Air Element

Fits: Peterbilt Trucks
Replaces: White 27-088627;
 Donaldson EAF5057
O.D.: 12 3/4 (323.9)
 Boot Gasket 13 3/8 (339.7)
I.D.: 15/16 (23.8) & 8 3/8 (212.7)
Height: 17 1/2 (444.5)
A. Gskt: [2] Attached
F. Gskt: [1] Included
Related To: PA2326 (Standard Media Version)
 PA2326XP (Extreme Performance Nano Version)

PA2326



Air Element

Fits: Peterbilt Trucks
Replaces: White 27-088627;
 Donaldson EAF5057
O.D.: 12 3/4 (323.9)
 Boot Gasket 13 3/8 (339.7)
I.D.: 15/16 (23.8) & 8 3/8 (212.7)
Height: 17 1/2 (444.5)
A. Gskt: [2] Attached
F. Gskt: [1] Included
Related To: LL2326 (Long-Life Media Version)
 PA2326XP (Extreme Performance Nano Version)

PA2326XP



Extreme Performance Nano Air Element

Fits: Peterbilt Trucks
Replaces: White 27-088627;
 Donaldson EAF5057
O.D.: 12 3/4 (323.9)
 Boot Gasket 13 3/8 (339.7)
I.D.: 15/16 (23.8) & 8 3/8 (212.7)
Height: 17 1/2 (444.5)
A. Gskt: [2] Attached
F. Gskt: [1] Included
Related To: LL2326 (Long-Life Media Version)
 PA2326 (Standard Media Version)

PA2328



Air Element

Replaces: White 31-15782
O.D.: 11 1/16 (281.0)
 Flange 11 11/16 (296.9)
I.D.: 7 25/32 (197.6)
Height: 7 (177.8)

PA2329

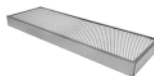

Cab Air Element

Fits: Massey Ferguson Equipment
Replaces: Massey Ferguson 525446-M1
Length: 29 (736.6)
Width: 9 1/4 (235.0)
Height: 2 3/16 (55.6)

LL2330



Long Life Outer Air Element

Fits: International Trucks
Use With: PA2579
Replaces: International 424700-C92
O.D.: 12 1/32 (305.6)
I.D.: 5/8 (15.9) & 7 11/16 (195.3)
Height: 15 5/16 (388.9)
A. Gskt: [1] Attached
F. Gskt: G103-N
Related To: PA2330 (Standard Media Version)

Measurements Are Shown In Inches And (Millimeters)

WARNING: These products can expose you to chemicals, including Diisononyl Phthalate, Carbon black extracts, Nickel, 1,3 Butadiene, Ethylene Oxide, Epichlorohydrin, which are known to the State of California to cause cancer, and Bisphenol, Ethylene Glycol, Ethylene Oxide, 1,3 Butadiene, Epichlorohydrin, which are known to the State of California to cause birth defects or other reproductive harm. For more information go to www.P65Warnings.ca.gov.

PA2330



Outer Air Element

Fits: International Trucks
Use With: PA2579
Replaces: International 424700-C92
O.D.: 12 1/32 (305.6)
I.D.: 5/8 (15.9) & 7 11/16 (195.3)
Height: 15 5/16 (388.9)
A. Gskt: [1] Attached
F. Gskt: G103-N
Related To: LL2330 (Long-Life Media Version)

PA2337



Air Element

Fits: Atlas Copco Compressors
Replaces: Atlas Copco 1030-1070
O.D.: 11 7/8 (301.6)
I.D.: 7 1/2 (190.5)
Height: 4 11/32 (110.3)

PA2331



Outer Air Element with Lift Tab

Contains: Flame Retardant Media
Fits: Ford Equipment
Use With: PA1809
Replaces: Ford D0NN-9B618-A
O.D.: 4 1/2 (114.3)
 Boot 4 7/8 (123.8)
I.D.: 2 1/4 (57.2) One End
Height: 10 3/4 (273.1)
A. Gskt: [2] Attached

PA2338-FN



Outer Air Element with Fins

Fits: International Wheel Tractors
Use With: PA1836
Replaces: International 537336-R1
O.D.: 7 15/16 (201.6)
 Fins 10 (254.0)
I.D.: 5 3/8 (136.5) One End
Height: 15 1/2 (393.7)
A. Gskt: [1] Attached

PA2332



Inner Air Element

Fits Inside: PA2314, LL2418-FN, PA2418-FN, PA2524-FN, PA2541-FN, PA2551
Fits: Bobcat, Case, Dresser, Hough, International, Massey Ferguson, Melroe, New Holland Equipment; Spra-Coupe Sprayers
Replaces: Case P250566; International 406130-R91; Massey Ferguson 1037735-M91; Melroe 6598898; New Holland 377059
O.D.: 3 3/8 (85.7)
 Flange 3 25/32 (96.0)
I.D.: 21/32 (16.7) & 2 7/8 (73.0)
Height: 14 1/16 (357.2)
A. Gskt: [1] Attached
F. Gskt: G103-N

PA2339



Outer Air Element with Lift Tabs

Fits: Case Equipment
Use With: PA2340
Replaces: Case A43734
O.D.: 11 5/8 (295.3)
 Boot 12 3/8 (314.3)
I.D.: 7/16 (11.1) & 7 3/16 (182.6)
Height: 7 5/16 (185.7)
A. Gskt: [2] Attached
F. Gskt: [1] Included

LL2333



Long Life Air Element with Lid and 6 Bolt Holes

Fits: Peterbilt Trucks
Replaces: Donaldson P182006, P182099; Fleetguard AF872M, AF4871M
O.D.: 13 13/16 (350.8)
 Lid 16 5/32 (410.4)
I.D.: 7 7/16 (188.9) One End
Height: 18 9/16 (471.5)
A. Gskt: [2] Attached
Related To: PA2333 (Standard Media Version)

PA2340



Inner Air Element

Fits Inside: PA2339
Fits: Case Equipment
Replaces: Case A43735
O.D.: 6 7/8 (174.6)
I.D.: 5/8 (15.9) & 5 9/16 (141.3)
Height: 6 1/16 (154.0)
A. Gskt: [1] Attached
F. Gskt: [1] Included

PA2333



Air Element with Lid and 6 Bolt Holes

Fits: Freightliner, GMC, International Trucks
Replaces: GMC 25096450; International 1685307-C1; White 22-0010240
O.D.: 13 13/16 (350.8)
 Lid 16 5/32 (410.4)
I.D.: 9 1/2 (241.3) One End
Height: 18 9/16 (471.5)
A. Gskt: [2] Attached
Related To: LL2333 (Long-Life Media Version)

PA2341



Outer Air Element

Fits: Massey Ferguson Wheel Tractors
Use With: PA2342
Replaces: Massey Ferguson 1038946-M91
O.D.: 6 7/8 (174.6)
 Boot 7 7/16 (188.9)
I.D.: 4 3/16 (106.4) One End
Height: 14 5/8 (371.5)
A. Gskt: [2] Attached

PA2335



Air Element

Replaces: United 250B18, 250B18-S
O.D.: 4 13/32 (111.9)
I.D.: 2 15/16 (74.6)
Height: 4 3/4 (120.7)

PA2342



Inner Air Element

Fits Inside: PA2341
Fits: Massey Ferguson Wheel Tractors
Replaces: Massey Ferguson 1038947-M91
O.D.: 4 3/32 (104.0)
I.D.: 5/8 (15.9) & 3 1/8 (79.4)
Height: 12 15/16 (328.6)
F. Gskt: G40-AF

Measurements Are Shown In Inches And (Millimeters)

WARNING: These products can expose you to chemicals, including Diisononyl Phthalate, Carbon black extracts, Nickel, 1,3 Butadiene, Ethylene Oxide, Epichlorohydrin, which are known to the State of California to cause cancer, and Bisphenol, Ethylene Glycol, Ethylene Oxide, 1,3 Butadiene, Epichlorohydrin, which are known to the State of California to cause birth defects or other reproductive harm. For more information go to www.P65Warnings.ca.gov.

PA2343



Outer Air Element

Fits: Case, John Deere, Oliver, White Equipment
Use With: PA1996
Replaces: John Deere AR64624; White 30-3089258
O.D.: 13 7/8 (352.4)
I.D.: 5/8 (15.9) & 7 7/16 (188.9)
Height: 6 29/32 (175.4)
A. Gskt: [1] Attached
F. Gskt: G103-N

LL2344-FN



Long Life Outer Air Element with Fins

Fits: Case, Ford, Gehl, John Deere, New Holland, Thomas Equipment; Ingersoll-Rand Compressors
Use With: PA2602
Replaces: Case R39392; Gehl 263638; John Deere MG221406; New Holland 221406
O.D.: 4 3/32 (104.0)
 Fins 5 1/8 (130.2)
I.D.: 25/32 (19.8) & 2 15/32 (62.7)
Height: 14 5/16 (363.5)
A. Gskt: [1] Attached
F. Gskt: G103-N
Related To: PA2344-FN (Standard Media Version)

PA2344-FN



Outer Air Element with Fins

Fits: Case, Ford, Gehl, John Deere, New Holland, Thomas Equipment; Ingersoll-Rand Compressors
Use With: PA2602
Replaces: Case R39392; Gehl 263638; John Deere MG221406; New Holland 221406
O.D.: 4 3/32 (104.0)
 Fins 5 1/8 (130.2)
I.D.: 25/32 (19.8) & 2 15/32 (62.7)
Height: 14 5/16 (363.5)
A. Gskt: [1] Attached
F. Gskt: G103-N
Related To: LL2344-FN (Long-Life Media Version)

PA2345



Outer Air Element

Fits: Case, International, John Deere, New Holland Equipment
Use With: PA2346, PA2388
Replaces: International 640968-C91; John Deere AT49022; New Holland 614103
O.D.: 11 1/8 (282.6)
I.D.: 5/8 (15.9) & 6 3/4 (171.5)
Height: 20 1/2 (520.7)
A. Gskt: [1] Attached
F. Gskt: G103-N

PA2346



Inner Air Element

Fits Inside: PA2345
Fits: Case, International, New Holland Equipment
Replaces: International 923611-C91; New Holland 614104
O.D.: 6 3/8 (161.9)
 Flange 7 1/2 (190.5)
I.D.: 5/8 (15.9) & 5 1/4 (133.4)
Height: 20 (508.0)
A. Gskt: [1] Attached
F. Gskt: G103-N

PA2347



Air Element

Fits: Onan Engines
Replaces: Onan 140-B1071
O.D.: 4 5/8 (117.5)
 Flange Gasket 5 3/16 (131.8)
I.D.: 1 1/2 (38.1) One End
Height: 2 19/32 (65.9)
A. Gskt: [1] Attached

PA2349-FN



Air Element with Fins and Lift Tabs

Replaces: White 27-011685
O.D.: 13 7/8 (352.4)
 Fins 15 25/32 (400.8)
I.D.: 5/8 (15.9) & 7 7/16 (188.9)
Height: 10 3/8 (263.5)
A. Gskt: [1] Attached
F. Gskt: G103-N

PA2350

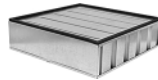

DynaCell Panel Air Element

Notes: Back is closed.
Fits: Ford, GMC Trucks; Cummins Engines
Replaces: Ford D8HZ-9601-C; GMC 6488476
Length: 19 (482.6)
Width: 19 (482.6)
Height: 5 3/8 (136.5)
Related To: PA2375 (Front and Back are Open)

PA2351



Outer Air Element

Fits: Dresser, International, John Deere Equipment
Use With: PA1967
Replaces: International 634269-C1; John Deere AT35155
O.D.: 7 31/32 (202.4)
I.D.: 11/16 (17.5) & 5 3/8 (136.5)
Height: 12 3/8 (314.3)
A. Gskt: [1] Attached
F. Gskt: G103-N
Related To: PA2304-FN (with Fins)

PA2352



Cab Air Element

Fits: John Deere Equipment
Replaces: John Deere AR49986
Length: 28 (711.2)
Width: 7 1/2 (190.5)
Height: 2 9/16 (65.1)
A. Gskt: [1] Attached
Related To: PA2353 (Thin Version)

PA2353



Cab Air Element

Fits: Allis Chalmers, Case, Ford, John Deere, Melroe, New Holland, Versatile Equipment; Spra-Coupe Sprayers
Replaces: Allis Chalmers 134692; Case F84818; Ford D2NN-19N-551A; John Deere AN112705; New Holland 70569300
Length: 28 (711.2)
Width: 7 1/2 (190.5)
Height: 2 3/16 (55.6)
Related To: PA2352 (Thick Version)

PA2354



Panel Air Element

Fits: Bell Equipment; Inslay Shovels; Komatsu Dump Trucks
Replaces: Hinson 3000020
Length: 20 (508.0)
Width: 7 1/2 (190.5)
Height: 2 3/16 (55.6)
Related To: PA5315 (with Attached Gasket)

Measurements Are Shown In Inches And (Millimeters)



WARNING: These products can expose you to chemicals, including Diisononyl Phthalate, Carbon black extracts, Nickel, 1,3 Butadiene, Ethylene Oxide, Epichlorohydrin, which are known to the State of California to cause cancer, and Bisphenol, Ethylene Glycol, Ethylene Oxide, 1,3 Butadiene, Epichlorohydrin, which are known to the State of California to cause birth defects or other reproductive harm. For more information go to www.P65Warnings.ca.gov.

PA2356

Cab Air Element



Fits: Case, Caterpillar, Versatile Equipment
Replaces: Case T39515; Caterpillar 8S468; Versatile 15942
Length: 23 1/2 (596.9)
Width: 7 (177.8)
Height: 2 3/16 (55.6)

PA2357

Air Element



Notes: Inside-Out Flow Direction
Fits: Caterpillar, Cummins Engines; Kenworth Trucks
Replaces: Caterpillar 7W7421; GMC 8994222; Kenworth 21401091
O.D.: 12 3/4 (323.9)
I.D.: 8 3/8 (212.7) One End
Height: 27 (685.8)
A. Gskt: [2] Attached
F. Gskt: G25-AF
Related To: LL2317, PA2317 (Short Versions) PA2608 (with Bolt Hole)

LL2358

Long Life Outer Air Element



Fits: Caterpillar, DJB, Hough, Iveco Equipment
Use With: PA2359, PA2738
Replaces: Caterpillar 8N5495, 7W5495
O.D.: 11 1/2 (292.1)
I.D.: 8 1/16 (204.8) One End
Height: 13 1/2 (342.9)
A. Gskt: [1] Attached
Related To: PA2358 (Standard Media Version)

PA2358

Outer Air Element



Fits: Caterpillar, DJB, Hough, Iveco Equipment
Use With: PA2359, PA2738
Replaces: Caterpillar 8N5495, 7W5495
O.D.: 11 1/2 (292.1)
I.D.: 8 1/16 (204.8) One End
Height: 13 1/2 (342.9)
A. Gskt: [1] Attached
Related To: LL2358 (Long-Life Media Version)

PA2359

Inner Air Element with 8 Bolt Holes



Fits Inside: LL2358, PA2358
Fits: Caterpillar, DJB, Hough Equipment
Replaces: Caterpillar 1P7360
O.D.: 7 5/8 (193.7)
 Flange 10 1/4 (260.4)
I.D.: 6 (152.4) One End
Height: 13 1/2 (342.9)
A. Gskt: [1] Attached

LL2360-FN

Long Life Outer Air Element with Fins



Fits: Bobcat, Case, Ditch Witch, Gehl, Grove, J.C. Bamford, Mustang, New Holland, Vermeer, Vibromax Equipment; Ingersoll-Rand Compressors
Use With: PA2487
Replaces: Case A173290; Ditch Witch 195690; Grove 9304100077; Ingersoll-Rand 35291970; New Holland 266221
O.D.: 5 1/4 (133.4)
 Fins 6 3/8 (161.9)
I.D.: 21/32 (16.7) & 3 1/4 (82.6)
Height: 15 3/8 (390.5)
A. Gskt: [1] Attached
F. Gskt: G103-N
Related To: PA2360-FN (Standard Media Version)

PA2360-FN

Outer Air Element with Fins



Fits: Bobcat, Case, Ditch Witch, Gehl, Grove, J.C. Bamford, Mustang, New Holland, Vermeer, Vibromax Equipment; Ingersoll-Rand Compressors
Use With: PA2487
Replaces: Case A173290; Ditch Witch 195690; Grove 9304100077; Ingersoll-Rand 35291970; New Holland 266221
O.D.: 5 1/4 (133.4)
 Fins 6 3/8 (161.9)
I.D.: 21/32 (16.7) & 3 1/4 (82.6)
Height: 15 3/8 (390.5)
A. Gskt: [1] Attached
F. Gskt: G103-N
Related To: LL2360-FN (Long-Life Media Version)

LL2361

Long Life Outer Air Element



Fits: Allis Chalmers, Fiat-Allis, New Holland, Samsung Equipment
Use With: PA2362
Replaces: Allis Chalmers 70671838; Fiat 70671809; New Holland 703409
O.D.: 12 1/32 (305.6)
 Boot 12 3/4 (323.9)
I.D.: 15/16 (23.8) & 7 23/32 (196.1)
Height: 23 1/2 (596.9)
A. Gskt: [2] Attached
F. Gskt: [1] Metal Washer
Related To: PA2361 (Standard Media Version) PA2361XP (Extreme Performance Nano Version)

PA2361

Outer Air Element



Fits: Allis Chalmers, Fiat-Allis, New Holland, Samsung Equipment
Use With: PA2362
Replaces: Allis Chalmers 70671838; Fiat 70671809; New Holland 703409
O.D.: 12 1/32 (305.6)
 Boot Gasket 12 3/4 (323.9)
I.D.: 15/16 (23.8) & 7 23/32 (196.1)
Height: 23 1/2 (596.9)
A. Gskt: [2] Attached
F. Gskt: [1] Metal Washer
Related To: LL2361 (Long-Life Media Version) PA2361XP (Extreme Performance Nano Version)

Measurements Are Shown In Inches And (Millimeters)

WARNING: These products can expose you to chemicals, including Diisononyl Phthalate, Carbon black extracts, Nickel, 1,3 Butadiene, Ethylene Oxide, Epichlorohydrin, which are known to the State of California to cause cancer, and Bisphenol, Ethylene Glycol, Ethylene Oxide, 1,3 Butadiene, Epichlorohydrin, which are known to the State of California to cause birth defects or other reproductive harm. For more information go to www.P65Warnings.ca.gov.

PA2361XP



Extreme Performance Nano Outer Air Element

Fits: Allis Chalmers, Fiat-Allis, New Holland, Samsung Equipment
Use With: PA2362
Replaces: Allis Chalmers 70671838; Fiat 70671809; New Holland 703409
O.D.: 12 1/32 (305.6)
 Boot 12 3/4 (323.9)
I.D.: 15/16 (23.8) & 7 23/32 (196.1)
Height: 23 1/2 (596.9)
A. Gskt: [2] Attached
F. Gskt: [1] Metal Washer
Related To: LL2361 (Long-Life Media Version)
 PA2361 (Standard Media Version)

PA2364



Inner Air Element

Fits Inside: LL2363, PA2363, PA2363XP, LL2453, PA2453, PA2453XP
Fits: Caterpillar, Euclid, Hitachi, KW-Dart, Terex, Unit Rig, WABCO Equipment
Replaces: Caterpillar 9Y7663; KW-Dart 3040562; Terex 6945658; WABCO VS122185
O.D.: 10 29/32 (277.0)
I.D.: 29/32 (23.0) & 8 5/32 (207.2)
Height: 22 3/16 (563.6)
A. Gskt: [1] Attached
F. Gskt: [1] Included

PA2362



Inner Air Element

Fits Inside: LL2361, PA2361
Fits: Allis Chalmers, Fiat-Allis, New Holland, Samsung Equipment
Replaces: Allis Chalmers 70671839; Fiat 70671809; New Holland 703408
O.D.: 7 5/8 (193.7)
I.D.: 7/8 (22.2) & 6 1/16 (154.0)
Height: 21 15/32 (545.3)
A. Gskt: [1] Attached
F. Gskt: [1] Included

PA2367



Outer Air Element

Fits: Galion, John Deere, Komatsu, New Holland Equipment; Onan Generators
Use With: PA2368
Replaces: John Deere AR57024; New Holland 279627; Onan 140-1969
O.D.: 9 3/32 (231.0)
I.D.: 1/2 (12.7) & 4 13/16 (122.2)
Height: 19 7/8 (504.8)
A. Gskt: [1] Attached
F. Gskt: [1] Included

LL2363



Long Life Outer Air Element with Bail Handle

Fits: Caterpillar, Euclid, Hitachi, KW-Dart, Terex, Unit Rig, WABCO Equipment
Use With: PA2364
Replaces: Caterpillar 9Y6835; KW-Dart 3040562; Terex 6945659; WABCO VA2186
O.D.: 17 5/8 (447.7)
 Boot 18 5/16 (465.1)
I.D.: 15/16 (23.8) & 11 (279.4)
Height: 23 17/32 (597.7)
A. Gskt: [2] Attached
F. Gskt: [1] Included
Related To: PA2363 (Standard Media Version)
 PA2363XP (Extreme Performance Nano Version)

PA2368



Inner Air Element

Fits Inside: PA2367
Fits: Galion, John Deere, Komatsu, New Holland Equipment
Replaces: John Deere AR57025
O.D.: 4 21/32 (118.3)
I.D.: 5/8 (15.9) & 3 15/16 (100.0)
Height: 16 7/16 (417.5)
A. Gskt: [1] Attached
F. Gskt: G103-N

PA2363



Outer Air Element with Bail Handle

Fits: Caterpillar, Euclid, Hitachi, KW-Dart, Terex, Unit Rig, WABCO Equipment
Use With: PA2364
Replaces: Caterpillar 9Y6835; KW-Dart 3040562; Terex 6945659; WABCO VA2186
O.D.: 17 5/8 (447.7)
 Boot 18 5/16 (465.1)
I.D.: 15/16 (23.8) & 11 (279.4)
Height: 23 17/32 (597.7)
A. Gskt: [2] Attached
F. Gskt: [1] Included
Related To: LL2363 (Long-Life Media Version)
 PA2363XP (Extreme Performance Nano Version)

PA2369



Outer Air Element

Fits: Allis Chalmers, John Deere Equipment
Use With: PA2370
Replaces: Allis Chalmers 70263435; John Deere AR54336
O.D.: 7 11/32 (186.5)
I.D.: 7/16 (11.1) & 3 31/32 (100.8)
Height: 15 5/32 (385.0)
A. Gskt: [1] Attached
F. Gskt: [1] Included

PA2363XP



Extreme Performance Nano Outer Air Element with Lift Bar

Fits: Caterpillar, Euclid, Hitachi, KW-Dart, Terex, Unit Rig, WABCO Equipment
Use With: PA2364
Replaces: Caterpillar 9Y6835; KW-Dart 3040562; Terex 6945659; WABCO VA2186
O.D.: 17 5/8 (447.7)
 Boot 18 5/16 (465.1)
I.D.: 15/16 (23.8) & 11 (279.4)
Height: 23 17/32 (597.7)
A. Gskt: [2] Attached
F. Gskt: [1] Included
Related To: LL2363 (Long-Life Media Version)
 PA2363 (Standard Media Version)

PA2370



Inner Air Element

Fits Inside: PA2369
Fits: Allis Chalmers, John Deere Equipment
Replaces: Allis Chalmers 263434; John Deere AR54337
O.D.: 3 7/8 (98.4)
I.D.: 5/8 (15.9) & 3 3/16 (81.0)
Height: 13 3/16 (335.0)
A. Gskt: [1] Attached
F. Gskt: G103-N

PA2371



Outer Air Element

Fits: Case, Dresser, International Equipment
Use With: PA2372
Replaces: Case A47145
O.D.: 10 3/8 (263.5)
I.D.: 15/16 (23.8) & 6 1/32 (153.2)
Height: 12 1/2 (317.5)
A. Gskt: [1] Attached
F. Gskt: [2] Included

Measurements Are Shown In Inches And (Millimeters)

! **WARNING:** These products can expose you to chemicals, including Diisononyl Phthalate, Carbon black extracts, Nickel, 1,3 Butadiene, Ethylene Oxide, Epichlorohydrin, which are known to the State of California to cause cancer, and Bisphenol, Ethylene Glycol, Ethylene Oxide, 1,3 Butadiene, Epichlorohydrin, which are known to the State of California to cause birth defects or other reproductive harm. For more information go to www.P65Warnings.ca.gov.

PA2372

Inner Air Element



Fits Inside: PA2371
Fits: Case, Dresser, International Equipment
Replaces: Case A47146
O.D.: 5 31/32 (151.6)
I.D.: 5/8 (15.9) & 4 27/32 (123.0)
Height: 10 3/8 (263.5)
A. Gskt: [1] Attached
F. Gskt: G103-N

PA2379

Air Element



Fits: Ford Trucks
Replaces: Ford B4HF-9601-DA
O.D.: 10 (254.0)
 Lid 12 (304.8)
I.D.: 3/8 (9.5) & 4 15/16 (125.4)
Height: 9 7/16 (239.7)
A. Gskt: [2] Attached
F. Gskt: G39-AF
Related To: PA2379-K (with Reusable Lid Assembly)

PA2374

Air Element



Fits: Gardner Denver Compressors
Replaces: Gardner Denver 2010253
O.D.: 9 5/8 (244.5)
I.D.: 3/8 (9.5) & 4 3/32 (104.0)
Height: 15 1/16 (382.6)
A. Gskt: [1] Attached
F. Gskt: [1] Included

PA2379-K

Air Element with Reusable Lid Assembly



Fits: Ford Trucks
Replaces: Ford B4HF-9601-DA
O.D.: 10 (254.0)
 Lid 12 (304.8)
I.D.: 3/8 (9.5) & 4 15/16 (125.4)
Height: 9 7/16 (239.7)
A. Gskt: [2] Attached
F. Gskt: G39-AF
Related To: PA2379 (Filter only)

PA2375

DynaCell Panel Air Element



Notes: Open on both ends.
Fits: Ford Trucks; Ingersoll-Rand Compressors
Replaces: Ford D8HZ-9601-E; Ingersoll-Rand 35258177
Length: 19 (482.6)
Width: 19 (482.6)
Height: 5 3/8 (136.5)
Related To: PA2350 (Back is Closed)

PA2380-FN

Outer Air Element with Fins



Fits: Allis Chalmers, Atlas-Weyhausen, Fiat-Allis, Hough, International, J.C. Bamford, John Deere, Massey Ferguson Equipment
Use With: PA2381
Replaces: Allis Chalmers 1909128; Fiat 72099164; International 924779-C1; J.C. Bamford 32/203702; John Deere AE31723
O.D.: 5 1/4 (133.4)
 Fins 6 3/8 (161.9)
I.D.: 2 1/32 (16.7) & 3 1/4 (82.6)
Height: 12 15/32 (316.7)
A. Gskt: [1] Attached
F. Gskt: G103-N

PA2376

Air Element



Fits: International Engines
Replaces: International 439723-C91
O.D.: 12 1/32 (305.6)
I.D.: 5/8 (15.9) & 7 11/16 (195.3)
Height: 19 31/32 (507.2)
A. Gskt: [1] Attached
F. Gskt: G103-N

PA2381

Inner Air Element



Fits Inside: PA2380-FN, PA2392, PA3778
Fits: Allis Chalmers, Fiat-Allis, Hough, International, J.C. Bamford, John Deere, Massey Ferguson Equipment
Replaces: Allis Chalmers 1909129; Fiat 79022026; International 537335-R3; J.C. Bamford 32/203703; John Deere AE31724
O.D.: 2 31/32 (75.4)
 Flange 3 21/32 (92.9)
I.D.: 5/8 (15.9) & 2 7/16 (61.9)
Height: 11 1/8 (282.6)
A. Gskt: [1] Attached
F. Gskt: G39-AF

PA2377

Outer Air Element



Fits: Hough, International Equipment
Use With: PA2378
Replaces: International 925761-C1
O.D.: 10 (254.0)
I.D.: 3/8 (9.5) & 5 1/2 (139.7)
Height: 20 7/8 (530.2)
A. Gskt: [1] Attached
F. Gskt: [1] Included

PA2382

Air Element



Replaces: Blue Bird 3022107241
O.D.: 10 3/8 (263.5)
I.D.: 6 1/32 (153.2) One End
Height: 17 13/16 (452.4)
A. Gskt: [2] Attached
F. Gskt: G21-AF

PA2378

Inner Air Element



Fits Inside: PA2377
Fits: Hough, International Equipment
Replaces: International 925762-C1
O.D.: 5 1/4 (133.4)
I.D.: 5/8 (15.9) & 4 1/8 (104.8)
Height: 19 7/16 (493.7)
A. Gskt: [1] Attached
F. Gskt: G103-N

Measurements Are Shown In Inches And (Millimeters)

WARNING: These products can expose you to chemicals, including Diisononyl Phthalate, Carbon black extracts, Nickel, 1,3 Butadiene, Ethylene Oxide, Epichlorohydrin, which are known to the State of California to cause cancer, and Bisphenol, Ethylene Glycol, Ethylene Oxide, 1,3 Butadiene, Epichlorohydrin, which are known to the State of California to cause birth defects or other reproductive harm. For more information go to www.P65Warnings.ca.gov.

PA2383 Air Element
Fits: International Wheel Tractors
Replaces: International 529957-R1
O.D.: 5 7/16 (138.1)
 Boot 6 3/8 (161.9)
I.D.: 2 27/32 (72.2) One End
Height: 10 7/8 (276.2)
A. Gskt: [2] Attached



PA2387 Outer Air Element with Lift Tabs
Fits: Versatile Tractors
Use With: PA2388
Replaces: Versatile 15803
O.D.: 9 5/8 (244.5)
 Flange 11 1/2 (292.1)
I.D.: 6 3/16 (157.2) One End
Height: 20 7/16 (519.1)
A. Gskt: [2] Attached



LL2384 Long Life Outer Air Element
Fits: Caterpillar Equipment, Industrial Engines
Use With: PA2385, PA2625, PA2647, PA2735
Replaces: Caterpillar 1P8483, 8N5313
O.D.: 12 1/2 (317.5)
I.D.: 9 1/8 (231.8) One End
Height: 15 1/2 (393.7)
A. Gskt: [1] Attached
Related To: PA2384 (Standard Media Version)
 PA2384XP (Extreme Performance Nano Version)



PA2388 Inner Air Element
Fits Inside: PA2345, PA2386, PA2387
Fits: John Deere Equipment; New Holland, Versatile Tractors
Replaces: John Deere AT49021
O.D.: 6 1/8 (155.6)
I.D.: 1/2 (12.7) & 4 15/16 (125.4)
Height: 18 5/16 (465.1)
A. Gskt: [1] Attached
F. Gskt: G20-AF, [1] Wing Nut



PA2384 Outer Air Element
Fits: Caterpillar Equipment, Industrial Engines
Use With: PA2385, PA2625, PA2647, PA2735
Replaces: Caterpillar 1P8483, 8N5313
O.D.: 12 1/2 (317.5)
I.D.: 9 1/8 (231.8) One End
Height: 15 1/2 (393.7)
A. Gskt: [1] Attached
Related To: LL2384 (Long-Life Media Version)
 PA2384XP (Extreme Performance Nano Version)



PA2389-FN Air Element with Fins and Lift Tabs
Replaces: White 27-077288
O.D.: 13 7/8 (352.4)
 Fins 15 3/4 (400.1)
I.D.: 5/8 (15.9) & 7 7/16 (188.9)
Height: 12 1/2 (317.5)
A. Gskt: [1] Attached
F. Gskt: G103-N



PA2384XP Extreme Performance Nano Outer Air Element
Fits: Caterpillar Equipment, Industrial Engines
Use With: PA2385, PA2625, PA2647, PA2735
Replaces: Caterpillar 1P8483, 8N5313
O.D.: 12 1/2 (317.5)
I.D.: 9 1/8 (231.8) One End
Height: 15 1/2 (393.7)
A. Gskt: [1] Attached
Related To: LL2384 (Long-Life Media Version)
 PA2384 (Standard Media Version)



PA2390 Set of 2 DynaCell Panel Air Elements
Notes: Uses 2 filters per application.
Fits: Industrial Applications
Replaces: Farr C29360-2, R300
Each Filter:
Length: 45 3/8 (1152.5)
Width: 14 (355.6)
Height: 6 3/16 (157.2)

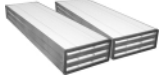

PA2385 Inner Air Element with 10 Bolt Holes
Fits Inside: LL2384, PA2384, PA2384XP, LL2609, PA2609
Fits: Caterpillar Equipment, Industrial Engines
Replaces: Caterpillar 1P8482, 7N1308
O.D.: 8 5/8 (219.1)
 Flange 11 3/8 (288.9)
I.D.: 6 31/32 (177.0) One End
Height: 15 1/4 (387.4)
A. Gskt: [1] Attached



PA2391 Outer Air Element
Fits: International Wheel Tractors
Use With: PA2489, PA2700
Replaces: International 529854-R2
O.D.: 5 7/16 (138.1)
 Boot 6 3/8 (161.9)
I.D.: 2 27/32 (72.2) One End
Height: 11 7/8 (301.6)
A. Gskt: [2] Attached



PA2386 Outer Air Element with Lift Tab
Fits: New Holland, Versatile Tractors
Use With: PA2388
Replaces: New Holland V22930; Versatile 22930
O.D.: 10 17/32 (267.5)
 Boot 12 (304.8)
I.D.: 6 7/8 (174.6) One End
Height: 20 3/8 (517.5)
A. Gskt: [2] Attached



PA2392 Outer Air Element with Bail Handle
Fits: International Wheel Tractors
Use With: PA2381
Replaces: International 537334-R1
O.D.: 6 3/32 (154.8)
I.D.: 3 15/32 (88.1) One End
Height: 13 5/16 (338.1)
A. Gskt: [1] Attached
Related To: PA2314 (Long Version)



Measurements Are Shown In Inches And (Millimeters)

WARNING: These products can expose you to chemicals, including Diisononyl Phthalate, Carbon black extracts, Nickel, 1,3 Butadiene, Ethylene Oxide, Epichlorohydrin, which are known to the State of California to cause cancer, and Bisphenol, Ethylene Glycol, Ethylene Oxide, 1,3 Butadiene, Epichlorohydrin, which are known to the State of California to cause birth defects or other reproductive harm. For more information go to www.P65Warnings.ca.gov.

LL2393



Long Life Air Element with Lid and 6 Bolt Holes
Fits: WhiteGMC Trucks
Replaces: White 27-092086
O.D.: 12 3/4 (323.9)
 Lid 16 5/32 (410.4)
I.D.: 7 7/16 (188.9) One End
Height: 19 1/2 (495.3)
A. Gskt: [2] Attached
Related To: PA2393 (Standard Media Version)

PA2398



Air Element
Fits: R.V.I. Trucks
Replaces: Renault 5000819342
O.D.: 12 3/4 (323.9)
I.D.: 8 11/32 (211.9) One End
Height: 21 (533.4)
A. Gskt: [2] Attached
F. Gskt: G25-AF
Related To: PA2437 (Short Version)

PA2393



Air Element with Lid and 6 Bolt Holes
Fits: WhiteGMC Trucks
Replaces: White 27-092086
O.D.: 12 3/4 (323.9)
 Lid 16 5/32 (410.4)
I.D.: 7 7/16 (188.9) One End
Height: 19 1/2 (495.3)
A. Gskt: [2] Attached
Related To: LL2398 (Long-Life Media Version)

PA2399



Air Element
Fits: American LaFrance Trucks;
 Ingersoll-Rand Compressors
Replaces: American LaFrance 1020900;
 Ingersoll-Rand 35253921
O.D.: 17 5/8 (447.7)
I.D.: 15/16 (23.8) & 11 1/32 (280.2)
Height: 8 1/32 (204.0)
A. Gskt: [2] Attached
F. Gskt: [1] Included

PA2394



Air Element with Lid and 6 Bolt Holes
Fits: Allmand Equipment; International Trucks
Replaces: International 417075-C91
O.D.: 13 7/8 (352.4)
 Lid 16 1/8 (409.6)
I.D.: 7 7/16 (188.9) One End
Height: 21 1/2 (546.1)
A. Gskt: [2] Attached

PA2401



Outer Air Element
Fits: Massey Ferguson Wheel Tractors
Use With: PA2402
Replaces: Massey Ferguson 1041845-M91
O.D.: 7 15/16 (201.6)
 Boot 9 (228.6)
I.D.: 11/16 (17.5) & 5 3/8 (136.5)
Height: 13 3/8 (339.7)
A. Gskt: [2] Attached
F. Gskt: G103-N

PA2395



Set of 2 DynaCell Panel Air Elements
Notes: Uses 2 filters per application.
Fits: Industrial Applications
Replaces: Farr C55445-1, RC250
Each Filter:
Length: 36 7/16 (925.5)
Width: 14 (355.6)
Height: 6 3/16 (157.2)

PA2402



Inner Air Element
Fits Inside: PA2401
Fits: Massey Ferguson Wheel Tractors
Replaces: Massey Ferguson 1041846-M91
O.D.: 5 1/4 (133.4)
I.D.: 5/8 (15.9) & 4 1/8 (104.8)
Height: 12 1/4 (311.2)
A. Gskt: [1] Attached
F. Gskt: G103-N

PA2396



Outer Air Element with Lift Tabs
Fits: Versatile Tractors
Use With: PA2397
Replaces: Versatile 22934
O.D.: 12 1/16 (306.4)
 Boot 14 (355.6)
I.D.: 7 11/16 (195.3) One End
Height: 20 3/8 (517.5)
A. Gskt: [2] Attached

PA2403



Outer Air Element with Lift Tabs
Fits: Case Tractors
Use With: PA2404
Replaces: Case A44694
O.D.: 12 1/16 (306.4)
 Boot 13 (330.2)
I.D.: 5/8 (15.9) & 7 11/16 (195.3)
Height: 7 1/8 (181.0)
A. Gskt: [2] Attached
F. Gskt: G103-N

PA2397



Inner Air Element
Fits Inside: PA2396
Fits: Versatile Tractors
Replaces: Versatile 22935
O.D.: 7 1/8 (181.0)
I.D.: 17/32 (13.5) & 5 13/16 (147.6)
Height: 18 1/4 (463.6)
A. Gskt: [1] Attached
F. Gskt: [1] Included

PA2404



Inner Air Element
Fits Inside: PA2403
Fits: Case Tractors
Replaces: Case A44695
O.D.: 6 7/8 (174.6)
I.D.: 21/32 (16.7) & 4 3/16 (106.4)
Height: 5 1/4 (133.4)
A. Gskt: [1] Attached
F. Gskt: G103-N

Measurements Are Shown In Inches And (Millimeters)

WARNING: These products can expose you to chemicals, including Diisononyl Phthalate, Carbon black extracts, Nickel, 1,3 Butadiene, Ethylene Oxide, Epichlorohydrin, which are known to the State of California to cause cancer, and Bisphenol, Ethylene Glycol, Ethylene Oxide, 1,3 Butadiene, Epichlorohydrin, which are known to the State of California to cause birth defects or other reproductive harm. For more information go to www.P65Warnings.ca.gov.

PA2405



Outer Air Element

Fits: Atlas Copco Compressors; Bomag, Claas, Dynapac, Iveco, John Deere, Liebherr, Volvo Equipment; DAF, Iveco, Mercedes-Benz, R.V.I., Scania Buses, Trucks
Use With: PA2835
Replaces: Atlas Copco 16192487; Bomag 5851012; Iveco 4776902; Mercedes-Benz 130941802; Volvo 7362224, 7362224-3
O.D.: 7 13/16 (198.4)
I.D.: 11/32 (8.7) & 4 3/32 (104.0)
Height: 14 3/4 (374.7)
A. Gskt: [1] Attached
F. Gskt: [1] Included

PA2406



Air Element with Lid and 6 Bolt Holes

Fits: International Trucks
Replaces: International 424181-C91
O.D.: 13 7/8 (352.4)
 Lid 16 1/8 (409.6)
I.D.: 7 7/16 (188.9) One End
Height: 7 1/2 (190.5)
A. Gskt: [2] Attached

PA2407



Cab Air Element

Notes: If gasket is removed from International housing, use PA2619 instead.
Fits: Case, International, John Deere, Minneapolis-Moline, Versatile, White Equipment
Replaces: Case A42573; International 109215-C1; Versatile 105382; White 20-7000329
Length: 38 (965.2)
Width: 6 (152.4)
Height: 2 3/16 (55.6)
Related To: PA2619 (with Attached Gasket)

PA2408



Cab Air Element

Fits: John Deere, White Equipment
Replaces: John Deere AH80212
Length: 37 (939.8)
Width: 6 (152.4)
Height: 2 3/16 (55.6)

PA2409



Outer Air Element

Fits: Dresser, Hough, International, Steiger Equipment
Use With: PA2410
Replaces: International 680587-C2
O.D.: 12 1/32 (305.6)
I.D.: 7/8 (22.2) & 7 11/16 (195.3)
Height: 18 1/2 (469.9)
A. Gskt: [1] Attached
F. Gskt: G129-N

PA2410



Inner Air Element

Fits Inside: PA2409, PA5751
Fits: Dresser, Gleaner, Hough, International, Massey Ferguson Steiger Equipment
Replaces: International 681911-C91
O.D.: 7 5/8 (193.7)
I.D.: 5/8 (15.9) & 6 1/16 (154.0)
Height: 17 3/8 (441.3)
A. Gskt: [1] Attached
F. Gskt: G103-N

PA2411



Cab Air Element

Fits: Ag-Chem, Hesston, International, Rickel Mfg. Equipment
Replaces: International 537268-R1
Length: 38 (965.2)
Width: 5 (127.0)
Height: 2 3/16 (55.6)

PA2412



Air Element with Air Restriction Gauge Fitting

Fits: Ford Buses, Trucks
Replaces: Ford D2HZ-9601-A
O.D.: 9 5/16 (236.5)
I.D.: 17/32 (13.5) & 4 27/32 (123.0)
Height: 10 7/16 (265.1)
A. Gskt: [1] Attached
F. Gskt: [1] Included
Related To: PA1840 (without Air Restriction Gauge Fitting)

PA2413



Inner Air Element

Fits Inside: PA1926, PA3698
Fits: Caterpillar Equipment; Mitsubishi Lift Trucks
Replaces: Caterpillar 4N313, 4N0313
O.D.: 3 3/8 (85.7)
I.D.: 11/16 (17.5) & 2 1/4 (57.2)
Height: 10 1/4 (260.4)
A. Gskt: [1] Attached
F. Gskt: G103-N

PA2414



Outer Air Element

Fits: Dresser, Hough, International Equipment
Use With: PA2415
Replaces: International 672019-C1
O.D.: 12 1/32 (305.6)
I.D.: 5/8 (15.9) & 7 11/16 (195.3)
Height: 13 1/2 (342.9)
F. Gskt: G103-N

PA2415



Inner Air Element

Fits Inside: PA2414
Fits: Dresser, Hough, International Equipment
Replaces: International 672020-C1
O.D.: 7 5/8 (193.7)
I.D.: 5/8 (15.9) & 6 1/16 (154.0)
Height: 12 3/8 (314.3)
A. Gskt: [1] Attached
F. Gskt: G103-N

PA2417-FN



Air Element with Fins

Fits: Grove Cranes
Replaces: Grove 9304100069
O.D.: 12 1/16 (306.4)
 Fins 13 3/4 (349.3)
I.D.: 5/8 (15.9) & 5 11/16 (144.5)
Height: 12 7/16 (315.9)
A. Gskt: [1] Attached
F. Gskt: G103-N

Measurements Are Shown In Inches And (Millimeters)

WARNING: These products can expose you to chemicals, including Diisononyl Phthalate, Carbon black extracts, Nickel, 1,3 Butadiene, Ethylene Oxide, Epichlorohydrin, which are known to the State of California to cause cancer, and Bisphenol, Ethylene Glycol, Ethylene Oxide, 1,3 Butadiene, Epichlorohydrin, which are known to the State of California to cause birth defects or other reproductive harm. For more information go to www.P65Warnings.ca.gov.

LL2418-FN



Long Life Outer Air Element with Fins

Fits: Allis Chalmers, Case, Caterpillar, Dresser, Fiat-Allis, John Deere, Kobelco, Komatsu, New Holland Equipment
Use With: PA2305, PA2332, PA2419
Replaces: Allis Chalmers 79011386; Case D56453; Caterpillar 7E0975; Fiat 73067507; Kobelco 2451U124-3A; Komatsu 600-181-9240
O.D.: 6 3/32 (154.8)
Fins 7 13/16 (198.4)
I.D.: 3/4 (19.1) & 3 15/32 (88.1)
Height: 15 5/16 (388.9)
A. Gskt: [1] Attached
F. Gskt: G103-N
Related To: PA2418-FN (Standard Media Version)

PA2418-FN



Outer Air Element with Fins

Fits: Allis Chalmers, Case, Caterpillar, Dresser, Fiat-Allis, John Deere, Kobelco, Komatsu, New Holland Equipment
Use With: PA2305, PA2332, PA2419
Replaces: Allis Chalmers 79011386; Case D56453; Caterpillar 7E0975; Fiat 73067507; Kobelco 2451U124-3A; Komatsu 600-181-9240
O.D.: 6 3/32 (154.8)
Fins 7 13/16 (198.4)
I.D.: 3/4 (19.1) & 3 15/32 (88.1)
Height: 15 5/16 (388.9)
A. Gskt: [1] Attached
F. Gskt: G103-N
Related To: LL2418-FN (Long-Life Media Version)

PA2419



Inner Air Element

Fits Inside: LL2418-FN, PA2418-FN, PA2420, PA2977-FN, PA3669-FN, PA3690, PA3751-FN, PA4697-FN
Fits: Allis Chalmers, Case, Caterpillar, Fiat-Allis, Hanomag, J.C. Bamford, Massey Ferguson, New Holland Equipment
Replaces: Allis Chalmers 79011387; Case L55204; Caterpillar 5W5890; Fiat 70257029; J.C. Bamford 32/202601; Massey Ferguson 1093683-M92
O.D.: 3 3/8 (85.7)
Flange 4 5/32 (105.6)
I.D.: 5/8 (15.9) & 2 29/32 (73.8)
Height: 14 3/32 (358.0)
A. Gskt: [1] Attached
F. Gskt: G103-N

PA2420



Outer Air Element

Use With: PA2419
Replaces: Massey Ferguson 1428748-M91
O.D.: 6 3/32 (154.8)
I.D.: 3/4 (19.1) & 3 15/32 (88.1)
Height: 15 5/16 (388.9)
A. Gskt: [1] Attached
F. Gskt: G103-N

PA2421



Outer Air Element with Lift Bar

Fits: Agco, Case, John Deere, White Equipment
Use With: PA1967
Replaces: Agco 72162545; John Deere AT43963; White 20-7002186
O.D.: 9 7/32 (234.2)
I.D.: 5/8 (15.9) & 4 27/32 (123.0)
Height: 12 1/2 (317.5)
A. Gskt: [1] Attached
F. Gskt: G103-N

PA2422



Outer Air Element with Lift Bar

Fits: Allis Chalmers, Deutz, Fendt Tractors
Use With: PA3682, PA3684
Replaces: Deutz 2311565
O.D.: 6 15/32 (164.3)
I.D.: 3 11/32 (84.9) One End
Height: 8 1/4 (209.6)
A. Gskt: [1] Attached
Related To: PA2423 (Long Version)

PA2423



Outer Air Element with Lift Bar

Fits: Allis Chalmers, Bomag, Davis, Deutz Equipment
Use With: PA3683, PA3685
Replaces: Allis Chalmers 99100307; Deutz 2322855
O.D.: 6 15/32 (164.3)
I.D.: 3 11/32 (84.9) One End
Height: 13 3/32 (332.6)
A. Gskt: [1] Attached
Related To: PA2422 (Short Version)

LL2425



Long Life Air Element

Fits: Ag-Chem Equipment; Ford Trucks
Replaces: Ford D5HZ-9601-D
O.D.: 10 3/8 (263.5)
I.D.: 6 1/32 (153.2) One End
Height: 16 (406.4)
A. Gskt: [2] Attached
F. Gskt: G21-AF
O. Gskt: G499-AF
Related To: PA2425 (Standard Media Version)

PA2425



Air Element

Fits: Ag-Chem Equipment; Ford Trucks
Replaces: Ford D5HZ-9601-D
O.D.: 10 3/8 (263.5)
I.D.: 6 1/32 (153.2) One End
Height: 16 (406.4)
A. Gskt: [2] Attached
F. Gskt: G21-AF
O. Gskt: G499-AF
Related To: LL2425 (Long-Life Media Version)

Measurements Are Shown In Inches And (Millimeters)

WARNING: These products can expose you to chemicals, including Diisononyl Phthalate, Carbon black extracts, Nickel, 1,3 Butadiene, Ethylene Oxide, Epichlorohydrin, which are known to the State of California to cause cancer, and Bisphenol, Ethylene Glycol, Ethylene Oxide, 1,3 Butadiene, Epichlorohydrin, which are known to the State of California to cause birth defects or other reproductive harm. For more information go to www.P65Warnings.ca.gov.

LL2426-FN



Long Life Outer Air Element with Fins
Fits: Allis Chalmers, Atlas-Weyhausen, Clark, John Deere, Kobelco, Massey Ferguson, Michigan, Vermeer, Versatile Equipment
Use With: PA2427
Replaces: Clark 961000; Grove 9437100309; John Deere AZ25868; Kobelco 2446R277S5; Versatile V103344
O.D.: 6 7/8 (174.6)
Fins: 8 3/4 (222.3)
I.D.: 21/32 (16.7) & 4 3/16 (106.4)
Height: 16 3/8 (415.9)
A. Gskt: [1] Attached
F. Gskt: G103-N
Related To: PA2426-FN (Standard Media Version)

PA2426-FN



Outer Air Element with Fins
Fits: Allis Chalmers, Atlas-Weyhausen, Clark, John Deere, Kobelco, Massey Ferguson, Michigan, Vermeer, Versatile Equipment
Use With: PA2427
Replaces: Clark 961000; Grove 9437100309; John Deere AZ25868; Kobelco 2446R277S5; Versatile V103344
O.D.: 6 7/8 (174.6)
Fins: 8 3/4 (222.3)
I.D.: 21/32 (16.7) & 4 3/16 (106.4)
Height: 16 3/8 (415.9)
A. Gskt: [1] Attached
F. Gskt: G103-N
Related To: LL2426-FN (Long-Life Media Version)

PA2427



Inner Air Element
Fits Inside: LL2426-FN, PA2426-FN
Fits: Allis Chalmers, Atlas-Weyhausen, Clark, Grove, John Deere, Kobelco, Massey Ferguson, Michigan, New Holland, Vermeer, Versatile Equipment
Replaces: Clark 961001; John Deere AZ25867; Kobelco 2446R277S6; Versatile V90183
O.D.: 4 3/32 (104.0)
Flange: 4 25/32 (121.4)
I.D.: 25/32 (19.8) & 3 5/8 (92.1)
Height: 15 3/32 (383.4)
A. Gskt: [1] Attached
F. Gskt: G103-N

PA2428



Air Element
Replaces: International 472099-C1
O.D.: 12 1/16 (306.4)
I.D.: 5/8 (15.9) & 5 11/16 (144.5)
Height: 17 11/16 (449.3)
A. Gskt: [1] Attached
F. Gskt: G103-N
Related To: PA2429 (Short Version)

PA2429



Air Element
Fits: International, WhiteGMC Trucks
Replaces: GMC 8995417; International 472088-C91
O.D.: 12 1/16 (306.4)
I.D.: 5/8 (15.9) & 5 11/16 (144.5)
Height: 15 11/16 (398.5)
A. Gskt: [1] Attached
F. Gskt: G103-N
Related To: PA2428 (Long Version)

PA2430



Air Element
Fits: Ford Buses, Trucks
Replaces: Ford D5HZ-9601-C
O.D.: 10 3/8 (263.5)
I.D.: 6 1/32 (153.2) One End
Height: 20 15/16 (531.8)
A. Gskt: [2] Attached
F. Gskt: G21-AF
O. Gskt: G499-AF
Related To: PA2425 (Short Version)

PA2431



Outer Air Element with Lift Bar
Fits: Ford, New Holland Equipment
Use With: PA1809, PA2432
Replaces: Ford D1NN-9601-A
O.D.: 6 11/16 (169.9)
Boot Gasket: 7 1/2 (190.5)
I.D.: 1/2 (12.7) & 3 3/4 (95.3)
Height: 15 5/16 (388.9)
A. Gskt: [2] Attached
F. Gskt: [1] Included

PA2432



Inner Air Element
Fits Inside: PA2431
Fits: Ford, New Holland Equipment
Replaces: Ford D1NN-9R500-A
O.D.: 3 5/8 (92.1)
I.D.: 1/2 (12.7) & 2 15/16 (74.6)
Height: 13 7/8 (352.4)
A. Gskt: [1] Attached
F. Gskt: [1] Included

PA2433



Outer Air Element with Lift Bar
Fits: Ford, Versatile Tractors
Use With: PA2308
Replaces: Ford D2NN-9601-A; Versatile 24575
O.D.: 7 15/16 (201.6)
Boot: 10 (254.0)
I.D.: 1/2 (12.7) & 4 5/8 (117.5)
Height: 14 1/2 (368.3)
A. Gskt: [2] Attached
F. Gskt: [1] Included

PA2434



Outer Air Element with Lift Tab
Fits: Allis Chalmers, Case-International, John Deere, New Idea Equipment
Use With: PA2435
Replaces: Allis Chalmers 70264739; International 67685-C92; John Deere AT44631; New Idea 730760
O.D.: 9 (228.6)
Boot Gasket: 10 (254.0)
I.D.: 5 11/16 (144.5) One End
Height: 16 9/16 (420.7)
A. Gskt: [2] Attached

PA2435



Inner Air Element
Fits Inside: PA2434, PA2569
Fits: Allis Chalmers, Case-International, Ford, John Deere, New Idea Equipment
Replaces: Allis Chalmers 70264740; Ford D5NN-9R500-C; International 67685-C92; John Deere AT44632; New Idea 730761
O.D.: 5 9/16 (141.3)
I.D.: 1/2 (12.7) & 4 13/32 (111.9)
Height: 15 21/32 (397.7)
F. Gskt: G20-AF, [1] Wing Nut

Measurements Are Shown In Inches And (Millimeters)

! **WARNING:** These products can expose you to chemicals, including Diisononyl Phthalate, Carbon black extracts, Nickel, 1,3 Butadiene, Ethylene Oxide, Epichlorohydrin, which are known to the State of California to cause cancer, and Bisphenol, Ethylene Glycol, Ethylene Oxide, 1,3 Butadiene, Epichlorohydrin, which are known to the State of California to cause birth defects or other reproductive harm. For more information go to www.P65Warnings.ca.gov.

PA2436

Cab Air Element with Pull Tabs

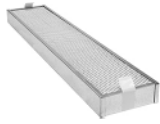

Fits: International Equipment;
Stolper Fresh Air Blowers
Replaces: International 175568-C1
Length: 32 (812.8)
Width: 6 3/4 (171.5)
Height: 2 3/16 (55.6)

PA2437

Air Element



Replaces: Brockway 221389
O.D.: 12 3/4 (323.9)
I.D.: 8 11/32 (211.9) One End
Height: 18 (457.2)
A. Gskt: [2] Attached
F. Gskt: G25-AF
Related To: PA2398 (Long Version)

PA2438

Inter-Cooler Air Element



Notes: Inside-Out Flow Direction.
Sometimes used with LL2439, PA2439
in vertical housing, or PA2494
in horizontal housing.
Fits: Brockway, Mack Trucks
Replaces: Mack 57MD21
O.D.: 12 3/4 (323.9)
I.D.: 8 11/32 (211.9)
Height: 9 (228.6)
A. Gskt: [2] Attached
F. Gskt: G25-AF
O. Gskt: G422-AF

LL2439

Long Life Air Element



Notes: Inside-Out Flow Direction.
Sometimes used with PA2438 in vertical
housing.
Fits: Brockway, Mack Trucks
Replaces: Mack 57MD31
O.D.: 12 3/4 (323.9)
I.D.: 8 11/32 (211.9) One End
Height: 15 (381.0)
A. Gskt: [2] Attached
F. Gskt: G25-AF
O. Gskt: G422-AF
Related To: PA2439 (Standard Media Version)

PA2439

Air Element



Notes: Inside-Out Flow Direction.
Sometimes used with PA2438 in vertical
housing.
Fits: Brockway, Mack Trucks
Replaces: Mack 57MD31
O.D.: 12 3/4 (323.9)
I.D.: 8 11/32 (211.9) One End
Height: 15 (381.0)
A. Gskt: [2] Attached
F. Gskt: G25-AF
O. Gskt: G422-AF
Related To: LL2439 (Long-Life Media Version)

PA2440

Cab Air Element



Fits: Case-International, Hesston, Hough,
Massey Ferguson, Michigan Equipment
Replaces: Case 8022345
Length: 33 (838.2)
Width: 6 1/2 (165.1)
Height: 2 3/16 (55.6)

PA2441

Air Element



Replaces: Brockway 221399
O.D.: 10 3/8 (263.5)
I.D.: 6 1/32 (153.2) One End
Height: 19 13/16 (503.2)
A. Gskt: [2] Attached
F. Gskt: G21-AF

PA2442

Outer Air Element



Fits: International, Massey Ferguson
Equipment
Use With: PA2443
Replaces: International 702641-C1
O.D.: 10 (254.0)
I.D.: 3/8 (9.5) & 5 1/2 (139.7)
Height: 17 5/16 (439.7)
A. Gskt: [1] Attached
F. Gskt: [1] Included

PA2443

Inner Air Element



Fits Inside: PA2442
Fits: International, Massey Ferguson
Equipment
Replaces: International 702642-C1
O.D.: 5 1/4 (133.4)
I.D.: 21/32 (16.7) & 4 1/8 (104.8)
Height: 16 3/32 (408.8)
A. Gskt: [1] Attached
F. Gskt: G103-N

PA2444

DynaCell Panel Air Element

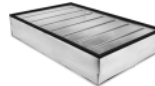

Notes: Front is open, sides are closed.
Replaces: Farr C51800, T528;
White 22-0010087
Length: 28 1/2 (723.9)
Width: 19 (482.6)
Height: 5 3/8 (136.5)
Related To: PA2564 (Both Sides Open)

PA2445

Outer Air Element



Fits: Case Equipment
Use With: PA2446
Replaces: Case A44804
O.D.: 13 7/8 (352.4)
I.D.: 11/16 (17.5) & 7 7/16 (188.9)
Height: 9 1/2 (241.3)
A. Gskt: [1] Attached
F. Gskt: G103-N

PA2446

Inner Air Element



Fits Inside: PA2445
Fits: Case Equipment
Replaces: Case A44805
O.D.: 6 7/8 (174.6)
I.D.: 21/32 (16.7) & 4 3/16 (106.4)
Height: 8 3/8 (212.7)
A. Gskt: [1] Attached
F. Gskt: G103-N

Measurements Are Shown In Inches And (Millimeters)

WARNING: These products can expose you to chemicals, including Diisononyl Phthalate, Carbon black extracts, Nickel, 1,3 Butadiene, Ethylene Oxide, Epichlorohydrin, which are known to the State of California to cause cancer, and Bisphenol, Ethylene Glycol, Ethylene Oxide, 1,3 Butadiene, Epichlorohydrin, which are known to the State of California to cause birth defects or other reproductive harm. For more information go to www.P65Warnings.ca.gov.

LL2447-FN

Long Life Air Element with Fins
Replaces: Donaldson P181066
O.D.: 13 7/8 (352.4)
 Fins 15 25/32 (400.8)
I.D.: 5/8 (15.9) & 9 1/2 (241.3)
Height: 14 3/8 (365.1)
A. Gskt: [1] Attached
F. Gskt: [1] Included
Related To: PA2447-FN (Standard Media Version)



PA2447-FN

Air Element with Fins
Replaces: Donaldson P181066
O.D.: 13 7/8 (352.4)
 Fins 15 25/32 (400.8)
I.D.: 5/8 (15.9) & 9 1/2 (241.3)
Height: 14 3/8 (365.1)
A. Gskt: [1] Attached
F. Gskt: [1] Included
Related To: LL2447-FN (Long-Life Media Version)



PA2448

Cab Air Element
Fits: Allis Chalmers Tractors
Replaces: Allis Chalmers 579916
Length: 26 3/4 (679.5)
Width: 7 3/4 (196.9)
Height: 2 3/16 (55.6)



PA2450

DynaCell Panel Air Element
Fits: Blaw-Knox, Cedarapids Road Building Equipment; Ottawa Trucks
Replaces: Farr T512, C49261; Ottawa 99105821
Length: 15 (381.0)
Width: 11 1/2 (292.1)
Height: 5 1/2 (139.7)



PA2451

Outer Air Element
Fits: Komatsu Equipment
Use With: PA2452
Replaces: Komatsu 600-181-3300
O.D.: 9 7/32 (234.2)
I.D.: 21/32 (16.7) & 4 27/32 (123.0)
Height: 15 1/2 (393.7)
A. Gskt: [1] Attached
F. Gskt: G103-N



PA2452

Inner Air Element
Fits Inside: PA2451
Fits: Komatsu Equipment
Replaces: Komatsu 669-181-7310
O.D.: 4 9/16 (115.9)
 Flange 5 23/32 (145.3)
I.D.: 21/32 (16.7) & 3 7/16 (87.3)
Height: 14 23/32 (373.9)
A. Gskt: [1] Attached
F. Gskt: G103-N



LL2453

Long Life Outer Air Element with Bail Handle
Fits: Case, Caterpillar, Driltech, KW-Dart, Terex, WABCO Equipment; Euclid, Komatsu Trucks
Use With: PA2364, PA2454
Replaces: Caterpillar 1W3637; Driltech 103653; Euclid 9038350; Komatsu 581-021-2120; WABCO VJ5175
O.D.: 17 5/8 (447.7)
 Boot 18 5/16 (465.1)
I.D.: 15/16 (23.8) & 12 1/8 (308.0)
Height: 23 17/32 (597.7)
A. Gskt: [2] Attached
F. Gskt: [1] Included
Related To: PA2453 (Standard Media Version) PA2453XP (Extreme Performance Nano Version)



PA2453

Outer Air Element with Bail Handle
Fits: Case, Caterpillar, Driltech, KW-Dart, Terex, WABCO Equipment; Euclid, Komatsu Trucks
Use With: PA2364, PA2454
Replaces: Caterpillar 1W3637; Driltech 103653; Euclid 9038350; Komatsu 581-021-2120; WABCO VJ5175
O.D.: 17 5/8 (447.7)
 Boot 18 5/16 (465.1)
I.D.: 15/16 (23.8) & 12 1/8 (308.0)
Height: 23 17/32 (597.7)
A. Gskt: [2] Attached
F. Gskt: [1] Included
Related To: LL2453 (Long-Life Media Version) PA2453XP (Extreme Performance Nano Version)



PA2453XP

Extreme Performance Nano Outer Air Element with Bail Handle
Fits: Case, Caterpillar, Driltech, KW-Dart, Terex, WABCO Equipment; Euclid, Komatsu Trucks
Use With: PA2364, PA2454
Replaces: Caterpillar 1W3637; Driltech 103653; Euclid 9038350; Komatsu 581-021-2120; WABCO VJ5175
O.D.: 17 5/8 (447.7)
 Boot 18 5/16 (465.1)
I.D.: 15/16 (23.8) & 12 1/8 (308.0)
Height: 23 17/32 (597.7)
A. Gskt: [2] Attached
F. Gskt: [1] Included
Related To: LL2453 (Long-Life Media Version) PA2453 (Standard Media Version)



PA2454

Inner Air Element
Fits Inside: PA2453, PA2453XP
Fits: Case, Caterpillar, Driltech, KW-Dart, Terex, WABCO Equipment; Euclid, Komatsu Trucks
Replaces: Caterpillar 1W3636; Driltech 103661; Euclid 9038349; Komatsu 581-021-2130; WABCO VJ5176
O.D.: 11 7/8 (301.6)
I.D.: 7/8 (22.2) & 10 1/4 (260.4)
Height: 22 1/2 (571.5)
A. Gskt: [1] Attached
F. Gskt: [1] Included



Measurements Are Shown In Inches And (Millimeters)

! **WARNING:** These products can expose you to chemicals, including Diisononyl Phthalate, Carbon black extracts, Nickel, 1,3 Butadiene, Ethylene Oxide, Epichlorohydrin, which are known to the State of California to cause cancer, and Bisphenol, Ethylene Glycol, Ethylene Oxide, 1,3 Butadiene, Epichlorohydrin, which are known to the State of California to cause birth defects or other reproductive harm. For more information go to www.P65Warnings.ca.gov.

PA2455 Inner Air Element
Fits Inside: PA1864-FN
Fits: Joy Compressors
Replaces: Joy 3606283-21
O.D.: 6 3/8 (161.9)
 Flange 7 1/2 (190.5)
I.D.: 5/8 (15.9) & 5 1/4 (133.4)
Height: 15 (381.0)
A. Gskt: [1] Attached
F. Gskt: G103-N



LL2458 Long Life Air Element
Fits: Kenworth Trucks
Replaces: GMC 25041399; Kenworth KW1600M
O.D.: 13 7/8 (352.4)
I.D.: 7 7/16 (188.9) One End
Height: 27 (685.8)
A. Gskt: [2] Attached
F. Gskt: G145-AF
Related To: PA2458 (Standard Media)



LL2456 Long Life Outer Air Element
Fits: CMI, Grove, Insley, Michigan, Morbark Equipment; Ingersoll-Rand, LeRoI, Sullair Compressors
Use With: PA2457
Replaces: Grove 9304100036; Ingersoll-Rand 35711209; Insley 453043; Sullair 48462
O.D.: 12 11/16 (322.3)
 Boot 12 25/32 (324.6)
I.D.: 29/32 (23.0) & 8 3/8 (212.7)
Height: 24 1/32 (610.4)
A. Gskt: [2] Attached
F. Gskt: [1] Included
Related To: PA2456 (Standard Media Version)
 PA2456XP (Extreme Performance Nano Version)



PA2458 Air Element
Fits: Kenworth Trucks
Replaces: GMC 25041399; Kenworth KW1600M
O.D.: 13 7/8 (352.4)
I.D.: 7 7/16 (188.9) One End
Height: 27 (685.8)
A. Gskt: [2] Attached
F. Gskt: G145-AF
Related To: LL2458 (Long-Life Version)



PA2456 Outer Air Element
Fits: CMI, Grove, Insley, Michigan, Morbark Equipment; Ingersoll-Rand, Sullair Compressors
Use With: PA2457
Replaces: Grove 9304100036; Ingersoll-Rand 35711209; Insley 453043; Sullair 48462
O.D.: 12 11/16 (322.3)
 Boot 12 25/32 (324.6)
I.D.: 29/32 (23.0) & 8 3/8 (212.7)
Height: 24 1/32 (610.4)
A. Gskt: [2] Attached
F. Gskt: [1] Included
Related To: LL2456 (Long-Life Media Version)
 PA2456XP (Extreme Performance Nano Version)



PA2459 Outer Air Element with Lift Tabs
Fits: White Equipment
Use With: PA2460
Replaces: White 30-3071219
O.D.: 9 5/8 (244.5)
I.D.: 6 3/16 (157.2) One End
Height: 16 5/16 (414.3)
A. Gskt: [1] Attached



PA2456XP Extreme Performance Nano Outer Air Element
Fits: CMI, Grove, Insley, Michigan, Morbark Equipment; Ingersoll-Rand, Sullair Compressors
Use With: PA2457
Replaces: Grove 9304100036; Ingersoll-Rand 35711209; Insley 453043; Sullair 48462
O.D.: 12 11/16 (322.3)
 Boot 12 25/32 (324.6)
I.D.: 29/32 (23.0) & 8 3/8 (212.7)
Height: 24 1/32 (610.4)
A. Gskt: [2] Attached
F. Gskt: [1] Included
Related To: LL2456 (Long-Life Media Version)
 PA2456 (Standard Media Version)



PA2460 Inner Air Element
Fits Inside: PA2459
Fits: White Equipment
Replaces: White 30-3130509
O.D.: 6 1/8 (155.6)
I.D.: 17/32 (13.5) & 4 15/16 (125.4)
Height: 14 3/8 (365.1)
A. Gskt: [1] Attached
F. Gskt: [1] Included



PA2457 Inner Air Element
Fits Inside: LL2456, PA2456, PA2456XP
Fits: CMI, Grove, Insley, Michigan, Morbark Equipment; Ingersoll-Rand, Sullair Compressors
Replaces: Grove 9304100037; Ingersoll-Rand 35123520; Insley 914621; Sullair 48463
O.D.: 8 1/4 (209.6)
I.D.: 15/16 (23.8) & 7 3/32 (180.2)
Height: 22 3/8 (568.3)
A. Gskt: [1] Attached
F. Gskt: [1] Included



PA2461 Outer Air Element
Fits: Hanomag, John Deere, Terex Equipment; R.V.I. Trucks
Use With: PA2462
Replaces: Hanomag 3074306-M1; John Deere AR70106
O.D.: 10 3/8 (263.5)
I.D.: 15/16 (23.8) & 6 1/32 (153.2)
Height: 20 3/8 (517.5)
A. Gskt: [1] Attached
F. Gskt: [1] Included



PA2462 Inner Air Element
Fits Inside: PA2461
Fits: Hanomag, John Deere, Terex Equipment
Replaces: Hanomag 3074309-M1; John Deere AR70107
O.D.: 5 15/16 (150.8)
I.D.: 21/32 (16.7) & 4 27/32 (123.0)
Height: 18 3/8 (466.7)
A. Gskt: [1] Attached
F. Gskt: G103-N



Measurements Are Shown In Inches And (Millimeters)

WARNING: These products can expose you to chemicals, including Diisononyl Phthalate, Carbon black extracts, Nickel, 1,3 Butadiene, Ethylene Oxide, Epichlorohydrin, which are known to the State of California to cause cancer, and Bisphenol, Ethylene Glycol, Ethylene Oxide, 1,3 Butadiene, Epichlorohydrin, which are known to the State of California to cause birth defects or other reproductive harm. For more information go to www.P65Warnings.ca.gov.

PA2463

Cab Air Element



Fits: Allis Chalmers Optional Equipment
Replaces: Allis Chalmers 566900
Length: 28 (711.2)
Width: 6 3/4 (171.5)
Height: 2 3/16 (55.6)

PA2464

Cab Air Element



Fits: Massey Ferguson Equipment
Replaces: Massey Ferguson 529760-M1
Length: 47 (1193.8)
Width: 6 (152.4)
Height: 2 9/16 (65.1)
A. Gskt: [1] Attached

PA2465

Air Element with Bolt



Contains: Bolt Thread: 5/16-18
Fits: GMC, International Buses, Trucks
Replaces: GMC 25040533; International 470289-C1
O.D.: 10 3/8 (263.5)
I.D.: 6 1/32 (153.2) One End
Height: 10 1/2 (266.7)
A. Gskt: [1] Attached

PA2466

Outer Air Element



Fits: Case, Case-International, Furukawa, John Deere, Komatsu, Minneapolis-Moline, Oliver Equipment
Use With: PA2467
Replaces: Furukawa 550106009; International 932391-C1; Komatsu 381-982-8121
O.D.: 9 7/32 (234.2)
I.D.: 2 1/32 (16.7) & 5 27/32 (148.4)
Height: 18 3/8 (466.7)
A. Gskt: [1] Attached
F. Gskt: G103-N

PA2467

Inner Air Element



Fits Inside: PA2466
Fits: Case, Case-International, Furukawa, John Deere, Komatsu, Minneapolis-Moline, Oliver Equipment
Replaces: Furukawa 550106008; International 932390-C1; Komatsu 381-928-8111
O.D.: 5 23/32 (145.3)
I.D.: 2 1/32 (16.7) & 4 19/32 (116.7)
Height: 16 3/8 (415.9)
A. Gskt: [1] Attached
F. Gskt: G103-N

PA2468

Air Element



Fits: GMC Buses, Trucks
Replaces: GMC 89946615
O.D.: 13 7/8 (352.4)
I.D.: 11/16 (17.5) & 7 7/16 (188.9)
Height: 18 1/2 (469.9)
A. Gskt: [1] Attached
F. Gskt: G103-N

PA2469

Inner Air Element



Fits Inside: PA1997
Fits: Massey Ferguson Equipment
Replaces: Massey Ferguson 1041911-M91
O.D.: 4 3/32 (104.0)
 Flange 4 13/16 (122.2)
I.D.: 3/4 (19.1) & 3 5/8 (92.1)
Height: 14 23/32 (373.9)
A. Gskt: [1] Attached
F. Gskt: G103-N

PA2472

Air Element



Contains: Flame Retardant Media
Fits: Ford Buses, Trucks
Replaces: Ford E1HZ-9601-A
O.D.: 12 5/8 (320.7)
I.D.: 9 3/4 (247.7)
Height: 5 1/2 (139.7)

PA2473

Air Element



Fits: International Buses, Trucks
Replaces: International 461236-C1
O.D.: 12 1/32 (305.6)
I.D.: 5/8 (15.9) & 7 11/16 (195.3)
Height: 8 1/2 (215.9)
A. Gskt: [1] Attached
F. Gskt: [1] Included

PA2474

Outer Air Element



Fits: Atlas Copco, CompAir Compressors; Bomag, John Deere, Kobelco, V.M.E., Volvo Equipment; DAF, Iveco, M.A.N., Mercedes-Benz, R.V.I., Scania
 Volvo Buses, Trucks
Use With: PA2836
Replaces: Atlas Copco 1619279800; Bomag 5821018; DAF 112294; Iveco 1902465; Mercedes-Benz 130941702; Volvo 6644990, 6644990-1
O.D.: 8 15/16 (227.0)
I.D.: 1/2 (12.7) & 4 19/32 (116.7)
Height: 15 (381.0)
A. Gskt: [1] Attached
F. Gskt: [1] Included

PA2475

Outer Air Element



Fits: Atlas Copco Compressors; DAF, Iveco, M.A.N., Mercedes-Benz, Scania Buses, Trucks; Kobelco, Liebherr, New Holland, V.M.E., Volvo Equipment
Use With: PA2814
Replaces: Atlas Copco 16192799; Iveco 1901779; Liebherr 9367183; Mercedes-Benz 10947904; Volvo 47857487
O.D.: 9 17/32 (242.1)
I.D.: 1/2 (12.7) & 5 5/32 (131.0)
Height: 19 9/16 (496.9)
A. Gskt: [1] Attached
F. Gskt: [1] Included

PA2476

Air Element





Fits: Benford Equipment; Petter Engines
Replaces: Petter ACF499-6
O.D.: 3 5/8 (92.1)
I.D.: 1 31/32 (50.0)
Height: 2 27/32 (72.2)

Measurements Are Shown In Inches And (Millimeters)

WARNING: These products can expose you to chemicals, including Diisononyl Phthalate, Carbon black extracts, Nickel, 1,3 Butadiene, Ethylene Oxide, Epichlorohydrin, which are known to the State of California to cause cancer, and Bisphenol, Ethylene Glycol, Ethylene Oxide, 1,3 Butadiene, Epichlorohydrin, which are known to the State of California to cause birth defects or other reproductive harm. For more information go to www.P65Warnings.ca.gov.

PA2477 Air Element

Replaces: Petter BAF423
O.D.: 4 3/8 (111.1)
I.D.: 1 31/32 (50.0)
Height: 2 19/32 (65.9)

PA2478 Outer Air Element with Lid and Lift Tab

Fits: Komatsu Equipment
Use With: PA1880
Replaces: Komatsu 612-881-7320
O.D.: 12 1/16 (306.4)
 Lid 14 13/16 (376.2)
I.D.: 15/16 (23.8) & 7 11/16 (195.3)
Height: 18 1/2 (469.9)
A. Gskt: [2] Attached
F. Gskt: [1] Included

PA2479 Air Element

Fits: Chrysler-Nissan Industrial Engines
Replaces: Nissan 16546-90114
O.D.: 8 17/32 (216.7)
I.D.: 4 3/8 (111.1)
Height: 3 5/16 (84.1)

PA2480 Air Element

Fits: R.V.I. Trucks
Replaces: Renault 5000802163
O.D.: 7 1/8 (181.0)
 Flange 8 7/8 (225.4)
I.D.: 5/8 (7.9) & 4 1/8 (104.8)
Height: 16 9/16 (420.7)
A. Gskt: [1] Attached

PA2481 Air Element with Lid

Fits: R.V.I. Buses, Trucks
Replaces: Renault 5000559387
O.D.: 6 (152.4)
 Lid 7 31/32 (202.4)
I.D.: 3/8 (9.5) & 3 5/16 (84.1)
Height: 13 3/8 (339.7)
A. Gskt: [1] Attached

LL2482 Long Life Air Element

Notes: Inside-Out Flow Direction
Fits: GMC, Kenworth, Mack Trucks
Replaces: GMC 25040009
O.D.: 8 27/32 (224.6)
I.D.: 5 15/32 (138.9) One End
Height: 23 (584.2)
A. Gskt: [2] Attached
F. Gskt: G207-AF
O. Gskt: G472-AF
Related To: PA2482 (Standard Media Version)

PA2482 Air Element

Notes: Inside-Out Flow Direction
Fits: GMC, Kenworth, Mack Trucks
Replaces: GMC 25040009
O.D.: 8 27/32 (224.6)
I.D.: 5 15/32 (138.9) One End
Height: 23 (584.2)
A. Gskt: [2] Attached
F. Gskt: G207-AF
O. Gskt: G472-AF
Related To: LL2482 (Long-Life Media Version)

PA2483 Air Element

Fits: Ford Trucks
Replaces: Ford E1HZ-9601-B
O.D.: 12 19/32 (319.9)
I.D.: 8 9/32 (210.3)
Height: 5 1/2 (139.7)

PA2484 Air Element

Fits: Chicago-Pneumatic, Dritelch Drills;
 Joy Compressors
Replaces: Dritelch 221551
O.D.: 7 15/16 (201.6)
I.D.: 11/16 (17.5) & 3 9/16 (90.5)
Height: 16 1/2 (419.1)
A. Gskt: [1] Attached
F. Gskt: G103-N

PA2485 Cab Air Element

Fits: Agco, Deutz-Allis, Minneapolis-Moline,
 Oliver, White Equipment
Replaces: White 20-7000164
Length: 47 (1193.8)
Width: 7 (177.8)
Height: 2 3/16 (55.6)

PA2486 Outer Air Element with Lift Bar

Fits: Massey Ferguson, Ramacher Equipment
Use With: PA2323
Replaces: Massey Ferguson 1042216-M91
O.D.: 5 5/16 (134.9)
I.D.: 5/8 (7.9) & 3 13/32 (86.5)
Height: 14 3/8 (365.1)
A. Gskt: [1] Attached

PA2487 Inner Air Element

Fits Inside: LL2360-FN, PA2360-FN
Fits: Bobcat, Bomag, Case, Davis, Ditch Witch,
 Gehl, J.C. Bamford, Massey Ferguson, New
 Holland, Vermeer, Versatile Equipment
Replaces: Case A173291; Clark 6630940; Davis
 87859; Ditch Witch 195809; J.C. Bamford
 32/205703; Melroe-Bobcat 6630940;
 Versatile 51934
O.D.: 2 31/32 (75.4)
 Flange 3 5/8 (92.1)
I.D.: 5/8 (15.9) & 2 7/16 (61.9)
Height: 14 3/32 (358.0)
A. Gskt: [1] Attached
F. Gskt: G103-N

Measurements Are Shown In Inches And (Millimeters)

 **WARNING:** These products can expose you to chemicals, including Diisononyl Phthalate, Carbon black extracts, Nickel, 1,3 Butadiene, Ethylene Oxide, Epichlorohydrin, which are known to the State of California to cause cancer, and Bisphenol, Ethylene Glycol, Ethylene Oxide, 1,3 Butadiene, Epichlorohydrin, which are known to the State of California to cause birth defects or other reproductive harm. For more information go to www.P65Warnings.ca.gov.

PA2488-FN



Outer Air Element with Fins
Fits: Bobcat Loaders; Massey Ferguson Equipment
Use With: PA2489
Replaces: Fiat 71909139; Massey Ferguson 1043326-M91
O.D.: 5 1/4 (133.4)
 Fins 6 3/8 (161.9)
I.D.: 2 1/32 (16.7) & 2 5/8 (66.7)
Height: 11 1/4 (285.8)
A. Gskt: [1] Attached
F. Gskt: G103-N

PA2489



Inner Air Element
Fits Inside: LL1667-FN, PA1667-FN, PA2391, PA2488-FN, PA3791-FN
Fits: Bobcat, Ditch Witch, Fiat, Ford, Hesston, John Deere, Kubota, Massey Ferguson, New Holland Equipment
Replaces: Ditch Witch 195818; Fiat 1909138; John Deere RE45826; Kubota 17381-11181; Massey Ferguson 1043327-M91; New Holland 86504143
O.D.: 2 17/32 (64.3)
 Flange 3 3/32 (78.6)
I.D.: 5/8 (15.9) & 2 5/32 (54.8)
Height: 10 1/8 (257.2)
A. Gskt: [1] Attached
F. Gskt: G103-N

PA2490



Outer Air Element
Fits: Quincy, Worthington Compressors
Use With: PA2491
Replaces: Quincy 234583; Worthington ELM64
O.D.: 12 1/2 (317.5)
I.D.: 13/32 (10.3) & 7 1/2 (190.5)
Height: 21 1/4 (539.8)
A. Gskt: [1] Attached
F. Gskt: [1] Included

PA2491



Inner Air Element
Fits Inside: PA2490
Fits: Quincy, Worthington Compressors
Replaces: Quincy 120382; Worthington ELM89
O.D.: 7 3/8 (187.3)
I.D.: 3/4 (19.1) & 6 1/8 (155.6)
Height: 19 1/2 (495.3)
A. Gskt: [1] Attached
F. Gskt: G103-N

LL2493



Long Life Air Element
Notes: Inside-Out Flow Direction
Fits: Western Star Trucks
Replaces: White 22-0054401
O.D.: 10 3/8 (263.5)
I.D.: 6 1/32 (153.2) One End
Height: 27 (685.8)
A. Gskt: [2] Attached
F. Gskt: G21-AF
Related To: PA2493 (Standard Media Version)

PA2493



Air Element
Notes: Inside-Out Flow Direction
Fits: Western Star Trucks
Replaces: White 22-0054401
O.D.: 10 3/8 (263.5)
I.D.: 6 1/32 (153.2) One End
Height: 27 (685.8)
A. Gskt: [2] Attached
F. Gskt: G21-AF
Related To: LL2493 (Long-Life Media Version)

PA2494



Air Element
Notes: Inside-Out Flow Direction.
 Sometimes used with PA2438 in horizontal housing.
Replaces: Mack 57MD29301
O.D.: 12 3/4 (323.9)
I.D.: 8 11/32 (211.9)
Height: 15 (381.0)
A. Gskt: [2] Attached
F. Gskt: G25-AF

PA2495



Outer Air Element
Fits: Minneapolis-Moline Tractors
Use With: PA1998
Replaces: White 30-3108732
O.D.: 7 5/8 (193.7)
 Boot 8 5/8 (219.1)
I.D.: 5/8 (15.9) & 4 1/4 (108.0)
Height: 16 7/16 (417.5)
A. Gskt: [2] Attached
F. Gskt: G103-N

PA2496



Outer Air Element with Lift Bar
Contains: Flame Retardant Media
Fits: Massey Ferguson Equipment
Use With: PA1809
Replaces: Massey Ferguson 1094056-M91
O.D.: 5 11/32 (135.7)
I.D.: 7/16 (11.1) & 2 7/32 (56.4)
Height: 10 11/16 (271.5)
A. Gskt: [1] Attached
F. Gskt: [1] Included

PA2497

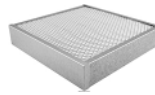

Cab Air Element
Fits: Allis Chalmers Equipment
Replaces: Allis Chalmers 246580
Length: 11 (279.4)
Width: 11 (279.4)
Height: 2 3/16 (55.6)

PA2498



Pressurized Cab Air Element
Fits: Caterpillar Crawler Tractors
Replaces: Caterpillar 6P6664
O.D.: 6 7/8 (174.6)
I.D.: 2 1/32 (16.7) & 4 3/16 (106.4)
Height: 12 3/8 (314.3)
A. Gskt: [1] Attached
F. Gskt: [1] Included, [1] Wing Nut

PA2499



Cab Air Element
Fits: Caterpillar Equipment
Replaces: Caterpillar 6K9606
Length: 23 1/2 (596.9)
Width: 7 1/8 (181.0)
Height: 15/16 (23.8)

Measurements Are Shown In Inches And (Millimeters)

WARNING: These products can expose you to chemicals, including Diisononyl Phthalate, Carbon black extracts, Nickel, 1,3 Butadiene, Ethylene Oxide, Epichlorohydrin, which are known to the State of California to cause cancer, and Bisphenol, Ethylene Glycol, Ethylene Oxide, 1,3 Butadiene, Epichlorohydrin, which are known to the State of California to cause birth defects or other reproductive harm. For more information go to www.P65Warnings.ca.gov.

PA2500



Conical-Shaped Air Element

Notes: Inside-Out Flow Direction
Fits: Ford, GMC, International, WhiteGMC Trucks; Advance Mixer, Gradall Equipment
Replaces: Ford F8HZ-9601-A; GMC 8997221; International 503634-C91; Mack 57MD29503
O.D.: 5 13/16 (147.6) to 8 11/16 (220.7)
I.D.: 2 3/16 (55.6) One End
Height: 29 (736.6)
A. Gskt: [2] Attached
F. Gskt: [1] Included
Related To: PA2540 (Short Version)

PA2502



Cab Air Element

Fits: Allis Chalmers, Egging Tractors
Replaces: Allis Chalmers 3107280
Length: 23 1/2 (596.9)
Width: 6 1/2 (165.1)
Height: 2 3/16 (55.6)

LL2503



Long Life Air Element

Notes: Inside-Out Flow Direction
Fits: GMC Trucks
Replaces: GMC 25041712
O.D.: 8 27/32 (224.6)
I.D.: 5 13/16 (147.6) One End
Height: 29 (736.6)
A. Gskt: [2] Attached
F. Gskt: [1] Included
O. Gskt: G207-AF
Related To: PA2503 (Standard Media Version)

PA2503



Air Element

Notes: Inside-Out Flow Direction
Fits: GMC Trucks
Replaces: GMC 25041712
O.D.: 8 27/32 (224.6)
I.D.: 5 13/16 (147.6) One End
Height: 29 (736.6)
A. Gskt: [2] Attached
F. Gskt: [1] Included
O. Gskt: G207-AF
Related To: LL2503 (Long-Life Media Version)

PA2504



Outer Air Element

Fits: Chevrolet, International, Isuzu, Nissan Trucks; Clark, Hitachi, Taylor Machine, Timberjack Equipment
Use With: PA2545
Replaces: Clark 2521682; GMC 25043888; Hitachi 4147010
O.D.: 8 27/32 (224.6)
I.D.: 15/16 (23.8) & 5 13/16 (147.6)
Height: 13 1/2 (342.9)
A. Gskt: [1] Attached
F. Gskt: [1] Included

LL2507



Long Life Outer Air Element

Fits: Benford, Terex Equipment
Use With: PA2508
Replaces: GMC 9059570; Terex 9039993
O.D.: 17 5/8 (447.7)
 Boot 18 5/16 (465.1)
I.D.: 13/32 (10.3) & 12 1/8 (308.0)
Height: 19 17/32 (496.1)
A. Gskt: [2] Attached
F. Gskt: G39-AF
Related To: PA2507 (Standard Media Version)

PA2507



Outer Air Element

Fits: Benford, Terex Equipment
Use With: PA2508
Replaces: GMC 9059570; Terex 9039993
O.D.: 17 5/8 (447.7)
 Boot 18 5/16 (465.1)
I.D.: 13/32 (10.3) & 12 1/8 (308.0)
Height: 19 17/32 (496.1)
A. Gskt: [2] Attached
F. Gskt: G39-AF
Related To: LL2507 (Long-Life Media Version)

PA2508



Inner Air Element

Fits Inside: LL2507, PA2507
Fits: Terex Tractors
Replaces: GMC 9039992; Terex 9039992
O.D.: 11 7/8 (301.6)
I.D.: 7/8 (22.2) & 10 1/4 (260.4)
Height: 18 5/32 (461.2)
A. Gskt: [1] Included
F. Gskt: [1] Included

PA2509



Outer Air Element

Fits: Agco, Allis Chalmers, Ford, Gleaner, Steiger Equipment
Use With: PA2510
Replaces: Allis Chalmers 70269244; Ford SFD07-1011
O.D.: 10 3/8 (263.5)
I.D.: 15/16 (23.8) & 6 1/32 (153.2)
Height: 18 3/8 (466.7)
A. Gskt: [1] Attached
F. Gskt: [1] Included

PA2510



Inner Air Element

Fits Inside: PA2509, PA2591
Fits: Agco, Allis Chalmers, Ford, Gleaner, Steiger Equipment
Replaces: Allis Chalmers 279245; Case A45695; Ford SFD07-1010
O.D.: 5 15/16 (150.8)
I.D.: 21/32 (16.7) & 4 27/32 (123.0)
Height: 16 3/8 (415.9)
A. Gskt: [1] Attached
F. Gskt: G103-N

PA2511



Outer Air Element

Fits: Dresser, International Equipment
Use With: PA2512
Replaces: International 631421-C1
O.D.: 7 11/32 (186.5)
I.D.: 7/16 (11.1) & 4 (101.6)
Height: 14 3/4 (374.7)
A. Gskt: [1] Attached
F. Gskt: [1] Included

PA2512



Inner Air Element

Fits Inside: PA2511
Fits: Dresser, International Equipment
Replaces: International 631422-C1
O.D.: 3 7/8 (98.4)
I.D.: 5/8 (15.9) & 2 1/2 (63.5)
Height: 12 1/16 (306.4)
A. Gskt: [1] Attached
F. Gskt: G103-N

Measurements Are Shown In Inches And (Millimeters)

WARNING: These products can expose you to chemicals, including Diisononyl Phthalate, Carbon black extracts, Nickel, 1,3 Butadiene, Ethylene Oxide, Epichlorohydrin, which are known to the State of California to cause cancer, and Bisphenol, Ethylene Glycol, Ethylene Oxide, 1,3 Butadiene, Epichlorohydrin, which are known to the State of California to cause birth defects or other reproductive harm. For more information go to www.P65Warnings.ca.gov.

PA2513



Outer Air Element with Lift Bar
Fits: Ford Equipment
Use With: PA2514
Replaces: Ford D5NN-9601-B
O.D.: 5 5/16 (134.9)
 Boot 5 3/4 (146.1)
I.D.: 7/16 (11.1) & 3 1/16 (77.8)
Height: 11 1/2 (292.1)
A. Gskt: [2] Attached
F. Gskt: [1] Included

PA2514



Inner Air Element
Fits Inside: PA2513
Fits: Ford Equipment
Replaces: Ford D5NN-9R500-B
O.D.: 2 15/16 (74.6)
I.D.: 17/32 (13.5) & 2 13/32 (61.1)
Height: 9 15/16 (252.4)
A. Gskt: [2] Attached
F. Gskt: [1] Included

PA2515



Air Element
Fits: GMC Buses, Trucks
Replaces: GMC 25177168
O.D.: 13 7/8 (352.4)
I.D.: 7 7/16 (188.9) One End
Height: 20 (508.0)
A. Gskt: [2] Included
F. Gskt: G145-AF

PA2516



Air Element
Fits: GMC Buses, Trucks
Replaces: GMC 25040535
O.D.: 13 7/8 (352.4)
I.D.: 7 7/16 (188.9) One End
Height: 26 (660.4)
A. Gskt: [2] Attached
F. Gskt: G145-AF

PA2517



Air Element with Lid and 6 Bolt Holes
Replaces: Ford D6HS-9601-B
O.D.: 13 7/8 (352.4)
 Lid 16 1/8 (409.6)
I.D.: 7 7/16 (188.9) One End
Height: 13 17/32 (343.7)
A. Gskt: [2] Attached

LL2518



Long Life Outer Air Element
Fits: Ag-Chem, Terex Equipment;
 Ingersoll-Rand, Joy, Sullair Compressors
Use With: PA2519
Replaces: Ag-Chem 718569; Euclid 9013550;
 Ingersoll-Rand 35355395; Joy 360628329;
 Sullair 46968
O.D.: 12 1/8 (308.0)
 Boot 12 13/16 (325.4)
I.D.: 29/32 (23.0) & 7 11/16 (195.3)
Height: 20 3/8 (517.5)
A. Gskt: [2] Attached
F. Gskt: [1] Included
Related To: PA2518 (Standard Media Version)
 PA2518XP (Extreme Performance Nano Version)

PA2518



Outer Air Element
Fits: Ag-Chem, Terex Equipment;
 Ingersoll-Rand, Joy, Sullair Compressors
Use With: PA2519
Replaces: Ag-Chem 718569; Euclid 9013550;
 Ingersoll-Rand 35355395; Joy 360628329;
 Sullair 46968
O.D.: 12 1/8 (308.0)
 Boot 12 13/16 (325.4)
I.D.: 29/32 (23.0) & 7 11/16 (195.3)
Height: 20 3/8 (517.5)
A. Gskt: [2] Attached
F. Gskt: [1] Included
Related To: LL2518 (Long-Life Media Version)
 PA2518XP (Extreme Performance Nano Version)

PA2518XP



Extreme Performance Nano Outer Air Element
Fits: Ag-Chem, Terex Equipment;
 Ingersoll-Rand, Joy, Sullair Compressors
Use With: PA2519
Replaces: Ag-Chem 718569; Euclid 9013550;
 Ingersoll-Rand 35355395; Joy 360628329;
 Sullair 46968
O.D.: 12 1/8 (308.0)
 Boot 12 13/16 (325.4)
I.D.: 29/32 (23.0) & 7 11/16 (195.3)
Height: 20 3/8 (517.5)
A. Gskt: [2] Attached
F. Gskt: [1] Included
Related To: LL2518 (Long-Life Media Version)
 PA2518 (Standard Media Version)

PA2519



Inner Air Element
Fits Inside: LL2518, PA2518, PA2518XP
Fits: Terex Equipment; Ingersoll-Rand, Joy,
 Sullair Compressors
Replaces: Ingersoll-Rand 46981;
 Joy 360628328; Terex 9031711
O.D.: 7 5/8 (193.7)
I.D.: 7/8 (22.2) & 6 1/16 (154.0)
Height: 18 3/8 (466.7)
A. Gskt: [1] Attached
F. Gskt: [1] Included

PA2520



Outer Air Element
Fits: International Buses, Trucks
Use With: PA2586
Replaces: International 478974-C1
O.D.: 10 3/8 (263.5)
I.D.: 6 1/32 (153.2) One End
Height: 12 3/8 (314.3)
A. Gskt: [1] Attached

Measurements Are Shown In Inches And (Millimeters)

WARNING: These products can expose you to chemicals, including Diisononyl Phthalate, Carbon black extracts, Nickel, 1,3 Butadiene, Ethylene Oxide, Epichlorohydrin, which are known to the State of California to cause cancer, and Bisphenol, Ethylene Glycol, Ethylene Oxide, 1,3 Butadiene, Epichlorohydrin, which are known to the State of California to cause birth defects or other reproductive harm. For more information go to www.P65Warnings.ca.gov.

LL2521 Long Life Outer Air Element with Lift Tab
Fits: International, Kenworth, Mercedes-Benz, Peterbilt Trucks; Thomas Buses
Use With: PA2522
Replaces: International 476741-C1
O.D.: 10 3/8 (263.5)
I.D.: 6 1/32 (153.2) One End
Height: 16 7/16 (417.5)
A. Gskt: [1] Attached
Related To: PA2521 (Standard Media Version)



PA2525 Outer Air Element with Lift Tabs
Fits: International Buses, Trucks
Use With: PA2526, PA3480
Replaces: International 470186-C91
O.D.: 12 1/32 (305.6) & 12 3/32 (307.2)
I.D.: 7 11/16 (195.3) One End
Height: 18 1/2 (469.9)
A. Gskt: [1] Attached
Related To: LL2525 (Long-Life Media Version)



PA2521 Outer Air Element
Fits: International, Kenworth, Mercedes-Benz, Peterbilt Trucks; Thomas Buses
Use With: PA2522
Replaces: International 476741-C1
O.D.: 10 3/8 (263.5)
I.D.: 6 1/32 (153.2) One End
Height: 16 7/16 (417.5)
A. Gskt: [1] Attached
Related To: LL2521 (Long-Life Media Version)



PA2526 Inner Air Element
Fits Inside: LL2525, PA2525
Fits: Fram Optional Housings; International Trucks
Replaces: International 482646-C91; Fram CA1599SY
O.D.: 7 5/8 (193.7)
I.D.: 21/32 (16.7) & 6 1/16 (154.0)
Height: 15 7/8 (403.2)
A. Gskt: [1] Attached
F. Gskt: G103-N



PA2522 Inner Air Element
Fits Inside: LL2521, PA2521
Fits: International Trucks; Thomas Buses
Replaces: International 482644-C1
O.D.: 5 15/16 (150.8)
I.D.: 21/32 (16.7) & 4 27/32 (123.0)
Height: 13 7/8 (352.4)
A. Gskt: [1] Attached
F. Gskt: G103-N



PA2527 Air Element
Replaces: Caterpillar 3I0177; GMC 25096334
O.D.: 6 7/8 (174.6)
I.D.: 21/32 (16.7) & 3 1/2 (88.9)
Height: 13 7/16 (341.3)
A. Gskt: [1] Attached
F. Gskt: G103-N, [1] Wing Nut



PA2523 Outer Air Element
Fits: Allis Chalmers, White Equipment; Ford Trucks
Use With: PA1912, PA1998
Replaces: Allis Chalmers 1325203; Ford E6HZ-9601-A
O.D.: 7 15/16 (201.6)
I.D.: 11/16 (17.5) & 5 3/8 (136.5)
Height: 16 1/2 (419.1)
A. Gskt: [1] Attached
F. Gskt: G103-N



PA2528 Air Element
Fits: Sullair Compressors
Replaces: Sullair 40853
O.D.: 8 1/2 (215.9)
I.D.: 7/16 (11.1) & 4 1/16 (103.2)
Height: 14 1/16 (357.2)
A. Gskt: [1] Attached
F. Gskt: [1] Included



PA2524-FN Outer Air Element with Fins
Fits: Case, Hough, International Equipment
Use With: PA2332
Replaces: International 690049-C1
O.D.: 6 7/8 (174.6)
Fins: 8 3/4 (222.3)
I.D.: 21/32 (16.7) & 3 1/2 (88.9)
Height: 15 3/8 (390.5)
A. Gskt: [1] Attached
F. Gskt: G103-N



PA2529 Outer Air Element
Fits: John Deere, New Holland Equipment
Use With: PA2530
Replaces: John Deere AR80652
O.D.: 9 1/16 (230.2)
I.D.: 3/8 (9.5) & 5 3/8 (136.5)
Height: 19 5/8 (498.5)
A. Gskt: [1] Attached
F. Gskt: [1] Included



LL2525 Long Life Outer Air Element with Lift Tabs
Fits: International Buses, Trucks
Use With: PA2526, PA3480
Replaces: International 470186-C91
O.D.: 12 1/32 (305.6) to 12 3/32 (307.2)
I.D.: 7 11/16 (195.3) One End
Height: 18 1/2 (469.9)
A. Gskt: [1] Attached
Related To: PA2525 (Standard Media Version)



PA2530 Inner Air Element
Fits Inside: PA2529
Fits: Hitachi, John Deere Equipment
Replaces: John Deere AR80653; Kobelco 2446U249S1
O.D.: 5 5/32 (131.0)
I.D.: 5/8 (15.9) & 4 1/32 (102.4)
Height: 16 5/32 (410.4)
A. Gskt: [1] Attached
F. Gskt: G103-N



Measurements Are Shown In Inches And (Millimeters)

WARNING: These products can expose you to chemicals, including Diisononyl Phthalate, Carbon black extracts, Nickel, 1,3 Butadiene, Ethylene Oxide, Epichlorohydrin, which are known to the State of California to cause cancer, and Bisphenol, Ethylene Glycol, Ethylene Oxide, 1,3 Butadiene, Epichlorohydrin, which are known to the State of California to cause birth defects or other reproductive harm. For more information go to www.P65Warnings.ca.gov.

PA2531

Air Element



Fits: Detroit Diesel Engines; GMC Trucks
Replaces: GMC 2050330
O.D.: 9 (228.6)
I.D.: 5 11/16 (144.5)
Height: 22 19/32 (573.9)
A. Gskt: [2] Attached
O. Gskt: G472-AF

PA2538

Outer Air Element



Fits: Agco, Dresser, Hough, International, Massey Ferguson, White Equipment
Use With: PA2539
Replaces: International 935694-C1
O.D.: 10 3/8 (263.5)
I.D.: 21/32 (16.7) & 6 1/32 (153.2)
Height: 16 1/2 (419.1)
A. Gskt: [1] Attached
F. Gskt: G103-N

PA2532

Air Element



Fits: Detroit Diesel Engines; GMC Trucks
Replaces: GMC 2030100
O.D.: 9 (228.6)
I.D.: 5 11/16 (144.5)
Height: 28 1/2 (723.9)
A. Gskt: [2] Attached
O. Gskt: G472-AF

PA2539

Inner Air Element



Fits Inside: PA2538, PA2777
Fits: Agco, Case, Dresser, Hough, International Equipment
Replaces: Case A171256; International 935693-C1
O.D.: 5 15/16 (150.8)
I.D.: 21/32 (16.7) & 4 27/32 (123.0)
Height: 14 1/2 (368.3)
A. Gskt: [1] Attached
F. Gskt: G103-N

PA2533

Air Element with Lid and 6 Bolt Holes



Fits: Ford Buses, Trucks
Replaces: Ford D5HZ-9601-A
O.D.: 12 1/32 (305.6)
 Lid 14 3/16 (360.4)
I.D.: 6 23/32 (170.7) One End
Height: 16 1/2 (419.1)
A. Gskt: [1] Attached

PA2540

Conical-Shaped Air Element



Fits: GMC, Mack Trucks; Caterpillar Loaders
Replaces: GMC 25040529; Mack 57MD27
O.D.: 5 3/4 (146.1) to 8 21/32 (219.9)
I.D.: 5 3/16 (131.8)
Height: 16 (406.4)
A. Gskt: [2] Attached
F. Gskt: [1] Included
Related To: PA2500 (Long Version)

PA2534

Cab Air Element

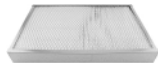

Fits: Caterpillar, Elgin, Owatonna Equipment
Replaces: Caterpillar 8P5142; Thermo King 2052B70G01
Length: 17 (431.8)
Width: 10 (254.0)
Height: 2 3/16 (55.6)

PA2541-FN

Outer Air Element with Fins



Fits: Benfra, Demag, Fiat-Allis, Hanomag, Massey Ferguson, New Holland Equipment
Use With: PA2332
Replaces: Benfra 40155; Demag 5150574; Fiat-Allis 79049791; Massey Ferguson 1428739-M91
O.D.: 5 1/4 (133.4)
 Fins 6 3/8 (161.9)
I.D.: 21/32 (16.7) & 3 5/8 (92.1)
Height: 15 15/32 (392.9)
A. Gskt: [1] Attached
F. Gskt: G103-N

PA2535

Inner Air Element



Fits Inside: PA1907-FN
Fits: Bobcat Loaders; Massey Ferguson Industrial Equipment, Wheel Tractors
Replaces: Massey Ferguson 523419-M91
O.D.: 2 3/8 (60.3)
 Flange 4 1/2 (114.3)
I.D.: 13/32 (10.3) & 2 (50.8)
Height: 8 15/32 (215.1)
A. Gskt: [2] Attached
F. Gskt: [1] Included

PA2542

Outer Air Element with Lift Bars



Fits: Dresser, International Equipment
Use With: PA2543
Replaces: International 627114-C1
O.D.: 6 19/32 (167.5)
I.D.: 3 21/32 (92.9) One End
Height: 17 3/16 (436.6)
A. Gskt: [1] Attached

PA2536

Air Element



Contains: Flame Retardant Media
Fits: Nissan Automotive; Datsun, Nissan Lift Trucks
Replaces: Nissan 16546-76015, 16546-L3000
O.D.: 5 1/4 (133.4)
I.D.: 3/8 (9.5) & 2 27/32 (72.2)
Height: 6 23/32 (170.7)
F. Gskt: [1] Included

PA2544

Air Element with Lid and 6 Bolt Holes



Fits: WhiteGMC Trucks
Replaces: White 22-005009
O.D.: 13 7/8 (352.4)
 Lid 16 1/8 (409.6)
I.D.: 7 7/16 (188.9) One End
Height: 16 1/32 (407.2)
A. Gskt: [2] Attached

Measurements Are Shown In Inches And (Millimeters)

WARNING: These products can expose you to chemicals, including Diisononyl Phthalate, Carbon black extracts, Nickel, 1,3 Butadiene, Ethylene Oxide, Epichlorohydrin, which are known to the State of California to cause cancer, and Bisphenol, Ethylene Glycol, Ethylene Oxide, 1,3 Butadiene, Epichlorohydrin, which are known to the State of California to cause birth defects or other reproductive harm. For more information go to www.P65Warnings.ca.gov.

PA2545



Inner Air Element

Fits Inside: PA2504, PA2779
Fits: Ag-Chem, Caterpillar, Clark, Hitachi, Kawasaki, Timberjack Equipment; GMC, International, Isuzu, Nissan Buses, Trucks
Replaces: GMC 94037809; Isuzu 1-14215-078-1; Nissan D6546-Z9006
O.D.: 5 11/16 (144.5)
I.D.: 11/16 (17.5) & 4 19/32 (116.7)
Height: 12 3/8 (314.3)
A. Gskt: [1] Attached
F. Gskt: G103-N

PA2551



Outer Air Element with Bail Handle

Fits: International Wheel Tractors
Use With: PA2332
Replaces: International 71912-C1
O.D.: 6 27/32 (173.8)
I.D.: 3 15/32 (88.1) One End
Height: 15 3/8 (390.5)
A. Gskt: [1] Attached

PA2546



Outer Air Element

Fits: Dresser, Ford, Hitachi, John Deere Equipment
Use With: PA2547
Replaces: John Deere AR79679
O.D.: 9 3/32 (231.0)
I.D.: 1/2 (12.7) & 5 7/32 (132.6)
Height: 17 (431.8)
A. Gskt: [1] Attached
F. Gskt: [1] Included

PA2552



Air Element

Replaces: International 466400-C1
O.D.: 12 5/8 (320.7)
I.D.: 8 13/32 (213.5)
Height: 8 5/8 (219.1)
A. Gskt: [2] Attached

PA2547



Inner Air Element

Fits Inside: PA2546
Fits: Dresser, Hitachi, John Deere Equipment
Replaces: John Deere AR79680
O.D.: 4 21/32 (118.3)
I.D.: 21/32 (16.7) & 3 15/16 (100.0)
Height: 14 19/32 (370.7)
A. Gskt: [1] Attached
F. Gskt: G103-N

PA2553



Air Element

Fits: DAF, R.V.I., Volvo Buses, Trucks
Replaces: DAF 693076; R.V.I. 5000242911; Volvo 1517842
O.D.: 8 3/8 (212.7)
I.D.: 4 (101.6)
Height: 12 5/8 (320.7)
A. Gskt: [2] Attached

PA2548



Air Element with Lid and Air Restriction Gauge Fitting

Fits: Ford Trucks
Replaces: Ford F6HZ-9601-B
O.D.: 10 (254.0)
 Lid 12 (304.8)
I.D.: 17/32 (13.5) & 4 15/16 (125.4)
Height: 8 1/16 (204.8)
A. Gskt: [1] Attached
F. Gskt: [1] Washer

PA2554



Panel Air Element

Notes: Do NOT use in cab air ventilation systems.
Fits: Caterpillar Industrial, Marine Engines
Use With: PA2554 FOAM
Replaces: Caterpillar 4N15, 4N0015
Length: 15 (381.0)
Width: 15 (381.0)
Height: 5 1/2 (139.7)

PA2549



Air Element with Lid and Lift Tab

Fits: GMC Trucks
Replaces: GMC 2021511, 2026736, 2034189
O.D.: 10 7/8 (276.2)
 Lid 11 7/8 (301.6)
I.D.: 7/16 (11.1) & 7 1/4 (184.2)
Height: 12 3/32 (307.2)
A. Gskt: [2] Attached

PA2554 FOAM



Foam Blanket for PA2554

Use With: PA2554
Length: 24 (609.6)
Width: 15 (381.0)
Height: 1/2 (12.7)

PA2550



Air Element

Fits: GMC Trucks
Replaces: GMC 2054757
O.D.: 8 27/32 (224.6)
I.D.: 5 15/32 (138.9) One End
Height: 15 (381.0)
A. Gskt: [2] Attached
F. Gskt: G207-AF

PA2555



Inter-Cooler Air Element

Notes: Sometimes used with PA2556.
Replaces: GMC 25042417; Mack 57MD29305P1
O.D.: 10 13/32 (264.3)
I.D.: 6 15/16 (176.2)
Height: 12 (304.8)
A. Gskt: [2] Attached

PA2556



Inter-Cooler Air Element

Notes: Sometimes used with PA2555.
Replaces: GMC 25042415; Mack 57MD29305P2
O.D.: 10 3/8 (263.5)
I.D.: 6 1/32 (153.2)
Height: 15 (381.0)
A. Gskt: [2] Attached

Measurements Are Shown In Inches And (Millimeters)

WARNING: These products can expose you to chemicals, including Diisononyl Phthalate, Carbon black extracts, Nickel, 1,3 Butadiene, Ethylene Oxide, Epichlorohydrin, which are known to the State of California to cause cancer, and Bisphenol, Ethylene Glycol, Ethylene Oxide, 1,3 Butadiene, Epichlorohydrin, which are known to the State of California to cause birth defects or other reproductive harm. For more information go to www.P65Warnings.ca.gov.

LL2557

Long Life Air Element



Fits: Caterpillar Industrial Engines
Replaces: Caterpillar 7N1225
O.D.: 10 3/8 (263.5)
I.D.: 6 1/32 (153.2) One End
Height: 9 1/2 (241.3)
A. Gskt: [1] Attached
Related To: PA2557 (Standard Media Version)

PA2557

Air Element



Fits: Caterpillar Industrial Engines
Replaces: Caterpillar 7N1225
O.D.: 10 3/8 (263.5)
I.D.: 6 1/32 (153.2) One End
Height: 9 1/2 (241.3)
A. Gskt: [1] Attached
Related To: LL2557 (Long-Life Media Version)

PA2558

Air Element



Fits: Mack Trucks
Replaces: Mack 2MD4004, 57MD32
O.D.: 8 27/32 (224.6)
I.D.: 11/16 (17.5) & 5 15/32 (138.9)
Height: 7 1/2 (190.5)
A. Gskt: [1] Attached
F. Gskt: G103-N

LL2559

Long Life Air Element



Replaces: GMC 25041976
O.D.: 13 7/8 (352.4)
I.D.: 7 7/16 (188.9) One End
Height: 24 (609.6)
A. Gskt: [2] Attached
F. Gskt: G145-AF
Related To: PA2559 (Standard Media Version)

PA2559

Air Element



Replaces: GMC 25041976
O.D.: 13 7/8 (352.4)
I.D.: 7 7/16 (188.9) One End
Height: 24 (609.6)
A. Gskt: [2] Attached
F. Gskt: G145-AF
Related To: LL2559 (Long-Life Media Version)

LL2562

Long Life Outer Air Element with Bail Handle



Fits: Ingersoll-Rand Compressors; Hitachi, Koehring, Liebherr, Terex, Volvo, WABCO Equipment
Use With: PA2563
Replaces: Hitachi 4206272; Ingersoll-Rand 35298108; WABCO VE1062
O.D.: 14 11/16 (373.1)
I.D.: 29/32 (23.0) & 10 11/32 (262.7)
Height: 24 1/2 (622.3)
A. Gskt: [1] Attached
F. Gskt: [1] Included
Related To: PA2562 (Standard Media Version)
 PA2562XP (Extreme Performance Nano Version)

PA2562

Outer Air Element with Bail Handle



Fits: Ingersoll-Rand Compressors; Hitachi, Koehring, Liebherr, Terex, Volvo, Wabco Equipment
Use With: PA2563
Replaces: Hitachi 4206272; Ingersoll-Rand 35298108; WABCO VE1062
O.D.: 14 11/16 (373.1)
I.D.: 29/32 (23.0) & 10 11/32 (262.7)
Height: 24 1/2 (622.3)
A. Gskt: [1] Attached
F. Gskt: [1] Included
Related To: LL2562 (Long-Life Media Version)
 PA2562XP (Extreme Performance Nano Version)

PA2562XP

Extreme Performance Nano Outer Air Element with Bail Handle



Fits: Ingersoll-Rand Compressors; Hitachi, Koehring, Liebherr, Terex, Volvo, Wabco Equipment
Use With: PA2563
Replaces: Hitachi 4206272; Ingersoll-Rand 35298108; WABCO VE1062
O.D.: 14 11/16 (373.1)
I.D.: 29/32 (23.0) & 10 11/32 (262.7)
Height: 24 1/2 (622.3)
A. Gskt: [1] Attached
F. Gskt: [1] Included
Related To: LL2562 (Long-Life Media Version)
 PA2562 (Standard Media Version)

PA2563

Inner Air Element



Fits Inside: LL2562, PA2562, PA2562XP, PA2849
Fits: Caterpillar, Hitachi, Ingersoll-Rand, Koehring, Terex, Wabco Equipment
Replaces: Caterpillar 1N4864; Ingersoll-Rand 35298116; WABCO VE1061
O.D.: 10 1/4 (260.4)
I.D.: 29/32 (23.0) & 9 1/8 (231.8)
Height: 22 1/2 (571.5)
A. Gskt: [1] Attached
F. Gskt: [1] Included

PA2564

DynaCell Air Element Replacement

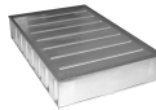

Notes: Both sides are open.
Replaces: Caterpillar 7C8343; Farr C49812, T528D; Ford D8HZ-9601-D; GMC 25040430; White 22-0050004
Length: 28 1/2 (723.9)
Width: 19 (482.6)
Height: 5 3/8 (136.5)
Related To: PA2444 (Sides are Closed)

PA2566

Air Element



Fits: Design Engineering Optional Equipment
Replaces: Design Engineering DEP1126
O.D.: 9 5/8 (244.5)
I.D.: 3/8 (9.5) & 5 (127.0)
Height: 10 5/32 (258.0)
A. Gskt: [1] Attached
F. Gskt: [1] Included

Measurements Are Shown In Inches And (Millimeters)



WARNING: These products can expose you to chemicals, including Diisononyl Phthalate, Carbon black extracts, Nickel, 1,3 Butadiene, Ethylene Oxide, Epichlorohydrin, which are known to the State of California to cause cancer, and Bisphenol, Ethylene Glycol, Ethylene Oxide, 1,3 Butadiene, Epichlorohydrin, which are known to the State of California to cause birth defects or other reproductive harm. For more information go to www.P65Warnings.ca.gov.

PA2567

Outer Air Element



Fits: White Equipment
Use With: PA2568
Replaces: White 30-3216535
O.D.: 9 1/16 (230.2)
I.D.: 15/16 (23.8) & 5 3/8 (136.5)
Height: 17 3/8 (441.3)
A. Gskt: [1] Attached
F. Gskt: [1] Included

PA2573

Outer Air Element



Fits: Ag-Chem, Dynapac, Tamrock, V.M.E.,
 Volvo Equipment; Sullair Compressors
Use With: PA2574
Replaces: Ag-Chem 700282; Dynapac 499505;
 Sullair 46299; V.M.E. M12565177
O.D.: 13 13/16 (350.8)
I.D.: 15/16 (23.8) & 9 1/2 (241.3)
Height: 20 1/2 (520.7)
A. Gskt: [1] Attached
F. Gskt: G285-AF, [1] Included
Related To: PA2573XP (Extreme Performance
 Nano Version)

PA2568

Inner Air Element



Fits Inside: PA2567
Fits: White Equipment
Replaces: White 30-3216543
O.D.: 5 1/4 (133.4)
I.D.: 5/8 (15.9) & 4 1/8 (104.8)
Height: 15 1/2 (393.7)
A. Gskt: [1] Included
F. Gskt: G103-N

PA2573XP

Extreme Performance Nano Outer Air Element



Fits: Ag-Chem, Dynapac, Tamrock, V.M.E.,
 Volvo Equipment; Sullair Compressors
Use With: PA2574
Replaces: Ag-Chem 700282; Dynapac 499505;
 Sullair 46299; V.M.E. M12565177
O.D.: 13 13/16 (350.8)
I.D.: 15/16 (23.8) & 9 1/2 (241.3)
Height: 20 1/2 (520.7)
A. Gskt: [1] Attached
F. Gskt: G285-AF, [1] Included
Related To: PA2573 (Standard Media Version)

PA2569

Outer Air Element with Lift Tab



Fits: Ford Tractors
Use With: PA2435
Replaces: Ford D5NN-9B618-B
O.D.: 9 (228.6)
 Boot 10 (254.0)
I.D.: 1/2 (12.7) & 5 11/16 (144.5)
Height: 16 3/8 (415.9)
A. Gskt: [2] Attached
F. Gskt: [1] Included

PA2574

Inner Air Element



Fits Inside: PA2573, PA2573XP
Fits: Ag-Chem, Dynapac, Tamrock, V.M.E.,
 Volvo Equipment; Sullair Compressors
Replaces: Ag-Chem 700270; Dynapac 499509;
 Sullair 47523; V.M.E. M12565176
O.D.: 8 5/8 (219.1)
I.D.: 15/16 (23.8) & 7 1/16 (179.4)
Height: 18 1/2 (469.9)
A. Gskt: [1] Attached
F. Gskt: [1] Included

PA2570

Inner Air Element



Fits Inside: LL1681-FN, PA1681-FN, PA1882,
 PA2666, PA2709
Fits: Bobcat, Gehl, John Deere Equipment;
 Tymco Sweepers
Replaces: Gehl 131853; John Deere AT44378
O.D.: 3 3/8 (85.7)
 Flange 4 5/32 (105.6)
I.D.: 5/8 (15.9) & 2 29/32 (73.8)
Height: 11 3/32 (281.8)
A. Gskt: [1] Attached
F. Gskt: G103-N

LL2575

Long Life Outer Air Element



Fits: Caterpillar Equipment, Lift Trucks
Use With: PA2576, PA2730
Replaces: Caterpillar 7N9028, 8N5504
O.D.: 8 3/8 (212.7)
I.D.: 4 (101.6) One End
Height: 5 27/32 (148.4)
A. Gskt: [1] Attached
Related To: PA2575 (Standard Media Version)

PA2571

Air Element



Replaces: GMC 25041990, 25166966
O.D.: 12 3/4 (323.9)
I.D.: 8 11/32 (211.9) One End
Height: 17 (431.8)
A. Gskt: [2] Attached
F. Gskt: G25-AF

PA2575

Outer Air Element



Fits: Caterpillar Equipment
Use With: PA2576, PA2730
Replaces: Caterpillar 7N9028, 8N5504
O.D.: 8 3/8 (212.7)
I.D.: 4 (101.6) One End
Height: 5 27/32 (148.4)
A. Gskt: [1] Attached
Related To: LL2575 (Long-Life Media Version)

PA2572

Cab Air Element



Fits: Caterpillar Equipment
Replaces: Caterpillar 6P1290
Length: 25 1/2 (647.7)
Width: 6 1/16 (154.0)
Height: 2 3/16 (55.6)

PA2576

Inner Air Element with 6 Bolts



Fits Inside: LL2575, PA2575
Fits: Caterpillar Equipment
Replaces: Caterpillar 7N9027
O.D.: 3 3/4 (95.3)
 Flange 6 11/16 (169.9)
I.D.: 2 5/8 (66.7) One End
Height: 5 1/8 (130.2)
A. Gskt: [1] Attached

Measurements Are Shown In Inches And (Millimeters)

WARNING: These products can expose you to chemicals, including Diisononyl Phthalate, Carbon black extracts, Nickel, 1,3 Butadiene, Ethylene Oxide, Epichlorohydrin, which are known to the State of California to cause cancer, and Bisphenol, Ethylene Glycol, Ethylene Oxide, 1,3 Butadiene, Epichlorohydrin, which are known to the State of California to cause birth defects or other reproductive harm. For more information go to www.P65Warnings.ca.gov.

PA2577



Outer Air Element

Fits: GMC, Isuzu, Nissan Buses, Trucks; Hitachi, John Deere, Kobelco, Komatsu, Link-Belt, MDI/Yutani, Mitsubishi, Timberjack, Timbco Equipment
Use With: PA2578
Replaces: GMC 94048864; Hitachi 4288963; Isuzu 1-14214-126-0; John Deere T52223; Kobelco 2446U191-S3; Mitsubishi ME063130; Nissan 16546-96071; Timberjack 8410616
O.D.: 10 27/32 (275.4)
I.D.: 15/16 (23.8) & 6 1/2 (165.1)
Height: 15 1/2 (393.7)
A. Gskt: [1] Attached
F. Gskt: [1] Included

LL2582



Long Life Outer Air Element

Fits: Case, Champion, Hitachi, John Deere, Kawasaki, Kobelco, V.M.E., Volvo Equipment
Use With: PA2583, PA3896
Replaces: Case 150783A1; Champion 37398; John Deere AT136708; Kawasaki 30981-70100
O.D.: 10 27/32 (275.4)
I.D.: 15/16 (23.8) & 6 1/2 (165.1)
Height: 20 1/2 (520.7)
A. Gskt: [1] Attached
F. Gskt: [1] Included
Related To: PA2582 (Standard Media Version)

PA2578



Inner Air Element

Fits Inside: PA2577
Fits: GMC, Isuzu, Nissan Buses, Trucks; Hitachi, John Deere, Kobelco, Komatsu, MDI/Yutani, Timberjack, Timbco Equipment
Replaces: GMC 25096436; Isuzu 1-14215-125-1; John Deere T52224; Nissan 16546-96072
O.D.: 6 3/8 (161.9)
I.D.: 5/8 (15.9) & 5 9/32 (134.1)
Height: 14 3/8 (365.1)
A. Gskt: [1] Attached
F. Gskt: G103-N

PA2582



Outer Air Element

Fits: Case, Champion, Hitachi, John Deere, Kawasaki, Kobelco, V.M.E., Volvo Equipment
Use With: PA2583, PA3896
Replaces: Case 150783A1; Champion 37398; John Deere AT136708; Kawasaki 30981-70100
O.D.: 10 27/32 (275.4)
I.D.: 15/16 (23.8) & 6 1/2 (165.1)
Height: 20 1/2 (520.7)
A. Gskt: [1] Attached
F. Gskt: [1] Included
Related To: LL2582 (Long-Life Media Version)

PA2579



Inner Air Element

Fits Inside: LL2330, PA2330, PA2612
Fits: International Trucks
Replaces: GMC 25096133; International 530560-C1
O.D.: 7 3/16 (182.6)
I.D.: 21/32 (16.7) & 5 11/16 (144.5)
Height: 14 3/8 (365.1)
A. Gskt: [1] Attached
F. Gskt: G103-N

PA2583



Inner Air Element

Fits Inside: LL2582, PA2582
Fits: Case, Champion, FMC, Hitachi, John Deere, Kawasaki, Kobelco, Kubota, Volvo Equipment
Replaces: Champion 37399; John Deere AT136707; Kubota 12499-11210
O.D.: 6 3/8 (161.9)
I.D.: 5/8 (15.9) & 5 9/32 (134.1)
Height: 19 1/2 (495.3)
A. Gskt: [1] Attached
F. Gskt: G103-N

PA2580



Air Element

Contains: Flame Retardant Media
Fits: R.V.I. Trucks
Replaces: GMC 9093553
O.D.: 12 3/4 (323.9)
I.D.: 8 11/32 (211.9)
Height: 23 1/2 (596.9)
A. Gskt: [1] Attached

PA2585



Air Element with Air Restriction Gauge Fitting

Fits: Ford Buses, Trucks
Replaces: Ford D6HZ-9601-A
O.D.: 9 7/32 (234.2)
 9 5/16 (236.5)
I.D.: 17/32 (13.5) & 4 27/32 (123.0)
Height: 9 1/32 (229.4)
A. Gskt: [1] Attached
F. Gskt: [1] Included

PA2581



Air Element

Fits: Cummins, Deutz, Perkins Engines; Ford Trucks; Leyland Buses
Replaces: Cummins 650931; Leyland 37H3737
O.D.: 7 15/16 (201.6)
I.D.: 11/16 (17.5) & 3 9/16 (90.5)
Height: 13 3/8 (339.7)
A. Gskt: [1] Attached
F. Gskt: G103-N

PA2586



Inner Air Element

Fits Inside: PA2520
Fits: Caterpillar Marine Engines; International Trucks
Replaces: Caterpillar 8N5006
O.D.: 5 15/16 (150.8)
I.D.: 21/32 (16.7) & 4 27/32 (123.0)
Height: 9 5/8 (244.5)
A. Gskt: [1] Attached

Measurements Are Shown In Inches And (Millimeters)



WARNING: These products can expose you to chemicals, including Diisononyl Phthalate, Carbon black extracts, Nickel, 1,3 Butadiene, Ethylene Oxide, Epichlorohydrin, which are known to the State of California to cause cancer, and Bisphenol, Ethylene Glycol, Ethylene Oxide, 1,3 Butadiene, Epichlorohydrin, which are known to the State of California to cause birth defects or other reproductive harm. For more information go to www.P65Warnings.ca.gov.

PA2587

Outer Air Element



Fits: Ford, Koehring, New Holland Equipment
Use With: PA2588
Replaces: Ford D5NN-9B618-A;
 Koehring 8825161
O.D.: 5 5/16 (134.9)
 Boot 5 3/4 (146.1)
I.D.: 7/16 (11.1) & 3 1/16 (77.8)
Height: 14 21/32 (372.3)
A. Gskt: [2] Attached
F. Gskt: [1] Included

PA2588

Inner Air Element



Fits Inside: PA2587
Fits: Ford, Koehring, New Holland Equipment
Replaces: Ford D6NN-9R500-B;
 Koehring 8825162
O.D.: 2 15/16 (74.6)
I.D.: 1/2 (12.7) & 2 13/32 (61.1)
Height: 13 3/8 (339.7)
A. Gskt: [1] Attached
F. Gskt: [1] Included

PA2589-FN

Air Element with Fins



Fits: Kubota Tractors
Replaces: Kubota 70000-17500
O.D.: 6 3/32 (154.8)
 Fins 7 13/16 (198.4)
I.D.: 1/2 (12.7) & 3 15/32 (88.1)
Height: 6 3/32 (154.8)
A. Gskt: [1] Attached
F. Gskt: [1] Included

PA2591

Outer Air Element with Lift Tab



Fits: Case, International Tractors
Use With: PA2510
Replaces: Case A45694
O.D.: 10 3/8 (263.5)
 Boot 11 (279.4)
I.D.: 21/32 (16.7) & 6 1/32 (153.2)
Height: 18 3/8 (466.7)
A. Gskt: [2] Attached
F. Gskt: G103-N, [1] Wing Nut

PA2592

Air Element for Pressurized Cab



Fits: Caterpillar Equipment
Replaces: Caterpillar 2V0036, 2V36
O.D.: 6 5/8 (168.3)
I.D.: 4 1/4 (108.0) One End
Height: 9 9/32 (235.7)
A. Gskt: [1] Attached

PA2593

Panel Air Element

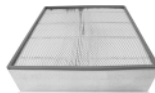

Replaces: International 947965-C2
Length: 19 1/2 (495.3)
Width: 19 1/2 (495.3)
Height: 5 9/16 (141.3)

PA2595

Outer Air Element with Lid



Replaces: White 22-0050010
O.D.: 12 3/4 (323.9)
 Lid 16 1/8 (409.6)
I.D.: 7 7/16 (188.9) One End
Height: 18 13/32 (467.5)
A. Gskt: [2] Attached

PA2596

Air Element



Fits: Ford, GMC Buses, Trucks
Replaces: Ford E0HT-9600-B; GMC 25041370
O.D.: 12 3/32 (307.2)
I.D.: 8 11/16 (220.7)
Height: 8 (203.2)
A. Gskt: [2] Attached

PA2598

Air Element



Fits: Design Engineering Optional Equipment
Replaces: Design Engineering DEP1226
O.D.: 9 11/32 (237.3)
I.D.: 3/8 (9.5) & 6 1/4 (158.8)
Height: 10 1/8 (257.2)
A. Gskt: [1] Attached
F. Gskt: [1] Included

PA2599

Air Element



Fits: Ford, GMC Buses, Trucks
Replaces: Ford E0HZ-9601-B; GMC 25041372
O.D.: 12 1/32 (305.6)
I.D.: 6 23/32 (170.7)
Height: 8 (203.2)
A. Gskt: [2] Attached

PA2600

Air Element with Lid



Fits: R.V.I. Trucks
Replaces: Renault 5000814944
O.D.: 9 29/32 (251.6)
 Lid 14 15/32 (367.5)
I.D.: 5/8 (15.9) & 6 15/32 (164.3)
Height: 15 1/2 (393.7)
A. Gskt: [2] Attached
F. Gskt: G103-N

PA2601

Cab Air Element



Fits: New Holland, Versatile Tractors
Replaces: New Holland V30986;
 Versatile 30986
Length: 44 (1117.6)
Width: 4 (101.6)
Height: 2 9/16 (65.1)
A. Gskt: [1] Attached

PA2602

Inner Air Element



Fits Inside: LL2344-FN, PA2344-FN
Fits: Case, Ford, Gehl, John Deere, New
 Holland, Thomas Equipment
Replaces: Case D82775; Ford 9809915;
 Gehl 263638; John Deere MG272744;
 New Holland 221688
O.D.: 2 3/8 (60.3)
 Flange 4 1/2 (114.3)
I.D.: 21/32 (16.7) & 2 (50.8)
Height: 13 1/4 (336.6)
A. Gskt: [2] Attached
F. Gskt: G103-N

Measurements Are Shown In Inches And (Millimeters)

WARNING: These products can expose you to chemicals, including Diisononyl Phthalate, Carbon black extracts, Nickel, 1,3 Butadiene, Ethylene Oxide, Epichlorohydrin, which are known to the State of California to cause cancer, and Bisphenol, Ethylene Glycol, Ethylene Oxide, 1,3 Butadiene, Epichlorohydrin, which are known to the State of California to cause birth defects or other reproductive harm. For more information go to www.P65Warnings.ca.gov.

PA2604



Outer Air Element

Fits: LeRoi Compressors
Use With: PA2605
Replaces: LeRoi 43-654
O.D.: 11 1/2 (292.1)
I.D.: 13/32 (10.3) & 7 1/4 (184.2)
Height: 15 7/8 (403.2)
A. Gskt: [1] Attached
F. Gskt: [1] Included

LL2609



Long Life Outer Air Element

Fits: Caterpillar Industrial Engines, Equipment
Use With: PA2385, PA2625
Replaces: Caterpillar 1W2516
O.D.: 12 1/2 (317.5)
I.D.: 9 1/8 (231.8) One End
Height: 19 (482.6)
A. Gskt: [1] Attached
Related To: PA2609 (Standard Media Version)

PA2605



Inner Air Element

Fits Inside: PA261
Fits: Massey Ferguson Wheel Tractors
Replaces: Massey Ferguson 1044274-M91
O.D.: 6 7/8 (174.6)
I.D.: 21/32 (16.7) & 5 9/16 (141.3)
Height: 14 3/8 (365.1)
A. Gskt: [1] Attached
F. Gskt: G103-N

PA2609



Outer Air Element

Fits: Caterpillar Industrial Engines, Equipment
Use With: PA2385, PA2625
Replaces: Caterpillar 1W2516
O.D.: 12 1/2 (317.5)
I.D.: 9 1/8 (231.8) One End
Height: 19 (482.6)
A. Gskt: [1] Attached
Related To: LL2609 (Long-Life Media Version)

PA2606



Outer Air Element with Lift Tab

Fits: Franklin Loggers
Use With: PA2607
Replaces: Franklin 1504917
O.D.: 9 (228.6)
 Boot 10 (254.0)
I.D.: 5 11/16 (144.5) One End
Height: 13 9/16 (344.5)
A. Gskt: [2] Attached

PA2610



Cab Air Element

Fits: John Deere Equipment
Replaces: John Deere AH115833
O.D.: 10 27/32 (275.4)
I.D.: 21/32 (16.7) & 6 1/2 (165.1)
Height: 7 1/2 (190.5)
F. Gskt: G103-N

PA2607



Inner Air Element

Fits Inside: PA2606
Fits: Franklin Loggers
Replaces: Franklin 1504918
O.D.: 5 9/16 (141.3)
I.D.: 13/32 (10.3) & 4 1/2 (114.3)
Height: 12 1/2 (317.5)
F. Gskt: G15-AF

PA2611



Outer Air Element

Fits: Massey Ferguson Wheel Tractors
Use With: PA2605
Replaces: Massey Ferguson 1044273-M91
O.D.: 11 1/2 (292.1)
I.D.: 13/32 (10.3) & 7 1/4 (184.2)
Height: 15 11/16 (398.5)
A. Gskt: [1] Attached
F. Gskt: [1] Included

LL2608



Long Life Air Element

Fits: Peterbilt Trucks with Vortex Housing
Replaces: GMC 25096184; Vortex VF160R
O.D.: 12 3/4 (323.9)
I.D.: 21/32 (16.7) & 8 11/32 (211.9)
Height: 27 (685.8)
A. Gskt: [2] Attached
F. Gskt: [1] Included
Related To: PA2608 (Standard Media Version)

PA2612



Outer Air Element with Lift Tabs

Fits: International Trucks
Use With: PA2579
Replaces: International 494730-C91
O.D.: 12 1/32 (305.6)
I.D.: 5/8 (15.9) & 7 11/16 (195.3)
Height: 17 3/4 (450.9)
A. Gskt: [2] Attached
F. Gskt: G103-N

PA2608



Air Element

Notes: Inside-Out Flow Direction
Fits: Peterbilt Trucks; Vortex Housings
Replaces: GMC 25096184; Vortex VF160R
O.D.: 12 3/4 (323.9)
I.D.: 21/32 (16.7) & 8 11/32 (211.9)
Height: 27 (685.8)
A. Gskt: [2] Attached
F. Gskt: [1] Included
Related To: LL2608 (Long-Life Media Version)

PA2613



Cab Air Element

Fits: Caterpillar Equipment
Replaces: Caterpillar 7G8116
O.D.: 6 3/32 (154.8)
I.D.: 21/32 (16.7) & 3 15/32 (88.1)
Height: 7 9/32 (184.9)
A. Gskt: [1] Attached
F. Gskt: [1] Wing Nut

Measurements Are Shown In Inches And (Millimeters)

! **WARNING:** These products can expose you to chemicals, including Diisononyl Phthalate, Carbon black extracts, Nickel, 1,3 Butadiene, Ethylene Oxide, Epichlorohydrin, which are known to the State of California to cause cancer, and Bisphenol, Ethylene Glycol, Ethylene Oxide, 1,3 Butadiene, Epichlorohydrin, which are known to the State of California to cause birth defects or other reproductive harm. For more information go to www.P65Warnings.ca.gov.

PA2614



Outer Air Element with Lift Tab
Fits: Massey Ferguson Wheel Tractors; Winpower Generators
Use With: PA2615
Replaces: Massey Ferguson 1051374-M91
O.D.: 12 1/2 (317.5)
I.D.: 13/32 (10.3) & 7 1/2 (190.5)
Height: 22 1/4 (565.2)
A. Gskt: [1] Attached
F. Gskt: [1] Included

PA2618



Air Element with Lift Tabs
Fits: Cummins Engines
Replaces: Cummins 3013205
O.D.: 13 7/8 (352.4)
I.D.: 11/16 (17.5) & 7 7/16 (188.9)
Height: 18 1/2 (469.9)
A. Gskt: [1] Included
F. Gskt: G103-N
Related To: LL2618 (Long-Life Media Version)

PA2615



Inner Air Element
Fits Inside: PA2614
Fits: Massey Ferguson Wheel Tractors
Replaces: Massey Ferguson 1051373-M91
O.D.: 7 3/8 (187.3)
I.D.: 25/32 (19.8) & 6 1/8 (155.6)
Height: 20 7/8 (530.2)
A. Gskt: [1] Attached
F. Gskt: G103-N

PA2619



Cab Air Element
Fits: Case, International, New Holland, Versatile Equipment
Replaces: International 143481-C91; Versatile V105382
Length: 38 (965.2)
Width: 6 (152.4)
Height: 2 9/16 (65.1)
A. Gskt: [1] Attached
Related To: PA2407 (without Attached Gasket)

PA2616



Outer Air Element
Fits: John Deere Graders
Use With: PA2687
Replaces: Alliance ABPN10GAF1896M; Caterpillar 310331; General Motors 25177201; John Deere AT75035
O.D.: 10 3/8 (263.5)
I.D.: 21/32 (16.7) & 6 1/32 (153.2)
Height: 13 3/8 (339.7)
A. Gskt: [1] Attached
F. Gskt: G103-N
Related To: PA2616XP (Extreme Performance Nano Version)

PA2620



Outer Air Element with Lift Tab
Fits: Ford Tractors
Use With: PA2621
Replaces: Ford D8NN-9B618-AA
O.D.: 9 1/8 (231.8)
Boot: 9 3/4 (247.7)
I.D.: 1/2 (12.7) & 5 13/16 (147.6)
Height: 18 1/2 (469.9)
A. Gskt: [2] Attached
F. Gskt: [1] Included, [1] Wing Nut

PA2616XP



Extreme Performance Nano Outer Air Element
Fits: John Deere Graders
Use With: PA2687
Replaces: Alliance ABPN10GAF1896M; Caterpillar 310331; General Motors 25177201; John Deere AT75035
O.D.: 10 3/8 (263.5)
I.D.: 21/32 (16.7) & 6 1/32 (153.2)
Height: 13 3/8 (339.7)
A. Gskt: [1] Attached
F. Gskt: G103-N
Related To: PA2616 (Standard Media Version)

PA2621



Inner Air Element
Fits Inside: PA2620, LL2688, PA2688
Fits: Case, Champion, Ford, Hitachi, John Deere, Komatsu, Volvo Equipment; Hino Trucks
Replaces: Case S238647; Ford D8NN-9R500-AA; Hino 17801-2460; John Deere AT81019; Komatsu 600-181-8370
O.D.: 5 23/32 (145.3)
I.D.: 11/16 (17.5) & 4 19/32 (116.7)
Height: 17 1/2 (444.5)
A. Gskt: [1] Attached
F. Gskt: G103-N

PA2617



Cab Air Element
Fits: Case Equipment
Replaces: Case F64318
Length: 38 (965.2)
Width: 7 (177.8)
Height: 2 3/16 (55.6)

PA2622



Inner Air Element
Fits Inside: PA1794-FN
Fits: John Deere Tractors
Replaces: John Deere AL27160
O.D.: 3 3/8 (85.7)
Flange: 4 5/32 (105.6)
I.D.: 21/32 (16.7) & 2 7/8 (73.0)
Height: 9 1/16 (230.2)
A. Gskt: [1] Attached
F. Gskt: [1] Included, [1] Wing Nut

LL2618



Long Life Air Element with Lift Tabs
Fits: Cummins Engines
Replaces: Cummins 3013205
O.D.: 13 7/8 (352.4)
I.D.: 11/16 (17.5) & 7 7/16 (188.9)
Height: 18 1/2 (469.9)
A. Gskt: [1] Included
F. Gskt: G103-N
Related To: PA2618 (Standard Media Version)

PA2623



Conical-Shaped Air Element
Fits: Cummins Engines; International Trucks
Replaces: International 503647-C91
O.D.: 5 3/4 (146.1) to 8 21/32 (219.9)
I.D.: 5 3/16 (131.8) One End
Height: 23 (584.2)
A. Gskt: [2] Attached
F. Gskt: [1] Included

Measurements Are Shown In Inches And (Millimeters)

WARNING: These products can expose you to chemicals, including Diisononyl Phthalate, Carbon black extracts, Nickel, 1,3 Butadiene, Ethylene Oxide, Epichlorohydrin, which are known to the State of California to cause cancer, and Bisphenol, Ethylene Glycol, Ethylene Oxide, 1,3 Butadiene, Epichlorohydrin, which are known to the State of California to cause birth defects or other reproductive harm. For more information go to www.P65Warnings.ca.gov.

PA2624



Outer Air Element
Use With: PA2625
Replaces: Ingersoll-Rand 35254903
O.D.: 13 13/16 (350.8)
 Boot 14 1/2 (368.3)
I.D.: 15/16 (23.8) & 9 1/2 (241.3)
Height: 15 1/2 (393.7)
A. Gskt: [2] Attached
F. Gskt: [1] Included

PA2630



Inner Air Element
Fits Inside: PA2629
Replaces: GMC 25096454; Ingersoll-Rand 58179367; International 501276-C1
O.D.: 8 1/4 (209.6)
I.D.: 15/16 (23.8) & 7 1/8 (181.0)
Height: 16 3/8 (415.9)
A. Gskt: [1] Attached
F. Gskt: [1] Included

PA2625



Inner Air Element
Fits Inside: PA1815, LL2384, PA2384, PA2384XP, LL2609, PA2609, PA2624
Fits: Caterpillar Applications Converted from Flanged Air Systems Previously Using PA1797 or PA2385
Replaces: Ingersoll-Rand 35254895
O.D.: 8 5/8 (219.1)
I.D.: 15/16 (23.8) & 7 1/16 (179.4)
Height: 14 1/2 (368.3)
A. Gskt: [1] Attached
F. Gskt: [1] Included

PA2631



Conical-Shaped Air Element
Fits: Freightliner Buses, Trucks; New Flyer Transit Buses
Replaces: Caterpillar 7C8320; GMC 8881300; International 594240-C1; Universal Coach T121022
O.D.: 9 25/32 (248.4) to 12 3/4 (323.9)
I.D.: 8 11/32 (211.9) One End
Height: 25 (635.0)
A. Gskt: [2] Attached
F. Gskt: G501-AF

PA2626



Cab Air Element
Fits: Caterpillar Equipment
Replaces: Caterpillar 8P5343
Length: 23 1/2 (596.9)
Width: 6 (152.4)
Height: 2 3/16 (55.6)

PA2632

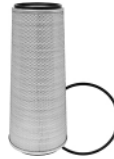

Conical-Shaped Air Element
Notes: Inside-Out Flow Direction
Fits: Ford, Freightliner Buses, Trucks
Replaces: Caterpillar 7C8318; Ford E2HZ-9601-A; GMC 25095857; Mack 57MD41M
O.D.: 9 25/32 (248.4) to 12 3/4 (323.9)
I.D.: 8 11/32 (211.9) One End
Height: 29 (736.6)
A. Gskt: [2] Attached
F. Gskt: G501-AF

PA2627



Dual-Stage Air Element with Blanket and Screen
Replaces: Fram CA3440
O.D.: 9 9/16 (242.9)
I.D.: 5 1/8 (130.2)
Height: 11 19/32 (294.5)
Related To: PA1701 (One End Closed)

PA2633-FN



Outer Air Element with Fins
Fits: Case Equipment
Use With: PA2634
Replaces: Case A47032
O.D.: 6 7/8 (174.6)
 Fins 8 13/16 (223.8)
I.D.: 21/32 (16.7) & 4 3/16 (106.4)
Height: 14 1/2 (368.3)
A. Gskt: [1] Attached
F. Gskt: G103-N

PA2628



Air Element
Fits: Peterbilt Trucks
Replaces: GMC 25043068; Peterbilt 513200
O.D.: 9 1/2 (241.3)
I.D.: 6 1/2 (165.1)
Height: 28 1/2 (723.9)
A. Gskt: [2] Attached

PA2634



Inner Air Element
Fits Inside: PA2633-FN
Fits: Case Equipment
Replaces: Case A47033
O.D.: 4 3/32 (104.0)
 Flange 4 27/32 (123.0)
I.D.: 25/32 (19.8) & 3 5/8 (92.1)
Height: 13 3/32 (332.6)
A. Gskt: [1] Attached
F. Gskt: G103-N

PA2629



Outer Air Element with Lid
Use With: PA2630
Replaces: GMC 25043813; Ingersoll-Rand 58179359; International 505633-C1
O.D.: 12 3/4 (323.9)
 Lid 16 1/8 (409.6)
I.D.: 8 11/32 (211.9) One End
Height: 19 17/32 (496.1)
A. Gskt: [2] Attached

PA2635-FN



Outer Air Element with Fins and Lid
Fits: John Deere Tractors
Use With: PA2644
Replaces: John Deere AL30394
O.D.: 6 11/32 (161.1)
 Lid 8 3/8 (212.7)
I.D.: 5/8 (15.9) & 3 15/32 (88.1)
Height: 14 5/8 (371.5)
A. Gskt: [1] Attached
F. Gskt: [1] Included, [1] Wing Nut

Measurements Are Shown In Inches And (Millimeters)

WARNING: These products can expose you to chemicals, including Diisononyl Phthalate, Carbon black extracts, Nickel, 1,3 Butadiene, Ethylene Oxide, Epichlorohydrin, which are known to the State of California to cause cancer, and Bisphenol, Ethylene Glycol, Ethylene Oxide, 1,3 Butadiene, Epichlorohydrin, which are known to the State of California to cause birth defects or other reproductive harm. For more information go to www.P65Warnings.ca.gov.

PA2636

Air Element



Contains: Flame Retardant Media
Fits: Caterpillar Lift Trucks
Replaces: Towmotor 348547
O.D.: 4 17/32 (115.1)
I.D.: 2 1/4 (57.2)
Height: 11 (279.4)

PA2642

Air Element



Fits: Ford Trucks
Replaces: Ford E2HZ-9601-B
O.D.: 13 7/8 (352.4)
I.D.: 11/16 (17.5) & 7 7/16 (188.9)
Height: 10 1/2 (266.7)
A. Gskt: [1] Attached
F. Gskt: G103-N
Related To: LL2642 (Long-Life Media Version)

PA2637

Outer Air Element



Fits: Case Tractors
Replaces: Case A42758
O.D.: 6 5/8 (168.3)
I.D.: 3/8 (9.5) & 4 11/32 (110.3)
Height: 14 5/16 (363.5)
A. Gskt: [1] Attached
F. Gskt: [1] Included

PA2643

Air Element



Replaces: White 22-0050012
O.D.: 12 1/32 (305.6)
I.D.: 6 23/32 (170.7)
Height: 16 (406.4)
A. Gskt: [2] Attached

PA2638

Cab Air Element



Fits: White Equipment
Replaces: White 30-3175154
Length: 36 (914.4)
Width: 6 1/2 (165.1)
Height: 2 3/16 (55.6)

PA2644

Inner Air Element



Fits Inside: PA2635-FN
Fits: John Deere Tractors
Replaces: John Deere AL30395
O.D.: 3 3/8 (85.7)
Flange 3 25/32 (96.0)
I.D.: 21/32 (16.7) & 2 7/8 (73.0)
Height: 13 1/16 (331.8)
A. Gskt: [1] Attached
F. Gskt: [1] Included, [1] Wing Nut

PA2640

Outer Air Element



Fits: Allis Chalmers Tractors
Replaces: Allis Chalmers 259792
O.D.: 12 1/32 (305.6)
I.D.: 5/8 (15.9) & 7 11/16 (195.3)
Height: 19 1/2 (495.3)
A. Gskt: [1] Attached
F. Gskt: G103-N

PA2645

Outer Air Element with Lift Tab



Fits: Massey Ferguson Wheel Tractors
Use With: PA2646
Replaces: Massey Ferguson 1633719-M1
O.D.: 8 1/4 (209.6)
Boot 9 1/8 (231.8)
I.D.: 3/8 (9.5) & 5 1/4 (133.4)
Height: 12 5/8 (320.7)
A. Gskt: [2] Attached

PA2641

Outer Air Element



Fits: Ford Trucks; Allis Chalmers, Deutz, Liebherr, Same, Yale Equipment
Use With: PA1912
Replaces: Deutz 4319263; Ford 83DB-9601-AA; Liebherr 7401993; Massey Ferguson 3074305-M1
O.D.: 9 7/32 (234.2)
I.D.: 21/32 (16.7) & 4 27/32 (123.0)
Height: 16 1/2 (419.1)
A. Gskt: [1] Included
F. Gskt: G103-N

PA2646

Inner Air Element



Fits Inside: PA2645
Fits: Massey Ferguson Wheel Tractors
Replaces: Massey Ferguson 1633720-M1
O.D.: 5 5/32 (131.0)
I.D.: 3/8 (9.5) & 4 1/32 (102.4)
Height: 11 1/2 (292.1)
A. Gskt: [1] Attached
F. Gskt: [1] Included

LL2642

Long Life Air Element



Fits: Ford Trucks
Replaces: Ford E2HZ-9601-B
O.D.: 13 7/8 (352.4)
I.D.: 11/16 (17.5) & 7 7/16 (188.9)
Height: 10 1/2 (266.7)
A. Gskt: [1] Attached
F. Gskt: G103-N
Related To: PA2642 (Standard Media Version)

PA2647

Inner Air Element with 10 Bolt Holes



Fits Inside: LL2384, PA2384, PA2384XP
Fits: Caterpillar Industrial, Marine Engines, Equipment; Ford Trucks
Replaces: Caterpillar 1W8161, 6N6444, 8N8934
O.D.: 8 5/8 (219.1)
Flange 11 3/8 (288.9)
I.D.: 6 31/32 (177.0) One End
Height: 12 (304.8)
A. Gskt: [1] Attached

Measurements Are Shown In Inches And (Millimeters)

WARNING: These products can expose you to chemicals, including Diisononyl Phthalate, Carbon black extracts, Nickel, 1,3 Butadiene, Ethylene Oxide, Epichlorohydrin, which are known to the State of California to cause cancer, and Bisphenol, Ethylene Glycol, Ethylene Oxide, 1,3 Butadiene, Epichlorohydrin, which are known to the State of California to cause birth defects or other reproductive harm. For more information go to www.P65Warnings.ca.gov.

PA2648



Air Element with Lid and 6 Bolt Holes
Fits: WhiteGMC Trucks
Replaces: White 22-0050013
O.D.: 13 7/8 (352.4)
Lid: 16 1/8 (409.6)
I.D.: 7 7/16 (188.9) One End
Height: 15 17/32 (394.5)
A. Gskt: [2] Attached

PA2654



Outer Air Element with Lift Bars
Fits: Massey Ferguson Wheel Tractors
Use With: PA2655
Replaces: Massey Ferguson 1051376-M91
O.D.: 11 1/2 (292.1)
I.D.: 13/32 (10.3) & 7 1/4 (184.2)
Height: 20 1/2 (520.7)
A. Gskt: [1] Attached
F. Gskt: [1] Included

PA2649



Air Element
Fits: Volvo Trucks
Replaces: Volvo 475975, 475975-1, 475975-9
O.D.: 7 15/16 (201.6)
I.D.: 7/16 (11.1) & 4 5/8 (117.5)
Height: 24 1/8 (612.8)
A. Gskt: [1] Included
F. Gskt: [1] Included

PA2655



Inner Air Element
Fits Inside: PA2654
Fits: Massey Ferguson Wheel Tractors
Replaces: Massey Ferguson 1051375-M91
O.D.: 6 7/8 (174.6)
I.D.: 5/8 (15.9) & 5 13/32 (137.3)
Height: 19 1/16 (484.2)
A. Gskt: [1] Attached
F. Gskt: G103-N

PA2650



Replacement for Ecolite Air Element in Disposable Housing
Fits: Freightliner, Kenworth Trucks
Replaces: Caterpillar 7C8339; Farr C71338-2 Series; GMC 25043580
O.D.: 11 1/32 (280.2)
Inlet: 10 23/32
Outlet: 7
Height: 25 7/8 (657.2)

PA2656



Air Element
Fits: GMC Buses, Trucks
Replaces: GMC 15583321
O.D.: 10 3/8 (263.5)
I.D.: 6 1/32 (153.2) One End
Height: 10 1/2 (266.7)
A. Gskt: [1] Attached

PA2651



Outer Air Element
Fits: Komatsu Equipment
Use With: PA2652
Replaces: Komatsu 600-181-9220
O.D.: 8 1/4 (209.6)
I.D.: 13/32 (10.3) & 4 3/16 (106.4)
Height: 12 15/16 (328.6)
A. Gskt: [1] Attached
F. Gskt: [1] Included

PA2657-FN



Outer Air Element with Fins
Fits: Case, Dresser, Hough, International, Oliver Equipment
Use With: PA2700
Replaces: International 3125199-R1,-R2
O.D.: 5 1/4 (133.4)
Fins: 6 3/8 (161.9)
I.D.: 21/32 (16.7) & 2 3/4 (69.9)
Height: 11 9/32 (286.5)
A. Gskt: [1] Attached
F. Gskt: G103-N

PA2652



Inner Air Element
Fits Inside: PA2651
Fits: Komatsu Equipment
Replaces: Komatsu 600-181-9320
O.D.: 4 1/8 (104.8)
I.D.: 21/32 (16.7) & 3 (76.2)
Height: 11 9/16 (293.7)
A. Gskt: [1] Attached
F. Gskt: G103-N

PA2658



Air Element
Notes: Inside-Out Flow Direction
Fits: GMC Buses, Trucks
Replaces: GMC 25043235
O.D.: 9 1/2 (241.3)
I.D.: 7/16 (11.1) & 6 1/2 (165.1)
Height: 28 7/16 (722.3)
A. Gskt: [2] Attached
F. Gskt: G31-AF

PA2653



Outer Air Element
Fits: Caterpillar Industrial, Marine Engines
Use With: PA2653 FOAM, PA2848
Replaces: Caterpillar 8N6309
O.D.: 19 9/32 (489.7)
I.D.: 12 7/8 (327.0) One End
Height: 10 11/32 (262.7)
A. Gskt: [1] Attached

PA2659



Air Element
Fits: Volvo Buses, Trucks
Replaces: Volvo 6872683, 6872683-5
O.D.: 7 15/16 (201.6)
I.D.: 7/16 (11.1) & 4 5/8 (117.5)
Height: 20 3/8 (517.5)
A. Gskt: [1] Attached
F. Gskt: [1] Included

PA2653 FOAM



Foam Blanket for PA2653
Use With: PA2653
Length: 60 5/16 (1531.9)
Width: 9 1/2 (241.3)
Height: 1/2 (12.7)

Measurements Are Shown In Inches And (Millimeters)

WARNING: These products can expose you to chemicals, including Diisononyl Phthalate, Carbon black extracts, Nickel, 1,3 Butadiene, Ethylene Oxide, Epichlorohydrin, which are known to the State of California to cause cancer, and Bisphenol, Ethylene Glycol, Ethylene Oxide, 1,3 Butadiene, Epichlorohydrin, which are known to the State of California to cause birth defects or other reproductive harm. For more information go to www.P65Warnings.ca.gov.

PA2660



Conical-Shaped Air Element

Fits: Caterpillar, Cummins, Detroit Diesel Engines; Ford, International, Kenworth, Peterbilt Trucks
Replaces: GMC 25096137
O.D.: 7 13/32 (188.1) to 10 13/32 (264.3)
I.D.: 6 15/16 (176.2) One End
Height: 28 1/2 (723.9)
A. Gskt: [1] Attached

PA2665



Inner Air Element

Fits Inside: PA2664
Fits: Komatsu Equipment
Replaces: Komatsu 600-181-2460
O.D.: 5 9/16 (141.3)
I.D.: 5/8 (15.9) & 4 7/32 (107.2)
Height: 10 25/32 (273.8)
A. Gskt: [1] Attached
F. Gskt: G103-N

LL2661



Long Life Air Element

Fits: Volvo Trucks
Replaces: White 22-0013205
O.D.: 12 1/16 (306.4)
I.D.: 7 11/16 (195.3)
Height: 16 (406.4)
A. Gskt: [2] Attached
Related To: PA2661 (Standard Media Version)

PA2666



Outer Air Element with Lift Bar

Notes: Sometimes used as Cab Air.
Fits: John Deere Equipment
Use With: PA2570
Replaces: John Deere AT65296, RE24619
O.D.: 6 7/8 (174.6)
I.D.: 21/32 (16.7) & 3 1/2 (88.9)
Height: 12 13/32 (315.1)
A. Gskt: [1] Attached
F. Gskt: G103-N

PA2661



Air Element

Fits: Volvo Trucks
Replaces: White 22-0013205
O.D.: 12 1/16 (306.4)
I.D.: 7 11/16 (195.3)
Height: 16 (406.4)
A. Gskt: [2] Attached
Related To: LL2661 (Long-Life Media Version)

LL2667



Long Life Outer Air Element

Fits: Komatsu Equipment
Use With: PA2668
Replaces: Komatsu 600-181-2300
O.D.: 9 5/8 (244.5)
I.D.: 21/32 (16.7) & 5 7/32 (132.6)
Height: 15 1/2 (393.7)
A. Gskt: [1] Attached
F. Gskt: G103-N
Related To: PA2667 (Standard Media Version)

PA2662



Outer Air Element

Fits: Case Tractors
Use With: PA2678
Replaces: Case K200379
O.D.: 5 3/16 (131.8)
I.D.: 21/32 (16.7) & 3 7/32 (81.8)
Height: 11 1/2 (292.1)
A. Gskt: [1] Attached
F. Gskt: G103-N

PA2667



Outer Air Element

Fits: Komatsu Equipment
Use With: PA2668
Replaces: Komatsu 600-181-2300
O.D.: 9 5/8 (244.5)
I.D.: 21/32 (16.7) & 5 7/32 (132.6)
Height: 15 1/2 (393.7)
A. Gskt: [1] Attached
F. Gskt: G103-N
Related To: LL2667 (Long-Life Media Version)

PA2663-FN



Air Element with Fins and Lift Tabs

Fits: Grove Equipment
Replaces: Grove 9304100072
O.D.: 13 13/16 (350.8)
 Fins 15 25/32 (400.8)
I.D.: 11/16 (17.5) & 9 1/2 (241.3)
Height: 18 1/2 (469.9)
A. Gskt: [1] Attached
F. Gskt: G103-N

PA2668



Inner Air Element

Fits Inside: LL2667, PA2667
Fits: Komatsu Equipment
Replaces: Komatsu 600-181-2350
O.D.: 5 1/16 (128.6)
I.D.: 21/32 (16.7) & 3 13/16 (96.8)
Height: 13 19/32 (345.3)
A. Gskt: [1] Attached
F. Gskt: G103-N

PA2664



Outer Air Element

Fits: Komatsu Equipment
Use With: PA2665
Replaces: Komatsu 600-181-2450
O.D.: 9 3/4 (247.7)
I.D.: 5/8 (15.9) & 5 5/8 (142.9)
Height: 13 1/16 (331.8)
A. Gskt: [1] Attached
F. Gskt: G103-N

PA2669-FN



Outer Air Element with Fins

Fits: Allis Chalmers, Deutz, Fiat, Hesston Tractors
Use With: PA2670
Replaces: Deutz 4319257; Fiat 1909116
O.D.: 6 3/32 (154.8)
 Fins 7 13/16 (198.4)
I.D.: 3/4 (19.1) & 3 15/32 (88.1)
Height: 13 1/2 (342.9)
A. Gskt: [1] Attached
F. Gskt: G103-N

Measurements Are Shown In Inches And (Millimeters)

WARNING: These products can expose you to chemicals, including Diisononyl Phthalate, Carbon black extracts, Nickel, 1,3 Butadiene, Ethylene Oxide, Epichlorohydrin, which are known to the State of California to cause cancer, and Bisphenol, Ethylene Glycol, Ethylene Oxide, 1,3 Butadiene, Epichlorohydrin, which are known to the State of California to cause birth defects or other reproductive harm. For more information go to www.P65Warnings.ca.gov.

PA2670



Inner Air Element

Fits Inside: PA2669-FN, PA3779-FN, PA3852-FN
Fits: Allis Chalmers, Deutz, Fiat, Hesston, John Deere, New Holland Tractors
Replaces: Deutz 4319256; Fiat 1909117
O.D.: 3 3/8 (85.7)
 Flange 3 25/32 (96.0)
I.D.: 21/32 (16.7) & 2 7/8 (73.0)
Height: 12 1/16 (306.4)
A. Gskt: [1] Attached
F. Gskt: G103-N

PA2672



Inner Air Element

Fits Inside: PA1975
Fits: Case-International, New Holland, Steiger, Versatile Tractors
Replaces: Case 13899; New Holland V63972; Steiger 13-899; Versatile 63972
O.D.: 8 5/8 (219.1)
I.D.: 5/8 (15.9) & 7 1/16 (179.4)
Height: 21 (533.4)
A. Gskt: [1] Attached
F. Gskt: G103-N

PA2673



Outer Air Element with Lift Bar

Fits: Allis Chalmers, Case-International, Steiger Tractors
Use With: PA2674
Replaces: Allis Chalmers 264744
O.D.: 9 7/32 (234.2)
I.D.: 21/32 (16.7) & 5 27/32 (148.4)
Height: 17 1/2 (444.5)
A. Gskt: [1] Attached
F. Gskt: G103-N

PA2674



Inner Air Element

Fits Inside: PA2673
Fits: Allis Chalmers, Case-International, Steiger Tractors
Replaces: Allis Chalmers 264745; Steiger 90-6444T1
O.D.: 5 9/16 (141.3)
I.D.: 5/8 (15.9) & 4 7/16 (112.7)
Height: 15 9/16 (395.3)
A. Gskt: [1] Attached
F. Gskt: G103-N

PA2675



Outer Air Element

Fits: Allis Chalmers, Euclid, Fiat-Allis, Terex, Versatile Equipment
Use With: PA1976
Replaces: Allis Chalmers 686821; Euclid 9038907; Fiat 70686821
O.D.: 13 13/16 (350.8)
 Boot 14 1/2 (368.3)
I.D.: 15/16 (23.8) & 9 1/2 (241.3)
Height: 22 1/2 (571.5)
A. Gskt: [2] Attached
F. Gskt: [1] Included
Related To: PA1975 (without Boot)

LL2676



Long Life Outer Air Element

Fits: Fiat-Hitachi, Hitachi, John Deere, New Holland, Versatile Equipment; Komatsu Dump Trucks; Nissan Trucks
Use With: PA2708, PA3668
Replaces: Hino 17801-2490; John Deere AR95758; New Holland V95611
O.D.: 12 1/8 (308.0)
I.D.: 29/32 (23.0) & 7 11/16 (195.3)
Height: 19 1/2 (495.3)
A. Gskt: [1] Attached
F. Gskt: [1] Included
Related To: PA2676 (Standard Media Version) PA2676XP (Extreme Performance Nano Version)

PA2676



Outer Air Element

Fits: Fiat-Hitachi, Hitachi, John Deere, New Holland, Versatile Equipment; Komatsu Dump Trucks; Nissan Trucks
Use With: PA2708, PA3668
Replaces: Hino 17801-2490; John Deere AR95758; New Holland V95611
O.D.: 12 1/8 (308.0)
I.D.: 29/32 (23.0) & 7 11/16 (195.3)
Height: 19 1/2 (495.3)
A. Gskt: [1] Attached
F. Gskt: [1] Included
Related To: LL2676 (Long-Life Media Version) PA2676XP (Extreme Performance Nano Version)

PA2676XP



Extreme Performance Nano Outer Air Element

Fits: Fiat-Hitachi, Hitachi, John Deere, New Holland, Versatile Equipment; Komatsu Dump Trucks; Nissan Trucks
Use With: PA2708, PA3668
Replaces: Hino 17801-2490; John Deere AR95758; New Holland V95611
O.D.: 12 1/8 (308.0)
I.D.: 29/32 (23.0) & 7 11/16 (195.3)
Height: 19 1/2 (495.3)
A. Gskt: [1] Attached
F. Gskt: [1] Included
Related To: LL2676 (Long-Life Media Version) PA2676 (Standard Performance Nano Version)

PA2677



Conical-Shaped Air Element with Lid

Fits: Mack Trucks
Replaces: Mack 2191P13-8427
O.D.: 8 21/32 (219.9)
 Lid 9 13/16 (249.2)
I.D.: 21/32 (16.7) & 5 3/16 (131.8)
Height: 15 9/16 (395.3)
A. Gskt: [2] Attached
F. Gskt: G103-N, [1] Wing Nut

PA2678



Inner Air Element

Fits Inside: PA2662
Fits: Case Tractors
Replaces: Case K200380
O.D.: 2 15/16 (74.6)
I.D.: 7/16 (11.1) & 1 7/8 (47.6)
Height: 9 31/32 (253.2)
A. Gskt: [1] Attached
F. Gskt: [1] Included

Measurements Are Shown In Inches And (Millimeters)



WARNING: These products can expose you to chemicals, including Diisononyl Phthalate, Carbon black extracts, Nickel, 1,3 Butadiene, Ethylene Oxide, Epichlorohydrin, which are known to the State of California to cause cancer, and Bisphenol, Ethylene Glycol, Ethylene Oxide, 1,3 Butadiene, Epichlorohydrin, which are known to the State of California to cause birth defects or other reproductive harm. For more information go to www.P65Warnings.ca.gov.

PA2679 Air Element with Lid and 6 Bolt Holes
Replaces: Mack 57MD37M
O.D.: 13 7/8 (352.4)
Lid 16 5/32 (410.4)
I.D.: 7 7/16 (188.9) One End
Height: 22 17/32 (572.3)
A. Gskt: [2] Attached



PA2680 Air Element with Lid
Fits: Freightliner, Mack Trucks
Replaces: Mack 57MD42M
O.D.: 10 5/8 (269.9)
Lid 11 11/16 (296.9)
I.D.: 6 11/16 (169.9) One End
Height: 28 13/32 (721.5)
A. Gskt: [1] Attached



PA2684-FN Outer Air Element with Fins
Fits: Case, International Tractors
Use With: PA2689
Replaces: International 3125342-R1, 3125342-R2
O.D.: 6 3/32 (154.8)
Fins 7 13/16 (198.4)
I.D.: 3/4 (19.1) & 3 15/32 (88.1)
Height: 11 1/2 (292.1)
A. Gskt: [1] Attached
F. Gskt: G103-N



LL2685 Long Life Air Element
Fits: Autocar, Volvo, WhiteGMC Trucks
Replaces: White 22-0055039
O.D.: 13 13/16 (350.8)
I.D.: 9 1/2 (241.3) One End
Height: 16 (406.4)
A. Gskt: [1] Attached



PA2687 Inner Air Element
Fits Inside: PA2616, PA2616XP
Fits: John Deere Equipment
Replaces: John Deere AT75036
O.D.: 5 15/16 (150.8)
I.D.: 21/32 (16.7) & 4 27/32 (123.0)
Height: 11 3/8 (288.9)
A. Gskt: [1] Attached
F. Gskt: [1] Included



LL2688 Long Life Outer Air Element
Fits: Case, Caterpillar, Champion, Dresser, Drott, Hitachi, John Deere, Kawasaki, Kobelco, Komatsu, Volvo Equipment; Hino Trucks
Use With: PA2621
Replaces: Case S238646; Caterpillar 9Y6845; Dresser 1249057-H1; Hino 17801-2260; John Deere AT81018; Komatsu 600-181-8270
O.D.: 9 1/8 (231.8)
I.D.: 15/16 (23.8) & 5 13/16 (147.6)
Height: 18 1/2 (469.9)
A. Gskt: [1] Attached
F. Gskt: [1] Included
Related To: PA2688 (Standard Media Version)



PA2688 Outer Air Element
Fits: Case, Caterpillar, Champion, Dresser, Drott, Hitachi, John Deere, Kawasaki, Kobelco, Komatsu, Volvo Equipment; Hino Trucks
Use With: PA2621
Replaces: Case S238646; Caterpillar 9Y6845; Dresser 1249057-H1; Hino 17801-2260; John Deere AT81018; Komatsu 600-181-8270
O.D.: 9 1/8 (231.8)
I.D.: 15/16 (23.8) & 5 13/16 (147.6)
Height: 18 1/2 (469.9)
A. Gskt: [1] Attached
F. Gskt: [1] Included
Related To: LL2688 (Long-Life Media Version)



PA2689 Inner Air Element
Fits Inside: PA2684-FN, PA2970, PA3466-FN, PA3924-FN
Fits: Case, International, J.C. Bamford, John Deere, Massey Ferguson, Zetor Equipment
Replaces: J.C. Bamford 32/903202, 32/906802; Massey Ferguson 1096469-M91
O.D.: 3 3/8 (85.7)
Flange 4 5/32 (105.6)
I.D.: 11/16 (17.5) & 2 29/32 (73.8)
Height: 10 3/32 (256.4)
A. Gskt: [1] Attached
F. Gskt: G103-N



PA2690 Panel Air Element
Fits: Waukesha Engines
Replaces: Waukesha 169180, 169180B, 169180H
Length: 19 7/16 (493.7)
Width: 19 7/16 (493.7)
Height: 5 5/16 (134.9)
A. Gskt: [1] Attached

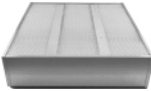

PA2691 Panel Air Element
Fits: Waukesha Engines
Replaces: Waukesha 169180A, 169180C
Length: 25 7/16 (646.1)
Width: 19 7/16 (493.7)
Height: 5 5/8 (142.9)
A. Gskt: [2] Attached



PA2692 Panel Air Element
Fits: Waukesha Engines
Replaces: Waukesha 169180F
Length: 19 1/2 (495.3)
Width: 19 1/2 (495.3)
Height: 2 19/32 (65.9)



Measurements Are Shown In Inches And (Millimeters)

WARNING: These products can expose you to chemicals, including Diisononyl Phthalate, Carbon black extracts, Nickel, 1,3 Butadiene, Ethylene Oxide, Epichlorohydrin, which are known to the State of California to cause cancer, and Bisphenol, Ethylene Glycol, Ethylene Oxide, 1,3 Butadiene, Epichlorohydrin, which are known to the State of California to cause birth defects or other reproductive harm. For more information go to www.P65Warnings.ca.gov.

PA2693

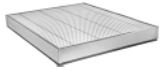

Panel Air Element

Fits: Waukesha Engines
Replaces: Waukesha 169180G
Length: 25 1/2 (647.7)
Width: 19 1/2 (495.3)
Height: 2 5/32 (54.8)
A. Gskt: [1] Attached

PA2694



Tube-Type Air Filter

Contains: 25 Tubes--5 x 5
Fits: Waukesha Engines
Replaces: Waukesha 1691802
Length: 19 7/16 (493.7)
Width: 19 7/16 (493.7)
Height: 8 1/16 (204.8)
A. Gskt: [2] Attached

PA2696

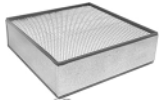

Panel Air Element

Fits: Waukesha Engines
Replaces: Waukesha 569180B
Length: 19 1/2 (495.3)
Width: 19 1/2 (495.3)
Height: 5 11/16 (144.5)
A. Gskt: [2] Attached

PA2698



Air Element

Notes: Inside-Out Flow Direction
Fits: Torit Air Cleaning Systems
Replaces: Torit 8PP18583-01
O.D.: 12 3/4 (323.9)
I.D.: 1 3/16 (30.2) & 8 11/32 (211.9)
Height: 22 1/2 (571.5)
A. Gskt: [1] Attached

PA2699



Air Element

Fits: Ingersoll-Rand Compressors
Replaces: Ingersoll-Rand 39708466
O.D.: 10 27/32 (275.4)
I.D.: 6 1/2 (165.1)
Height: 5 1/32 (127.8)
A. Gskt: [2] Attached

PA2700



Inner Air Element

Fits Inside: PA2391, PA2657-FN, PA2846-FN, PA2976-FN
Fits: Case, Fiat-Allis, International, Massey Ferguson, Zetor Equipment
Replaces: Fiat 700053475; International 3115569-R2; Massey Ferguson 3595519-M1
O.D.: 2 23/32 (69.1)
 Flange 3 21/32 (92.9)
I.D.: 21/32 (16.7) & 2 3/8 (60.3)
Height: 10 3/32 (256.4)
F. Gskt: [1] Included

PA2701



Outer Air Element with Lift Bar

Fits: Massey Ferguson Equipment with Perkins Engines
Use With: PA2702, PA2748
Replaces: Massey Ferguson 1670260-M1
O.D.: 4 5/8 (117.5)
 Boot 5 3/4 (146.1)
I.D.: 9/16 (14.3) & 3 1/32 (77.0)
Height: 9 11/32 (237.3)
A. Gskt: [2] Attached
F. Gskt: [1] Included

PA2702



Inner Air Element

Fits Inside: PA2701
Fits: Massey Ferguson Equipment with Perkins Engines
Replaces: Massey Ferguson 1670261-M1
O.D.: 2 15/16 (74.6)
I.D.: 7/16 (11.1) & 1 7/8 (47.6)
Height: 8 1/4 (209.6)
A. Gskt: [1] Attached
F. Gskt: [1] Included

PA2703



Conical-Shaped Air Element

Fits: Freightliner Trucks
Replaces: Nelson 84831S
O.D.: 7 13/32 (188.1) to 10 13/32 (264.3)
I.D.: 6 15/16 (176.2) One End
Height: 23 (584.2)
A. Gskt: [2] Attached
F. Gskt: G298-AF

PA2704



Air Element with Lid

Fits: Freightliner Trucks
Replaces: Caterpillar 9Y0307; GMC 25096292
O.D.: 10 5/8 (269.9)
 Lid 11 11/16 (296.9)
I.D.: 6 11/16 (169.9) One End
Height: 20 17/32 (521.5)
A. Gskt: [1] Attached

PA2705



Air Element with Lid

Fits: Freightliner, Kenworth, Peterbilt, Western Star Trucks
Replaces: White 22-0055064
O.D.: 10 5/8 (269.9)
 Lid 11 11/16 (296.9)
I.D.: 6 23/32 (170.7) One End
Height: 22 15/32 (570.7)
A. Gskt: [1] Attached

PA2706

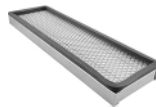

Cab Air Element

Fits: John Deere Equipment
Replaces: John Deere AH92463
Length: 16 7/16 (417.5)
Width: 5 (127.0)
Height: 1 7/16 (36.5)

PA2707



Outer Air Element

Fits: Iveco, Volvo Buses, Trucks
Use With: PA2773
Replaces: Volvo 1542743-8, 1660619-1
O.D.: 12 1/32 (305.6)
I.D.: 17/32 (13.5) & 7 7/8 (200.0)
Height: 14 1/2 (368.3)
A. Gskt: [1] Attached
F. Gskt: [1] Included

Measurements Are Shown In Inches And (Millimeters)



WARNING: These products can expose you to chemicals, including Diisononyl Phthalate, Carbon black extracts, Nickel, 1,3 Butadiene, Ethylene Oxide, Epichlorohydrin, which are known to the State of California to cause cancer, and Bisphenol, Ethylene Glycol, Ethylene Oxide, 1,3 Butadiene, Epichlorohydrin, which are known to the State of California to cause birth defects or other reproductive harm. For more information go to www.P65Warnings.ca.gov.

PA2708



Inner Air Element

Fits Inside: LL2676, PA2676, PA2676XP
Fits: Ford, John Deere, New Holland, Versatile Equipment
Replaces: John Deere AR95759; New Holland V95612
O.D.: 7 5/8 (193.7)
I.D.: 2 1/32 (16.7) & 6 1/16 (154.0)
Height: 18 3/8 (466.7)
A. Gskt: [1] Attached
F. Gskt: G103-N

PA2714



Inner Air Element

Fits Inside: PA2713
Fits: Agco, Case-International, Steiger Equipment
Replaces: Steiger 90-4204T1
O.D.: 7 5/8 (193.7)
I.D.: 2 1/32 (16.7) & 6 1/16 (154.0)
Height: 20 3/8 (517.5)
A. Gskt: [1] Attached

PA2709



Outer Air Element

Fits: John Deere Equipment
Use With: PA2570
Replaces: John Deere AT76215
O.D.: 7 11/32 (186.5)
I.D.: 7/16 (11.1) & 3 31/32 (100.8)
Height: 13 3/8 (339.7)
A. Gskt: [1] Attached
F. Gskt: [1] Included

PA2715



Conical-Shaped Air Element

Fits: Freightliner, Kenworth, Mack Trucks
Replaces: Donaldson P154575
O.D.: 7 13/32 (188.1) to 10 13/32 (264.3)
I.D.: 6 15/16 (176.2) One End
Height: 22 1/2 (571.5)
A. Gskt: [1] Attached

PA2710



Outer Air Element

Fits: Case, David Brown Tractors
Use With: PA2711
Replaces: Case K945043
O.D.: 6 3/32 (154.8)
I.D.: 3/4 (19.1) & 3 25/32 (96.0)
Height: 10 3/4 (273.1)
A. Gskt: [1] Attached
F. Gskt: G103-N

PA2716



Outer Air Element

Fits: John Deere Equipment
Use With: PA2717
Replaces: John Deere AT68183
O.D.: 6 3/32 (154.8)
I.D.: 3/4 (19.1) & 3 15/32 (88.1)
Height: 10 3/8 (263.5)
A. Gskt: [1] Attached
F. Gskt: G103-N

PA2711



Inner Air Element

Fits Inside: PA2710
Fits: Case, David Brown Tractors
Replaces: Case K952344
O.D.: 3 11/16 (93.7)
I.D.: 7/16 (11.1) & 2 9/16 (65.1)
Height: 10 (254.0)
A. Gskt: [1] Attached
F. Gskt: [1] Included

PA2717



Inner Air Element

Fits Inside: PA2716
Fits: John Deere Equipment
Replaces: John Deere AT68184
O.D.: 2 31/32 (75.4)
 Flange 3 5/8 (92.1)
I.D.: 5/8 (15.9) & 2 13/32 (61.1)
Height: 9 3/32 (231.0)
A. Gskt: [1] Attached
F. Gskt: G103-N

PA2712



Air Element

Fits: GMC, Isuzu, Nissan Buses, Trucks; J.C. Bamford, Kubota Equipment
Replaces: GMC 94156052; Isuzu 8-934156-052-0; Kubota 15484-11210; Nissan 16546-T9031
O.D.: 7 15/16 (201.6)
I.D.: 7/8 (22.2) & 5 3/8 (136.5)
Height: 10 1/2 (266.7)
A. Gskt: [1] Attached
F. Gskt: [1] Included

PA2718



Air Element with Lid

Fits: International Trucks
Replaces: International 1651566-C1
O.D.: 8 21/32 (219.9)
 Lid 9 11/16 (246.1)
I.D.: 5 3/16 (131.8) One End
Height: 28 1/2 (723.9)
A. Gskt: [1] Attached

PA2713



Outer Air Element

Fits: Agco, Case-International, Steiger Equipment
Use With: PA2714
Replaces: Steiger 90-4203T1
O.D.: 12 1/32 (305.6)
I.D.: 15/16 (23.8) & 7 11/16 (195.3)
Height: 21 1/2 (546.1)
A. Gskt: [1] Attached

PA2719



Inner Air Element with 8 Bolt Holes

Fits Inside: LL1615, PA1615, PA1615XP
Fits: Caterpillar Equipment
Replaces: Caterpillar 8N4901
O.D.: 4 3/4 (120.7)
 Flange 7 5/16 (185.7)
I.D.: 3 5/8 (92.1) One End
Height: 12 1/32 (305.6)
A. Gskt: [1] Attached

Measurements Are Shown In Inches And (Millimeters)

WARNING: These products can expose you to chemicals, including Diisononyl Phthalate, Carbon black extracts, Nickel, 1,3 Butadiene, Ethylene Oxide, Epichlorohydrin, which are known to the State of California to cause cancer, and Bisphenol, Ethylene Glycol, Ethylene Oxide, 1,3 Butadiene, Epichlorohydrin, which are known to the State of California to cause birth defects or other reproductive harm. For more information go to www.P65Warnings.ca.gov.

PA2721



Replacement for Ecolite Air Element in Disposable Housing
Fits: Farr Optional Filter Housings
Replaces: Farr C62891-1 Series
O.D.: 9 25/32 (248.4)
Inlet: 6
Outlet: 6
Height: 25 7/8 (657.2)

PA2722



Replacement for Ecolite Air Element in Disposable Housing
Fits: Farr Optional Filter Housings
Replaces: Farr C62891-2 Series
O.D.: 11 1/32 (280.2)
Inlet: 7
Outlet: 7
Height: 25 7/8 (657.2)

PA2723



Replacement for Ecolite Air Element in Disposable Housing
Fits: Farr Optional Filter Housings
Replaces: Farr C62891-3 Series
O.D.: 13 17/32 (343.7)
Inlet: 7
Outlet: 7
Height: 25 7/8 (657.2)

PA2724



Replacement for Ecolite Air Element in Disposable Housing
Fits: Farr Optional Filter Housings
Replaces: Farr C71338-3 Series
O.D.: 13 17/32 (343.7)
Inlet: 10 23/32
Outlet: 7
Height: 25 7/8 (657.2)

PA2725



Air Element
Contains: Flame Retardant Media
Fits: Caterpillar Industrial Engines, Lift Trucks
Replaces: Caterpillar 2W4246
O.D.: 6 5/8 (168.3)
I.D.: 4 1/4 (108.0)
Height: 5 7/16 (138.1)
A. Gskt: [2] Attached

PA2726



Air Element
Fits: Ford Buses, Trucks
Replaces: Ford E7HZ-9601-A
O.D.: 7 11/32 (186.5)
I.D.: 7/16 (11.1) & 5 5/16 (134.9)
Height: 23 1/2 (596.9)
A. Gskt: [1] Attached
F. Gskt: [1] Included

PA2727



Outer Air Element with Lift Bar
Fits: Massey Ferguson Equipment
Use With: PA2728
Replaces: Massey Ferguson 1678294-M1
O.D.: 5 3/16 (131.8)
 Boot 5 7/8 (149.2)
I.D.: 7/16 (11.1) & 2 31/32 (75.4)
Height: 12 9/16 (319.1)
A. Gskt: [2] Attached
F. Gskt: [1] Included

PA2728



Inner Air Element
Fits Inside: PA2727
Fits: Massey Ferguson Equipment
Replaces: Massey Ferguson 1678295-M1
O.D.: 2 15/16 (74.6)
I.D.: 7/16 (11.1) & 1 7/8 (47.6)
Height: 11 9/16 (293.7)
A. Gskt: [1] Attached
F. Gskt: [1] Included

PA2729



Conical-Shaped Air Element
Fits: Peterbilt Trucks
Replaces: Donaldson P521598
O.D.: 9 25/32 (248.4) to 11 7/8 (301.6)
I.D.: 7 3/8 (187.3) One End
Height: 25 (635.0)
A. Gskt: [2] Attached
F. Gskt: G501-A
 F

PA2730



Inner Air Element with 6 Bolt Holes
Fits Inside: LL2575, PA2575
Fits: Caterpillar Equipment
Replaces: Caterpillar 7W3754
O.D.: 3 15/16 (100.0)
 Flange 6 11/16 (169.9)
I.D.: 2 11/32 (59.5) One End
Height: 5 13/32 (137.3)
A. Gskt: [1] Attached

PA2731



Replacement for Ecolite Air Element in Disposable Housing
Contains: Bleed Valve
Fits: Kenworth Trucks
Replaces: Farr C78897-1 Series
O.D.: 13 17/32 (343.7)
Inlet: 6 29/32
Outlet: 7
Height: 25 17/32 (648.5)

PA2732



Conical-Shaped Air Element
Notes: Inside-Out Flow Direction
Fits: Freightliner, Peterbilt Trucks
Replaces: Donaldson P522293
O.D.: 7 13/32 (188.1) to 10 13/32 (264.3)
I.D.: 6 15/16 (176.2) One End
Height: 29 (736.6)
A. Gskt: [2] Included
F. Gskt: G348-AF

Measurements Are Shown In Inches And (Millimeters)

! **WARNING:** These products can expose you to chemicals, including Diisononyl Phthalate, Carbon black extracts, Nickel, 1,3 Butadiene, Ethylene Oxide, Epichlorohydrin, which are known to the State of California to cause cancer, and Bisphenol, Ethylene Glycol, Ethylene Oxide, 1,3 Butadiene, Epichlorohydrin, which are known to the State of California to cause birth defects or other reproductive harm. For more information go to www.P65Warnings.ca.gov.

PA2733



Inner Air Element with 8 Bolt Holes
Fits Inside: LL1669, PA1669
Fits: Caterpillar Equipment
Replaces: Caterpillar 8N6883
O.D.: 6 1/4 (158.8)
 Flange 9 1/16 (230.2)
I.D.: 4 5/8 (117.5) One End
Height: 16 7/32 (412.0)
A. Gskt: [1] Attached

PA2739



Inner Air Element
Fits Inside: LL1669, PA1669
Fits: Caterpillar Applications Converted from Flanged Air Systems Previously Using PA1670 or PA2733
O.D.: 6 1/4 (158.8)
I.D.: 29/32 (23.0) & 4 5/8 (117.5)
Height: 14 1/2 (368.3)
A. Gskt: [1] Attached
F. Gskt: [1] Included

PA2734



Air Element with 6 Bolt Holes
Replaces: Donaldson P181185
O.D.: 13 13/16 (350.8)
 Lid 16 5/32 (410.4)
I.D.: 9 1/2 (241.3) One End
Height: 21 17/32 (546.9)
A. Gskt: [2] Attached

PA2740



Cab Air Element
Fits: Caterpillar Equipment
Replaces: Caterpillar 9G1518
O.D.: 6 7/8 (174.6)
I.D.: 21/32 (16.7) & 4 3/16 (106.4)
Height: 9 1/2 (241.3)
A. Gskt: [1] Attached
F. Gskt: [1] Wing Nut

PA2735



Inner Air Element
Fits Inside: LL2384, PA2384, PA2384XP
Fits: Caterpillar Applications Converted from Flanged Air Systems Previously Using PA2647
O.D.: 8 5/8 (219.1)
I.D.: 15/16 (23.8) & 7 1/16 (179.4)
Height: 11 1/2 (292.1)
A. Gskt: [1] Attached
F. Gskt: [1] Included

PA2742



Outer Air Element with Bail Handle
Fits: American Grape Harvester Equipment; Atlas Copco Generators
Use With: PA2743
Replaces: Air Maze CD1219610-826
O.D.: 10 (254.0)
I.D.: 3/8 (9.5) & 5 7/8 (149.2)
Height: 17 19/32 (446.9)
A. Gskt: [1] Attached
F. Gskt: [1] Included

PA2736



Inner Air Element
Fits Inside: LL1615, PA1615, PA1615XP
Fits: Caterpillar Applications Converted from Flanged Air Systems Previously Using PA1647 or PA2719
O.D.: 4 3/4 (120.7)
I.D.: 29/32 (23.0) & 3 5/8 (92.1)
Height: 11 1/2 (292.1)
A. Gskt: [1] Attached
F. Gskt: [1] Included

PA2743



Inner Air Element
Fits Inside: PA2742
Fits: American Grape Harvester Equipment; Atlas Copco Generators
Replaces: Air Maze CD1219610-830
O.D.: 5 11/16 (144.5)
I.D.: 5/8 (15.9) & 4 15/16 (125.4)
Height: 15 9/16 (395.3)
A. Gskt: [1] Attached
F. Gskt: [1] Washer

PA2737



Inner Air Element
Fits Inside: LL1634, PA1634, PA1634XP
Fits: Caterpillar Applications Converted from Flanged Air Systems Previously Using PA1675 or PA2310
O.D.: 6 1/4 (158.8)
I.D.: 29/32 (23.0) & 4 5/8 (117.5)
Height: 12 3/8 (314.3)
A. Gskt: [1] Attached
F. Gskt: [1] Included

PA2744



Outer Air Element with Lift Tab
Use With: PA2745
Replaces: Air Maze CD1628610-826
O.D.: 12 1/2 (317.5)
I.D.: 13/32 (10.3) & 7 1/2 (190.5)
Height: 27 1/16 (687.4)
A. Gskt: [1] Attached
F. Gskt: [1] Included

PA2738



Inner Air Element
Fits Inside: PA1818, LL2358, PA2358
Fits: Caterpillar Applications Converted from Flanged Air Systems Previously Using PA1819 or PA2359
O.D.: 7 5/8 (193.7)
I.D.: 7/8 (22.2) & 6 1/16 (154.0)
Height: 12 1/2 (317.5)
A. Gskt: [1] Attached
F. Gskt: [1] Included

PA2745



Inner Air Element
Fits Inside: PA2744
Replaces: Air Maze CD1628610-827
O.D.: 7 3/8 (187.3)
I.D.: 25/32 (19.8) & 6 1/8 (155.6)
Height: 25 3/4 (654.1)
F. Gskt: G103-N

Measurements Are Shown In Inches And (Millimeters)

WARNING: These products can expose you to chemicals, including Diisononyl Phthalate, Carbon black extracts, Nickel, 1,3 Butadiene, Ethylene Oxide, Epichlorohydrin, which are known to the State of California to cause cancer, and Bisphenol, Ethylene Glycol, Ethylene Oxide, 1,3 Butadiene, Epichlorohydrin, which are known to the State of California to cause birth defects or other reproductive harm. For more information go to www.P65Warnings.ca.gov.

PA2746



Outer Air Element with Lift Tab
Use With: PA2747
Replaces: Air Maze CD1830610-826
O.D.: 13 7/8 (352.4)
I.D.: 17/32 (13.5) & 10 (254.0)
Height: 29 1/2 (749.3)
F. Gskt: [1] Included

PA2752



Cab Air Element
Fits: John Deere Equipment
Replaces: John Deere AT73529
Length: 29 1/2 (749.3)
Width: 5 (127.0)
Height: 2 9/16 (65.1)

PA2747



Inner Air Element
Fits Inside: PA2746
Replaces: Air Maze CD1830610-827
O.D.: 9 29/32 (251.6)
I.D.: 17/32 (13.5) & 8 1/16 (204.8)
Height: 28 1/4 (717.6)
F. Gskt: [1] Included

PA2753

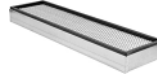

Cab Air Element
Fits: Allis Chalmers Tractors
Replaces: Allis Chalmers 1504385
Length: 26 (660.4)
Width: 7 (177.8)
Height: 2 9/16 (65.1)

PA2754



Air Element with Lift Bar
Fits: Sullair Compressors
Replaces: Sullair 250022-888
O.D.: 6 11/16 (169.9)
I.D.: 1/2 (12.7) & 3 3/4 (95.3)
Height: 11 11/32 (288.1)
A. Gskt: [1] Attached
F. Gskt: [1] Included

PA2748



Inner Air Element
Fits Inside: PA2701
Fits: Massey Ferguson Wheel Tractors
Replaces: Massey Ferguson 1688093-M1
O.D.: 2 29/32 (73.8)
I.D.: 15/32 (11.9) & 2 3/8 (60.3)
Height: 8 1/8 (206.4)
A. Gskt: [1] Attached
End Seals: [1] Included

PA2755



Air Element
Fits: Mack Trucks
Replaces: Mack 57MD44M
O.D.: 8 27/32 (224.6)
I.D.: 5 13/16 (147.6)
Height: 28 1/2 (723.9)
A. Gskt: [1] Attached

PA2749



Outer Air Element with Bail Handle
Fits: Caterpillar Equipment
Use With: PA1905
Replaces: Caterpillar 4W5716
O.D.: 13 13/16 (350.8)
 Boot 14 1/2 (368.3)
I.D.: 15/16 (23.8) & 9 1/2 (241.3)
Height: 18 1/2 (469.9)
A. Gskt: G285-AF, [1] Attached
F. Gskt: [1] Included
Related To: LL1894 , PA1894 (without Boot and Bail Handle)
 PA1894XP (Extreme Performance Nano Version)

PA2756



Conical-Shaped Air Element
Fits: Blue Bird Buses; Ford Trucks
Replaces: Blue Bird 4280574; Ford 81DB-9601-JB; Nelson 70469N
O.D.: 5 15/16 (150.8) to 7 (177.8)
I.D.: 21/32 (16.7) & 3 5/8 (92.1)
Height: 15 1/2 (393.7)
A. Gskt: [1] Attached
F. Gskt: G103-N

PA2750



Conical-Shaped Air Element
Fits: Blue Bird Buses; ERF, Leyland Trucks
Replaces: Leyland BBU8383; Nelson 70470N
O.D.: 7 3/16 (182.6) to 8 1/4 (209.6)
I.D.: 21/32 (16.7) & 4 23/32 (119.9)
Height: 18 1/2 (469.9)
F. Gskt: G103-N

PA2757



Air Element
Fits: Volvo Trucks
Replaces: Volvo 1660375-5
O.D.: 10 5/8 (269.9)
I.D.: 7/16 (11.1) & 6 1/4 (158.8)
Height: 22 11/16 (576.3)
A. Gskt: [1] Attached
F. Gskt: [1] Included

PA2751



Conical-Shaped Air Element
Fits: Blue Bird Buses; Bedford, ERF, Foden, Leyland Trucks
Replaces: Leyland BBU2734
O.D.: 7 15/16 (201.6) to 9 27/32 (250.0)
I.D.: 11/16 (17.5) & 6 1/4 (158.8)
Height: 19 1/2 (495.3)
A. Gskt: [1] Included
F. Gskt: G103-N

PA2759



Air Element
Fits: Bedford Trucks
Replaces: Chrysler 75062482; GMC 7972953; Leyland ABU8526
O.D.: 7 23/32 (196.1)
I.D.: 11/16 (17.5) & 5 3/32 (129.4)
Height: 14 7/16 (366.7)
A. Gskt: [1] Attached

Measurements Are Shown In Inches And (Millimeters)

! WARNING: These products can expose you to chemicals, including Diisononyl Phthalate, Carbon black extracts, Nickel, 1,3 Butadiene, Ethylene Oxide, Epichlorohydrin, which are known to the State of California to cause cancer, and Bisphenol, Ethylene Glycol, Ethylene Oxide, 1,3 Butadiene, Epichlorohydrin, which are known to the State of California to cause birth defects or other reproductive harm. For more information go to www.P65Warnings.ca.gov.

PA2761 Air Element with Lid
Fits: GMC, Isuzu, Mitsubishi Trucks
Replaces: GMC 94430250; Isuzu 8-94430-250-0; Mitsubishi ME033717
O.D.: 8 11/16 (220.7)
 Lid 10 3/8 (263.5)
I.D.: 7/8 (22.2) & 5 11/32 (135.7)
Height: 13 1/2 (342.9)
A. Gskt: [2] Attached
F. Gskt: [1] Included



PA2763 Air Element
Replaces: Leyland 10621312
O.D.: 8 1/8 (206.4)
I.D.: 3 25/32 (96.0)
Height: 7 1/8 (181.0)



PA2767 Outer Air Element
Fits: Claas, Fendt, International, John Deere, Kobelco, Liebherr Equipment; Iveco Trucks
Use With: PA3686
Replaces: Iveco 1904581; John Deere AZ18968; Leyland BBU6549; Nelson 70604S
O.D.: 5 7/8 (149.2)
I.D.: 7/16 (11.1) & 2 13/16 (71.4)
Height: 13 1/4 (336.6)
A. Gskt: [1] Attached



PA2771 Replacement for Ecolite Air Element in Disposable Housing
Fits: Akerman Excavators; Volvo Engines, Equipment
Replaces: Volvo 823701
O.D.: 7 3/4 (196.9)
I.D.: 4 (101.6) One End
Height: 28 3/16 (716.0)



PA2772 Outer Air Element
Fits: 1993-96 Volkswagen Eurovan; Bomag, Demag, Fendt Equipment; Sullair Compressors
Use With: PA3684
Replaces: Demag 29504476; Fendt 5821301; Volkswagen 44129620A
O.D.: 6 15/32 (164.3)
I.D.: 3 11/32 (84.9) One End
Height: 9 3/8 (238.1)
A. Gskt: [1] Attached



PA2773 Inner Air Element
Fits Inside: PA2707
Fits: Volvo Trucks
Replaces: Volvo 1544298
O.D.: 7 25/32 (197.6)
I.D.: 13/32 (10.3) & 6 15/16 (176.2)
Height: 12 5/8 (320.7)
A. Gskt: [1] Attached
F. Gskt: G15-AF



PA2774 Outer Air Element
Fits: Volvo Buses, Trucks
Use With: PA2775
Replaces: Volvo 1544449
O.D.: 13 13/16 (350.8)
I.D.: 5/8 (15.9) & 8 9/32 (210.3)
Height: 14 1/2 (368.3)
A. Gskt: [1] Attached
F. Gskt: [1] Included



PA2775 Inner Air Element
Fits Inside: PA2774
Fits: Volvo Buses, Trucks
Replaces: Volvo 1660903
O.D.: 7 13/16 (198.4)
I.D.: 7/16 (11.1) & 6 17/32 (165.9)
Height: 12 5/8 (320.7)
A. Gskt: [1] Attached
F. Gskt: [1] Included



PA2776 Outer Air Element
Fits: Claas, Liebherr, V.M.E., Volvo Equipment; Iveco, M.A.N., Mercedes-Benz Trucks
Use With: PA3494, PA3857
Replaces: Claas 709050; Iveco 1902129; Liebherr 5106191; M.A.N. 81.08304.0044; Mercedes-Benz 90940502; Volvo 11033128
O.D.: 11 15/16 (303.2)
I.D.: 13/32 (10.3) & 7 17/32 (191.3)
Height: 18 21/32 (473.9)
A. Gskt: [1] Attached
F. Gskt: [1] Included



PA2777 Outer Air Element
Fits: Case, International Tractors; Cummins Engines
Use With: PA2539
Replaces: Case A171255
O.D.: 9 29/32 (251.6)
I.D.: 11/16 (17.5) & 6 1/16 (154.0)
Height: 16 1/2 (419.1)
A. Gskt: [1] Attached
F. Gskt: G103-N



PA2778-FN Air Element with Fins
Contains: Flame Retardant Media
Fits: Komatsu Equipment; Nissan Lift Trucks
Replaces: Nissan 16546-00H10
O.D.: 4 3/32 (104.0)
 Fins 5 1/8 (130.2)
I.D.: 25/32 (19.8) & 2 15/32 (62.7)
Height: 7 23/32 (196.1)
A. Gskt: [1] Attached
F. Gskt: G103-N



LL2779 Long Life Outer Air Element
Fits: Caterpillar, Link-Belt Equipment; GMC, Hino, Isuzu, Nissan Buses, Trucks
Use With: PA2545
Replaces: Hino 17801-2280; Isuzu 1-14215-172-0; Nissan 16546-Z9004
O.D.: 9 1/8 (231.8)
I.D.: 15/16 (23.8) & 5 13/16 (147.6)
Height: 13 1/2 (342.9)
A. Gskt: [1] Attached
F. Gskt: [1] Included
Related To: PA2779 (Standard Media Version)



Measurements Are Shown In Inches And (Millimeters)

WARNING: These products can expose you to chemicals, including Diisononyl Phthalate, Carbon black extracts, Nickel, 1,3 Butadiene, Ethylene Oxide, Epichlorohydrin, which are known to the State of California to cause cancer, and Bisphenol, Ethylene Glycol, Ethylene Oxide, 1,3 Butadiene, Epichlorohydrin, which are known to the State of California to cause birth defects or other reproductive harm. For more information go to www.P65Warnings.ca.gov.

PA2779



Outer Air Element

Fits: Caterpillar, Link-Belt Equipment; GMC, Hino, Isuzu, Nissan Buses, Trucks
Use With: PA2545
Replaces: Hino 17801-2280; Isuzu 1-14215-172-0; Nissan 16546-Z9004
O.D.: 9 1/8 (231.8)
I.D.: 15/16 (23.8) & 5 13/16 (147.6)
Height: 13 1/2 (342.9)
A. Gskt: [1] Attached
F. Gskt: [1] Included
Related To: LL2779 (Long-Life Media Version)

PA2785



Air Element with Lid

Fits: Volvo Trucks
Replaces: Volvo 6792554
O.D.: 7 3/8 (187.3)
 Lid 8 1/8 (206.4)
I.D.: 13/32 (10.3) & 4 11/16 (119.1)
Height: 23 1/4 (590.6)
A. Gskt: [2] Attached
F. Gskt: [1] Included

PA2781



Outer Air Element

Fits: Caterpillar Equipment
Use With: PA2782, PA3551
Replaces: Caterpillar 7W9853
O.D.: 14 1/4 (362.0)
I.D.: 9 29/32 (251.6) One End
Height: 18 21/32 (473.9)
A. Gskt: [1] Attached

PA2786



Outer Air Element

Fits: Volvo Trucks
Use With: PA2787
Replaces: Volvo 1660600
O.D.: 10 3/16 (258.8)
I.D.: 13/32 (10.3) & 6 5/16 (160.3)
Height: 21 3/8 (542.9)
A. Gskt: [1] Attached
F. Gskt: [1] Included

PA2782



Inner Air Element with 12 Bolt Holes

Fits Inside: PA2781
Fits: Caterpillar Equipment
Replaces: Caterpillar 7W9567
O.D.: 9 13/16 (249.2)
 Flange 12 3/32 (307.2)
I.D.: 8 1/8 (206.4) One End
Height: 18 3/32 (459.6)
A. Gskt: [1] Attached

PA2787



Inner Air Element

Fits Inside: PA2786
Fits: Volvo Trucks
Replaces: Volvo 1660601, 1665886
O.D.: 6 1/8 (155.6)
I.D.: 13/32 (10.3) & 4 15/16 (125.4)
Height: 20 1/2 (520.7)
A. Gskt: [1] Attached
F. Gskt: [1] Included

PA2783



Air Element

Fits: Caterpillar, Fiat-Allis, Hanomag, Liebherr, Trojan Equipment; R.V.I. Buses
Replaces: Caterpillar 7E0973; Fiat 79042202; Hanomag 3074304-M1; Liebherr 7401179
O.D.: 7 5/8 (193.7)
I.D.: 5/8 (15.9) & 4 1/4 (108.0)
Height: 16 1/2 (419.1)
A. Gskt: [1] Attached
F. Gskt: G103-N
Related To: LL2783 (Long-Life Media Version)

PA2788



Outer Air Element with Lid

Fits: Case, Daewoo, Hitachi, Kobelco, Komatsu, MDI/Yutani Equipment
Use With: PA1911
Replaces: Case 161863A1; Hitachi 4129907; Kobelco 2447U242S2; Komatsu 600-181-6540
O.D.: 7 3/8 (187.3)
 Lid 9 9/32 (235.7)
I.D.: 21/32 (16.7) & 4 11/16 (119.1)
Height: 15 1/2 (393.7)
A. Gskt: [2] Attached
F. Gskt: G103-N

PA2784



Outer Air Element with Lid

Fits: Daewoo, Kawasaki, Kobelco, Komatsu Equipment; Hino, Mitsubishi Trucks
Use With: PA3578
Replaces: Hino 17801-2800; Kawasaki 30980-70070; Kobelco 2446R312S2; Komatsu 600-181-6820; Mitsubishi ME033603
O.D.: 8 11/16 (220.7)
 Lid 10 3/8 (263.5)
I.D.: 7/8 (22.2) & 5 11/32 (135.7)
Height: 17 29/32 (454.8)
A. Gskt: [2] Attached
F. Gskt: [1] Included

PA2789



Air Element

Fits: Ford Trucks
Replaces: Ford E8HZ-9601-A
O.D.: 13 7/8 (352.4)
I.D.: 11/16 (17.5) & 7 7/16 (188.9)
Height: 7 1/2 (190.5)
A. Gskt: [1] Attached
F. Gskt: G103-N

PA2790-FN



Outer Air Element with Fins and Lid

Fits: J.C. Bamford Equipment
Use With: PA2791
Replaces: J.C. Bamford 32/206002
O.D.: 5 1/4 (133.4)
 Lid 6 1/2 (165.1)
I.D.: 21/32 (16.7) & 2 27/32 (72.2)
Height: 14 1/16 (357.2)
A. Gskt: [1] Attached
F. Gskt: [1] Included, [1] Wing Nut

Measurements Are Shown In Inches And (Millimeters)

WARNING: These products can expose you to chemicals, including Diisononyl Phthalate, Carbon black extracts, Nickel, 1,3 Butadiene, Ethylene Oxide, Epichlorohydrin, which are known to the State of California to cause cancer, and Bisphenol, Ethylene Glycol, Ethylene Oxide, 1,3 Butadiene, Epichlorohydrin, which are known to the State of California to cause birth defects or other reproductive harm. For more information go to www.P65Warnings.ca.gov.

PA2791

Inner Air Element



Fits Inside: PA2790-FN, PA3859
Fits: Case, J.C. Bamford, New Holland Equipment
Replaces: J.C. Bamford 32/206003
O.D.: 2 23/32 (69.1)
 Flange Gasket 3 21/32 (92.9)
I.D.: 21/32 (16.7) & 2 3/8 (60.3)
Height: 12 1/32 (305.6)
A. Gskt: [1] Attached
F. Gskt: [1] Washer
End Seals: [1] Included

PA2798

Air Breather Element



Contains: Clamp
Fits: V.M.E., Volvo Equipment, Trucks
Replaces: Volvo 1586882-1
O.D.: 3 15/32 (88.1)
I.D.: 31/32 (24.6) One End
Height: 3 15/32 (88.1)
Grommets: [1] Attached
Related To: PA5700 (with Check Valve)

PA2792

Outer Air Element



Fits: Allis Chalmers, Demag, Eicher, Fendt, Fiat, International Equipment
Use With: PA3687
Replaces: Allis Chalmers 99100059; Demag 99054; Eicher 1871933-M91; Fendt X810270073; Fiat 9293140; International 3146927-R91
O.D.: 5 (127.0)
I.D.: 11/32 (8.7) & 2 9/16 (65.1)
Height: 11 17/32 (292.9)
A. Gskt: [1] Attached
F. Gskt: G39-AF

PA2799

Air Element



Notes: Inside-Out Flow Direction
Fits: Torit Air Cleaning Systems
Replaces: Torit 8PP22269-00
O.D.: 12 3/4 (323.9)
I.D.: 8 11/32 (211.9)
Height: 26 1/2 (673.1)
A. Gskt: [1] Included

PA2793

Outer Air Element with Lift Tab



Fits: Massey Ferguson Wheel Tractors
Use With: PA2794
Replaces: Massey Ferguson 1055534-M91
O.D.: 8 1/2 (215.9)
I.D.: 7/16 (11.1) & 5 3/8 (136.5)
Height: 12 3/4 (323.9)
A. Gskt: [1] Attached
F. Gskt: [1] Included

PA2800-FN

Air Element with Fins



Replaces: Multiparts BAU1475
O.D.: 5 1/4 (133.4)
 Fins 6 13/32 (162.7)
I.D.: 21/32 (16.7) & 2 25/32 (70.6)
Height: 18 1/4 (463.6)
A. Gskt: [1] Attached
F. Gskt: [2] Included

PA2794

Inner Air Element



Fits Inside: PA2793
Fits: Massey Ferguson Wheel Tractors
Replaces: Massey Ferguson 1055533-M91
O.D.: 5 1/4 (133.4)
I.D.: 5/8 (15.9) & 4 1/8 (104.8)
Height: 11 5/16 (287.3)
A. Gskt: [1] Attached
F. Gskt: G103-N

PA2801

Air Element with Lid



Fits: Scania Trucks
Replaces: Saab-Scania 370754
O.D.: 11 7/8 (301.6)
 Lid 15 1/32 (381.8)
I.D.: 13/32 (10.3) & 9 9/16 (242.9)
Height: 18 3/4 (476.3)
A. Gskt: [2] Attached

PA2796

Air Element



Fits: Pneumafil Dust Collectors
Replaces: Pneumafil A37536B-2
O.D.: 12 3/4 (323.9)
I.D.: 3/4 (19.1) & 8 3/8 (212.7)
Height: 29 3/4 (755.7)
A. Gskt: [1] Attached

PA2803

Replacement for Ecolite Air Element in Disposable Housing



Fits: Carrier-Transcold Refrigeration Units
Replaces: Carrier 30-01077-01
O.D.: 6 5/8 (168.3)
I.D.: 2 (50.8) One End
Height: 10 11/32 (262.7)

PA2797

Outer Air Element



Fits: Volvo Trucks
Use With: PA4627
Replaces: Volvo V1115700
O.D.: 12 3/4 (323.9)
I.D.: 8 11/32 (211.9) One End
Height: 16 21/32 (423.1)
A. Gskt: [2] Attached

PA2804

Replacement for Ecolite Air Element in Disposable Housing



Fits: Thermo King Refrigeration Units
Replaces: Thermo King 11-5978, 11-7400
O.D.: 6 5/8 (168.3)
I.D.: 1 13/32 (35.7) One End
Height: 11 11/32 (288.1)

Measurements Are Shown In Inches And (Millimeters)

WARNING: These products can expose you to chemicals, including Diisononyl Phthalate, Carbon black extracts, Nickel, 1,3 Butadiene, Ethylene Oxide, Epichlorohydrin, which are known to the State of California to cause cancer, and Bisphenol, Ethylene Glycol, Ethylene Oxide, 1,3 Butadiene, Epichlorohydrin, which are known to the State of California to cause birth defects or other reproductive harm. For more information go to www.P65Warnings.ca.gov.

PA2805



Replacement for Ecolite Air Element in Disposable Housing
Fits: LeRoi Compressors; Ditch Witch, Volvo, Wacker Equipment
Replaces: LeRoi 43-867-2
O.D.: 8 9/16 (217.5)
I.D.: 2 31/32 (75.4) One End
Height: 10 13/16 (274.6)

PA2815



Air Element
Replaces: Cummins 3905326; Ingersoll-Rand 39824115; Onan 140-2660
O.D.: 8 1/2 (215.9)
I.D.: 3 (76.2) One End
Height: 12 3/8 (314.3)
Related To: PA3868 (with Flame Retardant Media)

PA2806



Replacement for Ecolite Air Element in Disposable Housing
Fits: Godwin Pumps
Replaces: Donaldson C105004
O.D.: 10 9/16 (268.3)
I.D.: 4 1/4 (108.0) One End
Height: 11 13/16 (300.0)

PA2816



Replacement for Ecolite Air Element in Disposable Housing
Replaces: Donaldson ECB085008
O.D.: 8 9/16 (217.5)
Inlet: 3 15/32
Outlet: 4 11/32
Height: 9 27/32 (250.0)

PA2807



Replacement for Ecolite Air Element in Disposable Housing
Replaces: Gehl 77628; John Deere AM100258
O.D.: 5 1/2 (139.7)
I.D.: 1 3/4 (44.5) One End
Height: 8 3/8 (212.7)

PA2817



Air Element
Replaces: Donaldson ECB085009
O.D.: 8 1/2 (215.9)
I.D.: 3 (76.2) One End
Height: 4 3/8 (111.1)

PA2812



Air Element with Lid
Fits: Mercedes-Benz Buses, Trucks
Replaces: Mercedes-Benz 10949304
O.D.: 10 7/8 (276.2)
 Lid 13 5/16 (338.1)
I.D.: 13/32 (10.3) & 5 1/4 (133.4)
Height: 10 (254.0)
A. Gskt: [2] Attached

PA2818



Air Element
Replaces: Donaldson ECB085011
O.D.: 8 1/2 (215.9)
I.D.: 4 (101.6) One End
Height: 12 3/8 (314.3)

PA2813



Outer Air Element
Fits: DAF, Iveco, M.A.N., Scania Buses, Trucks
Use With: PA4809
Replaces: DAF 667078; Iveco 8122408
O.D.: 11 29/32 (302.4)
I.D.: 13/32 (10.3) & 7 17/32 (191.3)
Height: 14 7/8 (377.8)
A. Gskt: [1] Attached
F. Gskt: [1] Included

PA2819



Replacement for Ecolite Air Element in Disposable Housing
Replaces: Donaldson ECB105003
O.D.: 10 9/16 (268.3)
Inlet: 4 15/32
Outlet: 4
Height: 11 13/16 (300.0)

PA2814



Inner Air Element
Fits Inside: PA2475
Fits: DAF, Iveco, M.A.N., R.V.I., Volvo Buses, Trucks; Claas, Demag, Fendt, Liebherr, New Holland, V.M.E. Equipment
Replaces: DAF 691280; Demag 988765; Iveco 1909132; New Holland 430287; Volvo 4785749, 4785749-5
O.D.: 5 1/8 (130.2)
 Boot Gasket 5 9/16 (141.3)
I.D.: 11/16 (17.5) & 4 11/16 (119.1)
Height: 18 5/8 (473.1)
A. Gskt: [1] Attached
F. Gskt: [1] Included

PA2820



Air Element
Replaces: Donaldson ECB105006
O.D.: 10 1/2 (266.7)
I.D.: 4 (101.6) One End
Height: 11 7/8 (301.6)

Measurements Are Shown In Inches And (Millimeters)

WARNING: These products can expose you to chemicals, including Diisononyl Phthalate, Carbon black extracts, Nickel, 1,3 Butadiene, Ethylene Oxide, Epichlorohydrin, which are known to the State of California to cause cancer, and Bisphenol, Ethylene Glycol, Ethylene Oxide, 1,3 Butadiene, Epichlorohydrin, which are known to the State of California to cause birth defects or other reproductive harm. For more information go to www.P65Warnings.ca.gov.

PA2821 Air Element
Replaces: Donaldson ECB125003
O.D.: 12 1/2 (317.5)
I.D.: 6 (152.4) One End
Height: 16 3/8 (415.9)



PA2827 Replacement for Ecolite Air Element in Disposable Housing
Fits: Godwin Pumps
Replaces: Cummins 3910946; Lister 3043
O.D.: 8 9/16 (217.5)
I.D.: 3 1/4 (82.6) One End
Height: 6 5/16 (160.3)



PA2822 Replacement for Ecolite Air Element in Disposable Housing
Fits: Gehl Loaders
Replaces: Gehl 75986, 79388
O.D.: 5 1/2 (139.7)
I.D.: 1 3/4 (44.5) One End
Height: 8 3/8 (212.7)



PA2828 Replacement for Ecolite Air Element in Disposable Housing
Replaces: Donaldson C085005
O.D.: 8 19/32 (218.3)
I.D.: 2 1/2 (63.5) One End
Height: 6 3/8 (161.9)



PA2823 Replacement for Ecolite Air Element in Disposable Housing
Replaces: Jacobsen 330811
O.D.: 6 5/8 (168.3)
I.D.: 2 (50.8) One End
Height: 5 11/32 (135.7)



PA2829 Replacement for Ecolite Air Element in Disposable Housing
Replaces: Isuzu X14210-031; LeRoi 43-867-1
O.D.: 8 9/16 (217.5)
I.D.: 2 1/2 (63.5) One End
Height: 10 13/16 (274.6)



PA2824 Replacement for Ecolite Air Element in Disposable Housing
Fits: Godwin Pumps; Isuzu Engines
Replaces: Donaldson C065002
O.D.: 6 5/8 (168.3)
I.D.: 2 (50.8) One End
Height: 8 27/32 (224.6)



PA2830 Replacement for Ecolite Air Element in Disposable Housing
Fits: Godwin Pumps
Replaces: LeRoi 438673
O.D.: 10 9/16 (268.3)
I.D.: 4 1/4 (108.0) One End
Height: 7 5/16 (185.7)



PA2825 Replacement for Ecolite Air Element in Disposable Housing
Fits: Northern Lights Generators
Replaces: Broderson 60012047
O.D.: 8 9/16 (217.5)
I.D.: 2 1/2 (63.5) One End
Height: 5 5/16 (134.9)



PA2831 Replacement for Ecolite Air Element in Disposable Housing
Fits: Godwin Pumps
Replaces: Fiat 73253513
O.D.: 12 9/16 (319.1)
I.D.: 5 (127.0) One End
Height: 12 5/16 (312.7)



PA2826 Replacement for Ecolite Air Element in Disposable Housing
Fits: Godwin Pumps; Isuzu, John Deere Industrial Engines
Replaces: Donaldson C085002
O.D.: 8 9/16 (217.5)
I.D.: 2 1/2 (63.5) One End
Height: 7 13/16 (198.4)



PA2832 Replacement for Ecolite Air Element in Disposable Housing
Replaces: Ingersoll-Rand 8524575; Thermo King 11-6488
O.D.: 4 1/2 (114.3)
I.D.: 1 1/2 (38.1) One End
Height: 5 7/8 (149.2)



Measurements Are Shown In Inches And (Millimeters)

WARNING: These products can expose you to chemicals, including Diisononyl Phthalate, Carbon black extracts, Nickel, 1,3 Butadiene, Ethylene Oxide, Epichlorohydrin, which are known to the State of California to cause cancer, and Bisphenol, Ethylene Glycol, Ethylene Oxide, 1,3 Butadiene, Epichlorohydrin, which are known to the State of California to cause birth defects or other reproductive harm. For more information go to www.P65Warnings.ca.gov.

PA2833



Outer Air Element

Fits: R.V.I. Trucks
Use With: PA2834
Replaces: Renault 5000814797
O.D.: 12 1/8 (308.0)
I.D.: 5/8 (15.9) & 7 11/16 (195.3)
Height: 15 1/4 (387.4)
A. Gskt: [1] Attached
F. Gskt: G103-N

PA2834



Inner Air Element

Fits Inside: PA2833
Fits: John Deere Equipment; R.V.I. Trucks
Replaces: Renault 5000814798
O.D.: 7 1/4 (184.2)
 Flange 8 13/32 (213.5)
I.D.: 11/16 (17.5) & 6 3/16 (157.2)
Height: 14 17/32 (369.1)
A. Gskt: [1] Attached
F. Gskt: G103-N

PA2835



Inner Air Element

Fits Inside: PA2405
Fits: Bomag, Claas, Demag, Fendt, International, John Deere, Kobelco, Liebherr Equipment; DAF, Iveco, R.V.I. Buses, Trucks
Replaces: Bomag 5821014; Claas 1761680; Iveco 1902131; John Deere AZ30758
O.D.: 4 1/32 (102.4)
 Flange Gasket 4 13/32 (111.9)
I.D.: 11/16 (17.5) & 3 5/16 (84.1)
Height: 14 5/8 (371.5)
A. Gskt: [1] Attached
F. Gskt: [1] Included

PA2836



Inner Air Element

Fits Inside: PA2474
Fits: Atlas Copco, Compair Compressors; DAF, Iveco, M.A.N., R.V.I. Buses, Trucks; Bomag, John Deere, Kobelco, Liebherr, Volvo Equipment
Replaces: Atlas Copco 29000501; Bomag 5821019; Iveco 2243946; John Deere AZ26007; Liebherr 5601963; Volvo 4785746
O.D.: 4 13/32 (111.9)
 Flange Gasket 4 25/32 (121.4)
I.D.: 11/16 (17.5) & 3 11/16 (93.7)
Height: 14 15/16 (379.4)
A. Gskt: [1] Attached
F. Gskt: [1] Included

PA2837



Inner Air Element

Fits Inside: PA2845
Fits: Bomag, Claas, Demag, Fendt, Liebherr, V.M.E., Volvo Equipment; Iveco, M.A.N., R.V.I. Trucks
Replaces: Bomag 5821015; Claas 176169; Demag 39468640; Iveco 2415950; Liebherr 7361346; Volvo 4785611-7
O.D.: 3 9/32 (83.3)
 Flange Gasket 3 5/8 (92.1)
I.D.: 11/16 (17.5) & 2 27/32 (72.2)
Height: 13 7/16 (341.3)
A. Gskt: [1] Attached
F. Gskt: [1] Included

PA2838



Air Element with Lid

Fits: Mercedes-Benz Buses, Trucks, Vans
Replaces: Mercedes-Benz 10948304
O.D.: 12 7/8 (327.0)
 Lid 15 1/4 (387.4)
I.D.: 13/32 (10.3) & 6 9/16 (166.7)
Height: 10 1/16 (255.6)
A. Gskt: [1] Attached
End Seals: [1] Attached

PA2839



Air Element with Lift Tabs

Fits: MCI, Prevost Buses
Replaces: Flxible 97342400210; TCM 9G3-37; Universal Coach T121009
O.D.: 15 3/32 (383.4)
 Boot 16 1/16 (408.0)
I.D.: 13/16 (20.6) & 8 21/32 (219.9)
Height: 15 15/16 (404.8)
A. Gskt: [2] Attached
F. Gskt: [1] Included

PA2840



Outer Air Element

Fits: Astra Dump Trucks with Iveco Engine; New Holland Equipment
Use With: PA3861
Replaces: Iveco 107029
O.D.: 12 1/8 (308.0)
I.D.: 21/32 (16.7) & 7 23/32 (196.1)
Height: 20 1/2 (520.7)
A. Gskt: [1] Attached
F. Gskt: [1] Included

PA2843



Air Element

Replaces: Air Refiner ARM18-1200; Donaldson P181200
O.D.: 10 3/8 (263.5)
I.D.: 6 1/32 (153.2) One End
Height: 10 1/2 (266.7)
A. Gskt: [1] Attached

PA2844

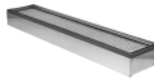

Cab Air Element

Fits: Caterpillar Crawler Tractors
Replaces: Caterpillar 7T1890
Length: 26 1/8 (663.6)
Width: 5 7/16 (138.1)
Height: 2 9/16 (65.1)
A. Gskt: [1] Attached

PA2845



Outer Air Element

Fits: Atlas Copco Compressors; Bomag, Claas, Demag, Fendt, Ford, John Deere, Liebherr, V.M.E., Volvo Equipment; Iveco, M.A.N., R.V.I. Buses, Trucks
Use With: PA2837, PA3601
Replaces: Atlas Copco 1619-2797; Bomag 5821013; Demag 964013; Ford A830X-9601-ABA; Iveco 1902127; John Deere AZ20623; Volvo 6644839
O.D.: 6 15/32 (164.3)
I.D.: 13/32 (10.3) & 3 5/8 (92.1)
Height: 13 3/4 (349.3)
A. Gskt: [1] Attached

Measurements Are Shown In Inches And (Millimeters)



WARNING: These products can expose you to chemicals, including Diisononyl Phthalate, Carbon black extracts, Nickel, 1,3 Butadiene, Ethylene Oxide, Epichlorohydrin, which are known to the State of California to cause cancer, and Bisphenol, Ethylene Glycol, Ethylene Oxide, 1,3 Butadiene, Epichlorohydrin, which are known to the State of California to cause birth defects or other reproductive harm. For more information go to www.P65Warnings.ca.gov.

PA2846-FN



Outer Air Element with Fins
Fits: Case, International Equipment
Use With: PA2700
Replaces: International 1265510-C1
O.D.: 5 1/4 (133.4)
 Fins 6 3/8 (161.9)
I.D.: 21/32 (16.7) & 3 1/4 (82.6)
Height: 11 3/8 (288.9)
A. Gskt: [1] Attached
F. Gskt: G103-N

PA2847



Air Element with Lid
Fits: Fendt, Hanomag, John Deere Equipment; Iveco, M.A.N., Mercedes-Benz, Volvo Buses, Trucks
Replaces: Hanomag 2872977-M1; Iveco 2164590; John Deere AZ23440; Mercedes Benz 10941004; Volvo 500858
O.D.: 8 15/16 (227.0)
 Lid 10 15/16 (277.8)
I.D.: 13/32 (10.3) & 4 9/16 (115.9)
Height: 15 3/32 (383.4)
A. Gskt: [2] Included

PA2848



Inner Air Element
Fits Inside: PA2653
Fits: Caterpillar Generators, Industrial, Marine Engines
Replaces: Caterpillar 8N2556
O.D.: 12 25/32 (324.6)
 Flange 15 5/8 (396.9)
I.D.: 10 9/32 (261.1) One End
Height: 10 5/16 (261.9)
A. Gskt: [1] Attached

PA2849



Outer Air Element with Bail Handle
Fits: Caterpillar Equipment
Use With: PA2563
Replaces: Caterpillar 4W5228
O.D.: 14 11/16 (373.1)
 Boot 15 3/8 (390.5)
I.D.: 29/32 (23.0) & 10 11/32 (262.7)
Height: 24 1/2 (622.3)
A. Gskt: [2] Attached
F. Gskt: [1] Included

PA2851



Conical-Shaped Air Element
Fits: Mack Trucks
Replaces: Mack 57MD45M
O.D.: 7 13/32 (188.1)
 to 10 13/32 (264.3)
I.D.: 6 15/16 (176.2) One End
Height: 20 1/2 (520.7)
A. Gskt: [1] Included

PA2852



Outer Air Element
Fits: Dresser Motor Graders
Use With: PA2853
Replaces: Dresser 1249055-H1
O.D.: 10 27/32 (275.4)
I.D.: 15/16 (23.8) & 6 1/2 (165.1)
Height: 18 1/2 (469.9)
A. Gskt: [1] Attached
F. Gskt: [1] Included

PA2853



Inner Air Element
Fits Inside: PA2852
Fits: Dresser Motor Graders
Replaces: International 1249056-H1
O.D.: 6 3/8 (161.9)
I.D.: 5/8 (15.9) & 5 9/32 (134.1)
Height: 17 1/2 (444.5)
A. Gskt: [1] Attached
F. Gskt: G103-N

PA2854



Panel Air Element
Replaces: Tennant 81363
Length: 30 (762.0)
Width: 20 (508.0)
Height: 3 9/16 (90.5)

PA2855



Air Element
Fits: Torit Air Cleaning Systems
Replaces: Torit 8PP19215-01
O.D.: 12 3/4 (323.9)
I.D.: 17/32 (13.5) & 8 11/32 (211.9)
Height: 26 1/2 (673.1)
A. Gskt: [1] Attached
F. Gskt: [1] Included

PA2856



Air Element
Fits: Torit Air Cleaning Systems
Replaces: Torit 8PP21586-00
O.D.: 7 15/16 (201.6)
I.D.: 11/16 (17.5) & 3 9/16 (90.5)
Height: 16 1/2 (419.1)
A. Gskt: [1] Attached
F. Gskt: [1] Included

PA2857



Air Element
Notes: Inside-Out Flow Direction
Fits: Torit Air Cleaning Systems
Replaces: Torit 8PP21347-00
O.D.: 12 3/4 (323.9)
I.D.: 17/32 (13.5) & 8 11/32 (211.9)
Height: 26 1/2 (673.1)
A. Gskt: [1] Attached
F. Gskt: [1] Included

PA2858



Air Element
Contains: Flame Retardant Media
Fits: Nissan Lift Trucks
Replaces: Nissan 16546-K4046B
O.D.: 7 (177.8)
I.D.: 3 21/32 (92.9)
Height: 5 (127.0)

Measurements Are Shown In Inches And (Millimeters)

WARNING: These products can expose you to chemicals, including Diisononyl Phthalate, Carbon black extracts, Nickel, 1,3 Butadiene, Ethylene Oxide, Epichlorohydrin, which are known to the State of California to cause cancer, and Bisphenol, Ethylene Glycol, Ethylene Oxide, 1,3 Butadiene, Epichlorohydrin, which are known to the State of California to cause birth defects or other reproductive harm. For more information go to www.P65Warnings.ca.gov.

PA2859-FN



Air Element with Fins

Fits: Case Tractors; DAF, Leyland Trucks
Replaces: Case K306535; Leyland MAK1629
O.D.: 7 15/16 (201.6)
 Fins 10 1/32 (254.8)
I.D.: 5/8 (15.9) & 5 5/16 (134.9)
Height: 13 7/16 (341.3)
A. Gskt: [1] Attached
F. Gskt: [1] Included; [1] Metal Washer

RS2863XP



Extreme Performance Nano Radial Seal Outer Air Element

Fits: Caterpillar, Cummins Engines; Ford, Freightliner, GMC, Hino, IHC, Kenworth, Ottawa, Peterbilt, Sterling Trucks; John Deere Tractors; Massey Ferguson Combines
Use With: RS3501
Replaces: Ford F3HZ-9601-A; GMC 15619013; John Deere RE34962
O.D.: 9 9/32 (235.7)
I.D.: 5 5/32 (131.0) One End
Height: 12 3/4 (323.9)
Related To: PA2863 (Standard Media Version)

PA2860-FN



Air Element with Fins

Replaces: Leyland RTC2478
O.D.: 5 1/4 (133.4)
 Fins 6 3/8 (161.9)
I.D.: 2 1/32 (16.7) & 2 5/8 (66.7)
Height: 8 15/32 (215.1)
A. Gskt: [1] Attached
F. Gskt: [1] Included

PA2865



Air Element with Lid

Fits: R.V.I. Trucks
Replaces: Renault 5000809894
O.D.: 9 3/16 (233.4)
 Lid 10 5/32 (258.0)
I.D.: 4 3/32 (104.0) One End
Height: 11 11/16 (296.9)
A. Gskt: [2] Attached

PA2861



Inner Air Element

Fits Inside: LL1690-FN, PA1690-FN
Fits: Hitachi, John Deere, Kubota, Yanmar Equipment
Replaces: John Deere CH12881; Kubota 15287-11490
O.D.: 2 7/16 (61.9)
I.D.: 2 1/32 (16.7) & 1 15/16 (49.2)
Height: 9 1/8 (231.8)
A. Gskt: [1] Attached
F. Gskt: G103-N

PA2866



Air Element

Fits: Hanomag, John Deere, Steyr-Daimler-Puch, Zettelmeyer Equipment; M.A.N. Trucks
Replaces: Deutz 2241034; M.A.N. 81.08304.0028; Zettelmeyer 2121270
O.D.: 7 25/32 (197.6)
 Flange 9 3/4 (247.7)
I.D.: 1 1/32 (8.7) & 4 1/16 (103.2)
Height: 14 13/16 (376.2)
A. Gskt: [1] Attached

PA2862



Air Element

Fits: Guldner Lift Trucks
Use With: PA2862 FOAM
Replaces: Guldner 9830715
O.D.: 3 7/8 (98.4)
I.D.: 2 3/8 (60.3)
Height: 2 3/4 (69.9)

PA2867-FN



Outer Air Element with Fins

Replaces: Donaldson P900509
O.D.: 13 7/8 (352.4)
 Fins 15 25/32 (400.8)
I.D.: 5/8 (15.9) & 9 1/2 (241.3)
Height: 14 11/16 (373.1)
A. Gskt: [1] Attached
F. Gskt: [1] Included

PA2862 FOAM



Foam Blanket for PA2862

Use With: PA2862
O.D.: 3 7/8 (98.4)
I.D.: 3 11/16 (93.7)
Length: 2 3/4 (69.9)

PA2869



Air Element

Fits: Volvo Buses, Trucks
Replaces: Volvo 347436
O.D.: 8 17/32 (216.7)
I.D.: 1 1/32 (8.7) & 6 1/32 (153.2)
Height: 10 11/32 (262.7)
A. Gskt: [1] Attached

RS2863



Radial Seal Outer Air Element

Fits: Caterpillar, Cummins Engines; Ford, Freightliner, GMC, Hino, IHC, Kenworth, Ottawa, Peterbilt, Sterling Trucks; John Deere Tractors; Massey Ferguson Combines
Use With: RS3501
Replaces: Ford F3HZ-9601-A; GMC 15619013; John Deere RE34962
O.D.: 9 9/32 (235.7)
I.D.: 5 5/32 (131.0) One End
Height: 12 3/4 (323.9)
Related To: RS2863XP (Extreme Performance Nano Version)

PA2870-FN



Air Element with Fins

Fits: Air Refiner Housings; Ford Trucks
Replaces: Air Refiner ARM90-0408
O.D.: 11 1/8 (282.6)
 Fins 13 13/16 (350.8)
I.D.: 7/8 (22.2) & 6 23/32 (170.7)
Height: 13 1/2 (342.9)
A. Gskt: [1] Attached
F. Gskt: [1] Included

Measurements Are Shown In Inches And (Millimeters)

WARNING: These products can expose you to chemicals, including Diisononyl Phthalate, Carbon black extracts, Nickel, 1,3 Butadiene, Ethylene Oxide, Epichlorohydrin, which are known to the State of California to cause cancer, and Bisphenol, Ethylene Glycol, Ethylene Oxide, 1,3 Butadiene, Epichlorohydrin, which are known to the State of California to cause birth defects or other reproductive harm. For more information go to www.P65Warnings.ca.gov.

PA2871

Air Element



Fits: Air Refiner Housings; Ford Trucks
Replaces: Air Refiner ARM90-0405
O.D.: 6 3/8 (161.9)
 Flange 7 1/2 (190.5)
I.D.: 5/8 (15.9) & 5 1/4 (133.4)
Height: 13 (330.2)
A. Gskt: [1] Attached
F. Gskt: [1] Included

PA2878

Air Element



Replaces: Ford 81DB-9601-DB;
 GMC 93152751
O.D.: 12 5/8 (320.7)
I.D.: 8 17/32 (216.7)
Height: 4 5/16 (109.5)

PA2873

Air Element with Lid



Fits: Volvo Buses
Replaces: Volvo 1131838
O.D.: 8 31/32 (227.8)
 Lid 10 15/16 (277.8)
I.D.: 13/32 (10.3) & 4 19/32 (116.7)
Height: 15 1/8 (384.3)
A. Gskt: [2] Attached

PA2880

Air Element



Fits: Hino Trucks
Replaces: Hino 17801-2200
O.D.: 8 1/2 (215.9)
I.D.: 7/8 (22.2) & 5 3/8 (136.5)
Height: 12 7/8 (327.0)
A. Gskt: [1] Attached
F. Gskt: [1] Included

PA2874

Replacement for Ecolite Air Element in Disposable Housing



Fits: Farr ECO-CM Housings;
 Freightliner Trucks
Replaces: Farr C78105-000
O.D.: 11 (279.4)
Inlet: 8
Outlet: 6
Height: 25 13/32 (645.3)

PA2881

Oblong Air Element



Replaces: Nissan 16546-06J00
O.D.: 8 (203.2) to 14 9/16 (369.9)
I.D.: 5 9/32 (134.1) & 11 13/16 (300.0)
Height: 2 7/8 (73.0)

PA2875

Replacement for Ecolite Air Element in Disposable Housing



Fits: Farr Optional Filter Housings
Replaces: Farr C71338-004
O.D.: 13 17/32 (343.7)
Inlet: 10 23/32
Outlet: 7
Height: 19 13/16 (503.2)

PA2883

Inner Air Element



Fits Inside: PA3786-FN
Fits: Ford Trucks
Replaces: GMC 25095991
O.D.: 8 1/2 (215.9)
I.D.: 21/32 (16.7) & 6 7/32 (158.0)
Height: 15 25/32 (400.8)
A. Gskt: [1] Attached
F. Gskt: [1] Included

PA2876

Replacement for Ecolite Air Element in Disposable Housing



Fits: Farr Optional Filter Housings
Replaces: Farr C71338-001
O.D.: 9 3/4 (247.7)
Inlet: 10 23/32
Outlet: 6
Height: 25 7/8 (657.2)

PA2884

Air Element



Fits: Isuzu Trucks
Replaces: Isuzu 8-94334-906-0
O.D.: 6 1/16 (154.0)
I.D.: 3 7/8 (98.4) & 4 (101.6)
Height: 6 3/8 (161.9)
A. Gskt: [1] Attached

PA2877-FN

Air Element with Fins



Replaces: Isuzu 1-14215-196-0
O.D.: 6 1/16 (154.0)
 Fins 7 13/16 (198.4)
I.D.: 1/2 (12.7) & 3 15/32 (88.1)
Height: 12 3/8 (314.3)
A. Gskt: [1] Attached
F. Gskt: [1] Included

PA2885

Air Element



Replaces: Nissan 16546-06J11
O.D.: 6 3/32 (154.8)
I.D.: 3 15/32 (88.1)
Height: 6 1/8 (155.6)
A. Gskt: [2] Attached

Measurements Are Shown In Inches And (Millimeters)

WARNING: These products can expose you to chemicals, including Diisononyl Phthalate, Carbon black extracts, Nickel, 1,3 Butadiene, Ethylene Oxide, Epichlorohydrin, which are known to the State of California to cause cancer, and Bisphenol, Ethylene Glycol, Ethylene Oxide, 1,3 Butadiene, Epichlorohydrin, which are known to the State of California to cause birth defects or other reproductive harm. For more information go to www.P65Warnings.ca.gov.

PA2887-FN



Outer Air Element with Fins
Replaces: International 3244397-R1
O.D.: 7 31/32 (202.4)
 Fins 9 29/32 (251.6)
I.D.: 11/16 (17.5) & 5 3/8 (136.5)
Height: 15 1/2 (393.7)
A. Gskt: [1] Attached
F. Gskt: [1] Included

PA2896



Inner Air Element
Fits Inside: PA2897
Replaces: Donaldson P128486
O.D.: 4 19/32 (116.7)
I.D.: 21/32 (16.7) & 3 11/32 (84.9)
Height: 10 3/4 (273.1)
A. Gskt: [1] Attached
F. Gskt: [1] Included

PA2888



Air Element
Fits: Mercedes-Benz Trucks, Vans
Replaces: Mercedes-Benz 20947004
O.D.: 5 29/32 (150.0)
I.D.: 7/16 (11.1) & 2 25/32 (70.6)
Height: 12 (304.8)
A. Gskt: [2] Attached

PA2897



Outer Air Element with 2 Lift Bars
Use With: PA2896
Replaces: Ryco HDA5495
O.D.: 8 13/32 (213.5)
I.D.: 21/32 (16.7) & 5 25/32 (146.8)
Height: 12 3/8 (314.3)
A. Gskt: [1] Attached
F. Gskt: [1] Included

PA2889



Inner Air Element
Fits Inside: PA2890
Fits: Massey Ferguson Wheel Tractors
Replaces: Massey Ferguson 1886638-M91
O.D.: 2 23/32 (69.1)
I.D.: 19/32 (15.1) & 1 31/32 (50.0)
Height: 8 (203.2)
F. Gskt: [1] Included

PA2899



Air Element
Replaces: Air Refiner ARM90-0442
O.D.: 6 3/8 (161.9)
 Flange Gasket 7 1/2 (190.5)
I.D.: 5/8 (15.9) & 5 1/4 (133.4)
Height: 18 (457.2)
A. Gskt: [1] Attached
F. Gskt: [1] Included

PA2890



Outer Air Element
Fits: Massey Ferguson Wheel Tractors
Use With: PA2889
Replaces: Massey Ferguson 1886637-M91
O.D.: 4 19/32 (116.7)
I.D.: 21/32 (16.7) & 2 15/32 (62.7)
Height: 9 11/32 (237.3)
A. Gskt: [1] Attached

PA2900



Air Element
Replaces: Heavy Duty Air A02028
O.D.: 11 7/8 (301.6)
I.D.: 17/32 (13.5) & 7 1/8 (181.0)
Height: 26 1/2 (673.1)
A. Gskt: [1] Attached

PA2891



Air Element
Fits: Iveco Buses, Trucks
Replaces: Iveco 1902128, 3168629
O.D.: 8 15/16 (227.0)
I.D.: 7/16 (11.1) & 4 19/32 (116.7)
Height: 11 5/8 (295.3)
A. Gskt: [1] Attached
F. Gskt: [1] Washer

PA2902



Outer Air Element
Fits: Caterpillar, Hitachi, John Deere, Kawasaki, Komatsu Equipment
Use With: PA2903
Replaces: Caterpillar 7Y1196; Hitachi 4240294; Kawasaki 3098170130; Komatsu 5610-21-2330
O.D.: 12 1/8 (308.0)
I.D.: 29/32 (23.0) & 7 11/16 (195.3)
Height: 24 1/2 (622.3)
A. Gskt: [1] Attached
F. Gskt: [1] Included

PA2895



Air Element
Replaces: Mazda SLA2-13-Z40A
O.D.: 7 15/16 (201.6)
I.D.: 29/32 (23.0) & 4 31/32 (126.2)
Height: 8 15/32 (215.1)
A. Gskt: [1] Attached
F. Gskt: [1] Included

PA2903



Inner Air Element
Fits Inside: PA2902
Fits: Caterpillar, Hitachi, John Deere, Kawasaki, Komatsu Equipment
Replaces: Caterpillar 7Y1197; Hitachi 4240295; Kawasaki 3098170140; Komatsu 5610-21-2320
O.D.: 7 1/4 (184.2)
I.D.: 11/16 (17.5) & 6 3/16 (157.2)
Height: 23 1/2 (596.9)
A. Gskt: [1] Attached
F. Gskt: G103-N

Measurements Are Shown In Inches And (Millimeters)

! **WARNING:** These products can expose you to chemicals, including Diisononyl Phthalate, Carbon black extracts, Nickel, 1,3 Butadiene, Ethylene Oxide, Epichlorohydrin, which are known to the State of California to cause cancer, and Bisphenol, Ethylene Glycol, Ethylene Oxide, 1,3 Butadiene, Epichlorohydrin, which are known to the State of California to cause birth defects or other reproductive harm. For more information go to www.P65Warnings.ca.gov.

PA2904 Air Element
Replaces: Isuzu 8-94135-886-0;
 Nissan 16546-T3400
O.D.: 6 3/32 (154.8)
I.D.: 1/2 (12.7) & 3 15/32 (88.1)
Height: 7 7/8 (200.0)
A. Gskt: [1] Attached
F. Gskt: [1] Included



PA2914 Air Element
Fits: Volvo Trucks
Replaces: Volvo 1660376
O.D.: 10 5/8 (269.9)
I.D.: 13/32 (10.3) & 7 1/4 (184.2)
Height: 22 27/32 (580.2)
A. Gskt: [2] Attached



PA2905 Air Element with Lid
Replaces: Fendt F135201090020;
 Volvo 4541565
O.D.: 5 (127.0)
 Lid 6 7/32 (158.0)
I.D.: 11/32 (8.7) & 2 17/32 (64.3)
Height: 11 17/32 (292.9)
A. Gskt: [1] Attached
End Seals: [1] Attached



PA2915 Air Element
Fits: Volvo Trucks
Replaces: Volvo 1660377, 16618084
O.D.: 6 7/8 (174.6)
I.D.: 13/32 (10.3) & 5 7/16 (138.1)
Height: 21 19/32 (548.5)
A. Gskt: [1] Attached



PA2906 Air Element
Replaces: Mann & Hummel C15124/1
O.D.: 6 1/16 (154.0)
I.D.: 3 1/2 (88.9)
Height: 9 1/32 (229.4)



PA2919 Air Element
Notes: OBSOLETE. Availability Limited to Dealer Stock.
Replaces: M.A.N. 45.16154.104
O.D.: 7 13/16 (198.4)
I.D.: 11/32 (8.7) & 4 1/16 (103.2)
Height: 4 13/16 (122.2)
A. Gskt: [1] Attached



PA2909 Air Element with Lift Bars
Replaces: Air Refiner ARM12-8487
O.D.: 8 1/4 (209.6)
I.D.: 5/8 (15.9) & 5 3/4 (146.1)
Height: 10 1/2 (266.7)
A. Gskt: [1] Attached
F. Gskt: [1] Included



PA2932 Air Element
Fits: Industrial Applications
Replaces: Heavy Duty Air A02067
O.D.: 6 27/32 (173.8)
I.D.: 7/16 (11.1) & 4 3/16 (106.4)
Height: 9 (228.6)
F. Gskt: [1] Included



PA2912 Air Element
Replaces: Knecht AG300
O.D.: 5 3/16 (131.8)
I.D.: 1/2 (12.7) & 2 5/8 (66.7)
Height: 6 25/32 (172.2)
A. Gskt: [1] Attached
F. Gskt: [1] Included



PA2933 Air Element
Fits: Mining Drills
Replaces: Heavy Duty Air A100195-192
O.D.: 1 31/32 (50.0)
I.D.: 1 1/8 (28.6)
Height: 1 13/16 (46.0)



PA2913 Air Element
Replaces: Isuzu 8-94107-690
O.D.: 6 3/32 (154.8)
I.D.: 1/2 (12.7) & 3 15/32 (88.1)
Height: 9 19/32 (243.7)
A. Gskt: [1] Attached
F. Gskt: [1] Included



PA2935 Panel Air Element
Fits: Industrial Applications
Replaces: Heavy Duty Air A6083
Length: 26 (660.4)
Width: 11 (279.4)
Height: 2 3/16 (55.6)

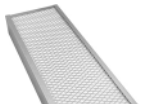

Measurements Are Shown In Inches And (Millimeters)

 **WARNING:** These products can expose you to chemicals, including Diisononyl Phthalate, Carbon black extracts, Nickel, 1,3 Butadiene, Ethylene Oxide, Epichlorohydrin, which are known to the State of California to cause cancer, and Bisphenol, Ethylene Glycol, Ethylene Oxide, 1,3 Butadiene, Epichlorohydrin, which are known to the State of California to cause birth defects or other reproductive harm. For more information go to www.P65Warnings.ca.gov.

PA2936

Panel Air Element



Fits: Industrial Applications
Replaces: Heavy Duty Air A7523
Length: 15 (381.0)
Width: 7 (177.8)
Height: 2 3/16 (55.6)

PA2938

Air Element



Fits: Industrial Applications
Replaces: Heavy Duty Air A3347
O.D.: 8 1/32 (204.0)
I.D.: 6 1/16 (154.0)
Height: 12 (304.8)
A. Gskt: [2] Attached

PA2942

Outer Air Element



Fits: Mercedes-Benz Trucks, Vans
Replaces: Mercedes-Benz 30944204
O.D.: 12 3/4 (323.9)
I.D.: 7/16 (11.1) & 6 5/16 (160.3)
Height: 10 1/16 (255.6)
A. Gskt: [1] Attached
F. Gskt: [1] Included

PA2944-FN

Air Element with Fins



Fits: Ford, New Holland Equipment
Replaces: Ford E9NN-9601-EA, SBA314531126
O.D.: 4 3/32 (104.0)
 Fins 5 1/8 (130.2)
I.D.: 13/32 (10.3) & 2 15/32 (62.7)
Height: 10 5/16 (261.9)
A. Gskt: [1] Attached
F. Gskt: [1] Included

LL2945

Long Life Outer Air Element



Fits: John Deere, Tamrock Equipment;
 R.V.I., Volvo Buses, Trucks
Replaces: John Deere AZ39761;
 Renault 5000953712
O.D.: 12 1/32 (305.6)
I.D.: 5/8 (15.9) & 7 11/16 (195.3)
Height: 16 11/16 (423.9)
A. Gskt: [1] Attached
F. Gskt: G103-N
Related To: PA2945 (Standard Media Version)

PA2945

Outer Air Element



Fits: John Deere, Tamrock Equipment;
 R.V.I., Volvo Buses, Trucks
Replaces: John Deere AZ39761;
 Renault 5000953712
O.D.: 12 1/32 (305.6)
I.D.: 5/8 (15.9) & 7 11/16 (195.3)
Height: 16 11/16 (423.9)
A. Gskt: [1] Attached
F. Gskt: G103-N
Related To: LL2945 (Long-Life Media Version)

PA2946

Air Element



O.D.: 6 5/8 (168.3)
I.D.: 3/8 (9.5) & 4 1/4 (108.0)
Height: 15 17/32 (394.5)
A. Gskt: [1] Attached
F. Gskt: [1] Included

PA2947

Panel Air Element

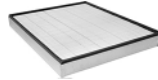

Fits: American Lincoln Floor Cleaning
 Equipment
Replaces: American Lincoln 82404070
Length: 24 (609.6)
Width: 19 11/16 (500.1)
Height: 2 9/16 (65.1)
A. Gskt: [1] Attached

PA2948

Air Element



Replaces: Hino 17801-2440
O.D.: 7 1/2 (190.5)
I.D.: 4 1/8 (104.8)
Height: 11 13/32 (289.7)
A. Gskt: [1] Attached
F. Gskt: [1] Included

PA2949-FN

Air Element with Fins



Contains: Flame Retardant Media
Fits: Nissan Lift Trucks
Replaces: Nissan 16546-51H10B
O.D.: 5 1/4 (133.4)
 Fins 6 3/8 (161.9)
I.D.: 21/32 (16.7) & 2 27/32 (72.2)
Height: 9 1/2 (241.3)
A. Gskt: [1] Attached
F. Gskt: [1] Included

PA2950

Air Element



Replaces: Air Refiner ARM913
O.D.: 9 7/32 (234.2)
I.D.: 29/32 (23.0) & 4 27/32 (123.0)
Height: 13 15/32 (342.1)
A. Gskt: [1] Attached
F. Gskt: [1] Included

PA2951

Air Element



Replaces: Air Refiner ARM13-7982
O.D.: 11 1/8 (282.6)
I.D.: 7/8 (22.2) & 6 23/32 (170.7)
Height: 16 1/2 (419.1)
A. Gskt: [1] Attached
F. Gskt: [1] Included

Measurements Are Shown In Inches And (Millimeters)



WARNING: These products can expose you to chemicals, including Diisononyl Phthalate, Carbon black extracts, Nickel, 1,3 Butadiene, Ethylene Oxide, Epichlorohydrin, which are known to the State of California to cause cancer, and Bisphenol, Ethylene Glycol, Ethylene Oxide, 1,3 Butadiene, Epichlorohydrin, which are known to the State of California to cause birth defects or other reproductive harm. For more information go to www.P65Warnings.ca.gov.

PA2952

Air Element



Replaces: Air Refiner ARM13-7981
O.D.: 12 3/32 (307.2)
I.D.: 7/8 (22.2) & 7 11/16 (195.3)
Height: 18 1/2 (469.9)
A. Gskt: [1] Attached
F. Gskt: [1] Included

PA2958

Air Element



Fits: Bedford Buses, Trucks
Replaces: GMC 7964609
O.D.: 8 5/16 (211.1)
I.D.: 6 1/32 (153.2)
Height: 8 1/32 (204.0)
A. Gskt: [1] Attached

PA2953

Air Element



Replaces: Air Refiner ARM14-0925
O.D.: 9 7/32 (234.2)
I.D.: 29/32 (23.0) & 4 27/32 (123.0)
Height: 15 3/8 (390.5)
A. Gskt: [1] Attached
F. Gskt: [1] Included

PA2959-FN

Outer Air Element with Fins



Fits: Ford Buses, Trucks
Use With: PA2960
Replaces: Air Refiner ARM90-0023;
 Motorcraft AFA93
O.D.: 13 7/8 (352.4)
 Fins 15 25/32 (400.8)
I.D.: 29/32 (23.0) & 9 1/2 (241.3)
Height: 15 1/2 (393.7)
A. Gskt: [1] Attached
F. Gskt: [1] Included

PA2954-FN

Outer Air Element with Fins



Replaces: Air Refiner ARM12-7172
O.D.: 7 15/16 (201.6)
 Fins 9 13/16 (249.2)
I.D.: 11/16 (17.5) & 3 9/16 (90.5)
Height: 10 3/8 (263.5)
A. Gskt: [1] Attached
F. Gskt: G103-N

PA2960

Inner Air Element



Fits Inside: PA2959-FN
Fits: Ford Buses, Trucks
Replaces: Air Refiner ARM90-0024;
 Motorcraft AFA94
O.D.: 8 1/4 (209.6)
I.D.: 21/32 (16.7) & 7 1/8 (181.0)
Height: 14 3/8 (365.1)
A. Gskt: [1] Attached
F. Gskt: G103-N

PA2955

Air Element with Lid



Fits: Mercedes-Benz Trucks, Vans
Replaces: Mercedes-Benz 29042404
O.D.: 12 7/8 (327.0)
 Lid 15 1/4 (387.4)
I.D.: 13/32 (10.3) & 6 9/16 (166.7)
Height: 14 1/32 (356.4)
A. Gskt: [2] Attached

PA2961-FN

Outer Air Element with Fins



Fits: Hino Buses, Trucks
Replaces: Hino 17801-1580, 17801-1720
O.D.: 7 15/16 (201.6)
 Fins 9 31/32 (253.2)
I.D.: 1/2 (12.7) & 3 13/16 (96.8)
Height: 11 7/8 (301.6)
A. Gskt: [1] Attached
F. Gskt: [1] Included

PA2956-FN

Outer Air Element with Fins



Fits: Ford Trucks
Use With: PA2957
Replaces: Donaldson P900471;
 Motorcraft AFA106
O.D.: 13 13/16 (350.8)
 Fins 15 25/32 (400.8)
I.D.: 29/32 (23.0) & 9 1/2 (241.3)
Height: 18 13/32 (467.5)
A. Gskt: [1] Attached
F. Gskt: [1] Included

PA2962

Air Element



Replaces: Air Refiner ARM90-0556;
 Donaldson P900556
O.D.: 12 3/32 (307.2)
I.D.: 7/8 (22.2) & 7 23/32 (196.1)
Height: 23 1/2 (596.9)
A. Gskt: [1] Attached
F. Gskt: [1] Included

PA2957

Inner Air Element



Fits Inside: PA2956-FN
Fits: Ford Trucks
Replaces: Donaldson P900472;
 Motorcraft AFA107
O.D.: 8 1/4 (209.6)
I.D.: 21/32 (16.7) & 7 1/8 (181.0)
Height: 17 1/8 (435.0)
A. Gskt: [1] Attached
F. Gskt: G103-N

PA2963













Air Element



Fits: Volvo Trucks
Replaces: Volvo 6897063
O.D.: 10 5/8 (269.9)
I.D.: 21/32 (16.7) & 7 1/4 (184.2)
Height: 22 13/16 (579.4)
A. Gskt: [1] Attached
F. Gskt: G103-N

Measurements Are Shown In Inches And (Millimeters)

WARNING: These products can expose you to chemicals, including Diisononyl Phthalate, Carbon black extracts, Nickel, 1,3 Butadiene, Ethylene Oxide, Epichlorohydrin, which are known to the State of California to cause cancer, and Bisphenol, Ethylene Glycol, Ethylene Oxide, 1,3 Butadiene, Epichlorohydrin, which are known to the State of California to cause birth defects or other reproductive harm. For more information go to www.P65Warnings.ca.gov.

<p>PA2964</p> 	<p>Air Element Fits: Volvo Trucks Replaces: Volvo 6897064 O.D.: 7 1/8 (181.0) I.D.: 21/32 (16.7) & 5 1/2 (139.7) Height: 21 9/16 (547.7) A. Gskt: [1] Attached F. Gskt: [1] Included</p>	<p>PA2976-FN</p>  <p>Outer Air Element with Fins and Lid Fits: Fiat-Allis, Massey Ferguson Equipment; Lister Engines Use With: PA2700 Replaces: Fiat 79062702; Lister 36607282; Massey Ferguson 3310358-M1 O.D.: 6 13/32 (162.7) Lid 6 25/32 (172.2) I.D.: 5/8 (15.9) & 2 3/4 (69.9) Height: 12 (304.8) A. Gskt: [1] Attached; [1] Wing Nut</p>
<p>PA2967</p> 	<p>Air Element Replaces: Air Refiner ARM13-8789; Donaldson P138789 O.D.: 7 1/4 (184.2) I.D.: 21/32 (16.7) & 6 3/16 (157.2) Height: 16 1/2 (419.1) A. Gskt: [1] Attached F. Gskt: [1] Included</p>	<p>PA2977-FN</p>  <p>Outer Air Element with Fins and Lid Fits: J.C. Bamford Equipment Use With: PA2419 Replaces: J.C. Bamford 32/903601 O.D.: 6 3/32 (154.8) Lid 8 3/8 (212.7) I.D.: 21/32 (16.7) & 3 15/32 (88.1) Height: 15 1/2 (393.7) I.Gskt: [1] Included A. Gskt: [1] Attached F. Gskt: [1] Wing Nut</p>
<p>PA2968-FN</p> 	<p>Air Element with Fins and Lid Fits: J.C. Bamford Equipment Replaces: J.C. Bamford 32/906801 O.D.: 6 25/32 (172.2) Lid 8 3/8 (212.7) I.D.: 5/8 (15.9) & 3 15/32 (88.1) Height: 11 1/2 (292.1) A. Gskt: [1] Attached; [1] Wing Nut</p>	<p>PA2978</p>  <p>Air Element Fits: Benford Construction Equipment Replaces: Gardner L22045 O.D.: 5 1/2 (139.7) I.D.: 3 1/8 (79.4) Height: 4 27/32 (123.0)</p>
<p>PA2970</p> 	<p>Outer Air Element with Lid Fits: J.C. Bamford Equipment Use With: PA2689 Replaces: J.C. Bamford 32/903201 O.D.: 6 15/16 (176.2) Lid 8 3/8 (212.7) I.D.: 5/8 (15.9) & 3 7/16 (87.3) Height: 11 9/16 (293.7) A. Gskt: [1] Attached F. Gskt: [1] Wing Nut</p>	<p>PA2980</p>  <p>Set of 2 Air Elements Contains: Outer and Inner Elements Replaces: Ford 2708E-9601-A Outer O.D.: 11 31/32 (304.0) I.D.: 8 17/32 (216.7) Height: 3 7/32 (81.8) Inner O.D.: 6 21/32 (169.1) I.D.: 3 3/16 (81.0) Height: 3 7/16 (87.3)</p>
<p>PA2971</p> 	<p>Air Element Replaces: Leyland ACU8498 O.D.: 9 5/32 (232.6) I.D.: 5/8 (15.9) & 4 7/8 (123.8) Height: 15 15/32 (392.9) F. Gskt: [1] Included, [1] Metal Washer</p>	<p>PA2981</p>  <p>Air Element Contains: [1] Dust Ejector Valve [1] Clamp Fits: Scania Trucks Replaces: Saab-Scania 370750 O.D.: 9 17/32 (242.1) Lid 12 5/32 (308.8) I.D.: 13/32 (10.3) & 5 3/16 (131.8) Height: 20 9/16 (522.3) A. Gskt: [1] Attached</p>
<p>PA2973</p> 	<p>Air Element Fits: Torit Air Cleaning Systems Replaces: Torit 8PP22343-00 O.D.: 12 3/4 (323.9) I.D.: 8 11/32 (211.9) Height: 26 1/2 (673.1) A. Gskt: [1] Attached</p>	<p>PA2982</p>  <p>Air Element with 4 Bolt Holes in Flange Fits: Volvo Trucks Replaces: Volvo 1665563 O.D.: 10 5/32 (258.0) Flange 10 15/16 (277.8) I.D.: 6 9/32 (159.5) One End Height: 21 17/32 (546.9) A. Gskt: [1] Attached</p>

Measurements Are Shown In Inches And (Millimeters)

 **WARNING:** These products can expose you to chemicals, including Diisononyl Phthalate, Carbon black extracts, Nickel, 1,3 Butadiene, Ethylene Oxide, Epichlorohydrin, which are known to the State of California to cause cancer, and Bisphenol, Ethylene Glycol, Ethylene Oxide, 1,3 Butadiene, Epichlorohydrin, which are known to the State of California to cause birth defects or other reproductive harm. For more information go to www.P65Warnings.ca.gov.

PA2984 Air Element
Fits: Ford Trucks
Replaces: Ford 87HX-9601-AA
O.D.: 9 9/16 (242.9)
I.D.: 7 1/4 (184.2)
Height: 3 3/4 (95.3)



PA2988 Air Element
Fits: Industrial Dust Collectors
Replaces: Farr C72518-001; Torit 8PP32582-00
O.D.: 12 3/4 (323.9)
 Flange 15 31/32 x 14 1/4 (405.6 x 362.0)
I.D.: 8 5/16 (211.1) One End
Height: 26 5/8 (676.3)
A. Gskt: [1] Attached
Related To: PA3580 (with Flame Retardant Media)



PA2989 Air Element
Fits: Industrial Dust Collectors
Replaces: Endustra 51013; Farr 84378;
 TDC 10000156
O.D.: 12 3/4 (323.9)
 Flange 15 31/32 x 14 7/32 (405.6 x 361.2)
I.D.: 8 5/16 (211.1) One End
Height: 22 5/8 (574.7)
A. Gskt: [1] Attached



HSG3077 Housing and Radial Seal Air Element
Notes: May use AB3349 Mounting Band.
Contains: RS3715 Radial Seal Air Element
 Dump Valve
Housing
O.D.: 5 17/32 (140.5)
Inlet: 1 3/4
Outlet: 1 7/8
Height: 10 11/16 (271.5)
RS3715
O.D. 3 17/32 (89.7)
I.D. 1 3/4 (44.5)
Height 7 (177.8)
Related To: HSG3078 (Vertical Outlet)



HSG3078 Housing and Radial Seal Air Element
Notes: May use AB3349 Mounting Band.
Contains: RS3715 Radial Seal Air Element
 Dump Valve
Housing
O.D.: 5 17/32 (140.5)
Inlet: 1 3/4
Outlet: 1 7/8
Height: 10 11/16 (271.5)
RS3715
O.D. 3 17/32 (89.7)
I.D. 1 3/4 (44.5)
Height 7 (177.8)
Related To: HSG3077 (Horizontal Outlet)



HSG3079 Housing and Radial Seal Air Element
Contains: RS3988 Radial Seal Element
 Indicator Port
 Mounting Band
 Dump Valve
Housing
O.D.: 5 17/32 (140.5)
Inlet: 2 1/2
Outlet: 2 19/32
Height: 15 3/4 (400.1)
RS3988
O.D. 5 1/32 (127.8)
I.D. 3 5/32 (80.2)
Height 12 5/16 (312.7)
Related To: HSG3080 (Vertical Outlet)



HSG3080 Housing and Radial Seal Air Element
Contains: RS3988 Radial Seal Element
 Indicator Port
 Mounting Band
 Dump Valve
Housing
O.D.: 5 17/32 (140.5)
Inlet: 2 1/2
Outlet: 2 19/32
Height: 15 3/4 (400.1)
RS3988
O.D. 5 1/32 (127.8)
I.D. 3 5/32 (80.2)
Height 12 5/16 (312.7)
Related To: HSG3079 (Horizontal Outlet)



AB3349 Mounting Band
Contains: [1] Mounting Band
 [1] Bolt
 [1] Nut
 [1] Spring
 [1] Washer
Use With: HSG3077, HSG3078



PA3404 Air Element
Fits: Torit ECB Housings
Replaces: Torit 8PP21028-00
O.D.: 12 25/32 (324.6)
I.D.: 17/32 (13.5) & 8 11/32 (211.9)
Height: 26 1/2 (673.1)
A. Gskt: [1] Attached
F. Gskt: [1] Included



PA3405 Air Element with Lift Tab
Fits: Bedford Trucks
Replaces: GMC 91107151
O.D.: 6 15/32 (164.3)
 Flange Gasket 7 7/8 (200.0)
I.D.: 21/32 (16.7) & 3 7/8 (98.4)
Height: 14 11/32 (364.3)
A. Gskt: [2] Attached
F. Gskt: [2] Included

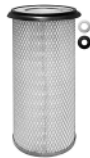

Measurements Are Shown In Inches And (Millimeters)

WARNING: These products can expose you to chemicals, including Diisononyl Phthalate, Carbon black extracts, Nickel, 1,3 Butadiene, Ethylene Oxide, Epichlorohydrin, which are known to the State of California to cause cancer, and Bisphenol, Ethylene Glycol, Ethylene Oxide, 1,3 Butadiene, Epichlorohydrin, which are known to the State of California to cause birth defects or other reproductive harm. For more information go to www.P65Warnings.ca.gov.

PA3406-FN

Air Element with Fins



Fits: White Equipment
Replaces: White 33-0032042
O.D.: 6 3/32 (154.8)
 Fins 7 13/16 (198.4)
I.D.: 3/4 (19.1) & 3 15/32 (88.1)
Height: 7 7/8 (200.0)
A. Gskt: [1] Attached
F. Gskt: G103-N

PA3416

Air Element



Fits: Isuzu Trucks
Replaces: Isuzu 1-14215-157-0
O.D.: 4 19/32 (116.7)
 Boot 5 13/16 (147.6)
I.D.: 5/8 (15.9) & 3 7/16 (87.3)
Height: 10 (254.0)
A. Gskt: [1] Attached
F. Gskt: [1] Included

PA3408

Air Element with Lid



Fits: R.V.I. Trucks
Replaces: Renault 5000807196
O.D.: 11 13/16 (300.0)
 Lid 14 19/32 (370.7)
I.D.: 7/16 (11.1) & 5 5/16 (134.9)
Height: 16 11/32 (415.1)
A. Gskt: [2] Attached
F. Gskt: [1] Included

PA3417

Air Element



Fits: Mitsubishi Trucks
Replaces: Mitsubishi ME033773
O.D.: 5 1/4 (133.4)
I.D.: 21/32 (16.7) & 4 1/8 (104.8)
Height: 11 25/32 (299.2)
A. Gskt: [1] Attached
F. Gskt: [1] Included

PA3411-FN

Air Element with Fins



Replaces: Daihatsu 17801-87303;
 Toyota 17801-87304
O.D.: 6 1/16 (154.0)
 Fins 7 7/8 (200.0)
I.D.: 1/2 (12.7) & 3 15/32 (88.1)
Height: 8 9/32 (210.3)
A. Gskt: [1] Attached

PA3419

Air Element



Fits: Lister Engines
Replaces: Lister-Petter 366-07188
O.D.: 5 7/8 (149.2)
I.D.: 3 7/16 (87.3)
Height: 2 7/8 (73.0)
A. Gskt: [1] Attached

PA3412

Air Breather Element



Fits: ERF, Leyland Trucks; Terex Dump
 Trucks, Scrapers
Replaces: ERF 932833; Euclid 9356460,
 9368796; GMC 9373285; Leyland 729090,
 10906323
O.D.: 3 15/32 (88.1)
I.D.: 1 9/16 (39.7) One End
Height: 2 13/16 (71.4)

PA3420

Panel Air Element



Replaces: Donaldson P123440
Length: 17 (431.8)
Width: 8 (203.2)
Height: 2 3/16 (55.6)

PA3421

Panel Air Element



Replaces: Donaldson P131231;
 Heavy Duty Air A1231
Length: 32 (812.8)
Width: 9 (228.6)
Height: 2 9/16 (65.1)

PA3414

Cab Air Element

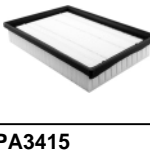

Fits: V.M.E., Volvo Loaders, Trucks
Replaces: Volvo 4771477
Length: 10 5/8 (269.9)
Width: 7 13/32 (188.1)
Height: 1 25/32 (45.2)

PA3430

Inner Air Element



Fits Inside: PA3439-FN
Fits: Dresser Equipment
Replaces: Dresser 1129112-C1
O.D.: 4 1/8 (104.8)
I.D.: 21/32 (16.7) & 3 (76.2)
Height: 14 1/4 (362.0)
A. Gskt: [1] Attached
F. Gskt: G103-N

PA3415

Air Element with Lid



Replaces: Isuzu 1-14215-156-0
O.D.: 7 3/8 (187.3)
 Lid 9 9/32 (235.7)
I.D.: 21/32 (16.7) & 4 11/16 (119.1)
Height: 11 5/16 (287.3)
A. Gskt: [2] Attached
F. Gskt: [1] Included

PA3435-FN

Air Element with Fins



Fits: Manitou Equipment
Use With: PA4881
Replaces: Manitou 177129
O.D.: 5 3/16 (131.8)
 Fins 6 3/8 (161.9)
I.D.: 21/32 (16.7) & 2 5/8 (66.7)
Height: 11 1/16 (281.0)
A. Gskt: [1] Attached
F. Gskt: [1] Included, [1] Wing Nut

Measurements Are Shown In Inches And (Millimeters)



WARNING: These products can expose you to chemicals, including Diisononyl Phthalate, Carbon black extracts, Nickel, 1,3 Butadiene, Ethylene Oxide, Epichlorohydrin, which are known to the State of California to cause cancer, and Bisphenol, Ethylene Glycol, Ethylene Oxide, 1,3 Butadiene, Epichlorohydrin, which are known to the State of California to cause birth defects or other reproductive harm. For more information go to www.P65Warnings.ca.gov.

PA3438 Panel Air Element
Fits: FMC Sweepers
Replaces: FMC 304973
Length: 29 15/16 (760.4)
Width: 6 (152.4)
Height: 2 9/16 (65.1)

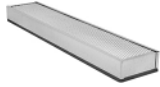

PA3439-FN Outer Air Element with Fins
Fits: Dresser Equipment
Use With: PA3430
Replaces: Dresser 1129111-C1, 1129111-C2
O.D.: 6 7/8 (174.6)
Fins: 8 3/4 (222.3)
I.D.: 2 1/32 (16.7) & 4 3/16 (106.4)
Height: 15 5/16 (388.9)
A. Gskt: [1] Included
F. Gskt: G103-N



PA3440 Cab Air Element
Fits: Caterpillar Equipment
Replaces: Caterpillar 6T0988
Length: 21 1/4 (539.8)
Width: 5 29/32 (150.0)
Height: 2 11/16 (68.3)
A. Gskt: [1] Attached

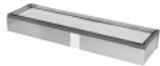

PA3442 Panel Air Element
Replaces: Pixall 6007-0024
Length: 31 (787.4)
Width: 5 (127.0)
Height: 2 3/16 (55.6)



PA3446 Air Element
Fits: R.V.I. Buses, Trucks
Replaces: Renault 5000243970
O.D.: 8 7/8 (225.4)
I.D.: 5/8 (7.9) & 4 1/8 (104.8)
Height: 13 3/8 (339.7)
A. Gskt: [1] Attached



PA3447 Air Element with Lid
Fits: Lister Engines
Replaces: Lister 382-07898
O.D.: 6 11/32 (161.1)
Lid: 7 1/8 (181.0)
I.D.: 1 1/16 (17.5) & 2 27/32 (72.2)
Height: 12 (304.8)
A. Gskt: [1] Attached
F. Gskt: G103-N, [1] Wing Nut



PA3448 Outer Air Element with Lid
Fits: Hino Trucks
Use With: PA3657
Replaces: Hino 17801-2620
O.D.: 7 3/8 (187.3)
Lid: 9 9/32 (235.7)
I.D.: 2 1/32 (16.7) & 4 11/16 (119.1)
Height: 13 1/2 (342.9)
A. Gskt: [2] Attached
F. Gskt: G103-N



PA3449 Air Element
Fits: DAF, R.V.I. Buses, Trucks
Replaces: DAF 693075; Renault 5000802170
O.D.: 8 25/32 (223.0)
Flange: 11 1/4 (285.8)
I.D.: 1/2 (12.7) & 4 3/4 (120.7)
Height: 14 3/4 (374.7)
A. Gskt: [1] Attached



PA3452 Air Element
Fits: Dust Collector Applications
Replaces: Ingersoll-Rand 56958945;
 Tipton 128495, FC3R1001
O.D.: 10 3/8 (263.5)
I.D.: 15/16 (23.8) & 6 1/16 (154.0)
Height: 26 1/2 (673.1)
A. Gskt: [1] Attached
F. Gskt: [1] Included



PA3453 Air Element
Replaces: Fleetguard AF263
O.D.: 12 1/32 (305.6)
I.D.: 7 7/8 (200.0) One End
Height: 16 1/2 (419.1)
A. Gskt: [1] Attached



PA3457 Air Element
Fits: Bucyrus-Erie Blast Hole Drill Dust
 Collectors
Replaces: Heavy Duty Air A07-200
O.D.: 5 11/16 (144.5)
I.D.: 3 9/16 (90.5)
Height: 4 27/32 (123.0)
A. Gskt: [2] Attached



PA3458 Air Element
Fits: Torit DownFlo EAC Dust Collectors
Replaces: Endustra 51053A; Torit 8PP23099-00
O.D.: 12 3/4 (323.9)
I.D.: 8 11/32 (211.9)
Height: 26 1/2 (673.1)
A. Gskt: [1] Attached



PA3460 Air Element
Fits: Torit Air Cleaning Systems
Replaces: Endustra 51049; Torit 8PP18803-00
O.D.: 7 15/16 (201.6)
I.D.: 1 1/16 (17.5) & 3 9/16 (90.5)
Height: 16 1/2 (419.1)
A. Gskt: [1] Included
F. Gskt: [1] Included



Measurements Are Shown In Inches And (Millimeters)

WARNING: These products can expose you to chemicals, including Diisononyl Phthalate, Carbon black extracts, Nickel, 1,3 Butadiene, Ethylene Oxide, Epichlorohydrin, which are known to the State of California to cause cancer, and Bisphenol, Ethylene Glycol, Ethylene Oxide, 1,3 Butadiene, Epichlorohydrin, which are known to the State of California to cause birth defects or other reproductive harm. For more information go to www.P65Warnings.ca.gov.

PA3461



Air Element

Fits: Torit DownFlo II Dust Collectors
Replaces: Torit 8PP32537-00
O.D.: 13 13/16 (350.8)
I.D.: 9 1/2 (241.3)
Height: 26 1/2 (673.1)
A. Gskt: [1] Attached

PA3470



Inner Air Element

Contains: Flame Retardant Media
Fits Inside: PA3469
Fits: John Deere Tractors
Replaces: John Deere RE46311
O.D.: 5 11/16 (144.5)
I.D.: 7/16 (11.1) & 4 13/32 (111.9)
Height: 15 (381.0)
A. Gskt: [1] Attached
F. Gskt: [1] Included

PA3463



Air Element

Notes: Inside-Out Flow Direction
Fits: Torit DownFlo II Dust Collectors
Replaces: Torit 8PP42057-00
O.D.: 13 13/16 (350.8)
I.D.: 9 1/2 (241.3)
Height: 26 1/2 (673.1)
A. Gskt: [1] Attached
Related To: PA3614 (with Flame Retardant Media)

PA3471



Inner Air Element with 8 Bolt Holes

Fits Inside: PA1673
Fits: Caterpillar Equipment
Replaces: Caterpillar 7C1062
O.D.: 3 3/4 (95.3)
 Flange 6 11/16 (169.9)
I.D.: 2 5/8 (66.7) One End
Height: 10 1/16 (255.6)
A. Gskt: [1] Attached

PA3464



Air Element

Fits: Quincy Compressors
Replaces: Quincy 23458-5
O.D.: 12 1/2 (317.5)
I.D.: 13/32 (10.3) & 7 1/2 (190.5)
Height: 22 1/2 (571.5)
A. Gskt: [1] Attached
F. Gskt: [1] Included

PA3472



Outer Air Element

Fits: John Deere Lawn & Garden Tractors
Use With: PA3565
Replaces: John Deere AM108242;
 Woodgate WGA1856
O.D.: 3 1/4 (82.6)
I.D.: 21/32 (16.7) & 2 1/8 (54.0)
Height: 7 1/2 (190.5)
A. Gskt: [1] Attached
F. Gskt: [1] Washer, [1] Wing Nut

PA3466-FN



Air Element with Fins

Notes: Sometimes used with PA2689 Inner Air Element
Fits: Massey Ferguson Equipment
Replaces: Massey Ferguson 1096468-M91
O.D.: 6 3/32 (154.8)
 Fins 7 13/16 (198.4)
I.D.: 3/4 (19.1) & 3 15/32 (88.1)
Height: 11 1/2 (292.1)
A. Gskt: [1] Attached
F. Gskt: G103-N

PA3472-FN



Outer Air Element with Fins

Fits: John Deere Equipment
Use With: PA3565
Replaces: John Deere AM108243
O.D.: 3 1/4 (82.6)
 Fins 4 1/4 (108.0)
I.D.: 21/32 (16.7) & 2 1/8 (54.0)
Height: 7 1/2 (190.5)
A. Gskt: [1] Attached
F. Gskt: G103-N

PA3467



Air Element with Lift Tab

Fits: Bartco Equipment; Gardner Denver Compressors
Replaces: Gardner Denver 1157641
O.D.: 8 1/2 (215.9)
I.D.: 7/16 (11.1) & 5 3/8 (136.5)
Height: 15 1/4 (387.4)
A. Gskt: [1] Attached
F. Gskt: [1] Included

PA3473

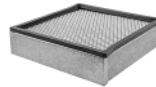

Panel Air Element

Replaces: Donaldson P105958
Length: 10 (254.0)
Width: 10 (254.0)
Height: 2 9/16 (65.1)

PA3469



Outer Air Element with Lift Tab

Fits: John Deere Tractors
Use With: PA3470
Replaces: John Deere RE46310
O.D.: 9 1/8 (231.8)
I.D.: 7/16 (11.1) & 5 13/16 (147.6)
Height: 17 (431.8)
A. Gskt: [1] Attached
F. Gskt: [1] Included

PA3474



Air Element

Fits: Blue Bird Buses
Replaces: Blue Bird 4298501
O.D.: 9 7/32 (234.2)
I.D.: 21/32 (16.7) & 4 27/32 (123.0)
Height: 12 3/8 (314.3)
A. Gskt: [1] Attached
F. Gskt: G103-N

Measurements Are Shown In Inches And (Millimeters)



WARNING: These products can expose you to chemicals, including Diisononyl Phthalate, Carbon black extracts, Nickel, 1,3 Butadiene, Ethylene Oxide, Epichlorohydrin, which are known to the State of California to cause cancer, and Bisphenol, Ethylene Glycol, Ethylene Oxide, 1,3 Butadiene, Epichlorohydrin, which are known to the State of California to cause birth defects or other reproductive harm. For more information go to www.P65Warnings.ca.gov.

PA3475

Air Element



Fits: Ford Buses, Trucks
Replaces: Ford F1HZ-9601-A, F1HZ-9601-C
O.D.: 7 11/32 (186.5)
I.D.: 7/16 (11.1) & 5 3/8 (136.5)
Height: 13 7/8 (352.4)
A. Gskt: [1] Attached
F. Gskt: [1] Included

PA3480

Inner Air Element



Fits Inside: LL2525, PA2525
Fits: International Trucks
Replaces: International 1674319-C1
O.D.: 7 5/8 (193.7)
I.D.: 21/32 (16.7) & 6 1/16 (154.0)
Height: 15 7/8 (403.2)
A. Gskt: [1] Attached
F. Gskt: G103-N

PA3476

Air Element



Fits: Kubota Equipment
Replaces: Kubota 15741-11080
O.D.: 4 3/32 (104.0)
 Flange 5 13/16 (147.6)
I.D.: 9/32 (7.1) & 2 1/2 (63.5)
Height: 10 5/16 (261.9)
A. Gskt: [2] Attached
F. Gskt: [1] Included

PA3481

Panel Air Element



Fits: Crenlo Tractor Cabs
Replaces: Crenlo 80255
Length: 18 7/16 (468.3)
Width: 5 1/4 (133.4)
Height: 2 3/16 (55.6)

PA3477

Air Element with Lid



Fits: DAF, R.V.I., Scania, Volvo Buses, Trucks;
 Faun Frisch, Hanomag Equipment
Replaces: DAF 110376; Faun Frisch 746385;
 Hanomag 195946201; Scania 365727
O.D.: 9 17/32 (242.1)
 Lid 12 1/4 (311.2)
I.D.: 7/16 (11.1) & 5 5/32 (131.0)
Height: 19 3/8 (492.1)
A. Gskt: [2] Attached
F. Gskt: [1] Included

PA3482

Cab Air Element with Lift Tabs



Fits: Caterpillar Equipment, Off-Highway Trucks
Replaces: Caterpillar 2G1946, 9P5174
Length: 13 1/4 (336.6)
Width: 11 15/16 (303.2)
Height: 13/16 (20.6)

PA3478

Conical-Shaped Air Element



Replaces: GMC 25096444
O.D.: 5 13/16 (147.6) to 8 21/32 (219.9)
I.D.: 5 3/16 (131.8) One End
Height: 28 1/2 (723.9)
A. Gskt: [1] Attached
F. Gskt: [1] Included
Related To: PA3478XP (Extreme Performance Nano Version)

PA3483

Replacement for Ecolite Air Element in Disposable Housing



Fits: Volvo-Penta Industrial, Marine Engines
Replaces: Volvo 842280
O.D.: 7 3/4 (196.9)
I.D.: 4 (101.6) One End
Height: 12 15/16 (328.6)

PA3478XP

Extreme Performance Nano Conical-Shaped Air Element



Replaces: Donaldson P604430
O.D.: 5 13/16 (147.6) to 8 21/32 (219.9)
I.D.: 5 3/16 (131.8) One End
Height: 28 1/2 (723.9)
A. Gskt: [1] Attached
F. Gskt: [1] Included
Related To: PA3478 (Standard Media Version)

PA3484

Outer Air Element with 4 Bolt Holes



Fits: Volvo Trucks
Use With: PA3865
Replaces: Volvo 1080918
O.D.: 10 21/32 (270.7)
 Flange 11 13/16 (300.0)
I.D.: 6 5/16 (160.3) One End
Height: 23 7/32 (589.8)
A. Gskt: [2] Attached

PA3479

Outer Air Element with Lid



Fits: Hitachi Equipment
Use With: PA3783
Replaces: Hitachi 4206098
O.D.: 7 31/32 (202.4)
 Lid 9 15/16 (252.4)
I.D.: 7/8 (22.2) & 5 1/4 (133.4)
Height: 10 15/16 (277.8)
A. Gskt: [1] Attached
F. Gskt: [1] Included

PA3486

Air Element



Fits: Ford Buses, Trucks
Replaces: Donaldson P150703
O.D.: 13 7/8 (352.4)
I.D.: 7 7/16 (188.9) One End
Height: 13 1/2 (342.9)
A. Gskt: [1] Attached

Measurements Are Shown In Inches And (Millimeters)

WARNING: These products can expose you to chemicals, including Diisononyl Phthalate, Carbon black extracts, Nickel, 1,3 Butadiene, Ethylene Oxide, Epichlorohydrin, which are known to the State of California to cause cancer, and Bisphenol, Ethylene Glycol, Ethylene Oxide, 1,3 Butadiene, Epichlorohydrin, which are known to the State of California to cause birth defects or other reproductive harm. For more information go to www.P65Warnings.ca.gov.

PA3487



Air Element with Bail Handle
Fits: Donaldson Air Cleaners; Elgin Sweepers
Replaces: Donaldson P525423
O.D.: 6 1/32 (153.2)
 Flange Gasket 7 3/32 (180.2)
I.D.: 3 15/32 (88.1) One End
Height: 15 3/8 (390.5)
A. Gskt: [2] Attached

PA3496



Outer Air Element with Bail Handle
Fits: Sullair Compressors
Use With: PA3498
Replaces: Sullair 2250051-238
O.D.: 15 1/8 (384.2)
 Boot 15 25/32 (400.8)
I.D.: 13/16 (20.6) & 10 (254.0)
Height: 24 1/2 (622.3)
A. Gskt: [2] Included
F. Gskt: [1] Included

PA3491



Outer Air Element
Fits: Ford, New Holland Tractors
Use With: PA3492
Replaces: Ford E9NN-9B618-BA;
 New Holland 82003726
O.D.: 8 1/8 (206.4)
I.D.: 21/32 (16.7) & 3 3/4 (95.3)
Height: 13 3/16 (335.0)
A. Gskt: [2] Attached
F. Gskt: [1] Included

PA3497



Conical-Shaped Outer Air Element
Replaces: Nelson 70855N
O.D.: 12 3/32 (307.2) to 13 23/32 (348.5)
I.D.: 21/32 (16.7) & 9 1/4 (235.0)
Height: 19 1/2 (495.3)
I.Gskt: [1] Included
A. Gskt: [1] Attached

PA3492



Inner Air Element
Fits Inside: PA3491, PA4683
Fits: Ford, New Holland Tractors
Replaces: Ford E9NN-9R500-AB;
 New Holland 82008601
O.D.: 3 5/8 (92.1)
 Boot 4 7/16 (112.7)
I.D.: 1/2 (12.7) & 3 (76.2)
Height: 11 15/32 (291.3)
A. Gskt: [1] Attached
F. Gskt: [1] Included

PA3498



Inner Air Element
Fits Inside: PA3496
Fits: Sullair Compressors
Replaces: Sullair 2250051-239
O.D.: 9 29/32 (251.6)
I.D.: 13/16 (20.6) & 8 1/16 (204.8)
Height: 23 1/2 (596.9)
A. Gskt: [1] Included
F. Gskt: [1] Included

PA3493



Replacement for Ecolite Air Element in Disposable Housing
Fits: Freightliner Chassis; Ottawa Trucks
Replaces: Farr 114880-003A
O.D.: 9 25/32 (248.4)
Inlet: 6
Outlet: 5
Height: 19 7/16 (493.7)

PA3499



Conical-Shaped Air Element
Fits: ERF, Foden Trucks
Replaces: ERF 990199; Foden Y05590000
O.D.: 10 3/8 (263.5) to 11 17/32 (292.9)
I.D.: 21/32 (16.7) & 6 17/32 (165.9)
Height: 19 1/2 (495.3)
A. Gskt: [1] Attached
F. Gskt: G103-N

PA3494



Inner Air Element
Fits Inside: PA2776
Fits: Claas Combines; Iveco, M.A.N. Trucks;
 Liebherr Cranes
Replaces: Claas 722390; Iveco 1905620;
 M.A.N. 81.08405.0011
O.D.: 6 1/16 (154.0)
 Boot 6 3/8 (161.9)
I.D.: 21/32 (16.7) & 5 19/32 (142.1)
Height: 18 9/16 (471.5)
A. Gskt: [1] Attached
F. Gskt: [1] Included

RS3501



Radial Seal Inner Air Element
Fits Inside: RS2863, RS2863XP
Fits: Ford, GMC Trucks; John Deere, Magnum
 Equipment
Replaces: GMC 12544543; Ford F3HZ-9R500-A;
 John Deere RE34963
O.D.: 5 1/4 (133.4)
I.D.: 3 23/32 (94.5) One End
Height: 12 1/32 (305.6)

PA3495

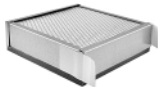

Cab Air Element
Fits: Caterpillar Equipment
Replaces: Caterpillar 7T8945
Length: 9 (228.6)
Width: 9 (228.6)
Height: 2 9/16 (65.1)

RS3502



Radial Seal Outer Air Element
Fits: Caterpillar Equipment
Use With: RS3503
Replaces: Caterpillar 6I2499
O.D.: 9 5/32 (232.6)
I.D.: 4 5/8 (117.5) One End
Height: 12 1/2 (317.5)

Measurements Are Shown In Inches And (Millimeters)

WARNING: These products can expose you to chemicals, including Diisononyl Phthalate, Carbon black extracts, Nickel, 1,3 Butadiene, Ethylene Oxide, Epichlorohydrin, which are known to the State of California to cause cancer, and Bisphenol, Ethylene Glycol, Ethylene Oxide, 1,3 Butadiene, Epichlorohydrin, which are known to the State of California to cause birth defects or other reproductive harm. For more information go to www.P65Warnings.ca.gov.

RS3503



Radial Seal Inner Air Element

Fits Inside: RS3502
Fits: Caterpillar Equipment
Replaces: Caterpillar 6I2500
O.D.: 4 23/32 (119.9)
I.D.: 3 3/16 (81.0) One End
Height: 11 25/32 (299.2)

RS3507



Radial Seal Inner Air Element

Fits Inside: RS3506, RS3506XP
Fits: Caterpillar Equipment
Replaces: Caterpillar 6I2504
O.D.: 5 9/16 (141.3)
I.D.: 4 13/32 (111.9) One End
Height: 15 11/16 (398.5)

RS3504



Radial Seal Outer Air Element

Fits: Agco, Massey Ferguson Tractors; Caterpillar Equipment
Use With: RS3505
Replaces: Caterpillar 6I2501
O.D.: 10 31/32 (278.6)
I.D.: 5 13/16 (147.6) One End
Height: 13 3/8 (339.7)
Related To: RS3504XP (Extreme Performance Nano Version)

RS3508



Radial Seal Outer Air Element

Fits: Caterpillar Equipment; Challenger Tractors; Wirtgen Equipment
Use With: RS3509
Replaces: Caterpillar 122-1674; Wirtgen 162084
O.D.: 11 15/32 (291.3)
I.D.: 7 1/8 (181.0) One End
Height: 13 1/2 (342.9)
Related To: RS3508XP (Extreme Performance Nano Version)

RS3504XP



Extreme Performance Nano Radial Seal Outer Air Element

Fits: Agco, Massey Ferguson Tractors; Caterpillar Equipment
Use With: RS3505
Replaces: Caterpillar 6I2501
O.D.: 10 31/32 (278.6)
I.D.: 5 13/16 (147.6) One End
Height: 13 3/8 (339.7)
Related To: RS3504 (Standard Media Version)

RS3508XP



Extreme Performance Nano Radial Seal Outer Air Element

Fits: Caterpillar Equipment; Challenger Tractors; Wirtgen Equipment
Use With: RS3509
Replaces: Caterpillar 122-1674; Wirtgen 162084
O.D.: 11 15/32 (291.3)
I.D.: 7 1/8 (181.0) One End
Height: 13 1/2 (342.9)
Related To: RS3508 (Standard Media Version)

RS3505



Radial Seal Inner Air Element

Fits Inside: RS3504, RS3504XP
Fits: Caterpillar Equipment
Replaces: Caterpillar 6I2502
O.D.: 5 7/8 (149.2)
I.D.: 4 1/8 (104.8) One End
Height: 12 5/8 (320.7)

RS3509



Radial Seal Inner Air Element

Fits Inside: RS3508, RS3508XP
Fits: Caterpillar Equipment
Replaces: Caterpillar 6I0274
O.D.: 7 1/4 (184.2)
I.D.: 5 9/32 (134.1) One End
Height: 13 3/16 (335.0)

RS3506



Radial Seal Outer Air Element

Fits: Caterpillar, John Deere, Komatsu Equipment; Freightliner Buses
Use With: RS3507, RS5392
Replaces: Caterpillar 6I2503
O.D.: 10 31/32 (278.6)
I.D.: 5 13/16 (147.6) One End
Height: 16 7/16 (417.5)
Related To: RS3506XP (Extreme Performance Nano Version)

RS3510



Radial Seal Outer Air Element

Fits: Caterpillar Equipment; Challenger Tractors
Use With: RS3511
Replaces: Caterpillar 6I2505
O.D.: 12 13/32 (315.1)
I.D.: 8 3/16 (208.0) One End
Height: 15 1/2 (393.7)
Related To: RS3510XP (Extreme Performance Nano Media)

RS3506XP



Extreme Performance Nano Radial Seal Outer Air Element

Fits: Caterpillar, John Deere, Komatsu Equipment; Freightliner Buses
Use With: RS3507, RS5392
Replaces: Caterpillar 6I2503
O.D.: 10 31/32 (278.6)
I.D.: 5 13/16 (147.6) One End
Height: 16 7/16 (417.5)
Related To: RS3506 (Standard Media Version)

RS3510XP



Extreme Performance Nano Radial Seal Outer Air Element

Fits: Caterpillar Equipment; Challenger Tractors
Use With: RS3511
Replaces: Caterpillar 6I2505
O.D.: 12 13/32 (315.1)
I.D.: 8 3/16 (208.0) One End
Height: 15 1/2 (393.7)
Related To: RS3510 (Standard Media Version)

Measurements Are Shown In Inches And (Millimeters)

WARNING: These products can expose you to chemicals, including Diisononyl Phthalate, Carbon black extracts, Nickel, 1,3 Butadiene, Ethylene Oxide, Epichlorohydrin, which are known to the State of California to cause cancer, and Bisphenol, Ethylene Glycol, Ethylene Oxide, 1,3 Butadiene, Epichlorohydrin, which are known to the State of California to cause birth defects or other reproductive harm. For more information go to www.P65Warnings.ca.gov.

RS3511



Radial Seal Inner Air Element
Fits Inside: RS3510, RS3510XP
Fits: Caterpillar Equipment
Replaces: Caterpillar 6I2506
O.D.: 8 5/16 (211.1)
I.D.: 6 1/32 (153.2) One End
Height: 15 7/32 (386.6)

RS3516



Radial Seal Outer Air Element
Fits: Freightliner, Peterbilt Trucks
Replaces: Donaldson P531026
O.D.: 9 9/32 (235.7)
I.D.: 5 25/32 (146.8) One End
Height: 23 7/16 (595.3)

RS3512



Radial Seal Outer Air Element
Fits: Caterpillar Equipment
Use With: RS3513
Replaces: Caterpillar 6I2507
O.D.: 12 13/32 (315.1)
I.D.: 8 3/16 (208.0) One End
Height: 15 1/2 (393.7)

RS3517



Radial Seal Outer Air Element
Fits: Ford, Freightliner Trucks;
 Case-International, Doosan, John Deere,
 Komatsu, New Holland Equipment
Use With: RS3717
Replaces: Donaldson P532966
O.D.: 9 9/32 (235.7)
I.D.: 5 5/32 (131.0) One End
Height: 18 15/16 (481.0)
Related To: RS3517XP (Extreme Performance
 Nano Version)

RS3513



Radial Seal Inner Air Element
Fits Inside: RS3512
Fits: Caterpillar Equipment
Replaces: Caterpillar 6I2508
O.D.: 8 5/16 (211.1)
I.D.: 6 1/32 (153.2) One End
Height: 11 3/4 (298.5)

RS3517XP



Extreme Performance Nano Radial Seal Outer
 Air Element
Fits: Ford, Freightliner Trucks;
 Case-International, Doosan, John Deere,
 Komatsu, New Holland Equipment
Use With: RS3717
Replaces: Donaldson P532966
O.D.: 9 9/32 (235.7)
I.D.: 5 5/32 (131.0) One End
Height: 18 15/16 (481.0)
Related To: RS3517 (Standard Media Version)

RS3514



Radial Seal Outer Air Element
Fits: Caterpillar Equipment
Use With: RS3515
Replaces: Caterpillar 6I2509
O.D.: 12 13/32 (315.1)
I.D.: 8 3/16 (208.0) One End
Height: 19 1/32 (483.4)
Related To: RS3514XP (Extreme Performance
 Nano Version)

RS3518



Radial Seal Outer Air Element
Fits: Ford, Freightliner, International, Sterling,
 WhiteGMC Trucks
Use With: RS3519
Replaces: Ford F1HZ-9601-B; GMC 25177196;
 International 3520400-C1; White 22-0013212
O.D.: 12 31/32 (329.4)
I.D.: 6 13/16 (173.0) One End
Height: 15 1/4 (387.4)
Related To: RS30187XP (Premium Housing
 Gasket)

RS3514XP



Extreme Performance Nano Radial Seal Outer
 Air Element
Fits: Caterpillar Equipment
Use With: RS3515
Replaces: Caterpillar 6I2509
O.D.: 12 13/32 (315.1)
I.D.: 8 3/16 (208.0) One End
Height: 19 1/32 (483.4)
Related To: RS3514 (Standard Media Version)

RS3518XP



Extreme Performance Nano Radial Seal Outer
 Air Element
Fits: Autocar, Ford, Freightliner, International,
 Peterbilt, Sterling, Volvo, White/GMC Trucks;
 Mercedes-Benz Latin America Buses; Taylor
 Sprayers
Use With: RS3519
Replaces: Donaldson DBA5069; Fleetguard
 AF25139M
O.D.: 12 31/32 (329.4)
I.D.: 6 13/16 (173) One End
Height: 15 1/4 (387.4)
Related To: RS3518 (Standard Gasket Version)

RS3515



Radial Seal Inner Air Element
Fits Inside: RS3514, RS3514XP
Fits: Caterpillar Equipment
Replaces: Caterpillar 6I2510
O.D.: 8 5/16 (211.1)
I.D.: 6 1/32 (153.2) One End
Height: 15 7/32 (386.6)

RS3519



Radial Seal Inner Air Element
Fits Inside: RS3518
Fits: Freightliner, Sterling, WhiteGMC Trucks
Replaces: Air-Refiner ARM52-7683
O.D.: 6 7/8 (174.6)
I.D.: 5 5/32 (131.0) One End
Height: 14 13/32 (365.9)

Measurements Are Shown In Inches And (Millimeters)

 **WARNING:** These products can expose you to chemicals, including Diisononyl Phthalate, Carbon black extracts, Nickel, 1,3 Butadiene, Ethylene Oxide, Epichlorohydrin, which are known to the State of California to cause cancer, and Bisphenol, Ethylene Glycol, Ethylene Oxide, 1,3 Butadiene, Epichlorohydrin, which are known to the State of California to cause birth defects or other reproductive harm. For more information go to www.P65Warnings.ca.gov.

RS3520



Radial Seal Outer Air Element
Fits: Freightliner Trucks
Use With: RS3521
Replaces: Donaldson P526678
O.D.: 9 9/32 (235.7)
I.D.: 5 5/32 (131.0) One End
Height: 15 (381.0)

RS3531



Radial Seal Inner Air Element
Fits Inside: RS3530, RS3530XP
Fits: International Buses, Trucks;
 John Deere Equipment
Replaces: International 2022289-C1;
 John Deere RE63932
O.D.: 6 7/8 (174.6)
I.D.: 5 5/32 (131.0) One End
Height: 17 23/32 (450.1)

RS3521



Radial Seal Inner Air Element
Fits Inside: RS3520
Fits: Freightliner Trucks
Replaces: Donaldson P529548
O.D.: 5 1/4 (133.4)
I.D.: 3 23/32 (94.5) One End
Height: 14 7/32 (361.2)

RS3532



Radial Seal Outer Air Element
Fits: John Deere Equipment
Use With: RS3533
Replaces: John Deere RE34966
O.D.: 9 9/32 (235.7)
I.D.: 5 5/32 (131.0) One End
Height: 15 5/8 (396.9)

RS3528



Radial Seal Outer Air Element
Fits: Caterpillar, Daewoo Equipment
Use With: RS3529
Replaces: Caterpillar 611450; Daewoo D141107
O.D.: 8 5/32 (207.2)
I.D.: 4 3/16 (106.4) One End
Height: 6 5/8 (168.3)

RS3533



Radial Seal Inner Air Element
Fits Inside: RS3532
Fits: John Deere Equipment
Replaces: John Deere RE34967
O.D.: 5 1/4 (133.4)
I.D.: 3 23/32 (94.5) One End
Height: 14 27/32 (377.0)

RS3529



Radial Seal Inner Air Element
Fits Inside: RS3528
Fits: Caterpillar, Daewoo Equipment
Replaces: Caterpillar 611451; Daewoo D141106
O.D.: 4 1/4 (108.0)
I.D.: 2 3/4 (69.9) One End
Height: 5 27/32 (148.4)

RS3534



Radial Seal Outer Air Element
Contains: 4 5/8 Inch Dust Ejector Hole
Fits: Kenworth, Peterbilt, Western Star Trucks
Replaces: Donaldson P534925
O.D.: 12 3/32 (332.6)
I.D.: 7 3/8 (187.3) One End
Height: 25 13/16 (655.6)
F. Gskt: [2] Included

RS3530



Radial Seal Outer Air Element
Fits: International Trucks; John Deere
 Equipment
Use With: RS3531
Replaces: International 2005895-C1;
 John Deere RE63931
O.D.: 12 31/32 (329.4)
I.D.: 6 13/16 (173.0) One End
Height: 18 5/8 (473.1)
Related To: RS3530XP (Extreme Performance
 Nano Media)

RS3535



Radial Seal Inner Air Element
Fits Inside: RS3538
Fits: Hitachi, John Deere Equipment
Replaces: Hitachi 4286130
O.D.: 5 1/4 (133.4)
I.D.: 3 23/32 (94.5) One End
Height: 13 27/32 (351.6)

RS3530XP



Extreme Performance Nano Radial Seal Outer
 Air Element
Fits: International Trucks; John Deere
 Equipment
Use With: RS3531
Replaces: International 2005895-C1;
 John Deere RE63931
O.D.: 12 31/32 (329.4)
I.D.: 6 13/16 (173.0) One End
Height: 18 5/8 (473.1)
Related To: RS3530 (Standard Media Version)

RS3536



Radial Seal Outer Air Element
Fits: Barber-Greene, Caterpillar Equipment
Use With: RS3537
Replaces: Caterpillar 102-9388
O.D.: 8 5/32 (207.2)
I.D.: 4 3/16 (106.4) One End
Height: 7 1/2 (190.5)

Measurements Are Shown In Inches And (Millimeters)

WARNING: These products can expose you to chemicals, including Diisononyl Phthalate, Carbon black extracts, Nickel, 1,3 Butadiene, Ethylene Oxide, Epichlorohydrin, which are known to the State of California to cause cancer, and Bisphenol, Ethylene Glycol, Ethylene Oxide, 1,3 Butadiene, Epichlorohydrin, which are known to the State of California to cause birth defects or other reproductive harm. For more information go to www.P65Warnings.ca.gov.

RS3537



Radial Seal Inner Air Element
Fits Inside: RS3536
Fits: Barber-Greene, Caterpillar Equipment
Replaces: Caterpillar 102-9387
O.D.: 4 1/4 (108.0)
I.D.: 2 3/4 (69.9) One End
Height: 6 21/32 (169.1)

RS3542



Radial Seal Outer Air Element
Fits: Bobcat, Case, Caterpillar, Ford, J.C. Bamford, John Deere, Landini, Massey Ferguson, New Holland, Thomas, Volvo Equipment; Ingersoll-Rand Compressors
Use With: RS3543
Replaces: Case 222425A1; J.C. Bamford 32/919001; Massey Ferguson 3540046-M1; Melroe-Bobcat 6666375; Thomas 42402
O.D.: 5 13/32 (137.3)
I.D.: 3 3/16 (81.0) One End
Height: 12 31/32 (329.4)
Related To: RS4578 (Flame Retardant Media)

RS3538



Radial Seal Outer Air Element
Fits: Hitachi, John Deere Equipment
Use With: RS3535
Replaces: Hitachi 4286128
O.D.: 9 9/32 (235.7)
I.D.: 5 5/32 (131.0) One End
Height: 14 19/32 (370.7)

RS3543



Radial Seal Inner Air Element
Fits Inside: RS3542
Fits: Bobcat, Case, Ford, J.C. Bamford, John Deere, Landini, Massey Ferguson, New Holland, Thomas, Volvo Equipment
Replaces: Case 222429A1; Fiat 1930588; John Deere AP33331; Massey Ferguson 3540047-M1; Melroe-Bobcat 6666376; New Holland 86982523; Thomas 42403
O.D.: 3 5/16 (84.1)
I.D.: 2 15/32 (62.7) One End
Height: 12 9/16 (319.1)

RS3539



Radial Seal Outer Air Element
Notes: Inside-Out Flow Direction
Contains: 3 3/4 Inch Dust Ejector Hole
Fits: Freightliner, Kenworth, Peterbilt, Western Star Trucks
Replaces: Donaldson P534816
O.D.: 11 13/32 (288.9)
I.D.: 6 13/16 (173.0) & 6 23/32 (170.7)
Height: 23 23/32 (602.5)
F. Gskt: G501-AF
Related To: RS3539XP (Extreme Performance Nano Version)

RS3544



Radial Seal Outer Air Element
Fits: Case, Caterpillar, Gehl, John Deere, New Holland, Vermeer, Volvo Equipment
Use With: RS3545
Replaces: Case 222421A1; Caterpillar 110-6326; Gehl L99453; John Deere AT171853; New Holland 86982524
O.D.: 6 1/2 (165.1)
I.D.: 3 9/16 (90.5) One End
Height: 14 1/32 (356.4)
Related To: RS5517 (Flame Retardant Media)

RS3539XP



Extreme Performance Nano Radial Seal Outer Air Element
Notes: Inside-Out Flow Direction
Contains: 3 3/4 Inch Dust Ejector Hole
Fits: Freightliner, Kenworth, Peterbilt, Western Star Trucks
Replaces: Donaldson EAF5100, DBA5100
O.D.: 11 13/32 (289.7)
I.D.: 3 25/32 (96.0) & 6 23/32 (170.7)
Height: 23 23/32 (602.5)
F. Gskt: G501-AF
Related To: RS3539 (Standard Media Version)

RS3545



Radial Seal Inner Air Element
Fits Inside: RS3544, RS5517
Fits: Case, Caterpillar, Gehl, John Deere, New Holland, Vermeer, Volvo Equipment
Replaces: Case 222422A1; Caterpillar 110-6331; Gehl L99967; John Deere AT171854; New Holland 86982525
O.D.: 3 21/32 (92.9)
I.D.: 2 7/8 (73.0) One End
Height: 13 1/2 (342.9)

RS3540



Radial Seal Outer Air Element
Fits: Case, Caterpillar, Hitachi, John Deere Equipment
Use With: RS3541
Replaces: Caterpillar 135-5788; Hitachi 4283861
O.D.: 8 5/32 (207.2)
I.D.: 4 27/32 (123.0) One End
Height: 14 19/32 (370.7)

RS3547



Radial Seal Inner Air Element
Fits Inside: RS3954
Fits: Bomag, Gehl, New Holland Equipment
Replaces: Fiat 1930592; Gehl 32120111002
O.D.: 2 13/32 (61.1)
I.D.: 1 3/4 (44.5) One End
Height: 11 7/16 (290.5)

RS3541



Radial Seal Inner Air Element
Fits Inside: RS3540
Fits: Case, Caterpillar, Hitachi, John Deere Equipment
Replaces: Caterpillar 135-5787; Hitachi 4287060
O.D.: 4 15/16 (125.4)
I.D.: 3 31/32 (100.8) One End
Height: 13 15/16 (354.0)

RS3548



Radial Seal Outer Air Element
Fits: Ford, GMC, Isuzu, Kenworth, Sterling Trucks; John Deere Equipment
Use With: RS3722
Replaces: John Deere RE51629
O.D.: 10 31/32 (278.6)
I.D.: 5 13/16 (147.6) One End
Height: 15 5/8 (396.9)
Related To: RS3548XP (Extreme Performance Nano Version)

Measurements Are Shown In Inches And (Millimeters)

WARNING: These products can expose you to chemicals, including Diisononyl Phthalate, Carbon black extracts, Nickel, 1,3 Butadiene, Ethylene Oxide, Epichlorohydrin, which are known to the State of California to cause cancer, and Bisphenol, Ethylene Glycol, Ethylene Oxide, 1,3 Butadiene, Epichlorohydrin, which are known to the State of California to cause birth defects or other reproductive harm. For more information go to www.P65Warnings.ca.gov.

RS3548XP



Extreme Performance Nano Radial Seal Outer Air Element

Fits: Ford, GMC, Isuzu, Kenworth, Sterling Trucks; John Deere Equipment
Use With: RS3722
Replaces: John Deere RE51629
O.D.: 10 31/32 (278.6)
I.D.: 5 13/16 (147.6) One End
Height: 15 5/8 (396.9)
Related To: RS3548 (Standard Media Version)

PA3556



Replacement for Ecolite Air Element in Disposable Housing

Fits: Farr Optional Housings
Replaces: Farr 114500-003
O.D.: 9 5/8 (244.5)
I.D.: 5 (127.0) One End
Height: 20 1/8 (511.2)

RS3549



Radial Seal Outer Air Element

Contains: Flame Retardant Media
Fits: Clark, John Deere Equipment
Use With: RS3703, RS3747
Replaces: Clark 2791707
O.D.: 5 1/32 (127.8)
I.D.: 3 5/32 (80.2) One End
Height: 12 5/16 (312.7)
Related To: RS3702 (without Flame Retardant Media)

PA3557-FN



Outer Air Element with Fins

Fits: John Deere Tractors
Use With: PA3632
Replaces: John Deere AM108184
O.D.: 4 3/32 (104.0)
 Fins 5 1/8 (130.2)
I.D.: 25/32 (19.8) & 2 15/32 (62.7)
Height: 8 3/8 (212.7)
A. Gskt: [1] Attached
F. Gskt: G103-N

RS3550



Radial Seal Air Element

Fits: Dodge Light-Duty Trucks
Replaces: Chrysler 4713953
O.D.: 8 5/32 (207.2)
I.D.: 4 3/16 (106.4) One End
Height: 10 (254.0)

PA3558



Outer Air Element

Fits: R.V.I. Buses, Trucks
Use With: PA3566
Replaces: Renault 5010064371
O.D.: 12 1/16 (306.4)
I.D.: 11/16 (17.5) & 7 11/16 (195.3)
Height: 15 11/16 (398.5)
A. Gskt: [1] Attached
F. Gskt: G103-N

PA3551



Inner Air Element

Fits Inside: PA2781
Replaces: Fleetguard AF4771
O.D.: 9 11/16 (246.1)
I.D.: 21/32 (16.7) & 8 1/8 (206.4)
Height: 17 13/16 (452.4)
A. Gskt: [1] Attached
F. Gskt: G103-N

PA3559



Air Element

Fits: Metroplex Dust Collectors
Replaces: Metroplex M00-709-102; Reed 70814
O.D.: 12 (304.8)
I.D.: 7 11/16 (195.3)
Height: 21 (533.4)
A. Gskt: [2] Attached

PA3554



Replacement for Ecolite Air Element in Disposable Housing

Fits: Farr Optional Housings
Replaces: Farr 114500-001
O.D.: 7 1/8 (181.0)
I.D.: 3 (76.2) One End
Height: 14 3/16 (360.4)

PA3560



Air Element

Notes: Inside-Out Flow Direction
Fits: Wheelabrator Dust Collectors
Replaces: TDC 10000045; Wheelabrator 661394
O.D.: 12 3/4 (323.9)
 Flange 13 7/8 (352.4)
I.D.: 8 7/16 (214.3) One End
Height: 26 5/8 (676.3)
A. Gskt: [1] Attached

PA3555



Replacement for Ecolite Air Element in Disposable Housing

Fits: Farr Optional Housings
Replaces: Farr 114500-002
O.D.: 8 1/8 (206.4)
I.D.: 4 (101.6) One End
Height: 17 3/16 (436.6)

PA3562



Air Element

Contains: Flame Retardant Media
Replaces: Donaldson P823295
O.D.: 7 15/16 (201.6)
I.D.: 11/16 (17.5) & 3 9/16 (90.5)
Height: 20 1/4 (514.4)
A. Gskt: [1] Attached
F. Gskt: G103-N

Measurements Are Shown In Inches And (Millimeters)

WARNING: These products can expose you to chemicals, including Diisononyl Phthalate, Carbon black extracts, Nickel, 1,3 Butadiene, Ethylene Oxide, Epichlorohydrin, which are known to the State of California to cause cancer, and Bisphenol, Ethylene Glycol, Ethylene Oxide, 1,3 Butadiene, Epichlorohydrin, which are known to the State of California to cause birth defects or other reproductive harm. For more information go to www.P65Warnings.ca.gov.

PA3563



Air Element

Contains: Flame Retardant Media
Fits: Torit DownFlo EAC Environmental Dust Collectors
Replaces: Torit 8PP40766-00
O.D.: 12 25/32 (324.6)
I.D.: 8 11/32 (211.9)
Height: 26 1/2 (673.1)
A. Gskt: [1] Attached

PA3573



Air Element

Replaces: Flxible 9754091
O.D.: 13 7/8 (352.4)
I.D.: 9 13/32 (238.9) One End
Height: 17 (431.8)
A. Gskt: [2] Attached
F. Gskt: [1] Included

PA3565



Inner Air Element

Fits Inside: PA3472, PA3472-FN
Fits: John Deere Lawn & Garden Mowers, Tractors
Replaces: John Deere M94734
O.D.: 2 (50.8)
 Flange 3 1/8 (79.4)
I.D.: 21/32 (16.7) & 1 17/32 (38.9)
Height: 6 1/4 (158.8)
A. Gskt: [1] Attached
F. Gskt: G103-N

PA3576



Air Element

Fits: Wheelabrator Dust Collectors
Replaces: Wheelabrator 8036082
O.D.: 12 3/4 (323.9)
 Flange 13 7/8 (352.4)
I.D.: 8 3/8 (212.7) One End
Height: 36 5/8 (930.3)
A. Gskt: [1] Attached

PA3566



Inner Air Element

Fits Inside: PA3558, PA3688
Fits: R.V.I. Buses, Trucks
Replaces: Renault 5010064372
O.D.: 6 3/8 (161.9)
 Flange 7 1/2 (190.5)
I.D.: 5/8 (15.9) & 5 1/4 (133.4)
Height: 14 7/8 (377.8)
A. Gskt: [1] Attached
F. Gskt: G103-N

PA3578



Inner Air Element

Fits Inside: PA2784
Fits: Daewoo, Kawasaki, Komatsu Equipment; Mitsubishi Trucks
Replaces: Komatsu 600-181-6730
O.D.: 5 1/4 (133.4)
I.D.: 21/32 (16.7) & 4 1/8 (104.8)
Height: 16 11/32 (415.1)
A. Gskt: [1] Attached
F. Gskt: G103-N

PA3568



Air Element

Fits: Wheelabrator Dust Collectors
Replaces: Wheelabrator 833600882
O.D.: 12 3/4 (323.9)
 Flange 15 x 16 1/2 (381.0 x 419.1)
I.D.: 8 3/8 (212.7) One End
Height: 36 5/8 (930.3)
A. Gskt: [1] Attached

PA3579



Air Element

Notes: Inside-Out Flow Direction
Fits: Torit Small TD Dust Collectors; Some Small Gas Turbines
Replaces: Torit 8PP18583-00
O.D.: 12 3/4 (323.9)
I.D.: 17/32 (13.5) & 8 11/32 (211.9)
Height: 22 1/2 (571.5)
A. Gskt: [1] Attached
F. Gskt: [1] Included

PA3569



Air Element

Fits: Torit DownFlo II Dust Collectors
Replaces: Heavy Duty Air A09268
O.D.: 13 13/16 (350.8)
I.D.: 9 1/2 (241.3)
Height: 28 1/2 (723.9)
A. Gskt: [1] Attached

PA3580



Air Element

Contains: Flame Retardant Media
Fits: Farr Mark III Dust Collectors
Replaces: Farr 72518-004
O.D.: 12 3/4 (323.9)
 Flange 15 31/32 x 14 11/32 (405.6 x 364.3)
I.D.: 8 11/32 (211.9) One End
Height: 26 5/8 (676.3)
A. Gskt: [1] Attached
Related To: PA2988 (without Flame Retardant Media)

PA3572



Air Element

Fits: M.A.N. Buses, Trucks
Replaces: M.A.N. 90-80115.5191
O.D.: 9 17/32 (242.1)
I.D.: 5 5/32 (131.0) One End
Height: 19 1/2 (495.3)
A. Gskt: [1] Attached

PA3581



Air Element

Fits: Torit Small TD Dust Collectors
Replaces: Torit 8PP21967-00
O.D.: 7 15/16 (201.6)
I.D.: 11/16 (17.5) & 3 9/16 (90.5)
Height: 22 1/2 (571.5)
A. Gskt: [1] Attached
F. Gskt: [1] Included

Measurements Are Shown In Inches And (Millimeters)

WARNING: These products can expose you to chemicals, including Diisononyl Phthalate, Carbon black extracts, Nickel, 1,3 Butadiene, Ethylene Oxide, Epichlorohydrin, which are known to the State of California to cause cancer, and Bisphenol, Ethylene Glycol, Ethylene Oxide, 1,3 Butadiene, Epichlorohydrin, which are known to the State of California to cause birth defects or other reproductive harm. For more information go to www.P65Warnings.ca.gov.

PA3584

Air Element



Fits: Gardner Denver Rock Drills;
Tipton Filter Clone Dust Collectors
Replaces: Tipton FC15-1001
O.D.: 16 5/8 (422.3)
I.D.: 12 (304.8)
Height: 25 (635.0)
A. Gskt: [2] Attached

PA3600

Air Element



Fits: Hino Trucks
Replaces: Hino 17801-2810
O.D.: 9 7/32 (234.2)
I.D.: 21/32 (16.7) & 4 27/32 (123.0)
Height: 18 1/2 (469.9)
A. Gskt: [1] Attached
F. Gskt: G103-N

PA3587

Air Element



Fits: Ingersoll-Rand Dust Collectors
Replaces: Ingersoll-Rand 36858405
O.D.: 13 13/16 (350.8)
I.D.: 9 1/2 (241.3)
Height: 27 1/2 (698.5)
A. Gskt: [1] Attached

PA3601

Inner Air Element



Contains: Insert Thread: M16 x 2.0
Fits Inside: PA2845
Fits: John Deere Tractors
Replaces: John Deere AL67195
O.D.: 3 11/32 (84.9)
Flange 4 3/32 (104.0)
I.D.: 5/8 (15.9) & 3 (76.2)
Height: 9 1/4 (235.0)

PA3588

Air Element



Contains: Flame Retardant Media
Fits: Torit Dust Collectors
Replaces: Torit 8PP25370-00
O.D.: 13 13/16 (350.8)
I.D.: 9 1/2 (241.3)
Height: 22 1/2 (571.5)
A. Gskt: [1] Attached
Related To: PA5699 (Different Media)

PA3602

Air Element



Fits: Industrial Dust Collectors
Replaces: Air Refiner ARM1416R
O.D.: 13 13/16 (350.8)
I.D.: 9 1/2 (241.3)
Height: 15 3/4 (400.1)

PA3595

Air Element with Twist Lock Mounting Tabs



Fits: Pneumafil ABB Dust Collectors
Replaces: Pneumafil A38738C-2
O.D.: 12 3/4 (323.9)
I.D.: 8 3/8 (212.7) One End
Height: 34 5/8 (879.5)
A. Gskt: [1] Attached

PA3604

Air Element



Notes: Inside-Out Flow Direction
Fits: Industrial Dust Collectors
Replaces: Air Refiner ARM17057
O.D.: 13 27/32 (351.6)
I.D.: 3/4 (19.1) & 11 1/8 (282.6)
Height: 14 (355.6)
F. Gskt: [1] Included

PA3597

Air Element



Fits: Iveco Trucks
Replaces: Iveco 1905983
O.D.: 9 9/16 (242.9)
I.D.: 13/32 (10.3) & 5 3/16 (131.8)
Height: 11 23/32 (297.7)
A. Gskt: [1] Attached
F. Gskt: [1] Washer

PA3605

Air Element



Fits: M.A.N. Buses, Trucks
Replaces: M.A.N. 90.80115.5196
O.D.: 8 15/16 (227.0)
I.D.: 4 19/32 (116.7) One End
Height: 15 (381.0)
A. Gskt: [1] Attached

PA3598

Air Element



Contains: Flame Retardant Media
Fits: Airflow PC Dust Collectors
Replaces: Airflow 7FRO-2912
O.D.: 12 3/32 (307.2)
I.D.: 7 11/16 (195.3) One End
Height: 12 (304.8)
A. Gskt: [1] Attached

PA3606

Outer Air Element



Fits: Claas, Liebherr, New Holland Equipment;
Iveco, M.A.N. Trucks
Use With: PA3787
Replaces: Claas 773670; M.A.N. 81.08401.6082
O.D.: 12 29/32 (327.8)
I.D.: 13/32 (10.3) & 8 1/2 (215.9)
Height: 24 1/4 (616.0)
A. Gskt: [1] Attached
F. Gskt: [1] Included

Measurements Are Shown In Inches And (Millimeters)

WARNING: These products can expose you to chemicals, including Diisononyl Phthalate, Carbon black extracts, Nickel, 1,3 Butadiene, Ethylene Oxide, Epichlorohydrin, which are known to the State of California to cause cancer, and Bisphenol, Ethylene Glycol, Ethylene Oxide, 1,3 Butadiene, Epichlorohydrin, which are known to the State of California to cause birth defects or other reproductive harm. For more information go to www.P65Warnings.ca.gov.

PA3607-FN

Air Element with Fins



Fits: Sullair Compressors
Replaces: Sullair 2250044-537
O.D.: 6 3/32 (154.8)
 Fins 7 13/16 (198.4)
I.D.: 3/4 (19.1) & 3 7/8 (98.4)
Height: 12 1/2 (317.5)
A. Gskt: [1] Attached
F. Gskt: G103-N

PA3608-FN

Outer Air Element with Fins and Lid



Contains: Flame Retardant Media
Fits: Toyota Lift Trucks
Replaces: Toyota 17808-23800-71
O.D.: 5 11/32 (135.7)
 Lid 7 27/32 (199.2)
I.D.: 15/32 (11.9) & 2 5/8 (66.7)
Height: 11 7/16 (290.5)
A. Gskt: [2] Attached
F. Gskt: [1] Included

PA3609

Outer Air Element



Fits: Komatsu Equipment
Use With: PA3610
Replaces: Komatsu 600-181-8210
O.D.: 8 1/2 (215.9)
I.D.: 5/8 (15.9) & 4 5/32 (105.6)
Height: 16 3/4 (425.5)
A. Gskt: [1] Attached
F. Gskt: G103-N
Related To: PA4581 (One Closed End)

PA3610

Inner Air Element



Fits Inside: PA3609
Fits: Komatsu Equipment
Replaces: Komatsu 600-181-8310
O.D.: 4 1/8 (104.8)
I.D.: 21/32 (16.7) & 3 (76.2)
Height: 15 1/4 (387.4)
A. Gskt: [1] Attached
F. Gskt: G103-N

PA3611

Air Element



Fits: Farr-Type D Dust Collectors
Replaces: Farr 101400-1
O.D.: 12 3/4 (323.9)
 Flange 15 31/32 x 14 1/4 (405.6 x 362.0)
I.D.: 8 5/16 (211.1) One End
Height: 34 5/8 (879.5)
A. Gskt: [1] Attached

PA3612

Air Element



Fits: Atlas, Fendt, Guldner Equipment;
 Fiat Lift Trucks
Replaces: Atlas Copco 16192867;
 Fiat 9292365; Guldner 9839012
O.D.: 4 3/8 (111.1)
I.D.: 5/8 (7.9) & 1 15/16 (49.2)
Height: 8 31/32 (227.8)
A. Gskt: [1] Attached
F. Gskt: [1] Included

PA3613

Cab Air Element



Fits: Komatsu Loaders
Replaces: Komatsu 421-07-12312
Length: 10 (254.0)
Width: 6 (152.4)
Height: 2 3/16 (55.6)

PA3614

Air Element



Notes: Inside-Out Flow Direction
Contains: Flame Retardant Media
Fits: Torit DownFlo II Series Dust Collectors
Replaces: Torit 8PP42058-00
O.D.: 13 13/16 (350.8)
I.D.: 9 1/2 (241.3)
Height: 26 1/2 (673.1)
A. Gskt: [1] Attached
Related To: PA3463 (Standard Media Version)

PA3627

Air Element



Fits: Industrial Applications
Replaces: Heavy Duty Air A1234-1
O.D.: 7 15/16 (201.6)
I.D.: 1/2 (12.7) & 3 9/16 (90.5)
Height: 10 1/2 (266.7)
A. Gskt: [1] Attached
F. Gskt: [1] Included

PA3628

Woven Aluminum Air Element



Fits: Industrial Applications
Replaces: Heavy Duty Air A09214
O.D.: 6 23/32 (170.7)
I.D.: 5 1/2 (139.7)
Height: 2 3/4 (69.9)

PA3629

Outer Air Element with Lid



Fits: Caterpillar Equipment
Use With: PA1911
Replaces: Caterpillar 4I7575, 96-4175
O.D.: 7 3/8 (187.3)
 Lid 9 9/32 (235.7)
I.D.: 21/32 (16.7) & 4 11/16 (119.1)
Height: 15 1/2 (393.7)
A. Gskt: [2] Attached
F. Gskt: G103-N

PA3630-FN

Outer Air Element with Fins



Fits: Kobelco, MDI/Yutani Equipment
Use With: PA3631
Replaces: Kobelco 2446R255-S5
O.D.: 6 7/8 (174.6)
 Fins 8 3/4 (222.3)
I.D.: 21/32 (16.7) & 4 3/16 (106.4)
Height: 20 1/2 (520.7)
A. Gskt: [1] Attached
F. Gskt: G103-N

PA3631

Inner Air Element



Fits Inside: PA3630-FN
Fits: Kobelco, MDI/Yutani Equipment
Replaces: Kobelco 2446R255-S6
O.D.: 4 3/32 (104.0)
 Flange 4 15/16 (122.2)
I.D.: 25/32 (19.8) & 3 5/8 (92.1)
Height: 19 5/16 (490.5)
A. Gskt: [1] Attached
F. Gskt: G103-N

Measurements Are Shown In Inches And (Millimeters)



WARNING: These products can expose you to chemicals, including Diisononyl Phthalate, Carbon black extracts, Nickel, 1,3 Butadiene, Ethylene Oxide, Epichlorohydrin, which are known to the State of California to cause cancer, and Bisphenol, Ethylene Glycol, Ethylene Oxide, 1,3 Butadiene, Epichlorohydrin, which are known to the State of California to cause birth defects or other reproductive harm. For more information go to www.P65Warnings.ca.gov.

PA3632

Inner Air Element



Fits Inside: PA3557-FN
Fits: John Deere Equipment
Replaces: John Deere AM108185
O.D.: 2 3/8 (60.3)
 Flange 4 1/2 (114.3)
I.D.: 21/32 (16.7) & 2 (50.8)
Height: 7 3/16 (182.6)
A. Gskt: [1] Attached
F. Gskt: G103-N

PA3640

Air Element



Fits: Wheelabrator WTB-3 Tumbblast Machine
Replaces: Wheelabrator 713200881
O.D.: 7 15/16 (201.6)
I.D.: 11/16 (17.5) & 3 9/16 (90.5)
Height: 32 1/2 (825.5)
A. Gskt: [1] Attached
F. Gskt: G103-N

PA3633

Air Element



Fits: Caterpillar Generators
Use With: PA3633 FOAM
Replaces: Caterpillar 4W5452, 105-9741
O.D.: 22 (558.8)
I.D.: 15 9/16 (395.3) One End
Height: 24 3/4 (628.7)
A. Gskt: [1] Attached

PA3643

Hydraulic Tank Breather



Fits: Caterpillar Equipment, Off-Highway Trucks; Generac Generators
Replaces: Caterpillar 8X4575
O.D.: 4 19/32 (116.7)
I.D.: 1 5/8 (41.3) One End
Height: 5 7/8 (149.2)

PA3633 FOAM

Foam Blanket for PA3633



Use With: PA3633
Replaces: Caterpillar 4W7103
Length: 68 13/16 (1747.8)
Width: 23 1/2 (596.9)

PA3644

Conical-Shaped Air Element



Fits: Kenworth Trucks
Replaces: Fleetguard AF25092M
O.D.: 8 5/32 (207.2) to 10 7/8 (276.2)
I.D.: 3 31/32 (100.8) & 6 23/32 (170.7)
Height: 24 3/4 (628.7)
A. Gskt: [2] Attached

PA3636

Air Element



Fits: Hitachi Excavators
Replaces: Hitachi 4206099
O.D.: 6 3/32 (154.8)
I.D.: 3/4 (19.1) & 4 3/32 (104.0)
Height: 12 3/8 (314.3)
A. Gskt: [1] Attached
F. Gskt: G103-N

PA3645

Air Element



Notes: Inside-Out Flow Direction
Fits: Stork Model Laser Engraver
O.D.: 9 7/32 (234.2)
I.D.: 21/32 (16.7) & 4 27/32 (123.0)
Height: 11 1/2 (292.1)
A. Gskt: [1] Attached
F. Gskt: G103-N

PA3637

Air Element



Fits: Industrial Applications
Replaces: Donaldson P150232
O.D.: 17 5/8 (447.7)
I.D.: 11 1/32 (280.2)
Height: 23 17/32 (597.7)
A. Gskt: [1] Attached

PA3650

Outer Air Element with Lid



Contains: Flame Retardant Media
Fits: Komatsu Equipment
Use With: PA4548
Replaces: Komatsu 600-181-6350
O.D.: 4 7/8 (123.8)
 Lid 6 5/16 (160.3)
I.D.: 21/32 (16.7) & 3 7/32 (81.8)
Height: 10 1/4 (260.4)
A. Gskt: [1] Attached
F. Gskt: G103-N

PA3638

Air Element



Fits: Wheelabrator Dust Collectors
Replaces: Wheelabrator 213600881
O.D.: 12 25/32 (324.6)
I.D.: 17/32 (13.5) & 8 11/32 (211.9)
Height: 36 1/2 (927.1)
A. Gskt: [1] Attached
F. Gskt: [1] Included

PA3651-FN

Outer Air Element with Fins and Lid



Contains: Flame Retardant Media
Fits: Caterpillar Lift Trucks
Replaces: Caterpillar 101-5412
O.D.: 4 3/32 (104.0)
 Lid 5 31/32 (151.6)
I.D.: 5/8 (15.9) & 2 7/32 (56.4)
Height: 9 1/8 (231.8)
A. Gskt: [2] Attached
F. Gskt: G103-N

Measurements Are Shown In Inches And (Millimeters)

WARNING: These products can expose you to chemicals, including Diisononyl Phthalate, Carbon black extracts, Nickel, 1,3 Butadiene, Ethylene Oxide, Epichlorohydrin, which are known to the State of California to cause cancer, and Bisphenol, Ethylene Glycol, Ethylene Oxide, 1,3 Butadiene, Epichlorohydrin, which are known to the State of California to cause birth defects or other reproductive harm. For more information go to www.P65Warnings.ca.gov.

PA3652



Outer Air Element with Lid
Fits: Fiat-Allis, Liebherr Equipment
Use With: PA3847
Replaces: Fiat 700052343; Liebherr 7403953
O.D.: 10 1/2 (266.7)
 Lid 12 1/2 (317.5)
I.D.: 21/32 (16.7) & 6 (152.4)
Height: 16 1/2 (419.1)
A. Gskt: [1] Attached
F. Gskt: [1] Included, [1] Wing Nut

PA3653



Outer Air Element
Fits: Fiat-Allis Equipment
Use With: PA3654
Replaces: Fiat 8322128
O.D.: 8 3/4 (222.3)
I.D.: 6 1/16 (154.0)
Height: 8 1/16 (204.8)
A. Gskt: [2] Attached

PA3654



Inner Air Element
Fits Inside: PA3653
Fits: Fiat-Allis Equipment
Replaces: Fiat 8322129
O.D.: 5 3/8 (136.5)
I.D.: 3 15/16 (100.0)
Height: 6 7/8 (174.6)
A. Gskt: [2] Attached

PA3655



Outer Air Element
Fits: Ford, New Holland Equipment
Use With: PA3656
Replaces: New Holland 9846494
O.D.: 9 29/32 (251.6)
I.D.: 11/16 (17.5) & 6 1/16 (154.0)
Height: 16 (406.4)
A. Gskt: [1] Attached
F. Gskt: G103-N

PA3656



Inner Air Element
Fits Inside: PA3655
Fits: Ford, New Holland Equipment
Replaces: New Holland 9846495
O.D.: 5 15/16 (150.8)
I.D.: 21/32 (16.7) & 4 29/32 (124.6)
Height: 15 (381.0)
A. Gskt: [1] Attached
F. Gskt: G103-N

PA3657



Inner Air Element
Fits Inside: PA3448
Fits: Hino Trucks
Replaces: Hino 17801-2610
O.D.: 4 9/16 (115.9)
 Flange 5 23/32 (145.3)
I.D.: 21/32 (16.7) & 3 7/16 (87.3)
Height: 12 (304.8)
A. Gskt: [1] Attached
F. Gskt: G103-N

PA3658



Cab Air Element
Fits: Caterpillar Equipment
Replaces: Caterpillar 7T1889
Length: 23 1/2 (596.9)
Width: 6 (152.4)
Height: 2 9/16 (65.1)
A. Gskt: [1] Attached

PA3660-FN



Air Element with Fins
Fits: Mitsubishi Trucks
Replaces: Mitsubishi MB120298
O.D.: 7 15/16 (201.6)
 Fins 9 31/32 (253.2)
I.D.: 1/2 (12.7) & 4 31/32 (126.2)
Height: 7 3/8 (187.3)
A. Gskt: [1] Attached
F. Gskt: [1] Included

PA3664-FN



Outer Air Element with Fins and Lid
Fits: Bomag, Komatsu, Kubota Equipment
Replaces: Kubota 15852-11082
O.D.: 3 9/32 (83.3)
 Lid 5 (127.0)
I.D.: 13/32 (10.3) & 1 27/32 (46.8)
Height: 7 1/4 (184.2)
A. Gskt: [2] Attached
F. Gskt: [1] Included

PA3667-FN



Air Element with Fins
Contains: Flame Retardant Media
Fits: Toyota Lift Trucks
Replaces: Toyota 17752-20540-71
O.D.: 5 1/4 (133.4)
 Fins 6 3/8 (161.9)
I.D.: 21/32 (16.7) & 2 5/8 (66.7)
Height: 11 5/16 (287.3)
A. Gskt: [1] Attached
F. Gskt: G103-N
Related To: PA1667-FN (without Flame Retardant Media)

PA3668



Inner Air Element
Fits Inside: LL2676, PA2676, PA2676XP
Fits: Hitachi, John Deere Equipment; Komatsu, Nissan Trucks
Replaces: John Deere AT201036
O.D.: 7 1/4 (184.2)
I.D.: 11/16 (17.5) & 6 3/16 (157.2)
Height: 18 1/2 (469.9)
A. Gskt: [1] Attached
F. Gskt: G103-N

PA3669-FN



Outer Air Element with Fins and Lid
Fits: Agco, Braud, Case, Ford, Massey Ferguson, Same, White Equipment
Use With: PA2419
Replaces: Case P1950555; New Holland 1930765; Same 242491300
O.D.: 6 3/32 (154.8)
 Lid 8 3/8 (212.7)
I.D.: 21/32 (16.7) & 3 15/32 (88.1)
Height: 15 1/2 (393.7)
A. Gskt: [1] Attached
F. Gskt: [1] Included, [1] Wing Nut

Measurements Are Shown In Inches And (Millimeters)

WARNING: These products can expose you to chemicals, including Diisononyl Phthalate, Carbon black extracts, Nickel, 1,3 Butadiene, Ethylene Oxide, Epichlorohydrin, which are known to the State of California to cause cancer, and Bisphenol, Ethylene Glycol, Ethylene Oxide, 1,3 Butadiene, Epichlorohydrin, which are known to the State of California to cause birth defects or other reproductive harm. For more information go to www.P65Warnings.ca.gov.

PA3670



Outer Air Element with Lid
Contains: Flame Retardant Media
Fits: Komatsu Equipment
Use With: PA3985
Replaces: Komatsu 600-182-1320
O.D.: 6 3/32 (154.8)
 Lid 7 5/8 (193.7)
I.D.: 2 1/32 (16.7) & 3 15/32 (88.1)
Height: 12 3/8 (314.3)
A. Gskt: [2] Attached
F. Gskt: G103-N, [1] Wing Nut

PA3679



Air Breather Element
Fits: Volvo Trucks
Replaces: Volvo 1082368-0
O.D.: 3 7/16 (87.3)
I.D.: 31/32 (24.6) One End
Height: 5 3/16 (131.8)
A. Gskt: [1] Attached

PA3671-FN



Outer Air Element with Fins
Contains: Flame Retardant Media
Fits: Kobelco, Komatsu Equipment
Use With: PA3672, PA3674
Replaces: Kobelco 2451U154-3N;
 Komatsu 600-181-7260
O.D.: 5 1/4 (133.4)
 Fins 6 11/32 (161.1)
I.D.: 2 1/32 (16.7) & 3 5/16 (84.1)
Height: 11 9/32 (286.5)
A. Gskt: [1] Attached
F. Gskt: G103-N

PA3680



Foam Cab Air Element
Fits: Caterpillar Equipment
Replaces: Caterpillar 6P1319
Length: 10 11/16 (271.5)
Width: 4 11/16 (119.1)
Height: 4 3/16 (106.4)

PA3672



Inner Air Element
Fits Inside: PA3671-FN
Replaces: Toyota 17804-23000-71
O.D.: 3 3/16 (81.0)
I.D.: 15/32 (11.9) & 2 17/32 (64.3)
Height: 10 3/8 (263.5)
A. Gskt: [1] Attached
F. Gskt: [1] Included

PA3681



Air Element
Fits: Mercedes-Benz Trucks, Vans
Replaces: Mercedes-Benz 20947304
O.D.: 7 13/16 (198.4)
I.D.: 11/32 (8.7) & 4 1/16 (103.2)
Height: 10 1/32 (254.8)
A. Gskt: [1] Attached

PA3674



Inner Air Element
Fits Inside: PA3671-FN
Fits: Komatsu, Mitsubishi Equipment
Replaces: Komatsu 600-181-7360;
 Mitsubishi 91461-11400
O.D.: 3 1/4 (82.6)
I.D.: 2 1/32 (16.7) & 2 1/8 (54.0)
Height: 9 17/32 (242.1)
A. Gskt: [1] Attached
F. Gskt: G103-N

PA3682



Inner Air Element
Fits Inside: PA2422
Fits: Deutz Tractors
Replaces: Deutz 2379161, 4308634
O.D.: 2 11/16 (68.3)
 Flange 3 5/32 (80.2)
I.D.: 5/8 (7.9) & 2 13/32 (61.1)
Height: 7 27/32 (199.2)
A. Gskt: [1] Attached

PA3675



Outer Air Element with Lid
Fits: Braud, Daewoo, Liebherr, Same
 Equipment
Use With: PA1981
Replaces: Daewoo 94749001;
 Liebherr 7405233; Same 242493801
O.D.: 10 1/32 (254.8)
 Lid 10 7/8 (276.2)
I.D.: 4 13/16 (122.2) One End
Height: 16 1/2 (419.1)
A. Gskt: [1] Attached
F. Gskt: [1] Included, [1] Wing Nut

PA3683



Inner Air Element
Fits Inside: PA2423
Fits: Deutz Tractors
Replaces: Deutz 2379163, 4308636
O.D.: 3 1/4 (82.6)
 Flange 3 17/32 (89.7)
I.D.: 7/16 (11.1) & 2 3/4 (69.9)
Height: 12 13/16 (325.4)
A. Gskt: [1] Attached

PA3676



Cab Air Element
Replaces: GMC 25043797
Length: 24 (609.6)
Width: 5 (127.0)
Height: 2 3/16 (55.6)

PA3684



Inner Air Element
Fits Inside: PA2422, PA2772
Fits: Deutz, Eicher, Fendt Tractors
Replaces: Fendt X810270072
O.D.: 3 11/32 (84.9)
I.D.: 5/8 (7.9) & 2 27/32 (72.2)
Height: 7 17/32 (191.3)
A. Gskt: [1] Attached

Measurements Are Shown In Inches And (Millimeters)

WARNING: These products can expose you to chemicals, including Diisononyl Phthalate, Carbon black extracts, Nickel, 1,3 Butadiene, Ethylene Oxide, Epichlorohydrin, which are known to the State of California to cause cancer, and Bisphenol, Ethylene Glycol, Ethylene Oxide, 1,3 Butadiene, Epichlorohydrin, which are known to the State of California to cause birth defects or other reproductive harm. For more information go to www.P65Warnings.ca.gov.

PA3685



Inner Air Element
Fits Inside: PA2423
Fits: Bomag, Deutz Equipment
Replaces: Deutz 2243522, 4930377
O.D.: 3 5/16 (84.1)
I.D.: 5/8 (7.9) & 2 27/32 (72.2)
Height: 12 5/16 (312.7)
A. Gskt: [1] Attached

PA3691



Air Element
Fits: Duraquip Equipment
Replaces: Duraquip 90603; Guardian G119253
O.D.: 9 1/4 (235.0)
I.D.: 9/16 (14.3) & 6 3/4 (171.5)
Height: 24 1/2 (622.3)
A. Gskt: [1] Attached
F. Gskt: G103-N

PA3686



Inner Air Element
Fits Inside: PA2767
Fits: Bomag, Claas, Fendt, Hanomag, International, Kobelco, Liebherr Equipment; Iveco Trucks
Replaces: Deutz 4144897
O.D.: 2 9/16 (65.1)
 Boot 3 5/32 (80.2)
I.D.: 21/32 (16.7) One End
Height: 12 27/32 (326.2)
A. Gskt: [1] Attached

PA3697



Air Element
Fits: Toyota Lift Trucks
Replaces: Toyota 17801-20540, 17801-20540-71
O.D.: 10 7/32 (259.6)
I.D.: 7 7/32 (183.4) One End
Height: 1 13/16 (46.0)
A. Gskt: [2] Attached

PA3687



Inner Air Element
Fits Inside: PA2792
Fits: Atlas, Eicher, Fendt, Hough, International, Steyr-Daimler-Puch Equipment
Replaces: International 3148080-R1; Steyr-Daimler-Benz 31100190019
O.D.: 2 13/32 (61.1)
 Boot 2 3/4 (69.9)
I.D.: 21/32 (16.7) & 2 1/16 (52.4)
Height: 11 3/16 (284.2)
A. Gskt: [1] Attached
F. Gskt: [1] Plastic Washer

PA3698



Outer Air Element
Fits: Caterpillar Equipment
Use With: PA2413
Replaces: Caterpillar 4N0326
O.D.: 6 27/32 (173.8)
I.D.: 5/8 (15.9) & 3 15/32 (88.1)
Height: 12 3/8 (314.3)
A. Gskt: [1] Attached
F. Gskt: G103-N

PA3688



Outer Air Element
Contains: Flame Retardant Media
Fits: R.V.I. Trucks
Use With: PA3566
Replaces: Renault 5010066304
O.D.: 12 1/16 (306.4)
I.D.: 11/16 (17.5) & 7 11/16 (195.3)
Height: 18 1/2 (469.9)
A. Gskt: [1] Attached
F. Gskt: G103-N

PA3699



Outer Air Element
Fits: R.V.I. Trucks
Replaces: Renault 5000751674, 5010094092, 5010094146
O.D.: 11 1/8 (282.6)
I.D.: 21/32 (16.7) & 6 23/32 (170.7)
Height: 15 5/16 (388.9)
A. Gskt: [1] Attached
F. Gskt: G103-N

PA3689



Air Element
Fits: Komatsu Equipment
Replaces: Komatsu 600-181-1680
O.D.: 6 3/8 (161.9)
I.D.: 5/8 (15.9) & 5 9/32 (134.1)
Height: 14 3/16 (360.4)
A. Gskt: [1] Attached
F. Gskt: G103-N

RS3700



Radial Seal Outer Air Element
Fits: Caterpillar Equipment
Use With: RS3701
Replaces: Caterpillar 106-3969
O.D.: 14 7/32 (361.2)
I.D.: 8 15/16 (227.0) One End
Height: 18 11/32 (465.9)
Related To: RS3700XP (Extreme Performance Nano Version)

PA3690



Outer Air Element with Lid
Fits: Lister Engines; Massey Ferguson Tractors
Use With: PA2419
Replaces: Lister 38207906; Massey Ferguson 1062501-M91
O.D.: 6 11/16 (169.9)
 Lid 8 13/32 (213.5)
I.D.: 21/32 (16.7) & 3 15/32 (88.1)
Height: 15 7/16 (392.1)
A. Gskt: [1] Attached
F. Gskt: [1] Wing Nut

RS3700XP



Extreme Performance Nano Radial Seal Outer Air Element
Fits: Caterpillar Equipment
Use With: RS3701
Replaces: Caterpillar 106-3969
O.D.: 14 7/32 (361.2)
I.D.: 8 15/16 (227.0) One End
Height: 18 11/32 (465.9)
Related To: RS3700 (Standard Media Version)

Measurements Are Shown In Inches And (Millimeters)

! **WARNING:** These products can expose you to chemicals, including Diisononyl Phthalate, Carbon black extracts, Nickel, 1,3 Butadiene, Ethylene Oxide, Epichlorohydrin, which are known to the State of California to cause cancer, and Bisphenol, Ethylene Glycol, Ethylene Oxide, 1,3 Butadiene, Epichlorohydrin, which are known to the State of California to cause birth defects or other reproductive harm. For more information go to www.P65Warnings.ca.gov.

RS3701



Radial Seal Inner Air Element
Fits Inside: RS3700, RS3700XP
Fits: Caterpillar Equipment
Replaces: Caterpillar 106-3973
O.D.: 9 3/32 (231.0)
I.D.: 6 29/32 (175.4) One End
Height: 17 27/32 (453.2)

RS3708



Radial Seal Outer Air Element
Fits: Case Equipment
Use With: RS3709
Replaces: Case 128781A1
O.D.: 5 13/32 (137.3)
I.D.: 3 3/16 (81.0) One End
Height: 15 15/32 (392.9)

RS3703



Radial Seal Inner Air Element
Fits Inside: RS3549, RS3988
Fits: Bobcat, Case-International, Caterpillar, John Deere, Kubota, Mustang, Terex, Timberjack Equipment
Replaces: Case 133721-A1; Melroe-Bobcat 6666334; Owatonna 42035599
O.D.: 3 5/16 (84.1)
I.D.: 2 15/32 (62.7) One End
Height: 11 31/32 (304.0)

RS3709



Radial Seal Inner Air Element
Fits Inside: RS3708, RS5395-FN
Fits: Case Equipment
Replaces: Case 128782A1
O.D.: 3 5/16 (84.1)
I.D.: 2 15/32 (62.7) One End
Height: 14 7/8 (377.8)

RS3704



Radial Seal Outer Air Element
Fits: Isuzu, Yanmar Engines; Bobcat, Caterpillar, John Deere, Komatsu, Kubota Equipment
Use With: RS3705
Replaces: John Deere M131802; Kubota TA040-93230; Melroe-Bobcat 6672467; Yanmar 119808-12520
O.D.: 4 1/8 (104.8)
I.D.: 2 5/16 (58.7) One End
Height: 10 13/16 (274.6)
Related To: RS3716 (with Flame Retardant Media)

RS3710



Radial Seal Outer Air Element
Fits: Nissan Trucks
Use With: RS3711
Replaces: Nissan 16546-Z9100
O.D.: 10 29/32 (277.0)
I.D.: 6 25/32 (172.2) One End
Height: 14 23/32 (373.9)

RS3705



Radial Seal Inner Air Element
Fits Inside: RS3704, RS3716
Fits: Isuzu, Yanmar Engines; Bobcat, Caterpillar, John Deere, Komatsu, Kubota Equipment
Replaces: Hitachi 4423981; John Deere M131803; Kubota TA040-93220; Melroe-Bobcat 6672468; Donaldson P822858
O.D.: 2 13/32 (61.1)
I.D.: 1 3/4 (44.5) One End
Height: 10 13/32 (264.3)

RS3711



Radial Seal Inner Air Element
Fits Inside: RS3710
Fits: Nissan Trucks
Replaces: Nissan 16546-Z9101
O.D.: 6 7/8 (174.6)
I.D.: 6 1/2 (165.1) One End
Height: 14 1/32 (356.4)

RS3706



Radial Seal Heavy-Duty Air Element
Fits: Chevrolet, GMC Light-Duty Trucks, Vans
Replaces: GMC 15986275, 25168082
O.D.: 7 11/32 (186.5)
I.D.: 3 19/32 (91.3) One End
Height: 11 3/32 (281.8)
Related To: RS3707 (Standard Version)
 RS3735 (Standard Version with Foam Wrap)

RS3712



Radial Seal Outer Air Element
Fits: Caterpillar Equipment
Use With: RS3713
Replaces: Caterpillar 123-6855
O.D.: 14 7/32 (361.2)
I.D.: 8 15/16 (227.0) One End
Height: 15 17/32 (394.5)

RS3707



Radial Seal Air Element
Fits: Chevrolet, GMC Light-Duty Trucks, Vans
Replaces: GMC 15998574, 25168081
O.D.: 6 1/2 (165.1)
I.D.: 3 9/16 (90.5) One End
Height: 11 1/32 (280.2)
Related To: RS3706 (Heavy-Duty Version)
 RS3735 (with Foam Wrap)

RS3713



Radial Seal Inner Air Element
Fits Inside: RS3712
Fits: Caterpillar Equipment
Replaces: Caterpillar 123-6856
O.D.: 9 3/32 (231.0)
I.D.: 6 29/32 (175.4) One End
Height: 15 7/32 (386.6)

Measurements Are Shown In Inches And (Millimeters)

WARNING: These products can expose you to chemicals, including Diisononyl Phthalate, Carbon black extracts, Nickel, 1,3 Butadiene, Ethylene Oxide, Epichlorohydrin, which are known to the State of California to cause cancer, and Bisphenol, Ethylene Glycol, Ethylene Oxide, 1,3 Butadiene, Epichlorohydrin, which are known to the State of California to cause birth defects or other reproductive harm. For more information go to www.P65Warnings.ca.gov.

RS3714



Radial Seal Outer Air Element
Fits: M.A.N. Trucks
Use With: RS4549
Replaces: M.A.N. 81.08304.0083
O.D.: 11 29/32 (302.4)
I.D.: 6 5/8 (168.3) One End
Height: 19 3/32 (485.0)

RS3720



Radial Seal Outer Air Element
Fits: Case-International, Steiger Equipment
Use With: RS3721
Replaces: Steiger 90-8300T1
O.D.: 12 13/32 (315.1)
I.D.: 8 3/16 (208.0) One End
Height: 21 5/8 (549.3)

RS3715



Radial Seal Outer Air Element
Notes: Also available in HSG3077 or HSG3078 Housings.
Fits: Exmark Lawn & Garden Tractors; Bobcat, John Deere Equipment
Use With: RS3930
Replaces: John Deere M113621
O.D.: 3 17/32 (89.7)
I.D.: 1 3/4 (44.5) One End
Height: 7 (177.8)

RS3721



Radial Seal Inner Air Element
Fits Inside: RS3720
Fits: Case-International, Steiger Tractors
Replaces: Steiger 90-8301T1
O.D.: 8 5/16 (211.1)
I.D.: 6 1/32 (153.2) One End
Height: 20 31/32 (532.6)

RS3716



Radial Seal Outer Air Element
Contains: Flame Retardant Media
Fits: TCM Lift Trucks
Use With: RS3705
Replaces: TCM 5365172061
O.D.: 4 1/8 (104.8)
I.D.: 2 5/16 (58.7) One End
Height: 10 13/16 (274.6)
Related To: RS3704 (without Flame Retardant Media)

RS3722



Radial Seal Inner Air Element
Fits Inside: RS3548, RS3548XP
Fits: John Deere Equipment
Replaces: John Deere RE51630
O.D.: 5 29/32 (150.0)
I.D.: 4 13/32 (111.9) One End
Height: 15 (381.0)

RS3717



Radial Seal Inner Air Element
Fits Inside: RS3517, RS3517XP
Fits: Freightliner Trucks; John Deere, Komatsu Equipment
Replaces: Donaldson P533781
O.D.: 5 1/4 (133.4)
I.D.: 4 15/16 (125.4) One End
Height: 18 7/32 (462.8)

RS3724



Radial Seal Air Element
Fits: Scania Trucks
Replaces: Scania 1335679
O.D.: 11 29/32 (302.4)
I.D.: 6 5/8 (168.3) One End
Height: 17 19/32 (446.9)

RS3718



Radial Seal Outer Air Element
Fits: Case-International, John Deere, Steiger Equipment
Use With: RS3719
Replaces: Case 132151A1; John Deere AT203050
O.D.: 10 31/32 (278.6)
I.D.: 5 27/32 (148.4) One End
Height: 21 5/8 (549.3)

RS3726



Radial Seal Outer Air Element
Fits: Scania Trucks
Use With: RS5313
Replaces: Scania 1335678
O.D.: 11 29/32 (302.4)
I.D.: 6 5/8 (168.3) One End
Height: 20 23/32 (526.3)

RS3719



Radial Seal Inner Air Element
Fits Inside: RS3718
Fits: Case-International, John Deere, Steiger Equipment
Replaces: Case 1321419A1; John Deere AT203051
O.D.: 5 29/32 (150.0)
I.D.: 4 13/32 (111.9) One End
Height: 21 1/16 (535.0)

RS3727



Radial Seal Outer Air Element
Fits: R.V.I. Trucks
Replaces: Renault 5010230841
O.D.: 12 9/32 (311.9)
I.D.: 6 31/32 (177.0) One End
Height: 18 11/32 (465.9)
Related To: RS5390 (Flame Retardant Media)

Measurements Are Shown In Inches And (Millimeters)

! **WARNING:** These products can expose you to chemicals, including Diisononyl Phthalate, Carbon black extracts, Nickel, 1,3 Butadiene, Ethylene Oxide, Epichlorohydrin, which are known to the State of California to cause cancer, and Bisphenol, Ethylene Glycol, Ethylene Oxide, 1,3 Butadiene, Epichlorohydrin, which are known to the State of California to cause birth defects or other reproductive harm. For more information go to www.P65Warnings.ca.gov.

RS3728



Radial Seal Outer Air Element
Fits: R.V.I. Buses, Trucks
Use With: RS3729
Replaces: Renault 5010230916
O.D.: 12 9/32 (311.9)
I.D.: 6 31/32 (177.0) One End
Height: 21 7/8 (555.6)

RS3734



Radial Seal Outer Air Element
Fits: Caterpillar, Agco, Case, John Deere, Komatsu, Liebherr, Massey Ferguson, New Holland, Volvo Equipment
Use With: RS3885
Replaces: Caterpillar 130-4678; John Deere AT203469
O.D.: 8 5/32 (207.2)
I.D.: 4 3/16 (106.4) One End
Height: 16 9/16 (420.7)
Related To: RS3734XP (Extreme Performance Nano Version)

RS3729



Radial Seal Inner Air Element
Fits Inside: RS3728
Fits: R.V.I. Trucks
Replaces: Renault 5010269584
O.D.: 6 7/8 (174.6)
I.D.: 5 11/16 (144.5) One End
Height: 21 1/8 (536.6)

RS3734XP



Extreme Performance Nano Radial Seal Outer Air Element
Fits: Caterpillar, Agco, Case, John Deere, Komatsu, Liebherr, Massey Ferguson, New Holland, Volvo Equipment
Use With: RS3885
Replaces: Caterpillar 130-4678; John Deere AT203469
O.D.: 8 5/32 (207.2)
I.D.: 4 3/16 (106.4) One End
Height: 16 9/16 (420.7)
Related To: RS3734 (Standard Media Version)

RS3730



Radial Seal Air Element
Fits: Freightliner Trucks
Replaces: Vortex VF120W
O.D.: 11 (279.4)
I.D.: 5 13/16 (147.6)
Height: 19 3/8 (492.1)

RS3735



Radial Seal Air Element with Foam Wrap
Fits: Chevrolet, GMC Light-Duty Trucks
Replaces: GMC 25173426
O.D.: 7 9/32 (184.9)
I.D.: 3 9/16 (90.5) One End
Height: 11 1/32 (280.2)
Related To: RS3707 (without Foam Wrap) RS3706 (Heavy-Duty Version without Foam Wrap)

RS3731



Radial Seal Outer Air Element
Fits: Mitsubishi Trucks
Use With: RS3732
Replaces: Mitsubishi ME073160, ME073597, ME073821
O.D.: 9 9/32 (235.7)
I.D.: 5 5/32 (131.0) One End
Height: 16 11/32 (415.1)

RS3736



Radial Seal Outer Air Element
Fits: Caterpillar Equipment
Use With: RS3737
Replaces: Caterpillar 131-8822
O.D.: 9 9/32 (235.7)
I.D.: 5 5/32 (131.0) One End
Height: 13 1/2 (342.9)

RS3732



Radial Seal Inner Air Element
Fits Inside: RS3731; RS5546
Fits: Mitsubishi Trucks
Replaces: Mitsubishi ME291563
O.D.: 5 1/4 (133.4)
I.D.: 3 23/32 (94.5) One End
Height: 15 23/32 (399.3)

RS3737



Radial Seal Inner Air Element
Fits Inside: RS3736
Fits: Caterpillar Equipment
Replaces: Caterpillar 131-8821
O.D.: 5 1/4 (133.4)
I.D.: 3 23/32 (94.5) One End
Height: 12 23/32 (323.1)

RS3733



Radial Seal Air Element
Fits: Hino Trucks
Replaces: Hino 17801-3000
O.D.: 9 9/32 (235.7)
I.D.: 5 5/32 (131.0) One End
Height: 13 23/32 (348.5)













RS3738



Radial Seal Outer Air Element
Fits: Ford Louisville Trucks
Use With: RS3739
Replaces: Ford F6HZ-9601-CA
O.D.: 13 15/32 (342.1)
I.D.: 8 5/32 (207.2) One End
Height: 17 3/4 (450.9)

Measurements Are Shown In Inches And (Millimeters)

WARNING: These products can expose you to chemicals, including Diisononyl Phthalate, Carbon black extracts, Nickel, 1,3 Butadiene, Ethylene Oxide, Epichlorohydrin, which are known to the State of California to cause cancer, and Bisphenol, Ethylene Glycol, Ethylene Oxide, 1,3 Butadiene, Epichlorohydrin, which are known to the State of California to cause birth defects or other reproductive harm. For more information go to www.P65Warnings.ca.gov.

<p>RS3739</p> 	<p>Radial Seal Inner Air Element Fits Inside: RS3738 Fits: Ford Louisville Trucks Replaces: Ford F6HZ-9602-AA O.D.: 8 5/16 (211.1) I.D.: 6 1/32 (153.2) One End Height: 16 13/16 (427.0)</p>	<p>RS3745</p> 	<p>Radial Seal Inner Air Element Fits Inside: RS3744, RS3744XP Fits: Ag-Chem, Case, Caterpillar, Hitachi, John Deere, New Holland, Volvo Equipment Replaces: John Deere AT175224 O.D.: 5 29/32 (150.0) I.D.: 4 13/32 (111.9) One End Height: 19 19/32 (497.7)</p>
<p>RS3740</p> 	<p>Radial Seal Outer Air Element Fits: Volvo Trucks Use With: RS3741 Replaces: Volvo 8076195 O.D.: 12 31/32 (329.4) I.D.: 7 3/4 (196.9) One End Height: 16 7/16 (417.5)</p>	<p>RS3746</p> 	<p>Radial Seal Cab Air Element Fits: John Deere Tractors Replaces: John Deere R119168 O.D.: 6 1/2 (165.1) I.D.: 3 9/16 (90.5) One End Height: 12 17/32 (318.3)</p>
<p>RS3741</p> 	<p>Radial Seal Inner Air Element Fits Inside: RS3740 Fits: Volvo Trucks Replaces: Volvo 8079756 O.D.: 7 7/8 (200.0) I.D.: 6 3/16 (157.2) One End Height: 15 21/32 (397.7)</p>	<p>RS3747</p> 	<p>Radial Seal Inner Air Element Fits Inside: RS3549, RS4595 Fits: Clark Lift Trucks Replaces: Toyota 17744-U2100-71 O.D.: 3 5/16 (84.1) I.D.: 2 15/32 (62.7) One End Height: 12 1/32 (305.6)</p>
<p>RS3743</p> 	<p>Radial Seal Air Element Notes: Inside-Out Flow Direction. Uses 2 filters per application (left/right housings). Contains: 3 3/32 (78.6) Inch Dust Evacuation Hole Fits: International Trucks Replaces: International 3507421-C1, 3517842-C1 O.D.: 9 21/32 (245.3) I.D.: 5 5/32 (131.0) Height: 23 17/32 (597.7) F. Gskt: [1] Included</p>	<p>RS3749</p> 	<p>Radial Seal Air Element Fits: Sterling Trucks Replaces: Ford F6HZ-9601-BA O.D.: 12 31/32 (329.4) I.D.: 6 13/16 (173.0) One End Height: 17 5/16 (438.9)</p>
<p>RS3744</p> 	<p>Radial Seal Outer Air Element Fits: Ag-Chem, Case, Caterpillar, Hitachi, J.C. Bamford, John Deere, Link-Belt, New Holland, Volvo Equipment; DAF Trucks Use With: RS3745 Replaces: DAF 1295090; John Deere AT175223 O.D.: 10 31/32 (278.6) I.D.: 5 13/16 (147.6) One End Height: 20 9/16 (522.3) Related To: RS3744XP (Extreme Performance Nano Version)</p>	<p>RS3750</p> 	<p>Radial Seal Air Element Fits: Kenworth, Peterbilt Trucks Replaces: Donaldson P542101 O.D.: 10 29/32 (277.0) I.D.: 6 25/32 (172.2) One End Height: 15 21/32 (397.7)</p>
<p>RS3744XP</p> 	<p>Extreme Performance Nano Radial Seal Outer Air Element Fits: Ag-Chem, Case, Caterpillar, Hitachi, J.C. Bamford, John Deere, Link-Belt, New Holland, Volvo Equipment; DAF Trucks Use With: RS3745 Replaces: DAF 1295090; John Deere AT175223 O.D.: 10 31/32 (278.6) I.D.: 5 13/16 (147.6) One End Height: 20 9/16 (522.3) Related To: RS3744 (Standard Media Version)</p>	<p>PA3752</p> 	<p>Air Element with Lid Fits: Bomag, Hamm, Zettelmeyer Equipment; Mercedes-Benz Buses, Trucks Replaces: Hamm 278947; Mercedes-Benz 10949604; Zettelmeyer 20782411 O.D.: 6 17/32 (165.9) Lid 7 13/16 (198.4) I.D.: 11/32 (8.7) & 3 3/8 (85.7) Height: 13 27/32 (351.6) A. Gskt: [1] Attached</p>

Measurements Are Shown In Inches And (Millimeters)

 **WARNING:** These products can expose you to chemicals, including Diisononyl Phthalate, Carbon black extracts, Nickel, 1,3 Butadiene, Ethylene Oxide, Epichlorohydrin, which are known to the State of California to cause cancer, and Bisphenol, Ethylene Glycol, Ethylene Oxide, 1,3 Butadiene, Epichlorohydrin, which are known to the State of California to cause birth defects or other reproductive harm. For more information go to www.P65Warnings.ca.gov.

PA3753

Air Element



Fits: Mercedes-Benz Trucks, Vans
Replaces: Mercedes-Benz 30943904
O.D.: 5 29/32 (150.0)
I.D.: 3/8 (9.5) & 2 13/16 (71.4)
Height: 9 1/32 (229.4)
A. Gskt: [1] Attached
Grommets: [1] Attached

PA3759

Air Element with Lid



Fits: Eicher, Hurlimann, Valmet, Zettlemeyer Equipment
Replaces: Zettelmeyer 2133207
O.D.: 5 7/8 (149.2)
Lid 7 (177.8)
I.D.: 11/32 (8.7) & 2 13/16 (71.4)
Height: 13 3/16 (335.0)
A. Gskt: [1] Attached

PA3754

Air Element



Fits: Iveco Trucks
Replaces: Iveco 1905710
O.D.: 12 7/8 (327.0)
I.D.: 13/32 (10.3) & 8 1/2 (215.9)
Height: 18 3/4 (476.3)
A. Gskt: [2] Attached

PA3760

Outer Air Element



Fits: DAF, Iveco, M.A.N., Pegaso Buses, Trucks
Replaces: DAF 393561; Iveco 1907533; Pegaso 173260
O.D.: 9 17/32 (242.1)
I.D.: 7/16 (11.1) & 5 3/16 (131.8)
Height: 14 27/32 (377.0)
A. Gskt: [1] Attached
F. Gskt: [1] Included

PA3755

Outer Air Element



Fits: Volvo Loaders
Replaces: Volvo 6631290, 6631299
O.D.: 10 1/16 (255.6)
I.D.: 7 9/16 (192.1)
Height: 7 11/16 (195.3)

PA3761-FN

Outer Air Element with Fins



Fits: Ford Tractors
Replaces: Ford E9NN-9601-GA, SBA314531128; New Holland 86512889
O.D.: 5 1/4 (133.4)
Fins 6 3/8 (161.9)
I.D.: 3/8 (9.5) & 2 5/8 (66.7)
Height: 11 9/32 (286.5)
A. Gskt: [1] Attached
F. Gskt: [1] Included

PA3756

Cab Air Element



Fits: Caterpillar Equipment
Replaces: Caterpillar 5G1913
Length: 16 (406.4)
Width: 8 (203.2)
Height: 2 3/16 (55.6)

PA3763

Panel Air Element with Foam Pad



Fits: Dodge Light-Duty Trucks
Replaces: Chrysler 4728406, 4856649, 4864442
Length: 11 13/16 (300.0)
Width: 10 25/32 (273.8)
Height: 2 11/16 (68.3)

PA3757

Air Element



Fits: Atlas Copco Compressors; Atlas-Weyhausen, Fiat Equipment
Replaces: Atlas Copco 16196220; Atlas-Weyhausen 2673698
O.D.: 3 11/16 (93.7)
I.D.: 11/32 (8.7) & 1 11/16 (42.9)
Height: 6 25/32 (172.2)
A. Gskt: [1] Attached

RS3764

Radial Seal Air Element



Replaces: Donaldson P778674
O.D.: 12 9/32 (311.9)
I.D.: 6 31/32 (177.0) One End
Height: 22 29/32 (581.8)

PA3758

Air Element with Lid



Replaces: Volvo 7354867
Lid 5 3/8 (136.5)
O.D.: 4 11/32 (110.3)
I.D.: 11/32 (8.7) & 1 31/32 (50.0)
Height: 8 15/16 (227.0)
A. Gskt: [2] Attached

PA3765

Outer Air Element



Fits: Mercedes-Benz Trucks, Vans
Replaces: Mercedes-Benz 30947004
O.D.: 12 29/32 (327.8)
I.D.: 7/16 (11.1) & 7 17/32 (191.3)
Height: 18 7/8 (479.4)
A. Gskt: [1] Attached

Measurements Are Shown In Inches And (Millimeters)

WARNING: These products can expose you to chemicals, including Diisononyl Phthalate, Carbon black extracts, Nickel, 1,3 Butadiene, Ethylene Oxide, Epichlorohydrin, which are known to the State of California to cause cancer, and Bisphenol, Ethylene Glycol, Ethylene Oxide, 1,3 Butadiene, Epichlorohydrin, which are known to the State of California to cause birth defects or other reproductive harm. For more information go to www.P65Warnings.ca.gov.

PA3766

Air Element



Fits: M.A.N. Buses
Replaces: M.A.N. 83.08405.0000
O.D.: 11 29/32 (302.4)
I.D.: 13/32 (10.3) & 7 17/32 (191.3)
Height: 13 1/4 (336.6)
A. Gskt: [1] Attached
F. Gskt: [1] Included

PA3775

Outer Air Element



Fits: Agco, White Equipment
Use With: PA3774
Replaces: Deutz 72162543; White 30-3435318
O.D.: 9 29/32 (251.6)
I.D.: 7/8 (22.2) & 6 1/16 (154.0)
Height: 15 9/16 (395.3)
A. Gskt: [1] Attached
F. Gskt: [1] Included

PA3767

Air Element with 4 Bolt Holes in Flange



Contains: [1] Grease packet.
Fits: Volvo Trucks
Replaces: Volvo 1665898
O.D.: 12 3/4 (323.9)
 Flange 14 (355.6)
I.D.: 7 25/32 (197.6) One End
Height: 16 19/32 (421.5)
A. Gskt: [2] Attached

PA3777

Cab Air Element



Fits: Caterpillar Equipment
Replaces: Caterpillar 3E0410
Length: 9 (228.6)
Width: 7 (177.8)
Height: 1 3/8 (34.9)
A. Gskt: [1] Attached

PA3768

Air Element with 4 Bolt Holes in Flange



Fits: Volvo Trucks
Replaces: Volvo 1665908
O.D.: 14 1/32 (356.4)
 Flange 14 7/8 (377.8)
I.D.: 7 7/8 (200.0) One End
Height: 16 5/16 (414.3)
A. Gskt: [2] Attached

PA3778

Outer Air Element



Fits: John Deere Tractors
Use With: PA2381
Replaces: John Deere AL65051
O.D.: 5 1/4 (133.4)
I.D.: 21/32 (16.7) & 3 1/4 (82.6)
Height: 12 1/2 (317.5)
A. Gskt: [1] Attached
F. Gskt: G103-N

PA3772

Outer Air Element



Fits: Volvo Trucks
Replaces: Volvo 1661667
O.D.: 11 3/32 (281.8)
 Flange 13 9/32 (337.3)
I.D.: 7 5/32 (181.8) One End
Height: 26 7/32 (666.0)
A. Gskt: [2] Attached

PA3779-FN

Outer Air Element with Fins



Fits: John Deere, New Holland Equipment
Use With: PA2670
Replaces: John Deere RE45827;
 New Holland 86529587
O.D.: 6 3/32 (154.8)
 Fins 7 13/16 (198.4)
I.D.: 3/4 (19.1) & 3 15/32 (88.1)
Height: 13 9/32 (337.3)
A. Gskt: [1] Attached
F. Gskt: G103-N, [1] Wing Nut

PA3773

Air Element



Fits: Saab, Volkswagen Automotive, Vans
Replaces: Saab 4023420; Volkswagen
 25129620, 25129620-A
O.D.: 7 3/16 (182.6)
I.D.: 3 15/16 (100.0)
Height: 4 1/16 (103.2)

PA3780

Outer Air Element



Replaces: Renault 5010317060
O.D.: 12 1/16 (306.4)
I.D.: 11/16 (17.5) & 7 11/16 (195.3)
Height: 18 23/32 (475.5)
A. Gskt: [1] Attached
F. Gskt: G103-N, [1] Wing Nut

PA3774

Inner Air Element



Fits Inside: PA3775
Fits: Agco, White Tractors
Replaces: Deutz 72162544
O.D.: 5 15/16 (150.8)
I.D.: 21/32 (16.7) & 4 27/32 (123.0)
Height: 13 1/2 (342.9)
A. Gskt: [1] Included
F. Gskt: G103-N

PA3781

Cab Air Element

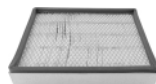

Fits: Caterpillar Equipment
Replaces: Caterpillar 7X6041
Length: 12 1/4 (311.2)
Width: 9 9/16 (242.9)
Height: 2 9/16 (65.1)
A. Gskt: [1] Attached

PA3782

Cab Air Element

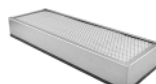

Fits: Caterpillar Equipment, Off-Highway
 Trucks
Replaces: Caterpillar 8C9657
Length: 17 1/2 (444.5)
Width: 6 (152.4)
Height: 2 9/16 (65.1)

Measurements Are Shown In Inches And (Millimeters)



WARNING: These products can expose you to chemicals, including Diisononyl Phthalate, Carbon black extracts, Nickel, 1,3 Butadiene, Ethylene Oxide, Epichlorohydrin, which are known to the State of California to cause cancer, and Bisphenol, Ethylene Glycol, Ethylene Oxide, 1,3 Butadiene, Epichlorohydrin, which are known to the State of California to cause birth defects or other reproductive harm. For more information go to www.P65Warnings.ca.gov.

PA3783



Inner Air Element
Fits Inside: PA3479
Fits: Hitachi Excavators; Isuzu Engines
Replaces: Hitachi 4247974
O.D.: 5 3/16 (131.8)
I.D.: 21/32 (16.7) & 3 31/32 (100.8)
Height: 9 9/16 (242.9)
A. Gskt: [1] Attached
F. Gskt: G103-N

PA3792



Outer Air Element
Fits: Kubota Tractors
Replaces: Kubota T0070-16323
O.D.: 4 3/32 (104.0)
I.D.: 2 1/2 (63.5)
Height: 9 15/16 (252.4)
A. Gskt: [2] Attached

PA3785-FN



Outer Air Element with Fins and Lid
Fits: John Deere Tractors
Replaces: John Deere M802606
O.D.: 4 3/32 (104.0)
 Lid 5 29/32 (150.0)
I.D.: 21/32 (16.7) & 2 1/2 (63.5)
Height: 10 1/2 (266.7)
A. Gskt: [1] Attached
F. Gskt: G103-N

PA3793



Replacement for Ecolite Air Element in Disposable Housing
Fits: Massey Ferguson Wheel Tractors
Replaces: Bosch 1457433005; Mercedes-Benz 30945104
O.D.: 5 31/32 (151.6)
 Housing 6 29/32 (175.4)
I.D.: 2 13/16 (71.4) One End
Height: 13 1/8 (333.4)

PA3786-FN



Outer Air Element with Fins
Fits: Ford Buses, Trucks
Use With: PA2883
Replaces: Donaldson P900006; Motorcraft AFA92
O.D.: 12 1/8 (308.0)
 Fins 15 3/4 (400.1)
I.D.: 7/8 (22.2) & 7 11/16 (195.3)
Height: 16 1/2 (419.1)
A. Gskt: [1] Attached
F. Gskt: G129-N

PA3794



Outer Air Element
Fits: Scania Trucks
Replaces: Scania 395776
O.D.: 12 3/32 (307.2)
I.D.: 21/32 (16.7) & 7 23/32 (196.1)
Height: 17 5/32 (435.8)
A. Gskt: [1] Attached
F. Gskt: G103-N

PA3787



Inner Air Element
Fits Inside: PA3606
Fits: Claas, Liebherr, New Holland Equipment; M.A.N. Trucks
Replaces: Claas 773820; Liebherr 7368215; M.A.N. 81.08304.0066
O.D.: 7 15/16 (201.6)
 Flange 8 5/16 (211.1)
I.D.: 21/32 (16.7) & 7 11/32 (186.5)
Height: 23 31/32 (608.8)
I.Gskt: [1] Included

PA3795



Outer Air Element
Fits: Yanmar Tractors
Replaces: Yanmar 124764-12510
O.D.: 4 3/32 (104.0)
I.D.: 25/32 (19.8) & 2 15/32 (62.7)
Height: 7 25/32 (197.6)
A. Gskt: [1] Attached
F. Gskt: G103-N

PA3790



Outer Air Element with Lid
Fits: Massey Ferguson Tractors
Use With: PA3950
Replaces: GMC 25313867; Massey Ferguson 3595500-M1
O.D.: 7 13/16 (198.4)
 Lid 8 13/32 (213.5)
I.D.: 5/8 (15.9) & 3 7/16 (87.3)
Height: 11 1/32 (280.2)
A. Gskt: [1] Attached
F. Gskt: [1] Wing Nut

PA3796



Outer Air Element
Fits: John Deere Tractors
Use With: PA3797
Replaces: John Deere AL78223
O.D.: 7 9/32 (184.9)
 Flange 9 9/32 (235.7)
I.D.: 3 19/32 (91.3) One End
Height: 12 1/4 (311.2)
A. Gskt: [1] Attached

PA3791-FN



Outer Air Element with Fins
Fits: New Holland Equipment
Use With: PA2489
Replaces: New Holland 86504145
O.D.: 5 1/4 (133.4)
 Fins 6 3/8 (161.9)
I.D.: 21/32 (16.7) & 2 5/8 (66.7)
Height: 11 1/2 (292.1)
A. Gskt: [1] Attached
F. Gskt: G103-N

PA3797



Inner Air Element with 3 Bolts
Fits Inside: PA3796
Fits: John Deere Tractors
Replaces: John Deere AL78224
O.D.: 5 1/32 (127.8)
 Flange 7 13/16 (198.4)
I.D.: 3 5/8 (92.1) One End
Height: 5 3/16 (131.8)
I.Gskt: [1] Included
O-Ring: [3] Included

Measurements Are Shown In Inches And (Millimeters)

WARNING: These products can expose you to chemicals, including Diisononyl Phthalate, Carbon black extracts, Nickel, 1,3 Butadiene, Ethylene Oxide, Epichlorohydrin, which are known to the State of California to cause cancer, and Bisphenol, Ethylene Glycol, Ethylene Oxide, 1,3 Butadiene, Epichlorohydrin, which are known to the State of California to cause birth defects or other reproductive harm. For more information go to www.P65Warnings.ca.gov.

PA3798

Cab Air Element



Fits: Ford Tractors
Replaces: Ford E4NN-94000N20-AE, E4NN-94000N20-AF
Length: 18 1/4 (463.6)
Width: 3 7/8 (98.4)
Height: 3 3/16 (81.0)
A. Gskt: [1] Attached

PA3800

Replacement for Ecolite Air Element in Disposable Housing



Fits: Blue Bird Buses; Farr Air Cleaners
Replaces: Farr 117122-000
O.D.: 11 1/2 (292.1)
I.D.: 7 (177.8) One End
Height: 25 19/32 (650.1)

PA3801-FN

Outer Air Element with Fins



Replaces: Caterpillar 97-1293
O.D.: 5 1/4 (133.4)
 Fins 6 11/32 (161.1)
I.D.: 2 1/32 (16.7) & 3 5/16 (84.1)
Height: 11 1/2 (292.1)
A. Gskt: [1] Attached
F. Gskt: G103-N

PA3802

Cab Air Element

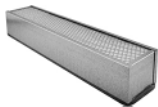

Fits: Caterpillar Equipment
Replaces: Caterpillar 7T3519
Length: 19 11/16 (500.1)
Width: 3 15/16 (100.0)
Height: 3 9/16 (90.5)
A. Gskt: [1] Included

PA3803

Cab Air Element

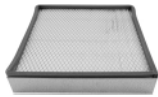

Fits: Caterpillar Equipment
Replaces: Caterpillar 7T7358
Length: 12 7/8 (327.0)
Width: 12 (304.8)
Height: 2 9/16 (65.1)
A. Gskt: [1] Attached

PA3804

Cab Air Element

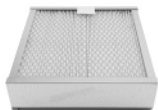

Fits: Caterpillar Equipment
Replaces: Caterpillar 9X3352
Length: 9 (228.6)
Width: 9 (228.6)
Height: 2 9/16 (65.1)
A. Gskt: [1] Attached

PA3805-FN

Air Element with Fins



Contains: Flame Retardant Media
Fits: Hyster Lift Trucks
Replaces: Hyster 1377093
O.D.: 4 3/32 (104.0)
 Fins 5 1/8 (130.2)
I.D.: 2 5/32 (19.8) & 2 15/32 (62.7)
Height: 14 5/16 (363.5)
A. Gskt: [1] Attached
F. Gskt: G103-N

PA3806

Outer Air Element with Bail Handle



Fits: Ingersoll-Rand Compressors
Use With: PA3810
Replaces: Ingersoll-Rand 36864361
O.D.: 13 13/16 (350.8)
 Boot 14 1/2 (368.3)
I.D.: 15/16 (23.8) & 9 1/2 (241.3)
Height: 27 5/16 (693.7)
A. Gskt: [2] Attached
F. Gskt: [1] Included

PA3807

Air Element with Lid



Fits: Mercedes-Benz Trucks, Vans
Replaces: Mercedes-Benz 10949404
O.D.: 8 9/32 (210.3)
 Lid 9 29/32 (251.6)
I.D.: 11/32 (8.7) & 4 1/16 (103.2)
Height: 8 11/16 (220.7)
A. Gskt: [1] Attached

PA3808-FN

Outer Air Element with Fins and Lid



Fits: Komatsu Excavators
Use With: PA3809
Replaces: Komatsu 205-017-3570, 205-017-3750
O.D.: 11 (279.4)
I.D.: 2 1/32 (16.7) & 5 3/8 (136.5)
Height: 17 15/16 (455.6)
A. Gskt: [1] Attached
F. Gskt: G103-N, [1] Wing Nut

PA3809

Inner Air Element



Fits Inside: PA3808-FN
Fits: Komatsu Excavators
Replaces: Komatsu 20501-K1480
O.D.: 4 9/16 (115.9)
I.D.: 2 1/32 (16.7) & 3 7/16 (87.3)
Height: 16 1/2 (419.1)
A. Gskt: [1] Attached
F. Gskt: G103-N

PA3810

Inner Air Element



Fits Inside: PA3806
Replaces: Ingersoll-Rand 36864379
O.D.: 9 11/32 (237.3)
I.D.: 13/16 (20.6) & 8 1/8 (206.4)
Height: 25 9/32 (642.1)
A. Gskt: [1] Attached
F. Gskt: [1] Included

PA3811-FN

Outer Air Element with Fins and Lid



Fits: J.C. Bamford Equipment
Use With: PA3812
Replaces: J.C. Bamford 32/905301
O.D.: 5 1/8 (130.2)
 Lid 5 21/32 (143.7)
I.D.: 2 15/32 (62.7) One End
Height: 8 13/32 (213.5)
A. Gskt: [1] Attached; [1] Wing Nut

Measurements Are Shown In Inches And (Millimeters)



WARNING: These products can expose you to chemicals, including Diisononyl Phthalate, Carbon black extracts, Nickel, 1,3 Butadiene, Ethylene Oxide, Epichlorohydrin, which are known to the State of California to cause cancer, and Bisphenol, Ethylene Glycol, Ethylene Oxide, 1,3 Butadiene, Epichlorohydrin, which are known to the State of California to cause birth defects or other reproductive harm. For more information go to www.P65Warnings.ca.gov.

PA3812



Inner Air Element

Fits Inside: PA3811-FN
Fits: J.C. Bamford Equipment
Replaces: J.C. Bamford 32/905302
O.D.: 2 3/8 (60.3)
 Flange 2 3/4 (69.9)
I.D.: 21/32 (16.7) & 1 31/32 (50.0)
Height: 6 31/32 (177.0)
A. Gskt: [1] Attached
F. Gskt: [1] Included

PA3819



Inner Air Element

Fits Inside: PA3818-FN; PA4614
Fits: J.C. Bamford Equipment
Replaces: J.C. Bamford 32/905002
O.D.: 2 11/16 (68.3)
 Flange 3 17/32 (89.7)
I.D.: 21/32 (16.7) & 2 13/32 (61.1)
Height: 6 31/32 (177.0)
A. Gskt: [1] Attached
F. Gskt: [1] Included

PA3814



DynaCell Air Element Replacement

Fits: Various Oil Field, Marine Applications
Replaces: Farr T520
Length: 19 1/2 (495.3)
Width: 19 1/2 (495.3)
Height: 5 1/4 (133.4)
A. Gskt: [1] Attached
Related To: PA3815 (Top Open)

PA3820-FN



Air Element with Fins and Lid

Fits: Hitachi, J.C. Bamford Excavators
Replaces: J.C. Bamford KAP0482
O.D.: 4 3/32 (104.0)
 Lid 5 29/32 (150.0)
I.D.: 19/32 (15.1) & 2 17/32 (64.3)
Height: 10 9/16 (268.3)
A. Gskt: [1] Attached; [1] Wing Nut

PA3815

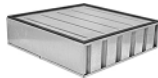

DynaCell Air Element Replacement

Fits: Various Oil Field, Marine Applications
Replaces: Farr T520D
Length: 19 1/2 (495.3)
Width: 19 1/2 (495.3)
Height: 5 1/4 (133.4)
A. Gskt: [1] Attached
Related To: PA3814 (Top Closed)

PA3821



Air Element

Fits: J.C. Bamford Equipment
Replaces: J.C. Bamford 98/800031;
 GMC25096242
O.D.: 4 3/4 (120.7)
I.D.: 2 1/8 (54.0) One End
Height: 11 1/4 (285.8)
A. Gskt: [1] Attached; [1] Wing Nut

PA3816



Outer Air Element with Lid

Fits: J.C. Bamford Equipment
Use With: PA3817
Replaces: J.C. Bamford 32/903001
O.D.: 6 9/32 (159.5)
 Lid 6 25/32 (172.2)
I.D.: 2 27/32 (72.2) One End
Height: 10 3/32 (256.4)
A. Gskt: [1] Attached; [1] Wing Nut

PA3822



Cab Air Element

Fits: Caterpillar Equipment
Replaces: Caterpillar 112-7448
Length: 11 9/32 (286.5)
Width: 8 15/16 (227.0)
Height: 1 29/32 (48.4)

PA3817



Inner Air Element

Fits Inside: PA3816
Fits: J.C. Bamford Equipment
Replaces: J.C. Bamford 32/903002
O.D.: 2 11/16 (68.3)
 Flange 3 17/32 (89.7)
I.D.: 21/32 (16.7) & 2 7/16 (61.9)
Height: 9 3/32 (231.0)
F. Gskt: [1] Included

PA3823

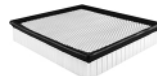

Cab Air Element

Fits: Caterpillar Equipment
Replaces: Caterpillar 107-0266
Length: 11 13/16 (300.0)
Width: 10 3/4 (273.1)
Height: 2 3/16 (55.6)

PA3818-FN



Outer Air Element with Fins and Lid

Fits: J.C. Bamford Equipment
Use With: PA3819
Replaces: J.C. Bamford 32/905001
O.D.: 5 1/2 (139.7)
 Lid 6 25/32 (172.2)
I.D.: 2 13/16 (71.4)
Height: 8 5/8 (219.1)
A. Gskt: [1] Attached; [1] Wing Nut

PA3824



Cab Air Element

Fits: Ford, New Holland Tractors
Replaces: New Holland 9823782
Length: 26 15/16 (684.2)
Width: 6 1/4 (158.8)
Height: 2 9/16 (65.1)
A. Gskt: [1] Attached

PA3825

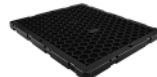

Cab Air Element

Fits: Caterpillar Crawler Tractors, Loaders
Replaces: Caterpillar 6T5068
Length: 12 19/32 (319.9)
Width: 10 5/8 (269.9)
Height: 5/8 (15.9)

Measurements Are Shown In Inches And (Millimeters)

WARNING: These products can expose you to chemicals, including Diisononyl Phthalate, Carbon black extracts, Nickel, 1,3 Butadiene, Ethylene Oxide, Epichlorohydrin, which are known to the State of California to cause cancer, and Bisphenol, Ethylene Glycol, Ethylene Oxide, 1,3 Butadiene, Epichlorohydrin, which are known to the State of California to cause birth defects or other reproductive harm. For more information go to www.P65Warnings.ca.gov.

RS3826



Radial Seal Outer Air Element
Fits: Caterpillar Gen Sets; New Holland, Volvo Equipment
Use With: RS3827
Replaces: Volvo 11033998-3
O.D.: 12 9/32 (311.9)
I.D.: 6 31/32 (177.0) One End
Height: 22 29/32 (581.8)

RS3827



Radial Seal Inner Air Element
Fits Inside: RS3826
Fits: Caterpillar Gen Sets; New Holland, Volvo Equipment
Replaces: Volvo 11033999-1
O.D.: 7 1/16 (179.4)
I.D.: 5 11/16 (144.5) One End
Height: 22 3/32 (561.2)

PA3828



Cab Air Element
Fits: Case Equipment
Replaces: Case R53519
Length: 12 1/4 (336.6)
Width: 4 (101.6)
Height: 2 9/16 (65.1)
A. Gskt: [1] Attached

PA3829

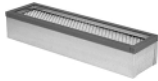

Cab Air Element
Notes: Uses 2 filters per application.
Fits: Caterpillar Motor Graders
Replaces: Caterpillar 9X4986
Length: 14 13/16 (376.2)
Width: 4 (101.6)
Height: 2 11/16 (68.3)
A. Gskt: [1] Included

PA3832



Inner Air Element
Fits Inside: LL1886, PA1886, PA1886XP
Fits: Komatsu Excavators
Replaces: Komatsu 20801-68510
O.D.: 7 5/16 (185.7)
I.D.: 21/32 (16.7) & 6 5/32 (156.4)
Height: 15 1/2 (393.7)
A. Gskt: [1] Attached
F. Gskt: [1] Metal Washer

PA3833



Air Element
Fits: Caterpillar, Mitsubishi Lift Trucks
Replaces: Caterpillar 108-5330; Hyster 3111230; Mitsubishi 91361-13300
O.D.: 4 1/4 (108.0)
 Flange 6 3/32 (154.8)
I.D.: 2 5/16 (58.7) One End
Height: 9 3/32 (231.0)
A. Gskt: [2] Attached

PA3834

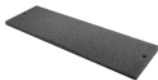

Foam Cab Air Element
Fits: Caterpillar Equipment
Replaces: Caterpillar 7T3549
Length: 14 5/8 (371.5)
Width: 4 1/2 (114.3)
Height: 1/2 (12.7)

PA3835



Foam Replacement Pad
Fits: Caterpillar Equipment
Replaces: Caterpillar 3E0411
Length: 9 (228.6)
Width: 7 (177.8)
Height: 1/4 (6.4)

PA3836



Air Element
Fits: Citroen, Fiat, Iveco, Peugeot Trucks, Vans
Replaces: Citroen 1444A1; Iveco 1902457; Peugeot 144409
O.D.: 6 5/16 (160.3)
I.D.: 3 29/32 (99.2)
Height: 6 31/32 (177.0)

PA3837



Air Element
Fits: Iveco Trucks
Replaces: Iveco 1902486
O.D.: 6 3/8 (161.9)
I.D.: 3 15/16 (100.0)
Height: 9 5/16 (236.5)

PA3838



Air Element
Fits: Mercedes-Benz Trucks, Vans
Replaces: Mercedes-Benz A0030949204
O.D.: 16 13/16 (427.0)
I.D.: 13/32 (10.3) & 10 (254.0)
Height: 10 5/16 (261.9)
F. Gskt: [1] Included

PA3839



Cab Air Element
Fits: Volvo Trucks
Replaces: Volvo 8143691, 8143691-7, 8144430
Length: 8 9/32 (210.3)
Width: 8 9/32 (210.3)
Height: 1 15/16 (49.2)

PA3840

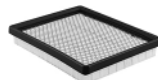

Panel Air Element
Fits: Thermo King Refrigeration Units
Replaces: Thermo King 11-7234
Length: 7 5/8 (193.7)
Width: 6 1/16 (154.0)
Height: 1 3/32 (27.8)

PA3842



Panel Air Element
Fits: Mercedes-Benz Buses, Trucks, Vans
Replaces: Mercedes-Benz 20949204
Length: 23 17/32 (597.7)
Width: 6 23/32 (170.7)
Height: 2 13/32 (61.1)
A. Gskt: [1] Attached

PA3843

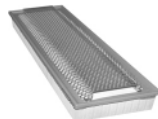

Panel Air Element
Fits: Mercedes-Benz Buses, Trucks, Vans
Replaces: Mercedes-Benz 20949304
Length: 23 17/32 (597.7)
Width: 6 23/32 (170.7)
Height: 3 3/16 (81.0)

Measurements Are Shown In Inches And (Millimeters)

WARNING: These products can expose you to chemicals, including Diisononyl Phthalate, Carbon black extracts, Nickel, 1,3 Butadiene, Ethylene Oxide, Epichlorohydrin, which are known to the State of California to cause cancer, and Bisphenol, Ethylene Glycol, Ethylene Oxide, 1,3 Butadiene, Epichlorohydrin, which are known to the State of California to cause birth defects or other reproductive harm. For more information go to www.P65Warnings.ca.gov.

PA3844 Air Element
Fits: Mercedes-Benz Trucks, Vans
Replaces: Mercedes-Benz A0030949104
O.D.: 16 17/32 (419.9)
I.D.: 13/32 (10.3) & 10 (254.0)
Height: 12 17/32 (318.3)
F. Gskt: [1] Included



PA3852-FN Outer Air Element with Fins and Lid
Fits: Fiat-Allis Equipment
Use With: PA2670
Replaces: Fiat 71405431
O.D.: 6 3/32 (154.8)
 Lid 8 13/32 (213.5)
I.D.: 3 15/32 (88.1) One End
Height: 13 15/16 (354.0)
A. Gskt: [1] Attached; [1] Wing Nut



PA3847 Inner Air Element
Fits Inside: PA3652, PA3860, PA3862-FN
Fits: Fiat-Allis, John Deere, Liebherr, Massey Ferguson, New Holland, Sisu Equipment
Replaces: Fiat 1930792; John Deere RE42762; Liebherr 7403951; Massey Ferguson 3580724-M1
O.D.: 5 15/16 (150.8)
I.D.: 21/32 (16.7) & 4 27/32 (123.0)
Height: 15 (381.0)
A. Gskt: [1] Attached
F. Gskt: [1] Included



PA3853-FN Air Element with Fins and Lid
Fits: Fermeq, Massey Ferguson Equipment
Replaces: Massey Ferguson 3515586-M1, 3595503-M1
O.D.: 7 5/8 (193.7)
 Lid 8 5/16 (211.1)
I.D.: 3 7/16 (87.3)
Height: 11 1/16 (281.0)
A. Gskt: [1] Attached
F. Gskt: [1] Wing Nut



PA3848-FN Outer Air Element with Fins
Fits: Manitou Equipment
Use With: PA4827
Replaces: Manitou 177130
O.D.: 6 3/32 (154.8)
 Fins 7 27/32 (199.2)
I.D.: 3 15/32 (88.1)
Height: 12 1/16 (306.4)
A. Gskt: [1] Attached
F. Gskt: [1] Included



PA3854-FN Air Element with Fins and Lid
Fits: Ammann, Fiat, Fiat-Allis, Hitachi, Vibromax Equipment
Replaces: Fiat 1930603, 1930826, 71415282
O.D.: 9 13/16 (249.2)
 Lid 11 (279.4)
I.D.: 5 3/8 (136.5) One End
Height: 16 7/16 (417.5)
A. Gskt: [1] Attached
F. Gskt: [1] Wing Nut, [1] Washer



PA3849 Outer Air Element with Lid
Fits: Fiat, Same Tractors
Use With: PA1981
Replaces: Fiat 1930786, 221190599
O.D.: 9 7/32 (234.2)
 Lid 11 (279.4)
I.D.: 4 27/32 (123.0)
Height: 16 3/8 (415.9)
A. Gskt: [1] Attached
F. Gskt: [1] Wing Nut



PA3855-FN Air Element with Fins and Lid
Fits: Fiat-Allis, Hitachi Equipment
Replaces: Fiat 1930602, 71420350, 700055856
O.D.: 9 13/16 (249.2)
 Lid 12 15/32 (316.7)
I.D.: 21/32 (16.7) & 6 3/16 (157.2)
Height: 16 1/2 (419.1)
A. Gskt: [1] Attached
F. Gskt: [1] Washer, [1] Wing Nut



PA3850 Outer Air Element with Lid
Fits: Fiat Tractors
Use With: PA3851
Replaces: Fiat 1930174
O.D.: 9 29/32 (251.6)
 Lid 10 27/32 (275.4)
I.D.: 4 13/16 (122.2)
Height: 13 3/8 (339.7)
A. Gskt: [1] Attached; [1] Wing Nut



PA3856 Air Element
Fits: Iveco Trucks
Replaces: Iveco 1908234
O.D.: 6 3/32 (154.8)
I.D.: 3 5/32 (80.2)
Height: 9 27/32 (250.0)



PA3851 Inner Air Element
Notes: Sometimes used as Inner Air Element with PA1884 on Fiat tractors.
Fits Inside: PA3850, PA3864
Fits: Fiat Tractors
Replaces: Fiat 1930175; Massey Ferguson 3385734-M1
O.D.: 4 9/16 (115.9)
I.D.: 3 17/32 (89.7) One End
Height: 12 1/4 (311.2)
A. Gskt: [1] Attached



PA3857 Inner Air Element
Fits Inside: PA2776
Fits: Mercedes-Benz Trucks, Vans
Replaces: Mercedes-Benz 30941604
O.D.: 5 13/16 (147.6)
 Boot 6 5/16 (160.3)
I.D.: 21/32 (16.7)
Height: 18 7/16 (468.3)
F. Gskt: [2] Included



Measurements Are Shown In Inches And (Millimeters)

WARNING: These products can expose you to chemicals, including Diisononyl Phthalate, Carbon black extracts, Nickel, 1,3 Butadiene, Ethylene Oxide, Epichlorohydrin, which are known to the State of California to cause cancer, and Bisphenol, Ethylene Glycol, Ethylene Oxide, 1,3 Butadiene, Epichlorohydrin, which are known to the State of California to cause birth defects or other reproductive harm. For more information go to www.P65Warnings.ca.gov.

PA3859 Outer Air Element with Lid
Fits: Case-International, Fiat, New Holland Equipment
Use With: PA2791
Replaces: Fiat 1930536
O.D.: 5 7/16 (138.1)
 Lid 7 1/16 (179.4)
I.D.: 2 13/16 (71.4)
Height: 13 15/16 (354.0)
A. Gskt: [1] Attached; [1] Wing Nut



PA3865 Inner Air Element
Fits Inside: PA3484
Fits: Volvo Trucks
Replaces: Volvo 1080920
O.D.: 5 15/16 (150.8)
 Boot 6 25/32 (172.2)
I.D.: 15/32 (11.9) & 5 3/8 (136.5)
Height: 22 27/32 (580.2)
A. Gskt: [1] Attached
F. Gskt: [1] Included



PA3860 Outer Air Element with Lid
Fits: Laverda, Massey Ferguson Equipment
Use With: PA3847
Replaces: Fiat 1930783; New Holland 452529
O.D.: 10 13/32 (264.3)
 Lid 12 1/2 (317.5)
I.D.: 19/32 (15.1) & 6 (152.4)
Height: 16 1/2 (419.1)
A. Gskt: [1] Attached
F. Gskt: [1] Washer, [1] Wing Nut



PA3867 Air Element
Fits: Various Marine Applications
Replaces: Cummins 3924540; Donaldson B085046
O.D.: 8 1/2 (215.9)
I.D.: 4 (101.6) One End
Height: 12 3/8 (314.3)



PA3861 Inner Air Element
Fits Inside: PA2840
Fits: Astra Trucks
Replaces: Astra 107030
O.D.: 7 5/16 (185.7)
 Flange 8 15/32 (215.1)
I.D.: 11/16 (17.5) & 6 5/32 (156.4)
Height: 19 5/32 (486.6)
A. Gskt: [1] Attached
F. Gskt: [1] Included



PA3868 Air Element
Contains: Flame Retardant Media
Fits: Various Marine Applications
Replaces: Cummins 3924893; Donaldson B085048
O.D.: 8 17/32 (216.7)
I.D.: 3 (76.2) One End
Height: 12 3/8 (314.3)
Related To: PA2815 (without Flame Retardant Media)



PA3862-FN Outer Air Element with Fins
Fits: Fiat-Allis, New Holland Equipment
Use With: PA3847
Replaces: Fiat 1930604
O.D.: 9 13/16 (249.2)
 Fins 11 7/16 (290.5)
I.D.: 5/8 (15.9) & 6 3/16 (157.2)
Height: 16 1/2 (419.1)
A. Gskt: [1] Attached



PA3869 Cab Air Element with Lift Tabs
Notes: Uses 2 filters per application.
Fits: Case Loaders
Replaces: International 1970006-C2
Length: 20 (508.0)
Width: 9 (228.6)
Height: 2 9/16 (65.1)
A. Gskt: [1] Attached



PA3863 Air Element
Fits: Hino Trucks
Replaces: Hino 1780B-44070, 1780B-G8011
O.D.: 7 17/32 (191.3)
I.D.: 3 5/16 (84.1)
Height: 5 11/16 (144.5)



RS3870 Radial Seal Outer Air Element
Contains: Blank Band
Fits: Caterpillar, Hitachi, John Deere, Terex, Volvo Equipment
Use With: RS3871, RS4639
Replaces: Terex 15270188; Volvo 11033996
O.D.: 12 9/32 (311.9)
I.D.: 6 31/32 (177.0) One End
Height: 20 17/32 (521.5)
Related To: RS4638 (without Blank Band)



PA3864 Outer Air Element with Lid
Fits: Massey Ferguson Equipment
Use With: PA3851
Replaces: Massey Ferguson 3385733-M1
O.D.: 9 5/32 (232.6)
 Lid 11 (279.4)
I.D.: 4 27/32 (123.0)
Height: 13 19/32 (345.3)
A. Gskt: [1] Attached
F. Gskt: [1] Wing Nut



RS3871 Radial Seal Inner Air Element
Fits Inside: RS3870, RS4638
Fits: Caterpillar, Hitachi, John Deere, Terex, Volvo Equipment
Replaces: Terex 15270189; Volvo 11033997-5
O.D.: 7 1/16 (179.4)
I.D.: 5 11/16 (144.5) One End
Height: 19 31/32 (507.2)
Related To: RS4639 (with Flame Retardant Media)



PA3872 Reinforced Cotton Fiber Panel Air Element
Replaces: Airguard DP40-205
Length: 23 3/8 (593.7)
Width: 23 3/8 (593.7)
Height: 1 3/4 (44.5)

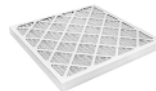

Measurements Are Shown In Inches And (Millimeters)

WARNING: These products can expose you to chemicals, including Diisononyl Phthalate, Carbon black extracts, Nickel, 1,3 Butadiene, Ethylene Oxide, Epichlorohydrin, which are known to the State of California to cause cancer, and Bisphenol, Ethylene Glycol, Ethylene Oxide, 1,3 Butadiene, Epichlorohydrin, which are known to the State of California to cause birth defects or other reproductive harm. For more information go to www.P65Warnings.ca.gov.

PA3873 Reinforced Cotton Fiber Panel Air Element
Fits: Farr Air Cleaners
Replaces: Farr 49880012
Length: 23 3/8 (593.7)
Width: 19 3/8 (492.1)
Height: 1 3/4 (44.5)



PA3874 Air Element
Fits: Sullair Compressors
Replaces: Sullair 225005-1136
O.D.: 9 7/32 (234.2)
I.D.: 21/32 (16.7) & 5 5/16 (134.9)
Height: 11 15/16 (303.2)
A. Gskt: [1] Attached
F. Gskt: G103-N



PA3875-FN Air Element with Fins and Lid
Fits: Kobelco, Komatsu Equipment
Replaces: Kobelco 2446U271-S2; Komatsu 3EC-01-11630, 3EC-01-11630-L, Z76-01-11630
O.D.: 6 3/8 (161.9)
Lid 7 1/8 (181.0)
I.D.: 21/32 (16.7) & 2 5/8 (66.7)
Height: 11 1/2 (292.1)
A. Gskt: [1] Attached
F. Gskt: G103-N



PA3876 Air Element
Fits: Iveco Trucks
Replaces: Iveco 1907695
O.D.: 12 29/32 (327.8)
I.D.: 13/32 (10.3) & 8 5/8 (219.1)
Height: 20 3/16 (512.8)
A. Gskt: [1] Attached
F. Gskt: [1] Included, [1] Steel Washer



PA3877 Cab Air Element
Fits: Caterpillar Equipment
Replaces: Caterpillar 9X8216
Length: 26 15/16 (684.2)
Width: 5 15/16 (150.8)
Height: 2 19/32 (65.9)
A. Gskt: [1] Attached



PA3878 Cab Air Element
Fits: Hitachi, John Deere Equipment
Replaces: John Deere AT103629, AT166805
Length: 18 (457.2)
Width: 10 (254.0)
Height: 2 15/16 (74.6)
A. Gskt: [2] Attached

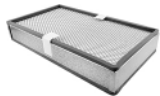

PA3879-FN Air Element with Fins and Lid
Fits: Massey Ferguson Tractors
Replaces: Massey Ferguson 3595518-M1
O.D.: 5 7/16 (138.1)
Lid 7 1/16 (179.4)
I.D.: 2 27/32 (72.2) One End
Height: 11 27/32 (300.8)
A. Gskt: [1] Attached



PA3880 Air Element
Fits: Yamaha Golf Carts
Replaces: Yamaha J381445000
O.D.: 4 1/8 (104.8)
I.D.: 1 7/32 (31.0) One End
Height: 5 13/16 (147.6)



PA3881 Cab Air Element
Fits: Caterpillar Excavators
Replaces: Caterpillar 8C4120; Nelson 87249N
Length: 15 1/4 (387.4)
Width: 7 5/16 (185.7)
Height: 2 3/16 (55.6)

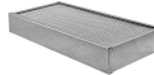

RS3882 Radial Seal Outer Air Element
Fits: Barber-Greene, Caterpillar, John Deere Equipment
Use With: RS3883
Replaces: Caterpillar 108-0671; John Deere AT175344
O.D.: 8 5/32 (207.2)
I.D.: 4 1/4 (108.0) One End
Height: 11 5/8 (295.3)



RS3882XP Extreme Performance Nano Radial Seal Outer Air Element
Fits: John Deere Excavators
Use With: RS3883
Replaces: John Deere AP35310
O.D.: 8 5/32 (207.2)
I.D.: 4 3/16 (106.4) One End
Height: 11 5/8 (295.3)



RS3883 Radial Seal Inner Air Element
Fits Inside: RS3882; RS3882XP
Fits: Barber-Greene, Caterpillar, John Deere Equipment
Replaces: Caterpillar 108-0672; John Deere AT175345
O.D.: 4 1/4 (108.0)
I.D.: 2 3/4 (69.9) One End
Height: 10 25/32 (273.8)



RS3884 Radial Seal Outer Air Element
Fits: Benford, Case-International, Dynapac, J.C. Bamford, New Holland, Pro-Tec Equipment
Use With: RS3885
Replaces: J.C. Bamford 32/912901
O.D.: 8 5/32 (207.2)
I.D.: 4 3/16 (106.4) One End
Height: 16 9/16 (420.7)



Measurements Are Shown In Inches And (Millimeters)

WARNING: These products can expose you to chemicals, including Diisononyl Phthalate, Carbon black extracts, Nickel, 1,3 Butadiene, Ethylene Oxide, Epichlorohydrin, which are known to the State of California to cause cancer, and Bisphenol, Ethylene Glycol, Ethylene Oxide, 1,3 Butadiene, Epichlorohydrin, which are known to the State of California to cause birth defects or other reproductive harm. For more information go to www.P65Warnings.ca.gov.

RS3885



Radial Seal Inner Air Element
Fits Inside: RS3734, RS3734XP, RS3884, RS30059-FN
Fits: Benford, Case-International, Caterpillar, Dynapac, J.C. Bamford, John Deere, Liebherr, New Holland, Pro-Tec Equipment
Replaces: J.C. Bamford 32/912902
O.D.: 4 1/4 (108.0)
I.D.: 3 3/8 (85.7) One End
Height: 16 1/16 (408.0)

PA3891



Replacement for Ecolite Air Filter in Disposable Housing
Contains: Water Drain Valve
Fits: Farr Air Cleaners; Thomas Buses
Replaces: Farr 119862-001, 119862-001G; Thomas 61100179
O.D.: 9 11/16 (246.1)
Inlet: 6
Outlet: 6
Height: 19 13/16 (503.2)

PA3886



Cab Air Element with Bail Handle
Fits: John Deere Equipment
Replaces: John Deere AH112712, AH115836
Length: 14 21/32 (372.3)
Width: 3 3/8 (85.7) to 5 1/4 (133.4)
Height: 2 7/16 (61.9)
A. Gskt: [2] Attached

PA3892



Outer Air Element with Lift Tab
Fits: Ingersoll-Rand Compressors
Use With: PA3893
Replaces: Ingersoll-Rand 36867786
O.D.: 12 (304.8)
 Boot 12 15/32 (316.7)
I.D.: 7/8 (22.2) & 7 7/8 (200.0)
Height: 20 1/2 (520.7)
A. Gskt: [2] Attached
F. Gskt: [1] Metal Washer

PA3887



Outer Air Element
Fits: John Deere Equipment
Use With: PA3889
Replaces: John Deere AZ45868
O.D.: 12 3/32 (307.2)
I.D.: 21/32 (16.7) & 7 11/16 (195.3)
Height: 22 1/2 (571.5)
A. Gskt: [1] Attached
F. Gskt: G103-N

PA3893



Inner Air Element
Fits Inside: PA3892
Fits: Ingersoll-Rand Compressors
Replaces: Ingersoll-Rand 36876019
O.D.: 7 5/8 (193.7)
I.D.: 7/8 (22.2) & 6 3/16 (157.2)
Height: 18 1/2 (469.9)
A. Gskt: [1] Attached
F. Gskt: [1] Metal Washer

RS3888



Radial Seal Air Element
Fits: DAF Trucks
Replaces: DAF 1317409
O.D.: 10 31/32 (278.6)
I.D.: 5 13/16 (147.6) One End
Height: 18 7/8 (479.4)

PA3894



Air Element
Fits: Various Industrial Equipment
Replaces: Nelson 70459A, 70459N
O.D.: 7 29/32 (200.8)
I.D.: 4 3/32 (104.0)
Height: 11 1/2 (292.1)

PA3889



Inner Air Element
Fits Inside: PA3887
Fits: John Deere Equipment
Replaces: John Deere AZ45867
O.D.: 7 1/4 (184.2)
 Flange 8 13/32 (213.5)
I.D.: 11/16 (17.5) & 6 3/16 (157.2)
Height: 21 13/16 (554.0)
A. Gskt: [1] Attached
F. Gskt: G103-N

PA3895-FN



Air Element with Fins
Fits: Bobcat Equipment
Replaces: Melroe-Bobcat 897064B
O.D.: 3 1/4 (82.6)
 Fins 4 1/4 (108.0)
I.D.: 13/32 (10.3) & 1 27/32 (46.8)
Height: 7 1/4 (184.2)
A. Gskt: [1] Attached
F. Gskt: [1] Included

PA3890



Air Element with Foam Wrap
Fits: Kohler Engines
Replaces: Kohler 253107
O.D.: 8 3/4 (222.3)
I.D.: 4 3/32 (104.0)
Height: 5 31/32 (151.6)

PA3896



Air Element
Notes: Sometimes used as Inner Air Element with PA2582.
Fits: Champion Graders; Ingersoll-Rand Compressors
Replaces: Ingersoll-Rand 35384627
O.D.: 6 3/8 (161.9)
I.D.: 5/8 (15.9) & 5 7/16 (138.1)
Height: 19 (482.6)
A. Gskt: [1] Attached
F. Gskt: G103-N

Measurements Are Shown In Inches And (Millimeters)

WARNING: These products can expose you to chemicals, including Diisononyl Phthalate, Carbon black extracts, Nickel, 1,3 Butadiene, Ethylene Oxide, Epichlorohydrin, which are known to the State of California to cause cancer, and Bisphenol, Ethylene Glycol, Ethylene Oxide, 1,3 Butadiene, Epichlorohydrin, which are known to the State of California to cause birth defects or other reproductive harm. For more information go to www.P65Warnings.ca.gov.

PA3897 Cab Air Element
Fits: John Deere Equipment
Replaces: John Deere AT74377
Length: 11 31/32 (304.0)
Width: 9 15/16 (252.4)
Height: 2 23/32 (69.1)
A. Gskt: [1] Attached



PA3898 Outer Air Element
Fits: Kobelco Equipment
Use With: PA3899
Replaces: Kobelco 2446R254-S5
O.D.: 8 1/8 (206.4)
I.D.: 21/32 (16.7) & 4 27/32 (123.0)
Height: 21 1/2 (546.1)
A. Gskt: [1] Attached
F. Gskt: G103-N



PA3899 Inner Air Element
Fits Inside: PA3898
Fits: Kobelco Equipment
Replaces: Kobelco 2446R254-S6
O.D.: 4 9/16 (115.9)
 Boot 5 3/4 (146.1)
I.D.: 21/32 (16.7) & 3 7/16 (87.3)
Height: 20 13/32 (518.3)
A. Gskt: [1] Attached
F. Gskt: G103-N



PA3900 Cab Air Element
Fits: John Deere Tractors
Replaces: John Deere RE70742
Length: 12 1/2 (317.5)
Width: 6 1/2 (165.1)
Height: 1 3/4 (44.5)



PA3901 Air Element
Fits: Exmark Lawn & Garden Tractors;
 Kohler Engines
Use With: PA3901 FOAM
Replaces: Kohler 2408303
O.D.: 6 31/32 (177.0)
I.D.: 5 19/32 (142.1)
Height: 3 (76.2)



PA3901 FOAM Foam Blanket for PA3901
Use With: PA3901
O.D.: 6 25/32 (172.2)
I.D.: 6 5/16 (160.3)
Height: 2 23/32 (69.1)



PA3902 Outer Air Element with Lift Bar
Fits: New Holland Tractors
Use With: PA3903
Replaces: New Holland 82008596
O.D.: 8 1/2 (215.9)
 Flange Gasket 10 (254.0)
I.D.: 19/32 (15.1) & 4 27/32 (123.0)
Height: 12 3/8 (314.3)
A. Gskt: [2] Attached
F. Gskt: [1] Included



PA3903 Inner Air Element
Fits Inside: PA3902
Fits: New Holland Tractors
Replaces: New Holland 82008597
O.D.: 4 23/32 (119.9)
 Flange 5 29/32 (150.0)
I.D.: 13/32 (10.3) & 3 31/32 (100.8)
Height: 12 1/4 (311.2)
A. Gskt: [2] Attached



PA3904 Outer Air Element
Fits: Caterpillar Generators, Industrial,
 Marine Engines
Use With: PA3905
Replaces: Caterpillar 4P0710
O.D.: 19 9/32 (489.7)
I.D.: 12 7/8 (327.0) One End
Height: 13 27/32 (351.6)
A. Gskt: [1] Attached



PA3905 Inner Air Element with 8 Bolt Holes
Fits Inside: PA3904
Fits: Caterpillar Generators, Industrial,
 Marine Engines
Replaces: Caterpillar 4P0711
O.D.: 12 25/32 (324.6)
 Flange 15 5/8 (396.9)
I.D.: 10 9/32 (261.1) One End
Height: 14 1/4 (362.0)
A. Gskt: [1] Attached



PA3906 Outer Air Element
Fits: Mitsubishi Trucks
Use With: PA5412
Replaces: Mitsubishi ME073252
O.D.: 9 1/8 (231.8)
I.D.: 15/16 (23.8) & 5 13/16 (147.6)
Height: 17 19/32 (446.9)
A. Gskt: [1] Attached
F. Gskt: [1] Included



PA3907 Replacement for Ecolite Air Filter in Disposable Housing
Fits: Farr Air Cleaners; Ottawa Trucks
Replaces: Farr 400292-000, 400292-000-A
O.D.: 11 1/2 (292.1)
Inlet: 6
Outlet: 7
Height: 16 29/32 (429.4)



PA3908 Outer Air Element
Fits: Kubota Tractors
Use With: PA3909
Replaces: Kubota 17301-11080
O.D.: 6 (152.4)
I.D.: 5/8 (15.9) & 4 (101.6)
Height: 7 3/4 (196.9)
A. Gskt: [1] Attached
F. Gskt: G103-N



Measurements Are Shown In Inches And (Millimeters)

WARNING: These products can expose you to chemicals, including Diisononyl Phthalate, Carbon black extracts, Nickel, 1,3 Butadiene, Ethylene Oxide, Epichlorohydrin, which are known to the State of California to cause cancer, and Bisphenol, Ethylene Glycol, Ethylene Oxide, 1,3 Butadiene, Epichlorohydrin, which are known to the State of California to cause birth defects or other reproductive harm. For more information go to www.P65Warnings.ca.gov.

PA3909



Inner Air Element

Fits Inside: PA3908
Fits: Kubota Tractors
Replaces: Kubota 17301-11180
O.D.: 3 7/8 (98.4)
I.D.: 5/8 (15.9) & 3 3/16 (81.0)
Height: 7 1/32 (178.6)
A. Gskt: [1] Attached
F. Gskt: [1] Included

PA3910-FN



Outer Air Element with Fins and Lid

Fits: J.C. Bamford Equipment
Use With: PA3911
Replaces: J.C. Bamford 32/911801
O.D.: 7 13/16 (198.4)
 Lid 8 3/8 (212.7)
I.D.: 19/32 (15.1) & 3 15/32 (88.1)
Height: 9 5/16 (236.5)
A. Gskt: [1] Attached
F. Gskt: [1] Included, [1] Wing Nut

PA3911



Inner Air Element

Fits Inside: PA3910-FN
Fits: J.C. Bamford Equipment
Replaces: J.C. Bamford 32/911802
O.D.: 3 3/8 (85.7)
 Flange 4 5/32 (105.6)
I.D.: 21/32 (16.7) & 2 29/32 (73.8)
Height: 7 21/32 (194.5)
A. Gskt: [1] Attached
F. Gskt: [1] Metal Washer

PA3914



Outer Air Element

Fits: Hino Equipment
Use With: PA3915
Replaces: Hino 17801-2910, 17801-2910M
O.D.: 10 27/32 (275.4)
I.D.: 15/16 (23.8) & 6 1/2 (165.1)
Height: 14 1/2 (368.3)
A. Gskt: [1] Attached
F. Gskt: [1] Included

PA3915



Inner Air Element

Fits Inside: PA3914
Fits: Hino Equipment
Replaces: Hino 17801-2900, 17801-2900M
O.D.: 6 3/8 (161.9)
I.D.: 5/8 (15.9) & 5 9/32 (134.1)
Height: 12 3/8 (314.3)
A. Gskt: [1] Attached
F. Gskt: G103-N

PA3916



Air Element

Fits: MCI, Universal Coach Buses
Replaces: MCI 9031073;
 Universal Coach T12-1111
O.D.: 12 3/32 (307.2)
I.D.: 7/8 (22.2) & 7 11/16 (195.3)
Height: 19 1/2 (495.3)
A. Gskt: [1] Attached
F. Gskt: [1] Included

PA3917



Cab Air Element

Fits: Caterpillar Equipment
Replaces: Caterpillar 1212761, 6T9504,
 7G6599; Fleetguard AF27700
Length: 17 15/32 (443.7)
Width: 8 1/2 (215.9)
Height: 5/8 (15.9)

PA3918



Outer Air Element with Lift Bar

Fits: John Deere Tractors
Use With: PA3919
Replaces: John Deere AL78869
O.D.: 8 29/32 (226.2)
 Flange 11 7/32 (285.0)
I.D.: 4 21/32 (118.3) One End
Height: 12 7/32 (310.4)
A. Gskt: [1] Attached

PA3919



Inner Air Element with 3 Bolts

Fits Inside: PA3918
Fits: John Deere Tractors
Replaces: John Deere AL78870
O.D.: 6 11/32 (161.1)
 Flange 9 3/8 (238.1)
I.D.: 4 21/32 (118.3) One End
Height: 5 1/8 (130.2)
A. Gskt: [1] Attached
O-Ring: [3] Included

RS3920



Radial Seal Outer Air Element

Fits: J.C. Bamford, Massey Ferguson,
 Volvo Equipment
Use With: RS3921
Replaces: J.C. Bamford 32/915802
O.D.: 5 31/32 (151.6)
I.D.: 3 3/8 (85.7) One End
Height: 14 1/8 (358.8)

RS3921



Radial Seal Inner Air Element

Fits Inside: RS3920
Fits: J.C. Bamford, Massey Ferguson
 Equipment
Replaces: J.C. Bamford 32/915801
O.D.: 3 3/32 (78.6)
I.D.: 2 15/16 (74.6) One End
Height: 13 19/32 (345.3)

RS3922



Radial Seal Outer Air Element

Fits: Deutz, Deutz-Fahr, Fendt, Gehl, Massey
 Ferguson Tractors; J.C. Bamford Excavators,
 Loaders; Terex Lift Trucks
Use With: RS3923
Replaces: J.C. Bamford 32/917804
O.D.: 6 3/8 (161.9)
I.D.: 3 3/4 (95.3) One End
Height: 14 3/4 (374.7)

Measurements Are Shown In Inches And (Millimeters)

WARNING: These products can expose you to chemicals, including Diisononyl Phthalate, Carbon black extracts, Nickel, 1,3 Butadiene, Ethylene Oxide, Epichlorohydrin, which are known to the State of California to cause cancer, and Bisphenol, Ethylene Glycol, Ethylene Oxide, 1,3 Butadiene, Epichlorohydrin, which are known to the State of California to cause birth defects or other reproductive harm. For more information go to www.P65Warnings.ca.gov.

RS3923



Radial Seal Inner Air Element
Fits Inside: RS3922
Fits: Deutz, Deutz-Fahr, Fendt, Massey Ferguson Tractors; J.C. Bamford Excavators, Loaders; Terex Lift Trucks
Replaces: J.C. Bamford 32/917805
O.D.: 3 17/32 (89.7)
I.D.: 3 13/32 (86.5) One End
Height: 14 7/32 (361.2)

PA3929

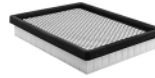

Cab Air Element
Fits: John Deere Tractors
Replaces: John Deere RE48882
Length: 9 1/32 (229.4)
Width: 7 3/16 (182.6)
Height: 1 5/8 (41.3)

PA3924-FN



Outer Air Element with Fins and Lid
Fits: John Deere, Zetor Tractors
Use With: PA2689
Replaces: Zetor 79011284
O.D.: 7 13/16 (198.4)
 Lid 8 3/8 (212.7)
I.D.: 19/32 (15.1) & 3 15/32 (88.1)
Height: 11 1/2 (292.1)
A. Gskt: [1] Attached
F. Gskt: [1] Included, [1] Wing Nut

RS3930



Radial Seal Inner Air Element
Fits Inside: RS3715
Fits: Allmand, Bobcat, Exmark, John Deere Equipment
Replaces: John Deere M123378; Walker 5090-3
O.D.: 1 11/16 (42.9)
I.D.: 1 3/16 (30.2) One End
Height: 6 5/8 (168.3)

PA3925



Inner Air Element
Fits Inside: RS4967
Fits: Volvo Trucks
Replaces: Volvo 1665937, 1665937-7
O.D.: 7 31/32 (202.4)
I.D.: 7 (177.8) One End
Height: 17 19/32 (446.9)

PA3931



Foam Inside Cab Air Element
Fits: John Deere Tractors
Replaces: John Deere R120501
Length: 13 (330.2)
Width: 7 (177.8)
Height: 1/2 (12.5)

PA3932



Outer Air Element
Notes: Uses 2 filters per application.
Fits: Caterpillar Generators, Industrial, Marine Engines
Use With: PA3933
Replaces: Caterpillar 113-1578
O.D.: 19 9/32 (489.7)
I.D.: 12 7/8 (327.0) One End
Height: 18 5/16 (465.1)
A. Gskt: [1] Attached

RS3926



Radial Seal Outer Air Element
Fits: Case-International Equipment
Use With: RS3927
Replaces: Case 243968A1
O.D.: 12 31/32 (329.4)
I.D.: 6 13/16 (173.0) One End
Height: 22 9/32 (565.9)

PA3933



Inner Air Element with 8 Bolt Holes
Fits Inside: PA3932
Fits: Caterpillar Generators, Industrial, Marine Engines
Replaces: Caterpillar 113-1579
O.D.: 12 25/32 (324.6)
 Flange 15 5/8 (396.9)
I.D.: 10 9/32 (261.1) One End
Height: 17 3/4 (450.9)
A. Gskt: [1] Attached

RS3927



Radial Seal Inner Air Element
Fits Inside: RS3926
Fits: Case-International Equipment
Replaces: Case 243969A1
O.D.: 6 7/8 (174.6)
I.D.: 5 5/32 (131.0) One End
Height: 21 15/32 (545.3)

RS3934



Radial Seal Outer Air Element
Fits: Case-International Equipment
Use With: RS3935
Replaces: Case 187471A1
O.D.: 8 5/32 (207.2)
I.D.: 4 3/16 (106.4) One End
Height: 15 5/8 (396.9)

PA3928



Set of 2 Cab Air Elements
Notes: Uses 2 filters per application.
Fits: John Deere Tractors
Replaces: John Deere AL115625, AL111748
Each Filter:
Length: 23 5/16 (592.1)
Width: 5 3/16 (131.8) to 5 3/8 (136.5)
Height: 3 11/32 (84.9)
A. Gskt: [1] Included

RS3935



Radial Seal Inner Air Element
Fits Inside: RS3934, RS3971
Fits: Case-International Equipment
Replaces: Case 187472A1
O.D.: 4 1/4 (108.0)
I.D.: 2 3/4 (69.9) One End
Height: 15 (381.0)

Measurements Are Shown In Inches And (Millimeters)

WARNING: These products can expose you to chemicals, including Diisononyl Phthalate, Carbon black extracts, Nickel, 1,3 Butadiene, Ethylene Oxide, Epichlorohydrin, which are known to the State of California to cause cancer, and Bisphenol, Ethylene Glycol, Ethylene Oxide, 1,3 Butadiene, Epichlorohydrin, which are known to the State of California to cause birth defects or other reproductive harm. For more information go to www.P65Warnings.ca.gov.

RS3936



Radial Seal Air Element

Fits: Mack Trucks
Replaces: Mack 2MD4139M, 57MD46M
O.D.: 9 9/32 (235.7)
I.D.: 5 25/32 (146.8) One End
Height: 25 17/32 (648.5)

RS3942



Radial Seal Outer Air Element

Fits: Ahlmann, Massey Ferguson Tractors;
Atlas Copco Compressors; Bomag Compactors;
Melroe-Bobcat Lift Trucks
Use With: RS3943
Replaces: Mann & Hummel C14200
O.D.: 4 31/32 (126.2)
I.D.: 2 31/32 (75.4) One End
Height: 12 17/32 (318.3)

PA3937

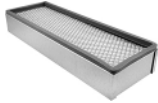

Cab Air Element

Notes: Uses 2 filters per application.
Fits: Caterpillar Equipment
Replaces: Caterpillar 113-0305
Length: 16 7/16 (417.5)
Width: 5 9/16 (141.3)
Height: 2 9/16 (65.1)
A. Gskt: [1] Attached

RS3943



Radial Seal Inner Air Element

Fits Inside: RS3942
Fits: Ahlmann, Massey Ferguson Tractors;
Atlas Copco Compressors; Bomag Compactors;
Melroe-Bobcat Lift Trucks
Replaces: Deutz 1180869;
Massey Ferguson 3901463-M1
O.D.: 2 3/4 (69.9)
I.D.: 2 11/16 (68.3) One End
Height: 12 1/16 (306.4)

PA3938



Air Element

Fits: Mack Trucks
Replaces: Mack 57MD47
O.D.: 10 27/32 (275.4)
I.D.: 15/16 (23.8) & 6 1/2 (165.1)
Height: 20 15/32 (519.9)
A. Gskt: [1] Attached
F. Gskt: [1] Included

PA3944



Panel Air Element

Replaces: Dart 625081, 842408; Euclid 1004320
Length: 20 (508.0)
Width: 15 (381.0)
Height: 2 3/16 (55.6)

PA3939

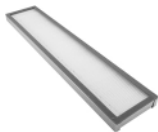

Cab Air Element

Fits: Caterpillar Excavators
Replaces: Caterpillar 411278
Length: 23 5/8 (600.1)
Width: 4 7/8 (123.8)
Height: 1 1/16 (27.0)

PA3945

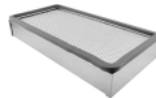

Cab Air Element

Fits: Hitachi Equipment
Replaces: Hitachi 4206637
Length: 17 1/8 (435.0)
Width: 8 7/16 (214.3)
Height: 2 11/16 (68.3)
A. Gskt: [1] Attached

RS3940



Radial Seal Outer Air Element

Contains: Flame Retardant Media
Fits: Toyota Lift Trucks
Use With: RS4962
Replaces: Toyota 17741-23600-71,
17743-23600-71
O.D.: 5 13/32 (137.3)
I.D.: 3 3/16 (81.0) One End
Height: 11 1/32 (280.2)

PA3946



Air Element

Fits: Volvo Trucks
Replaces: Volvo 6778729
O.D.: 7 15/16 (201.6)
I.D.: 7/16 (11.1) & 4 5/8 (117.5)
Height: 22 19/32 (573.9)
A. Gskt: [1] Attached
F. Gskt: [1] Included

PA3941



Air Element

Fits: Hatz Diesel Engines; Bitelli Paving
Equipment
Replaces: Hatz 1493000
O.D.: 6 1/2 (165.1)
I.D.: 3 15/32 (88.1)
Height: 3 21/32 (92.9)

PA3947



Air Element

Fits: Isuzu Trucks
Replaces: Isuzu 5-14215-008-0, 5-14215-030-0;
GMC 94055960
O.D.: 6 3/32 (154.8)
I.D.: 17/32 (13.5) & 3 1/8 (79.4)
Height: 10 13/16 (274.6)
A. Gskt: [1] Attached
F. Gskt: [1] Included

PA3948



Outer Air Element with Lift Bar

Fits: New Holland Tractors
Use With: PA3949
Replaces: New Holland 82001819, 82008606
O.D.: 8 1/2 (215.9)
Boot Gasket 10 (254.0)
I.D.: 19/32 (15.1) & 4 27/32 (123.0)
Height: 15 9/16 (395.3)
A. Gskt: [2] Attached
F. Gskt: [1] Included

Measurements Are Shown In Inches And (Millimeters)



WARNING: These products can expose you to chemicals, including Diisononyl Phthalate, Carbon black extracts, Nickel, 1,3 Butadiene, Ethylene Oxide, Epichlorohydrin, which are known to the State of California to cause cancer, and Bisphenol, Ethylene Glycol, Ethylene Oxide, 1,3 Butadiene, Epichlorohydrin, which are known to the State of California to cause birth defects or other reproductive harm. For more information go to www.P65Warnings.ca.gov.

PA3949



Inner Air Element with Lift Tabs
Notes: Oil Wetted Media
Fits Inside: PA3948
Fits: New Holland Tractors
Replaces: New Holland 82001820, 82008607
O.D.: 4 23/32 (119.9)
 Flange 5 29/32 (150.0)
I.D.: 13/32 (10.3) & 3 31/32 (100.8)
Height: 15 3/8 (390.5)
A. Gskt: [2] Attached

PA3950



Inner Air Element
Fits Inside: PA3790
Fits: Massey Ferguson Tractors
Replaces: Massey Ferguson 3515587-M1, 3595501-M1
O.D.: 3 3/8 (85.7)
 Flange 3 25/32 (96.0)
I.D.: 21/32 (16.7) & 2 7/8 (73.0)
Height: 9 1/32 (229.4)
A. Gskt: [1] Attached
F. Gskt: [1] Washer

PA3951



Conical-Shaped Air Element
Notes: Inside-Out Flow Direction
Fits: Ford, GMC, Mack Trucks
Replaces: Ford D8HZ-9601-B; GMC 8997222; International 526059-C91
O.D.: 7 13/32 (188.1) to 10 13/32 (264.3)
I.D.: 6 15/16 (176.2) One End
Height: 29 (736.6)
A. Gskt: [2] Attached
F. Gskt: G298-AF

RS3952



Radial Seal Air Element
Fits: DAF Trucks
Replaces: DAF 1353115
O.D.: 10 31/32 (278.6)
I.D.: 5 13/16 (147.6) One End
Height: 19 29/32 (505.6)

PA3953



Panel Air Element
Fits: Genie Industrial Lifts
Replaces: Lombardini 2175.164, 107.2175.160
Length: 8 7/8 (225.4)
Width: 5 5/16 (134.9)
Height: 1 5/8 (41.3)

RS3954



Radial Seal Outer Air Element
Fits: New Holland, Terex, Volvo Equipment
Use With: RS3547
Replaces: Perkins 26510362
O.D.: 4 1/8 (104.8)
I.D.: 2 5/16 (58.7) One End
Height: 11 27/32 (300.8)

PA3956



Air Element with Foam Wrap
Fits: Kohler Generators
Replaces: Cummins 3903876, 3903879; Kohler 253108
O.D.: 8 1/32 (204.0)
I.D.: 5 5/16 (134.9)
Height: 10 15/16 (277.8)

PA3957



Oval Air Element with Foam Wrap
Fits: American Sportsworks Utility Vehicles; Genie Lifts; Honda Engines; Toro Loaders
Use With: PA3957 FOAM
Replaces: Honda 17210-ZE3-010, 17210-ZE3-505
O.D.: 3 25/32 (96.0) to 4 13/32 (111.9)
I.D.: 1/4 (6.4) & 1 5/8 (41.3)
Height: 3 5/8 (92.1)
A. Gskt: [1] Metal Washer
Grommets: [1] Attached

PA3957 FOAM



Foam Blanket for PA3957
Use With: PA3957
O.D.: 3 27/32 (97.6)
I.D.: 3 3/8 (85.7)
Length: 3 3/16 (81.0)
Height: 2 27/32 (72.2)

PA3958



Foam Wrap
Fits: Detroit Diesel Marine Engines
Replaces: GMC 6422214, 25177939
O.D.: 8 19/32 (218.3)
I.D.: 7 19/32 (192.9)
Height: 7 (177.8)

PA3959



Air Element
Fits: Kubota Equipment
Replaces: Kubota 11420-11180
O.D.: 4 23/32 (119.9)
I.D.: 1 31/32 (50.0)
Height: 1 31/32 (50.0)
A. Gskt: [2] Attached

PA3961



Air Element
Fits: Iveco Trucks
Replaces: Iveco 1908233, 1908868
O.D.: 6 3/32 (154.8)
I.D.: 3 5/32 (80.2) One End
Height: 13 17/32 (343.7)

Measurements Are Shown In Inches And (Millimeters)

WARNING: These products can expose you to chemicals, including Diisononyl Phthalate, Carbon black extracts, Nickel, 1,3 Butadiene, Ethylene Oxide, Epichlorohydrin, which are known to the State of California to cause cancer, and Bisphenol, Ethylene Glycol, Ethylene Oxide, 1,3 Butadiene, Epichlorohydrin, which are known to the State of California to cause birth defects or other reproductive harm. For more information go to www.P65Warnings.ca.gov.

BA3964(4)

Set of 4 Nylon Screen Supported Bag Air Elements



Notes: Oil Wetted Media
Fits: Railroad Applications
Replaces: Clark EG2; EMD 9522063
Length: 22 (558.8)
Width: 18 3/4 (476.3)
Height: 5 (127.0)

RS3971

Radial Seal Outer Air Element



Fits: Gradall, Volvo Equipment
Use With: RS3935, RS5304
Replaces: Gradall 91343059
O.D.: 7 11/32 (186.5)
I.D.: 4 5/32 (105.6) One End
Height: 15 21/32 (397.7)

BA3965(4)

Set of 4 Nylon Screen Supported Bag Air Elements



Notes: Oil Wetted Media
Fits: Railroad Applications
Replaces: Clark EG1; EMD 8470903;
 General Electric 41A218313P1
Length: 29 3/8 (746.1)
Width: 27 3/8 (695.3)
Height: 6 3/8 (161.9)

PA3972

Outer Air Element



Fits: Kubota Tractors
Use With: PA3973
Replaces: Kubota 15724-11080
O.D.: 6 3/32 (154.8)
I.D.: 21/32 (16.7) & 4 3/32 (104.0)
Height: 9 5/8 (244.5)
A. Gskt: [1] Attached
F. Gskt: [1] Washer

PA3966

Air Element



Fits: EMD, GE Locomotives
Replaces: EMD 8402068; Farr 116367-001;
 General Electric 41A216205P1
O.D.: 8 (203.2)
I.D.: 6 1/8 (155.6)
Height: 12 5/32 (308.8)

PA3973

Inner Air Element



Fits Inside: PA3972
Fits: Kubota Tractors
Replaces: Kubota 15724-11180
O.D.: 3 7/8 (98.4)
I.D.: 5/8 (15.9) & 3 7/32 (81.8)
Height: 8 13/16 (223.8)
A. Gskt: [1] Attached
F. Gskt: [1] Metal Washer

PA3967

Air Element



Fits: John Deere Lawn & Garden Equipment
Replaces: John Deere AM101812;
 Onan 140-1911, 140-2523
O.D.: 8 1/4 (209.6)
I.D.: 6 13/32 (162.7)
Height: 3 13/16 (96.8)

RS3974

Radial Seal Outer Air Element



Fits: John Deere, New Holland Loaders
Use With: RS3975
Replaces: John Deere AT178583
O.D.: 9 9/32 (235.7)
I.D.: 5 5/32 (131.0) One End
Height: 21 7/8 (555.6)

PA3969

Air Element



Replaces: Mitsubishi 91261-08200
O.D.: 5 5/16 (134.9)
I.D.: 7/16 (11.1) & 3 1/16 (77.8)
Height: 10 3/8 (263.5)
A. Gskt: [1] Attached

RS3975

Radial Seal Inner Air Element



Fits Inside: RS3974
Fits: John Deere, New Holland Loaders
Replaces: John Deere AT178584
O.D.: 5 1/4 (133.4)
I.D.: 3 5/8 (92.1) One End
Height: 21 7/32 (539.0)

PA3970

Air Element



Fits: Hatz Engines
Replaces: Hatz 40084500
O.D.: 6 1/2 (165.1)
I.D.: 3 1/2 (88.9)
Height: 3 21/32 (92.9)

PA3978

Air Element



Fits: Sullair Compressors
Replaces: Sullair 405158, 405158S
O.D.: 12 3/32 (307.2)
I.D.: 13/32 (10.3) & 6 3/32 (154.8)
Height: 15 15/32 (392.9)
A. Gskt: [1] Attached
F. Gskt: [1] Metal Washer

Measurements Are Shown In Inches And (Millimeters)



WARNING: These products can expose you to chemicals, including Diisononyl Phthalate, Carbon black extracts, Nickel, 1,3 Butadiene, Ethylene Oxide, Epichlorohydrin, which are known to the State of California to cause cancer, and Bisphenol, Ethylene Glycol, Ethylene Oxide, 1,3 Butadiene, Epichlorohydrin, which are known to the State of California to cause birth defects or other reproductive harm. For more information go to www.P65Warnings.ca.gov.

PA3979

Air Element with Lid



Fits: Kubota Equipment
Replaces: Kubota 17351-11080, 17351-11083
O.D.: 5 1/4 (133.4)
Lid 7 (177.8)
I.D.: 9/16 (14.3) & 2 27/32 (72.2)
Height: 11 1/2 (292.1)
A. Gskt: [2] Attached

RS3988

Radial Seal Outer Air Element



Notes: Also available in HSG3079 or HSG3080 Housings.
Fits: Case, Caterpillar, Hitachi, Kubota, Mustang Equipment
Use With: RS3703
Replaces: Case 133720A1; Caterpillar 134-8726; Hitachi 4290940; John Deere AM129028
O.D.: 5 1/32 (127.8)
I.D.: 3 5/32 (80.2) One End
Height: 12 5/16 (312.7)
Related To: RS3549 (with Flame Retardant Media)

PA3980

Cab Air Element

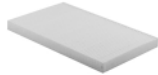

Fits: M.A.N. Buses, Trucks
Replaces: M.A.N. 81.69100.011
Length: 15 23/32 (399.3)
Width: 7 3/32 (180.2)
Height: 1 9/16 (39.7)

PA3989-FN

Air Element with Fins



Contains: Flame Retardant Media
Fits: Caterpillar, Mitsubishi Lift Trucks
Replaces: Mitsubishi 91861-01600
O.D.: 6 3/32 (154.8)
Fins 7 13/16 (198.4)
I.D.: 3/4 (19.1) & 3 15/32 (88.1)
Height: 12 1/8 (308.0)
A. Gskt: [1] Attached
F. Gskt: [1] Washer

PA3983-FN

Air Element with Fins



Fits: Kubota Engines
Replaces: Kubota 14971-11180
O.D.: 3 3/8 (85.7)
Fins 4 5/32 (105.6)
I.D.: 1 7/32 (31.0) & 1 1/4 (31.8)
Height: 4 1/32 (102.4)

RS3990

Radial Seal Outer Air Element



Fits: Kubota Engines
Use With: RS3991
Replaces: Atlas Copco 29149300-00; KHD 1319141; Worthington 6211455100
O.D.: 4 9/16 (115.9)
I.D.: 2 5/8 (66.7) One End
Height: 9 7/8 (250.8)

PA3984

Air Element with Lid



Fits: Lister Engines
Replaces: Lister 38207903
O.D.: 5 (127.0)
Lid 7 1/8 (181.0)
I.D.: 11/16 (17.5) & 2 27/32 (72.2)
Height: 13 29/32 (353.2)
A. Gskt: [1] Attached
F. Gskt: [1] Included, [1] Wing Nut

RS3991

Radial Seal Inner Air Element



Fits Inside: RS3990
Fits: Kubota Engines
Replaces: KHD 1180868
O.D.: 2 7/32 (56.4)
to 2 1/4 (57.2)
I.D.: 1 5/8 (41.3) One End
Height: 9 13/32 (238.9)

PA3985

Inner Air Element



Fits Inside: PA3670
Fits: Komatsu Excavators
Replaces: Komatsu 600-181-9480
O.D.: 3 3/8 (85.7)
Flange 4 3/16 (106.4)
I.D.: 11/16 (17.5) & 2 19/32 (65.9)
Height: 11 (279.4)
A. Gskt: [1] Attached
F. Gskt: [1] Included

RS3992

Radial Seal Outer Air Element



Fits: Deutz, Massey Ferguson, Liebherr, Volvo Equipment
Use With: RS3993
Replaces: Atlas Copco 2914930800; Demag 11323374
O.D.: 7 11/16 (195.3)
I.D.: 4 17/32 (115.1) One End
Height: 15 23/32 (399.3)

PA3986

Cab Air Element



Fits: Volvo Trucks
Replaces: Volvo 8089705
Length: 11 13/32 (289.7)
Width: 4 23/32 (119.9)
Height: 1 23/32 (43.7)

RS3993

Radial Seal Inner Air Element



Fits Inside: RS3992
Fits: Deutz, Massey Ferguson, Liebherr, Volvo Equipment
Replaces: Atlas Copco 16158928, 29149309; Bomag 5821148; Deutz 1180872, 4415903; Liebherr 7026329; Massey Ferguson 3901478-M1
O.D.: 4 11/32 (110.3)
I.D.: 3 9/16 (90.5) One End
Height: 15 5/32 (385.0)

PA3987

Replacement for Ecolite Air Element in Disposable Housing



Contains: Bleeder Valve
Fits: Blue Bird, Thomas Buses
Replaces: Farr 119861-003
O.D.: 11 (279.4)
Inlet: 7
Outlet: 6
Height: 19 11/16 (500.1)

Measurements Are Shown In Inches And (Millimeters)

WARNING: These products can expose you to chemicals, including Diisononyl Phthalate, Carbon black extracts, Nickel, 1,3 Butadiene, Ethylene Oxide, Epichlorohydrin, which are known to the State of California to cause cancer, and Bisphenol, Ethylene Glycol, Ethylene Oxide, 1,3 Butadiene, Epichlorohydrin, which are known to the State of California to cause birth defects or other reproductive harm. For more information go to www.P65Warnings.ca.gov.

RS3994



Radial Seal Outer Air Element
Fits: Atlas Copco Compressors; Caterpillar, Massey Ferguson Equipment
Use With: RS3995
Replaces: Atlas Copco 16138004, 29149310; Bomag 5821149; Claas 7521980; Deutz 1181003; Massey Ferguson 3902783-M1
O.D.: 8 11/16 (220.7)
I.D.: 4 15/16 (125.4) One End
Height: 15 27/32 (402.4)

RS3995



Radial Seal Inner Air Element
Contains: [1] Grease packet
Fits Inside: RS3994
Fits: Atlas Copco Compressors; Caterpillar, Massey Ferguson Equipment
Replaces: Bomag 5821150; Claas 751199.0, 752199.0; Deutz 1181004; Massey Ferguson 392782-M1
O.D.: 4 23/32 (119.9)
I.D.: 4 (101.6) One End
Height: 15 1/4 (387.4)

RS3996



Radial Seal Outer Air Element
Fits: Atlas Copco Compressors; Demag, Grove, Liebherr Cranes
Use With: RS3997
Replaces: Atlas Copco 2914-5023-00; Massey Ferguson 3902806-M1
O.D.: 9 1/2 (241.3)
I.D.: 5 3/4 (146.1) One End
Height: 21 5/32 (537.4)

RS3997



Radial Seal Inner Air Element with Bail Handle
Fits Inside: RS3996
Fits: Atlas Copco Compressors; Demag, Grove, Liebherr Cranes
Replaces: Atlas Copco 2914-5024-00; Massey Ferguson 3902812-M1
O.D.: 5 17/32 (140.5)
I.D.: 4 25/32 (121.4) One End
Height: 20 9/16 (522.3)

RS3998



Radial Seal Outer Air Element
Fits: Caterpillar Equipment; Demag, Grove, Liebherr Cranes
Use With: RS3999
Replaces: Atlas Copco 2914-5017-00; CompAir 11516/974; Ingersoll-Rand 89288971
O.D.: 11 23/32 (297.7)
I.D.: 8 1/32 (204.0) One End
Height: 23 5/16 (592.1)
Related To: RS3998XP (Extreme Performance Nano Version)

RS3998XP



Extreme Performance Nano Radial Seal Outer Air Element
Fits: Caterpillar Equipment; Demag, Grove, Liebherr Cranes
Use With: RS3999
Replaces: Atlas Copco 2914-5017-00; CompAir 11516/974; Ingersoll-Rand 89288971
O.D.: 11 23/32 (297.7)
I.D.: 8 1/32 (204.0) One End
Height: 23 5/16 (592.1)
Related To: RS3998 (Standard Media Version)

RS3999



Radial Seal Inner Air Element
Fits Inside: RS3998, RS3998XP
Fits: Caterpillar Loaders, Motor Graders; Demag, Grove, Liebherr Cranes
Replaces: Atlas Copco 2914-5018-00
O.D.: 7 29/32 (200.8)
I.D.: 7 9/16 (192.1) One End
Height: 22 5/8 (574.7)

PA4005



Air Element
Fits: Ford Vans
Replaces: Ford E1VZ-9601-A, F1UZ-9601-A
O.D.: 12 (304.8)
I.D.: 8 19/32 (218.3)
Height: 4 13/32 (111.9)

PA4015



Panel Air Element
Fits: Chrysler, Eagle, Mazda, Mitsubishi Automotive
Replaces: Mazda KL47-13-Z40; Mitsubishi MB906051
Length: 9 1/32 (229.4)
Width: 7 9/32 (184.9)
Height: 2 1/16 (52.4)

PA4016



Panel Air Element
Fits: Chrysler, Mitsubishi Automotive
Replaces: Mitsubishi MD620472
Length: 8 7/8 (225.4)
Width: 8 7/8 (225.4)
Height: 1 13/32 (35.7)

PA4018



Panel Air Element
Fits: Infiniti FX50, FX35; Nissan 300ZX, Lucino, Rogue, Sentra
Replaces: General Motors 25147124; Nissan 1654630P00, 1654673C10
Length: 9 1/32 (229.4)
Width: 6 5/8 (168.3)
Height: 1 7/32 (31.0)

PA4023



Panel Air Element
Fits: Chevrolet, Geo Tracker; Suzuki Sidekick
Replaces: GMC 96057994; Suzuki 13780-61A00
Length: 10 1/8 (257.2)
Width: 8 9/32 (210.3)
Height: 1 11/16 (42.9)

PA4028



Panel Air Element
Fits: Lexus, Toyota Automotive
Replaces: Toyota 17801-74060
Length: 12 3/16 (309.6)
Width: 7 3/8 (187.3)
Height: 1 11/16 (42.9)

PA4031



Panel Air Element
Fits: Toyota Automotive
Replaces: Toyota 17801-11080
Length: 9 13/16 (249.2)
Width: 4 11/16 (119.1)
Height: 2 (50.8)

Measurements Are Shown In Inches And (Millimeters)

WARNING: These products can expose you to chemicals, including Diisononyl Phthalate, Carbon black extracts, Nickel, 1,3 Butadiene, Ethylene Oxide, Epichlorohydrin, which are known to the State of California to cause cancer, and Bisphenol, Ethylene Glycol, Ethylene Oxide, 1,3 Butadiene, Epichlorohydrin, which are known to the State of California to cause birth defects or other reproductive harm. For more information go to www.P65Warnings.ca.gov.

PA4041 Air Element
Fits: Daihatsu Automotive
Replaces: Daihatsu 17801-87601-000
O.D.: 6 1/8 (155.6)
I.D.: 15/32 (11.9) & 3 3/8 (85.7)
Height: 6 7/32 (158.0)
A. Gskt: [1] Attached



PA4042 Panel Air Element
Fits: Porsche Automotive
Replaces: Porsche 91111018502
Length: 15 13/16 (401.6)
Width: 7 3/32 (180.2)
Height: 1 5/8 (41.3)

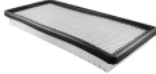

PA4043 Panel Air Element
Fits: Hyundai Automotive
Replaces: Hyundai 28113-22051
Length: 9 21/32 (245.3)
Width: 6 5/16 (160.3)
Height: 1 15/32 (37.3)

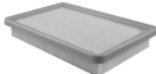

PA4044 Panel Air Element
Fits: Ford Automotive
Replaces: Ford F6DX-9601-BA, F6DZ-9601-B
Length: 9 15/16 (252.4)
Width: 7 1/32 (178.6)
Height: 1 9/16 (39.7)

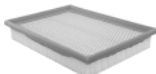

PA4045 Panel Air Element
Fits: Ford Automotive
Replaces: Ford F4BZ-9601-A
Length: 8 7/32 (208.8)
Width: 5 7/8 (149.2)
Height: 1 15/32 (37.3)

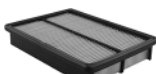

PA4046 Panel Air Element
Fits: Jeep Grand Cherokee;
 Nissan Automotive
Replaces: Chrysler 53007386
Length: 11 3/8 (288.9)
Width: 9 3/4 (247.7)
Height: 1 15/32 (37.3)

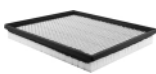

PA4048 Panel Air Element
Fits: BMW Automotive
Replaces: BMW 13721730946
Length: 9 21/32 (245.3)
Width: 7 (177.8)
Height: 2 5/16 (58.7)

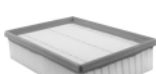

PA4049 Panel Air Element
Fits: Saturn Automotive
Replaces: Saturn 21000938
Length: 9 27/32 (250.0)
Width: 5 15/32 (138.9)
Height: 2 1/16 (52.4)
A. Gskt: [1] Attached



PA4050 Panel Air Element
Fits: Honda Automotive
Replaces: Honda 17220-P07-000
Length: 8 7/32 (208.8)
Width: 7 1/4 (184.2)
Height: 1 21/32 (42.1)
A. Gskt: [1] Attached

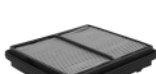

PA4060 Panel Air Element
Fits: Lexus, Toyota Automotive
Replaces: Toyota 17801-46060
Length: 9 21/32 (245.3)
Width: 8 1/8 (206.4)
Height: 2 1/16 (52.4)



PA4069 Panel Air Element
Fits: Ford Automotive
Replaces: Ford F23E-9601-BB, F23Z-9601-B
Length: 10 1/16 (255.6)
Width: 7 5/32 (181.8)
Height: 1 9/16 (39.7)

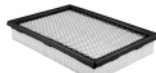

PA4070 Air Element
Fits: Nissan Light-Duty Trucks
Replaces: Nissan 16546-89G00; GMC 25147122
O.D.: 13 1/16 (331.8)
Height: 2 3/8 (60.3)
I.Gskt: [2] Included



PA4071 Air Element
Fits: Ford Automotive
Replaces: Ford F4ZZ-9601-A
O.D.: 4 5/8 (117.5)
 Flange 6 13/32 (162.7)
I.D.: 3 3/16 (81.0) One End
Height: 7 15/32 (189.7)



PA4072 Air Element
Replaces: Ingersoll-Rand 39449293
O.D.: 7 7/8 (200.0)
I.D.: 4 1/8 (104.8)
Height: 4 27/32 (123.0)



PA4073 Air Element with Foam Pad
Fits: Ford Trucks
Replaces: Ford F3TZ-9601-Z
Length: 10 13/32 (264.3)
Width: 8 3/8 (212.7)
Height: 1 25/32 (45.2)



PA4075 Air Element
Fits: Ford Automotive, Light-Duty Trucks
Replaces: Ford F50Y-9601-A
O.D.: 7 (177.8)
 Flange 8 1/8 (206.4)
I.D.: 4 7/32 (107.2) One End
Height: 7 9/16 (192.1)





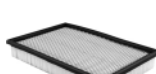





PA4076 Panel Air Element
Fits: Ford, Nissan Automotive
Replaces: Ford F3XY-9601-A;
 Nissan 16546-0B000
Length: 10 29/32 (277.0)
Width: 7 3/32 (180.2)
Height: 1 19/32 (40.5)

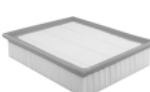
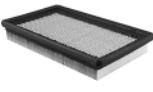
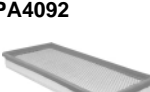

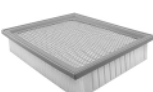
Measurements Are Shown In Inches And (Millimeters)

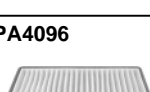
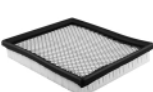
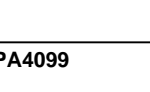
WARNING: These products can expose you to chemicals, including Diisononyl Phthalate, Carbon black extracts, Nickel, 1,3 Butadiene, Ethylene Oxide, Epichlorohydrin, which are known to the State of California to cause cancer, and Bisphenol, Ethylene Glycol, Ethylene Oxide, 1,3 Butadiene, Epichlorohydrin, which are known to the State of California to cause birth defects or other reproductive harm. For more information go to www.P65Warnings.ca.gov.

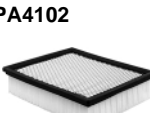
<p>PA4077</p> 	<p>Panel Air Element Fits: Acura, Honda, Isuzu Automotive Replaces: Honda 17220-POA-A00; Isuzu 5-86202-255-0 Length: 12 1/16 (306.4) Width: 7 9/32 (184.9) Height: 2 1/8 (54.0) A. Gskt: [1] Attached</p>	<p>PA4089</p> 	<p>Air Element Fits: Ford Automotive Replaces: Ford F67Z-9601-AA O.D.: 5 5/32 (131.0) Flange 6 23/32 (170.7) I.D.: 3 1/32 (77.0) One End Height: 5 29/32 (150.0)</p>
<p>PA4078</p> 	<p>Panel Air Element Fits: Chevrolet, Geo, Suzuki Automotive Replaces: GMC 25175325; Suzuki 13780-58B00 Length: 11 5/8 (295.3) Width: 5 9/32 (134.1) Height: 2 3/32 (53.2)</p>	<p>PA4091</p> 	<p>Panel Air Element Fits: Audi, BMW, Volkswagen Automotive Replaces: Audi 58133843; BMW 13711736675, 13721702158, 13721736675 Length: 10 1/8 (257.2) Width: 8 7/16 (214.3) Height: 2 3/16 (65.6)</p>
<p>PA4079</p> 	<p>Panel Air Element Fits: Buick Skylark; Chevrolet Berette, Corsica Replaces: GMC 25099735 Length: 10 3/4 (273.1) Width: 6 1/2 (165.1) Height: 1 21/32 (42.1)</p>	<p>PA4092</p> 	<p>Panel Air Element with Foam Pad Fits: Jeep Wrangler Replaces: Chrysler 4797777 Length: 13 1/2 (342.9) Width: 6 1/4 (158.8) Height: 1 5/16 (33.3)</p>
<p>PA4081</p> 	<p>Panel Air Element Fits: Honda, Isuzu, Toyota Automotive Replaces: Isuzu 8-97035-303-0, 8-97111-423-0; Toyota 17801-0W010 Length: 12 1/8 (308.0) Width: 7 27/32 (199.2) Height: 1 11/16 (42.9)</p>	<p>PA4093</p> 	<p>Oval Air Element Fits: Hatz Engines Replaces: Hatz 952900 O.D.: 6 17/32 (165.9) to 9 3/4 (247.7) I.D.: 2 9/32 (57.9) & 5 1/2 (139.7) Height: 3 5/8 (92.1)</p>
<p>PA4082</p> 	<p>Panel Air Element Fits: Volkswagen Automotive Replaces: Volkswagen 1H0129620 Length: 10 9/16 (268.3) Width: 8 31/32 (227.8) Height: 2 7/32 (56.4)</p>	<p>PA4094</p> 	<p>Foam Air Pump Element Contains: Instruction Sheet Fits: GMC Light-Duty Trucks, Vans Replaces: GMC 25043951 Length: 3 27/32 (97.6) Width: 3 19/32 (91.3) Height: 23/32 (18.3)</p>
<p>PA4084</p> 	<p>Panel Air Element Fits: Mazda Automotive Replaces: Mazda B595-13-Z40 Length: 9 11/16 (246.1) Width: 6 5/16 (160.3) Height: 1 15/32 (37.3)</p>	<p>PA4096</p> 	<p>Cabin Air Element Fits: BMW Automotive Replaces: BMW 64111393489, 64119069895 Length: 11 5/8 (295.3) Width: 6 1/2 (165.1) Height: 31/32 (24.6) A. Gskt: [1] Attached</p>
<p>PA4085</p> 	<p>Panel Air Element Fits: Chrysler Automotive Replaces: Chrysler 4573624, 4874153 Length: 8 7/8 (225.4) Width: 7 13/32 (188.1) Height: 1 1/2 (38.1)</p>	<p>PA4099</p> 	<p>Panel Air Element Fits: Honda Automotive Replaces: Honda 17220-P2N-A01 Length: 7 19/32 (192.9) Width: 7 7/8 (200.0) Height: 1 7/8 (47.6)</p>
<p>PA4088</p> 	<p>Air Element Fits: Ford Automotive Replaces: Ford F7CZ-9601-A O.D.: 5 27/32 (148.4) Flange 6 13/16 (173.0) I.D.: 3 3/32 (78.6) One End Height: 7 15/32 (189.7)</p>	<p>PA4100</p> 	<p>Panel Air Element Fits: Honda Automotive Replaces: Honda 17220-P2F-A01 Length: 8 7/8 (225.4) Width: 6 21/32 (169.1) Height: 1 5/16 (33.3)</p>
		<p>PA4102</p> 	<p>Panel Air Element Fits: Ford, Mazda Automotive, Light-Duty Trucks Replaces: Ford F77X-9601-AA, F77Z-9601-AA Length: 8 25/32 (223.0) Width: 7 9/16 (192.0) Height: 2 1/8 (54.0) A. Gskt: [1] Included</p>

Measurements Are Shown In Inches And (Millimeters)

 **WARNING:** These products can expose you to chemicals, including Diisononyl Phthalate, Carbon black extracts, Nickel, 1,3 Butadiene, Ethylene Oxide, Epichlorohydrin, which are known to the State of California to cause cancer, and Bisphenol, Ethylene Glycol, Ethylene Oxide, 1,3 Butadiene, Epichlorohydrin, which are known to the State of California to cause birth defects or other reproductive harm. For more information go to www.P65Warnings.ca.gov.

PA4103 Panel Air Element
Fits: Mitsubishi Automotive
Replaces: Mitsubishi MR188657
Length: 8 3/8 (212.7)
Width: 8 1/16 (204.8)
Height: 1 31/32 (50.0)
A. Gskt: [1] Attached



PA4104 Panel Air Element
Fits: Honda Automotive
Replaces: Honda 17220-PAA-000, 17220-PAA-A00
Length: 10 25/32 (273.8)
Width: 6 5/8 (168.3)
Height: 1 21/32 (42.1)
A. Gskt: [1] Attached

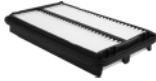

PA4105 Panel Air Element
Fits: Suzuki Automotive
Replaces: Suzuki 13780-60G00
Length: 7 7/16 (188.9)
Width: 6 1/16 (154.0)
Height: 2 1/16 (52.4)
A. Gskt: [1] Attached



PA4106 Panel Air Element
Fits: Acura, Honda Automotive
Replaces: Honda 17220-P8C-A00
Length: 12 5/8 (320.6)
Width: 6 11/32 (161.1)
Height: 2 15/16 (74.6)
A. Gskt: [1] Attached



PA4107 Panel Air Element
Fits: GM Automotive
Replaces: GMC 25161977
Length: 12 2/32 (324.6)
Width: 7 5/8 (193.7)
Height: 1 19/32 (40.5)



PA4108 Panel Air Element
Fits: Chevrolet Tracker; Suzuki Automotive
Replaces: GMC 25311970; Suzuki 13780-77E00
Length: 9 1/16 (230.2)
Width: 7 7/8 (200.0)
Height: 2 5/32 (54.8)



PA4109 Panel Air Element
Fits: Chrysler Automotive
Replaces: Chrysler 4591100AB, 4591100AC
Length: 9 17/32 (242.1)
Width: 7 3/32 (180.2)
Height: 1 19/32 (40.5)



PA4110 Panel Air Element with Foam Pad
Fits: Ford Light-Duty Trucks
Replaces: Ford F81A-9601-AA, F81Z-9601-AB
Length: 13 1/4 (336.6)
Width: 7 1/16 (179.4)
Height: 2 19/32 (65.9)



PA4111 Panel Air Element
Fits: Audi, Volkswagen Automotive
Replaces: Volkswagen 1J0129620
Length: 14 5/16 (363.5)
Width: 7 1/4 (184.2)
Height: 1 31/32 (50.0)

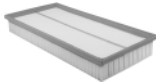

PA4112 Cabin Air Element
Fits: Ford Automotive
Replaces: Ford F6DZ-19N619-BA, F6DZ-19N619-C, F7DZ-19N619-A
Length: 10 15/16 (277.8)
Width: 3 1/4 (82.6) to 7 (177.8)
Height: 1 1/8 (28.6)
A. Gskt: [1] Attached

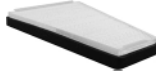

PA4113 Panel Air Element
Fits: Chevrolet, GMC Light-Duty Trucks
Replaces: GMC 25313348
Length: 12 9/32 (311.9)
Width: 9 23/32 (246.9)
Height: 2 5/16 (58.7)

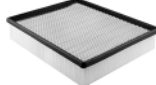

PA4114 Panel Air Element
Fits: Mazda Automotive
Replaces: Mazda FSD7-13-Z40
Length: 10 7/16 (265.1)
Width: 6 19/32 (167.5)
Height: 1 5/16 (33.3)

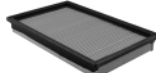

PA4118 Air Element
Fits: Dodge, Plymouth Automotive
Replaces: Chrysler 4891097AA
O.D.: 5 5/8 (142.9)
I.D.: 2 13/32 (61.1) One End
Height: 6 9/16 (167.5)



PA4120 Panel Air Element
Fits: Ford Light-Duty Trucks
Replaces: Ford XC3Z-9601-AA
Length: 13 3/8 (339.7)
Width: 7 1/4 (184.3)
Height: 2 5/16 (58.7)



PA4121 Panel Air Element
Fits: Saturn Automotive
Replaces: Saturn 90571362
Length: 12 19/32 (319.9)
Width: 9 11/32 (237.3)
Height: 1 13/32 (35.7)



PA4123 Panel Air Element
Fits: Ford Automotive
Replaces: Ford YS4Z-9601-CC
Length: 10 7/16 (265.1)
Width: 5 3/4 (146.1)
Height: 1 7/8 (47.6)

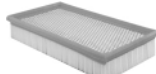

PA4124 Panel Air Element
Fits: Kia Automotive
Replaces: Kia K2A5-13-Z40A, OK2A5-13-Z40A
Length: 13 5/16 (338.1)
Width: 6 23/32 (170.7)
Height: 1 17/32 (38.9)

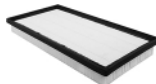

PA4126 Panel Air Element
Fits: Land Rover Discovery
Replaces: Land Rover ESR1445
Length: 10 1/4 (260.4)
Width: 8 (203.2)
Height: 2 1/4 (57.2)



Measurements Are Shown In Inches And (Millimeters)

WARNING: These products can expose you to chemicals, including Diisononyl Phthalate, Carbon black extracts, Nickel, 1,3 Butadiene, Ethylene Oxide, Epichlorohydrin, which are known to the State of California to cause cancer, and Bisphenol, Ethylene Glycol, Ethylene Oxide, 1,3 Butadiene, Epichlorohydrin, which are known to the State of California to cause birth defects or other reproductive harm. For more information go to www.P65Warnings.ca.gov.

PA4127

Panel Air Element



Fits: Lexus, Toyota Automotive, Light-Duty Trucks
Replaces: Toyota 17801-07010, 17801-50040
Length: 12 1/4 (311.2)
Width: 9 1/8 (231.8)
Height: 2 1/16 (52.4)

PA4128

Panel Air Element

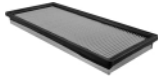

Fits: Subaru Light-Duty Trucks
Replaces: Subaru 16546-AA070, 16546-AA07A
Length: 14 21/32 (372.3)
Width: 6 7/16 (166.7)
Height: 1 9/32 (32.5)
A. Gskt: [1] Attached

PA4129

Panel Air Element



Fits: Honda Automotive
Replaces: Honda 17220-P8F-A00
Length: 11 1/4 (285.8)
Width: 5 1/2 (139.7) to 6 13/32 (162.7)
Height: 2 9/16 (65.1)

RS4130

Radial Seal Air Element



Fits: Chrysler Automotive
Replaces: Chrysler 5011836AA
O.D.: 5 1/32 (127.8)
I.D.: 3 5/32 (80.2) One End
Height: 6 1/4 (158.8)

RS4131

Radial Seal Air Element



Fits: Chevrolet, GMC Vans
Replaces: GMC 15153904
O.D.: 5 13/32 (137.3)
I.D.: 3 3/16 (81.0) One End
Height: 13 5/32 (334.2)

PA4132

Panel Air Element

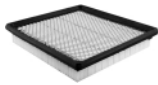

Fits: Chrysler, Dodge Vans
Replaces: Chrysler 4861480AA
Length: 9 11/32 (237.3)
Width: 8 7/16 (214.3)
Height: 1 21/32 (42.1)

PA4133

Cabin Air Element



Fits: Ford, Lincoln Light-Duty Trucks
Replaces: Ford F65Z-19N619-AB
Length: 10 9/16 (268.3)
Width: 9 31/32 (253.2)
Height: 1 7/32 (31.0)

PA4134

Panel Air Element

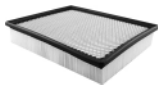

Fits: Chevrolet, GMC Light-Duty Trucks, Suburbans with 6.6L Turbo Diesel Engine
Replaces: GMC 25332443; ACDelco A1618C
Length: 12 9/32 (311.9)
Width: 9 23/32 (246.9)
Height: 2 5/16 (58.7)

PA4138

Panel Air Element



Fits: Hyundai Automotive
Replaces: Hyundai 28113-23001
Length: 10 1/4 (260.4)
Width: 7 3/32 (180.2)
Height: 1 17/32 (38.9)

SA4141

Crankcase Breather Filter in Metal Housing



Fits: Chrysler, Dodge, Jeep, Plymouth Automotive, Light-Duty Trucks
Replaces: Chrysler 3462094, 4273322, 5214561, 53030254
O.D.: 3 1/32 (77.0)
Inlet: 1
Outlet: 5/8
Height: 2 5/8 (66.7)

PA4144

Panel Air Element



Replaces: Mazda WL81-13-Z40
Length: 9 29/32 (251.6)
Width: 7 27/32 (199.2)
Height: 2 1/16 (52.4)
A. Gskt: [1] Attached

PA4145

Air Element with Lift Tab



Fits: Hummer Light-Duty Trucks
Replaces: GMC 12342870
O.D.: 9 3/32 (231.0)
I.D.: 15/32 (11.9) & 5 7/32 (132.6)
Height: 13 9/32 (337.3)
A. Gskt: [1] Attached
F. Gskt: [1] Included

PA4146

Panel Air Element

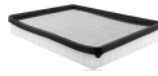

Fits: Buick, Chevrolet, Pontiac, Oldsmobile Automotive
Replaces: GMC 24508572; ACDelco A1614C
Length: 10 1/2 (266.7)
Width: 7 7/8 (200.0)
Height: 1 9/16 (39.7)

PA4147

Panel Air Element



Fits: Ford, Mercury Light-Duty Trucks
Replaces: Ford 1L2Z-9601-AA
Length: 11 1/2 (292.1)
Width: 7 3/32 (180.2)
Height: 2 1/4 (57.2)

PA4148

Panel Air Element



Fits: Ford Light-Duty Trucks
Replaces: Ford 1C3Z-9601-AA
Length: 13 3/8 (339.7)
Width: 7 5/16 (185.7)
Height: 3 13/32 (86.5)

PA4149 KIT

Set of 2 Cabin Air Elements



Notes: Uses 2 filters per application.
Fits: Cadillac, Chevrolet Light-Duty Trucks
Replaces: GMC 52485513
Each Filter:
Length: 9 11/32 (237.3)
Width: 5 7/16 (138.1)
Height: 29/32 (23.0)

Measurements Are Shown In Inches And (Millimeters)



WARNING: These products can expose you to chemicals, including Diisononyl Phthalate, Carbon black extracts, Nickel, 1,3 Butadiene, Ethylene Oxide, Epichlorohydrin, which are known to the State of California to cause cancer, and Bisphenol, Ethylene Glycol, Ethylene Oxide, 1,3 Butadiene, Epichlorohydrin, which are known to the State of California to cause birth defects or other reproductive harm. For more information go to www.P65Warnings.ca.gov.

PA4150 Panel Air Element
Fits: Lexus, Toyota Automotive, Light-Duty Trucks
Replaces: Toyota 17801-20040, 17801-0H010, 17801-0H020
Length: 12 17/32 (318.3)
Width: 7 19/32 (192.9)
Height: 1 11/16 (42.9)
A. Gskt: [1] Attached



PA4151 Panel Air Element
Fits: Dodge Light-Duty Trucks
Replaces: Chrysler 53032404AA
Length: 13 3/4 (349.3)
Width: 9 11/32 (237.3)
Height: 1 15/16 (49.2)
A. Gskt: [1] Attached

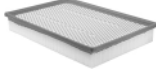

PA4152 Cabin Air Element
Fits: Ford, Mercury Vans
Replaces: Ford XF2Z-19N619-AB
Length: 11 3/8 (288.9)
Width: 5 1/16 (128.6)
Height: 15/16 (23.8)
A. Gskt: [1] Attached



PA4153 Cabin Air Element
Fits: Ford, Mercury Automotive
Replaces: Ford F5RZ-19N619-BA
Length: 20 11/32 (516.7)
Width: 4 1/8 (104.8)
Height: 1 1/8 (28.6)
A. Gskt: [1] Attached



PA4154 Cabin Air Element with Pull Tab
Fits: Buick, Chevrolet, Pontiac Automotive
Replaces: GMC 10261703, 10406026, 10446783
Length: 11 15/32 (291.3)
Width: 7 11/32 (186.5)
Height: 1 5/32 (29.4)
A. Gskt: [1] Attached

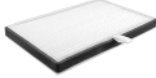

PA4156 KIT Set of 2 Cabin Air Elements
Notes: Uses 2 filters per application.
Contains: Charcoal Impregnated Media for Odor Control.
Fits: Buick, Chevrolet, Oldsmobile, Pontiac, Saturn Light-Duty Trucks, Vans
Replaces: GMC 10302760, 10322538
Each Filter:
Length: 8 11/16 (220.7)
Width: 4 1/4 (108.0)
Height: 1 17/32 (38.9)
A. Gskt: [1] Included on Each

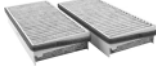

PA4157 Panel Air Element
Fits: Buick, Cadillac, Chevrolet, Pontiac, Saturn Automotive
Replaces: Saturn 22676970
Length: 10 15/16 (277.8)
Width: 9 11/32 (237.3)
Height: 1 15/32 (37.3)



PA4158 Air Element
Fits: Euclid Dump Trucks
Replaces: Euclid 9029495, E9029495; Fleetguard AF4728
O.D.: 3 17/32 (89.7)
I.D.: 1 17/32 (38.9)
Height: 4 1/2 (114.3)



PA4159 Cabin Air Element
Contains: Charcoal Impregnated Media for Odor Control.
Fits: Chrysler Pacifica, Town and Country, Voyager; Dodge Caravan, Grand Caravan
Replaces: Chrysler 82205905
Length: 12 7/32 (310.4)
Width: 9 7/32 (234.2)
Height: 29/32 (23.0)

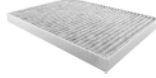

PA4160 Panel Air Element
Fits: Ford, Mazda Light-Duty Trucks
Replaces: Motorcraft FA1744
Length: 9 (228.6)
Width: 7 3/4 (196.9)
Height: 2 7/32 (56.4)

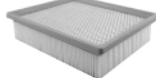

RS4161 Radial Seal Air Element
Fits: Buick, Chevrolet, GMC Light-Duty Trucks
Replaces: GMC 15036141
O.D.: 5 31/32 (151.6)
I.D.: 3 7/32 (81.8) One End
Height: 8 (203.2)



PA4162 Panel Air Element with Foam Pad
Fits: Dodge Light-Duty Trucks
Replaces: Chrysler 53032700AA
Length: 10 29/32 (277.0)
Width: 9 7/8 (250.8)
Height: 2 23/32 (69.1)
A. Gskt: [1] Attached

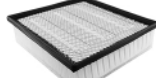

PA4163 Panel Air Element
Fits: Ford, Mazda, Mercury Automotive
Replaces: Ford YL8Z-9601-AA; Mazda YF09-13-Z40
Length: 9 15/16 (252.4)
Width: 7 1/32 (178.6)
Height: 2 3/16 (55.6)

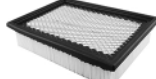

PA4164 Panel Air Element
Fits: Jeep Grand Cherokee
Replaces: Chrysler 5015610AA
Length: 10 23/32 (272.3)
Width: 9 11/16 (246.1)
Height: 1 17/32 (38.9)

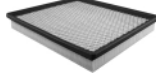

PA4165 Panel Air Element
Fits: Toyota Light-Duty Trucks
Replaces: Toyota 17801-31090
Length: 13 31/32 (354.8)
Width: 3 1/8 (79.4) to 6 17/32 (165.9)
Height: 2 7/16 (61.9)
A. Gskt: [1] Attached



Measurements Are Shown In Inches And (Millimeters)

WARNING: These products can expose you to chemicals, including Diisononyl Phthalate, Carbon black extracts, Nickel, 1,3 Butadiene, Ethylene Oxide, Epichlorohydrin, which are known to the State of California to cause cancer, and Bisphenol, Ethylene Glycol, Ethylene Oxide, 1,3 Butadiene, Epichlorohydrin, which are known to the State of California to cause birth defects or other reproductive harm. For more information go to www.P65Warnings.ca.gov.

PA4166

Air Element



Fits: Hatz Engines
Replaces: Bomag 5727220; Hatz 4030100;
 Fleetguard AF25481
O.D.: 5 1/2 (139.7)
I.D.: 3 1/4 (82.6)
Height: 3 9/32 (83.3)

PA4167

Panel Air Element

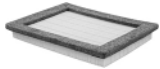

Fits: Ford, Lincoln Light-Duty Trucks
Replaces: Ford 4L3Z-9601-BA;
 Motorcraft FA1754
Length: 11 11/32 (288.1)
Width: 8 15/32 (215.1)
Height: 1 13/32 (35.7)
A. Gskt: [1] Attached

PA4168

Cabin Air Element



Fits: Jeep Grand Cherokee
Replaces: Chrysler 5013595AB, 82208300
Length: 18 5/16 (465.1)
Width: 3 1/16 (77.8)
Height: 1 5/8 (41.3)

PA4169

Cabin Air Element

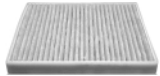

Contains: Charcoal Impregnated Media for
 Odor Control
Fits: Cadillac Escalade; Chevrolet Silverado,
 Suburban, Tahoe; GMC Sierra, Yukon
Replaces: GMC 88986533; ACDelco CF127
Length: 10 5/8 (269.9)
Width: 9 7/16 (239.7)
Height: 1 (25.4)
A. Gskt: [1] Attached

PA4170

Panel Air Element

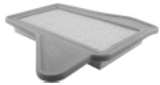

Fits: Chrysler Pacifica
Replaces: Chrysler 5510026AA
Length: 12 5/32 (308.8)
Width: 7 1/4 (184.2) to 12 19/32 (319.9)
Height: 1 25/32 (45.2)
A. Gskt: [1] Attached

PA4171

Panel Air Element



Fits: Ford Vans
Replaces: Ford 4C2U-9601-AB
Length: 12 5/16 (312.7)
Width: 6 23/32 (170.7)
Height: 3 5/16 (84.1)

PA4172

Panel Air Element

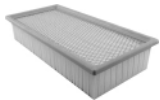

Fits: Ford Super Duty Pickups
Replaces: Ford 5C3Z-9601-AA;
 Motorcraft FA1782
Length: 14 23/32 (373.9)
Width: 6 13/16 (173.0)
Height: 2 3/4 (69.9)

PA4173

Air Element



Fits: Chevrolet Colorado, GMC Canyon;
 Hummer
Replaces: GMC 15202408;
 ACDelco A1624C
O.D.: 5 27/32 (148.4)
I.D.: 3 5/8 (92.1) One End
Height: 8 5/8 (219.1)

PA4174

Cabin Air Element

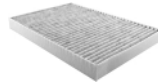

Contains: Charcoal Impregnated Media for
 Odor Control.
Fits: Chrysler 300; Dodge Charger, Magnum
Replaces: Chrysler 4596501AB
Length: 12 5/32 (308.8)
Width: 8 5/16 (211.1)
Height: 1 3/16 (30.2)

PA4175

Panel Air Element



Fits: Ford, Mercury Automotive
Replaces: Ford 6E5Z-9601-EA;
 Motorcraft FA1785
Length: 10 9/16 (268.3)
Width: 6 5/16 (160.3)
Height: 1 31/32 (50.0)

PA4176

Panel Air Element



Fits: Ford, Mercury Automotive
Replaces: Ford 6E5Z-9601-GA;
 Motorcraft FA1786
Length: 8 13/32 (213.5)
Width: 6 5/16 (160.3)
Height: 1 31/32 (50.0)

PA4177

Panel Air Element

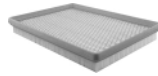

Fits: Chrysler, Dodge Automotive, Light-Duty
 Trucks
Replaces: Chrysler 5019002AA, 5037615AA
Length: 11 15/32 (291.3)
Width: 8 11/32 (211.9)
Height: 1 1/2 (38.1)

PA4178

Panel Air Element

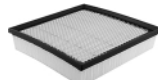

Fits: Chevrolet, Pontiac Automotive
Replaces: GMC 10650737
Length: 9 3/8 (238.1)
Width: 8 27/32 (224.6)
Height: 1 31/32 (50.0)

PA4179

Panel Air Element

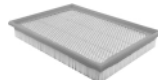

Fits: Jeep Cherokee, Commander, Liberty
Replaces: Chrysler 5018777AA
Length: 11 15/32 (291.3)
Width: 8 5/16 (211.1)
Height: 1 19/32 (40.5)

PA4180

Panel Air Element



Fits: Pontiac, Scion, Toyota Automotive
Replaces: Toyota 17801-0D020
Length: 11 3/8 (288.9)
Width: 5 29/32 (150.0)
Height: 2 (50.8)
A. Gskt: [1] Attached

PA4181

Panel Air Element

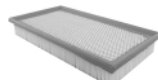

Fits: Ford, Jaguar, Lincoln, Mercury
 Automotive
Replaces: Ford XW4Z-9601-AC;
 Motorcraft FA1679
Length: 12 7/32 (310.4)
Width: 6 17/32 (165.9)
Height: 1 3/4 (44.5)

PA4182











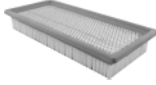

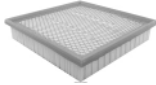



Panel Air Element

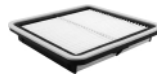

Fits: Acura, Honda Automotive
Replaces: Honda 17220-PLC-000
Length: 12 19/32 (319.9)
Width: 7 3/4 (196.9)
Height: 1 15/32 (37.3)
A. Gskt: [1] Attached



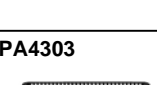







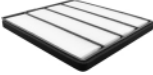

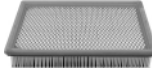

Measurements Are Shown In Inches And (Millimeters)

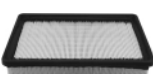
WARNING: These products can expose you to chemicals, including Diisononyl Phthalate, Carbon black extracts, Nickel, 1,3 Butadiene, Ethylene Oxide, Epichlorohydrin, which are known to the State of California to cause cancer, and Bisphenol, Ethylene Glycol, Ethylene Oxide, 1,3 Butadiene, Epichlorohydrin, which are known to the State of California to cause birth defects or other reproductive harm. For more information go to www.P65Warnings.ca.gov.

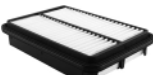
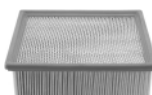
<p>PA4183 Panel Air Element  Fits: Ford, Mercury Automotive Replaces: Ford 5F9Z-9601-AA; Motorcraft FA1771 Length: 11 23/32 (297.7) Width: 5 11/32 (135.7) Height: 1 27/32 (46.8)</p>	<p>PA4192 Panel Air Element  Fits: 2004-09 Toyota Prius Replaces: Toyota 17801-21040 Length: 11 11/32 (288.1) Width: 7 1/4 (184.2) Height: 1 1/16 (27.0) A. Gskt: [1] Attached</p>
<p>PA4184 Panel Air Element  Fits: Dodge Durango Replaces: Chrysler 53032527AA Length: 8 29/32 (226.2) Width: 8 5/8 (219.1) Height: 1 3/4 (44.5)</p>	<p>PA4193 Panel Air Element  Fits: Acura, Honda Automotive Replaces: Honda 17220-RRA-A00 Length: 10 7/8 (276.2) Width: 6 11/32 (161.1) Height: 2 1/8 (54.0) A. Gskt: [1] Attached</p>
<p>PA4185 Panel Air Element  Fits: 2006-on Ford Explorer, Mercury Mountaineer all with V8-281 (4.6L) Engine Replaces: Motorcraft FA1780; Wix 49145 Length: 15 5/32 (385.0) Width: 8 1/16 (204.8) Height: 1 9/32 (32.5)</p>	<p>PA4194 Cabin Air Element  Fits: Lexus, Toyota Automotive Replaces: Toyota 87139-32010 Length: 8 3/8 (212.7) Width: 8 5/16 (211.1) Height: 21/32 (16.7) A. Gskt: [2] Attached</p>
<p>PA4187 Foam Wrap  Notes: Can be used as a replacement wrap for PA4553. Contains: Oil Wetted Media Fits: John Deere Mowers, Lawn & Garden Tractors Replaces: John Deere M76076 O.D.: 7 (177.8) I.D.: 6 3/4 (171.5) Height: 1 31/32 (50.0)</p>	<p>PA4195 KIT Set of 2 Cabin Air Elements  Notes: Uses 2 filters per application. Fits: Acura, Honda Automotive Replaces: Honda 80292-S5D-A01, 80292-S5A-003 Each Filter: Length: 8 27/32 (224.6) Width: 4 13/32 (111.9) Height: 1 1/8 (28.6)</p>
<p>PA4188 Cabin Air Element  Fits: Mitsubishi, Subaru, Toyota Automotive Replaces: Toyota 87139-47010 Length: 8 15/32 (215.1) Width: 8 15/32 (215.1) Height: 21/32 (16.7)</p>	<p>PA4196 Cabin Air Element  Fits: Acura, Honda Automotive Replaces: Honda 80292-SEC-A01 Length: 9 7/32 (234.2) Width: 8 21/32 (219.9) Height: 1 1/8 (28.6)</p>
<p>RS4189 Radial Seal Air Element  Fits: Acura, Honda Automotive Replaces: Honda 17220-PNA-003, 17220-PNB-003; Wix 42188 O.D.: 5 7/16 (138.1) I.D.: 3 5/32 (80.2) Height: 6 27/32 (173.6)</p>	<p>PA4197 Panel Air Element  Fits: Subaru Automotive, Light-Duty Trucks Replaces: Subaru 16546-AA10A Length: 8 11/16 (220.7) Width: 8 15/32 (215.4) Height: 1 1/4 (31.8) A. Gskt: [1] Attached</p>
<p>PA4190 Panel Air Element  Fits: Acura, Honda Automotive Replaces: Honda 17220-PGK-A00; ACDelco A2964C Length: 11 3/8 (288.9) Width: 2 1/8 (54.0) to 6 15/32 (164.3) Height: 1 5/8 (41.3) A. Gskt: [1] Attached</p>	<p>PA4198 Panel Air Element  Fits: Mitsubishi Automotive Replaces: Mitsubishi MR571396 Length: 9 1/8 (231.8) Width: 8 17/32 (216.7) Height: 1 31/32 (50.0)</p>
<p>PA4191 Panel Air Element  Fits: Acura, Honda Automotive Replaces: Honda 17220-RAA-A00; ACDelco A2950C Length: 13 7/16 (341.3) Width: 4 7/16 (112.7) to 5 15/16 (150.8) Height: 1 25/32 (45.2) A. Gskt: [1] Attached</p>	<p>PA4199 Cabin Air Element  Fits: Infiniti, Mitsubishi, Nissan Automotive, Light-Duty Trucks Replaces: Nissan B7200-5M000 Length: 8 11/16 (220.7) Width: 7 27/32 (199.2) Height: 1 3/16 (30.2)</p>
<p>PA4303 Panel Air Element  Fits: 2002-04 Honda Odyssey Replaces: Honda 17220-P8F-A10 Length: 11 7/32 (285.0) Width: 6 11/32 (161.1) Height: 1 5/8 (41.3) A. Gskt: [1] Attached</p>	<p>PA4303 Panel Air Element  Fits: 2002-04 Honda Odyssey Replaces: Honda 17220-P8F-A10 Length: 11 7/32 (285.0) Width: 6 11/32 (161.1) Height: 1 5/8 (41.3) A. Gskt: [1] Attached</p>

Measurements Are Shown In Inches And (Millimeters)

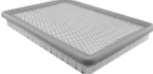
 **WARNING:** These products can expose you to chemicals, including Diisononyl Phthalate, Carbon black extracts, Nickel, 1,3 Butadiene, Ethylene Oxide, Epichlorohydrin, which are known to the State of California to cause cancer, and Bisphenol, Ethylene Glycol, Ethylene Oxide, 1,3 Butadiene, Epichlorohydrin, which are known to the State of California to cause birth defects or other reproductive harm. For more information go to www.P65Warnings.ca.gov.

<p>PA4304</p> 	<p>Cabin Air Element Fits: Acura MDX; Honda Odyssey, Pilot Replaces: Honda 80290-S0X-A01 Length: 11 5/8 (295.3) Width: 10 3/8 (263.5) Height: 25/32 (19.8) A. Gskt: [1] Attached</p>	<p>PA4313</p> 	<p>Panel Air Element Fits: Hyundai Sonata; Kia Optima, Magentis Replaces: Hyundai 28113-37101 Length: 9 3/8 (238.1) Width: 7 1/2 (190.5) Height: 1 9/16 (39.7)</p>
<p>PA4305</p> 	<p>Panel Air Element Fits: Scion, Toyota Automotive Replaces: Toyota 17801-21030 Length: 9 13/16 (249.2) Width: 4 3/4 (120.7) Height: 2 3/32 (53.2)</p>	<p>PA4314</p> 	<p>Panel Air Element Fits: Chrysler PT Cruiser Replaces: Chrysler 4891176AA; ACDelco A2937C Length: 10 1/32 (254.8) Width: 7 7/16 (188.9) Height: 1 15/32 (37.3)</p>
<p>PA4306</p> 	<p>Panel Air Element Fits: 2003-05 Honda Accord with V6-183 (3.0L) Engine Replaces: Honda 17220-RCA-A00; ACDelco A2951C Length: 12 29/32 (327.8) Width: 5 27/32 (148.4) Height: 1 19/32 (40.5) A. Gskt: [1] Attached</p>	<p>SA4315</p> 	<p>Crankcase Breather Filter in Plastic Housing Fits: Buick, Chevrolet, GMC, Oldsmobile, Pontiac Automotive, Light-Duty Trucks, Vans Replaces: GMC 25041487, 25047377; ACDelco FB82 Width: 1 15/32 (37.3) Height: 1 3/8 (34.9)</p>
<p>PA4307</p> 	<p>Panel Air Element Fits: 2001-05 Toyota RAV4 Replaces: Toyota 17801-28010 Length: 14 3/4 (374.7) Width: 3 7/8 (98.4) to 5 11/32 (135.7) Height: 2 1/8 (54.0)</p>	<p>PA4316</p> 	<p>Panel Air Element Fits: Chevrolet HHR Replaces: GMC 22731072; ACDelco A3054C Length: 13 7/8 (352.4) Width: 4 29/32 (124.6) Height: 2 9/32 (57.9)</p>
<p>PA4308</p> 	<p>Panel Air Element Fits: Hyundai, Kia Automotive Replaces: Hyundai 28113-2D000 Length: 10 (254.0) Width: 6 7/8 (174.6) Height: 1 5/8 (41.3)</p>	<p>PA4317</p> 	<p>Cabin Air Element Fits: Chevrolet, Pontiac, Saturn Automotive Replaces: GMC 52493319, ACDelco CF125 Length: 9 23/32 (246.9) Width: 8 1/2 (215.9) Height: 29/32 (23.0) A. Gskt: [2] Attached</p>
<p>PA4309</p> 	<p>Panel Air Element Fits: Hyundai Santa Fe Replaces: Hyundai 28113-26000 Length: 10 3/16 (258.8) Width: 7 (177.8) Height: 1 31/32 (50.0)</p>	<p>PA4318</p> 	<p>Panel Air Element Fits: Dodge Light-Duty Trucks; Sterling Bullet Replaces: Chrysler 53034051AB Length: 10 15/16 (277.8) Width: 9 29/32 (251.6) Height: 4 3/8 (111.1)</p>
<p>PA4310</p> 	<p>Panel Air Element Fits: 2000-06 Mazda MPV Van, 2003-on Mazda6 Replaces: Mazda RF2A-13-Z40A9U, RF2A-13-Z40A; Length: 12 19/32 (319.9) Width: 6 15/16 (176.2) Height: 1 27/32 (46.8)</p>	<p>PA4319</p> 	<p>Panel Air Element Fits: Opel, Renault Light-Duty Trucks Replaces: GMC 93187335; Opel 4402614, 4416403; Renault 7701047285, 7701476258, 8200457286 Length: 12 11/32 (313.5) Width: 4 (101.6) Height: 1 5/8 (41.3)</p>
<p>PA4311</p> 	<p>Panel Air Element Fits: Hyundai Accent Replaces: Hyundai 28113-22600; ACDelco A2936C Length: 9 13/16 (249.2) Width: 6 5/8 (168.3) Height: 1 17/32 (38.9)</p>	<p>PA4320</p> 	<p>Panel Air Element Fits: 2006 Honda Civic 4-1799cc (1.8L) MFI, 2007-on Civic 4-1799cc (1.8L) FI, Natural Gas Engines Replaces: Honda 17220-RNA-A00; Wix 49065 Length: 8 15/16 (227.0) Width: 7 3/4 (196.9) Height: 1 3/4 (44.5) A. Gskt: [1] Attached</p>
<p>PA4312</p> 	<p>Panel Air Element Fits: Saturn Automotive Replaces: GMC 22679620; ACDelco A2953C Length: 11 29/32 (302.4) Width: 8 15/32 (215.1) Height: 1 13/32 (35.7)</p>	<p>PA4321</p> 	<p>Panel Air Element Fits: Ford, Mercury, Lincoln Automotive Replaces: Ford 7T4Z-9601-A; Motorcraft FA1884 Length: 11 31/32 (304.0) Width: 6 11/16 (169.9) Height: 1 3/4 (44.5)</p>

Measurements Are Shown In Inches And (Millimeters)

 **WARNING:** These products can expose you to chemicals, including Diisononyl Phthalate, Carbon black extracts, Nickel, 1,3 Butadiene, Ethylene Oxide, Epichlorohydrin, which are known to the State of California to cause cancer, and Bisphenol, Ethylene Glycol, Ethylene Oxide, 1,3 Butadiene, Epichlorohydrin, which are known to the State of California to cause birth defects or other reproductive harm. For more information go to www.P65Warnings.ca.gov.

PA4322 Panel Air Element

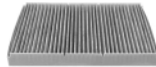
Fits: Toyota Light-Duty Trucks
Replaces: Toyota 17801-0S010
Length: 12 7/16 (315.9)
Width: 11 11/16 (296.9)
Height: 2 (50.8)
A. Gskt: [1] Attached

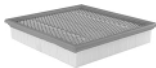
PA4331 Cabin Air Element

Contains: Charcoal Impregnated Media for Odor Control.
Fits: Audi, Volkswagen Automotive
Replaces: Volkswagen 1J0819644, 1J0819644A
Length: 11 3/32 (281.8)
Width: 8 3/16 (208.0)
Height: 1 3/16 (30.2)

PA4323 Panel Air Element

Fits: Ford, Lincoln Light-Duty Trucks
Replaces: Ford 7C3Z-9601-A; Motorcraft FA1883
Length: 10 15/32 (265.9)
Width: 9 29/32 (251.6)
Height: 1 7/8 (47.6)

PA4332 Cabin Air Element

Fits: Toyota Corolla, Matrix
Replaces: Toyota 88568-02020; Wix 24873
Length: 8 21/32 (219.9)
Width: 7 27/32 (199.2)
Height: 25/32 (19.8)

PA4324 Panel Air Element

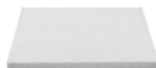
Fits: Pontiac Solstice, Saturn Sky Red Line
Replaces: GMC 15925738; ACDelco A3084C
Length: 14 9/16 (369.9)
Width: 9 9/16 (242.9)
Height: 1 5/32 (29.4)
A. Gskt: [1] Attached

PA4333 Panel Air Element

Fits: Lexus, Scion, Toyota Automotive, Light-Duty Trucks
Replaces: Toyota 17801-31120, 17801-AD010
Length: 10 (254.0)
Width: 5 1/2 (139.7) to 9 3/8 (235.7)
Height: 2 1/4 (57.2)
A. Gskt: [1] Attached

PA4325 Panel Air Element

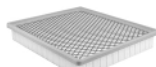
Fits: 2006-10 Chrysler PT Cruiser
Replaces: Chrysler 4891691AA
Length: 10 5/32 (258.0)
Width: 6 1/2 (165.1)
Height: 1 11/16 (42.9)

PA4334 Cabin Air Element

Fits: Hyundai, Kia Automotive, Light-Duty Trucks, Vans
Replaces: Hyundai 97133-2B010, 97133-3K000
Length: 9 7/8 (250.8)
Width: 8 23/32 (221.5)
Height: 1 3/16 (30.2)

PA4327 Cabin Air Element

Fits: Scion, Toyota Automotive, Light-Duty Trucks
Replaces: Toyota 87139-YZZ08
Length: 8 7/16 (214.3)
Width: 7 11/16 (195.3)
Height: 1 1/8 (28.8)

PA4335 Panel Air Element

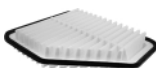
Fits: Chrysler, Dodge Automotive
Replaces: Chrysler 4891926AA
Length: 9 9/32 (235.7)
Width: 8 7/16 (214.3)
Height: 1 17/32 (38.9)

PA4328 Air Element

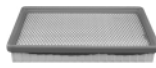
Fits: Toyota Automotive, Light-Duty Trucks
Replaces: Toyota 17801-31050, 17801-54080, 17801-54120; Donaldson P500021; Fleetguard AF25295
O.D.: 6 3/32 (154.8)
I.D.: 1/2 (12.7) & 3 15/32 (88.1)
Height: 7 3/4 (196.9)
F. Gskt: [1] Metal Washer

PA4336 Cabin Air Element

Contains: Charcoal Impregnated Media for Odor Control.
Fits: Dodge, Freightliner, Mercedes-Benz Sprinter Vans
Replaces: Chrysler 68012876AA; Mercedes-Benz AA9068300318
Length: 14 9/16 (369.9)
Width: 11 5/32 (283.4)
Height: 1 3/8 (34.9)
Related To: PA4488 (Standard Media Version)

PA4329 Panel Air Element

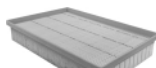
Fits: Chevrolet Cobalt; Pontiac G5, Pursuit
Replaces: GMC 21999324; ACDelco A2956C
Length: 9 3/8 (238.1)
Width: 4 1/2 (114.3) to 8 3/8 (212.7)
Height: 1 25/32 (45.2)











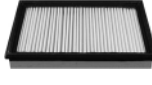

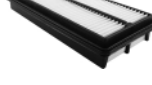
PA4337 Panel Air Element

Fits: Chevrolet, Pontiac Automotive
Replaces: General Motors 10366901; ACDelco A2930C
Length: 11 5/8 (295.3)
Width: 7 3/32 (180.2)
Height: 1 23/32 (43.7)

PA4330 Cabin Air Element

Fits: Buick, Cadillac, Oldsmobile, Pontiac Automotive
Replaces: GMC 25654414; ACDelco CF117
Length: 11 1/4 (285.8)
Width: 8 5/8 (219.1)
Height: 29/32 (23.0)
Related To: PA4384 (Charcoal Media Version)

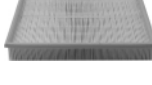
PA4338 Panel Air Element

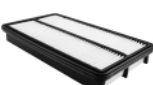
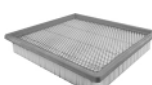
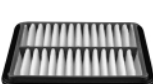
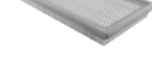
Fits: Ford, Mercury Automotive
Replaces: Ford 3W3Z-9601-AA; Motorcraft FA1745; Wix 46814
Length: 11 13/32 (289.7)
Width: 7 19/32 (192.9)
Height: 1 31/32 (50.0)

Measurements Are Shown In Inches And (Millimeters)

 **WARNING:** These products can expose you to chemicals, including Diisononyl Phthalate, Carbon black extracts, Nickel, 1,3 Butadiene, Ethylene Oxide, Epichlorohydrin, which are known to the State of California to cause cancer, and Bisphenol, Ethylene Glycol, Ethylene Oxide, 1,3 Butadiene, Epichlorohydrin, which are known to the State of California to cause birth defects or other reproductive harm. For more information go to www.P65Warnings.ca.gov.

<p>PA4340</p> 	<p>Cabin Air Element Fits: Chevrolet Equinox; Pontiac Torrent; Saturn Sky, VUE Replaces: Saturn 22665802 Length: 16 3/4 (425.5) Width: 4 13/32 (111.9) Height: 1 1/8 (28.6)</p>	<p>PA4353</p> 	<p>Panel Air Element Fits: Kia Sportage Replaces: Kia OK011-13-Z40 Length: 10 7/16 (265.1) Width: 7 1/8 (181.0) Height: 1 7/16 (36.5)</p>
<p>PA4341</p> 	<p>Panel Air Element Fits: Kia Sorento Replaces: Kia 28113-3E000, 28113-3E500 Length: 11 21/32 (296.1) Width: 9 3/8 (238.1) Height: 1 5/16 (33.3)</p>	<p>PA4355</p> 	<p>Panel Air Element Fits: Acura, Honda Automotive Replaces: Honda 17220-RDA-A00 Length: 12 27/32 (326.2) Width: 5 25/32 (146.8) Height: 2 1/8 (54.0) A. Gskt: [1] Attached</p>
<p>PA4344</p> 	<p>Panel Air Element Fits: Chevrolet Aveo, Pontiac Wave Replaces: GMC 96536696 Length: 8 3/4 (222.3) Width: 7 3/8 (187.3) Height: 1 25/32 (45.2) A. Gskt: [1] Attached</p>	<p>PA4356</p> 	<p>Panel Air Element Fits: Toyota Tacoma Light-Duty Truck Replaces: Toyota 17801-0C040 Length: 12 19/32 (319.9) Width: 9 1/2 (241.3) Height: 2 1/16 (52.4)</p>
<p>PA4345</p> 	<p>Panel Air Element Fits: Mazda3, Mazda5, MazdaSpeed3 Replaces: Mazda LF50-13-Z40A, LF50-13-Z40-9U Length: 10 27/32 (275.4) Width: 7 3/8 (187.3) Height: 2 3/32 (53.2) A. Gskt: [1] Attached</p>	<p>PA4357</p> 	<p>Panel Air Element Fits: Kia Sedona Replaces: Kia OK52Y-13-33X Length: 10 9/16 (268.3) Width: 7 7/16 (188.9) Height: 1 3/8 (34.9)</p>
<p>PA4348</p> 	<p>Panel Air Element Fits: Hyundai Tucson, Kia Sportage Replaces: Hyundai 28113-08000 Length: 9 31/32 (253.2) Width: 6 13/16 (173.0) Height: 1 23/32 (43.7) A. Gskt: [1] Attached</p>	<p>PA4358</p> 	<p>Panel Air Element Fits: Cadillac CTS Replaces: General Motors 25728874 Length: 3 15/32 (342.1) Width: 10 7/8 (276.1) Height: 1 1/4 (31.8)</p>
<p>PA4349</p> 	<p>Panel Air Element Fits: Hyundai Automotive Replaces: Hyundai 38113-3K200 Length: 9 9/32 (235.7) Width: 8 13/16 (223.8) Height: 2 5/16 (58.7) A. Gskt: [1] Attached</p>	<p>PA4359</p> 	<p>Panel Air Element Fits: Volvo Automotive Replaces: Volvo 9454647, 9454647-0 Length: 13 (330.2) Width: 8 1/2 (215.9) Height: 2 9/32 (57.9)</p>
<p>PA4350</p> 	<p>Panel Air Element Fits: Toyota Camry, Venza Replaces: Toyota 17801-28030, 17801-0H050 Length: 11 17/32 (292.9) Width: 7 7/8 (200.0) Height: 1 11/16 (42.9)</p>	<p>PA4360</p> 	<p>Panel Air Element Fits: 2003-08 Mazda6, 2006-07 MazdaSpeed6, 2007-on CX7 Replaces: Mazda AJ57-13-Z40, AJ57-13-Z409U Length: 12 5/16 (312.7) Width: 6 15/16 (176.2) Height: 1 27/32 (46.8) A. Gskt: [1] Attached</p>
<p>PA4351</p> 	<p>Panel Air Element Fits: 2007-09 Acura MDX; 2005-10 Honda Odyssey Replaces: Honda 17220-RGL-A00, 17220-RGL-A10 Length: 11 13/16 (300.0) Width: 6 7/8 (174.6) Height: 1 19/32 (40.5) A. Gskt: [1] Attached</p>	<p>PA4361</p> 	<p>Panel Air Element Fits: 2005-10 Ford Mustang Replaces: Ford 4R3Z-9601-AA; Motorcraft FA1773 Length: 9 31/32 (253.2) Width: 9 3/16 (233.4) Height: 1 23/32 (43.7)</p>
<p>PA4352</p> 	<p>Panel Air Element Fits: Toyota Prius Replaces: Toyota 17801-21020 Length: 7 5/16 (185.7) Width: 6 23/32 (170.7) Height: 1 1/16 (27.0)</p>	<p>PA4362</p> 	<p>Panel Air Element Fits: 2007-10 Dodge Caliber, Jeep Compass, Patriot Replaces: Chrysler 4891694AA Length: 12 27/32 (326.2) Width: 6 5/8 (168.3) Height: 1 1/4 (31.8)</p>

Measurements Are Shown In Inches And (Millimeters)

 **WARNING:** These products can expose you to chemicals, including Diisononyl Phthalate, Carbon black extracts, Nickel, 1,3 Butadiene, Ethylene Oxide, Epichlorohydrin, which are known to the State of California to cause cancer, and Bisphenol, Ethylene Glycol, Ethylene Oxide, 1,3 Butadiene, Epichlorohydrin, which are known to the State of California to cause birth defects or other reproductive harm. For more information go to www.P65Warnings.ca.gov.

PA4363 Panel Air Element
Fits: Hyundai, Kia Automotive
Replaces: Hyundai 28113-1G000; Kia 28113-1G000
Length: 10 11/32 (262.7)
Width: 5 9/32 (134.1)
Height: 2 3/16 (55.6)



PA4364 Panel Air Element
Fits: Acura, Honda Automotive
Replaces: Honda 17220-R70-A00
Length: 10 5/16 (261.9)
Width: 8 3/32 (205.6)
Height: 1 3/4 (44.5)
A. Gskt: [1] Attached



PA4365 Cabin Air Element
Fits: Ford, Lincoln Automotive
Replaces: Ford 7T4Z-19N619-B
Length: 7 7/8 (200.0)
Width: 7 7/16 (188.9)
Height: 23/32 (18.3)



PA4366 Panel Air Element
Fits: Honda Automotive
Replaces: Honda 17220-PWA-J10, 17315-SLN-A01
Length: 6 21/32 (169.1)
Width: 5 13/16 (147.6)
Height: 2 7/32 (56.4)
A. Gskt: [1] Attached



PA4367 Panel Air Element
Fits: 2007-10 Dodge Nitro; 2008-11 Jeep Liberty
Replaces: Chrysler 5189933AA
Length: 11 15/32 (291.3)
Width: 9 1/16 (230.2)
Height: 2 5/16 (58.7)

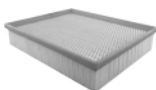

PA4368 Panel Air Element
Fits: Chevrolet, Suzuki Light-Duty Trucks
Replaces: GMC 96553450; Suzuki 13780-85Z00
Length: 7 3/4 (196.9) to 8 3/4 (222.3)
Width: 11 5/16 (287.3)
Height: 1 7/16 (36.5)
A. Gskt: [1] Attached



PA4370 Cabin Air Element
Fits: Ford, Mazda Automotive, Light-Duty Trucks
Replaces: Ford YL8Z-19N619-AB, YL84-19N619-AB; Motorcraft FP46, FP49
Length: 10 11/32 (262.7)
Width: 6 23/32 (170.7)
Height: 1 13/32 (35.7)
A. Gskt: [1] Attached



PA4371 Cabin Air Element
Fits: Lexus, Toyota Light-Duty Trucks
Replaces: Toyota 87139-48020
Length: 9 7/32 (234.2)
Width: 8 7/16 (214.3)
Height: 23/32 (18.3)

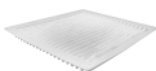

PA4372 Cabin Air Element
Fits: Scion, Toyota Automotive; Komatsu Excavators
Replaces: Toyota 88568-52010
Length: 8 1/2 (215.9)
Width: 7 11/16 (195.3)
Height: 5/8 (15.9)

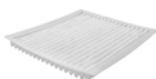

PA4373 Cabin Air Element
Contains: Charcoal Impregnated Media for Odor Control.
Fits: Chrysler, Dodge, Jeep Automotive
Replaces: Chrysler 5058381AA, 5058693AA
Length: 8 1/2 (215.9)
Width: 7 21/32 (194.5)
Height: 31/32 (24.6)

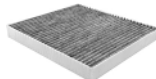

PA4374 Panel Air Element
Fits: Honda Automotive
Replaces: Honda 17220-R40-A00
Length: 10 9/16 (268.3)
Width: 5 (127.0) to 8 21/32 (219.9)
Height: 2 1/32 (51.6)
A. Gskt: [1] Attached



PA4375 Panel Air Element
Fits: Hyundai, Kia Automotive
Replaces: Hyundai 28113-39000; ACDelco A2992C
Length: 9 17/32 (242.1)
Width: 7 5/8 (193.7)
Height: 2 1/32 (51.6)
A. Gskt: [1] Attached



PA4376 Panel Air Element
Fits: Kia Automotive
Replaces: Kia K30C-13-Z40A, OK30C-13-Z40A
Length: 10 5/16 (261.9)
Width: 5 21/32 (143.7)
Height: 1 1/2 (38.1)



PA4377 Panel Air Element
Fits: 2006-on Honda Ridgeline
Replaces: Honda 17220-RJE-A00
Length: 13 1/8 (333.4)
Width: 6 15/16 (175.2)
Height: 1 25/32 (45.2)
A. Gskt: [1] Attached

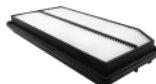

PA4380 Panel Air Element
Fits: Lexus Automotive
Replaces: Toyota 17801-50030
Length: 9 7/8 (250.8)
Width: 8 13/32 (213.5)
Height: 2 3/32 (53.2)
A. Gskt: [1] Attached



PA4381 Panel Air Element
Fits: Honda Civic Hybrid
Replaces: Honda 17220-PZA-000
Length: 8 7/8 (225.4)
Width: 5 31/32 (151.6)
Height: 1 9/16 (39.7)
A. Gskt: [1] Attached



PA4382 Panel Air Element
Fits: Suzuki Aerio
Replaces: Suzuki 13780-54G10
Length: 9 9/16 (242.9)
Width: 6 15/32 (164.3)
Height: 2 1/8 (54.0)
A. Gskt: [1] Attached



PA4383 Panel Air Element
Fits: Audi, Volkswagen Automotive
Replaces: Audi 6F133843A; Volkswagen 6F133843A
Length: 15 29/32 (404.0)
Width: 6 25/32 (172.2)
Height: 1 13/32 (35.7)



Measurements Are Shown In Inches And (Millimeters)

 **WARNING:** These products can expose you to chemicals, including Diisononyl Phthalate, Carbon black extracts, Nickel, 1,3 Butadiene, Ethylene Oxide, Epichlorohydrin, which are known to the State of California to cause cancer, and Bisphenol, Ethylene Glycol, Ethylene Oxide, 1,3 Butadiene, Epichlorohydrin, which are known to the State of California to cause birth defects or other reproductive harm. For more information go to www.P65Warnings.ca.gov.

PA4384

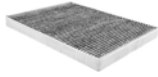

Cabin Air Element

Contains: Charcoal Impregnated Media for Odor Control.
Fits: Buick, Cadillac, Oldsmobile, Pontiac Automotive
Replaces: GMC 25689297; ACDelco CF105C, CF118C
Length: 11 21/32 (296.1)
Width: 8 13/16 (223.8)
Height: 7/8 (22.2)
Related To: PA4330 (Non-Charcoal Version)

PA4385



Panel Air Element

Fits: 2005-on Ford Escape Hybrid; 2006-on Mercury Mariner Hybrid
Replaces: Ford 5M6Z-9601-AA; Motorcraft FA1772
Length: 12 7/8 (327.0)
Width: 5 17/32 (140.5)
Height: 1 23/32 (43.7)

PA4386

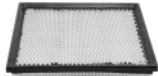

Panel Air Element

Fits: Land Rover Discovery, Freelander, Range Rover
Replaces: Land Rover ESR4238
Length: 9 7/16 (239.7)
Width: 8 1/32 (204.0)
Height: 1 13/16 (46.0)

PA4387



Panel Air Element

Fits: Hyundai Santa Fe
Replaces: Hyundai 28113-26350
Length: 10 5/8 (269.9)
Width: 7 17/32 (191.3)
Height: 1 31/32 (50.0)
A. Gskt: [1] Attached

PA4388



Air Element

Fits: Citroen, Peugeot Automotive
Replaces: Citroen 1444.H1; Peugeot 1444-H2
O.D.: 4 1/2 (114.3)
I.D.: 2 5/8 (66.7)
Height: 8 9/16 (218.3)

PA4389



Air Element

Replaces: Citroen 1444F5; Peugeot 1444-F5
O.D.: 6 5/8 (168.3)
I.D.: 4 23/32 (119.9)
Height: 4 27/32 (123.0)

PA4390



Panel Air Element

Fits: 2007-10 Dodge Sprinter, Freightliner Sprinter
Replaces: Chrysler 68013676AA; Mercedes-Benz A0000902651
Length: 13 29/32 (353.2)
Width: 10 7/16 (265.1)
Height: 2 1/4 (57.2)

PA4391



Cabin Air Element

Fits: Hyundai, Kia Automotive, Light-Duty Trucks
Replaces: Kia 97133-2E200, 97133-2E210
Length: 8 15/16 (227.0)
Width: 7 29/32 (200.8)
Height: 21/32 (16.7)

PA4392



Foam Cabin Air Element

Fits: Mazda 626
Replaces: Mazda GD7A-61-J6X; Wix 24486
Length: 9 1/8 (231.8)
Width: 8 21/32 (219.9)
Height: 5/16 (7.9)

PA4393



Cabin Air Element

Fits: Lexus, Toyota Automotive, Light-Duty Trucks
Replaces: Toyota 87139-07010
Length: 8 15/32 (215.1)
Width: 7 19/32 (192.9)
Height: 1 1/8 (28.6)

PA4394



Cabin Air Element

Fits: Ford, Mazda, Mercury Light-Duty Trucks
Replaces: Ford 8L8Z-19N619-B; Motorcraft FP66
Length: 12 3/16 (309.6)
Width: 4 (101.6) to 7 1/16 (179.4)
Height: 25/32 (19.8)
A. Gskt: [1] Attached

PA4395

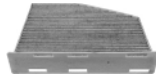

Cabin Air Element

Contains: Charcoal Impregnated Media for Odor Control.
Fits: Audi, Volkswagen Automotive
Replaces: Volkswagen 1K1819653A, 1K1819653B
Length: 11 1/4 (285.8)
Width: 6 (152.4) to 8 9/32 (210.3)
Height: 2 1/4 (57.2)
A. Gskt: [1] Attached

PA4397



Panel Air Element

Fits: Saturn Automotive
Replaces: Saturn 96815102
Length: 5 11/16 (144.5) to 11 1/8 (282.6)
Width: 8 13/16 (223.8)
Height: 5 1/4 (57.2)

PA4398



Cabin Air Element

Fits: Saturn Automotive
Replaces: Saturn 19130294
Length: 10 1/16 (255.6)
Width: 8 3/4 (222.3)
Height: 11/16 (17.5)

PA4399



Panel Air Element

Fits: Nissan Automotive
Replaces: Nissan 16546-JA00A, 16546-JA00B
Length: 12 11/32 (313.5)
Width: 5 7/32 (132.6)
Height: 2 1/4 (57.2)

PA4400



Panel Air Element

Fits: Kia Automotive
Replaces: Kia 28113-2G000
Length: 10 3/32 (256.4)
Width: 7 15/16 (201.6)
Height: 1 23/32 (43.7)

Measurements Are Shown In Inches And (Millimeters)



WARNING: These products can expose you to chemicals, including Diisononyl Phthalate, Carbon black extracts, Nickel, 1,3 Butadiene, Ethylene Oxide, Epichlorohydrin, which are known to the State of California to cause cancer, and Bisphenol, Ethylene Glycol, Ethylene Oxide, 1,3 Butadiene, Epichlorohydrin, which are known to the State of California to cause birth defects or other reproductive harm. For more information go to www.P65Warnings.ca.gov.

PA4401 Panel Air Element
Fits: Hyundai, Kia Automotive
Replaces: Hyundai 28113-2H000
Length: 7 3/4 (196.9)
Width: 7 13/32 (188.1)
Height: 1 15/16 (49.2)
A. Gskt: [1] Attached



PA4412 Panel Air Element
Fits: Chevrolet, GMC, Hummer, Isuzu Light-Duty Trucks
Replaces: General Motors 15942429; ACDelco A3095C
Length: 12 9/32 (311.9)
Width: 10 (254.0)
Height: 2 (50.8)
A. Gskt: [1] Included



PA4402 Panel Air Element
Fits: 2007-09 Hyundai Santa Fe
Replaces: Hyundai 28113-2B000
Length: 10 9/16 (268.3)
Width: 6 7/8 (174.6)
Height: 2 3/8 (60.3)
A. Gskt: [1] Attached



PA4413 Panel Air Element
Fits: 2007-09 Hyundai Entourage; 2006-on Kia Sedona
Replaces: Hyundai 28113-4D000; Kia 28113-4D000
Length: 11 31/32 (304.0)
Width: 6 9/32 (159.5)
Height: 2 1/8 (54.0)
A. Gskt: [1] Attached



PA4403 Set of 2 Cabin Air Elements
Notes: Uses 2 filters per application.
Fits: Mazda Automotive
Replaces: Mazda BP4K-61-J6X
Larger Filter
Length: 9 5/16 (236.5)
Width: 4 (101.6)
Height: 7/8 (22.2)
Smaller Filter
Length: 9 1/4 (235.0)
Width: 3 25/32 (96.0)
Height: 7/8 (22.2)
A. Gskt: [1] Attached to Smaller Filter



PA4414 Panel Air Element
Fits: BMW Automotive
Replaces: BMW 13717561235
Length: 14 1/4 (362.0)
Width: 5 3/32 (129.4)
Height: 1 31/32 (50.0)



PA4404 Cabin Air Element
Fits: Hyundai Automotive
Replaces: Hyundai 87901-E000A, 971331-E000
Length: 9 21/32 (245.3)
Width: 8 1/32 (204.0)
Height: 3/4 (19.1)
A. Gskt: [1] Attached



PA4416 KIT Set of 2 Cabin Air Elements
Notes: Uses 2 filters per application.
Fits: Acura, Honda Automotive
Replaces: Honda 80291-S84-A01
Each Filter:
Length: 11 19/32 (294.5)
Width: 3 3/4 (95.3)
Height: 1 3/16 (30.2)

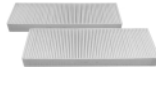

PA4405 Cabin Air Element
Fits: Chrysler, Dodge Vans; Infiniti Automotive
Replaces: Nissan 27277-EG025
Length: 9 (228.6)
Width: 7 13/16 (198.4)
Height: 1 1/4 (31.8)



PA4417 Panel Air Element
Fits: 2007-09 Honda CR-V
Replaces: Honda 17220-RZA-000
Length: 10 17/32 (267.5)
Width: 2 5/8 (66.7) to 6 23/32 (170.7)
Height: 1 15/16 (49.2)
A. Gskt: [1] Attached



PA4409 Cabin Air Element
Contains: Charcoal Impregnated Media for Odor Control.
Fits: Dodge, Freightliner Sprinter Vans
Replaces: Chrysler 5103600AA; Mercedes-Benz A9018300418
Length: 14 13/16 (376.2)
Width: 6 5/8 (168.3)
Height: 1 3/32 (27.8)
A. Gskt: [1] Attached
Related To: PA4489 (Standard Media Version)



PA4418 Panel Air Element
Fits: 2008-on Buick Enclave; 2009-on Chevrolet Traverse; 2007-on GMC Acadia, 2007-10 Saturn Outlook
Replaces: GMC 15278634; ACDelco A3083C
Length: 5 1/2 (139.7) to 13 3/4 (349.3)
Width: 2 1/4 (57.2) to 11 3/4 (298.5)
Height: 1 23/32 (43.7)
A. Gskt: [1] Attached

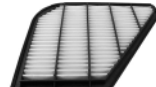

PA4410 KIT Set of 2 Cabin Air Elements
Notes: Uses 2 filters per application.
Fits: Nissan Frontier, Pathfinder, Xterra; Suzuki Equator
Replaces: Nissan 999M1-VR056
Each Filter:
Length: 10 5/32 (258.0)
Width: 3 31/32 (100.8)
Height: 31/32 (24.6)



PA4419 Panel Air Element
Fits: 2008-on Ford Focus
Replaces: Ford 8S4Z-9601-A; Motorcraft FA1890
Length: 3 3/4 (95.2) to 8 7/16 (214.3)
Width: 2 13/16 (71.4) to 7 3/4 (196.8)
Height: 2 3/16 (55.6)



PA4411 Cabin Air Element
Fits: Honda Fit
Replaces: Honda 80291-SAA-J01; Wix 24524
Length: 7 3/16 (182.6)
Width: 7 1/16 (179.4)
Height: 1 1/8 (28.6)









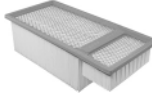

PA4421 Panel Air Element
Fits: 2006-08 Suzuki Grand Vitara
Replaces: Suzuki 13780-65J00; Wix 49085
Length: 9 (228.6)
Width: 5 1/8 (130.2) to 7 (177.8)
Height: 1 15/16 (49.2)
A. Gskt: [1] Attached

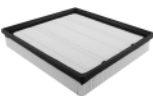
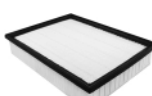
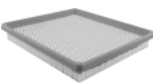
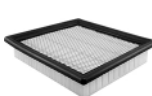
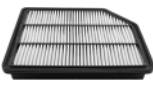

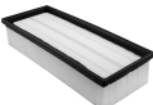
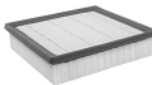
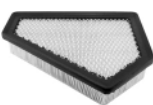
Measurements Are Shown In Inches And (Millimeters)

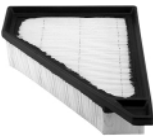
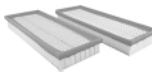
 **WARNING:** These products can expose you to chemicals, including Diisononyl Phthalate, Carbon black extracts, Nickel, 1,3 Butadiene, Ethylene Oxide, Epichlorohydrin, which are known to the State of California to cause cancer, and Bisphenol, Ethylene Glycol, Ethylene Oxide, 1,3 Butadiene, Epichlorohydrin, which are known to the State of California to cause birth defects or other reproductive harm. For more information go to www.P65Warnings.ca.gov.

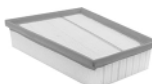
<p>PA4422</p> 	<p>Panel Air Element Fits: Nissan Frontier; Suzuki Equator Replaces: Nissan 16546-EA000 Length: 15 1/16 (382.6) Width: 7 9/32 (184.9) Height: 1 5/16 (33.3)</p>	<p>PA4433</p> 	<p>Panel Air Element Fits: Ford Super Duty F450, F550 Trucks with V8-406 (6.7L) FI Turbo Diesel Engine Replaces: Ford BC3Z-9601-A; Motorcraft FA1902 Length: 14 1/16 (357.2) Width: 6 11/16 (169.9) Height: 4 9/32 (108.7)</p>
<p>PA4423</p> 	<p>Panel Air Element Fits: Saturn Ion Replaces: General Motors 15893542; Saturn 15800986 Length: 11 15/16 (303.2) Width: 7 23/32 (196.1) Height: 1 5/16 (33.3)</p>	<p>PA4434</p> 	<p>Panel Air Element Fits: Honda Pilot Replaces: Honda 17220-RN0-A00 Length: 11 27/32 (300.8) Width: 6 7/8 (174.6) Height: 1 27/32 (46.8) A. Gskt: [1] Included</p>
<p>PA4425</p> 	<p>Panel Air Element Fits: Ford Transit 2.2 TDCI Van (7/06-on) Replaces: Ford 1373667, 6C11-9601-CB Length: 10 3/4 (273.1) Width: 9 13/16 (249.2) Height: 1 27/32 (46.8)</p>	<p>PA4435</p> 	<p>Panel Air Element with Foam Pad Fits: Lexus GX460; Toyota 4Runner, FJ Cruiser Replaces: Toyota 17801-38050 Length: 12 19/32 (319.9) Width: 9 11/32 (237.3) Height: 2 7/16 (61.9)</p>
<p>PA4426</p> 	<p>Panel Air Element Fits: Chrysler, Dodge, Volkswagen Automotive, Vans Replaces: Chrysler 4891713AA; Volkswagen 7B0129620 Length: 9 11/32 (237.3) Width: 8 7/16 (214.3) Height: 1 3/8 (34.9)</p>	<p>PA4436</p> 	<p>Panel Air Element Fits: Chrysler Cirrus; Dodge Journey Replaces: Chrysler 4891916AA Length: 9 5/32 (232.6) Width: 8 15/32 (215.1) Height: 1 27/32 (46.8)</p>
<p>PA4427</p> 	<p>Panel Air Element Fits: Hyundai Veracruz; Volkswagen Jetta, Passat Replaces: Hyundai 28113-3J100 Length: 12 1/4 (311.2) Width: 9 7/16 (239.7) Height: 1 11/16 (42.9) A. Gskt: [1] Included</p>	<p>PA4437</p> 	<p>Panel Air Element Fits: 2007-on Jeep Wrangler Replaces: Chrysler 53034018AD, 53034018AE Length: 11 1/2 (292.1) Width: 8 3/16 (208.0) Height: 1 23/32 (43.7) A. Gskt: [1] Attached</p>
<p>PA4428</p> 	<p>Panel Air Element Fits: Audi, Volkswagen Automotive Replaces: Volkswagen 1K0129620D, 1K0129620G, 3C0129620B; Length: 13 9/16 (344.5) Width: 5 11/32 (135.7) Height: 2 25/32 (70.6)</p>	<p>PA4438</p> 	<p>Panel Air Element Fits: Dodge Durango, Jeep Grand Cherokee Replaces: Chrysler 4861756AA Length: 9 5/8 (244.5) Width: 8 3/4 (222.3) Height: 2 3/16 (55.6)</p>
<p>PA4429</p> 	<p>Panel Air Element Fits: Cadillac CTS Replaces: General Motors 15875795; ACDelco A3096C Length: 11 3/8 (288.9) Width: 9 3/8 (238.1) Height: 2 3/32 (53.2)</p>	<p>PA4439</p> 	<p>Panel Air Element Fits: 2004-09 Cadillac SRX, 2005-on STS Replaces: General Motors 25735595, 25798271; ACDelco A2944C Length: 13 7/8 (352.4) Width: 9 (228.6) Height: 1 1/4 (31.8) A. Gskt: [1] Attached</p>
<p>PA4430</p> 	<p>Panel Air Element Fits: Ford Transit Connect Replaces: Ford 9T1Z-9601-A, 9T16-9601-AA; Motorcraft FA1900 Length: 2 11/16 (68.3) to 10 1/32 (254.8) Width: 1 1/32 (26.2) to 8 3/16 (208.0) Height: 2 13/32 (61.1)</p>	<p>PA4440 KIT</p> 	<p>Set of 2 Panel Air Elements Notes: Uses 2 filters per application. Fits: Mercedes-Benz Automotive Replaces: Mercedes-Benz 1120940004, 1120940604, 1120910004, 1130940004 Each Filter: Length: 13 29/32 (353.2) Width: 5 1/4 (133.4) Height: 1 3/4 (44.5)</p>
<p>PA4431</p> 	<p>Panel Air Element with Felt Pad Fits: Chevrolet Equinox, GMC Terrain Replaces: General Motors 25899727; ACDelco A3138C Length: 10 15/16 (277.8) Width: 8 27/32 (224.6) Height: 2 1/32 (51.6)</p>	<p>PA4441</p> 	<p>Panel Air Element Fits: 2007-12 Nissan Sentra Replaces: Nissan 16546-ET000 Length: 9 1/16 (230.2) Width: 7 7/16 (188.9) Height: 2 9/32 (57.9)</p>

Measurements Are Shown In Inches And (Millimeters)

 **WARNING:** These products can expose you to chemicals, including Diisononyl Phthalate, Carbon black extracts, Nickel, 1,3 Butadiene, Ethylene Oxide, Epichlorohydrin, which are known to the State of California to cause cancer, and Bisphenol, Ethylene Glycol, Ethylene Oxide, 1,3 Butadiene, Epichlorohydrin, which are known to the State of California to cause birth defects or other reproductive harm. For more information go to www.P65Warnings.ca.gov.

PA4442 Panel Air Element
Fits: Nissan Cube, Tiida, Versa
Replaces: Nissan 16546-ED000
Length: 9 1/16 (230.2)
Width: 5 5/16 (134.9)
Height: 1 11/32 (34.1)
A. Gskt: [1] Included

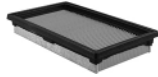

PA4443 Panel Air Element
Fits: Infiniti G35, EX35, G37, QX50; Nissan 350Z, 370Z
Replaces: Nissan 16546-JK20A
Length: 7 1/8 (181.0)
Width: 6 5/8 (168.3)
Height: 1 5/16 (33.3)

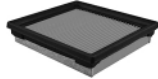

PA4444 Cabin Air Element with Pull Tab
Fits: Nissan Altima, Murano, Maxima, Quest
Replaces: Nissan 27277-JA000, 27277-JA00A, B7277-JN20A
Length: 11 1/16 (281.0)
Width: 10 9/16 (268.3)
Height: 13/16 (17.5)



RS4445 Radial Seal Air Element
Fits: Ford Escape, Mazda Tribute, Mercury Mariner
Replaces: Ford 9L8Z-9601-A; Mazda Z2C423603
O.D.: 5 31/32 (151.6)
I.D.: 3 1/32 (77.0) One End
Height: 10 1/8 (257.2)



PA4446 Panel Air Element
Fits: 2009-10 Pontiac Vibe; 2008-on Scion xD; 2006-on Toyota Yaris, 2009-on Corolla, Matrix
Replaces: General Motors 88975792; Toyota 17801-0D060, 17801-0T030, 17801-21050
Length: 9 7/16 (239.7)
Width: 6 31/32 (177.0)
Height: 2 3/32 (53.2)
A. Gskt: [1] Attached



PA4447 Panel Air Element
Fits: 2006-10 Hyundai Sonata
Replaces: Hyundai 28113-3K010
Length: 9 1/8 (231.8)
Width: 7 15/32 (189.7)
Height: 2 9/32 (57.9)

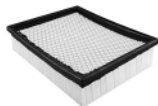

PA4448 Panel Air Element
Fits: Lexus RX400h; Toyota Highlander
Replaces: Toyota 17801-20050
Length: 14 5/16 (363.5)
Width: 6 3/16 (157.2)
Height: 1 29/32 (48.4)
A. Gskt: [1] Included



PA4449 Panel Air Element
Fits: Lexus RX350; Toyota Sienna
Replaces: Toyota 17801-0P050, 17801-31130
Length: 9 9/16 (242.9)
Width: 8 29/32 (226.2)
Height: 2 1/8 (54.0)

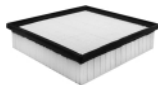

RS4450 Radial Seal Air Element
Fits: Ford Escape, Focus; Lincoln MKC
Replaces: Ford CV6Z-9601-A; Motorcraft FA1908
O.D.: 6 3/16 (157.2)
I.D.: 2 3/4 (69.9) One End
Height: 8 5/16 (211.1)
I.Gskt: [1] Included



PA4451 Panel Air Element
Fits: BMW X3, Z4
Replaces: BMW 13717542545
Length: 11 3/16 (284.2)
Width: 8 15/16 (227.0)
Height: 1 7/8 (47.6)



PA4452 Panel Air Element
Fits: Acura ILX, Honda Civic
Replaces: Honda 17220R1AA01
Length: 9 11/16 (246.1)
Width: 7 5/16 (185.7)
Height: 1 15/16 (49.2)
A. Gskt: [1] Included



PA4453 Panel Air Element with Foam Pad
Fits: Chevrolet Cruze; Buick Verano
Replaces: General Motors 13272719
Length: 10 15/32 (265.9)
Width: 10 3/16 (258.8)
Height: 1 15/32 (37.3)

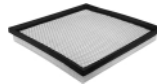

PA4454 Panel Air Element with Foam Pad
Fits: Buick, Chevrolet Automotive
Replaces: General Motors 13272720
Length: 10 3/32 (256.4)
Width: 9 13/16 (249.2)
Height: 1 21/32 (42.1)

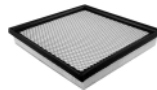

PA4455 Panel Air Element
Fits: Ford Fiesta
Replaces: Ford BE8Z-9601-A; Motorcraft FA1904
Length: 7 23/32 (196.1)
Width: 6 1/4 (158.8)
Height: 2 5/16 (58.7)

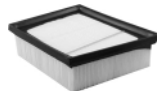

PA4456 Panel Air Element
Fits: Chrysler Town & Country, Dodge Grand Caravan; Ram Cargo Van; Volkswagen Routan
Replaces: Chrysler 4861737AA
Length: 12 3/4 (323.9)
Width: 9 23/32 (246.9)
Height: 1 25/32 (45.2)



PA4458 Panel Air Element
Fits: Dodge Pickups with 6-360 (5.9L) FI Turbo Diesel Engine
Replaces: Chrysler 53034249AA
Length: 10 15/16 (277.8)
Width: 9 15/16 (252.4)
Height: 4 13/32 (111.9)

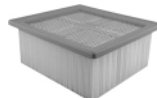









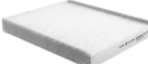
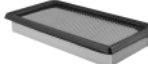

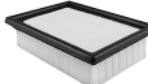

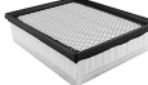
PA4460 KIT Set of 2 Cabin Air Elements
Fits: Jeep Wrangler
Replaces: Chrysler 55111302AA
Each Filter:
Length: 6 1/16 (154.0)
Width: 2 15/16 (74.6)
Height: 25/32 (19.8)

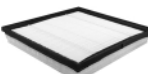

Measurements Are Shown In Inches And (Millimeters)

WARNING: These products can expose you to chemicals, including Diisononyl Phthalate, Carbon black extracts, Nickel, 1,3 Butadiene, Ethylene Oxide, Epichlorohydrin, which are known to the State of California to cause cancer, and Bisphenol, Ethylene Glycol, Ethylene Oxide, 1,3 Butadiene, Epichlorohydrin, which are known to the State of California to cause birth defects or other reproductive harm. For more information go to www.P65Warnings.ca.gov.

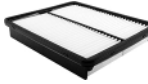
<p>PA4461</p> 	<p>Cabin Air Element Fits: Ford Explorer, Flex, Taurus, Lincoln MKS, MKT Replaces: Ford AE9Z19N619A; Motorcraft FP68 Length: 8 15/16 (227.0) Width: 7 9/32 (184.9) Height: 1 1/32 (26.2) A. Gskt: [2] Included</p>	<p>PA4469</p>  <p>Panel Air Element Fits: Nissan Versa with 4-1598cc (1.6L) Engine Replaces: Nissan 165461HK0A Length: 9 1/8 (231.8) Width: 4 9/16 (115.9) Height: 1 11/32 (34.1)</p>
<p>PA4462</p> 	<p>Cabin Air Element Fits: Dodge Durango, Jeep Grand Cherokee Replaces: Chrysler 68079487AA Length: 10 3/8 (263.5) Width: 9 19/32 (243.7) Height: 1 3/16 (30.2)</p>	<p>PA4470</p>  <p>Panel Air Element Fits: Ford Escape, Transit Connect Replaces: Ford CJ5Z-9601-A; Motorcraft FA1910 Length: 8 5/32 (207.2) Width: 6 3/32 (154.8) Height: 2 3/16 (55.6)</p>
<p>PA4463</p> 	<p>Panel Air Element Fits: Acura ILX, NSX, Honda Civic Replaces: Honda 17220RX0A00 Length: 10 7/32 (259.6) Width: 6 15/32 (164.3) Height: 2 13/32 (61.1) A. Gskt: [1] Included</p>	<p>PA4471</p>  <p>Panel Air Element with Foam Pad Fits: Ford Fusion; Lincoln MKZ Replaces: Ford DS7Z-9601-A; Motorcraft FA1912 Length: 9 23/32 (246.9) Width: 7 29/32 (200.8) Height: 1 29/32 (48.4)</p>
<p>PA4464</p> 	<p>Panel Air Element with Foam Pad Fits: Chevrolet Impala with V6-217 (3.6L) Engine Replaces: General Motors 20862288; ACDelco A3171C Length: 11 13/16 (300.0) Width: 7 3/16 (182.6) Height: 2 29/32 (73.8)</p>	<p>PA4472</p>  <p>Air Element Fits: Citroen, Fiat, Peugeot Vans Replaces: Citroen 1444QV; Fiat 1349042080, 1359643080; Peugeot 1444QT O.D.: 6 5/8 (168.3) I.D.: 3 13/16 (96.8) One End Height: 11 15/16 (303.2)</p>
<p>PA4465</p> 	<p>Panel Air Element with Foam Pad Fits: Cadillac SRX; Saab 9-4X Replaces: General Motors 15913344, 20897358; ACDelco A3139C, A3147C Length: 10 7/16 (265.1) Width: 10 13/32 (264.3) Height: 1 23/32 (43.7)</p>	<p>PA4473</p>  <p>Panel Air Element Fits: Dodge Dart Replaces: Chrysler 4627127AB Length: 7 23/32 (196.1) Width: 7 15/32 (189.7) Height: 2 5/16 (58.7)</p>
<p>PA4466</p> 	<p>Panel Air Element with Foam Pad Fits: Chevrolet Silverado, GMC Sierra Light-Duty Trucks with V8-400 (6.6L) Turbo Diesel Engine Replaces: General Motors 25945271; ACDelco A3141C Length: 13 (330.2) Width: 9 1/2 (241.3) Height: 2 29/32 (73.8)</p>	<p>PA4474</p>  <p>Cabin Air Element Fits: Ford Focus, C-Max, Escape, Transit Connect; Lincoln MKC Replaces: Motorcraft FP70 Length: 9 27/32 (250.0) Width: 8 (203.2) Height: 1 13/32 (35.7) A. Gskt: [2] Included</p>
<p>PA4467</p> 	<p>Panel Air Element with Foam Pad Fits: Nissan Interstar 2.2 DCI, Interstar 2.5 DCI Vans; Opel Movano II 2.2 CDTI, Movano II 2.5 CDTI Vans; Renault Master III 2.2 DCI, Master III 2.5 DCI, Master III 3.0 DCI Vans Replaces: Nissan 1654600QAD; Opel 4405238, 4416481; Renault 8200259359, 8200505566 Length: 11 9/32 (286.5) Width: 9 13/16 (249.2) Height: 2 23/32 (69.1)</p>	<p>PA4475</p>  <p>Cabin Air Element Fits: Ford Fusion, Lincoln MKZ Replaces: Motorcraft FP71 Length: 10 15/16 (277.8) Width: 8 13/16 (223.8) Height: 3/4 (19.1)</p>
<p>PA4468</p> 	<p>Panel Air Element Fits: Honda CR-V with 4-2354cc (2.4L) Engine Replaces: Honda 17220R5AA00 Length: 10 1/8 (257.2) Width: 7 3/4 (196.9) Height: 1 11/16 (42.9) A. Gskt: [1] Included</p>	<p>PA4476</p>  <p>Panel Air Element Fits: Hyundai Azera, Sonata; Kia Optima, Sorento Replaces: Kia 281132P100; Knecht LX2957; Mahle LX2957 Length: 10 29/32 (277.0) Width: 8 31/32 (227.8) Height: 1 5/8 (41.3) A. Gskt: [1] Included</p>

Measurements Are Shown In Inches And (Millimeters)

 **WARNING:** These products can expose you to chemicals, including Diisononyl Phthalate, Carbon black extracts, Nickel, 1,3 Butadiene, Ethylene Oxide, Epichlorohydrin, which are known to the State of California to cause cancer, and Bisphenol, Ethylene Glycol, Ethylene Oxide, 1,3 Butadiene, Epichlorohydrin, which are known to the State of California to cause birth defects or other reproductive harm. For more information go to www.P65Warnings.ca.gov.

PA4477 Panel Air Element
Fits: Honda CR-V
Replaces: Honda 17220REZA00
Length: 10 13/32 (264.3)
Width: 7 1/2 (190.5)
Height: 2 3/32 (53.2)
A. Gskt: [1] Included



PA4478 Panel Air Element
Fits: Chrysler 300, Dodge Challenger, Charger
Replaces: Chrysler 4861746AA
Length: 14 1/4 (362.0)
Width: 9 1/8 (231.8)
Height: 1 15/32 (37.3)



PA4479 Panel Air Element
Fits: Hyundai Accent, Veloster; Kia Rio, Soul
Replaces: Hyundai 281131R100
Length: 10 5/32 (258.0)
Width: 5 3/4 (146.1)
Height: 1 7/8 (47.6)
A. Gskt: [1] Included



PA4480 Panel Air Element
Fits: Hyundai Elantra; Kia Forte
Replaces: Hyundai 281133X000
Length: 10 5/32 (258.0)
Width: 6 13/32 (162.7)
Height: 2 1/16 (52.4)
A. Gskt: [1] Included



PA4481 Panel Air Element
Fits: Hyundai Santa Fe; Kia Sorento
Replaces: Hyundai 28113-2W100
Length: 11 27/32 (300.8)
Width: 9 (228.6)
Height: 1 15/32 (37.3)
A. Gskt: [1] Included

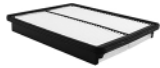

PA4483 Panel Air Element
Fits: Jeep Grand Cherokee
Replaces: Chrysler 4861688AA
Length: 8 11/16 (220.7)
Width: 8 9/32 (210.3)
Height: 1 15/16 (49.2)



PA4484 Panel Air Element
Fits: Jeep Cherokee
Replaces: Chrysler 52022378AA
Length: 10 19/32 (269.1)
Width: 7 9/32 (187.9)
Height: 1 21/32 (42.1)



PA4485 Panel Air Element
Contains: Flame Retardant Media
Fits: Chevrolet Malibu, Impala
Replaces: General Motors 20972654
Length: 11 3/16 (284.2)
Width: 9 15/16 (252.4)
Height: 1 9/16 (39.7)
Related To: PA4487 (with Foam Pad)

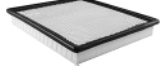

PA4486 Cabin Air Element
Fits: General Motors Light-Duty Trucks
Replaces: General Motors 22808781
Length: 9 3/4 (247.7)
Width: 9 5/32 (232.6)
Height: 1 3/16 (30.2)



PA4487 Panel Air Element with Foam Pad
Contains: Flame Retardant Media
Fits: Buick Regal; Cadillac XTS;
 Chevrolet Malibu
Replaces: General Motors 20972655
Length: 11 3/16 (284.2)
Width: 9 15/16 (252.4)
Height: 1 11/16 (42.9)
Related To: PA4485 (without Foam Pad)

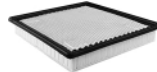

PA4488 Cabin Air Element
Fits: Dodge, Freightliner, Mercedes-Benz
 Sprinter Light-Duty Trucks
Replaces: Mercedes-Benz 9068300218,
 A9068300218; Donaldson P787452
Length: 13 31/32 (354.8)
Width: 9 7/32 (234.2)
Height: 1 3/8 (34.9)
A. Gskt: [1] Attached
Related To: PA4336 (Charcoal Media Version)

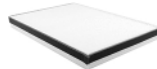

PA4489 Cabin Air Element
Fits: Sprinter Vans
Replaces: Mercedes-Benz 8303318,
 9018300018, A00083603318, A901830018
Length: 14 9/16 (369.9)
Width: 6 7/16 (163.5)
Height: 31/32 (24.6)
A. Gskt: [1] Attached
Related To: PA4409 (Charcoal Media Version)

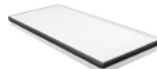

PA4548 Inner Air Element
Fits Inside: PA3650
Fits: Komatsu Excavators
Replaces: Komatsu 600-181-6360
O.D.: 3 5/32 (80.2)
I.D.: 5/8 (15.9) & 2 5/32 (54.8)
Height: 9 1/32 (229.4)
A. Gskt: [1] Attached
F. Gskt: [1] Included



RS4549 Radial Seal Inner Air Element
Fits Inside: RS3714
Fits: M.A.N. Trucks
Replaces: M.A.N. 81.08304.0084;
 Donaldson P778453
O.D.: 6 7/8 (174.6)
I.D.: 6 7/16 (163.5) One End
Height: 18 1/2 (469.9)



PA4551 Oval Air Element with Foam Wrap
Fits: Honda GX110 Engine
Replaces: Honda 17201-ZE0-822,
 17210-ZE0-505
O.D.: 2 7/8 (73.0) to 4 (101.6)
I.D.: 1/4 (6.4) & 1 5/16 (33.3)
Height: 2 1/16 (52.4)
A. Gskt: [1] Metal Washer
Grommets: [1] Attached



Measurements Are Shown In Inches And (Millimeters)

WARNING: These products can expose you to chemicals, including Diisononyl Phthalate, Carbon black extracts, Nickel, 1,3 Butadiene, Ethylene Oxide, Epichlorohydrin, which are known to the State of California to cause cancer, and Bisphenol, Ethylene Glycol, Ethylene Oxide, 1,3 Butadiene, Epichlorohydrin, which are known to the State of California to cause birth defects or other reproductive harm. For more information go to www.P65Warnings.ca.gov.

PA4552



Oval Air Element with Foam Wrap
Fits: Honda GX240, GX270 Engines
Replaces: Honda 17210-ZE2-505, 17210-ZE2-822
O.D.: 3 1/2 (88.9) to 3 31/32 (100.8)
I.D.: 1 1/2 (38.1) & 1 5/8 (41.3)
Height: 3 3/32 (78.6)
A. Gskt: [1] Metal Washer
Grommets: [1] Attached

RS4561



Radial Seal Air Element
Fits: Caterpillar Engines
Replaces: Caterpillar 289-2348
O.D.: 10 31/32 (278.6)
I.D.: 5 13/16 (147.6) One End
Height: 16 7/16 (417.5)

PA4553



Oval Air Element with Foam Wrap
Notes: Replacement foam wrap is PA4187.
Fits: John Deere Garden Tractors, Transporters
Replaces: John Deere M117254
O.D.: 4 21/32 (118.3) to 7 7/8 (200.0)
I.D.: 2 21/32 (67.5) & 5 7/8 (149.2)
Height: 2 9/16 (65.1)

RS4562



Radial Seal Air Element
Fits: DAF Trucks
Replaces: DAF 1346885, 1385791
O.D.: 9 11/16 (246.1)
I.D.: 4 29/32 (124.6) One End
Height: 17 7/16 (442.9)

PA4554



Panel Air Element
Replaces: Elgin 7070010
Length: 13 15/16 (354.0)
Width: 6 (152.4)
Height: 2 9/16 (65.1)
A. Gskt: [1] Attached

RS4563



Conical-Shaped Radial Seal Air Element
Fits: Freightliner Trucks
Replaces: Fleetguard AF25693, Nelson 870710A, 870710N
O.D.: 7 3/4 (196.9) to 10 13/32 (264.3)
I.D.: 3 1/8 (79.4) & 5 27/32 (148.4)
Height: 22 3/16 (563.6)
F. Gskt: [1] Included

PA4555

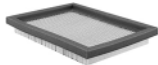

Panel Air Element
Fits: Briggs & Stratton Engines
Replaces: Briggs & Stratton 397795; GMC 25177524
Length: 6 5/16 (160.3)
Width: 4 7/16 (112.7)
Height: 13/16 (20.6)

RS4564



Radial Seal Air Element
Notes: Uses 2 filters per application. Inside-Out Flow Direction
Contains: 3 3/4 Inch Dust Ejector Hole
Fits: Peterbilt Trucks
Replaces: Donaldson P542753
O.D.: 11 3/8 (288.9)
I.D.: 6 13/16 (173.0) One End
Height: 21 11/32 (542.1)
F. Gskt: G501-AF

PA4557



Air Element
Fits: Onan RV Generators
Replaces: Onan 140-1891, 140-2379
O.D.: 4 (101.6)
I.D.: 2 3/4 (69.9)
Height: 3 5/32 (80.2)

PA4566



Air Element
Fits: Caterpillar Equipment
Replaces: Caterpillar 8T6288; Ingersoll-Rand 39322201
O.D.: 12 3/4 (323.9)
Boot Gasket: 13 11/32 (338.9)
I.D.: 15/16 (23.8) & 8 11/32 (211.9)
Height: 24 1/2 (622.3)
A. Gskt: [2] Attached

PA4559



Foam Cab Air Element
Fits: Volvo Loaders
Replaces: Volvo 11007847
Length: 18 5/32 (461.2)
Width: 15 9/16 (395.3)
Height: 19/32 (15.1)

PA4567

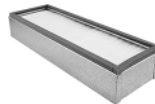

Cab Air Element
Fits: John Deere Equipment
Replaces: John Deere AT141209; Nelson 87387N
Length: 14 5/8 (371.5)
Width: 4 7/8 (123.8)
Height: 2 9/16 (65.1)
A. Gskt: [1] Attached

PA4560



Cab Air Element
Fits: Volvo Construction Equipment
Replaces: Volvo 11007848
Length: 15 19/32 (396.1)
Width: 12 27/32 (326.2)
Height: 2 3/4 (69.9)

Measurements Are Shown In Inches And (Millimeters)

WARNING: These products can expose you to chemicals, including Diisononyl Phthalate, Carbon black extracts, Nickel, 1,3 Butadiene, Ethylene Oxide, Epichlorohydrin, which are known to the State of California to cause cancer, and Bisphenol, Ethylene Glycol, Ethylene Oxide, 1,3 Butadiene, Epichlorohydrin, which are known to the State of California to cause birth defects or other reproductive harm. For more information go to www.P65Warnings.ca.gov.

PA4570



Set of 2 Cab Air Elements
Notes: Uses 2 filters per application.
Fits: John Deere Tractors
Replaces: John Deere AL112954, AL112955, AL71259
Each Filter:
Length: 8 (203.2)
Width: 4 1/4 (108.0) to 6 1/4 (158.8)
Height: 1 7/16 (36.5)
A. Gskt: [1] Attached Each Element

RS4577



Radial Seal Inner Air Element
Fits Inside: RS4576
Fits: Case Tractors
Replaces: Case 294293A1
O.D.: 8 1/8 (206.4)
I.D.: 6 1/8 (155.6) One End
Height: 10 9/16 (268.3)

PA4571



Air Element with 6 Bolt Holes
Replaces: Cummins 3630778; Fleetguard AF25278
O.D.: 13 13/16 (350.8)
Lid: 16 1/4 (412.8)
I.D.: 9 1/2 (241.3) One End
Height: 18 1/2 (469.9)
A. Gskt: [1] Attached

RS4578



Radial Seal Air Element
Contains: Flame Retardant Media
Fits: Hyster Lift Trucks
Replaces: Hyster 8500534
O.D.: 5 13/32 (137.3)
I.D.: 3 3/16 (81.0) One End
Height: 12 31/32 (329.4)
Related To: RS3542 (Standard Media Version)

RS4572



Radial Seal Air Element
Fits: Peterbilt Trucks
Replaces: Donaldson P544243
O.D.: 12 3/32 (332.6)
I.D.: 7 3/8 (187.3) One End
Height: 21 11/16 (550.9)
F. Gskt: [1] Included

RS4579



Radial Seal Outer Air Element
Fits: Atlas Copco Drilling Rigs; Case-International, New Holland Tractors; Volvo Dump Trucks
Use With: RS4580
Replaces: Volvo 11110217; Donaldson P781398
O.D.: 14 7/32 (361.2)
I.D.: 8 15/16 (227.0) One End
Height: 19 3/8 (492.1)

PA4573



Outer Air Element with Lift Bars
Fits: New Holland Equipment
Use With: PA4574
Replaces: New Holland 86512478
O.D.: 11 1/2 (292.1)
I.D.: 13/32 (10.3) & 7 1/4 (184.2)
Height: 20 3/4 (527.1)
A. Gskt: [1] Attached
F. Gskt: [1] Included

RS4580



Radial Seal Inner Air Element
Fits Inside: RS4579
Fits: Atlas Copco Drilling Rigs; Case-International, New Holland Tractors; Volvo Dump Trucks
Replaces: Volvo 11110218; Donaldson P781399
O.D.: 9 3/32 (231.0)
I.D.: 6 29/32 (175.4) One End
Height: 19 3/32 (485.0)

PA4574



Inner Air Element
Fits Inside: PA4573
Fits: New Holland Equipment
Replaces: New Holland 86512478
O.D.: 6 7/8 (174.6)
I.D.: 5/8 (15.9) & 5 13/32 (137.3)
Height: 19 1/8 (485.8)
A. Gskt: [1] Attached
F. Gskt: [1] Included

PA4581



Outer Air Element
Fits: Komatsu Dozers, Graders
Use With: PA4582
Replaces: Komatsu 600-300-0110
O.D.: 8 1/2 (215.9)
I.D.: 4 5/32 (105.6) One End
Height: 16 3/4 (425.5)
A. Gskt: [1] Attached
Related To: PA3609 (with Bolt Hole in Closed End)

RS4576



Radial Seal Outer Air Element
Fits: Case Tractors
Use With: RS4577
Replaces: Case 294292A1
O.D.: 13 7/16 (341.3)
I.D.: 7 29/32 (200.8) One End
Height: 11 9/16 (293.7)

PA4582



Inner Air Element with 6 Bolts
Fits Inside: PA4581
Fits: Komatsu Dozers, Graders
Replaces: Komatsu 600-300-0121, 6110-80-7300, 6610-80-7300
O.D.: 4 5/32 (105.6)
Flange: 6 11/16 (169.9)
I.D.: 2 27/32 (72.2) One End
Height: 16 7/16 (417.5)
A. Gskt: [1] Attached

Measurements Are Shown In Inches And (Millimeters)

WARNING: These products can expose you to chemicals, including Diisononyl Phthalate, Carbon black extracts, Nickel, 1,3 Butadiene, Ethylene Oxide, Epichlorohydrin, which are known to the State of California to cause cancer, and Bisphenol, Ethylene Glycol, Ethylene Oxide, 1,3 Butadiene, Epichlorohydrin, which are known to the State of California to cause birth defects or other reproductive harm. For more information go to www.P65Warnings.ca.gov.

PA4583-FN



Air Element with Fins
Fits: Caterpillar Lift Trucks
Replaces: Mitsubishi 91461-11500
O.D.: 5 1/4 (133.4)
 Fins 6 3/8 (161.9)
I.D.: 2 1/32 (16.7) & 3 5/16 (84.1)
Height: 11 3/8 (288.9)
A. Gskt: [1] Attached
F. Gskt: [1] Included

RS4597



Radial Seal Cab Air Element
Fits: John Deere Loaders
Replaces: John Deere T168220
O.D.: 6 1/2 (165.1)
I.D.: 3 9/16 (90.5) One End
Height: 11 19/32 (294.5)

PA4585



Air Element with Lid
Replaces: Fleetguard AF1968
O.D.: 10 5/8 (269.9)
 Lid 11 11/16 (296.9)
I.D.: 6 23/32 (170.7) One End
Height: 22 15/32 (570.7)
A. Gskt: [1] Attached

RS4598



Radial Seal Outer Air Element
Fits: New Holland Tractors
Use With: RS4599
Replaces: New Holland 82983412
O.D.: 6 1/2 (165.1)
I.D.: 3 11/16 (93.7) One End
Height: 14 5/8 (371.5)

PA4592



Cab Air Element
Fits: Caterpillar Equipment
Replaces: Caterpillar 7R2258
Length: 17 (431.8)
Width: 6 (152.4)
Height: 2 3/16 (55.6)

RS4599



Radial Seal Inner Air Element
Fits Inside: RS4598
Fits: New Holland Tractors
Replaces: New Holland 82983413
O.D.: 3 29/32 (99.2)
I.D.: 3 1/16 (77.8) One End
Height: 14 1/32 (356.4)

PA4593



Outer Air Element
Fits: Komatsu Dozers
Use With: PA4594
Replaces: Komatsu 600-181-7210;
 Donaldson P181144
O.D.: 7 1/16 (179.4)
I.D.: 7/16 (11.1) & 3 15/16 (100.0)
Height: 12 3/8 (314.3)
A. Gskt: [1] Attached
Grommets: [1] Attached

PA4600

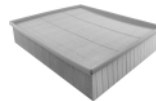

Panel Air Element
Fits: Dodge, Freightliner, Mercedes-Benz,
 Volkswagen Trucks, Vans
Replaces: Mercedes-Benz 30947504,
 30948204, 40942604, A0030947504;
 Volkswagen 2D0129620
Length: 12 13/32 (315.1)
Width: 10 7/8 (276.2)
Height: 2 25/32 (70.6)
A. Gskt: [1] Attached

PA4594



Inner Air Element
Fits Inside: PA4593
Fits: Komatsu Dozers
Replaces: Komatsu 600-181-7310
O.D.: 3 13/16 (96.8)
I.D.: 5/8 (15.9) & 2 3/8 (60.3)
Height: 11 7/16 (290.5)
A. Gskt: [1] Attached
F. Gskt: [1] Included

PA4601

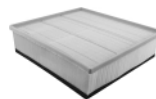

Panel Air Element with Foam Pad
Fits: Dodge, Freightliner, Mercedes-Benz,
 Volkswagen Trucks, Vans
Replaces: Mercedes-Benz 30948304,
 A0030948304; Volkswagen 2D0129620A
Length: 12 13/32 (315.1)
Width: 10 7/8 (276.2)
Height: 3 3/16 (81.0)

RS4595



Radial Seal Outer Air Element
Fits: Fleetguard/Nelson AH19087, AH19088,
 AH19089, AH19090 Housings
Use With: RS3747
Replaces: Nelson 87797N;
 Fleetguard AF25553
O.D.: 5 1/32 (127.8)
I.D.: 3 5/32 (80.2) One End
Height: 12 7/16 (315.9)

PA4602



Outer Air Element
Fits: Hitachi Excavators
Use With: PA4603
Replaces: Hitachi 4285623
O.D.: 6 3/32 (154.8)
 Flange 7 7/8 (200.0)
I.D.: 2 1/32 (16.7) & 4 3/32 (104.0)
Height: 12 7/8 (327.0)
A. Gskt: [1] Attached
F. Gskt: [1] Included

Measurements Are Shown In Inches And (Millimeters)

WARNING: These products can expose you to chemicals, including Diisononyl Phthalate, Carbon black extracts, Nickel, 1,3 Butadiene, Ethylene Oxide, Epichlorohydrin, which are known to the State of California to cause cancer, and Bisphenol, Ethylene Glycol, Ethylene Oxide, 1,3 Butadiene, Epichlorohydrin, which are known to the State of California to cause birth defects or other reproductive harm. For more information go to www.P65Warnings.ca.gov.

PA4603



Inner Air Element

Fits Inside: PA4602
Fits: Hitachi Excavators
Replaces: Hitachi 4247975
O.D.: 3 7/8 (98.4)
I.D.: 5/8 (15.9) & 3 3/16 (81.0)
Height: 11 19/32 (294.5)
A. Gskt: [1] Attached
F. Gskt: [1] Washer

PA4610 KIT



Set of 2 Outer Air Elements

Notes: Contains 2 elements that stack.
Use With: PA4611
Replaces: Komatsu 66758-17021 and 66758-17231; Fleetguard AF25088 and AF25048
Each Element
O.D.: 9 21/32 (245.3)
I.D.: 5 7/32 (132.6)
Height: 8 27/32 (224.6)
A. Gskt: [2] Attached to Element

PA4604-FN



Air Element with Fins

Replaces: Nelson 70757H; Fleetguard AF25543K
O.D.: 4 3/32 (104.0)
Fins: 5 1/16 (128.6)
I.D.: 2 1/32 (16.7) & 2 15/32 (62.7)
Height: 10 3/8 (263.5)
A. Gskt: [1] Attached
F. Gskt: [1] Included

PA4611



Inner Air Element

Fits Inside: PA4610 KIT
Replaces: Komatsu 67758-17031; Fleetguard AF25049
O.D.: 5 1/16 (128.6)
I.D.: 13/32 (10.3) & 3 13/16 (96.8)
Height: 16 15/16 (430.2)
A. Gskt: [1] Attached
F. Gskt: [1] Included

PA4605



Air Element

Replaces: Fleetguard AF25409M
O.D.: 13 13/16 (350.8)
I.D.: 15/16 (23.8) & 9 1/2 (241.3)
Height: 12 21/32 (321.5)
A. Gskt: [2] Attached
F. Gskt: [1] Included

PA4612



Cab Air Element with Pull Tabs

Fits: DAF XF Trucks
Replaces: DAF 1322255; Fleetguard AF25840
Length: 12 21/32 (321.5)
Width: 9 1/4 (235.0)
Height: 15/16 (23.8)
A. Gskt: [1] Attached

PA4606



Air Element with Bail Handle

Replaces: Ingersoll-Rand 39333372
O.D.: 13 13/16 (350.8)
Boot Gasket: 14 1/2 (368.3)
I.D.: 15/16 (23.8) & 9 1/2 (241.3)
Height: 27 5/16 (693.7)
A. Gskt: [2] Attached
F. Gskt: [1] Included

RS4613



Radial Seal Air Element

Notes: Inside-Out Flow Direction
Contains: 4 5/8 Inch Dust Ejector Hole
Replaces: Mack 57MD318
O.D.: 12 3/32 (332.6)
I.D.: 7 3/8 (187.3) One End
Height: 21 11/16 (550.9)
F. Gskt: [1] Included

PA4607



Inner Air Element

Fits Inside: PA4626
Fits: Nissan Trucks
Replaces: Nissan 16546-97002
O.D.: 6 1/16 (154.0)
I.D.: 2 1/32 (16.7) & 4 3/4 (120.7)
Height: 15 29/32 (404.0)
A. Gskt: [1] Attached

PA4614



Outer Air Element

Fits: J.C. Bamford Loaders
Use With: PA3819
Replaces: J.C. Bamford 32/909101
O.D.: 6 1/4 (158.8)
Flange: 6 7/8 (174.6)
I.D.: 19/32 (15.1) & 2 25/32 (70.6)
Height: 8 1/2 (215.9)
A. Gskt: [1] Attached
F. Gskt: [1] Included, [1] Wing Nut

PA4608



Air Element

Fits: Toyota Vans
Replaces: Toyota 17801-64030
O.D.: 5 3/16 (131.8)
I.D.: 15/32 (11.9) & 2 17/32 (64.3)
Height: 11 1/32 (280.2)
F. Gskt: [1] Included

PA4615



Air Element

Replaces: Toyota 23301-30205-71
O.D.: 7 11/16 (195.3)
I.D.: 3 5/16 (84.1)
Height: 5 11/16 (144.5)

Measurements Are Shown In Inches And (Millimeters)

WARNING: These products can expose you to chemicals, including Diisononyl Phthalate, Carbon black extracts, Nickel, 1,3 Butadiene, Ethylene Oxide, Epichlorohydrin, which are known to the State of California to cause cancer, and Bisphenol, Ethylene Glycol, Ethylene Oxide, 1,3 Butadiene, Epichlorohydrin, which are known to the State of California to cause birth defects or other reproductive harm. For more information go to www.P65Warnings.ca.gov.

RS4616



Radial Seal Outer Air Element
Fits: Terex Dump Trucks
Use With: RS4617
Replaces: Terex 15273424
O.D.: 14 7/32 (361.2)
I.D.: 8 15/16 (227.0) One End
Height: 20 1/2 (520.7)

RS4622



Radial Seal Outer Air Element
Fits: John Deere Tractors
Use With: RS4623
Replaces: John Deere RE164839
O.D.: 12 31/32 (329.4)
I.D.: 6 13/16 (173.0) One End
Height: 11 11/16 (296.9)

RS4617



Radial Seal Inner Air Element
Fits Inside: RS4616
Fits: Terex Dump Trucks
Replaces: Terex 15243425
O.D.: 9 3/32 (231.0)
I.D.: 6 29/32 (175.4) One End
Height: 20 11/32 (516.7)

RS4623



Radial Seal Inner Air Element
Fits Inside: RS4622
Fits: John Deere Tractors
Replaces: John Deere RE172447
O.D.: 6 7/8 (174.6)
I.D.: 5 5/16 (134.9) One End
Height: 10 7/8 (276.2)

RS4618



Radial Seal Air Element
Notes: Inside-Out Flow Direction
Contains: Drainage hole in bottom.
Fits: Mack Trucks
Replaces: Mack 57MD317
O.D.: 11 3/8 (288.9)
I.D.: 5 13/16 (147.6) One End
Height: 20 13/32 (543.7)
F. Gskt: G501-AF

PA4624



Outer Air Element
Fits: Kobelco Excavators
Use With: PA4625
Replaces: Kobelco LQ11PU0001S002
O.D.: 9 7/32 (234.2)
I.D.: 21/32 (16.7) & 5 27/32 (148.4)
Height: 14 3/4 (374.7)
A. Gskt: [1] Attached
F. Gskt: [1] Included

PA4619



Replacement for Ecolite Air Element in Disposable Housing
Fits: Onan Generators
Replaces: Donaldson C055003;
 Onan 1402680
O.D.: 5 1/2 (139.7)
I.D.: 1 3/4 (44.5) One End
Height: 5 3/8 (136.5)

PA4625



Inner Air Element
Fits Inside: PA4624
Fits: Kobelco Excavators
Replaces: Kobelco LQ11PU0001S001
O.D.: 5 9/16 (141.3)
I.D.: 21/32 (16.7) & 4 7/16 (112.7)
Height: 12 29/32 (327.8)
A. Gskt: [1] Attached
F. Gskt: G103-N

RS4620



Radial Seal Outer Air Element
Fits: John Deere, Volvo Equipment
Use With: RS4621
Replaces: Volvo 11110175;
 Donaldson P778905
O.D.: 9 9/32 (131.0)
I.D.: 5 5/32 (131.0) One End
Height: 18 19/32 (472.3)

PA4626



Outer Air Element
Fits: Nissan Trucks
Use With: PA4607
Replaces: Nissan 16546-97001
O.D.: 8 7/8 (225.4)
I.D.: 21/32 (16.7) & 6 1/4 (158.8)
Height: 16 15/16 (430.2)
A. Gskt: [1] Attached
F. Gskt: [1] Included

RS4621



Radial Seal Inner Air Element
Fits Inside: RS4620
Fits: John Deere, Volvo Equipment
Replaces: Volvo 11110176
O.D.: 5 1/4 (133.4)
I.D.: 3 3/4 (95.3) One End
Height: 17 7/8 (454.0)

PA4627



Inner Air Element
Fits Inside: PA2797
Replaces: Volvo V1114450;
 Donaldson P521692
O.D.: 8 1/4 (209.6)
I.D.: 21/32 (16.7) & 7 3/32 (180.2)
Height: 13 3/8 (339.7)
A. Gskt: [1] Attached
F. Gskt: [1] Included

Measurements Are Shown In Inches And (Millimeters)

 **WARNING:** These products can expose you to chemicals, including Diisononyl Phthalate, Carbon black extracts, Nickel, 1,3 Butadiene, Ethylene Oxide, Epichlorohydrin, which are known to the State of California to cause cancer, and Bisphenol, Ethylene Glycol, Ethylene Oxide, 1,3 Butadiene, Epichlorohydrin, which are known to the State of California to cause birth defects or other reproductive harm. For more information go to www.P65Warnings.ca.gov.

PA4628



Inner Air Element

Fits Inside: PA4656
Fits: Case Tractors
Replaces: Case A171254
O.D.: 4 3/32 (104.0)
 Flange 4 27/32 (123.0)
I.D.: 21/32 (16.7) & 3 5/8 (92.1)
Height: 13 19/32 (345.3)
A. Gskt: [1] Attached
F. Gskt: [1] Metal Washer

RS4634



Radial Seal Air Element

Notes: Features recessed closed end.
Fits: Mack Trucks
Replaces: Mack 57MD48M, 57MD320M;
 Donaldson EAF5114
O.D.: 9 9/32 (235.7)
I.D.: 5 25/32 (146.8) One End
Height: 25 1/2 (647.7)
Related To: RS4634XP (Extreme Performance
 Nano Version)

RS4629



Radial Seal Inner Air Element

Fits Inside: RS4989
Fits: John Deere Dump Trucks;
 New Holland Equipment
Replaces: John Deere TT221378;
 Donaldson P781102
O.D.: 9 3/32 (231.0)
I.D.: 7 (177.8) One End
Height: 24 5/8 (625.5)

RS4634XP



Extreme Performance Nano Air Element

Notes: Features recessed closed end.
Fits: Mack Trucks
Replaces: Donaldson DBA5114
O.D.: 9 9/32 (235.7)
I.D.: 5 25/32 (146.8) One End
Height: 25 1/2 (647.7)
Related To: RS4634 (Standard Version)

PA4630



Replacement for Ecolite Air Element in Disposable Housing

Fits: Motor Homes with Cummins Engine
Replaces: Farr 99842-009;
 Donaldson P537455
O.D.: 13 1/2 (342.9)
Inlet: 7
Outlet: 7 1/16
Height: 16 27/32 (427.8)

PA4635



Cab Air Element

Fits: John Deere Dozers, Motor Graders
Replaces: John Deere AT170037;
 Fleetguard AF25786
Length: 14 3/4 (374.7)
Width: 6 7/8 (174.6)
Height: 2 7/16 (61.9)
A. Gskt: [1] Attached

PA4631-FN



Air Element with Fins

Fits: Komatsu Equipment
Replaces: Komatsu 8481-01-155
O.D.: 6 3/32 (154.8)
 Fins 7 3/4 (196.9)
I.D.: 3/4 (19.1) & 3 15/32 (88.1)
Height: 15 9/16 (395.3)
A. Gskt: [1] Attached

RS4636



Radial Seal Outer Air Element

Fits: International Buses, Trucks
Use With: RS4637
Replaces: International 3532799-C1
O.D.: 10 1/4 (260.4)
I.D.: 7 15/16 (201.6) One End
Height: 15 29/32 (404.0)

PA4632



Outer Air Element

Contains: Grease packet
Fits: Kubota Excavators, Tractors
Use With: PA4633
Replaces: Kubota 6A10082630, 6A10082632
O.D.: 3 17/32 (89.7)
I.D.: 1 25/32 (45.2) One End
Height: 6 15/16 (176.2)

RS4637



Conical-Shaped Radial Seal Inner Air Element

Fits Inside: RS4636
Fits: International Buses, Trucks
Replaces: International 3532800-C1;
 Fleetguard AF25732
O.D.: 3 1/2 (88.9) to 8 1/32 (204.0)
I.D.: 5 1/32 (127.8) One End
Height: 15 11/32 (389.7)

PA4633



Inner Air Element

Fits Inside: PA4632, RS5273
Fits: Kubota Excavators, Tractors
Replaces: Kubota 32721-58242
O.D.: 1 21/32 (42.1)
I.D.: 1 7/32 (31.0) One End
Height: 6 7/16 (163.5)
I.Gskt: [1] Included

RS4638



Radial Seal Outer Air Element

Fits: Komatsu Equipment; Scania Trucks
Use With: RS3871, RS4639
Replaces: Caterpillar 1421340; Komatsu
 600-185-6110; Donaldson P777868;
 Fleetguard AF25627
O.D.: 12 9/32 (311.9)
I.D.: 6 31/32 (177.0) One End
Height: 20 9/16 (522.3)
Related To: RS3870 (with Blank Band)

Measurements Are Shown In Inches And (Millimeters)

WARNING: These products can expose you to chemicals, including Diisononyl Phthalate, Carbon black extracts, Nickel, 1,3 Butadiene, Ethylene Oxide, Epichlorohydrin, which are known to the State of California to cause cancer, and Bisphenol, Ethylene Glycol, Ethylene Oxide, 1,3 Butadiene, Epichlorohydrin, which are known to the State of California to cause birth defects or other reproductive harm. For more information go to www.P65Warnings.ca.gov.

RS4639 Radial Seal Inner Air Element
Contains: Flame Retardant Media
Fits Inside: RS3870, RS4638
Fits: Caterpillar Equipment
Replaces: Caterpillar 142-1403
O.D.: 7 1/16 (179.4)
I.D.: 5 11/16 (144.5) One End
Height: 19 31/32 (507.2)
Related To: RS3871 (without Flame Retardant Media)



PA4645-FN Air Element with Fins
Fits: Komatsu Excavators
Use With: PA4658
Replaces: Yanmar 129436-12900
O.D.: 4 1/8 (104.8)
 Fins 5 1/8 (130.2)
I.D.: 21/32 (16.7) & 2 1/2 (63.5)
Height: 10 3/4 (273.1)
A. Gskt: [1] Attached
F. Gskt: [1] Steel Washer



PA4640-FN Air Element with Lid and Fins
Fits: Caterpillar Excavators
Replaces: Caterpillar 6I6434
O.D.: 6 3/32 (154.8)
 Lid 8 21/32 (219.9)
I.D.: 21/32 (16.7) & 3 15/32 (88.1)
Height: 12 1/2 (317.5)
A. Gskt: [1] Attached
F. Gskt: [1] Metal Washer



RS4646 Radial Seal Air Element
Fits: Freightliner Trucks
Replaces: Donaldson P537355
O.D.: 9 21/32 (245.3)
I.D.: 3 3/32 (78.6) & 5 5/32 (131.0)
Height: 24 27/32 (631.0)
F. Gskt: [1] Included



PA4641 Air Element
Replaces: Toyota 17801-67070
O.D.: 9 15/32 (240.5)
I.D.: 4 11/32 (110.3)
Height: 4 3/4 (120.7)



PA4647 Air Element
Replaces: Toyota 17801-58010
O.D.: 7 3/4 (196.9)
I.D.: 3 1/4 (82.6)
Height: 5 3/4 (146.1)



RS4642 Radial Seal Outer Air Element
Fits: Volvo Trucks
Use With: RS4643
Replaces: Volvo 20411815;
 Donaldson P605551
O.D.: 13 (330.2)
I.D.: 9 1/8 (231.8) One End
Height: 19 1/2 (495.3)



PA4648 Air Element
Replaces: Toyota 17801-67060;
 Fleetguard AF25584M
O.D.: 8 5/8 (219.1)
I.D.: 4 9/32 (108.7) One End
Height: 5 11/16 (144.5)



RS4643 Radial Seal Inner Air Element
Fits Inside: RS4642
Fits: Volvo Trucks
Replaces: Volvo 20411816;
 Donaldson P605552
O.D.: 8 17/32 (216.7)
I.D.: 7 11/16 (195.3) One End
Height: 18 1/2 (469.9)



PA4649 Air Element
Replaces: Toyota 17801-54180
O.D.: 8 5/8 (219.1)
I.D.: 4 5/16 (109.5)
Height: 4 13/16 (122.2)



PA4644 Cab Air Element
Fits: John Deere Tractors
Replaces: John Deere RE67829
O.D.: 6 7/8 (174.6)
I.D.: 21/32 (16.7) & 3 1/2 (88.9)
Height: 12 13/32 (315.1)
A. Gskt: [1] Attached
F. Gskt: G103-N



PA4650-FN Outer Air Element with Fins
Fits: Samsung Excavators
Use With: PA1912
Replaces: Volvo 991240700
O.D.: 7 15/16 (201.6)
 Fins 10 (254.0)
I.D.: 11/16 (17.5) & 5 3/8 (136.5)
Height: 16 1/2 (419.1)
A. Gskt: [1] Attached
F. Gskt: [1] Metal Washer



Measurements Are Shown In Inches And (Millimeters)

 **WARNING:** These products can expose you to chemicals, including Diisononyl Phthalate, Carbon black extracts, Nickel, 1,3 Butadiene, Ethylene Oxide, Epichlorohydrin, which are known to the State of California to cause cancer, and Bisphenol, Ethylene Glycol, Ethylene Oxide, 1,3 Butadiene, Epichlorohydrin, which are known to the State of California to cause birth defects or other reproductive harm. For more information go to www.P65Warnings.ca.gov.

PA4651 Outer Air Element
Fits: Kubota Tractors
Replaces: Kubota 32751-96260
O.D.: 4 3/32 (104.0)
 Flange 5 3/4 (146.1)
I.D.: 19/32 (15.1) & 2 1/2 (63.5)
Height: 10 3/8 (263.5)
A. Gskt: [2] Attached



PA4657 Replacement for Ecolite Air Element in Disposable Housing
Fits: Pierce Fire Trucks
Replaces: Farr 99842-005
O.D.: 13 1/2 (342.9)
Inlet: 7
Outlet: 7
Height: 25 19/32 (650.1)



PA4652 Panel Air Element
Fits: Caterpillar Equipment
Replaces: Caterpillar 6C9226; Donaldson P777576; Fleetguard AF25713
Length: 11 13/16 (300.0)
Width: 9 13/16 (249.2)
Height: 1 1/16 (27.0)

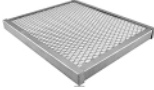

PA4658 Inner Air Element
Fits Inside: PA4645-FN
Fits: Komatsu Excavators
Replaces: Yanmar 129436-12910
O.D.: 2 9/16 (65.1)
I.D.: 11/16 (17.5) & 2 1/16 (52.4)
Height: 9 3/32 (231.0)



PA4653 Replacement for Ecolite Air Filter in Disposable Housing
Replaces: Farr 400820-014
O.D.: 11 1/32 (280.2)
Inlet: 7
Outlet: 7
Height: 19 13/16 (503.2)



PA4659 Cab Air Element
Notes: Uses 2 filters per application.
Fits: Caterpillar Loaders, Telehandlers
Replaces: Caterpillar 116-7376; Donaldson P609445
Length: 12 1/2 (317.5)
Width: 7 1/16 (179.4)
Height: 1 7/16 (36.5)

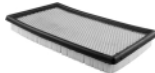

PA4654 KIT Set of 2 Cab Air Elements
Notes: Uses 2 filters per application.
Fits: Case Tractors
Replaces: Case 240883A1, 303748A1
Each Filter:
Length: 14 1/8 (358.8)
Width: 7 1/8 (181.0)
Height: 2 9/16 (65.1)
A. Gskt: [1] Attached to Each Filter



PA4660 Air Element
Replaces: Donaldson P527566
O.D.: 13 7/8 (352.4)
I.D.: 9 1/2 (241.3) One End
Height: 13 1/2 (342.9)
A. Gskt: [1] Attached
F. Gskt: [1] Included



PA4655 Replacement for Ecolite Air Filter in Disposable Housing
Fits: Freightliner Buses, Trucks
Replaces: Farr 114880-005 Series; Fleetguard AH19057
O.D.: 8 3/32 (205.6)
Inlet: 4
Outlet: 6
Height: 17 3/16 (436.6)



PA4661 Wire Supported Cotton Polyester Industrial Air Element
Fits: Industrial Applications
Replaces: Airguard DP40-203; Farr 49880-002
Length: 19 1/2 (495.3)
Width: 19 1/2 (495.3)
Height: 1 3/4 (44.5)

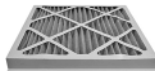

PA4656 Air Element with Lift Bar
Fits: Case Tractors
Use With: PA4628
Replaces: Case A171253
O.D.: 7 15/16 (201.6)
I.D.: 21/32 (16.7) & 4 5/8 (117.5)
Height: 15 1/2 (393.7)
A. Gskt: [1] Attached
F. Gskt: [1] Included



PA4662 Wire Supported Cotton Polyester Industrial Air Element
Fits: Industrial Applications
Replaces: Airguard DP40-202; Farr 49880-004
Length: 24 1/2 (622.3)
Width: 15 1/2 (393.7)
Height: 1 3/4 (44.5)

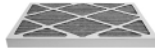

PA4663 Wire Supported Cotton Polyester Industrial Air Element
Fits: Industrial Applications
Replaces: Airguard DP40-210; Farr 49880-006
Length: 23 3/8 (593.7)
Width: 11 3/8 (288.9)
Height: 1 3/4 (44.5)



Measurements Are Shown In Inches And (Millimeters)

 **WARNING:** These products can expose you to chemicals, including Diisononyl Phthalate, Carbon black extracts, Nickel, 1,3 Butadiene, Ethylene Oxide, Epichlorohydrin, which are known to the State of California to cause cancer, and Bisphenol, Ethylene Glycol, Ethylene Oxide, 1,3 Butadiene, Epichlorohydrin, which are known to the State of California to cause birth defects or other reproductive harm. For more information go to www.P65Warnings.ca.gov.

PA4664

Wire Supported Cotton Polyester Industrial Air Element

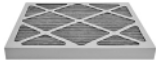

Fits: Industrial Applications
Replaces: Airguard DP40-201;
 Farr 49880-001
Length: 19 1/2 (495.3)
Width: 15 1/2 (393.7)
Height: 1 3/4 (44.5)

PA4665-FN

Outer Air Element with Fins



Fits: Kubota Excavators, Tractors
Use With: PA4666
Replaces: Kubota 6C040-94240
O.D.: 3 5/16 (84.1)
 Fins 4 1/4 (108.0)
I.D.: 2 1/32 (16.7) & 2 1/8 (54.0)
Height: 7 5/32 (181.8)
A. Gskt: [1] Attached
F. Gskt: [1] Included

PA4666

Inner Air Element



Fits Inside: PA4665-FN
Fits: Kubota Excavators, Tractors
Replaces: Kubota 6C040-94350;
 Fleetguard AF25702
O.D.: 2 5/32 (54.8)
I.D.: 5/8 (15.9) & 1 17/32 (38.9)
Height: 6 1/4 (158.8)

PA4668

Industrial Panel Air Element

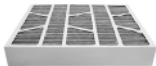

Fits: Industrial Applications
Replaces: Airguard DP40-411;
 Farr 59413-008; Fleetguard AF4987
Length: 23 3/8 (593.7)
Width: 10 3/8 (263.5)
Height: 3 3/4 (95.3)

PA4669

Industrial Panel Air Element

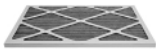

Fits: Industrial Applications
Replaces: Airguard DP40-102;
 Farr 119303-004; Fleetguard AF25233
Length: 24 1/2 (622.3)
Width: 15 1/2 (393.7)
Height: 3/4 (19.1)

RS4672

Radial Seal Outer Air Element



Fits: Chevrolet, GMC, Isuzu Trucks
Use With: RS4673
Replaces: GMC 88937525;
 ACDelco A2031C
O.D.: 7 7/8 (200.0)
I.D.: 4 3/4 (120.7) One End
Height: 18 1/2 (469.9)

RS4673

Radial Seal Inner Air Element



Fits Inside: RS4672
Fits: Chevrolet, GMC, Isuzu Trucks
Replaces: GMC 88937548;
 ACDelco A2035C
O.D.: 4 7/16 (112.7)
I.D.: 3 5/16 (84.1) One End
Height: 17 23/32 (450.1)

PA4674-FN

Air Element with Lid and Fins



Replaces: Toyota 17807-23800-71
O.D.: 5 5/16 (134.9)
 Lid 7 13/16 (198.4)
I.D.: 15/32 (11.9) & 3 5/16 (84.1)
Height: 11 17/32 (292.9)
A. Gskt: [2] Attached

RS4676

Radial Seal Outer Air Element



Fits: John Deere Dozers, Loaders
Use With: RS4677
Replaces: John Deere AT225338;
 Donaldson P600072
O.D.: 9 9/32 (235.7)
I.D.: 5 5/32 (131.0) One End
Height: 17 (431.8)

RS4677

Radial Seal Inner Air Element



Fits Inside: RS4676
Fits: John Deere Dozers, Loaders
Replaces: John Deere AT225339;
 Donaldson P600076
O.D.: 5 1/4 (133.4)
I.D.: 3 3/4 (95.3) One End
Height: 16 13/32 (416.7)

RS4678

Radial Seal Outer Air Element



Fits: Manitou Equipment
Use With: RS4679
Replaces: Manitou 563416;
 Fleetguard AF25795
O.D.: 6 1/2 (165.1)
I.D.: 3 9/16 (90.5) One End
Height: 13 7/16 (341.3)

RS4679

Radial Seal Inner Air Element



Fits Inside: RS4678, RS5641
Fits: Manitou Equipment
Replaces: Manitou 563415;
 Fleetguard AF25794
O.D.: 3 21/32 (92.9)
I.D.: 2 7/8 (73.0) One End
Height: 13 1/8 (333.4)

RS4680

Radial Seal Air Element



Fits: Lister Petter Engines
Replaces: Lister 624-50610;
 Woodgate WGA1652
O.D.: 5 23/32 (145.3)
I.D.: 3 (76.2) One End
Height: 12 5/8 (320.7)

Measurements Are Shown In Inches And (Millimeters)



WARNING: These products can expose you to chemicals, including Diisononyl Phthalate, Carbon black extracts, Nickel, 1,3 Butadiene, Ethylene Oxide, Epichlorohydrin, which are known to the State of California to cause cancer, and Bisphenol, Ethylene Glycol, Ethylene Oxide, 1,3 Butadiene, Epichlorohydrin, which are known to the State of California to cause birth defects or other reproductive harm. For more information go to www.P65Warnings.ca.gov.

PA4681 Cab Air Element
Fits: Volvo Trucks
Replaces: Volvo 20435801; Donaldson P606555
Length: 12 3/4 (323.9)
Width: 11 9/16 (293.7)
Height: 1 1/8 (28.6)



PA4682 Cab Air Element
Fits: Volvo Trucks
Replaces: Volvo 3948712
Length: 13 7/16 (341.3)
Width: 8 3/8 (212.7)
Height: 25/32 (19.8)



PA4683 Outer Air Element with Lift Bar
Fits: New Holland Tractors
Use With: PA3492
Replaces: New Holland 82011402, 82027153
O.D.: 7 3/16 (182.6)
 Flange 8 21/32 (219.9)
I.D.: 15/32 (11.9) & 3 27/32 (97.6)
Height: 13 13/32 (340.5)
A. Gskt: [2] Attached



PA4688 Oblong Air Element
Fits: Partner K650 Saws
Use With: PA4688 FOAM
Replaces: Partner 506224201; Woodgate WGA1546
O.D.: 3 3/8 (85.7) to 4 11/16 (119.1)
I.D.: 1 5/8 (41.3) & 2 29/32 (73.8)
Height: 2 1/8 (54.0)



PA4688 FOAM Foam Blanket for PA4688
Use With: PA4688
O.D.: 8 (203.2)
I.D.: 5 5/16 (134.9)
Height: 21/32 (16.7)



PA4689 Oblong Air Element
Replaces: Woodgate WGA1638
O.D.: 3 11/16 (93.7) to 5 25/32 (146.8)
I.D.: 2 3/32 (53.2) & 4 5/32 (105.6)
Height: 3 7/32 (81.8)



PA4692 Inner Air Element
Fits Inside: PA3852-FN
Replaces: Woodgate WGA1147S
O.D.: 3 13/32 (86.5)
 Flange 4 5/32 (105.6)
I.D.: 11/16 (17.5) & 2 5/16 (58.7)
Height: 12 (304.8)
A. Gskt: [1] Attached



PA4693 Air Element
Fits: Volkswagen Eurovan
Replaces: Volkswagen 44129620; Woodgate WGA1148
O.D.: 6 3/8 (161.9)
I.D.: 3 11/16 (93.7)
Height: 9 11/32 (237.3)



PA4694 Air Element with Foam Wrap
Fits: Honda Engines
Replaces: Honda 17210-ZG3-003, 17210-ZG3-505, 17210-ZG3-801; Woodgate WGA1157
O.D.: 4 13/16 (122.2)
I.D.: 1/4 (6.4) & 2 5/16 (58.7)
Height: 2 11/16 (68.3)
A. Gskt: [1] Attached
Grommets: [1] Attached



PA4695 Oblong Air Element with Foam Wrap
Fits: Honda Engines
Replaces: Honda 17210-ZE8-003, 17210-ZE8-013; Woodgate WGA1159
O.D.: 3 1/8 (79.4) to 5 3/32 (129.4)
I.D.: 1 3/32 (27.8) & 3 9/16 (90.5)
Height: 3 1/8 (79.4)
Grommets: [1] Attached



PA4696 FOAM Foam Blanket
Width: 3 3/16 (81.0)
Height: 7/32 (5.6)



PA4697-FN Outer Air Element with Fins
Fits: Manitou Telehandlers; New Holland Equipment
Use With: PA2419
Replaces: New Holland 85807057; Woodgate WGA1176K
O.D.: 6 1/16 (154.0)
 Fins 7 17/32 (191.3)
I.D.: 21/32 (16.7) & 3 7/16 (87.3)
Height: 15 3/32 (383.4)
A. Gskt: [1] Attached
F. Gskt: [1] Included



PA4698 Oblong Air Element with Foam Wrap
Fits: Honda Engines
Replaces: Honda 17210-ZE7-003, 17210-ZE7-013; Woodgate WGA1177
O.D.: 2 1/2 (63.5) to 7 17/32 (191.3)
I.D.: 1 1/16 (27.0) & 6 1/32 (153.2)
Height: 1 15/16 (49.2)
A. Gskt: [1] Attached
Grommets: [2] Attached



Measurements Are Shown In Inches And (Millimeters)

 **WARNING:** These products can expose you to chemicals, including Diisononyl Phthalate, Carbon black extracts, Nickel, 1,3 Butadiene, Ethylene Oxide, Epichlorohydrin, which are known to the State of California to cause cancer, and Bisphenol, Ethylene Glycol, Ethylene Oxide, 1,3 Butadiene, Epichlorohydrin, which are known to the State of California to cause birth defects or other reproductive harm. For more information go to www.P65Warnings.ca.gov.

CA4700



Channel Flow Air Element
Fits: Freightliner Buses, Trucks
Use With: PA4701
Replaces: Donaldson P548070, P607955; Fleetguard AF26154
O.D.: 9 29/32 (251.6)
 Flange 12 25/32 (324.6)
Height: 8 1/32 (204.0)
A. Gskt: [1] Attached
Related To: CA5420 (Flame Retardant Media Version)

PA4701



Channel Flow Air Secondary Element
Fits: Freightliner Buses, Trucks
Use With: CA4700
Replaces: Donaldson P544432, P616400; Fleetguard AF26153
O.D.: 9 13/32 (238.9)
Height: 31/32 (24.6)
A. Gskt: [1] Attached

CA4702



Channel Flow Air Element
Fits: John Deere Tractors
Use With: PA4704
Replaces: John Deere AL119839, AL172780; Donaldson P606119; Fleetguard AF26157; SF-Filter SL82001; Wix 46937
O.D.: 4 7/8 (123.8) to 12 7/32 (320.4)
Height: 7 11/32 (186.5)
A. Gskt: [1] Included

CA4703



Channel Flow Air Element
Fits: John Deere Sprayers, Tractors
Use With: PA4704
Replaces: John Deere AL150285, AL172781; Donaldson P606120; Fleetguard AF26156
O.D.: 4 7/8 (123.8) to 12 7/32 (310.4)
Height: 11 3/16 (284.2)
A. Gskt: [1] Included

PA4704



Channel Flow Air Secondary Element
Notes: Sometimes used with CA5278, Channel Flow Air Element.
Fits: John Deere Tractors
Use With: CA4702, CA4703
Replaces: John Deere AL150288; Donaldson P606121; Fleetguard AF26155; Wix 42795
O.D.: 4 9/32 (108.7) to 11 25/32 (299.2)
Height: 1 13/16 (46.0)
A. Gskt: [1] Included

PA4705



Air Element
Replaces: M.A.N. 45.0095.3105; Woodgate WGA1282
O.D.: 2 17/32 (64.3)
I.D.: 1 1/2 (38.1) One End
Height: 2 23/32 (69.1)
F. Gskt: [1] Included

PA4706



Air Element
Replaces: Mann & Hummel C1337; Woodgate WGA1286
O.D.: 5 (127.0)
I.D.: 2 17/32 (64.3)
Height: 4 15/16 (125.4)
Grommets: [2] Included

PA4707



Air Element
Replaces: M.A.N. 45.07554.166; Woodgate WGA1287
O.D.: 9 1/2 (241.3)
I.D.: 6 11/32 (161.1)
Height: 3 15/32 (88.1)

PA4708



Air Element
Replaces: M.A.N. 45.02155.104; Woodgate WGA1288
O.D.: 3 7/8 (98.4)
I.D.: 2 3/8 (60.3) One End
Height: 2 29/32 (73.8)
A. Gskt: [1] Attached

PA4709



Outer Air Element
Use With: PA2419
Replaces: J.C. Bamford 32/914700; Woodgate WGA1307
O.D.: 7 5/8 (193.7)
 Flange 8 3/16 (208.0)
I.D.: 19/32 (15.1) & 3 11/16 (93.7)
Height: 15 21/32 (397.7)
A. Gskt: [1] Attached; [1] Wing Nut

PA4711



Air Element
Replaces: Hydrovane 52438; Woodgate WGA1318
O.D.: 13 23/32 (348.5)
I.D.: 11 5/8 (295.3)
Height: 4 3/16 (106.4)

PA4713



Air Element
Replaces: Ceccato 640110; Woodgate WGA1339
O.D.: 6 5/16 (160.3)
I.D.: 4 1/2 (114.3)
Height: 4 25/32 (121.4)

PA4714



Panel Air Element
Replaces: Leyland ABU8516; Fleetguard AF4049; Woodgate WGA135
Length: 12 3/4 (323.9)
Width: 4 7/8 (123.8)
Height: 1 7/32 (31.0)

PA4715



Air Element
Replaces: Becker 84040910; Woodgate WGA1354
O.D.: 5 29/32 (150.0)
I.D.: 3 15/32 (88.1)
Height: 4 31/32 (126.2)

Measurements Are Shown In Inches And (Millimeters)



WARNING: These products can expose you to chemicals, including Diisononyl Phthalate, Carbon black extracts, Nickel, 1,3 Butadiene, Ethylene Oxide, Epichlorohydrin, which are known to the State of California to cause cancer, and Bisphenol, Ethylene Glycol, Ethylene Oxide, 1,3 Butadiene, Epichlorohydrin, which are known to the State of California to cause birth defects or other reproductive harm. For more information go to www.P65Warnings.ca.gov.

PA4716 Air Element
Replaces: Busch 532013; Woodgate WGA1392
O.D.: 5 (127.0)
I.D.: 2 17/32 (64.3)
Height: 6 3/32 (154.8)
F. Gskt: [2] Included



PA4732 Air Element
Replaces: Petter 334643; Woodgate WGA1574
O.D.: 3 13/16 (96.8)
I.D.: 1 31/32 (50.0)
Height: 4 3/16 (106.4)



PA4720 Air Element with Attached Spring
Replaces: Rietschle 731143; Woodgate WGA1412
O.D.: 2 17/32 (64.3)
I.D.: 1 1/2 (38.1)
Height: 7 27/32 (199.2)
A. Gskt: [1] Attached
Spring: [1] Attached



PA4733 Air Element with Foam Wrap
Fits: Lombardini 15LD315 Engine
Replaces: Lombardini 196.2175.120; Woodgate WGA1575
O.D.: 4 11/32 (110.3)
I.D.: 5/8 (7.9) & 2 7/16 (61.9)
Height: 2 15/16 (74.6)
A. Gskt: [1] Attached
Grommets: [1] Attached



PA4723 Panel Air Element
Fits: Mercedes-Benz European Vans
Replaces: Mercedes-Benz 6380900151; Fleetguard AF25719; Woodgate WGA1548
Length: 12 15/16 (328.6)
Width: 10 7/16 (265.1)
Height: 2 23/32 (69.1)



PA4734 Panel Air Element with Foam Pad
Replaces: Kubota 12812-11210; Woodgate WGA1576
Length: 4 9/32 (108.7)
Width: 3 29/32 (99.2)
Height: 1 3/8 (34.9)
O-Ring: [1] Included



PA4727 Air Element with Foam Wrap
Fits: Robin Engines
Replaces: Robin 1573620101; Woodgate WGA1565
O.D.: 3 17/32 (89.7)
I.D.: 2 7/16 (61.9)
Height: 2 3/8 (60.3)
A. Gskt: [2] Attached

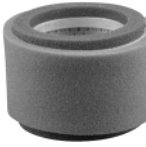

PA4735 Foam Air Filter
Fits: Honda G100, G110 Engines
Replaces: Honda 17211-896-000; Woodgate WGA1578
Length: 3 7/8 (98.4)
Width: 3 3/32 (78.6)
Height: 15/16 (23.8)



PA4729 Oval Air Element in Disposable Housing
Contains: [2] Bolt Holes in Housing
Replaces: Wacker 78842; Woodgate WGA1567
O.D.: 6 13/16 (173.0) to 10 11/16 (271.5)
I.D.: 1 31/32 (50.0) One End
Height: 1 11/16 (42.9)
Grommets: [1] Attached



PA4736 FOAM Foam Blanket
Fits: Exmark Lawn & Garden Tractors
O.D.: 6 19/32 (167.5)
I.D.: 6 3/32 (154.8)
Height: 2 5/32 (54.8)



PA4730 Panel Air Element
Fits: Ruggerini Engines
Replaces: Ruggerini 17540; Woodgate WGA1569
Length: 6 9/32 (159.5)
Width: 6 3/16 (157.2)
Height: 1 17/32 (38.9)



PA4737 Air Element with Foam Wrap
Fits: Kubota OC60E, OC95E Engines
Replaces: Kubota 11460-11180; Woodgate WGA1583
O.D.: 4 13/16 (122.2)
 Boot 4 31/32 (126.2)
I.D.: 1/4 (6.4) & 2 5/16 (58.7)
Height: 2 23/32 (69.1)
A. Gskt: [2] Attached



PA4731 Oblong Air Element
Fits: Wacker Equipment
Replaces: Wacker 95711; Woodgate WGA1570
O.D.: 2 3/4 (69.9) to 4 25/32 (121.4)
I.D.: 1 29/32 (48.4) & 3 15/16 (100.0)
Height: 1 7/32 (31.0)



PA4738 Foam Oblong Air Element
Fits: Robin EC08, EY08, EY15D Engines
Replaces: Robin 2273600203; Woodgate WGA1593
Width: 3 9/32 (83.3)
Height: 1 1/4 (31.8)



PA4740 Inner Air Element
Fits Inside: PA1690-FN
Replaces: Petter 397080; Woodgate WGA15S
O.D.: 2 13/32 (61.1)
 Flange 2 3/4 (69.9)
I.D.: 21/32 (16.7) & 2 (50.8)
Height: 9 1/32 (229.4)
A. Gskt: [2] Attached



Measurements Are Shown In Inches And (Millimeters)

WARNING: These products can expose you to chemicals, including Diisononyl Phthalate, Carbon black extracts, Nickel, 1,3 Butadiene, Ethylene Oxide, Epichlorohydrin, which are known to the State of California to cause cancer, and Bisphenol, Ethylene Glycol, Ethylene Oxide, 1,3 Butadiene, Epichlorohydrin, which are known to the State of California to cause birth defects or other reproductive harm. For more information go to www.P65Warnings.ca.gov.

PA4741

Air Element



Fits: Lister-Petter TR3, TS3 Engines
Replaces: Lister 366-07723; Woodgate WGA1601
O.D.: 5 29/32 (150.0)
I.D.: 3 13/32 (86.5)
Height: 3 5/8 (92.1)

PA4743

Air Element



Replaces: Hydrovane 57713; Woodgate WGA1605
O.D.: 9 23/32 (246.9)
I.D.: 7 5/16 (185.7)
Height: 4 1/16 (103.2)

PA4750

Panel Air Element



Fits: Briggs & Stratton Engines
Replaces: Briggs & Stratton 494511; Woodgate WGA1619
Length: 6 31/32 (177.1)
Width: 3 15/32 (88.1)
Height: 1 9/32 (32.5)

PA4753

Inner Air Element



Fits Inside: PA2360-FN, PA4865-FN
Replaces: Johnson Sweepers 13086; Woodgate WGA162S
O.D.: 2 23/32 (69.1)
Flange 3 17/32 (89.7)
I.D.: 2 1/32 (16.7) & 2 13/32 (61.1)
Height: 13 31/32 (354.8)
F. Gskt: [1] Included

PA4754

Panel Air Element

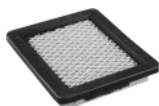

Notes: Can be used with PA4911 Foam Pad.
Fits: Honda Engines
Replaces: Honda 17211-ZL8-A000; Woodgate WGA1635
Length: 5 5/32 (131.0)
Width: 4 1/2 (114.3)
Height: 29/32 (23.0)

PA4755

Oval Air Element



Contains: 7/16 Inch bolt hole on closed end
Fits: Partner K950, K1250 Saws
Replaces: Partner 506231801; Woodgate WGA1639
O.D.: 3 15/16 (100.0) to 6 3/32 (154.8)
I.D.: 2 1/32 (51.6) & 4 1/16 (103.2)
Height: 2 19/32 (65.9)

PA4756

Foam Air Filter



Notes: [2] Small holes and [1] large, irregular hole cut in pad.
Fits: Partner K1200 Saws
Replaces: Partner 506231901; Woodgate WGA1640
Length: 10 13/32 (264.3)
Width: 5 5/8 (142.9)
Height: 11/16 (17.5)

PA4758

Air Element



Fits: Rig Master Auxilliary Power Units
Replaces: Atlas Copco 1613-9001-00; Woodgate WGA1647
O.D.: 3 31/32 (100.8)
I.D.: 2 21/32 (67.5)
Height: 3 1/8 (79.4)
A. Gskt: [2] Attached

PA4760

Oval Air Element with Foam Wrap



Fits: Honda GXV390 Engines
Replaces: Honda 17211-ZF5-001; Woodgate WGA1651
O.D.: 2 15/16 (74.6) to 5 9/32 (74.6)
I.D.: 1 11/32 (8.7) & 3 1/2 (88.9)
Height: 3 7/16 (87.3)

PA4763

Conical-Shaped Air Element with Foam Wrap



Fits: Robin EH25, EY28 Engines
Replaces: Robin 2343260407; Woodgate WGA1672
O.D.: 2 9/16 (65.1) to 4 21/32 (118.3)
I.D.: 2 3/4 (69.9) One End
Height: 3 9/32 (83.3)
A. Gskt: [1] Attached

PA4764

Air Element



Replaces: Petter 340660; Woodgate WGA1674
O.D.: 4 7/32 (107.2)
I.D.: 2 1/32 (51.6)
Height: 4 5/32 (105.6)

PA4766

Air Element



Replaces: Kubota 16616-11013; Woodgate WGA1697
O.D.: 4 3/32 (104.0)
I.D.: 2 1/32 (16.7) & 2 15/32 (62.7)
Height: 10 1/4 (260.4)
A. Gskt: [1] Attached
F. Gskt: [1] Included

PA4769

Oblong Air Element with Foam Wrap



Fits: Toro Lawn & Garden Tractors with Kawasaki Engines
Replaces: Kawasaki 11013-2110; Woodgate WGA1708
O.D.: 2 7/8 (73.0) to 6 5/32 (156.4)
I.D.: 1 13/32 (35.7) & 4 23/32 (119.9)
Height: 3 3/16 (81.0)
A. Gskt: [2] Attached

Measurements Are Shown In Inches And (Millimeters)

WARNING: These products can expose you to chemicals, including Diisononyl Phthalate, Carbon black extracts, Nickel, 1,3 Butadiene, Ethylene Oxide, Epichlorohydrin, which are known to the State of California to cause cancer, and Bisphenol, Ethylene Glycol, Ethylene Oxide, 1,3 Butadiene, Epichlorohydrin, which are known to the State of California to cause birth defects or other reproductive harm. For more information go to www.P65Warnings.ca.gov.

PA4772 Oval Air Element with Foam Wrap
Fits: Honda Engines
Replaces: Honda 17211-ZA0-003; Woodgate WGA1713
O.D.: 5 1/32 (127.8) to 7 3/32 (180.2)
I.D.: 3 1/32 (77.0) & 4 7/8 (123.8)
Height: 2 9/32 (57.9)
A. Gskt: [1] Attached



PA4773 Oval Air Element
Notes: Has 5/16 In. bolt hole on closed end.
Fits: Ford Lawn & Garden Tractors
Replaces: Briggs & Stratton 493909; Woodgate WGA1714
O.D.: 2 7/8 (73.0) to 7 1/4 (184.2)
I.D.: 15/16 (23.8) & 3 29/32 (99.2)
Height: 3 1/32 (77.0)



RS4775 Radial Seal Air Element
Fits: M.A.N. Trucks
Replaces: M.A.N. 81.08304.0087; Fleetguard AF25496; Woodgate WGA1743
O.D.: 9 21/32 (245.3)
I.D.: 4 23/32 (119.9) One End
Height: 15 (381.0)



PA4777 Air Element
Replaces: Tecumseh 23410051; Woodgate WGA1756
O.D.: 1 23/32 (43.7)
I.D.: 7/8 (22.2)
Height: 2 7/8 (73.0)



PA4778 Air Element
Replaces: Woodgate WGA1758
O.D.: 2 29/32 (73.8)
I.D.: 1 19/32 (40.5)
Height: 1 21/32 (42.1)



PA4781 Air Element
Replaces: Samsung 60131062; Woodgate WGA1777
O.D.: 7 15/16 (201.6)
I.D.: 17/32 (13.5) & 4 31/32 (126.2)
Height: 3 13/16 (96.8)



PA4785 Panel Air Element
Replaces: Peugeot 144508; Woodgate WGA1785
Length: 12 23/32 (323.1)
Width: 6 3/32 (154.8)
Height: 2 5/16 (58.7)



PA4790 Panel Air Element
Replaces: Ford 88VB-9601-AA; Fleetguard AF4918; Woodgate WGA1809
Length: 9 7/16 (239.7)
Width: 8 7/8 (225.4)
Height: 2 1/4 (57.2)

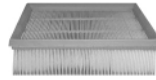

PA4793 Panel Air Element
Fits: Ford European Light-Duty Trucks
Replaces: Motorcraft EFA184; Woodgate WGA1835
Length: 11 3/32 (281.8)
Width: 7 1/8 (181.0)
Height: 2 9/32 (57.9)



RS4794 Radial Seal Air Element
Fits: DAF Trucks
Replaces: Leyland ACHD040; Fleetguard AF25478; Woodgate WGA1837
O.D.: 8 1/8 (206.4)
I.D.: 4 3/16 (106.4) One End
Height: 20 7/8 (530.2)



PA4795 Air Element with Lid
Replaces: Iseki 157210325000; Woodgate WGA1852
O.D.: 4 3/32 (104.0)
 Lid 5 7/8 (149.2)
I.D.: 9/16 (14.3) & 2 15/32 (62.7)
Height: 10 3/8 (263.5)
A. Gskt: [2] Attached



PA4801 Panel Air Element with Pull Tab
Replaces: J.C. Bamford 12/304176; Woodgate WGA1867
Length: 22 3/4 (577.9)
Width: 4 (101.6)
Height: 2 9/32 (57.9)
A. Gskt: [1] Attached



PA4802 Air Element
Fits: Carrier Refrigeration Units
Replaces: Carrier 30-0043022; Fleetguard AF25888; Woodgate WGA1869
O.D.: 4 1/8 (104.8)
 Top 4 15/32 (113.5)
I.D.: 2 21/32 (67.5) One End
Height: 10 5/32 (258.0)



RS4803 Radial Seal Air Element
Replaces: Kubota T0270-16321; Woodgate WGA1872
O.D.: 4 7/32 (107.2)
I.D.: 2 5/32 (54.8) One End
Height: 9 19/32 (243.7)



Measurements Are Shown In Inches And (Millimeters)

WARNING: These products can expose you to chemicals, including Diisononyl Phthalate, Carbon black extracts, Nickel, 1,3 Butadiene, Ethylene Oxide, Epichlorohydrin, which are known to the State of California to cause cancer, and Bisphenol, Ethylene Glycol, Ethylene Oxide, 1,3 Butadiene, Epichlorohydrin, which are known to the State of California to cause birth defects or other reproductive harm. For more information go to www.P65Warnings.ca.gov.

RS4804



Radial Seal Air Element

Fits: Massey Ferguson Equipment
Replaces: Iseki 167510421300; Woodgate WGA1873
O.D.: 3 3/4 (95.3)
I.D.: 1 21/32 (42.1)
Height: 6 15/16 (176.2)

PA4814



Air Element

Replaces: Ford A700X-9K600-BA; GMC 7988055; Fleetguard AF4023; Woodgate WGA920
O.D.: 5 21/32 (143.7)
I.D.: 3 1/2 (88.9)
Height: 5 3/16 (131.8)

RS4806



Radial Seal Air Element

Fits: Mitsubishi Trucks
Replaces: Mitsubishi ME017246; Woodgate WGA1882
O.D.: 9 1/8 (231.8)
I.D.: 4 23/32 (119.9) One End
Height: 11 7/32 (285.0)

PA4819



Air Element

Fits: Farymann Marine Engines; Wacker Equipment
Replaces: Farymann 5410522; Fleetguard AF25433; Woodgate WGA925
O.D.: 3 27/32 (97.6)
 4 3/32 (104.0)
I.D.: 1 13/32 (35.7)
Height: 5 3/16 (131.8)
Grommets: [1] Attached

RS4807



Radial Seal Air Element

Fits: Mitsubishi European Light-Duty Trucks
Replaces: Mitsubishi ML126032; Woodgate WGA1887
O.D.: 9 1/32 (229.4)
I.D.: 4 5/8 (117.5) One End
Height: 11 3/8 (288.9)

PA4820



Oval Air Element with Foam Wrap

Fits: Dynapac Equipment; Honda Engines
Replaces: Honda 17210-ZE1-822; Fleetguard AF25472; Woodgate WGA935
O.D.: 2 29/32 (73.8) to 3 31/32 (100.8)
I.D.: 1/4 (6.4) & 1 1/4 (31.8)
Height: 2 11/16 (68.3)
Grommets: [1] Attached

PA4809



Inner Air Element

Fits Inside: PA2813
Fits: Scania Trucks
Replaces: Scania 397813; Fleetguard AF4727; Woodgate WGA458S
O.D.: 5 15/16 (150.8)
 Flange 6 1/4 (158.8)
I.D.: 2 1/32 (16.7) & 5 11/16 (144.5)
Height: 14 25/32 (375.4)

PA4823

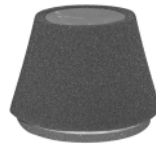

Conical-Shaped Air Element with Foam Wrap

Fits: Robin Engines
Replaces: Robin 2073260107; Woodgate WGA944
O.D.: 2 15/32 (62.7) to 4 5/32 (150.6)
I.D.: 2 13/16 (71.4) One End
Height: 3 7/32 (81.8)
A. Gskt: [1] Attached

PA4810



Air Element

Replaces: CompAir 982621014; Woodgate WGA471
O.D.: 5 1/16 (128.6)
I.D.: 3 7/16 (87.3)
Height: 3 11/32 (84.9)

PA4824



Air Element

Fits: Yanmar Engines, Generators
Replaces: Yanmar 114250-12580; Fleetguard AF25607; Woodgate WGA948
O.D.: 3 15/16 (100.0)
 Flange 4 1/8 (104.8)
I.D.: 2 1/8 (54.0) One End
Height: 1 25/32 (45.2)
Grommets: [1] Attached

PA4813



Air Element

Replaces: CompAir 982621015; Woodgate WGA639
O.D.: 6 3/16 (157.2)
I.D.: 4 13/16 (122.2)
Height: 5 19/32 (142.1)

PA4825



Air Element

Replaces: Orenstein & Koppel 1499267; Fleetguard AF4065; Woodgate WGA95
O.D.: 5 7/16 (138.1)
 Boot 6 15/32 (164.3)
I.D.: 2 27/32 (72.2) One End
Height: 15 5/8 (396.9)
A. Gskt: [1] Attached

Measurements Are Shown In Inches And (Millimeters)



WARNING: These products can expose you to chemicals, including Diisononyl Phthalate, Carbon black extracts, Nickel, 1,3 Butadiene, Ethylene Oxide, Epichlorohydrin, which are known to the State of California to cause cancer, and Bisphenol, Ethylene Glycol, Ethylene Oxide, 1,3 Butadiene, Epichlorohydrin, which are known to the State of California to cause birth defects or other reproductive harm. For more information go to www.P65Warnings.ca.gov.

PA4827

Inner Air Element



Fits Inside: PA3848-FN
Fits: Manitou Equipment
Replaces: New Holland 85807052; Fleetguard AF25321; Woodgate WGA964S
O.D.: 3 11/32 (84.9)
 Flange 4 3/16 (106.4)
I.D.: 23/32 (18.3) & 2 15/16 (74.6)
Height: 11 7/32 (285.0)
A. Gskt: [1] Attached

PA4829

Conical-Shaped Air Element with Foam Wrap



Fits: Robin Engines
Replaces: Robin 2053600404; Woodgate WGA967
O.D.: 2 15/32 (62.7)
 Flange 4 1/4 (108.0)
I.D.: 2 1/4 (57.2)
Height: 2 3/8 (60.3)
A. Gskt: [1] Attached

PA4830

Air Element



Fits: Robin Engines
Replaces: Robin 2433260008; Woodgate WGA969
O.D.: 3 15/16 (100.0)
I.D.: 1/4 (6.4) & 2 23/32 (69.0)
Height: 2 3/32 (53.2)

PA4832

Air Element



Replaces: Air Maze 6CD; Woodgate WGA977
O.D.: 9 5/8 (244.5)
I.D.: 7 1/2 (190.5)
Height: 9 1/16 (230.2)

PA4833-FN

Air Element with Lid and Fins



Fits: Hitachi Excavators
Replaces: Hitachi 4294845; Fleetguard AF25200K; Woodgate WGA982K
O.D.: 3 5/16 (84.1)
 Lid 5 1/32 (127.8)
I.D.: 7/16 (11.1) & 1 13/16 (46.0)
Height: 7 3/8 (187.3)
A. Gskt: [1] Attached

PA4834-FN

Air Element with Fins



Replaces: Gehl 49140111110; Woodgate WGA999K
O.D.: 4 3/32 (104.0)
 Fins 5 1/8 (130.2)
I.D.: 21/32 (16.7) & 2 15/32 (62.7)
Height: 6 1/32 (153.2)
A. Gskt: [1] Attached
F. Gskt: [1] Included

PA4848

Air Element



Replaces: Woodgate WGD800020
O.D.: 7 1/32 (178.6)
I.D.: 5 7/16 (138.1)
Height: 5 5/8 (142.9)

PA4849

Conical-Shaped Air Element



Replaces: Woodgate WGD800027
O.D.: 5 19/32 (142.1)
 Flange 8 21/32 (219.9)
I.D.: 4 5/8 (117.5)
Height: 12 3/4 (323.9)
A. Gskt: [1] Attached

PA4852

Panel Air Element



Fits: Stihl TS400 Chain Saws
Use With: PA4852 FOAM; PA4853
Replaces: Stihl 42231410300; Fleetguard AF25855; Woodgate WGA1187
Length: 5 13/32 (137.3)
Width: 3 3/8 (85.7)
Height: 1 13/16 (46.0)

PA4852 FOAM

Foam Blanket for PA4852



Notes: Has [2] holes drilled through foam blanket.
Fits: Stihl TS400 Chain Saws
Use With: PA4852
Width: 3 5/32 (80.2)
Height: 3/4 (19.1)

PA4853

Air Element

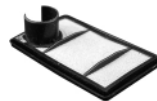

Contains: Tube on one end
Fits: Stihl TS400 Chain Saws
Use With: PA4852
Replaces: Stihl 42231401800; Woodgate WGA1187S
Length: 4 5/8 (117.5)
Width: 2 11/16 (68.3)
Height: 1 5/32 (29.4)

PA4854

Panel Air Element

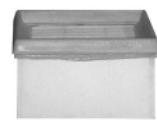

Fits: Makita Saws
Use With: PA4854 FOAM; PA4855
Replaces: Makita 394173010; Woodgate WGA1568
Length: 4 1/8 (104.8)
Width: 3 5/32 (80.2)
Height: 2 5/16 (58.7)

PA4855

Plastic Mesh Secondary Air Element



Fits: Makita Saws
Use With: PA4854
Replaces: Makita 394173020; Woodgate WGA1568S
Length: 3 9/16 (90.5)
Width: 2 9/16 (65.1)
Height: 21/32 (16.7)

Measurements Are Shown In Inches And (Millimeters)

WARNING: These products can expose you to chemicals, including Diisononyl Phthalate, Carbon black extracts, Nickel, 1,3 Butadiene, Ethylene Oxide, Epichlorohydrin, which are known to the State of California to cause cancer, and Bisphenol, Ethylene Glycol, Ethylene Oxide, 1,3 Butadiene, Epichlorohydrin, which are known to the State of California to cause birth defects or other reproductive harm. For more information go to www.P65Warnings.ca.gov.

PA4857

Cab Air Element



Fits: Freightliner Trucks
Replaces: Freightliner 91559, BOA91559
Length: 10 5/8 (269.9)
Width: 10 5/8 (269.9)
Height: 31/32 (24.6)

PA4858

Cab Air Element



Fits: John Deere Loaders, Toolcarriers
Replaces: John Deere T156471
Length: 16 3/8 (415.9)
Width: 8 9/16 (217.5)
Height: 1 9/16 (39.7)
A. Gskt: [2] Attached

RS4859

Radial Seal Air Element



Fits: Chevrolet Kodiak, GMC Topkick Trucks
Replaces: GMC 88937527, 88937528;
 ACDelco A2032C, A2033C
O.D.: 7 7/8 (200.0)
I.D.: 4 9/16 (115.9) One End
Height: 17 13/32 (442.1)

PA4860

Air Element in Disposable Housing



Replaces: Farr 40082-0022
O.D.: 11 (279.4)
Inlet: 7
Outlet: 6
Height: 19 13/16 (503.2)

RS4861

Radial Seal Air Element



Contains: 5/16 Inch bolt on closed end
Fits: DAF Trucks
Replaces: DAF 1318919; Fleetguard AF25237;
 Woodgate WGA1245
O.D.: 9 17/32 (242.1)
I.D.: 4 13/16 (122.2) One End
Height: 16 15/32 (418.3)

RS4862

Radial Seal Outer Air Element



Fits: International Trucks
Use With: RS4863
Replaces: International 3551814-C1
O.D.: 12 1/16 (306.4)
I.D.: 9 7/8 (250.8) One End
Height: 16 3/32 (408.8)

RS4863

Conical-Shaped Radial Seal Inner Air Element



Fits Inside: RS4862
Fits: International Trucks
Replaces: International 3551815-C1
O.D.: 5 3/8 (136.5) to 9 15/16 (252.4)
I.D.: 6 15/16 (176.2) One End
Height: 15 13/32 (391.3)

RS4864

Radial Seal Air Element with 2 Blank Bands



Replaces: Coopers AEM2620; Fleetguard
 AF25635; Woodgate WGA1634
O.D.: 8 3/8 (212.7)
I.D.: 4 27/32 (123.0) One End
Height: 14 17/32 (369.1)

PA4865-FN

Outer Air Element with Fins



Use With: PA4753
Replaces: Johnson Sweepers 13085;
 Woodgate WGA162K
O.D.: 5 1/4 (133.4)
 Fins 6 5/16 (160.3)
I.D.: 2 1/32 (16.7) & 2 13/16 (71.4)
Height: 15 (381.0)

PA4866

Outer Air Element



Fits: Massey Ferguson Tractors
Use With: PA4867
Replaces: Massey Ferguson 1698675-M2;
 Fleetguard AF1960; Woodgate WGA1083
O.D.: 4 7/32 (107.2)
 Boot 5 (127.0)
I.D.: 1 11/32 (8.2) & 2 11/16 (68.3)
Height: 9 13/32 (238.9)
A. Gskt: [1] Attached
F. Gskt: [1] Metal Washer, [1] Rubber Washer

PA4867

Inner Air Element



Fits Inside: PA4866
Fits: Massey Ferguson Tractors
Replaces: Massey Ferguson 1698676-M1;
 Fleetguard AF1961; Woodgate WGA1083S
O.D.: 2 19/32 (65.9)
I.D.: 1 11/32 (8.7) & 1 21/32 (42.1)
Height: 8 11/32 (211.9)
A. Gskt: [1] Attached

PA4870-FN

Outer Air Element with Lid and Fins



Fits: J.C. Bamford Loaders; Zetor Tractors
Use With: PA2700
Replaces: J.C. Bamford 32/913601; Fleetguard
 AF25958K; Woodgate WGA1059K
O.D.: 5 1/4 (133.4)
 Lid 6 27/32 (173.8)
I.D.: 19/32 (15.1) & 2 13/16 (71.4)
Height: 12 3/32 (307.2)
A. Gskt: [1] Attached; [1] Wing Nut

Measurements Are Shown In Inches And (Millimeters)



WARNING: These products can expose you to chemicals, including Diisononyl Phthalate, Carbon black extracts, Nickel, 1,3 Butadiene, Ethylene Oxide, Epichlorohydrin, which are known to the State of California to cause cancer, and Bisphenol, Ethylene Glycol, Ethylene Oxide, 1,3 Butadiene, Epichlorohydrin, which are known to the State of California to cause birth defects or other reproductive harm. For more information go to www.P65Warnings.ca.gov.

PA4871 Air Element
Replaces: Tamrock 81166609; Woodgate WGA937
O.D.: 8 7/32 (208.8)
I.D.: 5 15/16 (150.8)
Height: 4 (101.6)



PA4879 Foam Air Filter
Replaces: Woodgate WGA1896
Width: 3 15/32 (88.1)
Height: 13/32 (10.3)



PA4872 Air Element
Replaces: Becker 909506000; Woodgate WGA962
O.D.: 3 5/16 (84.1)
I.D.: 2 3/8 (60.3) One End
Height: 2 13/16 (71.4)
A. Gskt: [1] Attached



PA4881 Inner Air Element
Fits Inside: PA3435-FN
Fits: Manitou Equipment
Replaces: Manitou 177178; Woodgate WGA1054S
O.D.: 2 9/16 (65.1)
 Flange 2 29/32 (73.8)
I.D.: 1 1/32 (8.7) & 2 7/32 (56.4)
Height: 10 1/4 (260.4)
A. Gskt: [1] Attached



PA4873 Wire Mesh Supported Conical-Shaped Air Element with Foam Wrap
Fits: Robin Engines
Replaces: Robin 2263261500; Woodgate WGA968
O.D.: 1 31/32 (50.0) to 3 25/32 (96.0)
I.D.: 2 1/32 (51.6) One End
Height: 2 5/32 (54.8)
A. Gskt: [1] Attached



PA4882 Inner Air Element
Notes: OBSOLETE. Availability Limited to Dealer Stock.
Fits Inside: PA2727
Replaces: Woodgate WGA1086S
O.D.: 2 29/32 (73.8)
I.D.: 7/16 (11.1) & 2 13/32 (61.1)
Height: 11 1/8 (282.6)
A. Gskt: [1] Attached
F. Gskt: [1] Included



PA4874 Panel Air Element
Notes: For air conditioning
Replaces: Woodgate WGD20202
Length: 19 1/2 (495.3)
Width: 19 1/2 (495.3)
Height: 1 25/32 (45.2)

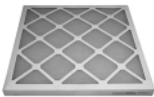

PA4883 Air Element
Replaces: Wacker 18419; Woodgate WGA1155
O.D.: 3 3/32 (78.6)
I.D.: 2 9/32 (57.9)
Height: 3 1/8 (79.4)
A. Gskt: [2] Attached



PA4876 Air Element
Contains: Threaded hex nut for removal.
Replaces: Atlas Copco 3214-6239-00; Fleetguard AF26147; Woodgate WGD852600
Thread: M76 x 4.0
O.D.: 4 23/32 (119.9)
I.D.: 2 15/16 (74.6) One End
Height: 23 5/8 (600.1)
A. Gskt: [1] Attached



PA4885 Panel Air Element
Fits: Briggs & Stratton Engines
Replaces: Briggs & Stratton 399877; Woodgate WGA1167
Length: 4 5/8 (117.5)
Width: 4 5/8 (117.5)
Height: 25/32 (19.8)

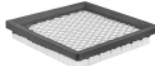

PA4877 Air Element
Replaces: Becker 84040112; Woodgate WGA1270
O.D.: 8 1/16 (204.8)
I.D.: 5 23/32 (145.3)
Height: 6 15/32 (164.3)



PA4886 Oblong Air Element with Foam Wrap
Fits: Komatsu Excavators; Yanmar Engines
Replaces: Yanmar 1146501-2540; Woodgate WGA1169
O.D.: 3 7/8 (98.4) to 5 19/32 (142.1)
I.D.: 1/4 (6.4) & 3 11/16 (93.7)
Height: 2 7/8 (73.0)
Grommets: [1] Attached



PA4878 Air Element
Replaces: CompAir AP111581443; Woodgate WGA1679
O.D.: 3 (76.2)
I.D.: 1 21/32 (42.1)
Height: 4 19/32 (116.7)
A. Gskt: [2] Attached
Related To: PA4939 (Long Version)



PA4887 Air Element in Disposable Housing
Fits: Vogele Paving Equipment
Replaces: Volvo 3826215; Fleetguard AF25312; Woodgate WGA1242
O.D.: 10 (254.0)
I.D.: 4 23/32 (119.9) One End
Height: 27 5/8 (701.7)



Measurements Are Shown In Inches And (Millimeters)

WARNING: These products can expose you to chemicals, including Diisononyl Phthalate, Carbon black extracts, Nickel, 1,3 Butadiene, Ethylene Oxide, Epichlorohydrin, which are known to the State of California to cause cancer, and Bisphenol, Ethylene Glycol, Ethylene Oxide, 1,3 Butadiene, Epichlorohydrin, which are known to the State of California to cause birth defects or other reproductive harm. For more information go to www.P65Warnings.ca.gov.

PA4888

Panel Air Element



Fits: Ford European Light-Duty Trucks
Replaces: Volvo 3434495; Fleetguard AF25709; Woodgate WGA1243
Length: 12 19/32 (319.9)
Width: 5 31/32 (151.6)
Height: 2 9/32 (57.9)

PA4889

Air Element



Replaces: Leyland ACU8456; Fleetguard AF25087; Woodgate WGA1252
O.D.: 11 3/32 (281.8)
I.D.: 2 1/32 (16.7) & 6 3/4 (171.5)
Height: 14 7/16 (366.7)
A. Gskt: [1] Attached
F. Gskt: [1] Washer

PA4890

Air Element



Replaces: Renault 5001000878; Fleetguard AF4910; Woodgate WGA1255
O.D.: 5 1/8 (130.2)
I.D.: 3 9/16 (90.5)
Height: 12 1/4 (311.2)

PA4891

Air Element



Replaces: Becker 84040405; Woodgate WGA1283
O.D.: 2 17/32 (64.3)
I.D.: 1 1/2 (38.1) One End
Height: 2 23/32 (69.1)
A. Gskt: [1] Attached

PA4893

Air Element



Replaces: Hydrovane HY0119; Woodgate WGA1316
O.D.: 8 11/16 (220.7)
I.D.: 5 29/32 (150.0)
Height: 2 1/4 (57.2)

PA4895

Air Element



Replaces: Rietschle 731142; Woodgate WGA1409
O.D.: 2 23/32 (69.1)
I.D.: 1 5/16 (33.3) One End
Height: 3 5/32 (80.2)

PA4896

Air Element with Attached Spring



Replaces: Rietschle 731148; Woodgate WGA1410
O.D.: 2 1/8 (54.0)
I.D.: 1 5/16 (33.3) One End
Height: 7 27/32 (199.2)
A. Gskt: [1] Attached
Spring: [1] Attached

PA4897

Air Breather Element in Disposable Housing



Replaces: Ingersoll-Rand 93191542; Woodgate WGA1415
O.D.: 6 15/32 (164.3)
I.D.: 3 (76.2) One End
Height: 5 1/2 (139.7)
A. Gskt: [1] Attached

PA4900

Air Element



Replaces: CompAir 9826281; Woodgate WGA1531
O.D.: 3 7/8 (98.4)
I.D.: 2 3/8 (60.3)
Height: 4 3/32 (104.0)

PA4902

Air Element



Fits: Hatz Engines
Replaces: Hatz 504260001001; Woodgate WGA1571
O.D.: 4 15/32 (113.5)
I.D.: 1/4 (6.4) & 2 (50.8)
Height: 3 3/32 (78.6)
Grommets: [1] Attached

PA4903

Air Element



Replaces: Nissan 16546-1G000; Fleetguard AF25353; Woodgate WGA1573
O.D.: 4 15/16 (125.4)
I.D.: 1 1/32 (8.7) & 2 3/4 (69.9)
Height: 9 1/4 (235.0)
A. Gskt: [2] Attached

PA4905

Panel Air Element

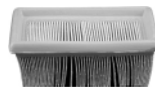

Fits: Stihl Chain Saws
Replaces: Stihl 41341410300B; Woodgate WGA1579
Length: 3 7/16 (87.3)
Width: 2 23/32 (69.1)
Height: 1 1/32 (26.2)

Measurements Are Shown In Inches And (Millimeters)



WARNING: These products can expose you to chemicals, including Diisononyl Phthalate, Carbon black extracts, Nickel, 1,3 Butadiene, Ethylene Oxide, Epichlorohydrin, which are known to the State of California to cause cancer, and Bisphenol, Ethylene Glycol, Ethylene Oxide, 1,3 Butadiene, Epichlorohydrin, which are known to the State of California to cause birth defects or other reproductive harm. For more information go to www.P65Warnings.ca.gov.

PA4906 Panel Air Element
Fits: Honda Engines
Replaces: Honda 17211-883-W21; Woodgate WGA1580
Length: 7 (177.8)
Width: 3 1/2 (88.9)
Height: 1 1/16 (27.0)



PA4907 Oblong Air Element with Foam Wrap
Fits: Robin Engines
Replaces: Robin 2623260107; Woodgate WGA1585
O.D.: 3 1/32 (77.0) to 5 3/4 (146.1)
I.D.: 1/4 (6.4) & 4 1/16 (103.2)
Height: 3 1/16 (77.8)
A. Gskt: [1] Attached



PA4908 Foam Air Filter
Notes: Has 1 3/16 In. hole in center.
Fits: Honda Engines
Replaces: Honda 17211-ZE1-000; Woodgate WGA1587
Length: 4 31/32 (126.2)
Width: 3 27/32 (97.6)
Height: 1 19/32 (40.5)



PA4910 Air Element with Foam Wrap
Fits: Kubota Engines
Replaces: Kubota 12182-11080; Woodgate WGA1629
O.D.: 4 1/2 (114.3) to 4 13/16 (122.2)
I.D.: 1/4 (6.4) & 2 5/16 (58.7)
Height: 2 5/8 (66.7)
A. Gskt: [1] Attached
Grommets: [1] Attached



PA4911 Foam Pad for PA4754
Replaces: Woodgate WGA1635-PF
Width: 3 3/32 (78.6)
Height: 7/32 (5.6)



PA4912 Panel Air Element
Fits: Mercedes-Benz Trucks, Vans
Replaces: Mercedes-Benz 8301218, A0008301218
Length: 15 1/32 (381.8)
Width: 5 3/16 (131.8)
Height: 1 19/32 (40.5)
A. Gskt: [1] Attached
Related To: PA5492 (Charcoal Impregnated Media Version)



PA4918 Replacement for Ecolite Air Element in Disposable Housing
Replaces: CompAir 982625141; Donaldson C065004; Woodgate WGA1692
O.D.: 6 1/2 (165.1)
I.D.: 2 1/4 (57.2) One End
Height: 10 3/8 (263.5)



PA4919 Inner Air Element
Fits Inside: PA1681-FN
Replaces: Nissan 16546-L9011; Woodgate WGA16S
O.D.: 3 11/32 (84.9)
 Flange 4 1/8 (104.8)
I.D.: 21/32 (16.7) & 2 29/32 (73.8)
Height: 11 1/16 (281.0)
A. Gskt: [1] Attached
F. Gskt: [1] Included



PA4925 Air Element
Replaces: Leyland ACU2376; Fleetguard AF4989; Woodgate WGA182
O.D.: 9 3/16 (233.4)
I.D.: 21/32 (16.7) & 4 13/16 (122.2)
Height: 16 15/32 (418.3)
A. Gskt: [1] Attached



PA4928 Panel Cab Air Element
Fits: DAF Trucks
Replaces: DAF 1322259; Fleetguard AF26139; Woodgate WGA1832
Length: 16 7/16 (417.5)
Width: 6 5/32 (156.4)
Height: 29/32 (23.0)
A. Gskt: [1] Attached

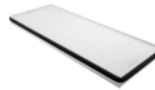

PA4929 Oval Air Element with Lid and Air Restriction Gauge Fitting
Fits: Volvo Trucks
Replaces: Volvo 3120490; Woodgate WGA1840
O.D.: 7 3/8 to 12 1/8 (187.3 to 308.0)
 Lid 9 9/32 to 13 31/32 (235.7 to 354.8)
I.D.: 5 7/16 (138.1) One End
Height: 25 (635.0)



PA4930 Air Element
Notes: Can be used with PA4931 Foam Blanket.
Contains: Plastic Clamp with Screw on Open End
 Fitting Attachment on Closed End
Fits: Kawasaki Mules
Replaces: Kawasaki 110291004; Woodgate WGA1849
O.D.: 5 1/32 (127.8)
I.D.: 2 27/32 (72.2)
Height: 4 7/16 (112.7)



PA4931 Foam Blanket for PA4930
Replaces: Kawasaki 110131217; Woodgate WGA1849PF
O.D.: 4 15/16 (125.4)
I.D.: 4 19/32 (116.7)
Length: 3 9/16 (90.5)



Measurements Are Shown In Inches And (Millimeters)

WARNING: These products can expose you to chemicals, including Diisononyl Phthalate, Carbon black extracts, Nickel, 1,3 Butadiene, Ethylene Oxide, Epichlorohydrin, which are known to the State of California to cause cancer, and Bisphenol, Ethylene Glycol, Ethylene Oxide, 1,3 Butadiene, Epichlorohydrin, which are known to the State of California to cause birth defects or other reproductive harm. For more information go to www.P65Warnings.ca.gov.

PA4932



Panel Air Element
Replaces: Jacobsen 72368G01; Woodgate WGA1850
Length: 11 15/32 (291.3)
Width: 5 3/32 (129.4)
Height: 1 13/16 (46.0)

PA4945



Panel Air Element with Lift Tabs
Fits: Mercedes-Benz Trucks, Vans
Replaces: Mercedes-Benz 9408350047
Length: 17 3/4 (450.9)
Width: 7 13/32 (191.3)
Height: 1 7/32 (31.0)
A. Gskt: [1] Attached

PA4934



Air Element
Fits: Kubota Tractors
Replaces: Kubota 67980-82630; Woodgate WGA1859
O.D.: 3 11/32 (84.9)
I.D.: 1 13/16 (46.0)
Height: 7 7/16 (188.9)
A. Gskt: [2] Attached

PA4947



Panel Air Element
Contains: [3] Screws
Fits: Iveco Trucks
Replaces: Iveco 3799020
Length: 17 5/16 (439.7)
Width: 3 29/32 (99.2)
Height: 1 1/2 (38.1)

PA4935



Oval Air Element
Notes: Lid measures 5 13/16 x 3 5/32 (147.6 x 80.2)
Replaces: Kawasaki 110132132; Woodgate WGA1860
O.D.: 5 1/16 (128.6) to 6 (152.4)
I.D.: 25/32 (19.8) & 3 27/32 (97.6)
Height: 2 7/16 (61.9)
A. Gskt: [1] Attached

PA4954



Panel Air Element
Contains: Charcoal Impregnated Media for Odor Control
Replaces: Iveco 93162491
Length: 11 13/32 (289.7)
Width: 6 5/16 (160.3)
Height: 1 3/16 (30.2)

PA4938



Panel Cab Air Element
Fits: Scania Trucks
Replaces: Scania 1420197; Woodgate WGA1885
Length: 9 3/32 (231.0)
Width: 6 7/8 (174.6)
Height: 2 23/32 (69.1)
A. Gskt: [1] Attached

PA4955



Cab Air Element
Fits: M.A.N. Trucks
Replaces: M.A.N. 81.61910.0018
Length: 18 3/8 (466.7)
Width: 7 9/32 (184.9)
Height: 2 13/16 (71.4)
A. Gskt: [1] Attached
Related To: PA5477 (Charcoal Media Version)

PA4939



Air Element
Replaces: Woodgate WGA1886
O.D.: 2 31/32 (75.4)
I.D.: 1 21/32 (42.1)
Height: 5 1/4 (133.4)
Related To: PA4878 (Short Version)

PA4956



Panel Air Element
Fits: Mercedes-Benz Trucks, Vans
Replaces: Mercedes-Benz 8301118
Length: 14 15/16 (379.4)
Width: 5 5/16 (134.9)
Height: 1 17/32 (38.9)

PA4941



Panel Air Element
Replaces: Volkswagen 55129620A; Woodgate WGA855
Length: 7 25/32 (197.6)
Width: 3 5/8 (92.1)
Height: 1 13/16 (46.0)

PA4957



Panel Air Element
Replaces: Mercedes-Benz 8356947
Length: 13 7/32 (335.8)
Width: 6 7/8 (174.6)
Height: 1 1/32 (26.2)
A. Gskt: [1] Attached

PA4942



Air Element with Lid
Replaces: Mercedes-Benz 120948502; Woodgate WGA88
O.D.: 10 7/16 (265.1)
Lid: 13 5/32 (334.2)
I.D.: 13/32 (10.3) & 5 1/4 (133.4)
Height: 9 1/32 (229.4)
A. Gskt: [1] Attached

RS4959



Radial Seal Air Element
Contains: Flame Retardant Media
Fits: DAF Trucks
Replaces: DAF 1638006, 1726060
O.D.: 10 1/2 (266.7)
I.D.: 6 11/16 (169.9)
Height: 18 7/8 (479.4)

PA4960-FN



Outer Air Element with Fins
Use With: PA4961
Replaces: Sofiltra 124005
O.D.: 7 7/8 (200.0)
Fins: 9 1/2 (241.3)
I.D.: 25/32 (19.8) & 3 9/16 (90.5)
Height: 14 1/16 (357.2)
A. Gskt: [1] Attached

Measurements Are Shown In Inches And (Millimeters)

WARNING: These products can expose you to chemicals, including Diisononyl Phthalate, Carbon black extracts, Nickel, 1,3 Butadiene, Ethylene Oxide, Epichlorohydrin, which are known to the State of California to cause cancer, and Bisphenol, Ethylene Glycol, Ethylene Oxide, 1,3 Butadiene, Epichlorohydrin, which are known to the State of California to cause birth defects or other reproductive harm. For more information go to www.P65Warnings.ca.gov.

PA4961



Inner Air Element

Fits Inside: PA4960-FN
Replaces: Sofiltra 125001
O.D.: 3 11/32 (84.9)
 Flange 4 5/8 (117.5)
I.D.: 7/16 (11.1) & 3 1/32 (77.0)
Height: 13 9/32 (337.3)
A. Gskt: [1] Attached

RS4969



Radial Seal Air Element

Fits: Iveco Trucks
Replaces: Iveco 42471166;
 Fleetguard AF25876
O.D.: 9 19/32 (243.7)
I.D.: 5 7/16 (138.1) One End
Height: 16 5/16 (414.3)

RS4962



Radial Seal Inner Air Element

Fits Inside: RS3940
Replaces: Toyota 17744-23600-71; Fleetguard
 AF25483; Woodgate WGA1289S
O.D.: 3 1/16 (77.8)
 Flange 3 5/32 (80.2)
I.D.: 2 7/16 (61.9) One End
Height: 10 15/32 (265.9)

RS4970



Radial Seal Air Element

Fits: DAF, Kenworth Trucks
Replaces: Fleetguard AF25873
O.D.: 8 3/8 (212.7)
I.D.: 4 11/16 (119.1) One End
Height: 16 7/16 (417.5)
Related To: RS5433 (Flame Retardant Media)

RS4963



Radial Seal Air Element

Fits: Scania Trucks
Replaces: Scania 1387549; Mann & Hummel
 C311254; Fleetguard AF25614; Woodgate
 WGA1529
O.D.: 12 3/16 (309.6)
I.D.: 7 1/32 (178.6) One End
Height: 18 5/16 (465.1)

RS4971



Radial Seal Outer Air Element

Contains: Flame Retardant Media
Fits: M.A.N. Trucks
Use With: RS5361
Replaces: M.A.N. 81.08405.0016;
 Fleetguard AF25894
O.D.: 10 11/16 (271.5)
I.D.: 6 11/16 (169.9) One End
Height: 20 (508.0)

RS4966



Radial Seal Outer Air Element

Fits: Volvo Trucks
Use With: RS5408
Replaces: Volvo 8149064; Fleetguard AF25631
O.D.: 11 31/32 (304.0)
 Flange 12 13/16 (325.4)
I.D.: 5 15/16 (150.8) One End
Height: 16 1/8 (409.6)

RS4972



Radial Seal Air Element

Fits: Deutz-Fahr Tractors
Use With: RS5684
Replaces: Fleetguard AF25504
O.D.: 8 5/32 (207.2)
I.D.: 4 9/32 (108.7) One End
Height: 15 1/16 (382.6)

RS4967



Radial Seal Outer Air Element

Fits: Volvo Trucks
Use With: PA3925
Replaces: Volvo 814996-1; Fleetguard AF25632
O.D.: 13 1/16 (331.8)
 Flange 13 25/32 (350.0)
I.D.: 7 15/16 (201.6) One End
Height: 16 11/32 (415.1)
A. Gskt: [2] Attached
Related To: RS5776 (Flame Retardant Media)

PA4973



Rectangular Air Element

Fits: Ingersoll-Rand Compressors
Replaces: Ingersoll-Rand 51322881;
 Woodgate WGD800016
Length: 32 3/16 (817.6)
Width: 9 13/32 (238.9)
Height: 3 1/2 (88.9)

RS4968



Radial Seal Air Element

Fits: Iveco Trucks
Replaces: Iveco 42471161;
 Fleetguard AF25875
O.D.: 9 21/32 (245.3)
I.D.: 5 7/16 (138.1) One End
Height: 13 1/16 (331.8)

PA4975



Panel Air Element

Replaces: Woodgate WGD12122
Length: 11 3/8 (288.9)
Width: 11 3/8 (288.9)
Height: 1 3/4 (44.5)

Measurements Are Shown In Inches And (Millimeters)

WARNING: These products can expose you to chemicals, including Diisononyl Phthalate, Carbon black extracts, Nickel, 1,3 Butadiene, Ethylene Oxide, Epichlorohydrin, which are known to the State of California to cause cancer, and Bisphenol, Ethylene Glycol, Ethylene Oxide, 1,3 Butadiene, Epichlorohydrin, which are known to the State of California to cause birth defects or other reproductive harm. For more information go to www.P65Warnings.ca.gov.

PA4977-FN

Air Element with Fins



Replaces: Fiat 8016660; Woodgate WGA1553
O.D.: 9 5/32 (232.6)
 Fins 11 13/32 (289.7)
I.D.: 25/32 (19.8) & 4 29/32 (124.6)
Height: 13 19/32 (345.3)

PA4987

Cab Air Element

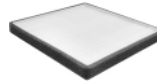

Fits: Komatsu Dozers
Replaces: Komatsu 77Z9-70-0010
Length: 8 9/32 (210.3)
Width: 8 1/32 (204.0)
Height: 25/32 (19.8)
A. Gskt: [1] Attached

PA4978

Air Element



Replaces: Becker 909536; Woodgate WGA956
O.D.: 2 9/32 (57.9)
I.D.: 3/16 (4.8) & 23/32 (18.3)
Height: 1 19/32 (40.5)
A. Gskt: [1] Attached

RS4988

Radial Seal Air Element



Fits: Caterpillar D9R Crawler Tractor
Replaces: Caterpillar 165-1689;
 Donaldson P606220
O.D.: 13 15/32 (342.1)
I.D.: 8 5/32 (207.2) One End
Height: 15 17/32 (394.5)

PA4979

Panel Air Element

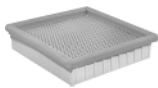

Fits: Lombardini Engines
Replaces: Lombardini 55.02175.096;
 Woodgate WGA1618
Length: 6 9/32 (159.5)
Width: 6 5/32 (156.4)
Height: 1 17/32 (38.9)

RS4989

Radial Seal Outer Air Element



Notes: Sometimes used with RS4629.
Fits: Caterpillar, John Deere, New Holland
 Equipment
Replaces: Perkins SEV551F14
O.D.: 14 7/32 (361.2)
I.D.: 8 15/16 (227.0) One End
Height: 24 27/32 (631.0)

PA4983

Inner Air Element



Fits Inside: PA4984-FN
Fits: Hyundai Excavators, Loaders
Replaces: Hyundai 11EM21051
O.D.: 5 5/32 (131.0)
I.D.: 3/4 (19.1) & 4 1/32 (102.4)
Height: 19 7/16 (493.7)
A. Gskt: [1] Attached

PA4991

Cab Air Element



Fits: Volvo Dump Trucks, Loaders
Replaces: Volvo 11703980
Length: 19 1/8 (485.8)
Width: 11 1/4 (285.8)
Height: 2 7/16 (61.9)
A. Gskt: [1] Included

PA4984-FN

Outer Air Element with Fins



Fits: Hyundai Excavators, Loaders
Use With: PA4983
Replaces: Hyundai 11EM21041
O.D.: 7 31/32 (202.4)
 Fins 9 13/16 (249.2)
I.D.: 3/4 (19.1) & 5 3/8 (136.5)
Height: 19 13/16 (503.2)
A. Gskt: [1] Attached

RS4992

Radial Seal Outer Air Element



Fits: John Deere Equipment
Use With: RS5329
Replaces: John Deere AT300487
O.D.: 8 27/32 (224.6)
I.D.: 7 1/8 (181.0) One End
Height: 16 23/32 (424.7)

PA4985

Cab Air Element



Fits: International Trucks
Replaces: International 2506656-C1
Length: 12 19/32 (319.9)
Width: 7 1/4 (184.2)
Height: 31/32 (24.6)

RS4993

Radial Seal Air Element



Replaces: Fleetguard AF25708M;
 Nelson 870904A, 870904N
O.D.: 11 3/32 (281.8)
I.D.: 8 (203.2) One End
Height: 20 15/32 (519.9)

PA4986

Cab Air Element



Fits: Komatsu Equipment
Replaces: Komatsu 77Z9-70-0020
Length: 12 7/32 (310.4)
Width: 8 1/32 (204.0)
Height: 25/32 (19.8)
A. Gskt: [1] Attached

Measurements Are Shown In Inches And (Millimeters)

WARNING: These products can expose you to chemicals, including Diisononyl Phthalate, Carbon black extracts, Nickel, 1,3 Butadiene, Ethylene Oxide, Epichlorohydrin, which are known to the State of California to cause cancer, and Bisphenol, Ethylene Glycol, Ethylene Oxide, 1,3 Butadiene, Epichlorohydrin, which are known to the State of California to cause birth defects or other reproductive harm. For more information go to www.P65Warnings.ca.gov.

RS4994



Radial Seal Outer Air Element
Fits: Caterpillar Crawler Tractors
Use With: RS4995
Replaces: Caterpillar 180-5474; Donaldson P606804
O.D.: 6 1/2 (165.1)
I.D.: 3 9/16 (90.5) One End
Height: 12 17/32 (318.3)

RS4995



Radial Seal Inner Air Element
Fits Inside: RS4994
Fits: Caterpillar Crawler Tractors
Replaces: Caterpillar 180-5475
O.D.: 3 21/32 (92.9)
I.D.: 2 7/8 (73.0) One End
Height: 12 3/32 (307.2)

CA4996



Channel Flow Primary Air Element
Fits: Caterpillar Crawler Tractors, Loaders; Valtra Tractors
Use With: PA4997
Replaces: Caterpillar 2277448, 2934053
O.D.: 7 7/8 (200.0) to 9 1/8 (231.8)
Height: 6 7/8 (174.6)

PA4997



Channel Flow Secondary Air Element
Fits: Caterpillar Crawler Tractors, Loaders
Use With: CA4996
Replaces: Caterpillar 2277449; J.C. Bamford 32/926072
O.D.: 5 9/16 (141.3) to 8 7/32 (208.8)
Height: 1 19/32 (40.5)

CA4999



Channel Flow Air Element
Fits: Ford Excursion, Super Duty Trucks all with 6.0L Turbo Diesel Engine
Replaces: Ford 3C3U-9601-BC; Motorola FA1746; Donaldson P603577; Fleetguard AF26152; Wix 42731
O.D.: 7 31/32 (202.4) to 12 3/32 (307.2)
Height: 9 5/16 (236.5)
A. Gskt: [1] Attached

CFB5000



Coolant Filter Base
Contains: 11/16-16 Threaded Stud
Use With: All Coolant Spin-ons with 11/16-16 Thread
O.D.: 4 11/16 (119.1)
Inlet: 3/8-18 NPTF
Outlet: 3/8-18 NPTF
Height: 3 3/32 (78.6)

CS5007



BTA PLUS Formula Liquid Additive (Pint Plastic Bottle)
Notes: NOT compatible with Long Life Organic Acid-based Coolant.
 For systems containing 0% to 60% Ethylene Glycol antifreeze.
Contains: 4 Units BTA PLUS
 Pre-Charge treatment is 1 1/4 units per gallon of cooling system capacity.
 Maintenance treatment is 1 1/4 units per 4 gallons of cooling system capacity every 12,000-15,000 miles or 300-350 hours of operation.
Replaces: Case B91245; Cummins 3305372, 3315459; John Deere RE23182, TY16004
Related To: CS5055 (55 Gallon Drum) CS5057 (5 Gallon Jug) CS5058 (Half Gallon Jug)

CS5008



BTE Liquid Coolant Additive (Pint Plastic Bottle)
Notes: NOT compatible with Long Life Organic Acid-based Coolant.
 For systems containing 40% to 60% Ethylene Glycol antifreeze.
 Compatible with all Ethylene Glycol antifreezes. Heavy-Duty antifreeze containing sodium nitrite needs no initial treatment.
 Pre-Charge treatment is one pint to each 4 gallons of cooling system capacity or fraction.
 Maintenance treatment is one pint for each 20 gallons of cooling system capacity or fraction. Every 12,000-15,000 miles or 300-350 hours of operation.

CS5009



BTE Liquid Coolant Additive (Half Gallon Plastic Jug)
Notes: NOT compatible with Long Life Organic Acid-based Coolant.
 For systems containing 40% to 60% Ethylene Glycol antifreeze.
 Compatible with all Ethylene Glycol antifreezes. Heavy-Duty antifreeze containing sodium nitrite needs no initial treatment.
 Pre-Charge treatment is one pint to each 4 gallons of cooling system capacity or fraction.
 Maintenance treatment is one pint for each 20 gallons of cooling system capacity or fraction. Every 12,000-15,000 miles or 300-350 hours of operation.

CS5010



BTE Liquid Coolant Additive (5 Gallon Bucket)
Notes: NOT compatible with Long Life Organic Acid-based Coolant.
 For systems containing 40% to 60% Ethylene Glycol antifreeze.
 Compatible with all Ethylene Glycol antifreezes. Heavy-Duty antifreeze containing sodium nitrite needs no initial treatment.
 Pre-Charge treatment is one pint to each 4 gallons of cooling system capacity or fraction.
 Maintenance treatment is one pint for each 20 gallons of cooling system capacity or fraction. Every 12,000-15,000 miles or 300-350 hours of operation.

Measurements Are Shown In Inches And (Millimeters)

WARNING: These products can expose you to chemicals, including Diisononyl Phthalate, Carbon black extracts, Nickel, 1,3 Butadiene, Ethylene Oxide, Epichlorohydrin, which are known to the State of California to cause cancer, and Bisphenol, Ethylene Glycol, Ethylene Oxide, 1,3 Butadiene, Epichlorohydrin, which are known to the State of California to cause birth defects or other reproductive harm. For more information go to www.P65Warnings.ca.gov.

CS5011



BTE Liquid Coolant Additive (55 Gallon No Return Plastic Drum)

Notes: NOT compatible with Long Life Organic Acid-based Coolant.
For systems containing 40% to 60% Ethylene Glycol antifreeze.
Compatible with all Ethylene Glycol antifreezes.
Heavy-Duty antifreeze containing sodium nitrite needs no initial treatment.
Pre-Charge treatment is one pint to each 4 gallons of cooling system capacity or fraction.
Maintenance treatment is one pint for each 20 gallons of cooling system capacity or fraction.
Every 12,000-15,000 miles or 300-350 hours of operation.

CSC5012



Liquid Coolant Cleaner (1 Gallon Plastic Bottle)

Notes: An inhibited neutral chelating cooling system cleaner. CSC is formulated to dissolve scale and corrosion products while removing silica gel and oil found in engine cooling systems.
Recommended treatment is 1 gallon to each 10 gallons of cooling system capacity.
While you may get improved performance from a higher concentration of CSC, do not use CSC at more than twice the recommended concentration levels.

CSC5013



Liquid Coolant Cleaner (5 Gallon Jug)

Notes: An inhibited neutral chelating cooling system cleaner. CSC is formulated to dissolve scale and corrosion products while removing silica gel and oil found in engine cooling systems.
Recommended treatment is 1 gallon to each 10 gallons of cooling system capacity.
While you may get improved performance from a higher concentration of CSC, do not use CSC at more than twice the recommended concentration levels.

CTK5028



Correcting Refractometer

Notes: This refractometer measures Ethylene and Propylene Glycol based fluids.
Contains: Internal Light Source
Syringe
Dip Stick

CTK5029



FleetStrip Coolant Test Kit

Notes: Kit is designed to test SCAs by measuring freeze point, nitrite and molybdate. Does not test Long Life Organic Acid-based coolant.
Contains: [1] Sample Vial
[1] Extraction Pipet
Instructions
Color Chart
Plastic Carrying Case
[50] Test Strips
Replaces: Fleetguard CC2602

CTK5029-1



FleetStrip Coolant Test Strip Only

Contains: [1] Test Strip, Color Chart, Instruction Sheet
Replaces: Fleetguard CC2602B

CTK5029-4



FleetStrip Coolant Test Strips Only

Contains: [4] Test Strips, Color Chart, Instruction Sheet

CTK5029-M



FleetStrip Coolant Test Kit

Notes: CTK5029-M Color Chart measurement is metric.
Kit is designed to test SCAs by measuring freeze point, nitrite and molybdate.
Does not test Long Life Organic Acid-based coolant.
Contains: [1] Sample Vial
[1] Extraction Pipet
Instructions
Color Chart
Plastic Carrying Case
[50] Test Strips

CS5055



BTA PLUS Liquid Additive (55 Gallon No Return Plastic Drum)

Notes: NOT compatible with Long Life Organic Acid-based Coolant.
Pre-Charge treatment is 1 1/4 units per gallon of cooling system capacity.
Maintenance treatment is 1 1/4 units per 4 gallons of cooling system
Related To: CS5007 (Pint Bottle)
CS5057 (5 Gallon Bucket)
CS5058 (Half Gallon Jug)

CS5057



BTA PLUS Liquid Additive (5 Gallon Jug)

Notes: NOT compatible with Long Life Organic Acid-based Coolant.
Pre-Charge treatment is 1 1/4 units per gallon of cooling system capacity.
Maintenance treatment is 1 1/4 units per 4 gallons of cooling system
Replaces: Caterpillar 8C3680
Related To: CS5007 (Pint Bottle)
CS5055 (55 Gallon No Return Plastic Drum)
CS5058 (Half Gallon Jug)

Measurements Are Shown In Inches And (Millimeters)



WARNING: These products can expose you to chemicals, including Diisononyl Phthalate, Carbon black extracts, Nickel, 1,3 Butadiene, Ethylene Oxide, Epichlorohydrin, which are known to the State of California to cause cancer, and Bisphenol, Ethylene Glycol, Ethylene Oxide, 1,3 Butadiene, Epichlorohydrin, which are known to the State of California to cause birth defects or other reproductive harm. For more information go to www.P65Warnings.ca.gov.

CS5058



BTA PLUS Formula Liquid Additive (Half Gallon Jug)

Notes: NOT compatible with Long Life Organic Acid-based Coolant.
Pre-Charge treatment is 1 1/4 units per gallon of cooling system capacity.
Maintenance treatment is 1 1/4 units per 4 gallons of cooling system
Replaces: Cummins 3305373;
Komatsu 1258390-H1
Related To: CS5007 (Pint Bottle)
CS5055 (55 Gallon No Return Plastic Drum)
CS5057 (5 Gallon Bucket)

BW5070



Coolant Spin-on with BTA PLUS Formula

Notes: Maintenance filter for systems with 1-6 gallons capacity.
Can be used with CFB5000 base, or CFB8784 dual base.
Contains: 2 Units BTA PLUS
Fits: Cummins Engines
Replaces: Cummins 3318157;
Fleetguard WF2070
Thread: 11/16 -16
O.D.: 3 11/16 (93.7)
Height: 4 3/8 (111.1)
I.Gskt: G381-A

OTK5060



Live Oil Sample Kit with Processing

Notes: Purchase of kit includes testing charges.
Testing includes 23 Elements, Antifreeze, Fuel Dilution, Viscosity @ 100 C, Complete Oil Condition (Soot, Oxidation, Nitration, Sulfation)
Contains: [1] 2.5 oz. Bottle with Lid, Live Sample Cap for Sample Extraction
Label for Sample Information
Ziploc, Bubble Mailer for Return
(Return Postage is not included)
Fits: Engines, Transmissions, Hydraulics
Use With: Systems with Pressurized Probalyzer Ports - OTK5061 (Marine Applications)
Replaces: Titan OD1020

BW5071



Coolant Spin-on with BTA PLUS Formula

Notes: Maintenance filter for systems with 7-16 gallons capacity.
Can be used with CFB5000 base or CFB8784 dual base.
Contains: 4 Units BTA PLUS
Fits: Cummins Engines
Replaces: Ag-Chem 709939; Case 1822627C1; Caterpillar 226-6565; Cummins 3315116; Demag 692338; Ford E5NN-8A424-A; General Motors 25012893; Hitachi 4127340; John Deere RE42052; Mack 25MF214; Fleetguard WF2071
Thread: 11/16 -16
O.D.: 3 11/16 (93.7)
Height: 4 3/8 (111.1)
I.Gskt: G381-A

OTK5061



Stainless Steel Probalyzer Plug

Notes: Installs into standard NPT 1/8 In. pressure ports, allows fluid samples to be drawn during operation using live sample caps, handles up to 5000 psi.
Can be installed on any pressurized line for oil and coolant. Best used in Marine applications as it does not corrode in salt water.
Contains: Stainless Steel Plug with Instructions
Use With: OTK5060
Replaces: Titan OD1015

BW5072



Coolant Spin-on with BTA PLUS Formula

Notes: Maintenance filter for systems with 17-21 gallons capacity.
Can be used with CFB5000 base or CFB8784 dual base.
Contains: 6 Units BTA PLUS
Fits: Cummins Engines
Replaces: Cummins 3318201; Ford E8NN-8A424-B; Hough 1257937H1; John Deere F434679; Komatsu 6742-01-3970; Onan 133-3538; Volvo 129680286; Fleetguard WF2072
Thread: 11/16 -16
O.D.: 3 11/16 (93.7)
Height: 4 3/8 (111.1)
I.Gskt: G381-A

OTK5062



Brass Probalyzer Plug

Notes: OBSOLETE. Availability limited to dealer. Installs into standard NPT 1/8 In. pressure ports, allows fluid samples to be drawn during operation using live sample caps, handles up to 2200 psi.
Can be installed on any pressurized line for oil and coolant.
Contains: Oil Sample Fittings with Instructions
Replaces: Titan OD1014

BW5073



Coolant Spin-on with BTA PLUS Formula

Notes: Maintenance filter for systems with 22-32 gallons capacity.
Can be used with CFB5000 base or CFB8784 dual base.
Contains: 8 Units BTA PLUS
Fits: Cummins Engines
Replaces: Agco 1076751M1; Case 690139C1; Caterpillar 226-6567; Cummins 3315115; Daewoo 9912-15115; Demag 692336; Hitachi 19305494; Versatile 104040; Volvo M12968028; Fleetguard WF2073
Thread: 11/16 -16
O.D.: 3 11/16 (93.7)
Height: 5 3/8 (136.5)
I.Gskt: G381-A

OTK5063



Oil Test Kit

Notes: Purchase of kit includes testing charges.
Testing includes 23 Elements, Antifreeze, Fuel Dilution, Viscosity @ 100 C, Complete Oil Condition (Soot, Oxidation, Nitration, Sulfation)
Contains: [1] 2.5 oz. Bottle with Lid
Label for Sample Information
Ziploc, Bubble Mailer for Return (Return Postage is not included)
Fits: Extractor Pumps and Tubing as well as mid-drain sampling.
Replaces: Titan OD8011

Measurements Are Shown In Inches And (Millimeters)

WARNING: These products can expose you to chemicals, including Diisononyl Phthalate, Carbon black extracts, Nickel, 1,3 Butadiene, Ethylene Oxide, Epichlorohydrin, which are known to the State of California to cause cancer, and Bisphenol, Ethylene Glycol, Ethylene Oxide, 1,3 Butadiene, Epichlorohydrin, which are known to the State of California to cause birth defects or other reproductive harm. For more information go to www.P65Warnings.ca.gov.

BW5074



Coolant Spin-on with BTA PLUS Formula
Notes: Maintenance filter for systems with 33-43 gallons capacity.
 Can be used with CFB5000 base or CFB8784 dual base.
Contains: 12 Units BTA PLUS
Fits: Cummins Engines
Replaces: Cummins 3315114;
 Fleetguard WF2074
Thread: 11/16 -16
O.D.: 3 11/16 (93.7)
Height: 5 3/8 (136.5)
I.Gskt: G381-A

BW5075



Coolant Spin-on with BTA PLUS Formula
Notes: Maintenance filter for systems with 44-51 gallons capacity.
 Can be used with CFB5000 base or CFB8784 dual base.
Contains: 15 Units BTA PLUS
Fits: Cummins Engines
Replaces: Cummins 3318318;
 Fleetguard WF2075
Thread: 11/16 -16
O.D.: 3 11/16 (93.7)
Height: 5 3/8 (136.5)
I.Gskt: G381-A

BW5076



Coolant Spin-on with BTA PLUS Formula
Notes: Maintenance filter for systems with 52-70 gallons capacity.
 Can be used with CFB5000 base or CFB8784 dual base.
Contains: 23 Units BTA PLUS
Fits: Cummins Engines
Replaces: Cummins 3318319;
 Fleetguard WF2076
Thread: 11/16 -16
O.D.: 3 11/16 (93.7)
Height: 7 5/32 (181.8)
I.Gskt: G381-A

BW5082



Coolant Spin-on with BTA PLUS Formula
Notes: Maintenance filter for systems with 7-16 gallons capacity.
 Can be used with CFB5000 base or CFB8784 dual base.
Contains: 4 Units BTA PLUS
Fits: International Equipment
Replaces: International 1822313-C1;
 Fleetguard WF2106
Thread: 11/16 -16
O.D.: 3 11/16 (93.7)
Height: 5 3/8 (136.5)
I.Gskt: G381-A

BW5086



Coolant Spin-on with BTA PLUS Formula
Contains: 11 1/2 Units BTA PLUS
Fits: Cummins Engines
Replaces: Cummins 3680433;
 Fleetguard WF2126
Thread: M36 x 2.0
O.D.: 3 3/4 (95.3)
Height: 5 13/32 (137.3)
I.Gskt: [1] Included

B5087



Coolant Spin-on without Chemicals
Notes: Long Life (150,000 miles) used with Extended Service coolant.
Fits: Cummins Engines
Replaces: Cummins 3680434
Thread: M36 x 2.0
O.D.: 3 3/4 (95.3)
Height: 5 15/32 (138.9)
F. Gskt: [1] Included

B5088



Coolant Spin-on without Chemicals
Notes: Long Life (150,000 miles) used with Extended Service coolant
 Can be used with CFB5000 base or CFB8784 dual base.
Fits: Caterpillar, Cummins Engines
Replaces: Cummins 3098689
Thread: 11/16 -16
O.D.: 3 11/16 (93.7)
Height: 4 3/8 (111.1)
I.Gskt: G381-A
Related To: B5090 (Long Version)

B5089



Coolant Spin-on without Chemicals
Notes: Can be used with CFB5000 base or CFB8784 dual base.
Fits: Scania Trucks
Replaces: International 1825314-C1;
 Fleetguard WF2107
Thread: 11/16 -16
O.D.: 3 11/16 (93.7)
Height: 4 3/8 (111.1)
I.Gskt: G381-A
Related To: B5134 (Long Version)

B5090



Coolant Spin-on without Chemicals
Notes: Long Life (150,000 miles) used with Extended Service coolant
 Can be used with CFB5000 base or CFB8784 dual base.
Fits: International, Kenworth Trucks
Replaces: Cummins 3098690;
 Fleetguard WF2123
Thread: 11/16 -16
O.D.: 3 11/16 (93.7)
Height: 5 3/8 (136.5)
I.Gskt: G381-A
Related To: B5088 (Short Version)

B5091



Coolant Spin-on without Chemicals
Fits: Mack Trucks
Replaces: Mack 20575545
Thread: M16 x 1.5
O.D.: 3 11/16 (93.7)
Height: 5 13/32 (137.3)
A. Gskt: G401

P5092



Coolant Element without Chemicals
Fits: Detroit Diesel DD15 (14.8L) Engine;
 Freightliner, Mercedes-Benz, Sterling,
 Western Star Trucks
Replaces: Detroit Diesel A4722030155,
 A4722030255; Mercedes-Benz A4722030255
O.D.: 3 21/32 (92.9)
I.D.: 1 5/8 (41.3) One End
Height: 5 9/32 (134.1)
O-Ring: [1] Included

Measurements Are Shown In Inches And (Millimeters)

WARNING: These products can expose you to chemicals, including Diisononyl Phthalate, Carbon black extracts, Nickel, 1,3 Butadiene, Ethylene Oxide, Epichlorohydrin, which are known to the State of California to cause cancer, and Bisphenol, Ethylene Glycol, Ethylene Oxide, 1,3 Butadiene, Epichlorohydrin, which are known to the State of California to cause birth defects or other reproductive harm. For more information go to www.P65Warnings.ca.gov.

B5134

Coolant Spin-on without Chemicals



Notes: Can be used with CFB5000 base or CFB8784 dual base.
Fits: John Deere Equipment
Replaces: Caterpillar 9Y4528; Cummins 3300721; Ford E7NN-8A469-AA; GMC 25010844; Hino 16304-41015; John Deere RE11992
Thread: 11/16 -16
O.D.: 3 11/16 (93.7)
Height: 5 13/32 (137.3)
I.Gskt: G381-A
Related To: B5089 (Short Version)

BW5136

Coolant Spin-on with BTE Formula



Notes: Maintenance filter for systems with 1-10 gallons capacity.
 Can be used with CFB5000 base or CFB8784 dual base.
Contains: 2 Units BTE
Fits: Allis Chalmers, Case, International, John Deere Equipment
Replaces: Allis Chalmers 40290892; Case A151931; Caterpillar 7E6014; Ford E7HZ-8A424-C; John Deere AR89381; Komatsu 600-411-1190
Thread: 11/16 -16
O.D.: 3 11/16 (93.7)
Height: 4 3/8 (111.1)
I.Gskt: G381-A

BW5137

Coolant Spin-on with BTE Formula



Notes: Maintenance filter for systems with 11-20 gallons capacity.
 Can be used with CFB5000 base or CFB8784 dual base.
Contains: 4 Units BTE
Fits: Allis Chalmers, Caterpillar, Fiat-Allis, International, Komatsu Equipment; Chevrolet, Freightliner, GMC, International, Iveco, Kenworth, Peterbilt Trucks
Replaces: Allis Chalmers 4681776; Caterpillar 9N3368; Cummins 209606; GMC 23507545; Ford D2HZ-8A424-A; International 1801090-C1; Komatsu 600-411-1020
Thread: 11/16 -16
O.D.: 3 11/16 (93.7)
Height: 4 13/32 (111.9)
I.Gskt: G381-A

BW5138

Coolant Spin-on with BTE Formula



Notes: Maintenance filter for systems with 21-30 gallons capacity.
 Can be used with CFB5000 base or CFB8784 dual base.
Contains: 6 Units BTE
Fits: Komatsu Equipment
Replaces: Allis Chalmers 70697635; Fiat 70697635; GMC 25011791; Komatsu 600-411-1140
Thread: 11/16 -16
O.D.: 3 11/16 (93.7)
Height: 5 3/8 (136.5)
I.Gskt: G381-A

BW5139

Coolant Spin-on with BTE Formula



Notes: Maintenance filter for systems with 31-40 gallons capacity.
 Can be used with CFB5000 base or CFB8784 dual base.
Contains: 8 Units BTE
Fits: Caterpillar, Komatsu Equipment
Replaces: Allis Chalmers 4393504, 4393504-8; Case A152819; Caterpillar 9N3366; Cummins 209607; GMC 6439698; Hino 16304-1011; International 1801089-C1; John Deere AR88276; Komatsu 600-411-1040
Thread: 11/16 -16
O.D.: 3 11/16 (93.7)
Height: 5 11/32 (135.7)
I.Gskt: G381-A

BW5140

Coolant Spin-on with BTE Formula



Notes: Maintenance filter for systems with 41-50 gallons capacity.
 Can be used with CFB5000 base or CFB8784 dual base.
Contains: 16 Units BTE
Fits: Caterpillar, Komatsu Equipment
Replaces: Caterpillar 1W5518; Clark 963797; Cummins 3315788; GMC 23507189; John Deere AR94652; Komatsu 600-411-1420
Thread: 11/16 -16
O.D.: 3 11/16 (93.7)
Height: 7 5/32 (181.8)
I.Gskt: G381-A

BW5141

Coolant Spin-on with BTE Formula



Notes: Maintenance filter for systems with 1-10 gallons capacity.
Contains: 2 Units BTE
Fits: Volvo Equipment
Replaces: Volvo 1661964-5, 1699830, 1699830-7
Thread: M16 x 1.5
O.D.: 3 11/16 (93.7)
Height: 5 13/32 (137.3)
I.Gskt: G401

BW5142

Coolant Spin-on with BTE Formula



Contains: 8 Units BTE
Fits: Volvo Engines
Replaces: Volvo 3945411
Thread: M16 x 1.5
O.D.: 3 11/16 (93.7)
Height: 5 13/32 (137.3)
I.Gskt: G401

BW5143

Coolant Spin-on with BTE Formula



Notes: Can be used with CFB5000 base or CFB8784 dual base.
Contains: 11 Units BTE
Fits: Iveco Trucks
Replaces: Iveco 1901776
Thread: 11/16 -16
O.D.: 3 11/16 (93.7)
Height: 5 3/8 (136.5)
I.Gskt: G381-A

Measurements Are Shown In Inches And (Millimeters)

WARNING: These products can expose you to chemicals, including Diisononyl Phthalate, Carbon black extracts, Nickel, 1,3 Butadiene, Ethylene Oxide, Epichlorohydrin, which are known to the State of California to cause cancer, and Bisphenol, Ethylene Glycol, Ethylene Oxide, 1,3 Butadiene, Epichlorohydrin, which are known to the State of California to cause birth defects or other reproductive harm. For more information go to www.P65Warnings.ca.gov.

B5144 Coolant By-Pass Spin-on Canister
Notes: For use with Long Life Coolant. DO NOT replace with spin-on containing chemicals.
Fits: Volvo Engines
Replaces: Volvo 3969696; Fleetguard WF2109
Thread: M16 x 1.5
O.D.: 3 11/16 (93.7)
Height: 5 7/16 (138.1)
I.Gskt: G401



B5145 Coolant Spin-on without Chemicals
Notes: Long Life (150,000 miles) used with Extended Service coolant.
Fits: Volvo Equipment
Replaces: Volvo 20458771; Fleetguard WF2129
Thread: M16 x 1.5
O.D.: 3 11/16 (93.7)
Height: 4 7/16 (112.7)
I.Gskt: G401



B5176 Coolant Spin-on without Chemicals
Fits: Mack Engines, Trucks
Replaces: Fleetguard WF2078
Thread: 3/4 -20
O.D.: 3 11/16 (93.7)
Height: 5 3/8 (136.5)
I.Gskt: G381-A



B5177 Coolant Spin-on without Chemicals
Fits: Mack Engines, Trucks
Replaces: Fleetguard WF2079
Thread: 1 -16
O.D.: 4 1/4 (108.0)
Height: 5 13/16 (147.6)
I.Gskt: [1] Included



BW5178 Coolant Spin-on with BTE Formula
Contains: 10 Units BTE
Fits: Mack Engines, Trucks
Replaces: GMC 6439296; Mack 25MF428, 25MF428-A; White 27-077522
Thread: 3/4 -20
O.D.: 3 11/16 (93.7)
Height: 5 3/8 (136.5)
I.Gskt: G381-A



BW5179 Coolant Spin-on with BTE Formula
Contains: 16 Units BTE
Fits: Mack Engines, Trucks
Replaces: GMC 25010921; Mack 25MF418
Thread: 1 -16
O.D.: 4 1/4 (108.0)
Height: 5 13/16 (147.6)
I.Gskt: [1] Included



BW5182 Coolant Spin-on with BTE Formula
Notes: Can be used with CFB5000 base or CFB8784 dual base.
Contains: 8 Units BTE
Fits: Komatsu Excavators, Loaders
Replaces: Komatsu 600-411-1181
Thread: 11/16 -16
O.D.: 3 11/16 (93.7)
Height: 3 7/32 (81.8)
I.Gskt: G381-A



BW5183 Coolant Spin-on with BTE Formula
Contains: 12 Units BTE
Fits: Mack Trucks
Replaces: Mack 20539991
Thread: M16 x 1.5
O.D.: 3 11/16 (93.7)
Height: 4 7/16 (112.7)
I.Gskt: G401



BW5200 Controlled Release Coolant Spin-on with BTE Formula
Notes: Can be used with CFB5000 base or CFB8784 dual base.
Contains: Flow Control Orifice that meters flow of coolant through filter to allow coolant additives to be released in the amount required to maintain proper system balance for up to 150,000 miles of service.
Fits: Applications Using a "Controlled Release" Coolant Additive
Replaces: Nalcool NF2088
Thread: 11/16 -16
O.D.: 3 11/16 (93.7)
Height: 5 13/32 (137.3)
I.Gskt: G381-A



BW5201 Controlled Release Coolant Spin-on with BTE Formula
Contains: Flow Control Orifice that meters flow of coolant through filter to allow coolant additives to be released in the amount required to maintain proper system balance for up to 150,000 miles of service.
Fits: Applications Using a "Controlled Release" Coolant Additive
Replaces: Nalcool NF2089, NF2089-1, NFC2089
Thread: 3/4 -20
O.D.: 3 11/16 (93.7)
Height: 5 3/8 (136.5)
I.Gskt: G381-A



BW5250 Controlled Release Coolant Spin-on with BTA PLUS Formula
Notes: Can be used with CFB5000 base or CFB8784 dual base.
Contains: Flow Control Orifice that meters flow of coolant through filter to allow coolant additives to be released in the amount required to maintain proper system balance for up to 150,000 miles of service.
Fits: Applications using a "Controlled Release" Coolant Additive
Replaces: Cummins XWF4242; Fleetguard WF2121
Thread: 11/16 -16
O.D.: 3 11/16 (93.7)
Height: 5 13/32 (137.3)
I.Gskt: G381-A



Measurements Are Shown In Inches And (Millimeters)

WARNING: These products can expose you to chemicals, including Diisononyl Phthalate, Carbon black extracts, Nickel, 1,3 Butadiene, Ethylene Oxide, Epichlorohydrin, which are known to the State of California to cause cancer, and Bisphenol, Ethylene Glycol, Ethylene Oxide, 1,3 Butadiene, Epichlorohydrin, which are known to the State of California to cause birth defects or other reproductive harm. For more information go to www.P65Warnings.ca.gov.

PE5270



Urea Diesel Exhaust Fluid Filter
Contains: [1] Plastic Drain Plug
 [1] Steel Mesh Strainer
 [1] Foam Absorber
Fits: DAF, M.A.N., Volvo Trucks
Replaces: Cummins 3967874; DAF 1649425, 1674485, 1789050, 1815766, 1819795; Iveco 42553548, 42561571, 42562233; M.A.N. 81154036015, 81154036089; Nissan 20421-NY00J; Volvo 207136
O.D.: 2 23/32 (69.1)
I.D.: 31/32 (24.6) One End
Height: 3 (76.2)
F. Gskt: [1] Included
O-Ring: [1] Attached, [1] Included

PE5271



Urea Diesel Exhaust Fluid Filter
Contains: [1] Plastic Drain Plug
Fits: Challenger, Fendt, Massey Ferguson Tractors; Volvo Trucks
Replaces: Agco V837062993; Deutz 2934622; Iveco 42555073, 42561605; Renault 7420877950, 7420877953; Volvo 20876498, 20876502
O.D.: 2 19/32 (65.9)
I.D.: 7/16 (11.1)
Height: 3 15/16 (100.0)
F. Gskt: [1] Included
O-Ring: [2] Attached

PE5272



Urea Diesel Exhaust Fluid Filter in Plastic Shell
Fits: Freightliner, Mercedes-Benz, Western Star Buses, Trucks
Replaces: Freightliner A0001420089, A0001420289; Mercedes-Benz A0001420089, A0001420289
Element
O.D.: 1 11/16 (42.9)
I.D.: 1 1/32 (26.2)
Height: 3 3/8 (85.7)
O-Ring: [1] Attached
Shell
O.D. 2 13/16 (71.4)
I.D. 1 3/4 (44.5)
Height 3 29/32 (99.2)

RS5273



Radial Seal Outer Air Element
Fits: Case-IH, Kubota, New Holland Equipment
Use With: PA4633
Replaces: Case 87300190, SBA314531174; Kubota 6C6099410
O.D.: 3 17/32 (89.7)
I.D.: 1 17/32 (38.9) One End
Height: 7 (177.8)

PA5274



Outer Air Element
Use With: PA5275
Replaces: Dongfeng 1109N12020; Donaldson P500940; Fleetguard AF25276
O.D.: 11 13/16 (300.0)
I.D.: 11/32 (8.7) & 7 7/8 (200.0)
Height: 18 3/4 (476.3)
A. Gskt: [1] Attached

PA5275



Inner Air Element
Fits Inside: PA5274
Replaces: Dongfeng 1109N12030; Donaldson P500941; Fleetguard AF25277
O.D.: 7 15/32 (189.7)
I.D.: 11/16 (17.5) & 6 1/2 (165.1)
Height: 17 19/32 (446.9)
A. Gskt: [1] Attached

PA5276



Hydraulic Breather Element
Fits: Komatsu Dump Trucks, Equipment
Replaces: Komatsu 4216035170
O.D.: 2 5/32 (54.8)
I.D.: 7/8 (22.2) & 1 1/32 (31.2)
Height: 1 9/32 (32.5)

CA5278



Channel Flow Air Element
Notes: Sometimes used with PA4704 Secondary Air Element
Fits: Valtra Tractors
Replaces: Valtra 36539600
O.D.: 5 1/8 (130.2) to 12 13/16 (325.4)
Height: 7 5/16 (185.7)

PA5281



Cab Air Element with Foam Wrap
Contains: Charcoal impregnated media for odor control.
Fits: John Deere Sprayers, Tractors
Replaces: John Deere RE199681
O.D.: 7 15/16 (201.6)
I.D.: 9/16 (14.3) & 3 17/32 (89.7)
Height: 12 1/4 (311.2)

PA5282

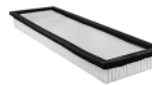

Cab Air Element
Fits: John Deere Tractors
Replaces: John Deere RE73220
Length: 15 11/32 (389.7)
Width: 4 29/32 (124.6)
Height: 1 7/16 (36.5)

PA5283



Cab Air Element
Fits: Gleaner, Massey Ferguson, White Combines
Replaces: Agco 71362389
Length: 23 29/32 (607.2)
Width: 9 (228.6)
Height: 2 1/4 (57.2)

BA5284



Coalescer Air Dryer Spin-on
Fits: Van Hool CL915, CL916 Buses with DAF Engines; DAF Trucks
Replaces: DAF 1681575, 1821580; Donaldson P951411
Thread: M41 x 1.5
O.D.: 5 7/16 (138.1)
Height: 6 9/16 (167.5)
I.Gskt: [1] Included
F. Gskt: [1] Included
Related To: BA5376 (Dessicant Version)

Measurements Are Shown In Inches And (Millimeters)

WARNING: These products can expose you to chemicals, including Diisononyl Phthalate, Carbon black extracts, Nickel, 1,3 Butadiene, Ethylene Oxide, Epichlorohydrin, which are known to the State of California to cause cancer, and Bisphenol, Ethylene Glycol, Ethylene Oxide, 1,3 Butadiene, Epichlorohydrin, which are known to the State of California to cause birth defects or other reproductive harm. For more information go to www.P65Warnings.ca.gov.

RS5285



Radial Seal Cab Air Element
Fits: Case Loaders; New Holland Motor Graders, Wheel Loaders
Replaces: Case 87712194, 76303305; New Holland 87712194, 76303305
O.D.: 6 1/4 (158.8)
I.D.: 2 3/4 (69.9) One End
Height: 10 29/32 (277.0)

RS5292



Radial Seal Inner Air Element
Fits Inside: RS5291
Fits: New Holland TF210, TG230, TG255, TG285 Tractors
Replaces: New Holland 451526A1
O.D.: 6 11/16 (169.9)
 Flange 7 1/4 (184.2)
I.D.: 5 7/16 (138.1) One End
Height: 15 (381.0)

RS5287XP



Extreme Performance Nano Radial Seal Outer Air Element
Contains: Inlet Adapter
Fits: Kenworth W900 Truck; Peterbilt 388, 389 Trucks
Replaces: Paccar P614556, X011622
O.D.: 12 3/32 (332.6)
I.D.: 4 5/8 (117.5) & 7 5/8 (193.7)
Height: 24 13/16 (630.2)
F. Gskt: [1] Included
Related To: RS30187XP (Premium Housing Gasket)

RS5293



Radial Seal Outer Air Element
Fits: Caterpillar Off-Highway Trucks; Donaldson G200088, G290055 Housings
Use With: RS5294
Replaces: Caterpillar 2777837, 4199172; Donaldson P609519; Fleetguard AF27698
O.D.: 17 23/32 (450.1)
I.D.: 11 7/16 (290.5) One End
Height: 30 1/32 (762.8)
Related To: RS5293XP (Extreme Performance Nano Version)

RS5288XP



Extreme Performance Nano Radial Seal Outer Air Element
Contains: Inlet Adapter
Fits: Kenworth, Peterbilt Trucks
Replaces: Paccar P614986
O.D.: 11 13/32 (289.7)
I.D.: 3 25/32 (96.0) & 7 5/8 (193.7)
Height: 22 29/32 (581.8)
F. Gskt: [1] Included

RS5293XP



Extreme Performance Nano Radial Seal Outer Air Element
Fits: Caterpillar Off-Highway Trucks; Donaldson G200088, G290055 Housings
Use With: RS5294
Replaces: Caterpillar 2777837, 4199172; Donaldson P609519; Fleetguard AF27698
O.D.: 17 23/32 (450.1)
I.D.: 11 7/16 (290.5) One End
Height: 30 1/32 (762.8)
Related To: RS5293 (Standard Media Version)

PA5289



Primary Oval Air Element with Lid
Fits: Caterpillar Equipment
Use With: PA5290
Replaces: Caterpillar 3466687
O.D.: 5 5/8 to 11 1/4 (142.9 to 285.8)
 Lid 5 5/16 to 11 7/8 (134.9 to 301.6)
I.D.: 7/8 (22.2) & 6 (152.4) One End
Height: 8 3/8 (212.7)

RS5294



Radial Seal Inner Air Element
Fits Inside: RS5293
Fits: Caterpillar Off-Highway Trucks; Donaldson G200088, G290055 Housings
Replaces: Caterpillar 2777838; Donaldson P609518; Fleetguard AF27698
O.D.: 11 9/16 (293.7)
I.D.: 9 (228.6) One End
Height: 24 3/8 (619.1)

PA5290



Secondary Oval Air Element
Fits: Caterpillar Equipment
Use With: PA5289
Replaces: Caterpillar 3466688
O.D.: 5 3/16 (131.8)
 to 10 5/16 (261.9)
Height: 1 1/2 (38.1)

RS5295



Radial Seal Inner Air Element
Notes: OBSOLETE. Availability Limited to Dealer Stock. Replaced by RS30191
Fits Inside: RS5296
Replaces: Reytor IT3098S; Donaldson P623175; Fleetguard AA2986
O.D.: 6 23/32 (170.7)
I.D.: 5 1/2 (139.7) One End
Height: 15 7/32 (386.6)

RS5291



Radial Seal Outer Air Element
Fits: New Holland TF210, TG230, TG255, 285 Tractors
Use With: RS5292
Replaces: New Holland 451525A1
O.D.: 11 (279.4)
I.D.: 7 3/32 (180.2) One End
Height: 15 3/4 (400.1)

RS5296



Radial Seal Inner Air Element
Notes: OBSOLETE. Availability Limited to Dealer Stock. Replaced by RS30192
Use With: RS5295
Replaces: Reytor IT3098; Donaldson P623166; Fleetguard AA2986
O.D.: 11 (279.4)
I.D.: 7 11/16 (195.3) One End
Height: 16 15/32 (418.3)

Measurements Are Shown In Inches And (Millimeters)

WARNING: These products can expose you to chemicals, including Diisononyl Phthalate, Carbon black extracts, Nickel, 1,3 Butadiene, Ethylene Oxide, Epichlorohydrin, which are known to the State of California to cause cancer, and Bisphenol, Ethylene Glycol, Ethylene Oxide, 1,3 Butadiene, Epichlorohydrin, which are known to the State of California to cause birth defects or other reproductive harm. For more information go to www.P65Warnings.ca.gov.

PA5297

Outer Air Element



Notes: Metal washer welded on one end.
Fits: Valtra Tractors
Use With: PA5298
Replaces: Agco 836862573; Valtra V836862573; Fleetguard AF26665
O.D.: 7 27/32 (199.2)
I.D.: 13/32 (10.3) & 5 (127.0)
Height: 15 9/16 (395.3)
A. Gskt: [1] Attached

RS5304

Radial Seal Inner Air Element



Fits Inside: RS3971
Fits: Volvo Excavators, Loaders
Replaces: Agco 4270036M1; Case K1H10560; J.C. Bamford 32/925402; New Holland 87682992; Volvo 11110284
O.D.: 4 1/4 (108.0)
I.D.: 3 3/8 (85.7) One End
Height: 15 5/32 (385.0)

PA5298

Inner Air Element



Notes: Metal washer welded on one end.
Fits Inside: PA5297
Fits: Valtra Tractors
Replaces: Agco 836862574; Valtra V836862574; Fleetguard AF27681
O.D.: 4 29/32 (124.6)
I.D.: 7/16 (11.1) & 3 31/32 (100.8)
Height: 16 21/32 (423.1)
A. Gskt: [1] Attached

RS5305

Radial Seal Cab Air Element



Fits: Caterpillar Loaders
Replaces: Caterpillar 149-1912; Donaldson P195930, P609447
O.D.: 6 1/2 (165.1)
I.D.: 3 9/16 (90.5) One End
Height: 11 27/32 (300.8)
Related To: RS5761 (Charcoal Media Version)

PA5299

Cab Air Element



Fits: Massey Ferguson Equipment
Replaces: Massey Ferguson 1078061M1
Length: 33 (838.2)
Width: 4 (101.6)
Height: 2 7/32 (56.4)

PA5306

Cab Air Element

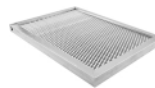

Fits: Kenworth Trucks
Replaces: Kenworth 525507, 525507BSM
Length: 13 7/8 (352.4)
Width: 10 3/32 (256.4)
Height: 7/8 (22.2)

PA5300

Cab Air Element with Pull Tabs



Fits: Caterpillar Equipment
Replaces: Caterpillar 180-7487; Donaldson P606762; Fleetguard AF25780
Length: 16 13/16 (427.0)
Width: 11 11/16 (297.0)
Height: 2 9/16 (65.1)
A. Gskt: [1] Included

PA5310

Pre-Filter Cab Air Element



Fits: Volvo Equipment
Replaces: Volvo 11703979
Length: 17 1/8 (435.0)
Width: 4 13/16 (122.2)
Height: 1 3/4 (44.5)
A. Gskt: [1] Included

RS5301

Radial Seal Air Element



Fits: Mack Trucks
Replaces: Renault 5010315990; Donaldson P782137; Fleetguard AF25898
O.D.: 9 11/16 (246.1)
I.D.: 4 7/8 (123.8) One End
Height: 14 5/8 (371.5)

PA5311

Air Breather Element



Fits: Volvo Equipment
Replaces: Volvo 11707077, 11707077-1
O.D.: 4 5/32 (105.6)
I.D.: 2 15/32 (62.7)
Height: 2 7/8 (73.0)

PA5302

Air Element in Disposable Housing



Fits: Winpower Generators
Replaces: Fleetguard AH1100
O.D.: 15 5/16 (388.9)
Outlet: 5 1/2
Height: 12 1/4 (311.2)
F. Gskt: [4] Included

PA5312 KIT

Air Element Kit



Contains: [1] Panel Air Element
 [1] Breather Element
Fits: Scania Trucks
Replaces: Scania 1485187, 1485188, 1486634
Panel Air
O.D.: 3 27/32 (97.6)
Length: 1 3/16 (27.8)
Width: 6 31/32 (177.0)
Height: 2 5/8 (66.7)
Breather
O.D. 3 27/32 (97.6)
Height 1 3/16 (30.2)

PA5303

Air Element in Disposable Housing



Replaces: Cummins 3315742; Fleetguard AH1101
O.D.: 17 5/8 (447.7)
Outlet: 5 1/2
Height: 19 13/16 (503.2)
F. Gskt: [4] Included

Measurements Are Shown In Inches And (Millimeters)

WARNING: These products can expose you to chemicals, including Diisononyl Phthalate, Carbon black extracts, Nickel, 1,3 Butadiene, Ethylene Oxide, Epichlorohydrin, which are known to the State of California to cause cancer, and Bisphenol, Ethylene Glycol, Ethylene Oxide, 1,3 Butadiene, Epichlorohydrin, which are known to the State of California to cause birth defects or other reproductive harm. For more information go to www.P65Warnings.ca.gov.

RS5313



Radial Seal Inner Air Element
Fits Inside: RS3726
Fits: Scania Trucks
Replaces: Scania 1335680;
 Fleetguard AF25969
O.D.: 6 7/8 (174.6)
I.D.: 5 5/32 (131.0) One End
Height: 19 23/32 (500.9)

PA5321



Cab Air Element
Fits: Peterbilt Trucks
Replaces: Elixaire 5X000180, 5X000190
Length: 11 1/8 (282.6)
Width: 6 25/32 (172.2)
Height: 25/32 (19.8)

PA5314

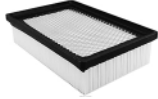

Cab Air Element
Fits: John Deere Equipment
Replaces: John Deere AT191102
Length: 9 5/16 (236.5)
Width: 6 11/32 (161.1)
Height: 2 9/32 (57.9)

PA5323



Air Element with Lid and 6 Bolt Holes
Replaces: Fleetguard AF25593;
 Nelson 64288P
O.D.: 12 3/32 (307.2)
 Lid 16 1/4 (412.8)
I.D.: 7 23/32 (196.1) One End
Height: 23 3/4 (603.3)
A. Gskt: [2] Attached

PA5315



Panel Air Element
Fits: John Deere Equipment
Replaces: Elgin 7172355; Donaldson P113407
Length: 20 (508.0)
Width: 7 1/2 (190.5)
Height: 2 3/16 (55.6)
A. Gskt: [1] Attached
Related To: PA2354 (without Attached Gasket)

PA5324-FN



Air Element with Fins
Fits: Bobcat Excavators
Replaces: Melroe-Bobcat 1916711080
O.D.: 3 1/4 (82.6)
 Fins 4 7/32 (107.2)
I.D.: 7/16 (11.1) & 1 11/16 (42.9)
Height: 7 1/4 (184.2)
A. Gskt: [1] Attached

PA5316



Wire Mesh Supported Hydraulic Breather
Fits: Case, J.C. Bamford, Kobelco, Link-Belt,
 Volvo Excavators
Replaces: Volvo 14500233
O.D.: 2 5/32 (54.8)
I.D.: 1 7/32 (31.0)
Height: 1 1/2 (38.1)
A. Gskt: [2] Attached

RS5325



Radial Seal Air Element
Fits: Carrier Refrigeration Units
Replaces: Carrier 300042624, 300042627
O.D.: 4 5/32 (105.6)
I.D.: 3 (76.2) One End
Height: 10 23/32 (272.3)

PA5317



Cab Air Element with Handle
Fits: Volvo Excavators
Replaces: Volvo 14503269
Length: 12 13/16 (325.4)
Width: 6 1/32 (153.2)
Height: 2 9/32 (57.9)
A. Gskt: [1] Attached

PA5326



Air Element in Disposable Housing
Fits: Ingersoll-Rand Equipment
Replaces: Ingersoll-Rand 85413458;
 Donaldson ECC065003
O.D.: 6 5/8 (168.3)
I.D.: 2 5/16 (58.7) One End
Height: 6 5/16 (160.3)

PA5318

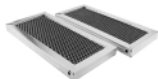

Set of 2 Cab Air Elements
Notes: Uses 2 filters per application.
Fits: Western Star Trucks
Replaces: Alliance 384160, RD384160
Each Filter:
Length: 11 15/16 (303.2)
Width: 5 7/16 (138.1)
Height: 7/8 (22.2)

PA5319

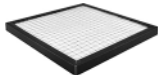

Cab Air Element
Fits: Freightliner Trucks
Replaces: Alliance ABPN83328345, N8328345;
 Freightliner 22446600, 2244665000;
 Fleetguard AF25697
Length: 10 19/32 (269.1)
Width: 10 19/32 (269.1)
Height: 3/4 (19.1)

PA5327

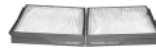

Cab Air Element
Fits: Komatsu Equipment
Replaces: Komatsu 20Y-979-6261
Length: 10 (254.0)
Width: 5 5/8 (142.9)
Height: 25/32 (19.8)

PA5320



Insert for Cab Air Element
Fits: Peterbilt Trucks
Replaces: Elixaire 5X010007
Length: 10 13/16 (274.6)
Width: 8 1/8 (206.4)
Height: 25/32 (19.8)
A. Gskt: [2] Attached

PA5328



Cab Air Element
Fits: Komatsu Equipment
Replaces: Komatsu 17M-911-3530
Length: 8 15/16 (227.0)
Width: 6 19/32 (167.5)
Height: 2 1/8 (54.0)

Measurements Are Shown In Inches And (Millimeters)

! **WARNING:** These products can expose you to chemicals, including Diisononyl Phthalate, Carbon black extracts, Nickel, 1,3 Butadiene, Ethylene Oxide, Epichlorohydrin, which are known to the State of California to cause cancer, and Bisphenol, Ethylene Glycol, Ethylene Oxide, 1,3 Butadiene, Epichlorohydrin, which are known to the State of California to cause birth defects or other reproductive harm. For more information go to www.P65Warnings.ca.gov.

RS5329



Radial Seal Inner Air Element
Fits Inside: RS4992
Fits: John Deere Equipment
Replaces: John Deere AT300488, AT314583
O.D.: 4 25/32 (121.4)
 Flange 7 1/4 (184.2)
I.D.: 3 5/8 (92.1) One End
Height: 16 1/8 (409.6)

PA5336



Cab Air Element
Fits: Iveco Trucks
Replaces: Iveco 504024890; Fleetguard AF26146
Length: 17 21/32 (448.5)
Width: 8 1/8 (206.4)
Height: 1 (25.4)
Related To: PA5476 (Charcoal Media Version)

PA5330



Foam Cab Air Element
Fits: DAF, Renault Trucks
Replaces: DAF 1600428; Renault 5001833354
Length: 8 31/32 (227.8)
Width: 4 3/16 (106.4)
Height: 25/32 (19.8)

PA5337



Cab Air Element
Fits: Sterling Trucks
Replaces: Ford F6HZ-19N619-AA
Length: 8 5/8 (219.1)
Width: 6 3/16 (157.2)
Height: 1 11/32 (34.1)
A. Gskt: [1] Included

PA5331

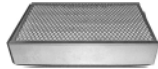

Cab Air Element
Fits: Volvo Motor Graders
Replaces: Volvo 12725424
Length: 12 9/32 (311.9)
Width: 7 9/16 (192.1)
Height: 2 7/16 (61.9)
A. Gskt: [1] Attached

PA5338-FN



Air Element with Lid and Fins
Fits: J.C. Bamford Equipment
Replaces: J.C. Bamford 32/925594
O.D.: 6 13/16 (173.0)
I.D.: 19/32 (15.1) & 2 27/32 (72.2)
Height: 11 23/32 (292.7)
A. Gskt: [1] Attached
F. Gskt: [1] Washer, [1] Wing Nut

RS5332



Radial Seal Air Element
Fits: Volvo Equipment
Replaces: Volvo Penta 3827643
O.D.: 11 31/32 (304.0)
I.D.: 7 3/8 (187.3) One End
Height: 19 1/8 (485.8)

PA5339



Cab Air Element
Fits: M.A.N. Trucks
Replaces: M.A.N. 85.619.500.025; Fleetguard AF26231
Length: 13 31/32 (354.8)
Width: 6 3/16 (157.2)
Height: 1 19/32 (40.5)
A. Gskt: [2] Attached

PA5333



Cab Air Element
Fits: New Holland Equipment
Replaces: Case/New Holland 86504784
Length: 8 3/32 (205.6)
Width: 5 9/32 (134.1)
Height: 1 5/8 (41.3)

PA5340



Cab Air Element
Fits: Mercedes-Benz Trucks
Replaces: Mercedes-Benz 9738350147; Fleetguard AF26144
Length: 22 23/32 (577.1)
Width: 6 7/16 (163.5)
Height: 1 15/32 (37.3)
A. Gskt: [1] Attached

RS5334



Radial Seal Outer Air Element
Fits: Caterpillar, Komatsu Equipment
Use With: RS5335
Replaces: Komatsu 600-185-2510, 600-185-2500
O.D.: 7 11/32 (186.5)
I.D.: 4 5/32 (105.6) One End
Height: 15 17/32 (394.5)

PA5341



Cab Air Element
Fits: DAF Trucks
Replaces: DAF 1362124; Fleetguard AF26145
Length: 10 11/32 (262.7)
Width: 6 1/2 (165.1)
Height: 1 9/16 (39.7)
A. Gskt: [1] Attached

RS5335



Radial Seal Inner Air Element
Fits Inside: RS5334
Fits: Caterpillar, Komatsu Equipment
Replaces: Komatsu 600-185-2500, 600-185-2520
O.D.: 4 1/4 (108.0)
I.D.: 3 3/8 (85.7) One End
Height: 15 (381.0)

RS5342



Radial Seal Air Element with Lid
Fits: Mercedes-Benz Trucks
Replaces: Mercedes-Benz 60949604, A0030949604; Fleetguard AF25653
O.D.: 11 7/32 (285.0)
 Lid 13 15/32 (342.1)
I.D.: 5 1/32 (127.8) One End
Height: 13 25/32 (350.0)

Measurements Are Shown In Inches And (Millimeters)

WARNING: These products can expose you to chemicals, including Diisononyl Phthalate, Carbon black extracts, Nickel, 1,3 Butadiene, Ethylene Oxide, Epichlorohydrin, which are known to the State of California to cause cancer, and Bisphenol, Ethylene Glycol, Ethylene Oxide, 1,3 Butadiene, Epichlorohydrin, which are known to the State of California to cause birth defects or other reproductive harm. For more information go to www.P65Warnings.ca.gov.

RS5343



Radial Seal Air Element with Lid
Fits: Mercedes-Benz Trucks
Replaces: Mercedes-Benz 40940204, A0040940204; Fleetguard AF25476
O.D.: 11 7/32 (285.0)
Lid: 13 17/32 (343.7)
I.D.: 5 1/32 (127.8) One End
Height: 15 31/32 (405.6)

RS5351



Radial Seal Air Element
Notes: Sometimes used as Inner Air Element with RS3727.
Fits: R.V.I. Trucks
Replaces: Renault 5010317187; Fleetguard AF25634; Donaldson P780624
O.D.: 7 1/16 (179.4)
I.D.: 5 11/16 (144.5) One End
Height: 17 1/2 (444.5)

RS5344



Radial Seal Outer Air Element
Use With: RS5345
Replaces: Reytor IT2000; Fleetguard AF25856
O.D.: 10 1/32 (254.8)
I.D.: 4 31/32 (126.2) One End
Height: 16 7/16 (417.5)

CA5352



Channel Flow Air Element
Fits: Chevrolet Silverado, GMC Sierra
Replaces: GMC 15282462; Donaldson P605313, P610875
O.D.: 9 5/16 (236.5)
Height: 6 9/32 (159.5)
A. Gskt: [1] Attached

RS5345



Radial Seal Inner Air Element
Fits Inside: RS5344
Replaces: Reytor IT2000S; Fleetguard AF25857
O.D.: 5 1/8 (130.2)
I.D.: 4 3/8 (111.1) One End
Height: 15 (381.0)

PA5353



Panel Air Element
Fits: Stihl TS700 Saw
Replaces: Stihl 42241410300A; SF Filter SL1551
Length: 5 5/8 (142.9)
Width: 4 1/32 (102.4)
Height: 1 7/8 (47.6)

RS5347



Radial Seal Inner Air Element
Fits Inside: RS5348
Replaces: Reytor IT2002S; Luber-finer LAF5764
O.D.: 5 3/4 (146.1)
I.D.: 4 7/8 (123.8) One End
Height: 15 1/2 (393.7)

RS5354



Radial Seal Outer Air Element
Fits: John Deere Sprayers, Tractors
Use With: RS5355
Replaces: John Deere RE210102; Fleetguard AF26337
O.D.: 12 3/32 (307.2)
I.D.: 7 13/16 (198.4) One End
Height: 12 11/16 (322.3)

RS5348



Radial Seal Outer Air Element
Use With: RS5347
Replaces: Reytor IT2004
O.D.: 9 15/32 (240.5)
I.D.: 5 9/16 (141.3) One End
Height: 16 11/32 (415.1)

RS5355



Radial Seal Inner Air Element
Fits Inside: RS5354
Fits: John Deere Sprayers, Tractors
Replaces: John Deere RE210103; Fleetguard AF26336
O.D.: 7 5/32 (181.8)
I.D.: 5 27/32 (148.4) One End
Height: 11 23/32 (297.7)

PA5350

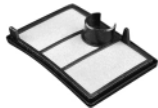

Air Element
Fits: Stihl Saws
Replaces: Stihl 42241401801A
Length: 4 11/16 (119.1)
Width: 3 9/32 (83.3)
Height: 15/16 (23.8)

RS5356



Radial Seal Air Element
Contains: Flame Retardant Media
Fits: Iveco Trucks
Replaces: Iveco 41272124; Donaldson P785352; Fleetguard AF26241
O.D.: 12 7/32 (310.3)
I.D.: 8 1/32 (204.0) One End
Height: 18 7/32 (462.8)

Measurements Are Shown In Inches And (Millimeters)



WARNING: These products can expose you to chemicals, including Diisononyl Phthalate, Carbon black extracts, Nickel, 1,3 Butadiene, Ethylene Oxide, Epichlorohydrin, which are known to the State of California to cause cancer, and Bisphenol, Ethylene Glycol, Ethylene Oxide, 1,3 Butadiene, Epichlorohydrin, which are known to the State of California to cause birth defects or other reproductive harm. For more information go to www.P65Warnings.ca.gov.

PA5357



Outer Air Element with Lift Bar
Fits: Case, New Holland Tractors
Replaces: Case 82034446
O.D.: 8 1/2 (215.9)
 Boot Gasket 10 (254.0)
I.D.: 19/32 (15.1) & 4 27/32 (123.0)
Height: 15 19/32 (396.1)
A. Gskt: [2] Attached
F. Gskt: [2] Included

PA5364



Outer Air Element
Contains: Flame Retardant Media
Fits: Iveco Trucks with Cursor 13 Engine
Use With: PA5365
Replaces: Iveco 2992374, 41272211;
 Fleetguard AF26204
O.D.: 12 7/8 (327.0)
I.D.: 13/32 (10.3) & 8 1/2 (215.9)
Height: 18 11/32 (465.9)
A. Gskt: [1] Attached
F. Gskt: [1] Washer

RS5358



Radial Seal Outer Air Element
Contains: Flame Retardant Media
Fits: Mercedes-Benz Trucks
Use With: RS5549
Replaces: Mercedes-Benz 40943504,
 A0040943504; Fleetguard AF26242
O.D.: 10 17/32 (267.5)
I.D.: 6 19/32 (167.5) One End
Height: 20 13/16 (528.6)
Related To: RS5508 (without Flame Retardant
 Media)

PA5365



Inner Air Element
Fits Inside: PA5364
Fits: Iveco Trucks with Cursor 13 Engine
Replaces: Iveco 2996157, 41214149;
 Fleetguard AF26245
O.D.: 7 7/8 (200.0)
I.D.: 21/32 (16.7) & 7 5/8 (193.7)
Height: 18 5/32 (461.2)
A. Gskt: [2] Attached

PA5359



Cab Air Element
Fits: Freightliner Trucks; Thomas Buses
Replaces: Alliance ABP/N10G-36000006;
 Freightliner 36000006, VCC36000006
Length: 8 5/8 (219.1)
Width: 8 11/32 (211.9)
Height: 31/32 (24.6)

CA5366



Channel Flow Air Element
Fits: Ford Trucks
Replaces: Ford 4C4Z-9601-AA;
 Motorcraft FA1753; Donaldson P69086;
 Fleetguard AF26493
O.D.: 7 5/16 (185.7) to 11 7/16 (290.5)
Height: 9 3/16 (233.4)
A. Gskt: [1] Included

RS5360



Radial Seal Air Element
Fits: DAF Trucks
Replaces: DAF 1363025, 1640920, 1657522;
 Fleetguard AF25976
O.D.: 10 7/16 (265.1)
I.D.: 6 3/16 (157.2) One End
Height: 16 15/32 (418.3)

CA5368



Channel Flow Air Element
Fits: Freightliner Business Class M2 Trucks
Replaces: Donaldson P607965, P544325
O.D.: 11 31/32 (304.0) & 14 7/8 (377.8)
Height: 8 1/32 (204.0)
Related To: CA5419 (Flame Retardant Media
 Version)

RS5361



Radial Seal Inner Air Element
Fits Inside: RS4971; RS5534
Fits: ERF, ECM, ECT Series Trucks; M.A.N.
 Buses, Trucks
Replaces: M.A.N. 81.084.050.017; Donaldson
 P782937; Fleetguard AF25896
O.D.: 6 3/32 (154.8)
I.D.: 5 11/32 (135.7) One End
Height: 16 (406.4)
I.Gskt: [1] Included

CA5369



Channel Flow Air Element
Fits: Ford Super Duty Trucks with V8-391
 (6.4L) Turbo Diesel Engine
Replaces: Ford 7C3Z-9601-B; Motorcraft
 FA1886; Donaldson P613522
O.D.: 6 1/32 (153.2) to 11 7/8 (310.6)
Height: 8 23/32 (221.5)
A. Gskt:
 [1] Included

PA5363



Cab Air Element
Fits: Caterpillar Loaders
Replaces: Caterpillar 170-7272;
 Donaldson P609444
Length: 15 5/8 (396.9)
Width: 10 1/32 (254.8)
Height: 1 1/32 (26.2)
A. Gskt: [1] Attached

CA5370



Channel Flow Air Element
Fits: Chevrolet Express Van, GMC Savana
Replaces: General Motors 15102546
O.D.: 5 31/32 (151.6) to 10 29/32 (277.0)
Height: 6 9/32 (159.5)
A. Gskt: [1] Included

Measurements Are Shown In Inches And (Millimeters)

WARNING: These products can expose you to chemicals, including Diisononyl Phthalate, Carbon black extracts, Nickel, 1,3 Butadiene, Ethylene Oxide, Epichlorohydrin, which are known to the State of California to cause cancer, and Bisphenol, Ethylene Glycol, Ethylene Oxide, 1,3 Butadiene, Epichlorohydrin, which are known to the State of California to cause birth defects or other reproductive harm. For more information go to www.P65Warnings.ca.gov.

BA5371



Desiccant Air Dryer Spin-on
Fits: Haldex Pure Air Plus DA33100, DA33105, DA33110, DA33200 Air Dryers
Replaces: Haldex DA33120
Thread: 2 1/2 -12
O.D.: 5 7/32 (132.6)
Height: 6 5/8 (168.3)
I.Gskt: [1] Included

BA5372



Desiccant Air Dryer
Contains: [4] Bolts
 [4] Lock Washers
 Grease Tube
Fits: Freightliner FLD Trucks
Replaces: Bendix 103981, 104358
O.D.: 4 17/32 (115.1)
 Lid 5 27/32 (148.4)
Height: 9 23/32 (246.9)
O-Ring: [1] Included

BA5373



Desiccant Air Dryer Spin-on
Contains: Grease Tube
Fits: Ford, Freightliner, Hino, Kenworth, Peterbilt Trucks
Replaces: Bendix 065624, 109493
Thread: 1 1/4 -17
O.D.: 7 9/32 (184.9)
 Flange 8 3/8 (212.7)
Height: 7 17/32 (191.3)
O-Ring: [2] Attached, [2] Included

BA5374



Desiccant Air Dryer Spin-on
Fits: Blue Bird, Kassbohrer, Setra Buses; DAF, E.R.F., Freightliner, IHC, Iveco, Kenworth, Mack, M.A.N., Mercedes-Benz, Peterbilt, R.V.I., Sterling, Volvo Trucks; Liebherr Cranes
Replaces: Caterpillar 2032389; Iveco 2992261; Ford 4C452A131AA; General Motors 89040662; Hengst T250W; Mann & Hummel TB1374x
Thread: M39 x 1.5
O.D.: 5 1/2 (139.7)
Height: 6 9/16 (167.5)
I.Gskt: [1] Included
O-Ring: [1] Included
Related To: BA5379 (Coalescer Version)

BA5375



Desiccant Air Dryer Spin-on
Fits: R.V.I., Scania Trucks
Replaces: Scania 1384549, 1455253
Thread: 1 1/4 -11 BSP-PL
O.D.: 5 1/2 (139.7)
Height: 6 31/32 (177.0)
I.Gskt: [1] Included
O-Ring: [1] Included
Related To: BA5378 (Coalescer Version)

BA5376



Desiccant Air Dryer Spin-on
Fits: Van Hool CL915, CL916 Buses with DAF Engines
Replaces: DAF 1391510; Hengst T200W
Thread: M41 x 1.5
O.D.: 5 1/2 (139.7)
Height: 5 15/32 (138.9)
I.Gskt: [1] Included
O-Ring: [1] Included
Related To: BA5284 (Coalescer Version)

BA5377



Desiccant Air Dryer
Contains: Threaded Stud: 5/8-11
 Grease Tube
Fits: Blue Bird, Thomas Buses; Autocar, Capacity, Freightliner, IHC, Kenworth, Mack, Oshkosh, Peterbilt, Sterling, Western Star Trucks
Replaces: Bendix 107794, 107796
O.D.: 4 17/32 (115.1)
 Lid 5 27/32 (148.4)
Height: 10 23/32 (272.3)
O-Ring: [2] Included

BA5378



Coalescer Air Dryer Spin-on
Fits: Scania Trucks
Replaces: Scania 1774598; Donaldson P783753
Thread: 1 1/4 -11 BSP-PL
O.D.: 5 11/32 (135.7)
Height: 7 (177.8)
I.Gskt: [1] Included
O-Ring: [1] Included
Related To: BA5375 (Desiccant Version)

BA5379



Coalescer Air Dryer Spin-on
Fits: M.A.N. TGA Series, TGM Series, TGS Series, TGX Series Trucks
Replaces: Volvo 20557234, 20972915; DAF 1506635; M.A.N. 81.52108.6025; WABCO R950068
Thread: M39 x 1.5
O.D.: 5 3/8 (136.5)
Height: 6 9/16 (167.5)
I.Gskt: [1] Included
O-Ring: [1] Included
Related To: BA5374 (Desiccant Version)

RS5387 KIT



Radial Seal Air Element with Lid
Contains: Plastic lid with dump valve.
Fits: Thermo King Refrigeration Units
Replaces: Thermo King 11-9300
Element
O.D.: 5 (127.0)
I.D.: 1 29/32 (48.4) One End
Height: 9 29/32 (251.6)

PA5388



Air Element with Lid
Fits: Case-International, New Holland Tractors
Replaces: Case 1931168; Donaldson P778702; Fleetguard AF25342
O.D.: 6 3/32 (154.8)
 Lid 8 3/8 (212.7)
I.D.: 19/32 (15.1) & 3 15/32 (88.1)
Height: 13 1/2 (342.9)
A. Gskt: [1] Attached
F. Gskt: [1] Included, [1] Wing Nut

RS5389-FN



Radial Seal Outer Air Element with Fins
Fits: International WorkStar Trucks
Use With: RS4863
Replaces: International 3551816-C1
O.D.: 12 1/16 (306.4)
 Fins 13 5/16 (338.1)
I.D.: 9 7/8 (250.8) One End
Height: 16 1/32 (407.2)

Measurements Are Shown In Inches And (Millimeters)

WARNING: These products can expose you to chemicals, including Diisononyl Phthalate, Carbon black extracts, Nickel, 1,3 Butadiene, Ethylene Oxide, Epichlorohydrin, which are known to the State of California to cause cancer, and Bisphenol, Ethylene Glycol, Ethylene Oxide, 1,3 Butadiene, Epichlorohydrin, which are known to the State of California to cause birth defects or other reproductive harm. For more information go to www.P65Warnings.ca.gov.

RS5390 Radial Seal Air Element
Contains: Flame Retardant Media
Fits: R.V.I., Volvo Trucks
Replaces: Volvo 20732726; R.V.I. 5001865723; Donaldson P780622, P785522, Fleetguard AF26244
O.D.: 12 9/32 (311.9)
I.D.: 6 31/32 (177.0) One End
Height: 18 11/32 (465.9)
Related To: RS3727 (Standard Media Version)



RS5397 Radial Seal Outer Air Element
Fits: Case-International, New Holland Tractors
Use With: RS5398
Replaces: Case 82027573, 82034433, 82034434, 82034440; New Holland 82027573, 82034433, 82034434, 82034440
O.D.: 9 7/8 (250.8)
I.D.: 5 5/16 (134.9) One End
Height: 17 3/16 (436.6)



RS5391 Radial Seal Air Element
Replaces: Iveco 8041419
O.D.: 9 1/2 (241.3)
I.D.: 4 7/8 (123.8) One End
Height: 19 1/2 (495.3)



RS5398 Radial Seal Inner Air Element
Fits Inside: RS5397
Fits: Case, New Holland Tractors
Replaces: Case 82034435, 82034436, 82027574; New Holland 82034435, 82034436, 82027574
O.D.: 5 15/32 (138.9)
I.D.: 4 1/2 (114.3) One End
Height: 16 19/32 (421.5)



RS5392 Radial Seal Inner Air Element
Fits Inside: RS3506, RS3506XP
Fits: John Deere Feller Bunchers, Loaders
Replaces: John Deere F435742
O.D.: 5 29/32 (150.0)
I.D.: 4 3/8 (111.1) One End
Height: 15 23/32 (399.3)



PA5399 Cab Air Element
Fits: Case, New Holland Tractors
Replaces: Case 87302687; New Holland 87302687
Length: 14 31/32 (380.2)
Width: 5 1/8 (130.2)
Height: 1 31/32 (50.0)



PA5393 Foam Cab Air Element
Fits: Sterling Trucks
Replaces: Ford F6HZ-19N619-BA
Length: 5 27/32 (148.4)
Width: 4 17/32 (115.1)
Height: 1 (25.4)

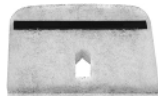

PA5400 Cab Air Element with Foam
Fits: Case-International, New Holland Tractors
Replaces: Case 87311194; New Holland 87311194
Length: 14 31/32 (380.2)
Width: 5 1/8 (130.2)
Height: 2 1/8 (54.0)



RS5395-FN Radial Seal Outer Air Element with Fins
Fits: ASV PT70, PT80 Loaders
Use With: RS3709
Replaces: Donaldson P601437
O.D.: 6 7/8 (174.6)
 Fins 8 3/8 (212.7)
I.D.: 3 1/8 (79.4) One End
Height: 15 13/32 (391.3)



PA5401 Cab Air Element
Replaces: J.C. Bamford 33/125629
Length: 17 1/32 (432.6)
Width: 2 7/8 (73.0)
Height: 1 7/8 (47.6)
A. Gskt: [1] Attached



PA5396 Cab Air Element with Foam
Notes: Uses 2 filters per application.
Fits: Case-International, New Holland Tractors
Replaces: Case 82022328, 820223280, 82034664; New Holland 82022328, 820223280, 82034664
Length: 21 21/32 (550.1)
Width: 3 15/16 (100.0)
Height: 2 1/2 (63.5)
A. Gskt: [1] Attached



PA5403 Cab Air Element
Fits: Case-International Tractors
Replaces: Case 82029888, 82034665, 82034663; New Holland 82029888, 82034665, 82034663
Length: 8 3/16 (208.0)
Width: 4 9/16 (115.9)
Height: 1 13/16 (46.0)



PA5404 Cab Air Element
Fits: Case-International, New Holland Tractors
Replaces: Case C001723, C001896, 82034661, 87385322; New Holland C001723, C001896, 82034661, 87385322
Length: 20 15/32 (519.9)
Width: 4 3/32 (104.0)
Height: 2 (50.8)
A. Gskt: [1] Attached



PA5405 Cab Air Element
Replaces: J.C. Bamford 30/925759
Length: 11 11/32 (288.1)
Width: 3 15/32 (88.1)
Height: 25/32 (19.8)
A. Gskt: [1] Attached



Measurements Are Shown In Inches And (Millimeters)

WARNING: These products can expose you to chemicals, including Diisononyl Phthalate, Carbon black extracts, Nickel, 1,3 Butadiene, Ethylene Oxide, Epichlorohydrin, which are known to the State of California to cause cancer, and Bisphenol, Ethylene Glycol, Ethylene Oxide, 1,3 Butadiene, Epichlorohydrin, which are known to the State of California to cause birth defects or other reproductive harm. For more information go to www.P65Warnings.ca.gov.

PA5406-FN



Air Element with Lid & Fins

Replaces: Schmidt 1297503131
O.D.: 8 5/16 (211.1)
I.D.: 3 7/16 (87.3) One End
Height: 11 1/32 (280.2)
A. Gskt: [1] Attached; [1] Wing Nut

PA5412



Inner Air Element

Fits Inside: PA3906
Fits: Mitsubishi Trucks
Replaces: Mitsubishi AE073385, DC073385, ME073385; Donaldson P815403; Fleetguard AF25582M
O.D.: 5 23/32 (145.3)
I.D.: 21/32 (16.7) & 4 19/32 (116.7)
Height: 16 5/8 (422.3)
A. Gskt: [1] Attached
F. Gskt: [1] Metal Washer

PA5407



Air Element

Fits: Citroen, Fiat, Peugeot Automotive
Replaces: Citroen 144499; Fiat 1310636080; Fleetguard AF25296; SF-Filter SL8327
O.D.: 6 3/4 (171.5)
I.D.: 3 11/32 (84.9)
Height: 11 15/32 (291.3)

RS5413



Radial Seal Air Element

Notes: Features recessed closed end.
Contains: Flame Retardant Media
Fits: DAF Trucks
Replaces: DAF 1638054; Donaldson P786443
O.D.: 10 31/32 (278.6)
I.D.: 5 13/16 (147.6) One End
Height: 20 1/32 (508.8)

RS5408



Radial Seal Inner Air Element

Contains: Grease packet
Fits Inside: RS4966
Fits: Volvo Trucks
Replaces: Volvo 3979928; Fleetguard AF26162; Wix Europe 93250E
O.D.: 6 5/8 (168.3)
I.D.: 5 (127.0) One End
Height: 17 5/16 (439.7)

RS5414



Radial Seal Outer Air Element

Fits: John Deere Equipment
Use With: RS5415
Replaces: John Deere AH164062; Donaldson P612469
O.D.: 12 31/32 (329.8)
I.D.: 6 13/16 (173.0) One End
Height: 23 9/32 (591.3)

RS5409



Radial Seal Air Element

Fits: M.A.N. Trucks
Replaces: M.A.N. 81.08405.0022; Donaldson P785002; Fleetguard AF26261
O.D.: 9 3/32 (231.0)
I.D.: 5 7/16 (138.1) One End
Height: 16 5/16 (414.3)

RS5415



Radial Seal Inner Air Element

Fits Inside: RS5414
Fits: John Deere Equipment
Replaces: John Deere AH164063
O.D.: 6 7/8 (174.6)
I.D.: 5 7/16 (138.1) One End
Height: 22 9/16 (573.1)

PA5410-FN



Air Element with Fins

Contains: Flame Retardant Media
O.D.: 4 1/8 (104.8)
 Fins 5 1/8 (130.2)
I.D.: 25/32 (19.8) & 2 1/2 (63.5)
Height: 10 3/8 (263.5)
A. Gskt: [1] Attached
F. Gskt: [1] Metal Washer
Related To: PA1690-FN (Standard Media Version)

CA5416



Channel Flow Air Element

Fits: Hummer H2
Replaces: General Motors 15286805, 88944151; ACDelco A2948C, A3100C
O.D.: 5 31/32 (151.6) to 10 29/32 (277.0)
Height: 7 7/32 (183.4)
A. Gskt: [1] Included

RS5411



Radial Seal Air Element

Replaces: Volvo 3827589; Fleetguard AF26237; Alco MD7580
O.D.: 9 27/32 (250.0)
I.D.: 4 3/4 (120.7) One End
Height: 17 9/16 (446.1)

CA5417



Channel Flow Primary Air Element

Fits: John Deere Tractors
Use With: PA5418
Replaces: John Deere RE196945
O.D.: 9 29/32 (251.6)
Height: 9 1/8 (231.8)
A. Gskt: [1] Included

Measurements Are Shown In Inches And (Millimeters)

WARNING: These products can expose you to chemicals, including Diisononyl Phthalate, Carbon black extracts, Nickel, 1,3 Butadiene, Ethylene Oxide, Epichlorohydrin, which are known to the State of California to cause cancer, and Bisphenol, Ethylene Glycol, Ethylene Oxide, 1,3 Butadiene, Epichlorohydrin, which are known to the State of California to cause birth defects or other reproductive harm. For more information go to www.P65Warnings.ca.gov.

PA5418



Channel Flow Secondary Air Element
Fits: John Deere Sprayers, Tractors
Use With: CA5417
Replaces: John Deere RE181915
O.D.: 9 3/8 (238.1)
Height: 2 3/16 (55.6)
A. Gskt: [1] Included

CA5419



Channel Flow Air Element
Contains: Flame Retardant Media
Fits: Freightliner Business Class M2 Series Trucks
Replaces: Donaldson P605960
O.D.: 11 31/32 (304.0)
 Flange 14 7/8 (377.8)
Height: 8 1/32 (204.0)
A. Gskt: [1] Attached
Related To: CA5368 (Standard Media Version)

CA5420



Channel Flow Air Element
Contains: Flame Retardant Media
Fits: Freightliner Business Class M2 Series Trucks
Replaces: Donaldson P607960; Wix 49959
O.D.: 9 29/32 (251.6)
 Flange 11 21/32 (296.1)
Height: 8 1/32 (204.0)
A. Gskt: [1] Attached
Related To: CA4700 (Standard Media Version)

CA5421



Channel Flow Air Element
Replaces: Volvo 70320440
O.D.: 12 1/32 (305.6)
Height: 8 3/16 (208.0)
A. Gskt: [1] Attached

RS5422



Radial Seal Air Element
Fits: Evobus, Mercedes-Benz/Setra Buses
Replaces: Mercedes-Benz 40941804, A0040941804; Donaldson P783117; Fleetguard AF26172; Hengst E626L
O.D.: 7 11/32 (186.5)
I.D.: 4 5/32 (105.6) One End
Height: 14 1/32 (356.4)

PA5423-FN



Air Element with Fins
Replaces: Case 808039R1; John Deere CM18213; Donaldson P900247; Fleetguard AF25027K
O.D.: 5 3/16 (131.8)
 Fins 6 7/16 (163.5)
I.D.: 5/8 (15.9) & 3 5/8 (92.1)
Height: 11 9/16 (293.7)
A. Gskt: [1] Attached

RS5424



Radial Seal Air Element
Fits: Blue Bird Vision Buses
Replaces: Blue Bird 0061519, 61519, BB0061519; Racor 500353001
O.D.: 9 5/8 (244.5)
I.D.: 4 7/8 (123.8) One End
Height: 11 11/32 (288.1)

PA5425



Air Element with Lid
Replaces: Cummins 3351735; Fleetguard AF25688
O.D.: 11 1/8 (282.6)
 Lid 15 3/32 (383.4)
I.D.: 21/32 (16.7) & 6 23/32 (170.7)
Height: 15 27/32 (402.4)
A. Gskt: [2] Attached

PA5426

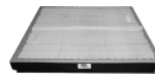

Panel Air Element with Foam Pad and Lift Tabs
Fits: Mercedes-Benz Trucks
Replaces: Mercedes-Benz 40941104, A0040941104; Fleetguard AF25731
Length: 24 29/32 (632.6)
Width: 22 1/2 (571.5)
Height: 3 3/32 (78.6)
A. Gskt: [2] Attached

PA5428

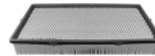

Panel Air Element
Fits: Chevrolet Trucks
Replaces: General Motors 19152817; ACDelco A3102C
Length: 16 11/16 (423.9)
Width: 8 7/8 (225.4)
Height: 2 1/4 (57.2)

RS5429



Radial Seal Outer Air Element
Fits: John Deere, Liebherr, MacDon Equipment
Use With: RS5430
Replaces: Fleetguard AF26124; Wix 49148
O.D.: 10 1/4 (260.4)
I.D.: 6 17/32 (165.9) One End
Height: 20 7/16 (519.1)

RS5430



Radial Seal Inner Air Element
Fits Inside: RS5429
Fits: John Deere, Liebherr, MacDon Equipment
Replaces: Fleetguard AF26125; Wix 49149
O.D.: 5 13/32 (137.3)
 Flange 8 1/32 (204.0)
I.D.: 5 3/16 (131.8) One End
Height: 19 17/32 (496.1)

Measurements Are Shown In Inches And (Millimeters)

WARNING: These products can expose you to chemicals, including Diisononyl Phthalate, Carbon black extracts, Nickel, 1,3 Butadiene, Ethylene Oxide, Epichlorohydrin, which are known to the State of California to cause cancer, and Bisphenol, Ethylene Glycol, Ethylene Oxide, 1,3 Butadiene, Epichlorohydrin, which are known to the State of California to cause birth defects or other reproductive harm. For more information go to www.P65Warnings.ca.gov.

RS5431



Radial Seal Air Element

Fits: DAF Trucks
Replaces: DAF 1433690, 1644642, 1667999, 1672463, APUC543; Alco MD-7622
O.D.: 8 13/32 (213.5)
I.D.: 4 29/32 (124.6) One End
Height: 13 3/8 (339.7)

PA5437



Inner Air Element

Fits Inside: PA5436
Fits: Agco, Challenger, Massey Ferguson Tractors
Replaces: Massey Ferguson 3703704-M91
O.D.: 2 3/8 (60.3)
I.D.: 7/16 (11.1) & 2 (50.8)
Height: 8 7/8 (225.4)

RS5432



Radial Seal Air Element

Fits: Volvo-Penta Generators
Replaces: Deutz 1182786; M.A.N. 83.08405.0001; Volvo 21377909
O.D.: 9 29/32 (251.6)
I.D.: 6 3/16 (157.2) One End
Height: 18 29/32 (480.2)

RS5438



Radial Seal Air Element

Contains: Flame Retardant Media
Fits: M.A.N. TGL Series, TGM Series Trucks
Replaces: M.A.N. 81.08405.0023; Donaldson P785001; Fleetguard AF26262
O.D.: 8 29/32 (226.2)
I.D.: 4 21/32 (118.3) One End
Height: 12 (304.8)
Related To: RS5536 (Standard Media Version)

RS5433



Radial Seal Air Element

Contains: Flame Retardant Media
Fits: DAF, Kenworth Trucks
Replaces: DAF 1668000, 1672464
O.D.: 8 13/32 (213.5)
I.D.: 4 11/16 (119.1) One End
Height: 16 17/32 (419.9)
Related To: RS4970 (Standard Media Version)

RS5440



Radial Seal Air Element

Use With: RS5548
Replaces: Deutz 1182912
O.D.: 9 15/32 (240.5)
I.D.: 5 15/32 (138.9) One End
Height: 18 5/16 (465.1)

RS5434



Radial Seal Air Element

Fits: Isuzu Trucks
Replaces: Isuzu 8-97062-294-0; Donaldson P543614, P828633
O.D.: 9 9/32 (235.7)
I.D.: 5 5/32 (131.0) One End
Height: 11 3/8 (288.9)

RS5441



Radial Seal Air Element

Fits: Nissan Atleon Trucks with Cummins ISB4 Series Engine
Use With: RS5547
Replaces: Nissan 16546-LA40A
O.D.: 9 3/32 (231.0)
I.D.: 5 7/16 (138.1) One End
Height: 16 5/16 (414.3)

RS5435



Radial Seal Air Element

Fits: J.C. Bamford Fastrac Tractors
Replaces: J.C. Bamford 32/210101; Perkins 26510387
O.D.: 8 13/32 (213.5)
I.D.: 4 29/32 (124.6) One End
Height: 15 19/32 (396.1)

RS5442



Radial Seal Outer Air Element

Use With: RS5443
Replaces: Donaldson P601767
O.D.: 9 5/32 (232.6)
I.D.: 4 5/8 (117.5) One End
Height: 13 7/16 (341.3)

PA5436



Outer Air Element

Fits: Challenger, Massey Ferguson Tractors
Use With: PA5437
Replaces: Massey Ferguson 3703703-M91;
 Flange 5 11/16 (144.5)
O.D.: 4 3/32 (104.0)
I.D.: 17/32 (13.5) & 2 1/2 (63.5)
Height: 10 3/8 (263.5)
A. Gskt: [1] Attached
F. Gskt: [1] Included

RS5443



Radial Seal Inner Air Element

Fits Inside: RS5442
Replaces: Donaldson P601774
O.D.: 4 23/32 (119.9)
I.D.: 3 1/4 (82.6) One End
Height: 12 25/32 (324.6)

Measurements Are Shown In Inches And (Millimeters)



WARNING: These products can expose you to chemicals, including Diisononyl Phthalate, Carbon black extracts, Nickel, 1,3 Butadiene, Ethylene Oxide, Epichlorohydrin, which are known to the State of California to cause cancer, and Bisphenol, Ethylene Glycol, Ethylene Oxide, 1,3 Butadiene, Epichlorohydrin, which are known to the State of California to cause birth defects or other reproductive harm. For more information go to www.P65Warnings.ca.gov.

PA5444-FN



Air Element with Fins

Replaces: Foton D136703E; CLARCOR Filtration (China) KQ1317A8
O.D.: 5 1/8 (130.2)
Fins: 6 15/32 (164.3)
I.D.: 3/8 (9.5) & 2 15/32 (62.7)
Height: 6 11/16 (169.9)
A. Gskt: [1] Attached
F. Gskt: [1] Washer

CA5450



Channel Flow Primary Air Element

Fits: Case, Case-IH, J.C. Bamford, John Deere, New Holland Equipment
Use With: PA5451
Replaces: Case 82988916, 87037984, 87356351; J.C. Bamford 32/925682; John Deere FG6340591, RE253518; New Holland 82988916, 87037984, 87356351
O.D.: 5 27/32 (148.4) to 9 13/16 (249.2)
Height: 7 1/8 (181.0)

PA5445



Outer Air Element with Lift Tabs

Fits: Hualing 280HP Heavy Truck
Use With: PA5446
Replaces: CLARCOR Filtration (China) K3250
O.D.: 12 7/8 (327.0)
I.D.: 27/32 (21.4) & 8 11/32 (211.9)
Height: 19 13/32 (492.9)

PA5451



Channel Flow Secondary Air Element with Pull Handle

Fits: Case, Case-IH, J.C. Bamford, John Deere, New Holland Equipment
Use With: CA5450
Replaces: Case 82988917, 87037985, 87356353; New Holland 82988917, 87037985, 87356353; J.C. Bamford 32/925683; John Deere FG6340592, RE253519
O.D.: 4 1/4 (108.0) to 8 1/4 (209.6)
Height: 2 9/16 (65.1)
A. Gskt: [1] Attached

PA5446



Inner Air Element

Fits Inside: PA5445
Replaces: CLARCOR Filtration (China) K3250
O.D.: 8 9/32 (210.3)
I.D.: 29/32 (23.0) & 7 3/32 (180.2)
Height: 17 17/32 (445.3)
A. Gskt: [1] Attached
F. Gskt: [1] Washer

RS5452



Radial Seal Outer Air Element

Fits: Mercedes-Benz Buses, Trucks
Replaces: Mercedes-Benz A3740947104; Reytor IT3095
O.D.: 10 29/32 (277.0)
I.D.: 6 25/32 (172.2) One End
Height: 16 1/2 (419.1)

RS5447



Radial Seal Outer Air Element

Fits: Dynapac Rollers
Replaces: Dynapac 909270; Donaldson P781470; Fleetguard AF25612
O.D.: 8 5/32 (207.2)
I.D.: 4 3/16 (106.4) One End
Height: 20 5/8 (523.9)

RS5453



Radial Seal Inner Air Element

Fits: Mercedes-Benz Buses
Replaces: Mercedes-Benz A3740947204; Reytor IT3095S
O.D.: 6 1/4 (158.8)
I.D.: 5 1/4 (133.4) One End
Height: 15 5/32 (385.0)

RS5448



Radial Seal Inner Air Element

Fits: Dynapac Rollers
Replaces: Dynapac 909271; Donaldson P781471
O.D.: 4 1/4 (108.0)
I.D.: 3 7/16 (87.3) One End
Height: 19 15/16 (506.4)

PA5454



Panel Air Element

Contains: Flame Retardant Media
Fits: Waukesha VHP 12, 16 Cylinder Stationary Engines
Replaces: Waukesha 214275A
Length: 25 1/4 (641.4)
Width: 19 1/4 (489.0)
Height: 3 3/4 (95.3)
A. Gskt: [2] Attached

RS5449



Radial Seal Air Element

Fits: Caterpillar Generator Sets; Caterpillar, Lister-Petter Industrial Engines
Replaces: Caterpillar 246-5011; Lister 75727890; Perkins 135326205
O.D.: 4 1/8 (104.8)
I.D.: 2 7/16 (61.9) One End
Height: 10 3/4 (273.1)

RS5455



Radial Seal Outer Air Element

Fits: Case-International Equipment; New Holland Tractors
Use With: RS5456
Replaces: Case 367349A1, 87409371
O.D.: 12 1/8 (308.0)
I.D.: 8 1/2 (215.9) One End
Height: 13 3/4 (349.3)

Measurements Are Shown In Inches And (Millimeters)

WARNING: These products can expose you to chemicals, including Diisononyl Phthalate, Carbon black extracts, Nickel, 1,3 Butadiene, Ethylene Oxide, Epichlorohydrin, which are known to the State of California to cause cancer, and Bisphenol, Ethylene Glycol, Ethylene Oxide, 1,3 Butadiene, Epichlorohydrin, which are known to the State of California to cause birth defects or other reproductive harm. For more information go to www.P65Warnings.ca.gov.

RS5456



Radial Seal Inner Air Element
Fits Inside: RS5455
Fits: Case-International,
 New Holland Equipment
Replaces: Case 367350A1, 87409407;
 Fleetguard AF25711
O.D.: 8 1/8 (206.4)
I.D.: 6 (152.4) One End
Height: 12 31/32 (329.4)

RS5462



Radial Seal Inner Air Element
Contains: [1] Grease packet
Fits Inside: RS5461
Fits: J.C. Bamford Equipment
Replaces: J.C. Bamford 32/210002
O.D.: 7 5/32 (181.8)
I.D.: 5 1/2 (139.7) One End
Height: 19 1/16 (484.2)

PA5457

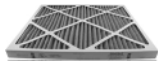

Wire Supported Cotton Polyester Industrial Air Element
Replaces: Airguard DP40-204
Length: 24 1/2 (622.3)
Width: 19 1/2 (495.3)
Height: 1 3/4 (44.5)

PA5463



Outer Air Element
Use With: PA5464
Replaces: Cummins 3237954;
 Fleetguard AF25804
O.D.: 14 (355.6)
 Boot 14 13/16 (376.2)
I.D.: 21/32 (16.7) & 9 19/32 (243.7)
Height: 26 1/32 (661.2)
A. Gskt: [2] Attached
F. Gskt: [1] Included, [1] Wing Nut

RS5458



Radial Seal Air Element
Fits: Blue Bird Vision Buses
Replaces: Blue Bird 87782
O.D.: 9 31/32 (253.2)
 Lid 11 1/2 (292.1)
I.D.: 4 13/16 (122.2) One End
Height: 11 3/8 (288.9)

PA5464



Inner Air Element
Fits Inside: PA5463
Replaces: Cummins 4055279; Donaldson
 P500922; Fleetguard AF25803
O.D.: 8 13/32 (213.5)
I.D.: 11/16 (17.5) & 6 3/16 (157.2)
Height: 16 3/4 (425.5)
A. Gskt: [1] Attached
F. Gskt: [1] Included, [1] Wing Nut

RS5459



Radial Seal Outer Air Element
Fits: Volvo Dump Trucks, Excavators, Loaders
Use With: RS5460
Replaces: Volvo 11110531, 11110532,
 15193232
O.D.: 14 7/32 (361.2)
I.D.: 8 15/16 (227.0) One End
Height: 22 7/16 (569.9)

PA5465



Air Element
Replaces: Perkins SEV5514
O.D.: 12 23/32 (323.1)
I.D.: 1 1/16 (27.0) & 9 9/32 (235.7)
Height: 22 3/16 (563.6)

RS5460



Radial Seal Inner Air Element
Fits Inside: RS5459
Fits: Volvo Dump Trucks, Excavators, Loaders
Replaces: Volvo 11110533;
 Fleetguard AF26491
O.D.: 9 3/32 (231.0)
I.D.: 6 7/8 (174.6) One End
Height: 22 3/32 (561.2)

PA5467



Outer Air Element
Use With: PA5468
Replaces: Cummins 3814695;
 Fleetguard AF25910
O.D.: 7 25/32 (197.6)
I.D.: 11/32 (8.7) & 4 11/32 (110.3)
Height: 12 3/32 (307.2)
A. Gskt: [1] Attached
F. Gskt: [1] Included

RS5461



Radial Seal Outer Air Element
Fits: J.C. Bamford Equipment
Use With: RS5462
Replaces: J.C. Bamford 32/210001;
 Coopers AEM2756
O.D.: 9 27/32 (250.0)
I.D.: 7 13/32 (188.1) One End
Height: 19 21/32 (499.3)

PA5468



Inner Air Element
Fits Inside: PA5467
Replaces: Cummins 3814696;
 Fleetguard AF25911
O.D.: 4 3/32 (104.0)
I.D.: 21/32 (16.7) & 3 17/32 (89.7)
Height: 10 29/32 (277.0)
A. Gskt: [1] Attached
F. Gskt: [1] Included

Measurements Are Shown In Inches And (Millimeters)

! **WARNING:** These products can expose you to chemicals, including Diisononyl Phthalate, Carbon black extracts, Nickel, 1,3 Butadiene, Ethylene Oxide, Epichlorohydrin, which are known to the State of California to cause cancer, and Bisphenol, Ethylene Glycol, Ethylene Oxide, 1,3 Butadiene, Epichlorohydrin, which are known to the State of California to cause birth defects or other reproductive harm. For more information go to www.P65Warnings.ca.gov.

PA5469



Outer Air Element

Fits: Guangxi Liugong Machinery Co., Ltd. Loaders, Rollers; Xuzhou Construction Machinery Group Loaders; Zhengzhou Yutong Group Co., Ltd. Buses
Use With: PA5521
Replaces: Sinotruck WG9719190001; Fleetguard Shanghai A749-020
O.D.: 12 (304.8)
I.D.: 7 1/16 (11.1) & 7 11/16 (195.3)
Height: 18 11/16 (474.7)
A. Gskt: [1] Attached

RS5470



Radial Seal Outer Air Element

Fits: John Deere Combines, Cotton Pickers
Use With: RS5471
Replaces: John Deere AH212294; Donaldson P618930
O.D.: 11 11/16 (296.9)
I.D.: 7 27/32 (199.2) One End
Height: 24 5/8 (625.5)

RS5471



Radial Seal Inner Air Element

Fits Inside: RS5470, RS5472
Fits: John Deere Combines, Cotton Pickers
Replaces: John Deere AH212294; Donaldson P618932; Fleetguard AF26438
O.D.: 7 1/16 (179.4)
I.D.: 6 13/32 (162.7) One End
Height: 22 1/2 (571.5)
O-Ring: [1] Attached

RS5472



Radial Seal Outer Air Element

Fits: John Deere Equipment
Use With: RS5471
Replaces: John Deere AH222225; Donaldson P618931
O.D.: 12 23/32 (323.1)
I.D.: 7 13/16 (198.4) One End
Height: 24 5/8 (625.5)

PA5473



Outer Air Element

Fits: Tata Engines
Use With: PA5474
Replaces: Tata Cummins 252509140134; Fleetguard AF25884
O.D.: 7 25/32 (197.6)
I.D.: 11/32 (8.7) & 3 15/16 (100.0)
Height: 14 25/32 (375.4)
A. Gskt: [1] Attached
F. Gskt: [1] Included

PA5474



Inner Air Element

Fits Inside: PA5473
Replaces: Tata Cummins 252509140133; Donaldson P500957; Fleetguard India AF25885
O.D.: 3 3/4 (95.3) to 4 1/4 (108.0)
I.D.: 11/16 (17.5) & 3 1/2 (88.9)
Height: 14 9/32 (362.7)
A. Gskt: [1] Attached

PA5475



Cabin Air Element

Fits: Iveco Light-Duty Trucks
Replaces: Iveco 3802821; Hengst E2593LI; Mahle LA439; Mann & Hummel CU2952
Length: 11 17/32 (292.9)
Width: 7 9/16 (192.1)
Height: 1 3/16 (30.2)
A. Gskt: [2] Attached

PA5476



Cab Air Element

Contains: Charcoal Impregnated Media for Odor Control
Fits: Iveco Trucks
Replaces: Iveco 2994583; Hengst E1908LC; Mann & Hummel CUK4594
Length: 17 21/32 (448.5)
Width: 8 1/8 (206.4)
Height: 1 (25.4)
Related To: PA5366 (Standard Media)

PA5477



Cab Air Element

Contains: Charcoal Impregnated Media for Odor Control
Fits: M.A.N. Trucks
Replaces: M.A.N. 81.61910.0019; Donaldson P786092; Hengst E954LC; Mahle LAK154; Mann & Hummel CUK4795
Length: 18 19/32 (472.3)
Width: 7 7/16 (188.9)
Height: 2 13/16 (71.4)
A. Gskt: [1] Attached
Related To: PA4955 (Standard Media Version)

RS5478-FN



Radial Seal Outer Air Element with Fins

Fits: Donaldson FRG09 Housings
Use With: RS5479
Replaces: Donaldson P601280; Wix 49280
O.D.: 7 (177.8)
 Fins 8 1/2 (215.9)
I.D.: 4 (101.6) One End
Height: 16 7/16 (417.5)

RS5479



Radial Seal Inner Air Element

Fits Inside: RS5478-FN
Fits: Donaldson FRG09 Housings
Replaces: Donaldson P601286
O.D.: 4 1/8 (104.8)
I.D.: 3 7/16 (87.3) One End
Height: 15 9/16 (395.3)

PA5480



Outer Air Element with Lift Bars

Use With: PA5481
Replaces: Cummins 4055592; Fleetguard AF25906
O.D.: 14 1/4 (362.0)
I.D.: 21/32 (16.7) & 9 15/16 (252.4)
Height: 24 1/2 (622.3)
A. Gskt: [1] Attached
F. Gskt: [1] Included, [1] Wing Nut

Measurements Are Shown In Inches And (Millimeters)

WARNING: These products can expose you to chemicals, including Diisononyl Phthalate, Carbon black extracts, Nickel, 1,3 Butadiene, Ethylene Oxide, Epichlorohydrin, which are known to the State of California to cause cancer, and Bisphenol, Ethylene Glycol, Ethylene Oxide, 1,3 Butadiene, Epichlorohydrin, which are known to the State of California to cause birth defects or other reproductive harm. For more information go to www.P65Warnings.ca.gov.

PA5481



Inner Air Element

Fits Inside: PA5480
Replaces: Cummins 4055591;
 Fleetguard AF25907
O.D.: 9 5/8 (244.5)
I.D.: 13/16 (20.6) & 8 7/16 (214.3)
Height: 22 1/4 (565.2)
A. Gskt: [1] Attached
F. Gskt: [1] Included, [1] Wing Nut

PA5487



Outer Air Element

Replaces: Ashok Leyland X3973800;
 Fleetguard AF26010
O.D.: 12 3/32 (307.2)
I.D.: 5/8 (15.9) & 7 11/16 (195.3)
Height: 18 7/16 (468.3)
A. Gskt: [1] Attached
F. Gskt: [1] Included

PA5482

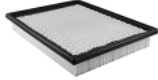

Cab Air Element

Fits: Komatsu Dump Trucks, Loaders
Replaces: Komatsu 427-07-22120
Length: 12 9/32 (311.9)
Width: 10 1/16 (255.6)
Height: 1 13/16 (46.0)

RS5488



Radial Seal Air Element

Use With: RS5549
Replaces: M.A.N. 81.08405.0029;
 Scania 1510905; Fleetguard AF26677
O.D.: 9 15/16 (252.4)
I.D.: 6 (152.4) One End
Height: 20 29/32 (531.0)

RS5483



Radial Seal Air Element

Fits: Kassbohrer Buses
Replaces: EvoBus 8.319.150.192.0; Irisbus
 5010423885; Donaldson P780731;
 Fleetguard AF25626
O.D.: 11 27/32 (300.8)
I.D.: 6 9/16 (166.7) One End
Height: 13 1/16 (331.8)

RS5489



Radial Seal Outer Air Element

Use With: RS5490
Replaces: Donaldson P785589;
 Sandvik 55089266
O.D.: 8 (203.2)
I.D.: 4 3/8 (111.1) One End
Height: 16 21/32 (423.1)

RS5484



Radial Seal Air Element

Fits: Kassbohrer Buses
Replaces: EvoBus 8.319.147.187,
 8.319.147.187.0; Mercedes-Benz 40942204,
 A0040942204; Donaldson P778924;
 Fleetguard AF25522
O.D.: 11 27/32 (300.8)
I.D.: 6 9/16 (166.7) One End
Height: 18 17/32 (470.7)

RS5490



Radial Seal Inner Air Element

Fits Inside: RS5489
Replaces: Donaldson P785389
O.D.: 4 1/16 (103.2)
I.D.: 3 5/16 (84.1) One End
Height: 14 3/8 (365.1)

PA5485-FN



Outer Air Element with Fins

Use With: PA5486
Replaces: Arrow Filter 13023273
O.D.: 7 15/16 (201.6)
 Fins 10 (254.0)
I.D.: 1/2 (12.7) & 4 31/32 (126.2)
Height: 15 3/4 (400.1)
A. Gskt: [1] Attached
F. Gskt: [1] Washer

PA5491



Air Element

Replaces: Caterpillar 7C1572
O.D.: 10 19/32 (269.1)
I.D.: 6 (152.4) One End
Height: 8 3/8 (212.7)

PA5486



Inner Air Element

Fits Inside: PA5485-FN
Replaces: Arrow Filter 13023273
O.D.: 4 9/16 (115.9)
 Flange 5 3/4 (146.1)
I.D.: 1/2 (12.7) & 3 7/16 (87.3)
Height: 14 23/32 (373.9)
A. Gskt: [1] Attached
F. Gskt: [1] Included

PA5492



Cab Air Element

Contains: Charcoal Impregnated Media for
 Odor Control
Fits: Mercedes-Benz Trucks, Vans
Replaces: Mercedes-Benz 8301318, 8303418,
 A0008301318, A0008303408
Length: 14 7/8 (377.8)
Width: 5 1/2 (139.7)
Height: 1 9/16 (39.7)
A. Gskt: [1] Attached
Related To: PA4912 (Standard Media Version)

Measurements Are Shown In Inches And (Millimeters)





WARNING: These products can expose you to chemicals, including Diisononyl Phthalate, Carbon black extracts, Nickel, 1,3 Butadiene, Ethylene Oxide, Epichlorohydrin, which are known to the State of California to cause cancer, and Bisphenol, Ethylene Glycol, Ethylene Oxide, 1,3 Butadiene, Epichlorohydrin, which are known to the State of California to cause birth defects or other reproductive harm. For more information go to www.P65Warnings.ca.gov.

PA5493 Cab Air Element

Fits: Scania Serie G, Serie P, Serie R Trucks
Replaces: Scania 1770813, 1913500; Fleetguard AF27692
Length: 14 23/32 (373.9)
Width: 5 5/16 (134.9)
Height: 25/32 (19.8)
A. Gskt: [1] Attached

CA5500 Channel Flow EXO Air Element

Fits: Kenworth Trucks
Replaces: Kenworth P611696; Donaldson P616056
O.D.: 11 3/16 (284.2) to 17 11/32 (440.5)
Height: 9 27/32 (250.0)

PA5494 Foam Cab Air Element

Fits: Freightliner Trucks
Replaces: Freightliner 91595, BOA91595; Alliance ABP/N10G-91595
Length: 7 7/8 (200.0)
Width: 6 5/16 (160.3)
Height: 5/8 (15.9)

PA5503 Outer Air Element

Fits: Guangxi Liugong Machinery Company, LTD Equipment
Use With: PA5504
Replaces: Dongfeng Motor Corp. 1109.6B-020-B; Fleetguard AF25268
O.D.: 8 9/32 (210.3)
I.D.: 11/32 (8.7) & 5 5/32 (131.0)
Height: 14 23/32 (373.9)
A. Gskt: [1] Attached

PA5495 Foam Cab Air Element

Replaces: Freightliner 803190015900, BOA803190015900, ZGG20010; Alliance ABPN10G803190015900; Donaldson P614225
Length: 8 1/2 (215.9)
Width: 7 5/8 (193.7)
Height: 3/4 (19.1)

PA5504 Inner Air Element

Fits Inside: PA5503
Fits: Guangxi Liugong Machinery Company, LTD Equipment
Replaces: Dongfeng Motor Corp. 1109.6B-030-B; Fleetguard AF25269
O.D.: 4 7/8 (123.8)
I.D.: 23/32 (18.3) & 3 3/8 (85.7)
Height: 14 11/32 (364.3)
A. Gskt: [1] Attached

PA5496 Outer Air Element

Fits: Guangxi Liugong Machinery Company, LTD Equipment
Use With: PA5497
Replaces: Dongfeng Motor Corp. 1109N-020; Fleetguard AF25270; Sakura A-8636
O.D.: 9 7/32 (234.2)
I.D.: 15/32 (11.9) & 5 5/16 (134.9)
Height: 16 7/8 (428.6)
A. Gskt: [1] Attached

PA5505 Air Element

Fits: Some MTU 12V2000, 16V2000, 18V2000 Marine Engines
Replaces: Donaldson B120376, ECB120376; Mann & Hummel C311195; SF-Filter SL12942
O.D.: 12 19/32 (319.9)
I.D.: 7 13/16 (198.4) One End
Height: 17 9/16 (446.1)

PA5497 Inner Air Element

Fits Inside: PA5496
Fits: Guangxi Liugong Machinery Company, LTD Equipment
Replaces: Dongfeng Motor Corp. 1109N-030; Fleetguard AF25277; Sakura A-8637
O.D.: 5 3/16 (131.8)
 Flange 5 29/32 (150.0)
I.D.: 15/32 (11.9) & 4 1/32 (102.4)
Height: 16 5/16 (414.3)
A. Gskt: [1] Attached

RS5506 Radial Seal Air Element

Fits: M.A.N. TGL Series, TGM Series Trucks
Replaces: M.A.N. 81.08405.0018; Alco MD-7664; Donaldson P788809
O.D.: 10 (254.0)
I.D.: 5 1/32 (127.8) One End
Height: 18 (457.2)

PA5498 Outer Air Element

Fits: Zhengzhou Yutong Group Company, LTD Buses
Use With: PA5499
Replaces: Dongfeng Motor Corp. 1109-00135; Fleetguard AF25452
O.D.: 11 (279.4)
I.D.: 23/32 (18.3) & 6 1/2 (165.1)
Height: 20 3/16 (512.8)
A. Gskt: [1] Attached

RS5507 Radial Seal Air Element

Contains: [2] Washers
 [2] Lock Washers
 [2] O-Rings
 [2] Nuts
Fits: Cummins 500KVA Generator with QSX15-C Tier 3 Diesel Engine
Replaces: Cummins 4946497; Fleetguard AF26173
O.D.: 11 31/32 (304.0)
I.D.: 5 27/32 (148.4) One End
Height: 16 1/4 (412.8)

PA5499 Inner Air Element

Fits Inside: PA5498
Fits: Zhengzhou Yutong Group Company, LTD Buses
Replaces: Dongfeng Motor Corp. 1109-00135; Fleetguard AF25453
O.D.: 6 1/8 (155.6)
I.D.: 23/32 (18.3) & 5 7/32 (132.6)
Height: 19 (482.6)
A. Gskt: [1] Attached

Measurements Are Shown In Inches And (Millimeters)

 **WARNING:** These products can expose you to chemicals, including Diisononyl Phthalate, Carbon black extracts, Nickel, 1,3 Butadiene, Ethylene Oxide, Epichlorohydrin, which are known to the State of California to cause cancer, and Bisphenol, Ethylene Glycol, Ethylene Oxide, 1,3 Butadiene, Epichlorohydrin, which are known to the State of California to cause birth defects or other reproductive harm. For more information go to www.P65Warnings.ca.gov.

RS5508



Radial Seal Air Element
Replaces: Iveco 42537392, 500394100;
 Donaldson P784456
O.D.: 10 17/32 (267.5)
I.D.: 6 19/32 (167.5) One End
Height: 20 13/16 (528.6)
Related To: RS5358 (Flame Retardant Media)

RS5509



Radial Seal Outer Air Element
Fits: John Deere 824K, 844J, 844K Loaders
Use With: RS5510
Replaces: John Deere AT311066
O.D.: 12 3/32 (307.2)
I.D.: 7 11/16 (195.3) One End
Height: 20 9/16 (522.3)

RS5510



Radial Seal Inner Air Element
Fits Inside: RS5509
Fits: John Deere 824K, 844J, 844K Loaders
Replaces: John Deere AT311067
O.D.: 7 5/32 (181.8)
I.D.: 5 27/32 (148.4) One End
Height: 19 21/32 (499.3)

PA5511

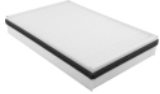

Cab Air Element
Fits: Fendt Tractors
Replaces: Fendt H931812140511
Length: 11 13/16 (300.0)
Width: 7 15/32 (189.7)
Height: 1 25/32 (45.2)
A. Gskt: [1] Attached

PA5512

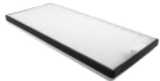

Panel Air Element
Replaces: Liebherr 10287303
Length: 16 (406.4)
Width: 7 1/16 (179.4)
Height: 1 3/16 (30.2)
A. Gskt: [1] Attached

CA5514



Channel Flow Primary Air Element
Fits: Agco, Caterpillar, Challenger, John Deere, Massey Ferguson Equipment; Ford, IHC Trucks
Use With: PA5515
Replaces: Agco 4286473M2; Caterpillar 3045632; International 2591005C1; John Deere F071150
O.D.: 8 1/4 (209.6) to 13 3/8 (339.7)
Height: 7 7/16 (188.9)

PA5515



Channel Flow Secondary Air Element with Pull Handle
Fits: Ag-Chem, Agco, Caterpillar, Challenger, J.C. Bamford, John Deere, Massey Ferguson, Valtra Equipment; IHC Trucks
Use With: CA5514, CA5788
Replaces: Agco 4286474M1; Caterpillar 3045633; International 2591007C1; J.C. Bamford 32/925753; John Deere F071151
O.D.: 7 1/2 (190.5) to 12 13/16 (325.4)
Height: 2 5/16 (58.7)
A. Gskt: [1] Attached

PA5516

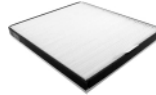

Cab Air Element
Replaces: Liebherr 10323466
Length: 10 5/8 (269.9)
Width: 9 1/16 (230.2)
Height: 1 3/16 (30.2)
A. Gskt: [1] Attached

RS5517



Radial Seal Outer Air Element
Contains: Flame Retardant Media
Use With: RS3545
Replaces: Donaldson P604996; Komatsu 3EC02A541E; Toyota 17741-U3330-71
O.D.: 6 1/2 (165.1)
I.D.: 3 9/16 (90.5) One End
Height: 14 1/32 (356.4)
Related To: RS3544 (Standard Media Version)

PA5518



Air Element
Replaces: CLARCOR Filtration (China) KY1530-2000; Huafeng Power 88290006013
O.D.: 6 1/8 (155.6)
I.D.: 9/16 (14.3) & 3 3/8 (85.7)
Height: 11 15/16 (303.2)
A. Gskt: [1] Attached

PA5519



Air Element
Replaces: CLARCOR Filtration (China) KY1833-2000; Foton Lovol FT75011B010
O.D.: 7 3/32 (180.2)
I.D.: 1/2 (12.7) & 3 7/8 (98.4)
Height: 13 1/2 (342.9)
A. Gskt: [1] Attached

PA5521



Inner Air Element
Fits Inside: PA5469
Replaces: CLARCOR Filtration (China) WG9719190001; Fleetguard Shanghai A749-030
O.D.: 7 1/4 (184.2)
I.D.: 9/16 (14.3) & 6 1/16 (154.0)
Height: 17 5/16 (439.7)
A. Gskt: [1] Attached

Measurements Are Shown In Inches And (Millimeters)

WARNING: These products can expose you to chemicals, including Diisononyl Phthalate, Carbon black extracts, Nickel, 1,3 Butadiene, Ethylene Oxide, Epichlorohydrin, which are known to the State of California to cause cancer, and Bisphenol, Ethylene Glycol, Ethylene Oxide, 1,3 Butadiene, Epichlorohydrin, which are known to the State of California to cause birth defects or other reproductive harm. For more information go to www.P65Warnings.ca.gov.

PA5522



Outer Air Element

Use With: PA5523
Replaces: CLARCOR Filtration (China)
 KW2036B17-1000; FAW Group 11096B030
O.D.: 7 13/16 (198.4)
I.D.: 3/8 (9.5) & 4 1/8 (104.8)
Height: 14 15/32 (367.5)
A. Gskt: [1] Attached

PA5528



Outer Air Element

Use With: PA5529
Replaces: CLARCOR Filtration (China)
 KX2640-2000; Shantui 612600110540
O.D.: 10 7/32 (259.6)
I.D.: 1/2 (12.7) & 6 1/2 (165.1)
Height: 16 1/4 (412.8)
A. Gskt: [1] Attached

PA5523



Inner Air Element

Fits Inside: PA5522
Replaces: CLARCOR Filtration (China)
 KW2036B17-2000; FAW Group 11096B030
O.D.: 3 29/32 (99.2)
I.D.: 5/8 (15.9) & 3 1/2 (88.9)
Height: 14 3/8 (365.1)
A. Gskt: [1] Attached

PA5529



Inner Air Element

Fits Inside: PA5528
Replaces: CLARCOR Filtration (China)
 KX2640-3000; Shantui 612600110540
O.D.: 6 1/4 (158.8)
I.D.: 1/2 (12.7) & 4 7/8 (123.8)
Height: 14 15/32 (367.5)
A. Gskt: [1] Attached

PA5524



Outer Air Element

Use With: PA5525
Replaces: CLARCOR Filtration (China)
 KY2448-2000; Shaanqi Group AZ91121901421;
 Sinotruk AZ91121901421
O.D.: 9 17/32 (242.1)
I.D.: 3/8 (9.5) & 5 1/4 (133.4)
Height: 19 9/16 (496.9)
A. Gskt: [1] Attached

PA5530



Outer Air Element

Use With: PA5531
Replaces: CLARCOR Filtration (China)
 KY2337-2000
O.D.: 8 31/32 (277.8)
I.D.: 3/8 (9.5) & 4 7/16 (112.7)
Height: 15 1/16 (382.6)
A. Gskt: [1] Attached

PA5525



Inner Air Element

Fits Inside: PA5524
Replaces: CLARCOR Filtration (China)
 KY2448-3000; Shaanqi Group AZ91121901421;
 Sinotruk AZ91121901421
O.D.: 4 7/8 (123.8)
I.D.: 5/8 (15.9) & 4 11/16 (119.1)
Height: 18 13/16 (477.8)
A. Gskt: [1] Attached

PA5531



Inner Air Element

Fits Inside: PA5530
Replaces: CLARCOR Filtration (China)
 KY2337-3000
O.D.: 4 7/32 (107.2)
I.D.: 5/8 (19.5) & 4 1/16 (103.2)
Height: 14 9/16 (369.9)
A. Gskt: [1] Attached

PA5526



Outer Air Element

Use With: PA5527
Replaces: CLARCOR Filtration (China)
 KW2139-1000; Foton Lovol 13023273;
 Huafeng Power 13023273
O.D.: 7 13/16 (193.4)
I.D.: 3/8 (9.5) & 4 1/16 (103.2)
Height: 16 (406.4)
A. Gskt: [1] Attached

PA5532

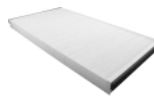

Cab Air Element

Replaces: M.A.N. 81.77910.0012,
 81.77972.0155
Length: 18 1/8 (460.4)
Width: 9 7/16 (239.7)
Height: 1 3/16 (30.2)
A. Gskt: [1] Attached

PA5533



Cab Air Element

Replaces: M.A.N. 81.77972.0121;
 Donaldson P789258
Length: 33 5/16 (846.1)
Width: 9 23/32 (246.9)
Height: 27/32 (21.4)

PA5527



Inner Air Element

Fits Inside: PA5526
Replaces: CLARCOR Filtration (China)
 KW2139-2000; Foton Lovol 13023273;
 Huafeng Power 13023273
O.D.: 3 29/32 (99.2)
I.D.: 5/8 (15.9) & 3 7/16 (87.3)
Height: 15 9/16 (395.3)
A. Gskt: [1] Attached

RS5534



Radial Seal Outer Air Element

Fits: Liebherr LTM1080/1 Crane
Use With: RS5361
Replaces: Kassbohrer 83191752020; Liebherr
 571755608; M.A.N. 81083040100;
 Mercedes-Benz 40941704, A0040941704
O.D.: 10 17/32 (267.5)
I.D.: 6 19/32 (167.5) One End
Height: 18 23/32 (475.5)

Measurements Are Shown In Inches And (Millimeters)

WARNING: These products can expose you to chemicals, including Diisononyl Phthalate, Carbon black extracts, Nickel, 1,3 Butadiene, Ethylene Oxide, Epichlorohydrin, which are known to the State of California to cause cancer, and Bisphenol, Ethylene Glycol, Ethylene Oxide, 1,3 Butadiene, Epichlorohydrin, which are known to the State of California to cause birth defects or other reproductive harm. For more information go to www.P65Warnings.ca.gov.

RS5535



Radial Seal Air Element

Fits: Iveco EuroCargo Trucks
Replaces: Iveco 2992388, 42553258
O.D.: 9 1/8 (231.8)
I.D.: 5 13/16 (147.6) One End
Height: 16 5/32 (410.4)

RS5541



Radial Seal Inner Air Element

Fits Inside: RS5540
Fits: Isuzu 6WA1 Engine
Replaces: FAW Hanwei 110906055A;
CLARCOR Filtration (China) KU2845
O.D.: 7 5/16 (185.7)
I.D.: 6 5/16 (160.3) One End
Height: 17 3/16 (436.6)
O-Ring: [1] Included

RS5536



Radial Seal Outer Air Element

Use With: RS5550
Replaces: Sullair 68562431;
Mann & Hummel C23513
O.D.: 9 (228.6)
I.D.: 4 7/8 (123.8) One End
Height: 11 7/8 (301.6)
Related To: RS5438 (Flame Retardant Media)

RS5543



Radial Seal Outer Air Element

Fits: Manitou MLT523, MLT523A, MT523
Telescopic Handlers
Use With: RS5544
Replaces: Manitou 227959
O.D.: 5 13/32 (137.3)
I.D.: 3 3/16 (81.0) One End
Height: 12 19/32 (319.9)

RS5537



Radial Seal Outer Air Element

Replaces: Faun Frisch 99707008877; FAW
Hanwei 1109060385; Hitachi 59004040; M.A.N.
81083040101, 81083040103; Sullair 68562430;
CLARCOR Filtration (China) KU2437
O.D.: 9 25/32 (248.4)
I.D.: 5 21/32 (143.7) One End
Height: 16 5/32 (410.4)

RS5544



Radial Seal Inner Air Element

Fits Inside: RS5543
Fits: Manitou MLT523, MLT523A, MT523
Telescopic Handlers
Replaces: Manitou 227960
O.D.: 3 5/16 (84.1)
I.D.: 2 15/32 (62.7) One End
Height: 12 7/32 (310.4)

RS5538



Radial Seal Outer Air Element

Fits: Faw-Xichai 6DL Diesel Engine
Use With: RS5539
Replaces: Faw-Xichai 110907050A;
Donaldson R000753
O.D.: 11 3/32 (281.8)
I.D.: 7 7/16 (188.9) One End
Height: 17 21/32 (448.5)

PA5545

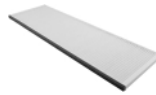

Cab Air Element

Replaces: M.A.N. 83.77972.0608;
Mercedes-Benz 18355547
Length: 19 3/8 (492.1)
Width: 5 3/4 (146.1)
Height: 3/8 (9.5)
A. Gskt: [1] Attached

RS5539



Radial Seal Inner Air Element

Fits Inside: RS5538
Replaces: Faw-Xichai 110906050A
O.D.: 7 5/16 (185.7)
I.D.: 6 19/32 (167.5) One End
Height: 15 7/16 (392.1)
O-Ring: [1] Attached

RS5546



Radial Seal Outer Air Element

Use With: RS3732
Replaces: Fleetguard AF25746;
Nelson 70991N
O.D.: 8 13/16 (223.8)
I.D.: 5 5/32 (131.0) One End
Height: 16 7/8 (428.6)

RS5540



Radial Seal Outer Air Element

Fits: Isuzu 6WA1 Engine
Use With: RS5541
Replaces: FAW Hanwei 110907055A;
CLARCOR Filtration (China) KU2845
O.D.: 11 3/32 (281.8)
I.D.: 7 7/16 (188.9) One End
Height: 19 13/32 (492.9)

RS5547



Radial Seal Inner Air Element

Fits Inside: RS5441
Fits: King Long XMQ6120, XMQ6900 Buses
Replaces: Hitachi 59004050; King Long
4574556159; M.A.N. 81084050026; Mann &
Hummel CF1430
O.D.: 5 5/16 (134.9)
I.D.: 4 1/4 (108.0) One End
Height: 13 15/16 (354.0)
O-Ring: [1] Included

Measurements Are Shown In Inches And (Millimeters)



WARNING: These products can expose you to chemicals, including Diisononyl Phthalate, Carbon black extracts, Nickel, 1,3 Butadiene, Ethylene Oxide, Epichlorohydrin, which are known to the State of California to cause cancer, and Bisphenol, Ethylene Glycol, Ethylene Oxide, 1,3 Butadiene, Epichlorohydrin, which are known to the State of California to cause birth defects or other reproductive harm. For more information go to www.P65Warnings.ca.gov.

RS5548



Radial Seal Inner Air Element

Fits Inside: RS5440
Replaces: FAW Group 1109070297;
 CLARCOR Filtration (China) KU2337, KU2437;
 Mann & Hummel CF1440
O.D.: 5 5/16 (134.9)
I.D.: 4 3/8 (111.1) One End
Height: 15 29/32 (404.0)
O-Ring: [1] Included

PA5554



Air Element

Replaces: CLARCOR Filtration (China)
 KY1520-2000; Foton Lovol SM1021-1109010
O.D.: 6 1/8 (155.6)
I.D.: 7/16 (11.1) & 3 3/8 (85.7)
Height: 7 11/16 (195.3)

RS5549



Radial Seal Inner Air Element

Fits Inside: RS548
Fits: Heuliez, Irisbus, Iveco Autobus, M.A.N.,
 Neoplan, Renault, Scania Buses
Replaces: Bomag 5821450; Irisbus
 5006307754, 503131284;
 M.A.N. 81084050027; Scania 1510942
O.D.: 6 1/8 (155.6)
I.D.: 5 1/8 (130.2) One End
Height: 18 7/16 (468.3)
O-Ring: [1] Included

PA5555



Air Element

Replaces: CLARCOR Filtration (China)
 KY1522-2000; Foton Lovol D20010.48.1
O.D.: 6 1/8 (155.6)
I.D.: 7/16 (11.1) & 3 3/8 (85.7)
Height: 8 13/16 (223.8)
A. Gskt: [1] Attached

RS5550



Radial Seal Inner Air Element

Fits Inside: RS5536 (NOT for use with RS5438)
Replaces: Mann & Hummel CF1240;
O.D.: 4 1/2 (114.3)
I.D.: 3 9/16 (90.5) One End
Height: 9 1/2 (241.3)
O-Ring: [1] Included

PA5556



Outer Air Element

Use With: PA5557
Replaces: CLARCOR Filtration (China)
 KY2139-1000; Weichai Power 13023273 (Outer)
O.D.: 8 1/2 (215.9)
I.D.: 15/32 (11.9) & 4 13/16 (122.2)
Height: 15 29/32 (404.0)
A. Gskt: [1] Attached

PA5551



Air Element

Replaces: CLARCOR Filtration (China)
 30123630; Jinan Diesel Engine Co. 3012.36.30
O.D.: 19 9/32 (489.7)
I.D.: 12 7/16 (315.9)
Height: 10 3/4 (273.1)
A. Gskt: [2] Attached

PA5557



Inner Air Element

Fits Inside: PA5556
Replaces: CLARCOR Filtration (China)
 KY2139-2000; Weichai Power 13023273 (Inner)
O.D.: 4 21/32 (118.3)
 Flange 5 9/32 (134.1)
I.D.: 15/32 (11.9) & 3 7/16 (87.3)
Height: 14 3/4 (374.7)
A. Gskt: [1] Attached

PA5552



Air Element

Replaces: CLARCOR Filtration (China)
 12VB36M40; Jinan Diesel Engine Co.
 12VB.36M.40
O.D.: 15 1/32 (381.8)
I.D.: 29/32 (23.0) & 10 9/16 (268.3)
Height: 19 9/32 (489.7)
A. Gskt: [1] Attached

RS5558



Radial Seal Outer Air Element

Fits: Ingersoll-Rand Compressors
Use With: RS5559
Replaces: Ingersoll-Rand 54717145
O.D.: 8 13/16 (223.8)
I.D.: 5 17/32 (140.5) One End
Height: 16 23/32 (424.7)

PA5553



Air Element

Replaces: CLARCOR Filtration (China)
 12VB36M50; Jinan Diesel Engine Co.
 12VB.36M.50
O.D.: 9 3/8 (238.1)
I.D.: 29/32 (23.0) & 7 5/8 (193.7)
Height: 20 11/16 (525.5)
A. Gskt: [1] Attached

RS5559



Radial Seal Inner Air Element

Fits Inside: RS5558
Fits: Ingersoll-Rand 10/105 VHP300WIR, 375,
 XP375WIR, P425WIR Compressors with
 Ingersoll-Rand 4IRD5AE Engine
Replaces: Ingersoll-Rand 54717152
O.D.: 5 1/2 (139.7)
I.D.: 3 3/4 (95.3) One End
Height: 15 3/4 (400.0)

Measurements Are Shown In Inches And (Millimeters)

WARNING: These products can expose you to chemicals, including Diisononyl Phthalate, Carbon black extracts, Nickel, 1,3 Butadiene, Ethylene Oxide, Epichlorohydrin, which are known to the State of California to cause cancer, and Bisphenol, Ethylene Glycol, Ethylene Oxide, 1,3 Butadiene, Epichlorohydrin, which are known to the State of California to cause birth defects or other reproductive harm. For more information go to www.P65Warnings.ca.gov.

PA5560

Air Element



Replaces: CLARCOR Filtration (China) K2410-0300; Huafeng Power K2410-0300
O.D.: 9 7/16 (239.7)
I.D.: 6 3/8 (161.9)
Height: 4 11/32 (110.3)
A. Gskt: [2] Attached

PA5561

Outer Air Element



Use With: PA5562
Replaces: CLARCOR Filtration (China) K3251-1000; Foton Lovol 1331311982010, K3251-1000
O.D.: 12 3/4 (323.9)
I.D.: 7/16 (11.1) & 8 3/8 (212.7)
Height: 20 (508.0)
A. Gskt: [1] Attached

PA5562

Inner Air Element



Fits Inside: PA5561
Replaces: CLARCOR Filtration (China) K3251-2000; Foton Lovol 1331311982010, K3251-2000
O.D.: 8 9/32 (210.3)
I.D.: 7/16 (11.1) & 7 3/32 (180.2)
Height: 18 1/2 (469.9)
A. Gskt: [1] Attached

PA5563

Air Element



Replaces: CLARCOR Filtration (China) K2007-1000; Weichai Power K2007-1000, 13023208
O.D.: 7 27/32 (199.2)
I.D.: 4 27/32 (123.0)
Height: 3 9/32 (83.3)
A. Gskt: [2] Attached

PA5564

Outer Air Element



Use With: PA5565
Replaces: CLARCOR Filtration (China) KL2851-0100, 612600113988; Foton Lovol KL2851-0100; Sinotruk KL2851-0100
O.D.: 10 27/32 (275.4)
I.D.: 13/32 (10.3) & 6 1/2 (165.1)
Height: 19 7/8 (504.8)
A. Gskt: [1] Attached

PA5565

Inner Air Element



Fits Inside: PA5564
Replaces: CLARCOR Filtration (China) KL2851-0200, 612600113988; Foton Lovol KL2851-0200; Sinotruk KL2851-0200
O.D.: 6 13/32 (162.7)
I.D.: 13/32 (10.3) & 5 9/32 (134.1)
Height: 18 5/8 (473.1)
A. Gskt: [1] Attached

BA5566

Desiccant Air Dryer Spin-on



Contains: Left Hand Threads
Fits: Volvo Trucks
Replaces: Knorr-Bremse K005686, K014712, K039453; Renault 5001865404, 7421267793; Volvo 20754416, 21267818; WABCO 4329012452; Mahle AL26
Thread: M39 x 1.5 LH
O.D.: 5 3/8 (136.5)
Height: 6 9/16 (167.5)
I.Gskt: [1] Included
O-Ring: [1] Included

PA5567

Air Element



Replaces: Kubota 5T051-26111; CLARCOR Filtration (China) KY1522A-2000
O.D.: 5 7/8 (149.2)
I.D.: 11/32 (8.7) & 3 7/32 (81.8)
Height: 9 1/8 (231.8)
A. Gskt: [1] Attached

PA5568

Outer Air Element with Lift Tabs



Use With: PA5569
Replaces: Shaanqi Group DZ93259190101; CLARCOR Filtration (China) K3260-2000
O.D.: 12 3/4 (323.9)
 Boot 12 31/32 (329.4)
I.D.: 29/32 (23.0) & 8 3/8 (212.7)
Height: 24 7/16 (620.7)
A. Gskt: [1] Attached

PA5569

Inner Air Element with Lift Tab



Fits Inside: PA5568
Replaces: Shaanqi Group DZ93259190101; CLARCOR Filtration (China) K3260-3000
O.D.: 8 9/32 (210.3)
I.D.: 29/32 (23.0) & 7 3/32 (180.2)
Height: 22 1/4 (565.2)
A. Gskt: [1] Attached

PA5570

Outer Air Element



Use With: PA5572
Replaces: Foton Lovol KW1532A1; Huafeng Power KW1532A1-2000; CLARCOR Filtration (China) KW1532A1-2000
O.D.: 6 1/8 (155.6)
I.D.: 7/16 (11.1) & 3 9/32 (83.3)
Height: 12 29/32 (327.8)
A. Gskt: [1] Attached

PA5571

Air Element



Replaces: Foton Lovol KW1532-1000; CLARCOR Filtration (China) KW1532-1000
O.D.: 6 1/8 (155.6)
I.D.: 7/16 (11.1) & 3 3/8 (85.7)
Height: 12 29/32 (327.0)
A. Gskt: [1] Attached

Measurements Are Shown In Inches And (Millimeters)



WARNING: These products can expose you to chemicals, including Diisononyl Phthalate, Carbon black extracts, Nickel, 1,3 Butadiene, Ethylene Oxide, Epichlorohydrin, which are known to the State of California to cause cancer, and Bisphenol, Ethylene Glycol, Ethylene Oxide, 1,3 Butadiene, Epichlorohydrin, which are known to the State of California to cause birth defects or other reproductive harm. For more information go to www.P65Warnings.ca.gov.

PA5572 Inner Air Element
Fits Inside: PA5570
Replaces: Foton Lovol KW1532-2000; Huafeng Power KW1532-2000; CLARCOR Filtration (China) KW1532-2000
O.D.: 3 1/8 (79.4)
 Flange 3 3/4 (95.3)
I.D.: 7/16 (11.1) & 3 3/4 (95.3)
Height: 11 7/8 (301.6)
A. Gskt: [1] Attached



PA5578 Inner Air Element
Fits Inside: PA5577
Replaces: Shaanqi Group DZ93259190115; CLARCOR Filtration (China) KY3051-3000
O.D.: 7 1/4 (184.2)
I.D.: 7/16 (11.1) & 6 3/16 (157.2)
Height: 19 7/8 (504.8)
A. Gskt: [1] Attached



PA5573 Outer Air Element
Use With: PA5574
Replaces: Sullair 88290001466; CLARCOR Filtration (China) KQ3856-1000
O.D.: 15 1/32 (381.8)
I.D.: 29/32 (23.0) & 10 9/16 (268.3)
Height: 22 7/16 (569.9)
A. Gskt: [1] Attached



PA5579 Air Element
Replaces: Shanghai Screw Compressor Co. 25150014071; CLARCOR Filtration (China) K1016-2000
O.D.: 4 3/32 (104.0)
I.D.: 21/32 (16.7) & 2 15/32 (62.7)
Height: 6 5/8 (168.3)
A. Gskt: [1] Attached



PA5574 Inner Air Element
Fits Inside: PA5573
Replaces: Sullair 88290001467; CLARCOR Filtration (China) KQ3856-2000
O.D.: 9 3/8 (238.1)
I.D.: 29/32 (23.0) & 8 1/16 (204.8)
Height: 19 9/32 (489.7)
A. Gskt: [1] Attached



PA5580 Cab Air Element
Fits: John Deere, Volvo, Zetor Equipment
Replaces: John Deere RE187966
Length: 12 19/32 (319.9)
Width: 6 1/2 (165.1)
Height: 1 7/8 (47.6)



PA5575 Outer Air Element
Use With: PA5576
Replaces: CLARCOR Filtration (China) KY2030-1000; Foton Lovol TD82011A11
O.D.: 7 13/16 (198.4)
I.D.: 3/8 (9.5) & 4 5/32 (105.6)
Height: 12 3/16 (309.6)
A. Gskt: [1] Attached



PA5581 Cab Air Element
Fits: Caterpillar D3G, D4G, D5G Crawler Tractors
Replaces: Caterpillar 1832813
Length: 20 13/16 (528.6)
Width: 5 11/32 (135.7)
Height: 2 9/32 (57.9)



PA5576 Inner Air Element
Fits Inside: PA5575
Replaces: CLARCOR Filtration (China) KY2030-2000; Foton Lovol TD82011A11
O.D.: 4 1/4 (108.0)
I.D.: 13/32 (10.3) & 3 5/8 (92.1)
Height: 11 23/32 (297.7)
A. Gskt: [1] Attached



PA5582 Air Element
Notes: OBSOLETE. Availability Limited to Dealer Stock. Replaced by PA30206
Contains: Flame Retardant Media
Fits: Hyster Lift Trucks
Replaces: Hyster 1620142; Yale 580069337; Donaldson P616742
O.D.: 5 1/8 (130.2)
 Flange 6 11/16 (169.9)
I.D.: 3 5/16 (84.1) One End
Height: 13 (330.2)



PA5577 Outer Air Element
Use With: PA5578
Replaces: Shaanqi Group DZ93259190115; CLARCOR Filtration (China) KY3051-2000
O.D.: 12 (304.8)
I.D.: 7/16 (11.1) & 7 11/16 (195.3)
Height: 20 25/32 (527.8)
A. Gskt: [1] Attached



PA5583 Air Element
Fits: Ditch Witch, Hyster, Yale Equipment
Replaces: Hyster 1574111; Yale 580053908; Donaldson P611859
O.D.: 4 1/32 (102.4)
 Flange 5 9/16 (141.3)
I.D.: 2 13/16 (71.4) One End
Height: 12 7/8 (327.0)



PA5584 Outer Air Element
Contains: Flame Retardant Media
Fits: Hyster, Yale Equipment
Use With: PA30163
Replaces: Hyster 1559418; Yale 580048838; Donaldson P611858
O.D.: 3 13/32 (86.5)
 Flange 4 3/4 (120.7)
I.D.: 2 1/4 (57.2) One End
Height: 10 17/32 (267.5)



Measurements Are Shown In Inches And (Millimeters)

WARNING: These products can expose you to chemicals, including Diisononyl Phthalate, Carbon black extracts, Nickel, 1,3 Butadiene, Ethylene Oxide, Epichlorohydrin, which are known to the State of California to cause cancer, and Bisphenol, Ethylene Glycol, Ethylene Oxide, 1,3 Butadiene, Epichlorohydrin, which are known to the State of California to cause birth defects or other reproductive harm. For more information go to www.P65Warnings.ca.gov.

PA5585



Cab Air Element

Fits: M.A.N., Neoplan Buses
Replaces: M.A.N. 88779100003; Donaldson P787437; Fleetguard AF55709
Length: 8 21/32 (219.9)
Width: 5 29/32 (150.0)
Height: 25/32 (19.8)

PA5586



Cab Air Element

Fits: Evobus, Konvekta, M.A.N., Neoplan, Solaris Buses
Replaces: M.A.N. 88779100002; Mercedes-Benz 18352747; Konvekta H14002499; Donaldson P788729; Fleetguard AF55708
Length: 15 3/4 (400.1)
Width: 5 3/16 (131.8)
Height: 25/32 (19.8)

BF5587-D



Secondary Fuel Spin-on with Drain

Fits: Massey Ferguson, Volvo Equipment
Replaces: Volvo 3976655, 3976655-5; Mann & Hummel WK842/2; Sinfa FG758; Woodgate WGF842-2
Thread: M16 x 1.5
O.D.: 3 7/16 (87.3)
Height: 6 13/32 (162.7)
I.Gskt: [1] Included
O-Ring: [1] Attached
Related To: BF587-D (without Trapped O-Ring)

PA5588



Outer Air Element

Use With: PA5589
Replaces: Dongfeng Tianlong A660-020; Fleetguard AF26413
O.D.: 11 13/16 (300.0)
I.D.: 11/16 (17.5) & 7 7/8 (200.0)
Height: 18 19/32 (472.3)
A. Gskt: [1] Attached
F. Gskt: [1] Included

PA5589



Inner Air Element

Fits Inside: PA5588
Replaces: Dongfeng Tianlong A660-030; Fleetguard AF26414
O.D.: 7 15/32 (189.7)
I.D.: 11/16 (17.5) & 6 7/32 (158.0)
Height: 17 7/16 (442.9)
A. Gskt: [1] Attached
F. Gskt: [1] Included

RS5591XP



Extreme Performance Nano Radial Seal Cab Air Element

Fits: Case-International Sprayers; Case-International, New Holland Tractors
Replaces: Case 259288A1, 87684088
O.D.: 6 1/8 (155.6)
I.D.: 2 1/2 (63.5) One End
Height: 13 21/32 (346.9)

BA5592



Desiccant Air Dryer Spin-on

Fits: Freightliner, Mack, Volvo Trucks
Replaces: Volvo 8235R950068, 85110799
Thread: M39 x 1.5
O.D.: 5 1/2 (139.7)
Height: 6 9/16 (167.5)
I.Gskt: [1] Included
O-Ring: [1] Included

RS5593



Radial Seal Cab Air Element

Notes: OBSOLETE. Replaced by RS5593XP
Fits: Case-IH Combines
Replaces: Case 247752A1
O.D.: 7 3/32 (180.2)
I.D.: 2 15/32 (62.7) One End
Height: 21 15/16 (557.2)

RS5593XP



Extreme Performance Nano Radial Seal Cab Air Element

Fits: Case-IH Combines
Replaces: Case 247752A1
O.D.: 7 3/32 (180.2)
I.D.: 2 15/32 (62.7) One End
Height: 21 15/16 (557.2)

PA5594



Cab Air Element

Fits: M.A.N. Neoplan Buses
Replaces: M.A.N. 83779100519; Mann & Hummel CU3933; SF-Filter SKL46339
Length: 15 7/16 (392.1)
Width: 6 3/32 (154.8)
Height: 21/32 (16.7)

PA5596



Cab Air Element

Fits: 1995-on Evobus Turismo I Bus
Replaces: Evobus 18359547; Mercedes-Benz A0018359547; Mann & Hummel CU4033
Length: 15 11/32 (389.7)
Width: 5 3/32 (129.4)
Height: 21/32 (16.7)

PA5597



Cab Air Element

Fits: Evobus, M.A.N., Vison Buses
Replaces: Evobus 18359247; Konvekta H14003495; M.A.N. 83779720656; Mercedes-Benz A0018359247
Length: 17 29/32 (454.8)
Width: 5 15/16 (150.8)
Height: 15/32 (11.9)
A. Gskt: [1] Attached

PA5598



Cab Air Element

Fits: Evobus Buses
Replaces: Evobus 18356147; Mercedes-Benz 18356147
Length: 23 3/8 (593.7)
Width: 4 9/16 (115.9)
Height: 15/32 (11.9)

Measurements Are Shown In Inches And (Millimeters)

WARNING: These products can expose you to chemicals, including Diisononyl Phthalate, Carbon black extracts, Nickel, 1,3 Butadiene, Ethylene Oxide, Epichlorohydrin, which are known to the State of California to cause cancer, and Bisphenol, Ethylene Glycol, Ethylene Oxide, 1,3 Butadiene, Epichlorohydrin, which are known to the State of California to cause birth defects or other reproductive harm. For more information go to www.P65Warnings.ca.gov.

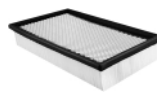
<p>PA5599 Panel Air Element Fits: Evobus Buses Replaces: Evobus 18358447; Konvekta T140009005; Mercedes-Benz A0018358447; Mann & Hummel CU3935 Length: 15 3/8 (390.5) Width: 5 19/32 (142.1) Height: 23/32 (18.3)</p> 	<p>PA5625 Cab Air Element Fits: Bobcat Loaders Replaces: Bobcat 6678207 Length: 14 5/8 (371.5) Width: 4 5/8 (117.5) Height: 1 3/16 (30.2)</p> 
<p>PA5618 Cab Air Element Fits: Bobcat Loaders Replaces: Bobcat 6677983 Length: 24 13/32 (619.9) Width: 4 3/16 (106.4) Height: 1 3/32 (27.8)</p> 	<p>PA5626 Cab Air Element Fits: Agco, Challenger, Massey Ferguson Tractors Replaces: Massey Ferguson 3388840M2, 3388840M3 Length: 34 17/32 (877.1) Width: 5 5/16 (134.9) Height: 2 13/32 (61.1)</p> 
<p>PA5619 Oval Air Element Notes: Recommend using with PA4187 (Oiled Foam) Fits: John Deere Lawn & Garden Tractors Replaces: John Deere M76077, MIU10778 O.D.: 3 1/2 (88.9) to 8 5/8 (219.1) I.D.: 1 21/32 (42.1) & 6 27/32 (173.8) Height: 2 29/32 (73.8) A. Gskt: [2] Attached</p> 	<p>RS5627 Radial Seal Outer Air Element Fits: Mercedes-Benz O 500 M, O 500 R, O 500 U, OF 1721, OF 1518, OH 1520, OH1618, OH 1621 L, OF1622 L Latin America Buses, 2726, 2726 B-36, 2726 K-36 South America Trucks Use With: RS5628 Replaces: Mercedes-Benz 6345280306, A6345280306; Racor AR5626RS; Donaldson P618941 O.D.: 10 3/8 (263.5) I.D.: 5 3/4 (146.1) One End Height: 15 7/8 (403.2)</p> 
<p>PA5620 Cab Air Element Fits: New Holland Excavators Replaces: Komatsu YT20M00004S050; New Holland YT20M00004S050 Length: 8 5/32 (207.2) Width: 7 5/16 (185.7) Height: 1 5/32 (29.4)</p> 	<p>RS5628 Radial Seal Inner Air Element Fits Inside: RS5627 Fits: Volkswagen 26.220, 26.260, 26.260 E, 26.300, 26.310 Trucks Replaces: Volkswagen 2S0129620A O.D.: 5 3/4 (146.1) I.D.: 4 3/8 (111.1) One End Height: 16 1/2 (419.1)</p> 
<p>PA5621 Cab Air Element with Handle Fits: Fiat-Hitachi, Hitachi, John Deere Excavators; John Deere Loggers Replaces: Hitachi 4350249, 4S00640 Length: 13 9/32 (337.3) Width: 8 21/32 (219.9) Height: 2 13/16 (71.4) A. Gskt: [1] Attached</p> 	<p>PA5629 Cab Air Element Fits: Kobelco, New Holland Excavators Replaces: Kobelco YN50V01006P1P; New Holland YN50V01006P1, YN50V01006P1P Length: 8 17/32 (216.7) Width: 7 15/16 (201.6) Height: 1 31/32 (50.0) A. Gskt: [1] Attached</p> 
<p>PA5622 Cab Air Element with Pull Tab Fits: Komatsu Dozers, Excavators Replaces: Komatsu 2039796840 Length: 9 5/32 (232.6) Width: 7 29/32 (200.8) Height: 15/16 (23.8)</p> 	<p>PA5630 Cab Air Element Fits: Hitachi Zaxis 75US-A, ZX75US-A Excavators Replaces: Hitachi 4S00687 Length: 17 1/2 (444.5) Width: 4 1/4 (108.0) Height: 3/16 (4.8)</p> 
<p>PA5623 Cab Air Element Fits: Volvo Equipment Replaces: Volvo 14506997, VOE14506997; Fleetguard AF26668 Length: 16 3/32 (408.9) Width: 11 23/32 (297.7) Height: 1 3/16 (30.2) A. Gskt: [1] Attached</p> 	<p>PA5631 Cab Air Element Fits: Case, Link-Belt Excavators Replaces: Case KHR2772, MMR80010 Length: 9 (228.6) Width: 7 1/8 (181.0) Height: 1 27/32 (46.8)</p> 
<p>PA5624 Cab Air Element Fits: Hitachi Excavators; John Deere Excavators, Forestry Swing Machines Replaces: Hitachi 4484453 Length: 11 11/32 (288.1) Width: 6 5/8 (168.3) Height: 1 7/16 (36.5)</p> 	<p>PA5632 Cab Air Element Fits: Caterpillar Equipment Replaces: Caterpillar 2098217 Length: 12 7/16 (315.9) Width: 7 1/16 (179.4) Height: 2 5/32 (54.8)</p> 

Measurements Are Shown In Inches And (Millimeters)

 **WARNING:** These products can expose you to chemicals, including Diisononyl Phthalate, Carbon black extracts, Nickel, 1,3 Butadiene, Ethylene Oxide, Epichlorohydrin, which are known to the State of California to cause cancer, and Bisphenol, Ethylene Glycol, Ethylene Oxide, 1,3 Butadiene, Epichlorohydrin, which are known to the State of California to cause birth defects or other reproductive harm. For more information go to www.P65Warnings.ca.gov.

PA5633



Cab Air Element
Fits: Caterpillar Crawler Tractors
Replaces: Caterpillar 3E7904;
 Donaldson P618641
Length: 9 23/32 (246.9)
Width: 6 17/32 (165.9)
Height: 1 3/8 (34.9)

PA5634



Outer Air Element
Notes: OBSOLETE. Availability Limited to Dealer Stock. Replaced by PA30207.
Fits: John Deere Loaders, Tractors
Use With: PA5635
Replaces: John Deere RE282286;
 Donaldson P609221
O.D.: 5 1/8 (130.2)
 Flange 5 15/16 (150.8)
I.D.: 3 1/4 (82.6) One End
Height: 13 (330.2)

PA5635



Inner Air Element
Notes: OBSOLETE. Availability Limited to Dealer Stock. Replaced by PA30208
Fits Inside: PA5634
Fits: John Deere Loaders, Tractors
Replaces: John Deere RE282287;
 Donaldson P608599
O.D.: 2 7/16 (61.9) to 3 7/8 (98.4)
I.D.: 3 5/8 (92.1) One End
Height: 12 25/32 (324.6)

PA5636

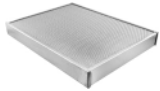

Cab Air Element
Fits: Komatsu Dump Trucks
Replaces: Komatsu PB7001
Length: 20 (508.0)
Width: 14 19/32 (370.7)
Height: 2 3/16 (55.6)

PA5637



Cab Air Element
Fits: International Trucks
Replaces: International 1699956C1;
 Donaldson P617005; Fleetguard AF55700
Length: 13 21/32 (346.9)
Width: 10 1/32 (254.8)
Height: 19/32 (15.1)

PA5638



Cab Air Element
Fits: Caterpillar Equipment
Replaces: Caterpillar 2457823
Length: 7 15/16 (201.6)
Width: 7 7/8 (200.0)
Height: 23/32 (18.3)

RS5641



Radial Seal Outer Air Element
Fits: Power Prime DV150i Pump with Perkins 1104C Engine
Use With: RS4679
Replaces: FG Wilson 915671;
 J.C. Bamford 32110086;
 Perkins 26510380
O.D.: 6 13/32 (162.7)
I.D.: 3 17/32 (89.7) One End
Height: 13 21/32 (346.9)

PA5642



Cab Air Element with Foam Pad
Fits: Evobus Buses; Mercedes-Benz Trucks
Replaces: Evobus 18359147;
 Mercedes-Benz A0018359147
Length: 20 5/32 (512.0)
Width: 9 7/32 (234.2)
Height: 1 7/8 (47.6)
A. Gskt: [2] Attached

PA5643



Cab Air Element
Fits: Evobus Buses with Mercedes-Benz Engines
Replaces: Evobus 18356247;
 Mercedes-Benz A0018356247
Length: 10 31/32 (278.6)
Width: 4 9/16 (115.9)
Height: 1/2 (12.7)
A. Gskt: [2] Velco strips attached

PA5644



Cab Air Element
Fits: Evobus Buses with Mercedes-Benz Engines
Replaces: Evobus 18357147;
 Mercedes-Benz A0018357147
Length: 19 13/32 (492.9)
Width: 5 27/32 (148.4)
Height: 1 3/16 (30.2)
A. Gskt: [1] Attached

PA5645

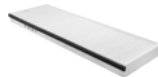

Cab Air Element
Fits: Evobus CapaCity, Intouro, Integro, Setra Turismo, Travego Buses; Irisbus Crossway, Arway Buses
Replaces: Evobus 18357047;
 Mercedes-Benz A0018357047
Length: 17 29/32 (454.8)
Width: 5 27/32 (148.4)
Height: 1 3/16 (30.2)
A. Gskt: [1] Attached

PA5646

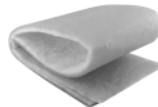

Foam Cab Air Element
Fits: Evobus Integro, Setra Buses with Mercedes-Benz Engines
Replaces: Evobus 18351347, 8441000941;
 Mercedes-Benz A0018351347
Length: 60 5/8 (1539.9)
Width: 9 21/32 (245.3)
Height: 25/32 (19.8)

PA5647



Cab Air Element
Fits: Evobus Buses with Mercedes-Benz Engines
Replaces: Evobus 3568303118;
 Mercedes-Benz A3568303118
Length: 20 21/32 (524.7)
Width: 8 3/4 (222.3)
Height: 1 13/16 (46.0)

PA5648











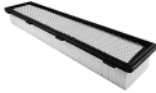

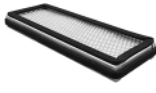

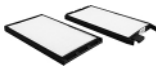
Cab Air Element
Fits: Evobus CapaCity, Citaro Buses with Mercedes-Benz Engines
Replaces: Evobus 18351547; Konvekta H14002484; Mercedes-Benz A0018351547
Length: 19 27/32 (504.0)
Width: 8 7/8 (225.4)
Height: 1 3/16 (30.2)
A. Gskt: [2] Attached

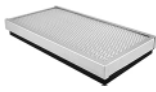
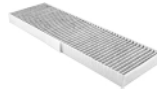
Measurements Are Shown In Inches And (Millimeters)

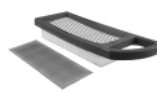

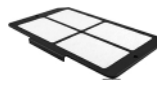
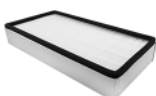
WARNING: These products can expose you to chemicals, including Diisononyl Phthalate, Carbon black extracts, Nickel, 1,3 Butadiene, Ethylene Oxide, Epichlorohydrin, which are known to the State of California to cause cancer, and Bisphenol, Ethylene Glycol, Ethylene Oxide, 1,3 Butadiene, Epichlorohydrin, which are known to the State of California to cause birth defects or other reproductive harm. For more information go to www.P65Warnings.ca.gov.

<p>PA5649 Cab Air Element Fits: Case-IH, McCormick Equipment Replaces: Case 248124A1, 87761808 Length: 18 1/2 (469.9) Width: 4 9/16 (115.9) Height: 2 1/4 (57.2)</p> 	<p>PA5657 Cab Air Element with Pull Tabs Fits: Case, New Holland Equipment Replaces: Case 627749 Length: 29 29/32 (759.6) Width: 9 17/32 (242.1) Height: 2 3/16 (55.6)</p> 
<p>PA5650 Cab Air Element Fits: Caterpillar Equipment Replaces: Caterpillar 2318132 Length: 10 23/32 (272.3) Width: 4 3/32 (104.0) Height: 1 3/32 (27.8) A. Gskt: [2] Attached</p> 	<p>PA5658 Oval Air Element Fits: Onan RV Generators Replaces: Onan 1402897 O.D.: 4 7/16 (112.7) to 6 19/32 (167.5) I.D.: 2 15/16 (74.6) & 5 1/32 (127.8) Height: 4 1/16 (103.2)</p> 
<p>PA5651 Set of 2 Cab Air Elements Notes: Uses 2 filters per application. Fits: Komatsu Excavators Replaces: Komatsu 22B9791730 Each Filter: Length: 8 1/8 (206.4) Width: 4 1/2 (114.3) Height: 19/32 (15.1) A. Gskt: [1] Attached to Each Filter</p> 	<p>PA5659 Foam Cab Air Element Contains: Adhesive backing Fits: Case-IH Sprayers; Steiger Tractors Replaces: Case 87409368 Length: 62 1/4 (1581.2) Width: 3 (76.2) Height: 2 (50.8)</p> 
<p>PA5652 Cab Air Element Fits: John Deere Backhoe/Loaders Replaces: John Deere AT184590 Length: 12 9/16 (319.1) Width: 6 1/2 (165.1) Height: 1 7/16 (36.5) A. Gskt: [1] Attached</p> 	<p>PA5660 Cab Air Element Contains: Charcoal impregnated media for odor control. Fits: Case Loaders Replaces: Case 87029691, 87681240 Length: 14 1/2 (368.3) Width: 4 9/32 (108.7) Height: 15/16 (23.8) A. Gskt: [2] Attached</p> 
<p>PA5653 Cab Air Element Fits: John Deere, Timberjack Feller Bunchers Replaces: John Deere 700093800; Timberjack 700093800 Length: 17 (431.8) Width: 10 1/32 (254.8) Height: 2 3/16 (55.6)</p> 	<p>PA5661 Panel Air Element with Foam Pre-Cleaner Fits: L100, 102, LA105, L108, LA110, X110, 115, LA115, X 120, Z225 EZTrak Lawn & Garden Equipment Replaces: John Deere GY20573; Stens 102871 and 102875 Length: 8 31/32 (227.8) Width: 6 5/16 (160.3) Height: 1 1/2 (38.1)</p> 
<p>PA5654 Cab Air Element Fits: Caterpillar Off-Highway Trucks, Wheel Tractors Replaces: Caterpillar 1748145 Length: 16 1/8 (409.6) Width: 5 31/32 (151.6) Height: 2 19/32 (65.9) A. Gskt: [1] Attached</p> 	<p>PA5662 Cab Air Element Fits: Hitachi Excavators Replaces: Hitachi 4441139, 4S00684; John Deere 4S00684 Length: 11 3/8 (288.9) Width: 6 9/16 (166.7) Height: 3/8 (9.5)</p> 
<p>PA5655 Cab Air Element Fits: Caterpillar Off-Highway Trucks, Equipment Replaces: Caterpillar 1193355 Length: 15 29/32 (404.0) Width: 7 7/8 (200.0) Height: 2 3/16 (55.6) A. Gskt: [1] Attached</p> 	<p>PA5663 Cab Air Element with Bail Handle Fits: Komatsu HM350-1, HM400-1 Dump Trucks Replaces: Komatsu 2099796260 Length: 9 31/32 (253.2) Width: 6 1/32 (153.2) Height: 2 3/16 (55.6)</p> 
<p>PA5656 Cab Air Element Fits: Hitachi, John Deere Excavators Replaces: Hitachi 4632689, 4S00686SH Length: 12 9/16 (319.1) Width: 8 (203.2) Height: 3 1/16 (77.8) A. Gskt: [1] Attached</p> 	<p>PA5664 Air Element Fits: Volvo-Penta Marine Engines Replaces: Volvo 858488 O.D.: 7 31/32 (202.4) I.D.: 3 27/32 (97.6) Height: 3 15/16 (100.0)</p> 

Measurements Are Shown In Inches And (Millimeters)

 **WARNING:** These products can expose you to chemicals, including Diisononyl Phthalate, Carbon black extracts, Nickel, 1,3 Butadiene, Ethylene Oxide, Epichlorohydrin, which are known to the State of California to cause cancer, and Bisphenol, Ethylene Glycol, Ethylene Oxide, 1,3 Butadiene, Epichlorohydrin, which are known to the State of California to cause birth defects or other reproductive harm. For more information go to www.P65Warnings.ca.gov.

PA5665 Air Element
Replaces: Air Refiner ARP1063; Universal Silencer 811063; Wix 42788
O.D.: 9 23/32 (246.9)
I.D.: 7 9/32 (184.9)
Height: 6 (152.4)



PA5666 Cab Air Element
Fits: Hitachi, John Deere Excavators
Replaces: Hitachi 4643580, 4S00685
Length: 11 1/32 (280.2)
Width: 6 5/16 (160.3)
Height: 1 25/32 (45.2)



PA5667 Cab Air Element
Fits: Fiat-Hitachi Excavators; Hitachi, New Holland Loaders
Replaces: New Holland 154227500
Length: 18 5/16 (465.1)
Width: 5 5/16 (134.9)
Height: 2 5/32 (54.8)



PA5668 Cab Air Element
Fits: Case Loaders
Replaces: Case 360260A2
Length: 29 3/32 (739.0)
Width: 5 9/16 (141.3)
Height: 2 3/16 (55.6)
A. Gskt: [1] Attached



PA5669 Cab Air Element
Fits: John Deere Dozers, Feller Bunchers, Loaders
Replaces: John Deere AT307501
Length: 12 17/32 (318.3)
Width: 7 1/16 (179.4)
Height: 1 5/8 (41.3)

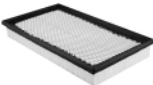

RS5670 Radial Seal Air Element
Fits: Nissan, Renault Trucks
Replaces: Nissan 16546MA70A, 16546MA70C; Renault 5001869822
O.D.: 6 27/32 (173.8)
I.D.: 3 3/4 (95.3) One End
Height: 7 1/4 (184.2)



RS5672 Radial Seal Outer Air Element
Use With: RS5673
Replaces: DongFeng Tianlong 11043911210; Fleetguard AF26433
O.D.: 11 25/32 (299.2)
I.D.: 7 3/4 (196.9) One End
Height: 20 (508.0)



RS5673 Radial Seal Inner Air Element
Fits Inside: RS5672
Replaces: DongFeng Tianlong 11043911216; Fleetguard AF26434
O.D.: 7 1/16 (179.4)
I.D.: 6 15/32 (164.3) One End
Height: 19 5/32 (486.6)



PA5674 Air Element in Disposable Housing
Fits: Pierce-Arrow Fire Trucks
Replaces: Farr 99842002; Wix 46813
O.D.: 10 31/32 (278.6)
Inlet: 7
Outlet: 7 1/16
Height: 25 23/32 (653.3)



RS5675 Radial Seal Outer Air Element
Use With: RS5676
Replaces: Scania 1931040
O.D.: 10 31/32 (278.6)
I.D.: 5 17/32 (140.5) One End
Height: 18 3/8 (466.7)



RS5676 Radial Seal Inner Air Element
Fits Inside: RS5675, RS30130
Replaces: Scania 1931041
O.D.: 5 29/32 (150.0)
I.D.: 4 5/16 (109.5) One End
Height: 16 7/32 (412.0)



PA5678 Foam Cab Air Element
Fits: New Holland Bale Wagons
Replaces: New Holland 593939
Length: 24 9/32 (616.7)
Width: 4 11/32 (110.3)
Height: 31/32 (24.6)



PA5679 Cab Air Element
Fits: IHC 7400 WorkStar, 7500 WorkStar, 7600 WorkStar, 8600 TranStar Trucks
Replaces: International 3839141C1; MicronAir N10215P
Length: 12 1/4 (311.2)
Width: 6 5/32 (156.4)
Height: 1 3/16 (30.2)



PA5680 Cab Air Element
Fits: Caterpillar Engines, Off-Highway Trucks, Wheel Tractors
Replaces: Caterpillar 2593222
Length: 14 7/16 (366.7)
Width: 6 1/32 (153.2)
Height: 2 9/32 (57.9)

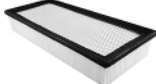

Measurements Are Shown In Inches And (Millimeters)

 **WARNING:** These products can expose you to chemicals, including Diisononyl Phthalate, Carbon black extracts, Nickel, 1,3 Butadiene, Ethylene Oxide, Epichlorohydrin, which are known to the State of California to cause cancer, and Bisphenol, Ethylene Glycol, Ethylene Oxide, 1,3 Butadiene, Epichlorohydrin, which are known to the State of California to cause birth defects or other reproductive harm. For more information go to www.P65Warnings.ca.gov.

PA5681 Cab Air Element
Fits: Euclid, Hitachi Dump Trucks
Replaces: Euclid E12630763; Hitachi 12630763; Donaldson P123229
Length: 16 (406.4)
Width: 11 31/32 (304.0)
Height: 2 3/16 (58.7)



PA5688 Cab Air Element
Fits: Fendt, Massey Ferguson Combines
Replaces: Massey Ferguson 28980100, D28980100; Hifi/Jura Filtration SC60028
Length: 25 9/16 (649.3)
Width: 13 7/8 (352.4)
Height: 1 1/2 (38.1)
A. Gskt: [1] Attached

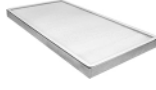

PA5682 Cab Air Element
Fits: Agco, Challenger Tractors
Replaces: Agco 3786649M1, 3786649M2, 3786649M3; Mahle LX1151
Length: 19 11/16 (500.1)
Width: 7 7/8 (200.0)
Height: 2 5/32 (54.8)



PA5689 Cab Air Element
Fits: John Deere Tractors
Replaces: John Deere RE291412; Mann & Hummel CU33128
O.D.: 12 15/16 (328.6)
I.D.: 9 9/16 (242.9)
Height: 2 29/32 (73.8)



PA5683 Cab Air Element with Pull Tab
Fits: Komatsu Equipment
Replaces: Komatsu 22B9791740
Length: 8 19/32 (218.3)
Width: 4 5/32 (105.6)
Height: 31/32 (24.6)
A. Gskt: [1] Attached



PA5690 Foam Cab Air Element
Fits: International 5000 PayStar, 5600 Series, 9100i, 9300, 9900i Trucks
Replaces: International 498144C1
Length: 13 3/8 (339.7)
Width: 12 13/16 (325.4)
Height: 25/32 (19.8)



RS5684 Radial Seal Inner Air Element
Fits Inside: RS4972
Fits: Deutz-Fahr Tractors
Replaces: Deutz 90000592; Renault 7700039510; Donaldson P777779
O.D.: 4 1/8 (104.8)
I.D.: 3 29/32 (99.2) One End
Height: 14 3/32 (358.0)



PA5691 Foam cab Air Element
Fits: International Trucks
Replaces: International 1696834C1
Length: 11 13/16 (300.0)
Width: 11 7/32 (285.0)
Height: 17/32 (14.0)



RS5685 Radial Seal Cab Air Element
Contains: Carbon Activated Inner Core
Fits: Case-International Sprayers, Tractors; New Holland Tractors
Replaces: Case 87267363
O.D.: 6 3/32 (154.8)
I.D.: 2 7/16 (61.9) One End
Height: 13 31/32 (354.8)



RS5692 Radial Seal Air Element
Contains: Flame Retardant Media
Fits: DAF Trucks
Replaces: DAF 1679397; Alco MD7672
O.D.: 9 23/32 (246.9)
I.D.: 6 5/16 (160.3) One End
Height: 15 11/32 (389.7)



PA5686 Cab Air Element with Pull Tabs
Fits: John Deere 643G, 843G Feller Bunchers, 544G, 624G Loaders
Replaces: John Deere AT171176
Length: 19 21/32 (499.3)
Width: 5 9/32 (134.1)
Height: 2 19/32 (65.9)
A. Gskt: [1] Attached



RS5693 Radial Seal Air Element
Fits: Volvo-Penta D12D (12.0L) Engine
Replaces: Volvo 21196919, 3828811
O.D.: 9 25/32 (248.4) to 11 1/16 (281.0)
I.D.: 7 11/32 (186.5) One End
Height: 12 5/16 (312.7)



PA5687 Air Element
Fits: Evobus, Mercedes-Benz, Setra Buses
Replaces: Evobus 6285280606; Mercedes-Benz A6285280606; Donaldson P786816
O.D.: 11 7/8 (301.6)
I.D.: 13/32 (10.3) & 7 17/32 (191.3)
Height: 18 7/8 (479.4)



PA5694 Foam Cab Air Element
Fits: Peterbilt 387, 587 Trucks
Replaces: Peterbilt 525838BSM
Length: 13 11/16 (347.7)
Width: 10 1/32 (254.8)
Height: 25/32 (19.8)



PA5695 Cab Air Element
Fits: Fendt Combines. Tractors
Replaces: Agco 72478600; Fendt H816810140070, H816810140071
Length: 16 1/16 (408.0)
Width: 4 23/32 (119.9)
Height: 2 5/16 (58.7)



Measurements Are Shown In Inches And (Millimeters)

WARNING: These products can expose you to chemicals, including Diisononyl Phthalate, Carbon black extracts, Nickel, 1,3 Butadiene, Ethylene Oxide, Epichlorohydrin, which are known to the State of California to cause cancer, and Bisphenol, Ethylene Glycol, Ethylene Oxide, 1,3 Butadiene, Epichlorohydrin, which are known to the State of California to cause birth defects or other reproductive harm. For more information go to www.P65Warnings.ca.gov.

PA5696



Cab Air Element

Fits: John Deere Combines, Tractors
Replaces: John Deere RE284091;
 Fleetguard AF55740
Length: 24 1/32 (610.4)
Width: 4 1/16 (103.2)
Height: 3 7/16 (87.3)

PA5697

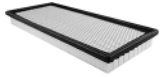

Cab Air Element

Fits: Caterpillar Loaders, Motor Graders
Replaces: Caterpillar 2112660
Length: 15 21/32 (397.7)
Width: 6 7/16 (163.5)
Height: 1 17/32 (38.9)

PA5698



Cab Air Element

Fits: John Deere Loaders
Replaces: John Deere AT359416
Length: 10 19/32 (269.1)
Width: 3 9/16 (90.5)
Height: 1 3/32 (27.8)

PA5699



Air Element

Contains: Flame Retardant Media
Fits: LeTourneau Equipment
Replaces: LeTourneau 4219820
O.D.: 13 7/8 (352.4)
I.D.: 9 1/2 (241.3)
Height: 22 1/2 (571.5)
A. Gskt: [1] Attached
Related To: PA3588 (Different Media)

PA5700



Air Breather Element

Contains: Check Valve
 Clamp
Fits: Volvo Dump Trucks, Equipment
Replaces: Volvo 11172907; Donaldson
 P528708; Fleetguard AF27819
O.D.: 3 7/16 (87.3)
I.D.: 31/32 (24.6) One End
Height: 3 9/16 (90.5)
Grommets: [1] Attached
Related To: PA2798 (without Check Valve)

PA5701



Outer Air Element

Fits: Quangqi Hino Trucks
Use With: PA5702
Replaces: Hino S178013530;
 Weifang APPA11201
O.D.: 12 15/16 (328.6)
I.D.: 13/16 (20.6) & 8 19/32 (218.3)
Height: 16 1/4 (412.8)
A. Gskt: [1] Attached

PA5702



Inner Air Element

Fits Inside: PA5701
Fits: Hino Trucks
Replaces: Hino S178013540;
 Weifang WPPA11202
O.D.: 7 1/4 (184.4)
I.D.: 13/16 (20.6) & 6 3/16 (157.2)
Height: 14 3/32 (358.0)
A. Gskt: [1] Attached

PA5704



Outer Air Element

Fits: Jिंगgang Trucks
Use With: PA5705
Replaces: Hongyan 1109-52/30 Outer;
 Weifang K3052 Outer
O.D.: 12 (304.8)
I.D.: 9/16 (14.3) & 7 11/16 (195.3)
Height: 20 9/32 (515.1)
A. Gskt: [1] Attached

PA5705



Inner Air Element

Fits Inside: PA5704
Fits: Jिंगgang Trucks
Replaces: Hongyan 1109-52/30 Inner;
 Weifang K3052 Inner
O.D.: 7 1/4 (184.2)
I.D.: 9/16 (14.3) & 6 3/16 (157.2)
Height: 19 1/2 (495.3)
A. Gskt: [1] Attached

RS5707



Radial Seal Outer Air Element

Fits: Yutong Buses
Use With: RS5708
Replaces: Yutong AA90141 Outer;
 Weifang K3043 Outer; Fleetguard AF26597
O.D.: 11 25/32 (299.2)
I.D.: 7 3/4 (196.9) One End
Height: 17 (431.8)

RS5708



Radial Seal Inner Air Element

Fits Inside: RS5707
Fits: Yutong Buses
Replaces: Yutong AA90141 Inner; Weifang
 K3043 Inner; Fleetguard AF26598
O.D.: 7 1/16 (179.4)
I.D.: 5 29/32 (150.0) One End
Height: 16 1/4 (412.8)

PA5710



Cab Air Element

Fits: Case-IH, New Holland Tractors
Replaces: New Holland 47128151, 73402760,
 82012057; Donaldson P784574
Length: 20 7/16 (519.1)
Width: 4 1/8 (104.7)
Height: 1 31/32 (50.0)
A. Gskt: [1] Attached

PA5711

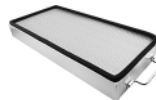

Cab Air Element with Bail Handle

Fits: Case Loaders
Replaces: Case 330014A1
Length: 19 31/32 (507.2)
Width: 9 1/16 (230.2)
Height: 2 19/32 (65.9)
A. Gskt: [1] Attached

PA5712



Cab Air Element with Lift Tab

Fits: John Deere Dump Trucks
Replaces: John Deere TT226019
Length: 14 1/4 (362.0)
Width: 10 23/32 (272.3)
Height: 1 13/32 (35.7)

Measurements Are Shown In Inches And (Millimeters)

WARNING: These products can expose you to chemicals, including Diisononyl Phthalate, Carbon black extracts, Nickel, 1,3 Butadiene, Ethylene Oxide, Epichlorohydrin, which are known to the State of California to cause cancer, and Bisphenol, Ethylene Glycol, Ethylene Oxide, 1,3 Butadiene, Epichlorohydrin, which are known to the State of California to cause birth defects or other reproductive harm. For more information go to www.P65Warnings.ca.gov.

PA5713 Foam Cab Air Element
Fits: John Deere Tractors
Replaces: John Deere R65450
Length: 29 17/32 (750.1)
Width: 4 1/8 (104.8)
Height: 31/32 (24.6)



PA5714 Foam Cab Air Element
Fits: Volvo Loaders
Replaces: Volvo 2815618
Length: 9 1/16 (230.2)
Width: 6 1/8 (155.6)
Height: 1 3/16 (30.2)

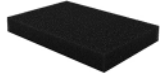

PA5715 Foam Cab Air Element
Fits: Komatsu Dump Trucks
Replaces: Komatsu XA3004
Length: 18 29/32 (480.2)
Width: 3 15/32 (88.1)
Height: 1/2 (12.7)



PA5716 Foam Cab Air Element
Fits: Komatsu Dump Trucks
Replaces: Komatsu BF5467
Length: 18 13/16 (477.8)
Width: 4 1/8 (104.8)
Height: 1/2 (12.7)



PA5717 Foam Cab Air Element
Fits: Caterpillar 307 Excavator
Replaces: Caterpillar 1199431
Length: 22 29/32 (581.8)
Width: 2 15/16 (74.6)
Height: 15/32 (11.9)



PA5718 KIT Set of 2 Foam Cab Air Elements
Notes: Uses 2 filters per application.
Fits: New Holland Loaders
Replaces: New Holland 76043561
Each Filter:
Length: 18 17/32 (470.7)
Width: 3 17/32 (89.7)
Height: 1/2 (12.7)



PA5719 Foam Cab Air Element
Fits: Caterpillar Loaders
Replaces: Caterpillar 1429291
Length: 7 (177.8)
Width: 5 15/32 (138.9)
Height: 1/2 (12.7)

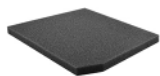

PA5720 Cab Air Element
Fits: Caterpillar Excavators
Replaces: Caterpillar 3276618
Length: 10 15/16 (277.8)
Width: 7 7/16 (188.9)
Height: 1 9/16 (39.7)
A. Gskt: [1] Attached



PA5721 Foam Cab Air Element
Fits: Volvo Motor Graders
Replaces: Volvo 96913
Length: 11 11/16 (296.9)
Width: 5 1/8 (130.2)
Height: 3/8 (9.5)



PA5722 Cab Air Element
Fits: Freightliner Trucks
Replaces: Freightliner 2246891000
Length: 8 5/8 (219.1)
Width: 7 11/16 (195.3)
Height: 31/32 (24.6)



PA5723 Cab Air Element
Fits: Hitachi, John Deere Excavators
Replaces: Hitachi 4455778, 4S00688;
 John Deere 4455778, 4S00688
Length: 8 21/32 (219.9)
Width: 4 7/8 (123.8)
Height: 19/32 (15.1)
A. Gskt: [1] Attached

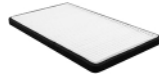

PA5724 Air Element
Fits: John Deere Lawn & Garden Tractors
Use With: PA5724 FOAM
Replaces: John Deere M144816, M152049
O.D.: 7 13/16 (198.4)
I.D.: 5 7/8 (149.2) One End
Height: 2 15/16 (74.6)
A. Gskt: [1] Attached



PA5724 FOAM Foam Wrap for PA5724
Fits: John Deere Lawn & Garden Tractors
Use With: PA5724
Replaces: John Deere M148207
O.D.: 11 13/32 (289.7)
Width: 3/8 (9.5)
Height: 2 9/16 (65.1)



PA5725 Cab Air Element
Contains: Charcoal Impregnated Media for Odor Control
Fits: Case Loaders
Replaces: Case 87656118;
 New Holland 87656118
Length: 14 1/2 (368.3)
Width: 6 11/32 (161.1)
Height: 15/16 (23.8)

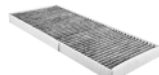

PA5726 Foam Cab Air Element
Fits: John Deere Tractors
Replaces: John Deere R131204
Length: 29 29/32 (759.6)
Width: 4 5/32 (105.6)
Height: 1/2 (12.7)



PA5727 Foam Cab Air Element
Fits: John Deere Skidders
Replaces: John Deere T183432
Length: 12 29/32 (327.8)
Width: 3 17/32 (89.7)
Height: 1/2 (12.7)



PA5728 Oval Air Element
Fits: John Deere Lawn & Garden Equipment
Use With: PA5728 FOAM
Replaces: John Deere M150949;
 Kawasaki 110137027
O.D.: 3 9/16 (90.5) to 7 5/16 (185.7)
I.D.: 1 3/16 (30.2) & 5 7/16 (138.1)
Height: 3 1/4 (82.6)
A. Gskt: [1] Attached



PA5728 FOAM Foam Wrap for PA5728
Fits: John Deere Lawn & Garden Equipment
Use With: PA5728
Replaces: John Deere M140295
O.D.: 8 1/32 (204.0)
I.D.: 7 3/32 (180.2)
Length: 2 23/32 (69.1)



Measurements Are Shown In Inches And (Millimeters)

WARNING: These products can expose you to chemicals, including Diisononyl Phthalate, Carbon black extracts, Nickel, 1,3 Butadiene, Ethylene Oxide, Epichlorohydrin, which are known to the State of California to cause cancer, and Bisphenol, Ethylene Glycol, Ethylene Oxide, 1,3 Butadiene, Epichlorohydrin, which are known to the State of California to cause birth defects or other reproductive harm. For more information go to www.P65Warnings.ca.gov.

PA5729

Cab Air Element with Handle and Foam Pre-Cleaner

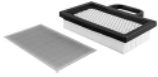

Fits: John Deere Lawn & Garden Equipment
Replaces: Briggs & Stratton 499486S;
 John Deere GY20575
Length: 5 29/32 (150.0)
Width: 4 7/32 (107.2)
Height: 1 17/32 (38.9)

RS5730

Radial Seal Outer Air Element



Fits: Volvo Trucks with D13C Engine
Use With: RS5731
Replaces: Volvo 21115483
O.D.: 12 3/32 (332.6)
I.D.: 8 9/32 (210.3)
Height: 16 1/8 (409.6)

RS5731

Radial Seal Inner Air Element



Fits Inside: RS5730
Fits: Volvo Trucks
Replaces: Volvo 21115501;
 Hengst E1024LS; Mahle LXS300
O.D.: 7 21/32 (194.5)
I.D.: 6 31/32 (177.0) One End
Height: 14 9/32 (362.7)
O-Ring: [1] Attached

PA5732

Foam Cab Air Element



Fits: Case, New Holland Dozers
Replaces: Case 76092242;
 New Holland 76092242
Length: 15 9/16 (395.3)
Width: 8 9/32 (210.3)
Height: 3/16 (4.8)

PA5733

Panel Air Element



Fits: Onan Generators
Replaces: Onan 1403116
Length: 10 1/4 (260.4)
Width: 6 17/32 (165.9)
Height: 1 13/32 (35.7)

PA5734

Cab Air Element

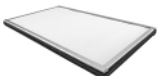

Fits: Case, New Holland Loaders
Replaces: Case 78314367;
 New Holland 87314367
Length: 16 3/8 (415.9)
Width: 9 27/32 (250.0)
Height: 27/32 (21.4)
A. Gskt: [1] Attached

PA5735

Air Element in Disposable Housing



Fits: Peterbilt Trucks
Replaces: Farr 400820023;
 Paccar 400820023; Parker 400820023;
 Racor 400820023
O.D.: 10 31/32 (278.6)
Inlet: 7
Outlet: 5 29/32
Height: 14 29/32 (378.6)

PA5736

Cab Air Element

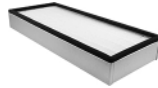

Fits: Caterpillar Scrapers, Wheel Tractors
Replaces: Caterpillar 3E7319
Length: 18 19/32 (472.3)
Width: 7 7/8 (200.0)
Height: 2 19/32 (65.9)
A. Gskt: [1] Attached

PA5737 KIT

Air Element with Foam Wrap



Fits: John Deere, Sabre, Scotts Lawn & Garden Equipment
Replaces: John Deere GY20576;
 Kohler 2408303
O.D.: 6 15/16 (176.2)
I.D.: 5 9/16 (141.3)
Height: 2 15/16 (74.6)

PA5738

Cab Air Element



Fits: Caterpillar Loaders
Replaces: Caterpillar 2318130, 3036658
Length: 8 11/32 (211.9)
Width: 3 21/32 (92.9)
Height: 1 17/32 (38.9)
A. Gskt: [2] Attached

PA5739

Cab Air Element



Fits: Case, New Holland Loaders
Replaces: Case 139768A1; Donaldson P784574
Length: 12 1/16 (306.4)
Width: 4 1/32 (102.4)
Height: 2 7/16 (61.9)
A. Gskt: [1] Attached

PA5740

Cab Air Element

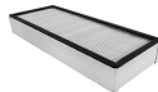

Fits: Case, New Holland Dozers
Replaces: Case 76092248
Length: 14 31/32 (380.2)
Width: 5 27/32 (148.4)
Height: 2 3/32 (53.2)

RS5741

Radial Seal Outer Air Element



Fits: Bobcat Loaders
Use With: RS5742
Replaces: Bobcat 6698057
O.D.: 6 1/8 (155.6)
I.D.: 3 9/16 (90.5) One End
Height: 12 1/16 (306.4)

RS5742

Radial Seal Inner Air Element



Fits Inside: RS5741
Fits: Bobcat Loaders
Replaces: Bobcat 6698058;
 Fleetguard AF26365
O.D.: 3 3/8 (85.7)
 Flange 5 3/32 (129.4)
I.D.: 2 11/16 (68.3) One End
Height: 10 15/16 (277.8)

Measurements Are Shown In Inches And (Millimeters)



WARNING: These products can expose you to chemicals, including Diisononyl Phthalate, Carbon black extracts, Nickel, 1,3 Butadiene, Ethylene Oxide, Epichlorohydrin, which are known to the State of California to cause cancer, and Bisphenol, Ethylene Glycol, Ethylene Oxide, 1,3 Butadiene, Epichlorohydrin, which are known to the State of California to cause birth defects or other reproductive harm. For more information go to www.P65Warnings.ca.gov.

RS5743



Radial Seal Outer Air Element with Bail Handle
Fits: Komatsu Dump Trucks
Replaces: Komatsu XA4292; Donaldson P608306; Fleetguard AF27696
O.D.: 17 23/32 (450.1)
I.D.: 11 7/16 (290.5) One End
Height: 24 7/8 (631.8)

RS5748



Radial Seal Inner Air Element
Fits Inside: RS5747
Fits: Bobcat Loaders
Replaces: Bobcat 7008044
O.D.: 3 3/8 (85.7)
 Flange 5 3/32 (129.4)
I.D.: 2 3/4 (69.9) One End
Height: 9 3/16 (233.4)

RS5743XP



Extreme Performance Nano Radial Seal Outer Air Element with Bail Handle
Fits: Caterpillar Off-Highway Trucks
Use With: RS5744
Replaces: Caterpillar 4199162; Donaldson P608306; Fleetguard AF27696
O.D.: 17 23/32 (450.1)
I.D.: 11 7/16 (290.5) One End
Height: 24 7/8 (631.8)

RS5749



Radial Seal Outer Air Element
Fits: Harlo HP5000, HP6500 Lift Trucks; Reed B20 Concrete Pump
Replaces: Fleetguard AF26120
O.D.: 7 1/2 (190.5)
I.D.: 5 11/16 (144.5) One End
Height: 14 13/16 (376.2)

RS5744



Radial Seal Inner Air Element
Fits Inside: RS5743XP
Fits: Caterpillar Off-Highway Trucks
Replaces: Caterpillar 2673005; Donaldson P608305; Fleetguard AF27695
O.D.: 11 9/16 (293.7)
I.D.: 9 (228.6) One End
Height: 19 1/4 (489.0)

RS5750



Radial Seal Inner Air Element
Fits: Harlo HP5000, HP6500 Lift Trucks
Replaces: Fleetguard AF26121; Nelson 871402N
O.D.: 4 1/8 (104.8)
 Flange 5 7/8 (149.2)
I.D.: 2 15/16 (74.6) One End
Height: 14 1/8 (358.8)

RS5745



Radial Seal Outer Air Element
Fits: Yale Equipment using 8 Inch OptiAir Series Housings
Use With: RS5746
Replaces: Yale 580088196
O.D.: 6 1/4 (158.8)
I.D.: 3 9/16 (90.5) One End
Height: 14 1/16 (357.2)

PA5751



Outer Air Element
Fits: Challenger, Gleaner, Massey Ferguson Combines
Use With: PA2410
Replaces: Agco 71368961
O.D.: 12 3/32 (307.2)
I.D.: 7/8 (22.2) & 7 23/32 (196.1)
Height: 18 1/32 (458.0)
F. Gskt: [1] Steel Washer

RS5746



Radial Seal Inner Air Element
Fits Inside: RS5745
Fits: Yale Equipment using 8 Inch OptiAir Series Housings
Replaces: Fleetguard AF25961; Wix 49868
O.D.: 3 3/8 (85.7)
 Flange 5 3/32 (129.4)
I.D.: 2 7/8 (73.0) One End
Height: 13 3/32 (332.6)

PA5752



Cab Air Element
Fits: Caterpillar Loaders
Replaces: Caterpillar 2112661; Donaldson P627028; Fleetguard AF27911
O.D.: 6 1/8 (155.6)
I.D.: 21/32 (16.7) & 3 15/32 (88.1)
Height: 9 1/2 (241.3)
A. Gskt: [1] Attached
F. Gskt: [1] Wing Nut

RS5747



Radial Seal Outer Air Element
Fits: Bobcat Loaders
Use With: RS5748
Replaces: Bobcat 7008043
O.D.: 6 1/4 (158.8)
I.D.: 3 9/16 (90.5) One End
Height: 10 1/16 (255.6)

PA5753

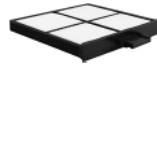

Cab Air Element with Pull Tab
Fits: Kobelco, New Holland Excavators
Replaces: Case YN50V01015P3, YN50V01015P3P; New Holland YN50V01015P3, YN50V01015P3P
Length: 8 11/32 (211.9)
Width: 7 1/2 (190.5)
Height: 1 1/16 (27.0)
A. Gskt: [1] Attached

Measurements Are Shown In Inches And (Millimeters)

WARNING: These products can expose you to chemicals, including Diisononyl Phthalate, Carbon black extracts, Nickel, 1,3 Butadiene, Ethylene Oxide, Epichlorohydrin, which are known to the State of California to cause cancer, and Bisphenol, Ethylene Glycol, Ethylene Oxide, 1,3 Butadiene, Epichlorohydrin, which are known to the State of California to cause birth defects or other reproductive harm. For more information go to www.P65Warnings.ca.gov.

RS5754



Radial Seal Air Element with Lid
Contains: Bleed Valve
 Flame Retardant Media
Fits: DAF Trucks with PACCAR Engines
Replaces: DAF 1854407, 1931681, 1931685;
 Donaldson P951919
O.D.: 10 31/32 (278.6)
 Lid 13 19/32 (345.3)
I.D.: 5 25/32 (146.8) One End
Height: 20 5/32 (512.0)

RS5761



Radial Seal Cab Air Element
Contains: Charcoal Impregnated Media for
 Odor Control
Fits: Caterpillar Motor Graders, Off-Highway
 Trucks
Replaces: Caterpillar 2208800
O.D.: 6 15/32 (164.3)
I.D.: 3 5/8 (92.1) One End
Height: 11 21/32 (296.1)
Related To: RS5305 (Standard Media Version)

PA5755



Cab Air Element
Fits: Caterpillar Crawler Tractors
Replaces: Caterpillar 2653857, 3197944
Length: 20 25/32 (527.8)
Width: 3 31/32 (100.8)
Height: 3 5/8 (92.1)
A. Gskt: [1] Attached
F. Gskt: [1] Included

PA5762



Air Element
Fits: Caterpillar Gen Sets, Gen Set Engines
Replaces: Caterpillar 9Y3879
O.D.: 12 19/32 (319.9)
I.D.: 6 (152.4) One End
Height: 13 11/32 (338.9)

RS5756



Radial Seal Air Element
Fits: Blue Bird Buses
Replaces: Blue Bird 10004113;
 Racor 500454001, 500454001BB
O.D.: 11 3/8 (288.9)
I.D.: 6 3/8 (161.9) One End
Height: 19 11/16 (500.1)
F. Gskt: [1] Included

PA5763



Outer Air Element
Fits: Valmet, Valtra Tractors
Use With: PA5764
Replaces: Agco 20228310, 836462568
O.D.: 6 1/2 (165.1)
I.D.: 13/32 (10.3) & 3 3/8 (85.7)
Height: 15 (381.0)
A. Gskt: [1] Attached

PA5757



Cab Air Element
Fits: Caterpillar Crawler Tractors
Replaces: Caterpillar 2380479
Length: 20 (508.0)
Width: 3 15/16 (100.0)
Height: 3 9/16 (90.5)
A. Gskt: [1] Attached

PA5764



Inner Air Element
Fits Inside: PA5763
Fits: Valtra Tractors
Replaces: Agco 20228410, 836462569
O.D.: 3 1/2 (88.9)
I.D.: 13/32 (10.3) & 2 13/16 (71.4)
Height: 14 3/4 (374.6)
A. Gskt: [1] Attached

RS5758



Radial Seal Outer Air Element with Pull Tabs
Use With: RS5759
Replaces: Longgong 612600114993 Outer;
 Weifang KX2400 Outer
O.D.: 9 1/2 (241.3)
I.D.: 8 1/8 (206.4) One End
Height: 16 9/32 (413.5)
A. Gskt: [1] Attached

PA5765

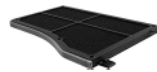

Foam Cab Air Element
Fits: Peterbilt Trucks
Replaces: Peterbilt 5S013817, 5X013817
Length: 13 11/32 (338.9)
Width: 9 3/32 (231.0)
Height: 5/8 (15.9)

RS5759



Radial Seal Inner Air Element
Fits Inside: RS5758
Replaces: Longgong 612600114993 Inner;
 Weifang KX2400 Inner
O.D.: 5 21/32 (143.7)
I.D.: 4 7/16 (112.7) One End
Height: 16 1/4 (412.8)

PA5766



Cab Air Element
Fits: Komatsu Dump Trucks, Loaders
Replaces: Komatsu 4260732441
Length: 12 1/4 (311.2)
Width: 9 31/32 (253.2)
Height: 1 3/4 (44.5)

RS5767



Radial Seal Air Element
Contains: Air Divider Hose Connection
Fits: Chevrolet, GMC, Isuzu Trucks;
 Isuzu 6HK1-TC 7.8L Engine
Replaces: General Motors 19179832;
 Isuzu 19179832; ACDelco A3101C
O.D.: 7 13/16 (198.4)
I.D.: 4 27/32 (123.0) One End
Height: 19 23/32 (500.9)

Measurements Are Shown In Inches And (Millimeters)

! **WARNING:** These products can expose you to chemicals, including Diisononyl Phthalate, Carbon black extracts, Nickel, 1,3 Butadiene, Ethylene Oxide, Epichlorohydrin, which are known to the State of California to cause cancer, and Bisphenol, Ethylene Glycol, Ethylene Oxide, 1,3 Butadiene, Epichlorohydrin, which are known to the State of California to cause birth defects or other reproductive harm. For more information go to www.P65Warnings.ca.gov.

PA5768 Cab Air Element
Fits: John Deere Equipment
Replaces: John Deere RE195491
Length: 12 3/32 (307.2)
Width: 4 7/32 (107.2)
Height: 1 3/16 (30.2)



PA5779 Cab Air Element
Fits: Citroen Jumper, Fiat Ducato Trucks
Replaces: Fiat 1312764080, 1312766080
Length: 17 9/32 (438.9)
Width: 5 21/32 (143.7)
Height: 21/32 (16.7)



PA5770 Cab Air Element
Fits: Caterpillar Equipment
Replaces: Caterpillar 2656618
Length: 12 23/32 (323.1)
Width: 5 27/32 (148.4)
Height: 2 7/32 (56.4)

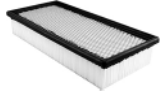

PA5780 Cab Air Element with Handle
Contains: 8 Inch Metal Handle
Fits: Volvo Motor Graders
Replaces: Volvo 12742527
Length: 33 31/32 (862.8)
Width: 5 15/16 (150.8)
Height: 1 21/32 (42.1)
A. Gskt: [2] Attached



PA5771 Cab Air Element
Fits: John Deere Dozers
Replaces: John Deere AT315958
Length: 26 7/32 (666.0)
Width: 6 1/2 (165.1)
Height: 2 7/32 (56.4)



PA5781 Cab Air Element with Pull Strap
Fits: Volvo Motor Graders
Replaces: Volvo 12742526
Length: 25 31/32 (659.6)
Width: 5 15/16 (150.8)
Height: 1 21/32 (42.1)
A. Gskt: [2] Attached



PA5772 Cab Air Element
Fits: Caterpillar Off-Highway Trucks, Pipelayers, Telehandlers
Replaces: Caterpillar 2015023
Length: 10 3/8 (263.5)
Width: 7 (177.8)
Height: 1 13/32 (35.7)

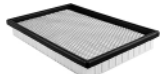

RS5782 Radial Seal Conical Shaped Outer Air Element
Notes: MUST be used with RS5783 Inner Air Element
Fits: John Deere Excavators, Loaders; New Holland Excavators
Use With: RS5783
Replaces: John Deere AT332908; Baldwin PA5501
O.D.: 6 1/16 (154.0) to 7 23/32 (196.1)
I.D.: 4 11/16 (119.1) One End
Height: 14 (355.6)



PA5773 Foam Cab Air Element
Fits: Freightliner Trucks
Replaces: Alliance ABPN/10G/91621
Length: 10 1/8 (257.2)
Width: 5 1/32 (127.8)
Height: 3/16 (4.8)



RS5783 Radial Seal Conical Shaped Inner Air Element
Fits Inside: RS5782
Fits: John Deere Excavators, Loaders; New Holland Excavators
Replaces: John Deere AT332909; Baldwin PA5502
O.D.: 3 3/16 (81.0) to 4 31/32 (126.2)
I.D.: 4 3/16 (106.4) One End
Height: 13 11/16 (347.7)



PA5774 Cab Air Element
Fits: Caterpillar Loaders, Skid Steers
Replaces: Caterpillar 2656619
Length: 10 5/8 (269.9)
Width: 4 3/4 (120.7)
Height: 2 7/32 (56.4)



RS5776 Radial Seal Air Element
Contains: Flame Retardant Media
Fits: Volvo Trucks
Replaces: Volvo 21834210; Fleetguard AF25632; Mahle LX1281
O.D.: 14 (355.6)
I.D.: 7 25/32 (197.6) One End
Height: 16 1/4 (412.8)
Related To: RS4967 (Standard Media Version)



RS5784 Radial Seal Air Element
Fits: Ingersoll Rand Compressors
Replaces: Ingersoll Rand 54471834
O.D.: 6 1/2 (165.1)
I.D.: 3 3/4 (95.3) One End
Height: 14 (355.6)



PA5777 Cab Air Element
Fits: Valtra Tractors
Replaces: Agco 20531310
Length: 18 11/32 (465.9)
Width: 7 (177.8)
Height: 2 5/32 (54.8)
A. Gskt: [2] Attached

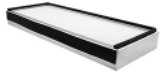

PA5785 Outer Air Element with Blank Band
Fits: Valmet Forestry Equipment, Tractors
Use With: PA5786
Replaces: Agco 836128654; Valmet V836128654
O.D.: 6 5/8 (168.3)
Flange: 7 11/16 (195.3)
I.D.: 11/32 (8.7) & 4 21/32 (118.3)
Height: 13 7/8 (352.4)
A. Gskt: [2] Attached



PA5778 Cab Air Element
Fits: Turismo Buses
Replaces: Mercedes-Benz A3568304218; Evobus 3568304218
Length: 13 11/16 (347.7)
Width: 5 11/16 (144.5)
Height: 9/16 (14.3)
A. Gskt: [1] Attached

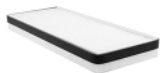

Measurements Are Shown In Inches And (Millimeters)

WARNING: These products can expose you to chemicals, including Diisononyl Phthalate, Carbon black extracts, Nickel, 1,3 Butadiene, Ethylene Oxide, Epichlorohydrin, which are known to the State of California to cause cancer, and Bisphenol, Ethylene Glycol, Ethylene Oxide, 1,3 Butadiene, Epichlorohydrin, which are known to the State of California to cause birth defects or other reproductive harm. For more information go to www.P65Warnings.ca.gov.

PA5786



Inner Air Element

Fits Inside: PA5785, PA5787
Fits: Valmet Forestry Equipment, Tractors;
 Valtra Tractors
Replaces: Agco 836128655;
 Valmet V836128655
O.D.: 4 1/2 (114.3)
I.D.: 11/32 (8.7) & 3 3/32 (78.6)
Height: 13 (330.2)

PA5787



Outer Air Element with Blank Band and Lift Tab

Fits: Valmet Forestry Equipment, Tractors
Use With: PA5786
Replaces: Agco 836136409;
 Valmet V836136409
O.D.: 6 5/8 (168.3)
 Flange 7 11/16 (195.3)
I.D.: 11/32 (8.7) & 4 21/32 (118.3)
Height: 13 25/32 (350.0)
A. Gskt: [2] Attached

CA5788



Channel Flow Primary Air Element

Fits: Ag-Chem, Agco, Apache, Challenger,
 Fendt, Massey Ferguson, Valtra Equipment
Use With: PA5515
Replaces: Fendt H931202090410;
 J.C. Bamford 32/925752;
 Massey Ferguson 4286479M2
O.D.: 8 9/32 (210.3) to 13 13/32 (340.5)
Height: 11 7/32 (285.0)

CA5789



Channel Flow Primary Air Element

Fits: Mack Trucks
Use With: PA5792
Replaces: Mack 57MD321M, 21020786;
 Case/New Holland N102191;
 Volvo 43863232
O.D.: 10 7/32 (259.6) to 15 5/8 (396.9)
Height: 13 1/4 (336.6)

CA5790



Channel Flow Air Element

Fits: Freightliner Trucks
Replaces: Freightliner 333648001, P610260;
 Donaldson P618478
Length: 26 1/8 (663.6)
Width: 5 1/4 (133.4)
Height: 9 9/32 (235.7)

CA5791



Channel Flow Primary Air Element

Fits: Case, Case-IH,
 New Holland Equipment
Use With: PA5792
Replaces: Case 87356545;
 New Holland 87356545
O.D.: 11 1/4 (285.8) to 15 1/16 (382.8)
Height: 9 5/16 (236.5)

PA5792



Channel Flow Secondary Air Element with Pull Handle

Fits: Case, Case-IH, New Holland Equipment
Use With: CA5789, CA5791
Replaces: Case 87356547
O.D.: 9 7/16 (192.1) to 14 3/4 (374.7)
Height: 2 5/16 (58.7)
A. Gskt: [1] Attached

CA5793



Channel Flow Air Element

Fits: 1999-2003 Ford F450 Super Duty, F550
 Super Duty Trucks, 2000-03 Excursion all with
 V8-445 (7.3L) Turbo Diesel Engine
Replaces: Ford 2U2Z9601BA, 2U2J9601BA;
 Motorcraft FA1757
O.D.: 5 5/8 to 12 7/8 (142.9 to 327.0)
 Flange 8 to 14 3/8 (203.2 to 365.1)
Height: 6 (152.4)

PA5796

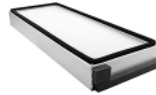

Cab Air Element

Fits: Challenger, Valtra Tractors
Replaces: Agco 20531300;
 Donaldson P750026
Length: 19 1/16 (484.2)
Width: 6 15/16 (176.2)
Height: 2 1/8 (54.0)
A. Gskt: [2] Attached

PA5797

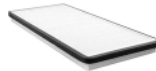

Cab Air Element

Fits: Volvo Buses
Replaces: Volvo 20746873, 2130158,
 70326723, 85107862
Length: 15 31/32 (405.6)
Width: 7 1/16 (179.4)
Height: 1 3/16 (30.2)
A. Gskt: [1] Attached

PA5798



Cab Air Element

Fits: Citroen, Fiat, Peugeot Trucks
Replaces: Citroen 6447YA, 6479C9;
 Peugeot 6447YA
Length: 9 27/32 (250.0)
Width: 9 1/4 (235.0)
Height: 31/32 (24.6)

PA5799



Air Element

Replaces: Jinan Diesel 301236M1030
O.D.: 19 9/32 (489.7)
I.D.: 12 7/16 (315.9)
Height: 14 9/32 (362.7)
A. Gskt: [2] Attached

BF5800



Primary Fuel Spin-on

Notes: Can be used with FB1301 base.
Fits: Detroit Diesel Engines
Replaces: Detroit Diesel 6438839;
 GMC 25010793
Thread: 1 -12
O.D.: 3 11/16 (93.7)
Height: 8 (203.2)
I.Gskt: [1] Included
Related To: BF592 (Short Version)
 BF5813 (Fuel/Water Separator Version)

Measurements Are Shown In Inches And (Millimeters)



WARNING: These products can expose you to chemicals, including Diisononyl Phthalate, Carbon black extracts, Nickel, 1,3 Butadiene, Ethylene Oxide, Epichlorohydrin, which are known to the State of California to cause cancer, and Bisphenol, Ethylene Glycol, Ethylene Oxide, 1,3 Butadiene, Epichlorohydrin, which are known to the State of California to cause birth defects or other reproductive harm. For more information go to www.P65Warnings.ca.gov.

BF5801

Primary Fuel Spin-on



Notes: CAUTION: Do NOT use on Cummins engines. Furnished D-Ring must be installed on post for seal.
Can be used with FB1311 base.
Fits: Detroit Diesel Engines Using Cummins Fuel Filter Base
Thread: 1 -14
O.D.: 3 11/16 (93.7)
Height: 8 1/32 (204.0)
I.Gskt: G381-A
F. Gskt: ES24-D

BF5815

Secondary Fuel Spin-on



Contains: Integral Post Seal
Fits: Detroit Diesel Engines
Replaces: Detroit Diesel 23518530
Thread: 13/16 -12
O.D.: 3 11/16 (93.7)
Height: 7 3/32 (180.2)
I.Gskt: [1] Included

BF5810

Secondary Fuel Spin-on



Notes: Can be used with FB1302 base.
Contains: Integral Post Seal
Fits: Detroit Diesel Engines
Replaces: Detroit Diesel 23518482
Thread: 13/16 -12
O.D.: 3 11/16 (93.7)
Height: 7 3/32 (180.2)
I.Gskt: [1] Included

BF5816

High Efficiency Secondary Fuel Spin-on



Contains: Integral Post Seal
Fits: Detroit Diesel Engines
Replaces: Detroit Diesel 23533726
Thread: 13/16 -12
O.D.: 3 11/16 (93.7)
Height: 7 3/32 (180.2)
I.Gskt: [1] Included

BF5812

Primary Fuel/Water Separator Spin-on with Drain



Notes: CAUTION: Do NOT use on Cummins engines. Furnished D-Ring must be installed on post for seal.
Can be used with FB1311 base.
Fits: Detroit Diesel Engines with Cummins Fuel Filter Base
Replaces: Detroit Diesel 23516189
Thread: 1 -14
O.D.: 3 11/16 (93.7)
Height: 8 27/32 (224.6)
I.Gskt: G381-A
F. Gskt: ES24-D

6020

Transmission Filter



Notes: Pan gasket contains [13] bolt holes.
Fits: 1967-80 Buick, Oldsmobile, Pontiac, 1963-84, 1988-90 Cadillac, 1968-90 Chevrolet, 1967-90 GMC, 1992-93 Hummer, 1975-92 Jaguar; 1972 International Light-Duty Trucks; 1968-79 Jeep Automotive with THM375
Replaces: GMC 12337210
Length: 11 23/32 (297.7)
Width: 6 1/2 (165.1)
Height: 5/8 (15.9)
Grommets: [1] Attached
Pan Gasket: [1] Included, Plus One Small O-Ring

BF5813

Primary Fuel/Water Separator Spin-on with Drain



Notes: Can be used with FB1301 base.
Fits: Detroit Diesel Engines
Replaces: GMC 23512317
Thread: 1 -12
O.D.: 3 11/16 (93.7)
Height: 8 13/16 (223.8)
I.Gskt: [1] Included
O. Gskt: ES24-D (for Caterpillar Engines)
Related To: BF5800 (Fuel Version)

6021

Transmission Filter

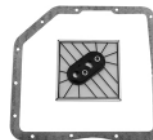

Notes: Pan gasket contains [13] bolt holes.
Fits: 1966-74, 1982-84 Buick, 1982 Cadillac, 1967-84, 1986 Chevrolet, 1969-84, 1986 GMC Light-Duty Trucks, 1968-74, 1981-84 Oldsmobile, 1969-83 Pontiac Automotive, 1965-67 Jeep with THM250C, THM350, THM350C
Replaces: GMC 6433856
Width: 5 5/8 (142.9)
O-Ring: [1] Included
Pan Gasket: [1] Included

BF5813-O

Fuel/Water Separator with Open End for Bowl



Fits: Isuzu Trucks
Replaces: Racor S3202T; Isuzu 8156189210; General Motors Corp. 156189210
Thread: 1 -12 UNF-2B
O.D.: 3 3/4 (95.3)
Height: 7 13/32 (188.1)
F. Gskt: [2] Included
O-Ring: [1] Included
Related To: BF5813 (Drain Version)
BF5800 (Fuel Version)

BK6022

Service Kit for Detroit Diesel



Contains: [2] B495 Lube
[1] PF7744 Pri. Fuel
[1] BF5810 Sec. Fuel
[1] CTK5029-1 Coolant Test Strip

BK6023

Service Kit for Detroit Diesel



Contains: [2] B495 Lube
[1] BF1395-SP Fuel/Water Separator
[1] CTK5029-1 Coolant Test Strip

Measurements Are Shown In Inches And (Millimeters)

WARNING: These products can expose you to chemicals, including Diisononyl Phthalate, Carbon black extracts, Nickel, 1,3 Butadiene, Ethylene Oxide, Epichlorohydrin, which are known to the State of California to cause cancer, and Bisphenol, Ethylene Glycol, Ethylene Oxide, 1,3 Butadiene, Epichlorohydrin, which are known to the State of California to cause birth defects or other reproductive harm. For more information go to www.P65Warnings.ca.gov.

BK6024

Service Kit for Cummins

Contains: [1] BD7154 Dual-Flow Lube
[1] PF7680 Fuel/Water Separator
[1] CTK5029-1 Coolant Test Strip



BK6025

Service Kit for Cummins

Contains: [1] BD7154 Dual-Flow Lube
[1] BF7766 Fuel
[1] CTK5029-1 Coolant Test Strip



BK6026

Service Kit for Mercedes-Benz

Contains: [1] P7230 Lube
[1] PF7744 Pri. Fuel
[1] PF7761 Fuel
[1] CTK5029-1 Coolant Test Strip



BK6027

Service Kit for Volvo

Contains: [2] B76 F-F Lube
[1] BC7242 By-Pass Lube
[1] BF1384-SP Fuel/Water Separator
[1] BF7814 Fuel



BK6028

Service Kit

Contains: [1] BD7153 Dual-Flow Lube
[2] BF1212 Pri. Fuel
[1] BW5073 Coolant
[2] BT8873 Hydraulic
[1] BT839-10 Hydraulic



BK6029

Service Kit for Mack

Contains: [2] B76 F-F Lube
[1] BC7228 By-Pass Lube Spinner
[1] BF7656 Pri. Fuel
[1] BF7657 Sec. Fuel



BK6030

Service Kit

Contains: [1] BT215 Lube
[1] PF717 Pri. Fuel
[1] BT351 Hydraulic
[1] PT9167 Hydraulic

Image Not Available.

BK6031

Service Kit for Cummins

Contains: [1] B7177 Lube Spin-on
[1] BF1378-SPS Fuel/Water Separator Spin-on
[1] BF7940 Fuel Spin-on



BK6032

Service Kit for Cummins

Contains: [1] BD7309 Dual-Flow Lube
[1] BF1378-SPS Fuel/Water Separator
[1] BF7924 Fuel



BK6033

Service Kit for International

Contains: [1] P7329 Lube
[1] PF7748 Fuel/Water Separator
[1] PF7928 Fuel

Image Not Available.

BK6034

Service Kit for International

Contains: [1] B7030 Lube
[1] BF7629 Pri. Fuel
[1] BF7584 Fuel/Water Separator

Image Not Available.

BK6035

Service Kit for Cummins

Contains: [1] BD7309 Dual-Flow Lube
[1] BF7924 Fuel



BK6041

Service Kit

Contains: [1] B7030 Lube
[1] BF7531 Pri. Fuel
[1] PT8487 Steering

Image Not Available.

BK6043

Service Kit

Contains: [1] BD7309 Dual-Flow Lube
[1] BF1272-SPS Fuel/Water Separator
[1] BW5071 Coolant
[1] PT8487 Steering

Image Not Available.

BK6044

Service Kit for Mack









Contains: [2] B76 F-F Lube
[1] B7409 By-Pass Lube
[1] BF1386-O Fuel/Water Separator
[1] BF7943 Fuel
[1] B5091 Coolant

Image Not Available.

Measurements Are Shown In Inches And (Millimeters)









WARNING: These products can expose you to chemicals, including Diisononyl Phthalate, Carbon black extracts, Nickel, 1,3 Butadiene, Ethylene Oxide, Epichlorohydrin, which are known to the State of California to cause cancer, and Bisphenol, Ethylene Glycol, Ethylene Oxide, 1,3 Butadiene, Epichlorohydrin, which are known to the State of California to cause birth defects or other reproductive harm. For more information go to www.P65Warnings.ca.gov.

<p>BK6045 Service Kit</p> <p>Image Not Available.</p> <p>Contains: [1] BD7309 Dual-Flow Lube [1] BF7815 Fuel [1] BW5074 Coolant</p>	<p>BK6054 Service Kit for Mack</p>  <p>Contains: [2] B76 F-F Lube [1] BC7242 By-Pass Lube [1] BF7943 Fuel [1] BF1386-O Fuel/Water Separator</p>
<p>BK6046 Service Kit</p> <p>Image Not Available.</p> <p>Contains: [1] B99 Lube [1] BF7632 Fuel [1] BW5139 Coolant</p>	<p>BK6055 Service Kit for Cummins</p> <p>Image Not Available.</p> <p>Contains: [1] BD7153 Dual-Flow Lube [1] PF7766 Fuel [1] PF7755 Fuel/Water Separator</p>
<p>BK6047 Service Kit</p> <p>Image Not Available.</p> <p>Contains: [1] BT339 Lube [1] BF1212 Fuel/Water Separator [1] BF1352-SPS Fuel/Water Separator [1] BT839-10 Hydraulic</p>	<p>BK6056 Service Kit for Cummins</p>  <p>Contains: [1] B7177 Lube [1] BF7940 Fuel [1] BF1378-SPS Fuel/Water Separator [1] BT287-10 Hydraulic</p>
<p>BK6048 Service Kit</p> <p>Image Not Available.</p> <p>Contains: [1] BD7309 Dual-Flow Lube [1] BF7924 Fuel [1] BW5074 Coolant</p>	<p>BK6057 Service Kit</p>  <p>Contains: (2) B7225 Full Flow Lube Spin-on (1) B7685 By-Pass Lube Spin-on (1) BF1386-O Fuel/Water Separator with Open Port for Bowl (1) BF7814 Fuel Spin-on (1) BW5141 Coolant Spin-on with BTE Formula Fits: Mack Trucks</p>
<p>BK6049 Service Kit</p>  <p>Contains: [1] B1428 Lube [1] BF781 Pri. Fuel [2] BT839-10 Hydraulic [1] P106-HD Steering [1] PA2256 Air Breather</p>	<p>BK6058 Service Kit for Mack</p> <p>Image Not Available.</p> <p>Contains: [2] B76 F-F Lube [1] BC7242 By-Pass Lube [1] BF7814 Fuel [1] BF1386-O Fuel/Water Separator</p>
<p>BK6050 Service Kit</p>  <p>Contains: [1] BT287 F-F Lube [2] B7600 F-F Lube [1] B7685 By-Pass Lube [1] BF7814 Pri. Fuel [1] BF1366-O Fuel/Water Separator [1] BW5141 Coolant [2] BT8851-MPG Hydraulic</p>	<p>BK6059 Service Kit</p> <p>Image Not Available.</p> <p>Contains: [1] B99 Lube [1] BF7587 Fuel [1] BF1212 Fuel/Water Separator [1] BW5137 Coolant [1] P528 Steering</p>
<p>BK6051 Service Kit for Volvo</p>  <p>Contains: [2] B76 F-F Lube [1] B7685 By-Pass Lube [1] BF7814 Pri. Fuel [1] BF1386-O Fuel/Water Separator</p>	<p>BK6060 Service Kit</p>  <p>Contains: [1] B7177 F-F Lube [1] B7577 By-Pass Lube [1] BF7966 Pri. Fuel [1] BF1210 Fuel/Water Separator [1] BF1385-SPS Fuel/Water Separator [1] BT839-10 Hydraulic [1] PT951 Steering</p>
<p>BK6052 Service Kit</p> <p>Image Not Available.</p> <p>Contains: [1] BD7154 Dual-Flow Lube [2] BF1212 Pri. Fuel [1] BW5075 Coolant [2] BT8873 Hydraulic [1] BT8847 Hydraulic</p>	<p>BK6061 Service Kit for International</p>  <p>Contains: [2] B495-SS Lube [1] PF7748 Fuel/Water Separator Fits: International Trucks Replaces: Fleetguard MK12941</p>
<p>BK6053 Service Kit for Mack</p>  <p>Contains: [2] B76 F-F Lube [1] BC7242 By-Pass Lube [1] BF7656 Pri. Fuel [1] BF7773 Fuel</p>	











Measurements Are Shown In Inches And (Millimeters)

WARNING: These products can expose you to chemicals, including Diisononyl Phthalate, Carbon black extracts, Nickel, 1,3 Butadiene, Ethylene Oxide, Epichlorohydrin, which are known to the State of California to cause cancer, and Bisphenol, Ethylene Glycol, Ethylene Oxide, 1,3 Butadiene, Epichlorohydrin, which are known to the State of California to cause birth defects or other reproductive harm. For more information go to www.P65Warnings.ca.gov.

<p>BK6062</p> 	<p>Service Kit for Volvo Contains: [2] B7600 F-F Lube [1] B7685 B-P Lube [1] BF7814 Fuel [1] PF7782 Fuel/Water Separator Fits: Volvo Equipment Replaces: Fleetguard MK13185; Wix 24039</p>	<p>BK6070</p> <p>Service Kit Contains: [2] B76 F-F Lube [1] B7409 By-Pass Lube [1] BF7943 Pri. Fuel</p> <p>Image Not Available.</p>
<p>BK6063</p> 	<p>Service Kit for Cummins Contains: [1] BD7154 Dual-Flow Lube [1] BF7766 Fuel [1] PF7782 Fuel/Water Separator Fits: Cummins Engines Replaces: Fleetguard MK13195; Wix 24305</p>	<p>BK6071</p> <p>Service Kit Contains: [2] B76 F-F Lube [1] BC7242 By-Pass Lube [1] BF7773 Pri. Fuel</p> 
<p>BK6064</p> 	<p>Service Kit for Cummins Contains: [1] BD7154 Dual-Flow Lube [1] PF9814 Fuel [1] BF9860 Fuel Fits: Cummins Engines Replaces: Fleetguard MK13448</p>	<p>BK6072</p> <p>Service Kit Contains: [2] B7225 F-F Lube [1] BC7242 By-Pass Lube [1] BF7656 Pri. Fuel [1] BF7657 Sec. Fuel [1] B5176 Coolant</p> <p>Image Not Available.</p>
<p>BK6065</p> <p>Image Not Available.</p>	<p>Service Kit Contains: [2] B113 F-F Lube [1] B7152 By-Pass Lube [1] BF840-K1 In-Line Fuel</p>	<p>BK6073</p> <p>Service Kit Contains: [2] B76 F-F Lube [1] B7409 By-Pass Lube [1] BF7943 Fuel [1] BF1386-O Fuel/Water Separator [1] B5145 Coolant</p> <p>Image Not Available.</p>
<p>BK6066</p> <p>Image Not Available.</p>	<p>Service Kit Contains: [2] B113 F-F Lube [1] B7285 By-Pass Lube [1] BF840-K1 In-Line Fuel</p>	<p>BK6074</p> <p>Service Kit Contains: [1] BD103 Dual-Flow Lube [1] BF7814 Fuel [1] BF1293-SPS Fuel/Water Separator [1] B5134 Coolant</p> <p>Image Not Available.</p>
<p>BK6067</p> <p>Image Not Available.</p>	<p>Service Kit Contains: [2] B113 F-F Lube [1] B7285 By-Pass Lube [1] BF840-K1 In-Line Fuel</p>	<p>BK6075</p> <p>Service Kit Contains: [2] B7225 F-F Lube [1] BC7242 By-Pass Lube [1] BF7656 Pri. Fuel [1] BF7773 Fuel [1] B5176 Coolant</p> <p>Image Not Available.</p>
<p>BK6068</p> 	<p>Service Kit Contains: [1] B7139 Lube [1] BF988 Pri. Fuel [1] RS3715 Radial Seal Outer Air</p>	<p>BK6076</p> <p>Service Kit Contains: [1] B7299 Lube [1] BF7587 Fuel [1] BF1212 Fuel/Water Separator</p> <p>Image Not Available.</p>
<p>BK6069</p> 	<p>Service Kit for Mack / Volvo Engines Contains: [2] B76 Full Flow Lube [1] B7409 By-Pass Lube [1] BF1386-O Fuel/Water Separator [1] BF46117 Fuel</p>	<p>BK6077</p> <p>Service Kit Contains: [2] B495 Lube [1] PF7748 Fuel/Water Separator</p> <p>Image Not Available.</p>
<p>BK6078</p> <p>Image Not Available.</p>	<p>Service Kit for Mack / Volvo Engines Contains: [2] B76 Full Flow Lube [1] B7409 By-Pass Lube [1] BF1386-O Fuel/Water Separator [1] BF46117 Fuel [1] BW5183 Coolant</p>	<p>BK6078</p> <p>Service Kit Contains: [1] BD7153 Dual-Flow Lube [1] PF7748 Fuel/Water Separator</p> <p>Image Not Available.</p>

Measurements Are Shown In Inches And (Millimeters)

WARNING: These products can expose you to chemicals, including Diisononyl Phthalate, Carbon black extracts, Nickel, 1,3 Butadiene, Ethylene Oxide, Epichlorohydrin, which are known to the State of California to cause cancer, and Bisphenol, Ethylene Glycol, Ethylene Oxide, 1,3 Butadiene, Epichlorohydrin, which are known to the State of California to cause birth defects or other reproductive harm. For more information go to www.P65Warnings.ca.gov.

<p>BK6079 Service Kit Contains: [1] BD103 Dual-Flow Lube [1] BF5810 Fuel</p> <p>Image Not Available.</p>	<p>BK6087 Service Kit Contains: [1] B161-S Lube [1] BF9894 Pri. Fuel [1] RS3715 Radial Seal Outer Air</p> 
<p>BK6080 Service Kit Contains: [1] BD103 Dual-Flow Lube [1] BF880-FP Pri. Fuel</p> <p>Image Not Available.</p>	<p>BK6088 Service Kit Contains: [1] P7505 [1] PF9924 Kit [1] P5092 Fits: Freightliner Coronado SD</p> <p>Image Not Available.</p>
<p>BK6081 Service Kit for Cummins Contains: [1] BD7154 Dual-Flow Lube [1] PF9814 Fuel Element [1] BF9885 } Fuel Spin-on</p> 	<p>BK6089 Service Kit for Thermo King Contains: [1] B7375 Lube Spin-on [1] BF9893 Fuel Spin-on [1] RS5387 KIT Radial Seal Air Element with Lid Fits: Thermo King Refrigeration Units Replaces: Thermo King 10-449</p> 
<p>BK6082 Service Kit for Mack Engines Contains: [2] B76 F-F Lube [1] B7409 By-Pass Lube [1] BF46034 Fuel Spin-on</p> 	<p>BK6090 Service Kit Contains: [2] B7225 F-F Lube [1] B7685 By-Pass Lube [1] BF1386-O Fuel/Water Separator [1] BF7814 Fuel Replaces: Donaldson P559106; Fleetguard FF5507, LF3654, LF3973, FS19966</p> 
<p>BK6083 Service Kit for Mack GU713 Contains: (2) B7225 - Full Flow Lube (1) B7685 - By-Pass Lube (1) BF1386-O - Fuel/Water Separator with Open Port for Bowl (1) BF46117 - Fuel</p> <p>Image Not Available.</p>	<p>BK6092 Service Kit for Cummins Contains: [1] BD50000 Lube Spin-on [1] PF9814 Fuel/Water Separator Element [1] BF9885 Fuel Spin-on</p> 
<p>BK6085 Service Kit for Mack / Volvo Engines Contains: [2] B76 Full-Flow Lube [1] B7685 By-Pass Lube [1] BF46117 Fuel</p> 	<p>BK6093 Service Kit Contains: (2) B7700 High Efficiency Lube (1) B7685 By-Pass Lube (1) BF1386-O Fuel/Water Separator with Open Port for Bowl (1) BF7814 Fuel (1) BW5142 Coolant</p> 
<p>BK6086 Service Kit Contains: [1] BD7154 Dual-Flow Lube [1] BF9885 Fuel [1] PF9928 Fuel/Water Separator</p> 	<p>BK6094 Service Kit for Volvo and Mack Applications Contains: [2] B76 [1] B7409 [1] BF1386-O [1] BF7943 [1] B5176</p> 
<p>Image Not Available.</p>	<p>BK6112 Service Kit Contains: [1] BT251 Full-Flow Lube [1] BF840-K1 In-Line Fuel Filter with Clamps & Hoses [1] PA638 Air Element Fits: GasJack Compressors with Ford 460 Engine</p> <p>Image Not Available.</p>

Measurements Are Shown In Inches And (Millimeters)

WARNING: These products can expose you to chemicals, including Diisononyl Phthalate, Carbon black extracts, Nickel, 1,3 Butadiene, Ethylene Oxide, Epichlorohydrin, which are known to the State of California to cause cancer, and Bisphenol, Ethylene Glycol, Ethylene Oxide, 1,3 Butadiene, Epichlorohydrin, which are known to the State of California to cause birth defects or other reproductive harm. For more information go to www.P65Warnings.ca.gov.

BK6117

Service Kit for Mack/Volvo Trucks

- Contains:** [2] B7700 High Efficiency Lube Spin-on
 [1] B7685 By-Pass Lube Spin-on
 [1] PF7680 Fuel/Water Separator Element
 [1] BW5142 Coolant Spin-on with BTE Formula



BK6118

Service Kit for CUMMINS ISX , X15 Engines

- Contains:** [1] BD50000 High Efficiency Dual-Flow Lube Spin-on
 [1] PF9814 Fuel/Water Separator Element
 [1] BF46129 Fuel Spin-on

Image
Not
Available.

BK6138

Service Kit

- Contains:** [2] B7700 High Efficiency Lube Spin-on
 [1] B7685 By-Pass Lube Spin-on
 [1] PF7680 Fuel/Water Separator Element
 [1] BF7814 Fuel Spin-on
 [1] BW5142 Coolant Spin-on
Replaces: Donaldson P559632



BK6140

Service Kit

- Contains:** [2] B76 Full-Flow Lube Spin-ons
 [1] B7685 By-Pass Lube Spin-on
 [1] BF7814 Fuel Spin-on



BK6161

Service Kit for Mercedes-Benz

- Contains:** [1] P7188 Lube
 [1] BC7326 By-Pass Lube Spinner
 [1] PF7735 Fuel



BK6167

Service Kit for Cummins

- Contains:** [1] BD7309 Dual-Flow Lube
 [1] BF1293-SPS Fuel/Water Separator

Image
Not
Available.

BK6181

Service Kit for Caterpillar

- Contains:** [1] B7600 Lube
 [1] PF935 Pri. Fuel
 [1] BF7632 Fuel

Image
Not
Available.

BK6183

Service Kit for Caterpillar

- Contains:** [1] B7299 Lube
 [1] BF7587 Fuel
 [1] BF1259 Fuel/Water Separator



BK6184

Service Kit for Caterpillar

- Contains:** [1] B7299 High Efficiency Lube
 [1] BF7587 Fuel



BK6185

Service Kit for Mack

- Contains:** [2] B7225 Full-Flow Lube
 [1] BC7242 By-Pass Lube Spinner
 [1] BF7656 Pri. Fuel
 [1] BF7773 Sec. Fuel
 [1] BW5178 Coolant



BK6186

Service Kit for Detroit Diesel

- Contains:** [2] B495 Lube
 [1] BF5810 Fuel

Image
Not
Available.

BK6187

Service Kit for Caterpillar

- Contains:** [1] B7299 Lube
 [1] BF596 Pri. Fuel
 [1] BF7587 Fuel

Image
Not
Available.

BK6189

Service Kit for Caterpillar

- Contains:** [1] B99 Lube
 [1] BF7587 Fuel
 [1] BF1212 Fuel/Water Separator

Image
Not
Available.

BK6195

Service Kit for Caterpillar

- Contains:** [1] B99 Lube
 [1] BF7587 Fuel
Replaces: Donaldson P559519;
 Fleetguard MK12673



BK6196

Service Kit for Caterpillar

- Contains:** [1] B99 Lube
 [1] BF7587 Fuel
 [1] BW5137 Coolant



Measurements Are Shown In Inches And (Millimeters)



WARNING: These products can expose you to chemicals, including Diisononyl Phthalate, Carbon black extracts, Nickel, 1,3 Butadiene, Ethylene Oxide, Epichlorohydrin, which are known to the State of California to cause cancer, and Bisphenol, Ethylene Glycol, Ethylene Oxide, 1,3 Butadiene, Epichlorohydrin, which are known to the State of California to cause birth defects or other reproductive harm. For more information go to www.P65Warnings.ca.gov.

BK6215

Service Kit for Caterpillar
Contains: [1] B99 Lube
 [1] BF957 Pri. Fuel
 [1] BF7587 Fuel
 [1] B5134 Coolant



BK6380

Service Kit for Cummins
Contains: [1] BD103 Dual-Flow Lube
 [1] BF1212 Fuel/Water Separator
 [1] BW5071 Coolant
Replaces: Donaldson P559047; Fleetguard MK11997, MK1105300; Fram FK7132; Luber-finer LK143C, LK177C



BK6287

Service Kit for Caterpillar
Contains: [1] B7600 Lube
 [1] BF7632 } Fuel



BK6426

Service Kit for Cummins
Contains: [1] BD7153 Dual-Flow Lube
 [1] BF7760 Pri. Fuel
 [1] BF7766 Fuel
 [1] BW5086 Coolant

Image
Not
Available.

BK6299

Service Kit for Caterpillar
Contains: [1] B99 F-F Lube
 [1] B7577 By-Pass Lube
 [1] BF7587 Fuel

Image
Not
Available.

BK6429

Service Kit for Cummins
Contains: [1] BD103 Dual-Flow Lube
 [1] BF7815 Fuel
 [1] BF1293-SPS Fuel/Water Separator

Image
Not
Available.

BK6341

Service Kit for Cummins
Contains: [1] BD7154 Dual-Flow Lube
 [1] BF1259 Fuel/Water Separator



BK6438

Service Kit for Cummins
Contains: [1] BD7154 Dual-Flow Lube
 [1] BF1259 Fuel/Water Separator
 [1] B5134 Coolant



BK6375

Service Kit for Cummins
Contains: [1] BD103 Dual-Flow Lube
 [1] BF1259 Fuel/Water Separator
 [1] BW5071 Coolant
Replaces: Donaldson P559303; Fleetguard MK12119, MK11811; Fram FK8139; Luber-finer LK208C



BK6440

Service Kit for Cummins
Contains: [1] BD7154 Dual-Flow Lube
 [1] BF7760 Fuel
 [1] BF7766 Fuel



BK6376

Service Kit for Cummins
Contains: [1] BD103 Dual-Flow Lube
 [1] BF1259 Fuel/Water Separator
Replaces: Donaldson P559468; Fleetguard MK11807, MK12557; Luber-finer LK228C



BK6444

Service Kit for Cummins
Contains: [1] BD7153 Dual-Flow Lube
 [1] BF1259 Fuel/Water Separator
 [1] BW5072 Coolant

Image
Not
Available.

BK6451

Service Kit for Cummins
Contains: [1] BD103 Dual-Flow Lube
 [1] BF1259 Fuel/Water Separator
 [1] BW5072 Coolant

Image
Not
Available.

Measurements Are Shown In Inches And (Millimeters)

WARNING: These products can expose you to chemicals, including Diisononyl Phthalate, Carbon black extracts, Nickel, 1,3 Butadiene, Ethylene Oxide, Epichlorohydrin, which are known to the State of California to cause cancer, and Bisphenol, Ethylene Glycol, Ethylene Oxide, 1,3 Butadiene, Epichlorohydrin, which are known to the State of California to cause birth defects or other reproductive harm. For more information go to www.P65Warnings.ca.gov.

BK6452 Service Kit for Cummins
Contains: [1] BD7154 Dual-Flow Lube
 [1] BF1259 Fuel/Water Separator
 [1] BW5072 Coolant

Image Not Available.

BK6457 Service Kit
Contains: [2] B7225 F-F Lube
 [1] B7685 By-Pass Lube
 [1] BF7814 Fuel
 [1] BF1386-O Fuel/Water Separator
 [1] PT9394-MPG Steering



BK6463 Service Kit for Cummins
Contains: [1] BD7154 Dual-Flow Lube
 [1] BF7760 Pri. Fuel
 [1] BF7766 Fuel
 [1] BW5086 Coolant

Image Not Available.

BK6464 Service Kit for Cummins
Contains: [1] BD7154 Dual-Flow Lube
 [1] PF7755 Fuel/Water Separator
 [1] BF7766 Fuel



BK6467 Service Kit for Cummins
Contains: [1] BD7309 Dual-Flow Lube
 [1] BF1272-SPS Fuel/Water Separator

Image Not Available.

BK6561 Service Kit for Detroit Diesel
Contains: [2] B495 Lube
 [1] BF5800 Pri. Fuel
 [1] BF5810 Sec. Fuel
 [1] BW5137 Coolant
Replaces: Fleetguard MK11518, MK11660



BK6562 Service Kit for Detroit Diesel
Contains: [2] B495 Lube
 [1] BF5800 Pri. Fuel
 [1] BF5810 Sec. Fuel
Replaces: GMC 23518686, 25014736;
 Donaldson P559251; Fleetguard MK11562;
 Fram FK7646; Luber-finer LK161D;
 Wix 24537



BK6579 Service Kit for Detroit Diesel
Contains: [2] B495 Lube
 [1] BF5800 Pri. Fuel
 [1] BF5810 Sec. Fuel
 [1] BW5071 } Coolant
Replaces: Donaldson P559299, P559466;
 Fleetguard MK11666; Luber-finer LK162D



BK6583 Service Kit for Detroit Diesel
Contains: [2] B495 Lube
 [1] PF7680 Fuel Element
Replaces: Donaldson P559474;
 Fleetguard MK12358, MK12499



BK6595 Service Kit for Detroit Diesel
Contains: [2] B495 Lube
 [1] PF7680 Fuel Element
 [1] BW5137 Coolant



BK6600 Service Kit for International
Contains: [2] BT261 Lube
 [1] BF979 Pri. Fuel
 [1] BF588 Sec. Fuel
 [1] BW5137 Coolant
Replaces: Donaldson P559217; Fleetguard MK151900; Fram FK3888; Luber-finer LK321



BK6601 Service Kit for International
Contains: [2] BT261 Lube
 [1] BF979 Pri. Fuel
 [1] BF588 Sec. Fuel
Replaces: Donaldson P559009;
 Fleetguard MK12427, MK146600;
 Fram FK3887, FK3905; Luber-finer LK9I



BK6610 Service Kit for International
Contains: [2] B299 Lube
 [1] BF979 Pri. Fuel
 [1] BF588 Sec. Fuel
Replaces: Fleetguard MK11029;
 Luber-finer LK115I



BK6613 Service Kit for Mack
Contains: [2] B76 F-F Lube
 [1] BC7242 Centrifugal By-Pass Lube
 [1] BF7656 Pri. Fuel
 [1] BF7657 Sec. Fuel



BK6619 Service Kit for International
Contains: [1] B7030 Lube
 [1] BF7629 Fuel
 [1] BW5137 Coolant
Replaces: Luber-finer LK204I; Wix 24567



BK6634 Service Kit for International
Contains: [1] B7030 Lube
 [1] BF7629 Fuel
 [1] BW5071 } Coolant



Measurements Are Shown In Inches And (Millimeters)

WARNING: These products can expose you to chemicals, including Diisononyl Phthalate, Carbon black extracts, Nickel, 1,3 Butadiene, Ethylene Oxide, Epichlorohydrin, which are known to the State of California to cause cancer, and Bisphenol, Ethylene Glycol, Ethylene Oxide, 1,3 Butadiene, Epichlorohydrin, which are known to the State of California to cause birth defects or other reproductive harm. For more information go to www.P65Warnings.ca.gov.

BK6649 Service Kit
Image Not Available.
Contains: [1] B76-MPG Lube
 [1] BF948 Pri. Fuel
 [1] BF7634 Fuel
 [1] BT387-10 Hydraulic

BK6659 Service Kit for Mack
Image
Contains: [2] B7225 F-F Lube
 [1] BC7242 By-Pass Spinner Lube
 [1] BF1256 Fuel/Water Separator
 [1] BF7773 Fuel

BK6650 Service Kit for Volvo
Image
Contains: [2] B76-SS F-F Lube
 [1] B7685 By-Pass Lube
 [1] BF7943 Fuel

BK6661 Service Kit for Mercedes-Benz
Image
Contains: [1] P7188 Lube
 [1] PF7735 Fuel

BK6652 Service Kit for International
Image
Contains: [1] BD7250 Dual Flow Lube
 [1] PF7779 Fuel Element

BK6662 Service Kit for Mack
Image
Contains: [2] B7225 F-F Lube
 [1] BC7242 By-Pass Lube Spinner
 [1] BF7656 Pri. Fuel
 [1] BF1286 Fuel/Water Separator

BK6653 Service Kit for Mack
Image
Contains: [2] B7225 F-F Lube
 [1] BC7242 By-Pass Lube
 [1] BF7656 Pri. Fuel
 [1] BF1286 Fuel/Water Separator
 [1] BW5178 Coolant
Fits: Mack ASET-CEGR Engine
Replaces: Mack 57GC2245

BK6663 Service Kit for Volvo
Image
Contains: [2] B76-SS F-F Lube
 [1] B7685 By-Pass Lube
 [1] BF7814 Fuel

BK6654 Service Kit for Volvo
Image Not Available.
Contains: [2] B7600 F-F Lube
 [1] B7685 By-Pass Lube
 [1] BF7814 Fuel
 [1] BF1329 Fuel/Water Separator
 [1] B5145 Coolant

BK6665 Service Kit for Mack
Image
Contains: [2] B7225 Full-Flow Lube
 [1] BC7242 By-Pass Lube Spinner
 [1] BF7656 Pri. Fuel
 [1] BF7773 Fuel

BK6656 Service Kit for Mack
Image
Contains: [2] B76 Lube
 [1] B7409 By-Pass Lube
 [1] BF1386-O Fuel/Water Separator
 [1] BF7943 Fuel
 [1] BW5183 Coolant

BK6666 Service Kit for Mack
Image
Contains: [2] B7225 F-F Lube
 [1] BC7228 By-Pass Lube
 [1] BF7657 Fuel
 [1] BF1256 Pri. Fuel/Water Separator

BK6657 Service Kit for Mack
Image
Contains: [2] B7225 F-F Lube
 [1] BC7242 By-Pass Lube
 [1] BF7656 Pri. Fuel
 [1] BF7657 Sec. Fuel
 [1] BW5178 Coolant
Fits: Mack ASET-IEGR Engine
Replaces: Mack 57GC2234

BK6670 Service Kit for Volvo
Image Not Available.
Contains: [2] B76-SS F-F Lube
 [1] B7685 By-Pass Lube
 [1] PF7744 Pri. Fuel
 [1] BF7814 Fuel

BK6658 Service Kit for Mack
Image
Contains: [2] B7225 F-F Lube
 [1] BC7242 By-Pass Spinner Lube
 [1] BF1256 Fuel/Water Separator
 [1] BF7657 Sec. Fuel

BK6675 Service Kit for Mercedes-Benz
Image
Contains: [1] P7230 Lube
 [1] PF7761 Fuel

Measurements Are Shown In Inches And (Millimeters)

WARNING: These products can expose you to chemicals, including Diisononyl Phthalate, Carbon black extracts, Nickel, 1,3 Butadiene, Ethylene Oxide, Epichlorohydrin, which are known to the State of California to cause cancer, and Bisphenol, Ethylene Glycol, Ethylene Oxide, 1,3 Butadiene, Epichlorohydrin, which are known to the State of California to cause birth defects or other reproductive harm. For more information go to www.P65Warnings.ca.gov.

BK6676



Service Kit for Mercedes-Benz
Contains: [1] P7230 Lube
 [1] PF7748 Fuel/Water Separator
 [1] PF7761 Fuel

BK6700



Service Kit for Mack
Contains: [2] B76 Lube
 [1] BF877 Pri. Fuel
 [1] BF876 Sec. Fuel
 [1] BW5178 Coolant
Replaces: Mack 57GC294, 215SB192A;
 Donaldson P559001; Fleetguard MK31M;
 Fram FK3352; Luber-finer LK1M;
 Purolator K50001; Wix 24210

BK6683

Image
Not
Available.

Service Kit for Volvo
Contains: [2] B76-SS F-F Lube
 [1] B7685 By-Pass Lube
 [1] BF7653 Pri. Fuel

BK6702



Service Kit for Mack
Contains: [2] B76 Lube
 [1] BF877 Pri. Fuel
 [1] BF976 Sec. Fuel
Replaces: Donaldson P559205;
 Fleetguard MK11116; Luber-finer LK77M

BK6685

Image
Not
Available.

Service Kit for Caterpillar
Contains: [1] B7600 Lube
 [1] BF1173 Pri. Fuel
 [1] BF7632 Fuel

BK6704



Service Kit for Mack
Contains: [2] B76 F-F Lube
 [1] BC110 By-Pass Lube Spinner
 [1] BF7656 Pri. Fuel
 [1] BF7657 Sec. Fuel
 [1] BW5178 Coolant
Replaces: Mack 57GC2177; Fram FK8454;
 Luber-finer LK236M; Wix 24566

BK6686



Service Kit for Caterpillar
Contains: [1] B99 Lube
 [1] BF957 Pri. Fuel
 [1] BF7587 Fuel

BK6705



Service Kit for Mack
Contains: [2] B76 F-F Lube
 [1] BC110 By-Pass Lube Spinner
 [1] BF7656 Pri. Fuel
 [1] BF7657 Sec. Fuel
Replaces: Mack 57GC2177A, 57GC2177B;
 Hastings KF48

BK6691

Image
Not
Available.

Service Kit for Volvo
Contains: [2] B76-SS F-F Lube
 [1] B7685 By-Pass Lube
 [1] PF7744 Pri. Fuel
 [1] BF7814 Fuel
 [1] BW5142 Coolant

BK6710



Service Kit for Mack
Contains: [3] B76 Lube
 [1] BF877 Pri. Fuel
 [1] BF976 Sec. Fuel
 [1] BW5179 Coolant
Replaces: Mack 57GC295A, 215SB134A;
 Donaldson P559031; Fleetguard MK33M;
 Fram FK3434; Luber-finer LK3M;
 Purolator K50002; Wix 24222

BK6693



Service Kit for Mack
Contains: [2] B7225 F-F Lube
 [1] BC7242 By-Pass Lube Spinner
 [1] BF7656 Pri. Fuel
 [1] BF7657 Sec. Fuel

BK6720



Service Kit for Mack
Contains: [2] B76 F-F Lube
 [1] BC110 By-Pass Lube Spinner
 [1] BF877 Pri. Fuel
 [1] BF976 Sec. Fuel
 [1] BW5179 Coolant
Replaces: Mack 57GC298, 57GC2136;
 Fleetguard MK11057; Fram FK7121; Luber-finer
 LK107M; Purolator K50005; Wix 24561

BK6694



Service Kit for Mack
Contains: [2] B76 F-F Lube
 [1] BC7173 By-Pass Lube Spinner
 [1] BF7656 Pri. Fuel
 [1] BF7657 Sec. Fuel
 [1] BW5178 Coolant
Replaces: Fleetguard MK12790

BK6721



Service Kit for Mack
Contains: [2] B76 F-F Lube
 [1] BC110 By-Pass Lube Spinner
 [1] BF877 Pri. Fuel
 [1] BF976 Sec. Fuel
Replaces: Mack 215SB210, 215SB210A;
 Donaldson P559222; Fleetguard MK11362;
 Fram FK8064; Luber-finer LK170M; Wix 24564

BK6696



Service Kit for Mack
Contains: [2] B76 F-F Lube
 [1] BC7173 By-Pass Lube Spinner
 [1] BF7656 Pri. Fuel
 [1] BF7657 Sec. Fuel
Replaces: Mack 57GC2188A;
 Fleetguard MK12698

Measurements Are Shown In Inches And (Millimeters)

WARNING: These products can expose you to chemicals, including Diisononyl Phthalate, Carbon black extracts, Nickel, 1,3 Butadiene, Ethylene Oxide, Epichlorohydrin, which are known to the State of California to cause cancer, and Bisphenol, Ethylene Glycol, Ethylene Oxide, 1,3 Butadiene, Epichlorohydrin, which are known to the State of California to cause birth defects or other reproductive harm. For more information go to www.P65Warnings.ca.gov.

BK6722 Service Kit for Mack
Contains: [2] B76 F-F Lube
 [1] BC110 By-Pass Lube Spinner
 [1] BF877 Pri. Fuel
 [1] BF876 Sec. Fuel
 [1] BW5178 Coolant
Replaces: Mack 57GC297, 57GC2135;
 Donaldson P559069; Fleetguard MK11488;
 Fram FK8326; Wix 24536



BK6723 Service Kit for Mack
Contains: [2] B76 F-F Lube
 [1] BC110 By-Pass Lube Spinner
 [1] BF877 Pri. Fuel
 [1] BF976 Sec. Fuel
 [1] BW5178 Coolant
Replaces: Mack 57GC2120, 57GC2120B;
 Donaldson P559051; Fleetguard MK11412;
 Fram FK7120; Hastings KF23;
 Luber-finer LK109M; Purolator K50015



BK6764 Service Kit for International
Contains: [1] B7030 Lube
 [1] BF7629 Fuel
Replaces: Fleetguard MK11663, MK12150;
 Luber-finer LK209I



BK6780 Service Kit for Mack
Contains: [1] PA2438 Inter-Cooler Air Element
 [1] PA2439 Air Element
 [2] G25-AF Gaskets
Replaces: Mack 215SB194; Donaldson
 X005582; Fram KA1549; Luber-finer LK1MA



BK6799 Service Kit for Thermo King
Contains: [1] BD7095 Dual-Flow Lube
 [1] BF7579 Box-Style Fuel Filter
 [1] BF7580 Box-Style Fuel/Water Separator
Replaces: Fleetguard MK12073;
 Luber-finer LK195T



BK6903 Service Kit for Volvo
Contains: [1] B76 F-F Lube
 [1] B7685 By-Pass Lube
 [2] BF988 Fuel



BK6923 Service Kit for Mack
Contains: [2] B7225 F-F Lube
 [1] BC7242 By-Pass Lube
 [1] PF7680 Fuel/Water Separator

Image Not Available.

BK6930 Service Kit for Volvo
Contains: [2] B76 F-F Lube
 [1] B7685 By-Pass Lube
 [1] BF7814 Fuel
 [1] BF1329 Fuel/Water Separator
 [1] BW5142 Coolant



BK6931 Service Kit for Volvo
Contains: [2] B76 F-F Lube
 [1] B7685 By-Pass Lube
 [1] BF7814 Fuel
 [1] BF1366-O Fuel/Water Separator
 [1] BW5142 Coolant

Image Not Available.

BK6933 Service Kit
Contains: [1] B7049 Lube
 [1] RS3716 Radial Seal Outer Air

Image Not Available.

BK6934 Service Kit for Detroit Diesel
Contains: [2] B495-SS Severe Service Lube
 [1] PF7680 Fuel/Water Separator



BK6942 Service Kit for Mack
Contains: [2] B7225 F-F Lube
 [1] B7409 By-Pass Lube
 [1] BF7943 Fuel
 [1] BF1386-O Fuel/Water Separator



BK6943 Service Kit for Caterpillar
Contains: [1] B99 Lube
 [1] BF5800 Pri. Fuel
 [1] B5134 Coolant
 [1] BF614 Fuel
 [1] BF1212 Fuel/Water Separator

Image Not Available.

BK6944 Service Kit for Cummins
Contains: [1] BD7154 Dual-Flow Lube
 [1] PF7733 Fuel/Water Separator
 [1] B5134 Coolant

Image Not Available.

BK6945 Service Kit for Caterpillar
Contains: [1] B99 Lube
 [1] BF584 Fuel
 [1] PF7733 Fuel/Water Separator
 [1] B5134 Coolant







Image Not Available.

BK6946 Service Kit for Cummins
Contains: [1] BD103 Dual-Flow Lube
 [1] BF1272-SPS Fuel/Water Separator
 [1] PF7733 Fuel/Water Separator
 [1] B5134 Coolant

Image Not Available.

Measurements Are Shown In Inches And (Millimeters)

WARNING: These products can expose you to chemicals, including Diisononyl Phthalate, Carbon black extracts, Nickel, 1,3 Butadiene, Ethylene Oxide, Epichlorohydrin, which are known to the State of California to cause cancer, and Bisphenol, Ethylene Glycol, Ethylene Oxide, 1,3 Butadiene, Epichlorohydrin, which are known to the State of California to cause birth defects or other reproductive harm. For more information go to www.P65Warnings.ca.gov.

<p>BK6947</p> <p>Image Not Available.</p>	<p>Service Kit for Mack Contains: [2] B76 F-F Lube [1] BC7173 By-Pass Lube [1] BF7656 Pri. Fuel [1] BF7657 Fuel [1] B5176 Coolant</p>	<p>BK6956</p>  <p>Service Kit Contains: [2] B76 F-F Lube [1] B7409 By-Pass Lube [1] BF1386-O Fuel/Water Separator [1] BF7943 Fuel Spin-on</p>
<p>BK6948</p> <p>Image Not Available.</p>	<p>Service Kit for Mack Contains: [2] B7225 F-F Lube [1] BC7242 By-Pass Lube [1] BF7773 Fuel [1] BF1256 Pri. Fuel/Water Separator [1] B5176 Coolant [1] BT9408 Air Coalescer</p>	<p>BK6980</p>  <p>Service Kit Contains: [1] BT339 F-F Lube [1] B7577 By-Pass Lube [1] BF1210 Fuel/Water Separator [1] BT839-10 Hydraulic [1] PT951 Steering</p>
<p>BK6949</p> <p>Image Not Available.</p>	<p>Service Kit for Sterling Contains: [1] P7230 Lube [1] PF7761 Fuel [1] BF1339-SP Fuel/Water Separator</p>	<p>BK6981</p> <p>Image Not Available.</p> <p>Service Kit Contains: [1] BT339 Lube [1] BF7519 In-Line Fuel [1] BF988 Fuel [1] BF1280 Fuel/Water Separator [2] BT389 Hydraulic [1] PT951 Steering</p>
<p>BK6950</p> <p>Image Not Available.</p>	<p>Service Kit for Caterpillar Contains: [1] B7299 Lube [1] BF7587 Fuel [1] BF1216 Fuel/Water Separator</p>	<p>BK6982</p>  <p>Service Kit Contains: [1] BT339 Lube [1] BF7519 Fuel [1] BF1356 Fuel/Water Separator [1] BT389 Hydraulic [1] PT951 Steering [1] PT9415-MPG KIT Transmission</p>
<p>BK6951</p> <p>Image Not Available.</p>	<p>Service Kit for Mack Contains: [2] B76 F-F Lube [1] B7409 By-Pass Lube [1] PF7744 Pri. Fuel [1] BF7943 Fuel [1] B5144 Coolant</p>	<p>BK6983</p>  <p>Service Kit Contains: [1] B7177 Lube [1] BF7540 Fuel [1] BF1378-SPS Fuel/Water Separator [1] BT839-10 Hydraulic [1] PT951 Steering [1] PT9415-MPG KIT Transmission</p>
<p>BK6952</p> <p>Image Not Available.</p>	<p>Service Kit for Caterpillar Contains: [1] B99 Lube [1] BF7587 Fuel [1] PF7890-30 Fuel/Water Separator [1] BC7456 KIT Paper Insert</p>	<p>BK6984</p>  <p>Service Kit Contains: [2] BF1212 Pri. Fuel [1] BT8847 Hydraulic [2] BT8873 Hydraulic [3] PT752 Hydraulic [1] BW5071 Coolant</p>
<p>BK6953</p> <p>Image Not Available.</p>	<p>Service Kit for Caterpillar Contains: [1] B99 Lube [1] BF7587 Fuel [1] BW5071 Coolant</p>	<p>BK6985</p>  <p>Service Kit Contains: [1] B7177 Lube [1] BF7940 Fuel [1] BF1378-SPS Fuel/Water Separator [1] BT839-10 Hydraulic</p>
<p>BK6954</p> 	<p>Service Kit for Caterpillar Contains: [1] B99 Lube [1] BF7587 Fuel [1] BF1259 Fuel/Water Separator</p>	<p>BK6986</p> <p>Image Not Available.</p> <p>Service Kit Contains: [1] B7177 Lube [1] BF1212 Fuel/Water Separator [1] BF1378-SPS Fuel/Water Separator [1] BT839-10 Hydraulic</p>
<p>BK6955</p> <p>Image Not Available.</p>	<p>Service Kit for Cummins Contains: [1] BD7154 Dual-Flow Lube [1] BF7766 Fuel [1] BF1212 Fuel/Water Separator</p>	

Measurements Are Shown In Inches And (Millimeters)

 **WARNING:** These products can expose you to chemicals, including Diisononyl Phthalate, Carbon black extracts, Nickel, 1,3 Butadiene, Ethylene Oxide, Epichlorohydrin, which are known to the State of California to cause cancer, and Bisphenol, Ethylene Glycol, Ethylene Oxide, 1,3 Butadiene, Epichlorohydrin, which are known to the State of California to cause birth defects or other reproductive harm. For more information go to www.P65Warnings.ca.gov.

BK6987 Service Kit
Contains: [1] BT339 Lube
 [1] BF7695 Pri. Fuel
 [1] BT839-10 Hydraulic



BK6988 Service Kit
Contains: [1] B7177 F-F Lube
 [1] B7577 By-Pass Lube
 [1] BF7966 Pri. Fuel
 [1] BF1210 Fuel/Water Separator
 [1] BF1385-SPS Fuel
 [1] BT839-10 Hydraulic
 [1] PT9415-MPG KIT Transmission
 [1] PT951 Steering

Image Not Available.

BK6993 Service Kit for Mack
Contains: [2] B7225 F-F Lube
 [1] BC7228 By-Pass Lube
 [1] BF7656 Pri. Fuel
 [1] BF7657 Fuel

Image Not Available.

BK6996 Service Kit
Contains: [1] BT339 Lube
 [1] BF988 Fuel
 [1] BF1280 Fuel/Water Separator
 [1] BT839-10 Hydraulic

Image Not Available.

BK6997 Service Kit
Contains: [1] B7139 Lube
 [1] BF840 In-Line Fuel
 [1] BF954 Fuel
 [1] RS3715 Radial Seal Outer Air



P7000 KIT Kit of 2 Lube Elements
Contains: [1] P7092
 [1] P7093
Fits: Case, Furukawa, Kobelco, MDI/Yutani, Mitsubishi, Tadano Equipment
Replaces: Case 151197A1; Kobelco 2451U-1801; Mitsubishi ME064356



P7092
O.D.: 5 1/16 (128.6)
I.D.: 2 11/32 (59.5)
Height: 5 7/8 (149.2)

P7093
O.D. 5 1/16
I.D. 19/32
Height 6 23/32

B7001 Lube Spin-on
Contains: Anti-Drainback Valve
 14 PSID By-Pass Valve
Fits: Ford (Europe) Transit
Replaces: Ford 914F-6714-A, 914F-6714-AA
Thread: M22 x 1.5
O.D.: 3 11/16 (93.7)
Height: 3 3/4 (95.3)
I.Gskt: [1] Included



P7003 Full-Flow Lube Element
Fits: Caterpillar Industrial, Marine Engines
Replaces: Caterpillar 1R0726, 4P2839, 7N7500
O.D.: 7 3/8 (187.3)
I.D.: 2 27/32 (72.2)
Height: 10 9/32 (261.1)
A. Gskt: [2] Attached



B7004 Lube Spin-on
Fits: Hitachi Equipment
Replaces: Hitachi 4206079
Thread: 1 1/2 -12
O.D.: 4 21/32 (118.3)
Height: 8 3/32 (205.6)
I.Gskt: [1] Included



B7005 Full-Flow Lube Spin-on
Fits: Hino Trucks; Hitachi Equipment
Replaces: Detroit Diesel 23530411; Hino 15607-1380, 15607-1740; Hitachi 4178801, 4283859; Isuzu 1-13240-046-0, 1-13240-075-0
Thread: 1 1/2 -12
O.D.: 4 21/32 (118.3)
Height: 8 3/32 (205.6)
I.Gskt: [1] Included



P7007 Lube Element
Replaces: Deutz 1172637
O.D.: 7 5/8 (193.7)
I.D.: 4 21/32 (118.3)
Height: 7 3/32 (180.2)
A. Gskt: [2] Attached



B7009 Lube Spin-on
Contains: 8 PSID By-Pass Valve
Fits: Ford Tractors
Replaces: Ford F0NN-6714-AA
Thread: 1 -12
O.D.: 4 1/4 (108.0)
Height: 5 7/8 (149.2)
I.Gskt: G401



B7010 Lube Spin-on
Fits: GM, Saturn Automotive
Replaces: GMC 25014377
Thread: 13/16 -16
O.D.: 3 (76.2)
Height: 4 3/8 (104.0)
I.Gskt: [1] Included



Measurements Are Shown In Inches And (Millimeters)

WARNING: These products can expose you to chemicals, including Diisononyl Phthalate, Carbon black extracts, Nickel, 1,3 Butadiene, Ethylene Oxide, Epichlorohydrin, which are known to the State of California to cause cancer, and Bisphenol, Ethylene Glycol, Ethylene Oxide, 1,3 Butadiene, Epichlorohydrin, which are known to the State of California to cause birth defects or other reproductive harm. For more information go to www.P65Warnings.ca.gov.

B7011



Lube or Hydraulic Spin-on

Notes: Can be used with OB1314 and OB1316 bases (requires optional G286-C gasket).
Fits: Transit Buses
Replaces: Zinga LE-3
Thread: 1 1/2 -16
O.D.: 5 1/16 (128.6)
Height: 10 3/4 (273.1)
F. Gskt: [1] Included
O. Gskt: G286-C, G369-V, G372, G447, G483, G704, G710

P7017



Lube Element

Fits: DAF, Mercedes-Benz, R.V.I. Buses, Trucks
Replaces: Mercedes-Benz 3661840225
O.D.: 3 9/32 (83.3)
I.D.: 13/16 (20.6)
Height: 5 3/8 (136.5)
I.Gskt: [2] Included
F. Gskt: [1] Copper Washer, [1] Metal Washer
O-Ring: [1] Included

P7012



Lube Element

Fits: Caterpillar Industrial, Marine Engines
Replaces: Caterpillar 1W4136
O.D.: 7 5/16 (185.7)
I.D.: 3 13/32 (86.5)
Height: 13 19/32 (345.3)
A. Gskt: [2] Attached

B7018



By-Pass Lube Spin-on

Fits: Nissan Trucks
Replaces: Nissan 15201-Z9008
Thread: 3/4 -16
O.D.: 4 1/4 (108.0)
Height: 5 7/8 (149.2)
I.Gskt: G401

P7013



Lube Element

Fits: Hino Engines; Hitachi Equipment
Replaces: Hitachi 4507886
O.D.: 3 15/16 (100.0)
I.D.: 19/32 (15.1)
Height: 5 29/32 (150.0)
F. Gskt: [1] Included
Grommets: [2] Attached

B7019



Lube Spin-on

Contains: Integral Post Seal
Fits: Hitachi, J.C. Bamford, Link-Belt Equipment; Isuzu Engines
Replaces: Fiat 76561779; Isuzu 1-13240-105-21
Thread: 1 3/8 -16
O.D.: 4 21/32 (118.3)
Height: 9 29/32 (251.6)
I.Gskt: [1] Included

B7014



Lube Spin-on

Contains: Anti-Drainback Valve
 14 PSID By-Pass Valve
Fits: Hino Engines; Kobelco Loaders
Replaces: Hino 15607-1630
Thread: 1 -16
O.D.: 3 11/16 (93.7)
Height: 5 3/8 (136.5)
I.Gskt: G381-A

B7020



Lube Spin-on

Contains: Anti-Drainback Valve
 14 PSID By-Pass Valve
Fits: Lexus, Toyota Light-Duty Trucks, Vans
Thread: 3/4 -16
O.D.: 3 (76.2)
Height: 4 3/32 (104.0)
I.Gskt: [1] Included

P7015



Lube Element

Fits: Claas, Demag Equipment; M.A.N., Mercedes-Benz Buses, Trucks
Replaces: Claas 1335300; Demag 760017; Mann & Hummel H9471, H9471X
O.D.: 3 5/16 (84.1)
I.D.: 29/32 (23.0)
Height: 7 27/32 (199.2)
F. Gskt: [2] Metal Washers
O-Ring: [1] Included
Grommets: [2] Attached

P7021



Lube Element

Fits: Mitsubishi Equipment, Trucks
Replaces: Mitsubishi 30840-06010, ME021074, ME034481
O.D.: 3 15/16 (100.0)
I.D.: 11/16 (17.5) & 1 1/8 (28.6)
Height: 7 27/32 (199.2)
A. Gskt: [2] Attached
F. Gskt: [2] Included

P7016



Lube Element

Fits: Mercedes-Benz Trucks, Vans
Replaces: Mercedes-Benz 4411800009
O.D.: 3 9/32 (83.3)
I.D.: 13/16 (20.6)
Height: 7 27/32 (199.2)
O-Ring: [2] Included
Grommets: [2] Attached

B7022



Lube Spin-on

Contains: Anti-Drainback Valve
Fits: Nissan Buses
Replaces: Nissan 15208-05D00
Thread: 3/4 -16
O.D.: 3 25/32 (96.0)
Height: 5 9/32 (134.1)
I.Gskt: G381-A

B7023



Lube Spin-on

Contains: 14 PSID By-Pass Valve
Fits: Ingersoll-Rand Compressors
Replaces: Ingersoll-Rand 39460456
Thread: 1 1/4 -12
O.D.: 3 11/16 (93.7)
Height: 5 3/8 (136.5)
I.Gskt: G381-A

Measurements Are Shown In Inches And (Millimeters)

WARNING: These products can expose you to chemicals, including Diisononyl Phthalate, Carbon black extracts, Nickel, 1,3 Butadiene, Ethylene Oxide, Epichlorohydrin, which are known to the State of California to cause cancer, and Bisphenol, Ethylene Glycol, Ethylene Oxide, 1,3 Butadiene, Epichlorohydrin, which are known to the State of California to cause birth defects or other reproductive harm. For more information go to www.P65Warnings.ca.gov.

B7024 Air Breather Spin-on
Contains: Integral Post Seal
 Adapter Thread: 3/4-14 NPT
Fits: Boart, Fletcher Drills; Gehl, Liebherr, Oldenburg Equipment
Replaces: Schroeder ABF3/10 (with Adapter)
Thread: 1 1/8 -16
O.D.: 3 11/16 (93.7)
Height: 4 5/16 (109.5)
Related To: BT367-S (without Adapter)



B7031 Full-Flow Lube Spin-on
Contains: Anti-Drainback Valve
 30 PSID By-Pass Valve
Fits: Claas, Zetor Equipment; DAF, Iveco Buses, Trucks; Deutz Engines
Replaces: Claas 568440; DAF 661049; Deutz 1174419; Iveco 1161934; Zetor 4061130
Thread: 1 -12
O.D.: 3 11/16 (93.7)
Height: 6 5/8 (168.3)
I.Gskt: G381-A
Related To: B236 (Long Version)



B7025 Lube Spin-on
Fits: Thermo King Refrigeration Units
Replaces: Thermo King 11-6228
Thread: 3/4 -20
O.D.: 3 11/16 (93.7)
Height: 5 3/8 (136.5)
I.Gskt: G381-A



B7033 Full-Flow Lube Spin-on
Contains: Anti-Drainback Valve
 14 PSID By-Pass Valve
Replaces: Isuzu 8-94463-713-0
Thread: M22 x 1.5
O.D.: 3 1/32 (77.0)
Height: 4 1/16 (103.2)
I.Gskt: [1] Included



B7026-MPG Maximum Performance Glass Hydraulic Spin-on
Fits: Massey Ferguson Tractors
Replaces: Massey Ferguson 3595175-M1
Thread: M24 x 2.0
O.D.: 3 21/32 (92.9)
Height: 5 5/8 (142.9)
I.Gskt: G381-A



B7034 By-Pass Lube Spin-on
Thread: M20 x 1.5
O.D.: 3 25/32 (96.0)
Height: 4 11/32 (110.3)
I.Gskt: [1] Included



BD7028 Dual-Flow Lube Spin-on
Contains: 20 PSID By-Pass Valve
Fits: Kobelco Excavators; Mitsubishi Engines, Trucks
Replaces: Mitsubishi ME013307
Thread: M26 x 1.5
O.D.: 4 1/4 (108.0)
Height: 5 27/32 (148.4)
I.Gskt: G401



P7035 Lube Element
Fits: Belarus Tractors
Replaces: Belarus 2401017040A3
O.D.: 3 15/16 (100.0)
I.D.: 1 19/32 (40.5)
Height: 7 3/4 (196.9)
End Seals: [2] Attached



BD7029 Dual-Flow Lube Spin-on
Contains: Anti-Drainback Valve
 5-8 PSID By-Pass Valve
Fits: Toyota Camry with Diesel Engine
Replaces: Toyota 90915-03006, 90915-30002
Thread: M24 x 1.5
O.D.: 3 31/32 (100.8)
Height: 4 27/32 (123.0)
I.Gskt: [1] Included



B7039 Lube Spin-on
Fits: Ford Light-Duty Trucks, Vans; International Trucks
Replaces: Ford F4TZ-6731-A
Thread: 1 1/2 -16
O.D.: 4 1/4 (108.0)
Height: 7 3/8 (187.3)
I.Gskt: [1] Included



B7030 Full-Flow Lube Spin-on
Contains: 30 PSID By-Pass Valve
Fits: Agco, Terex Equipment; Detroit Diesel, International Engines; International Buses, Trucks
Replaces: GMC 25171955; International 1819452-C1
Thread: M36 x 1.5
O.D.: 5 3/8 (136.5)
Height: 12 3/32 (307.2)
I.Gskt: [1] Included



B7042 Lube Spin-on
Contains: Anti-Drainback Valve
 14 PSID By-Pass Valve
Fits: Caterpillar Lift Trucks; Citroen Trucks; Peugeot Automotive, Light-Duty Trucks
Replaces: Caterpillar 1N4402; Citroen 95638903; Peugeot 110987
Thread: M20 x 1.5
O.D.: 3 11/16 (93.7)
Height: 5 3/8 (136.5)
I.Gskt: G381-A



Measurements Are Shown In Inches And (Millimeters)

WARNING: These products can expose you to chemicals, including Diisononyl Phthalate, Carbon black extracts, Nickel, 1,3 Butadiene, Ethylene Oxide, Epichlorohydrin, which are known to the State of California to cause cancer, and Bisphenol, Ethylene Glycol, Ethylene Oxide, 1,3 Butadiene, Epichlorohydrin, which are known to the State of California to cause birth defects or other reproductive harm. For more information go to www.P65Warnings.ca.gov.

B7044 Lube Spin-on
Contains: Anti-Drainback Valve
Replaces: Nissan 15209-Z6502
Thread: 1 -12
O.D.: 3 23/32 (94.5)
Height: 6 23/32 (170.7)
I.Gskt: G401



P7053 Lube Element
Contains: Reinforced Centertube
Fits: Hino Engines, Tractors, Trucks
Replaces: Hino 15607-1560
O.D.: 3 15/16 (100.0)
I.D.: 19/32 (15.1) & 1 15/16 (49.2)
Height: 7 9/32 (184.9)
F. Gskt: [2] Included
O. Gskt: ES1074
End Seals: [1] Attached
Grommets: [1] Attached



B7045 Lube Spin-on
Contains: 14 PSID By-Pass Valve
Fits: Toyota Engines
Replaces: Toyota 15601-78010
Thread: M26 x 1.5
O.D.: 4 1/4 (108.0)
Height: 5 27/32 (148.4)
I.Gskt: G401



P7055 Lube Element
Contains: Reinforced Centertube
Fits: Isuzu Trucks
Replaces: Isuzu 1-87810-079-2
O.D.: 3 15/16 (100.0)
I.D.: 17/32 (13.5) & 19/32 (15.1)
Height: 9 5/8 (244.5)
F. Gskt: [3] Included
End Seals: [1] Attached
Grommets: [1] Attached

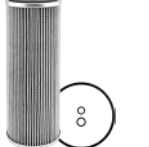

B7047 Full-Flow Lube Spin-on
Contains: Anti-Drainback Valve
Fits: Nissan Engines, Trucks
Replaces: Nissan FL208-05D01
Thread: 3/4 -16
O.D.: 3 23/32 (94.5)
Height: 4 15/32 (113.5)
I.Gskt: G401



P7058 Lube Element
Fits: Nissan Trucks
Replaces: Nissan 15274-99025, 15274-99285
O.D.: 4 11/32 (110.3)
I.D.: 5/8 (15.4) & 1 27/32 (46.8)
Height: 8 11/32 (211.9)
A. Gskt: [1] Attached



B7049 Lube Spin-on
Contains: Anti-Drainback Valve
Fits: Caterpillar, Komatsu, Mitsubishi Lift Trucks; Nissan Engines
Replaces: Nissan 15208-01B01
Thread: 3/4 -16
O.D.: 3 (76.2)
Height: 2 27/32 (72.2)
I.Gskt: [1] Included



P7059 Lube Element
Fits: Nissan Trucks
Replaces: Nissan 15274-99085, 15274-99087
O.D.: 5 1/32 (127.8)
I.D.: 5/8 (15.9) & 2 15/32 (62.7)
Height: 6 15/32 (164.3)
A. Gskt: [1] Attached
F. Gskt: [1] Included, [3] Copper Washers
Grommets: [1] Attached



P7050 Lube Element
Fits: Hitachi Excavators; Isuzu Trucks
Replaces: Isuzu 9-88511-194-2
O.D.: 3 9/32 (83.3)
I.D.: 5/8 (15.9) & 1 5/8 (41.3)
Height: 5 25/32 (146.8)
F. Gskt: [3] Included
End Seals: [1] Attached
Grommets: [1] Attached



P7081 Full-Flow Lube Element
Fits: Toyota Lift Trucks
Replaces: Toyota 4152-46010
O.D.: 3 5/8 (92.1)
I.D.: 23/32 (18.3)
Height: 5 15/32 (138.9)
F. Gskt: [4] Included, [1] Metal Washer



B7051 Lube Spin-on
Contains: Anti-Drainback Valve
 30 PSID By-Pass Valve
 Standpipe
Fits: Komatsu Equipment
Replaces: Komatsu 6134-51-5120
Thread: 1 1/8 -16
O.D.: 4 1/4 (108.0)
Height: 5 27/32 (148.4)
I.Gskt: [1] Included



B7082 Lube Spin-on
Contains: Anti-Drainback Valve
 8 PSID By-Pass Valve
Fits: Bobcat Loaders
Replaces: Melroe-Bobcat 6659329
Thread: M20 x 1.5
O.D.: 3 11/16 (93.7)
Height: 5 3/32 (129.4)
I.Gskt: [1] Included



P7052 Lube Element
Contains: Reinforced Centertube
Fits: Mercedes-Benz Buses, Trucks, Vans
Replaces: Mercedes-Benz 3551800009
O.D.: 3 15/16 (100.0)
I.D.: 1/2 (12.7) & 19/32 (15.1)
Height: 9 5/8 (244.5)
F. Gskt: [4] Included
End Seals: [1] Attached
Grommets: [1] Attached



Measurements Are Shown In Inches And (Millimeters)

WARNING: These products can expose you to chemicals, including Diisononyl Phthalate, Carbon black extracts, Nickel, 1,3 Butadiene, Ethylene Oxide, Epichlorohydrin, which are known to the State of California to cause cancer, and Bisphenol, Ethylene Glycol, Ethylene Oxide, 1,3 Butadiene, Epichlorohydrin, which are known to the State of California to cause birth defects or other reproductive harm. For more information go to www.P65Warnings.ca.gov.

P7083

Lube Element



Fits: Nissan Lift Trucks
Replaces: Nissan 15208-76225
O.D.: 3 3/32 (78.6)
I.D.: 7/8 (22.2) & 1 5/8 (41.3)
Height: 5 7/16 (138.1)
F. Gskt: [3] Included
End Seals: [1] Attached

BD7095

Dual-Flow Lube Spin-on



Contains: Anti-Drainback Valve
Fits: Thermo King Refrigeration Units
Replaces: Thermo King 11-7382
Thread: M26 x 1.5
O.D.: 3 11/16 (93.7)
Height: 7 1/8 (181.0)
I.Gskt: G381-A

P7084

Lube Element



Contains: Reinforced Centertube
Fits: Isuzu Trucks
Replaces: Isuzu 9-88513-264-1
O.D.: 4 1/4 (108.0)
I.D.: 9/16 (14.3) & 1 15/16 (49.2)
Height: 7 1/16 (179.4)
A. Gskt: [1] Attached
F. Gskt: [4] Included
End Seals: [1] Attached

B7097

Dual-Flow Lube Spin-on



Contains: 10-15 PSID By-Pass Valve
Fits: Ford Cargo Trucks
Replaces: Ford 826F-6714-AA2A
Thread: M60 x 3.0
O.D.: 5 15/32 (138.9)
Height: 6 3/4 (171.5)
I.Gskt: [1] Included

B7089

Lube Spin-on



Contains: 40 PSID By-Pass Valve
Fits: Ford, New Holland Equipment
Replaces: Ford F2NN-6714-AA,
 F2NN-6714-AB
Thread: 1 -12
O.D.: 3 11/16 (93.7)
Height: 6 5/8 (168.3)
I.Gskt: G381-A

B7099

Lube Spin-on



Contains: 30 PSID By-Pass Valve
Fits: Fendt, International, Kubota Equipment
Replaces: Fendt F139215310010;
 International 3132023-R92
Thread: 3/4 -16
O.D.: 3 11/16 (93.7)
Height: 4 7/16 (112.7)
I.Gskt: G401

B7091

Lube Spin-on



Contains: Anti-Drainback Valve
 18-20 PSID By-Pass Valve
Fits: Ford Tractors
Replaces: Ford SBA140516230
Thread: 3/4 -16
O.D.: 3 1/32 (77.0)
Height: 5 13/16 (147.6)
I.Gskt: [1] Included

P7102

By-Pass Lube Element with Handle



Fits: Hitachi Excavators
Replaces: Hitachi 4231195
Thread: M16 x 2.0
O.D.: 6 1/2 (165.1)
Height: 5 3/32 (129.4)
F. Gskt: [1] Included, [2] Metal Washers

P7092

Full-Flow Lube Element



Notes: Included in P7000 KIT
Contains: Reinforced Centertube
Fits: Caterpillar, Furukawa Equipment;
 Mitsubishi Engines
Replaces: Mitsubishi 31240-53054
O.D.: 5 1/16 (128.6)
I.D.: 2 11/32 (59.5)
Height: 5 7/8 (149.2)
A. Gskt: [1] Attached
F. Gskt: [2] Included
End Seals: [1] Attached

P7103

Fuel Element



Fits: Mitsubishi Equipment, Trucks;
 Nissan Trucks; Yanmar Engines
Replaces: Mitsubishi ME023833, ME023838;
 Nissan 16444-Z9000
O.D.: 2 7/8 (73.0)
I.D.: 15/32 (11.9)
Height: 3 9/16 (90.5)
F. Gskt: [2] Included
Grommets: [2] Attached

P7093

By-Pass Lube Element



Notes: Included in P7000 KIT
Contains: Bleed Hole
Fits: Caterpillar Excavators;
 Mitsubishi Engines
Replaces: Caterpillar 94-8385;
 Mitsubishi ME054236, ME054238
O.D.: 5 1/16 (128.6)
I.D.: 19/32 (15.1)
Height: 6 23/32 (170.7)
F. Gskt: [2] Included
Grommets: [2] Attached

P7104

Lube Element



Fits: Nissan Trucks
Replaces: Nissan 15274-99428
O.D.: 3 25/32 (96.0)
I.D.: 19/32 (15.1) & 1 23/32 (43.7)
Height: 6 1/16 (154.0)
A. Gskt: [1] Attached
F. Gskt: [4] Included

BD7105

Dual-Flow Lube Spin-on with Drain



Contains: Standpipe
Fits: Hino, Nissan Trucks; Hitachi,
 Kobelco Equipment
Replaces: Hino 15607-1600; Hitachi 4285963
Thread: 1 1/2 -16
O.D.: 4 7/16 (112.7)
Height: 8 11/32 (211.9)
I.Gskt: [1] Included

Measurements Are Shown In Inches And (Millimeters)

WARNING: These products can expose you to chemicals, including Diisononyl Phthalate, Carbon black extracts, Nickel, 1,3 Butadiene, Ethylene Oxide, Epichlorohydrin, which are known to the State of California to cause cancer, and Bisphenol, Ethylene Glycol, Ethylene Oxide, 1,3 Butadiene, Epichlorohydrin, which are known to the State of California to cause birth defects or other reproductive harm. For more information go to www.P65Warnings.ca.gov.

P7106

Lube Element



Contains: Reinforced Centertube
Fits: Hino Trucks
Replaces: Hino 15607-1320
O.D.: 4 5/32 (105.6)
I.D.: 19/32 (15.1) & 1 7/8 (47.6)
Height: 6 3/4 (171.5)
A. Gskt: [1] Attached
F. Gskt: [4] Included

P7107

Lube Element



Contains: Reinforced Centertube
Fits: Kobelco Loaders; Nissan Trucks
Replaces: Kobelco 2451R131-1F; Nissan 15274-90225
O.D.: 3 15/16 (100.0)
I.D.: 5/8 (15.9) & 1 23/32 (43.7)
Height: 7 9/16 (192.1)
A. Gskt: [1] Attached
F. Gskt: [3] Included

B7113

Full-Flow Lube Spin-on



Contains: Anti-Drainback Valve
 30 PSID By-Pass Valve
Fits: Pegaso Buses, Trucks
Replaces: Pegaso 649092
Thread: 1 1/8 -16
O.D.: 4 1/4 (108.0)
Height: 7 11/32 (186.5)
I.Gskt: [1] Included

P7114

Lube Element



Fits: BMW Automotive
Replaces: BMW 11421267268, 11429063138
O.D.: 3 3/16 (81.0)
I.D.: 1 3/32 (27.8)
Height: 5 3/32 (129.4)
A. Gskt: [2] Attached
F. Gskt: [4] Included

B7116

Lube Spin-on



Contains: 30 PSID By-Pass Valve
Fits: M.A.N. Trucks
Replaces: M.A.N. 51.05501.7160, 51.05501.7161, 51.05501.7165
Thread: M30 x 2.0
O.D.: 4 1/4 (108.0)
Height: 7 13/32 (188.1)
I.Gskt: [1] Included

B7117

Lube Spin-on



Replaces: Mann & Hummel W940/34
Thread: 1 -16
O.D.: 3 11/16 (93.7)
Height: 5 3/8 (136.5)
I.Gskt: G381-A

B7119

Full-Flow Lube Spin-on



Contains: Anti-Drainback Valve
 16 PSID By-Pass Valve
Fits: Allis Chalmers, Massey Ferguson Tractors
Replaces: Allis Chalmers 2100723; Massey Ferguson 3283341-M1
Thread: 3/4 -16
O.D.: 3 1/4 (82.6)
Height: 3 5/32 (80.2)
I.Gskt: [1] Included

BD7120

Dual-Flow Lube Spin-on



Contains: Anti-Drainback Valve
 36 PSID By-Pass Valve
Fits: R.V.I. Trucks
Replaces: Renault 7700860823
Thread: 3/4 -16
O.D.: 3 25/32 (96.0)
Height: 5 23/32 (145.3)
I.Gskt: [1] Included

B7121

Dual-Flow Lube Spin-on



Contains: 14-16 PSID By-Pass Valve
Fits: Kobelco Equipment; Mitsubishi Trucks
Replaces: Kobelco 2446R-332D11; 2451U-3431
Thread: M26 x 1.5
O.D.: 4 1/4 (108.0)
Height: 7 11/32 (186.5)
I.Gskt: [1] Included

B7124

By-Pass Lube Spin-on



Fits: GMC, Hino, Isuzu Trucks
Replaces: GMC 94054123; Hino 15607-1860; Isuzu 1-13240-089-0
Thread: 5/8 -18
O.D.: 4 1/4 (108.0)
Height: 5 7/8 (149.2)
I.Gskt: G401

B7125

Full-Flow Lube Spin-on



Contains: 20 PSID By-Pass Valve
Fits: Ditch Witch, John Deere, Lincoln Equipment; Atlas Copco, Ingersoll-Rand Compressors
Replaces: Ingersoll-Rand 36881696; John Deere RE59754
Thread: 1 1/2 -16
O.D.: 3 11/16 (93.7)
Height: 5 3/4 (146.1)
I.Gskt: [1] Included

P7126

Lube Element with Handle



Contains: Reinforced Centertube
Fits: Hitachi Equipment
Replaces: Hitachi 4225367
Thread: M16 x 2.0
O.D.: 6 1/2 (165.1)
Height: 11 15/16 (303.2)
F. Gskt: [3] Included

Measurements Are Shown In Inches And (Millimeters)

! **WARNING:** These products can expose you to chemicals, including Diisononyl Phthalate, Carbon black extracts, Nickel, 1,3 Butadiene, Ethylene Oxide, Epichlorohydrin, which are known to the State of California to cause cancer, and Bisphenol, Ethylene Glycol, Ethylene Oxide, 1,3 Butadiene, Epichlorohydrin, which are known to the State of California to cause birth defects or other reproductive harm. For more information go to www.P65Warnings.ca.gov.

P7127 Lube Element
Fits: Hino Equipment, Trucks
Replaces: Hino 15607-1010, 15607-1010A, 15607-1011
O.D.: 4 27/32 (123.0)
I.D.: 2 1/32 (16.7)
Height: 8 7/8 (225.4)
F. Gskt: [5] Included



B7135 Full-Flow Lube Spin-on
Fits: Detroit Diesel Engines
Replaces: GMC 23550401
Thread: M45 x 1.5
O.D.: 5 3/8 (136.5)
Height: 12 3/32 (307.2)
I.Gskt: [1] Included



B7128 Lube Spin-on
Contains: Anti-Drainback Valve
 50 PSID By-Pass Valve
Fits: Fendt, Renault Tractors;
 Sullair Compressors
Replaces: Mann & Hummel W930
Thread: 3/4 -16
O.D.: 3 11/16 (93.7)
Height: 4 7/16 (112.7)
I.Gskt: G401



P7136 Lube Element
Fits: Audi, Volkswagen Automotive
Replaces: GMC 25313731;
 Volkswagen 21115561B, 21115562A
O.D.: 3 1/4 (82.6)
I.D.: 1 5/16 (23.8) & 1 9/16 (39.7)
Height: 4 11/32 (110.3)
A. Gskt: [2] Attached
O-Ring: [1] Included



V7129-C Cotton/Sisal Lube Sock
Replaces: Nelson 82620D; Winslow CP3245-T0
O.D.: 4 3/8 (111.1)
I.D.: 1 5/32 (29.4)
Height: 31 1/4 (793.8)



P7137 Lube Element
Fits: BMW Automotive
Replaces: BMW 11421745390, 11421745391
O.D.: 3 1/4 (82.6)
I.D.: 1 1/32 (26.2) & 1 9/16 (39.7)
Height: 6 3/8 (161.9)
A. Gskt: [1] Attached
F. Gskt: [1] Metal Washer
O-Ring: [1] Included



B7130 Lube Spin-on
Contains: 14 PSID By-Pass Valve
Fits: Gehl, TCM Loaders
Replaces: Gehl 127389; TCM 20801-01261
Thread: 1 -12
O.D.: 4 1/4 (108.0)
Height: 5 13/16 (147.6)
I.Gskt: [1] Included



P7138 Lube Element
Fits: BMW Automotive
Replaces: BMW 11421427908, 11421740534
O.D.: 3 1/4 (82.6)
I.D.: 1 9/16 (39.7)
Height: 4 1/8 (104.8)
A. Gskt: [2] Attached
F. Gskt: [1] Metal Washer
O-Ring: [1] Included



B7131 Lube Spin-on
Contains: Anti-Drainback Valve
 30 PSID By-Pass Valve
Fits: Caterpillar Lift Trucks;
 Mitsubishi Engines
Replaces: Caterpillar 103-9737;
 Wako 32A4000100
Thread: 1 -12
O.D.: 4 1/4 (108.0)
Height: 4 1/32 (102.4)
I.Gskt: [1] Included



B7139 Full-Flow Lube Spin-on
Contains: Anti-Drainback Valve
 30 PSID By-Pass Valve
Fits: Carrier-Transcold Refrigeration Units;
 Massey Ferguson Tractors
Replaces: Agco 72118856, 74920158; Carrier
 941172, 25-34602-00; Massey Ferguson
 3281019-M1, 3435171-M1
Thread: 3/4 -16
O.D.: 3 1/32 (77.0)
Height: 4 3/32 (104.0)
I.Gskt: [1] Included



P7132 Lube Element
Contains: 60 PSID By-Pass Valve
Fits: Honda ATVs, Motorcycles
Replaces: Honda 15410-KF0-315,
 15412-KF0-000
O.D.: 1 31/32 (50.0)
I.D.: 15/32 (11.9) One End
Height: 1 7/16 (36.5)
A. Gskt: [1] Attached
F. Gskt: [1] Included



BD7141 Dual-Flow Lube Spin-on
Replaces: Isuzu 8-94396-375-4
Thread: 1 1/2 -12
O.D.: 4 21/32 (118.3)
Height: 8 3/32 (205.6)
I.Gskt: [1] Included



P7134 Power Steering Element
Notes: Inside-Out Flow Direction
Fits: International Buses, Trucks
Replaces: International 1653998-C91
O.D.: 2 15/32 (62.7)
I.D.: 1 3/32 (27.8)
Height: 3 9/16 (90.5)
F. Gskt: [8] Included



Measurements Are Shown In Inches And (Millimeters)

WARNING: These products can expose you to chemicals, including Diisononyl Phthalate, Carbon black extracts, Nickel, 1,3 Butadiene, Ethylene Oxide, Epichlorohydrin, which are known to the State of California to cause cancer, and Bisphenol, Ethylene Glycol, Ethylene Oxide, 1,3 Butadiene, Epichlorohydrin, which are known to the State of California to cause birth defects or other reproductive harm. For more information go to www.P65Warnings.ca.gov.

B7142 Full-Flow Lube Spin-on
Contains: 20 PSID By-Pass Valve
Replaces: Hyster 1313454; Perkins CV2473
Thread: M30 x 1.5
O.D.: 4 1/4 (108.0)
Height: 7 9/16 (192.1)
I.Gskt: [1] Included



BD7153 High Velocity Dual-Flow Lube Spin-on
Contains: Venturi-Type Cone
Fits: Cummins Engines
Replaces: Cummins 3406810, 340681000; Fleetguard LF9000
Thread: M95 x 2.5
O.D.: 4 21/32 (118.3)
Height: 14 7/32 (361.2)
I.Gskt: [1] Included
Related To: BD7154 (Short Version)



B7143 Full-Flow Lube Spin-on
Contains: 50 PSID By-Pass Valve
Fits: Atlas Copco, Kaeser Compressors
Replaces: Kaeser 6-1981, 6-1981-0, 6-1981-0/A1
Thread: 1 -12
O.D.: 3 11/16 (93.7)
Height: 8 1/8 (206.4)
I.Gskt: G381-A



BD7154 High Velocity Dual-Flow Lube Spin-on
Contains: Venturi-Type Cone
Fits: Cummins Engines
Replaces: Cummins 3406809; Fleetguard LF9001
Thread: M95 x 2.5
O.D.: 4 21/32 (118.3)
Height: 11 25/32 (299.2)
I.Gskt: [1] Included
Related To: BD7153 (Long Version) BD7509 (Vamac Gasket) BD50000 (High Efficiency Version)



B7144 Lube Spin-on
Contains: Anti-Drainback Valve
 14 PSID By-Pass Valve
Fits: Case, Hitachi, Kobelco, Link-Belt, Massey Ferguson, Mitsubishi Equipment; Isuzu Engines
Replaces: Hitachi 4183853; Isuzu 8-94321-219-1; Kobelco 2451U309-1; Link-Belt KNH0324
Thread: 1 -12
O.D.: 4 1/4 (108.0)
Height: 5 27/32 (148.4)
I.Gskt: [1] Included



B7155 Lube Spin-on
Fits: Hino Trucks
Replaces: Hino 15607-2050
Thread: 1 1/2 -16
O.D.: 4 21/32 (118.3)
Height: 8 1/8 (206.4)
I.Gskt: [1] Included



P7145 Lube Element
Fits: Deutz Engines; Deutz Tractors; M.A.N. Engines, Trucks
Replaces: M.A.N. 51.055040.096; Renault 5001846993
O.D.: 3 9/32 (83.3)
I.D.: 1 5/8 (41.3) One End
Height: 8 13/32 (213.5)
A. Gskt: [1] Attached
O-Ring: [1] Included



B7156 Lube Spin-on
Contains: Anti-Drainback Valve
 40 PSID By-Pass Valve
Fits: Hatz Diesel Engines; Renault Tractors
Replaces: Hatz 40065300
Thread: 3/4 -16
O.D.: 3 11/16 (93.7)
Height: 5 3/8 (136.5)
I.Gskt: G381-A



B7151 Lube Spin-on
Contains: 40 PSID By-Pass Valve
Fits: DAF Trucks
Replaces: DAF 1306549
Thread: 1 -12
O.D.: 4 1/4 (108.0)
Height: 9 1/8 (231.8)
I.Gskt: G401



B7157 Lube Spin-on
Contains: Anti-Drainback Valve
 35 PSID By-Pass Valve
Fits: MWM Engines
Replaces: MWM 605412970039
Thread: 1 1/2 -16
O.D.: 5 3/8 (136.5)
Height: 12 3/32 (307.2)
I.Gskt: [1] Included



B7152 Lube Spin-on
Contains: Anti-Drainback Valve
 20 PSID By-Pass Valve
Fits: Case, Hitachi, Kubota Equipment
Replaces: Kubota 17321-32430
Thread: 3/4 -16
O.D.: 3 11/16 (93.7)
Height: 3 1/4 (82.6)
I.Gskt: G381-A



BD7158 Dual-Flow Lube Spin-on
Contains: Integral Post Seal
 25-31 PSID By-Pass Valve
Fits: Caterpillar Excavators, Industrial Engines
Replaces: Caterpillar 5I7950, 5I7950X
Thread: M32 x 1.5
O.D.: 4 1/4 (108.0)
Height: 8 25/32 (223.0)
I.Gskt: [1] Included



Measurements Are Shown In Inches And (Millimeters)

WARNING: These products can expose you to chemicals, including Diisononyl Phthalate, Carbon black extracts, Nickel, 1,3 Butadiene, Ethylene Oxide, Epichlorohydrin, which are known to the State of California to cause cancer, and Bisphenol, Ethylene Glycol, Ethylene Oxide, 1,3 Butadiene, Epichlorohydrin, which are known to the State of California to cause birth defects or other reproductive harm. For more information go to www.P65Warnings.ca.gov.

BD7159 Dual-Flow Lube Spin-on
Contains: 40 PSID By-Pass Valve
Fits: Isuzu Engines, Trucks
Replaces: Isuzu 8-94338-181-0, 8-94338-18-1, 8-97096-777-0
Thread: 1 1/2 -12
O.D.: 4 21/32 (118.3)
Height: 4 15/16 (125.4)
I.Gskt: [1] Included



BD7160 Dual-Flow Lube Spin-on
Contains: 11-17 PSID By-Pass Valve
Replaces: GMC 94360427; Isuzu 8-94360-427-1, 8-97021-576-0; Mazda RFT1-1A-302, RYF0-14-302; Mitsubishi MD336080; Nissan 15208-HC200, 15208-89TA0
Thread: M26 x 1.5
O.D.: 3 17/32 (89.7)
Height: 4 15/16 (125.4)
I.Gskt: [1] Included
O-Ring: [3] Included



B7161 Lube Spin-on
Contains: 35 PSID By-Pass Valve
 Hex nut for removal
Fits: DAF Trucks
Replaces: DAF 1331057, 1345332
Thread: M42 x 2.0
O.D.: 5 3/8 (136.5)
Height: 8 7/8 (225.4)
I.Gskt: [1] Included



B7162 Lube Spin-on
Contains: 35 PSID By-Pass Valve
 Hex nut for removal
Fits: DAF Engines, Trucks
Replaces: DAF 1310901
Thread: M42 x 2.0
O.D.: 5 3/8 (136.5)
Height: 12 3/8 (314.3)
I.Gskt: [1] Included



B7163 Lube Spin-on
Contains: 35 PSID By-Pass Valve
Replaces: Atlas Copco 1202-8040-00
Thread: M20 x 1.5
O.D.: 3 23/32 (94.5)
Height: 8 3/32 (205.6)
I.Gskt: [1] Included



B7164 By-Pass Lube Spin-on
Fits: Hitachi, Kobelco Excavators; Isuzu Engines
Replaces: Hitachi 4285642; Isuzu 8-97026-134-2
Thread: M20 x 1.5
O.D.: 4 1/4 (108.0)
Height: 7 5/8 (193.7)
I.Gskt: [1] Included



B7165 Lube Spin-on
Contains: Anti-Drainback Valve
 8 PSID Front End By-Pass Valve
Fits: Ariens, Bush Hog, Cub Cadet, Gravely, Husqvarna, John Deere, Snapper, White Lawn & Garden Tractors; Briggs & Stratton Engines
Replaces: Briggs & Stratton 492932
Thread: 3/4 -16
O.D.: 3 1/32 (77.0)
Height: 2 5/16 (58.7)
I.Gskt: G449-B



BD7166 Dual-Flow Lube Spin-on
Contains: 15 PSID By-Pass Valve
Fits: GMC Trucks; Isuzu Engines
Replaces: GMC 97719921; Isuzu 2-90654-600-0, 8-97049-282-0
Thread: 1 1/2 -12
O.D.: 4 21/32 (118.3)
Height: 8 1/16 (204.8)
I.Gskt: [1] Included



B7167 Lube Spin-on
Contains: Anti-Drainback Valve
 20 PSID By-Pass Valve
Fits: Bobcat Loaders; Citroen, Peugeot Trucks; Suzuki Automotive
Replaces: Melroe-Bobcat 6661011
Thread: M20 x 1.5
O.D.: 3 1/32 (77.0)
Height: 3 1/2 (88.9)
I.Gskt: G449-B



BD7168 Dual-Flow Lube Spin-on
Contains: Anti-Drainback Valve
 23 PSID By-Pass Valve
Fits: Iveco Trucks
Replaces: Iveco 1905704, 1907571
Thread: M30 x 2.0
O.D.: 4 5/16 (109.5)
Height: 10 3/8 (263.5)
I.Gskt: [1] Included
F. Gskt: [1] Included



BD7169 Dual-Flow Lube Spin-on
Contains: 19 PSID By-Pass Valve
Fits: GMC, Isuzu Buses, Trucks
Replaces: GMC 97148270; Isuzu 2-90654-800-0, 8-97148-270-0
Thread: 1 1/2 -12
O.D.: 4 21/32 (118.3)
Height: 4 15/16 (125.4)
I.Gskt: [1] Included



B7170 Lube Spin-on
Contains: Anti-Drainback Valve
 2 PSID Front-End Check Valve
 50 PSID By-Pass Valve
Fits: John Deere, Liebherr Equipment
Replaces: Liebherr 5700043, 570004323
Thread: 1 -12
O.D.: 3 11/16 (93.7)
Height: 8 1/8 (206.4)
I.Gskt: G381-A



Measurements Are Shown In Inches And (Millimeters)

WARNING: These products can expose you to chemicals, including Diisononyl Phthalate, Carbon black extracts, Nickel, 1,3 Butadiene, Ethylene Oxide, Epichlorohydrin, which are known to the State of California to cause cancer, and Bisphenol, Ethylene Glycol, Ethylene Oxide, 1,3 Butadiene, Epichlorohydrin, which are known to the State of California to cause birth defects or other reproductive harm. For more information go to www.P65Warnings.ca.gov.

B7171 Lube Spin-on
Contains: Anti-Drainback Valve
 Front End Check Valve
 35 PSID By-Pass Valve
Fits: Liebherr Equipment
Replaces: Liebherr 7381111, 738111123
Thread: M30 x 2.0
O.D.: 4 1/4 (108.0)
Height: 9 1/8 (231.8)
I.Gskt: [1] Included



B7177 Lube Spin-on
Fits: Equipment, Motor Homes and Trucks with Cummins ISB 5.9L, QSB 5.9L Engines
Replaces: Cummins 3937144
Thread: 1 1/8 -16
O.D.: 3 11/16 (93.7)
Height: 7 3/16 (182.6)
I.Gskt: G401



B7172 Lube Spin-on
Contains: Anti-Drainback Valve
 20 PSID By-Pass Valve
Fits: Perkins Engines
Replaces: Perkins 140516990
Thread: 3/4 -16
O.D.: 3 1/32 (77.0)
Height: 4 3/32 (104.0)
I.Gskt: [1] Included



P7178 Power Steering Element
Notes: Inside-Out Flow Direction
Contains: 14 PSID By-Pass Valve
Fits: International Trucks
Replaces: International 1696766-C1
O.D.: 2 3/4 (69.9)
I.D.: 7/16 (11.1) One End
Height: 3 (76.2)
Grommets: [1] Attached



BC7173 Centrifugal By-Pass Lube Element
Fits: Mack, R.V.I. Engines
Replaces: Mack 57GC2187, 236GB245M
O.D.: 3 27/32 (97.6)
I.D.: 3/8 (9.5) & 1/2 (12.7)
Height: 4 1/2 (114.3)
F. Gskt: [1] Included



B7179 Lube Spin-on
Contains: Anti-Drainback Valve
 20 PSID By-Pass Valve
Fits: Agco, Case, Massey Ferguson, Valtra, Valmet Equipment
Replaces: Agco 836647133
Thread: M24 x 1.5
O.D.: 4 1/4 (108.0)
Height: 5 27/32 (148.4)
I.Gskt: G401



B7174-MPG Maximum Performance Glass Lube Spin-on
Fits: Case Dump Trucks; Case-IH Harvesters, Tractors; Iveco Engines, Trucks; New Holland Combines, Forage Harvesters, Tractors; Winpower Generators
Replaces: Iveco 99445200
Thread: M30 x 2.0
O.D.: 4 1/4 (108.0)
Height: 9 1/8 (231.8)
I.Gskt: [1] Included



B7180 Lube Spin-on
Notes: For Vertical Installation Only.
Contains: 35 PSID By-Pass Valve
Fits: Atlas Copco Mining Trucks; Coleman Generators; Detroit Diesel Engines; Hitachi, Terex, Unit Rig Dump Trucks; LeTourneau Loaders; MTU Diesel Engines
Replaces: Detroit Diesel 23526919
Thread: 1 1/2 -16
O.D.: 5 3/8 (136.5)
Height: 12 3/32 (307.2)
I.Gskt: [1] Included



B7175 Lube Spin-on
Fits: Detroit Diesel Engines
Replaces: Detroit Diesel 23540000
Thread: M45 x 1.5
O.D.: 5 3/8 (136.5)
Height: 12 3/32 (307.2)
I.Gskt: [1] Included



B7181 Lube Spin-on
Contains: Anti-Drainback Valve
Fits: Daewoo, Komatsu Equipment
Replaces: Daewoo 65055105015
Thread: 1 -16
O.D.: 3 11/16 (93.7)
Height: 7 1/8 (181.0)
I.Gskt: G381-A



BD7176 High Velocity Dual-Flow Lube Spin-on
Contains: Venturi-Type Cone
Fits: Cummins Engines
Replaces: Cummins 4016657; Fleetguard LF9050
Thread: M90 x 2.0
O.D.: 4 23/32 (119.9)
Height: 11 5/8 (295.3)
I.Gskt: [1] Included



B7182 Lube Spin-on
Contains: 35 PSID By-Pass Valve
Fits: DAF Trucks
Replaces: DAF 1316123, 1346986, 267715
Thread: 1 1/2 -16
O.D.: 5 3/8 (136.5)
Height: 8 7/8 (225.4)
I.Gskt: [1] Included
Related To: B7187 (Long Version)



Measurements Are Shown In Inches And (Millimeters)

WARNING: These products can expose you to chemicals, including Diisononyl Phthalate, Carbon black extracts, Nickel, 1,3 Butadiene, Ethylene Oxide, Epichlorohydrin, which are known to the State of California to cause cancer, and Bisphenol, Ethylene Glycol, Ethylene Oxide, 1,3 Butadiene, Epichlorohydrin, which are known to the State of California to cause birth defects or other reproductive harm. For more information go to www.P65Warnings.ca.gov.

P7183

Lube Element



Fits: Railroad Applications
Replaces: Clark C52; GE 2X4223, 41C615890
O.D.: 6 13/32 (162.7)
I.D.: 1 15/32 (37.3) One End
Height: 30 3/32 (764.4)
I.Gskt: [1] Included
A. Gskt: [1] Attached

P7190

Lube Element



Fits: M.A.N. Engines, Trucks
Replaces: M.A.N. 51.055040.098
O.D.: 4 3/4 (120.7)
I.D.: 2 7/32 (56.4)
Height: 5 27/32 (148.4)
A. Gskt: [2] Attached
O-Ring: [3] Included

P7185

By-Pass Lube Element



Fits: Hino Trucks
Replaces: Hino 15607-1210, 15607-1340, 15607-2160; Donaldson P502191; Fleetguard LF3709
O.D.: 4 25/32 (121.4)
I.D.: 29/32 (23.0)
Height: 9 3/4 (247.7)
F. Gskt: [2] Included
O-Ring: [2] Included
Grommets: [1] Included

B7191

Lube Spin-on



Contains: Anti-Drainback Valve
 30 PSID By-Pass Valve
 Standpipe
Replaces: Waukesha 304126
Thread: 1 1/8 -16
O.D.: 4 1/4 (108.0)
Height: 10 7/16 (265.1)
I.Gskt: [1] Included

BC7186 KIT

Paper Insert



Notes: Paper insert for Spinner II Models 36/60/66/76/96
Fits: Peterbilt Trucks
Replaces: Spinner II 70669, 71429
Length: 15 5/32 (385.0)
Width: 2 1/2 (63.5)
O-Ring: [2] Included

P7192

Lube Element



Fits: Demag, Grove Equipment; Mercedes-Benz Engines, Trucks, Vans
Replaces: Mercedes-Benz 5411800009, 5411240225; Renault 5001846632
O.D.: 4 21/32 (118.3)
I.D.: 2 1/8 (54.0) One End
Height: 12 1/4 (311.2)
O-Ring: [2] Included

B7187

Lube Spin-on



Contains: 35 PSID By-Pass Valve
Fits: DAF Trucks
Replaces: DAF 267714
Thread: 1 1/2 -16
O.D.: 5 3/8 (136.5)
Height: 12 3/8 (314.3)
I.Gskt: [1] Included
Related To: B7182 (Short Version)

P7193

Lube Element



Notes: Uses 4 filters per application.
Fits: Superior Compressors with Natural Gas Engines
Replaces: Superior 870078A
O.D.: 6 1/32 (153.2)
I.D.: 5/8 (15.9) & 2 (50.8)
Height: 11 13/32 (289.7)
A. Gskt: [1] Attached
F. Gskt: [1] Included
Grommets: [1] Attached

P7188

Lube Element



Fits: Equipment, Trucks with Deutz, Mercedes-Benz Engines; Fendt Tractors
Replaces: Deutz 2931095, 4252248; Mercedes-Benz 1801709, 9061800009, A0001801709
O.D.: 3 9/32 (83.3)
I.D.: 3/8 (9.5) & 1 9/16 (39.7)
Height: 8 3/8 (212.7)
O-Ring: [1] Included
End Seals: [1] Attached

BC7194

Centrifugal By-Pass Lube Element



Fits: DAF Trucks
Replaces: DAF 1310891, 1376481
O.D.: 3 27/32 (97.6)
I.D.: 9/16 (14.3)
Height: 4 1/2 (114.3)
F. Gskt: [1] Included
O-Ring: [1] Included

B7189

Lube Spin-on



Contains: Anti-Drainback Valve
 20 PSID By-Pass Valve
Fits: MDI/Yutani Equipment; Mitsubishi Engines, Trucks
Replaces: Mitsubishi ME014833
Thread: M20 x 1.5
O.D.: 4 1/4 (108.0)
Height: 4 3/4 (120.7)
I.Gskt: [1] Included

P7195









Lube Element



Fits: Komatsu Dump Trucks, Engines
Replaces: Komatsu 6128-51-5030
O.D.: 6 5/16 (160.3)
I.D.: 7/8 (22.2)
Height: 15 (381.0)
O-Ring: [2] Included

Measurements Are Shown In Inches And (Millimeters)

WARNING: These products can expose you to chemicals, including Diisononyl Phthalate, Carbon black extracts, Nickel, 1,3 Butadiene, Ethylene Oxide, Epichlorohydrin, which are known to the State of California to cause cancer, and Bisphenol, Ethylene Glycol, Ethylene Oxide, 1,3 Butadiene, Epichlorohydrin, which are known to the State of California to cause birth defects or other reproductive harm. For more information go to www.P65Warnings.ca.gov.

<p>P7196</p>  <p>Lube Element Fits: Fendt Tractors; M.A.N. Trucks; Mercedes-Benz Automotive, Engines Replaces: Mercedes-Benz 6021800009, 8021840025; Renault 6005019830 O.D.: 3 1/4 (82.6) I.D.: 1 7/16 (36.5) Height: 6 31/32 (177.0) O-Ring: [3] Included Grommets: [2] Attached</p>	<p>B7219</p>  <p>Lube Spin-on Contains: Anti-Drainback Valve 30 PSID By-Pass Valve 2 PSID Front-End Check Valve Fits: New Holland Tractors Replaces: New Holland 1931018 Thread: 3/4 -16 O.D.: 4 1/4 (108.0) Height: 4 3/8 (111.1) A. Gskt: G381-A</p>
<p>B7197</p>  <p>Lube Spin-on Contains: Anti-Drainback Valve 14 PSID By-Pass Valve Fits: Ingersoll-Rand Compressors, Engines Replaces: Ingersoll-Rand 54381314; Fleetguard LF3983 Thread: M20 x 1.5 O.D.: 3 11/16 (93.7) Height: 3 27/32 (97.6) I.Gskt: [1] Included</p>	<p>B7220</p>  <p>Lube Spin-on Contains: Anti-Drainback Valve 30 PSID By-Pass Valve Fits: Komatsu Equipment Replaces: Komatsu 600-211-6240, 600-211-6242 Thread: 1 -12 O.D.: 3 11/16 (93.7) Height: 3 1/4 (82.6) I.Gskt: G381-A</p>
<p>P7199</p>  <p>Lube Element Fits: Buses, Trucks with Mercedes-Benz Engines Replaces: Mercedes-Benz 1801609, A0001801609; Fleetguard LF3827 O.D.: 3 9/32 (83.3) I.D.: 3/8 (9.5) & 1 9/16 (39.7) Height: 5 15/16 (150.8) A. Gskt: [1] Attached O-Ring: [1] Included</p>	<p>B7221</p>  <p>Lube Spin-on Contains: Anti-Drainback Valve 8 PSID Front-End By-Pass Valve Fits: Equipment Using Lister-Petter LPA3A Engine Replaces: Lister 751-10620 Thread: 3/4 -16 O.D.: 3 11/16 (93.7) Height: 2 9/16 (65.1) I.Gskt: G381-A</p>
<p>B7215</p>  <p>Lube Spin-on Contains: 20 PSID By-Pass Valve Fits: Case-International, New Holland Equipment Replaces: New Holland 86605897 Thread: 1 -12 O.D.: 3 11/16 (93.7) Height: 6 5/8 (168.3) I.Gskt: G381-A</p>	<p>B7222</p>  <p>Lube Spin-on Contains: Anti-Drainback Valve 20 PSID By-Pass Valve Fits: Lincoln Ranger 8 Welder with Ruggerini Diesel Engine; Lister-Petter Industrial, Marine Engines Replaces: Ruggerini 17524; Fleetguard LF3826 Thread: 3/4 -16 O.D.: 3 1/16 (77.8) Height: 2 11/32 (59.5) I.Gskt: G449-B</p>
<p>B7216</p>  <p>Lube Spin-on Contains: Anti-Drainback Valve 30 PSID By-Pass Valve Fits: John Deere Mowers, Tractors all with Yanmar Engines Replaces: John Deere M806419 Thread: M20 x 1.5 O.D.: 3 (76.2) Height: 2 27/32 (72.2) I.Gskt: [1] Included</p>	<p>B7223</p>  <p>Lube Spin-on Contains: 30 PSID By-Pass Valve Fits: Komatsu Equipment Replaces: Komatsu 6136-51-5120, 6136-51-5121 Thread: 1 1/8 -16 O.D.: 4 1/4 (108.0) Height: 5 27/32 (148.4) I.Gskt: [1] Included</p>
<p>B7217</p>  <p>Lube Spin-on Contains: 20 PSID By-Pass Valve Fits: Hitachi, John Deere, Link-Belt Excavators Replaces: Hitachi 4448336 Thread: 1 1/2 -12 O.D.: 4 21/32 (118.3) Height: 8 3/32 (205.6) I.Gskt: [1] Included</p>	<p>B7224</p>  <p>Lube Spin-on Contains: 35 PSID By-Pass Valve Fits: DAF Trucks Replaces: DAF 1327672 Thread: M42 x 2.0 O.D.: 5 3/8 (136.5) Height: 12 3/8 (314.3) I.Gskt: [1] Included</p>

Measurements Are Shown In Inches And (Millimeters)

! **WARNING:** These products can expose you to chemicals, including Diisononyl Phthalate, Carbon black extracts, Nickel, 1,3 Butadiene, Ethylene Oxide, Epichlorohydrin, which are known to the State of California to cause cancer, and Bisphenol, Ethylene Glycol, Ethylene Oxide, 1,3 Butadiene, Epichlorohydrin, which are known to the State of California to cause birth defects or other reproductive harm. For more information go to www.P65Warnings.ca.gov.

B7225 Full-Flow Lube Spin-on
Notes: Uses 2 filters per application.
Fits: Mack Trucks
Replaces: Mack 485GB3232, 485GB3236
Thread: 1 1/8 -16
O.D.: 4 1/4 (108.0)
Height: 10 7/16 (265.1)
I.Gskt: [1] Included
Related To: B76 (Media Difference)



P7232 Lube Element
Fits: DAF Trucks
Replaces: DAF 1397764
O.D.: 4 11/32 (110.3)
I.D.: 2 1/4 (57.2)
Height: 5 7/8 (149.2)
A. Gskt: [2] Attached
O-Ring: [1] Included



B7227 Lube Spin-on
Fits: R.V.I. Trucks
Replaces: Renault 5010240400, 5010295195, 5010295196
Thread: 1 1/8 -16
O.D.: 4 1/4 (108.0)
Height: 7 3/8 (187.3)
I.Gskt: [1] Included



P7233 Lube Element
Fits: John Deere Engines, Equipment
Replaces: John Deere RE509672; Fleetguard LF16043
O.D.: 4 3/4 (120.7)
I.D.: 5/8 (7.9) & 2 1/16 (52.4)
Height: 5 25/32 (146.8)
A. Gskt: [1] Attached
O-Ring: [1] Included



BC7228 Centrifugal By-Pass Lube Element
Fits: Mack Engines
Replaces: Mack 57GC2206, 236GB41M
O.D.: 3 27/32 (97.6)
I.D.: 1/2 (12.7) & 5/8 (15.9)
Height: 7 (177.8)
F. Gskt: [1] Included



P7235 Lube Element
Fits: Ford Light-Duty Trucks; International Engines
Replaces: Ford 3C3Z-6731-AA; International 1840752-C91, 1844588-C91
O.D.: 3 9/32 (83.3)
I.D.: 3/8 (9.5) & 1 9/16 (39.7)
Height: 6 11/16 (169.9)
O-Ring: [1] Included
Related To: P7436, P7437 (with Lid)



B7229 Lube Spin-on
Contains: By-Pass Screen
 35 PSID By-Pass Valve
Fits: Detroit Diesel 4000 Series Engines
Replaces: Detroit Diesel 5241840301; Euclid E12980181; Donaldson P550512
Thread: M36 x 1.5
O.D.: 5 3/8 (136.5)
Height: 12 3/32 (307.2)
I.Gskt: [1] Included



BT7237 Lube Spin-on
Fits: Case, New Holland Equipment
Replaces: Case 87803261; DAF 1399494; Iveco 504074043; New Holland 87803260
Thread: M27 x 2.0
O.D.: 3 11/16 (93.7)
Height: 6 5/8 (168.3)
I.Gskt: [1] Included



P7230 Lube Element
Fits: Freightliner, Sterling, Western Star Trucks; Mercedes-Benz Engines
Replaces: Mercedes-Benz 1802109, 4571840125, A0001802109, A4571840125
O.D.: 4 3/4 (120.7)
I.D.: 9/16 (14.3) & 2 1/16 (52.4)
Height: 10 15/32 (265.9)
A. Gskt: [1] Attached
O-Ring: [1] Included



B7238 Lube Spin-on
Contains: Anti-Drainback Valve
 14 PSID By-Pass Valve
Fits: Onan Generators
Replaces: Onan 122-0836
Thread: 3/4 -16
O.D.: 2 9/16 (65.1)
Height: 4 3/4 (120.7)
I.Gskt: [1] Included



B7231 Lube Spin-on
Replaces: E.M.D. 40058635; Clark TL3FSO
Thread: 3/4 -16
O.D.: 3 11/16 (93.7)
Height: 7 1/8 (181.0)
I.Gskt: G381-A



B7239 Lube Spin-on
Contains: Anti-Drainback Valve
 Integral Post Seal
Fits: Daewoo Excavators
Replaces: Daewoo 65-05510-5016
Thread: 1 1/2 -12
O.D.: 4 21/32 (118.3)
Height: 8 3/32 (205.6)
I.Gskt: [1] Included



Measurements Are Shown In Inches And (Millimeters)

WARNING: These products can expose you to chemicals, including Diisononyl Phthalate, Carbon black extracts, Nickel, 1,3 Butadiene, Ethylene Oxide, Epichlorohydrin, which are known to the State of California to cause cancer, and Bisphenol, Ethylene Glycol, Ethylene Oxide, 1,3 Butadiene, Epichlorohydrin, which are known to the State of California to cause birth defects or other reproductive harm. For more information go to www.P65Warnings.ca.gov.

B7240 Lube Spin-on
Contains: Anti-Drainback Valve
 14 PSID By-Pass Valve
Fits: Kubota Equipment
Replaces: Kubota 70000-74035
Thread: 3/4 -16
O.D.: 3 11/16 (93.7)
Height: 3 1/4 (82.6)
I.Gskt: G401



B7241 Lube Spin-on
Contains: Anti-Drainback Valve
Fits: Daewoo Engines, Excavators
Replaces: Daewoo 65055105017, 65055105020;
 Fleetguard LF3716
Thread: 1 1/2 -12
O.D.: 4 21/32 (118.3)
Height: 9 15/16 (252.4)
I.Gskt: [1] Included



BC7242 Centrifugal By-Pass Lube Element
Fits: 8/19/03-on Mack ASET Engines S/N
 300079-up, 11/11/03-on ASET AI,
 AMI Engines S/N 3V0313-up
Replaces: Mack 57GC2231, 236GB42M
O.D.: 3 27/32 (97.6)
I.D.: 3/8 (9.5)
Height: 7 (177.8)
F. Gskt: [1] Included
O-Ring: [1] Included



B7243 Lube Spin-on
Contains: Anti-Drainback Valve
 20 PSID By-Pass Valve
Fits: Chrysler, Dodge, Hyundai, Kia,
 Mitsubishi Automotive, Light-Duty Trucks
Replaces: Mitsubishi MD352626, MZ690116;
 Hyundai 26300-35500, 26300-35501
Thread: M20 x 1.5
O.D.: 3 1/32 (77.0)
Height: 3 7/16 (87.3)
I.Gskt: [1] Included



B7245 High Efficiency Lube Spin-on
Fits: Gas Compression Industry
Thread: 1 1/2 -16
O.D.: 5 3/8 (136.5)
Height: 12 3/32 (307.2)
I.Gskt: [1] Included



B7246 Lube Spin-on with Drain Plug
Fits: Hitachi Cranes, Excavators
Replaces: Hitachi 4266385, 4430378;
 Fleetguard LF3603
Thread: 1 3/8 -16
O.D.: 4 29/32 (124.6)
Height: 10 1/16 (255.6)
I.Gskt: [1] Included



P7247 Transmission Filter
Fits: Ford Super Duty Pickups, E Series Vans
Replaces: Ford 3C3Z-7B155-BA;
 Motorcraft FT145
O.D.: 1 13/16 (46.0)
I.D.: 3/8 (9.5)
Height: 3 3/8 (85.7)
O-Ring: [1] Included



B7249-MPG Maximum Performance Glass Lube Spin-on
Replaces: Donaldson ELF7405;
 Fleetguard LF3566
Thread: 1 1/2 -16
O.D.: 5 3/8 (136.5)
Height: 12 3/32 (307.2)
I.Gskt: [1] Included
Related To: B99, B99-MPG, B99-SS (Different Media)



BD7250 High Velocity Dual-Flow Lube Spin-on
Contains: Venturi-Type Cone
Fits: International Engines, Trucks
Replaces: International 1841606-C1,
 1842639-C91; Donaldson P550656;
 Fleetguard LF9025
Thread: M95 x 2.0
O.D.: 4 21/32 (118.3)
Height: 14 7/32 (361.2)
I.Gskt: [1] Included
O-Ring: [2] Viton Included



BD7252 High Velocity Dual-Flow Lube Spin-on
Contains: Venturi-Type Cone
Fits: International Engines, Trucks
Replaces: International 1842543-C1,
 1842655-C91; Fleetguard LF90035
Thread: M92 x 2.0
O.D.: 4 21/32 (118.3)
Height: 10 11/32 (262.7)
I.Gskt: [1] Included
O-Ring: [2] Included



P7255 Lube Element
Replaces: Ford XS7Q-6744-AA;
 Fleetguard LF16113;
 Woodgate WGL9206
O.D.: 3 9/16 (90.5)
I.D.: 1 11/32 (34.1)
Height: 2 7/16 (61.9)



P7256 Lube Element
Replaces: Petter 393204;
 Woodgate WGL3456
O.D.: 2 1/32 (51.6)
I.D.: 29/32 (23.0)
Height: 2 25/32 (70.6)
A. Gskt: [2] Attached
F. Gskt: [1] Included
O-Ring: [1] Included



Measurements Are Shown In Inches And (Millimeters)

! **WARNING:** These products can expose you to chemicals, including Diisononyl Phthalate, Carbon black extracts, Nickel, 1,3 Butadiene, Ethylene Oxide, Epichlorohydrin, which are known to the State of California to cause cancer, and Bisphenol, Ethylene Glycol, Ethylene Oxide, 1,3 Butadiene, Epichlorohydrin, which are known to the State of California to cause birth defects or other reproductive harm. For more information go to www.P65Warnings.ca.gov.

P7259



Lube Element

Contains: By-Pass Valve
Fits: Hatz Engines
Replaces: Hatz 3795700;
 Fleetguard LF3794; Woodgate WGL9104
O.D.: 1 21/32 (42.1)
I.D.: 1/2 (12.7) One End
Height: 2 17/32 (64.3)
Grommets: [1] Attached

P7265



Lube Element

Replaces: Woodgate WGL9163
O.D.: 3 11/16 (93.7)
I.D.: 1 31/32 (50.0)
Height: 5 13/32 (137.3)

P7260



Lube Element

Replaces: Robin 2286430101;
 Woodgate WGL9121
O.D.: 1 7/32 (31.0)
 Flange 1 25/32 x 2 9/16 (45.2 x 65.1)
I.D.: 15/32 (11.9) One End
Height: 2 17/32 (64.3)
O-Ring: [1] Attached

P7267



Lube Element

Replaces: Hino 15607-1531;
 Woodgate WGL9195
O.D.: 4 13/16 (122.2)
I.D.: 2 1/32 (16.7)
Height: 8 21/32 (219.9)
F. Gskt: [3] Included
O-Ring: [2] Included

P7261



Wire Mesh Lube Element

Notes: Closed end has tabs on end cap.
Fits: Honda Engines
Replaces: Honda 15221-ZG3-000;
 Woodgate WGL9122
O.D.: 1 3/16 (30.2) to 1 13/32 (357)
I.D.: 5/8 (7.9) One End
Height: 2 11/32 (59.5)
Grommets: [1] Attached

P7268



Wire Mesh Supported Lube Element

Replaces: Fairey-Arlon TXW5CC10;
 Woodgate WGTW5CC-10
O.D.: 4 3/16 (106.4)
I.D.: 13/32 (10.3) & 2 27/32 (72.2)
Height: 10 3/16 (258.8)
O-Ring: [1] Attached

P7262



Lube Element with Lift Tab

Contains: By-Pass Valve
Fits: Lombardini Engines
Replaces: Lombardini 500.2175.19;
 Woodgate WGL9123
O.D.: 29/32 (22.9)
I.D.: 13/32 (10.3) One End
Height: 2 11/32 (59.5)
A. Gskt: [1] Attached

P7269



Lube Element with Bail Handle

Replaces: Woodgate WGL3605N
O.D.: 3 7/32 (81.8)
I.D.: 7/8 (22.2)
Height: 5 3/16 (131.8)
O-Ring: [2] Included, [1] Copper O-Ring
Grommets: [2] Attached

P7263



Lube Element with Lift Tab

Contains: By-Pass Valve
Fits: Ruggerini Engines
Replaces: Ruggerini 17505;
 Woodgate WGL9125
O.D.: 29/32 (23.0)
I.D.: 13/32 (10.3)
Height: 2 7/8 (73.0)
A. Gskt: [1] Attached

B7271



Lube Spin-on

Contains: Anti-Drainback Valve
 8-12 PSID By-Pass Valve
 Standpipe
Fits: Case, Terex Equipment
Replaces: Massey Ferguson 3621292-M1;
 Woodgate WGL3353
Thread: 3/4 -16
O.D.: 3 11/16 (93.7)
Height: 4 1/2 (114.3)
I.Gskt: [1] Included

P7264



Lube Element

Contains: By-Pass Valve
Fits: Hitachi, John Deere Excavators
Replaces: Hitachi 4294132;
 Woodgate WGL9126
O.D.: 3 9/16 (90.5)
I.D.: 1 5/8 (41.3) One End
Height: 8 7/32 (208.8)
O-Ring: [1] Attached

B7273



Lube Spin-on

Contains: Anti-Drainback Valve
 By-Pass Valve
Fits: J.C. Bamford Excavators
Replaces: J.C. Bamford 2/800176;
 Woodgate WGL3528
Thread: M20 x 1.5
O.D.: 3 5/8 (92.1)
Height: 5 1/16 (128.6)
I.Gskt: [1] Included

Measurements Are Shown In Inches And (Millimeters)

WARNING: These products can expose you to chemicals, including Diisononyl Phthalate, Carbon black extracts, Nickel, 1,3 Butadiene, Ethylene Oxide, Epichlorohydrin, which are known to the State of California to cause cancer, and Bisphenol, Ethylene Glycol, Ethylene Oxide, 1,3 Butadiene, Epichlorohydrin, which are known to the State of California to cause birth defects or other reproductive harm. For more information go to www.P65Warnings.ca.gov.

B7274 Lube Spin-on
Contains: 20 PSID By-Pass Valve Standpipe
Fits: J.C. Bamford Equipment
Replaces: J.C. Bamford 32/915500; Woodgate WGL9035
Thread: 1 -12
O.D.: 3 11/16 (93.7)
Height: 4 3/8 (111.1)
I.Gskt: [1] Included



B7285 Lube Spin-on
Contains: Anti-Drainback Valve 20 PSID By-Pass Valve
Fits: Kubota Engines, Equipment
Replaces: Kubota 15853-32430; Woodgate WGL9187
Thread: M20 x 1.5
O.D.: 2 9/16 (65.1)
Height: 2 5/8 (66.7)
I.Gskt: [1] Included



B7275 Lube Spin-on
Contains: Anti-Drainback Valve By-Pass Valve
Replaces: Ford 89FF-6714-A1C; Mercedes-Benz 1031800610; Woodgate WGL9107
Thread: 3/4 -16
O.D.: 3 (76.2)
Height: 3 27/32 (97.6)
I.Gskt: [1] Included



B7286 Lube Spin-on
Contains: Anti-Drainback Valve By-Pass Valve
Replaces: Iseki 621324000210; Woodgate WGL9200
Thread: 3/4 -16
O.D.: 2 11/16 (68.3)
Height: 3 (76.2)
I.Gskt: [1] Included



B7276 Lube Spin-on
Contains: Anti-Drainback Valve 14 PSID By-Pass Valve
Fits: Lombardini Engines
Replaces: Lombardini 105.2175.136, 115.2175.136; Woodgate WGL9130
Thread: M20 x 1.5
O.D.: 3 (76.2)
Height: 2 5/16 (58.7)
I.Gskt: [1] Included



B7287 Lube Spin-on
Replaces: Iseki 621324000510; Woodgate WGL9201
Thread: 3/4 -16
O.D.: 3 1/32 (77.0)
Height: 3 3/16 (81.0)
I.Gskt: [1] Included



B7277 Lube Spin-on
Contains: By-Pass Valve
Replaces: Fiat-Iveco 5495622; Mercedes-Benz 1031840201; Woodgate WGL9132
Thread: M20 x 1.5
O.D.: 3 3/32 (78.6)
Height: 3 27/32 (97.6)
I.Gskt: [1] Included



B7289 Lube Spin-on
Contains: Anti-Drainback Valve By-Pass Valve
Fits: Toro Groundsmaster, Reelmaster Tractors
Replaces: Toro 74-7970; Woodgate WGL9109
Thread: M20 x 1.5
O.D.: 3 (76.2)
Height: 3 11/32 (84.9)
I.Gskt: [1] Included



B7280 Lube Spin-on
Replaces: GMC 93156631; Woodgate WGL9160
Thread: M20 x 1.5
O.D.: 4 9/32 (108.7)
Height: 4 (101.6)
I.Gskt: [1] Included



B7290 Lube Spin-on
Contains: Anti-Drainback Valve 14 PSID By-Pass Valve
Fits: Caterpillar, Lombardini, Ruggieri Engines
Replaces: Lombardini 500.217.536; Woodgate WGL3338
Thread: 3/4 -16
O.D.: 3 (76.2)
Height: 3 7/8 (98.4)
I.Gskt: [1] Included



B7281 Lube Spin-on
Contains: Anti-Drainback Valve 14 PSID By-Pass Valve
Replaces: Yanmar 119100-35100; Woodgate WGL3536
Thread: M20 x 1.5
O.D.: 3 7/32 (81.8)
Height: 3 7/8 (98.4)
I.Gskt: [1] Included



B7291 Lube Spin-on
Contains: Anti-Drainback Valve 17 PSID By-Pass Valve
Replaces: Leyland ADU3553; Fleetguard LF3643; Woodgate WGL3643
Thread: 13/16 -16
O.D.: 3 5/8 (92.1)
Height: 3 7/8 (98.4)
I.Gskt: [1] Included



B7283 Lube Spin-on
Contains: Anti-Drainback Valve By-Pass Valve
Replaces: Renault 7701727480; Woodgate WGL9180
Thread: M20 x 1.5
O.D.: 3 1/2 (88.9)
Height: 2 11/32 (59.5)
I.Gskt: [1] Included



B7292 Lube Spin-on
Contains: 8-12 PSID By-Pass Valve
Fits: Ducati Motorcycles
Replaces: GMC 7984608; Woodgate WGL9032
Thread: M16 x 1.5
O.D.: 3 (76.2)
Height: 2 31/32 (75.4)
I.Gskt: [1] Included



Measurements Are Shown In Inches And (Millimeters)

WARNING: These products can expose you to chemicals, including Diisononyl Phthalate, Carbon black extracts, Nickel, 1,3 Butadiene, Ethylene Oxide, Epichlorohydrin, which are known to the State of California to cause cancer, and Bisphenol, Ethylene Glycol, Ethylene Oxide, 1,3 Butadiene, Epichlorohydrin, which are known to the State of California to cause birth defects or other reproductive harm. For more information go to www.P65Warnings.ca.gov.

B7293 Lube Spin-on
Contains: Anti-Drainback Valve
 By-Pass Valve
Replaces: Lister 601-32950;
 Woodgate WGL9131
Thread: M16 x 1.5
O.D.: 3 3/32 (78.6)
Height: 2 1/2 (63.5)
I.Gskt: [1] Included



B7294 Lube Spin-on
Contains: Anti-Drainback Valve
 32 PSID By-Pass Valve
Fits: Bomag Rollers with Deutz Engines
Replaces: Deutz 1180815; Woodgate WGL9060
Thread: 3/4 -16
O.D.: 3 (76.2)
Height: 2 9/32 (57.9)
I.Gskt: [1] Included



B7295 Lube Spin-on
Fits: Claas Combines
Replaces: Woodgate WGL3310
Thread: 3/4 -16
O.D.: 3 (76.2)
Height: 3 1/8 (79.4)
I.Gskt: [1] Included



B7298 Lube Spin-on
Contains: Anti-Drainback Valve
 14 PSID By-Pass Valve
Fits: Kubota Equipment
Replaces: Kubota 1C020-32430;
 Woodgate WGL9202
Thread: 3/4 -16
O.D.: 3 23/32 (94.5)
Height: 3 31/32 (100.8)
I.Gskt: [1] Included



B7299 High Efficiency Lube Spin-on
Fits: Caterpillar Engines
Replaces: Caterpillar 1R1808
Thread: 1 1/2 -16
O.D.: 5 3/8 (136.5)
Height: 12 3/32 (307.2)
I.Gskt: [1] Included
Related To: B99, B99-MPG, B99-SS (Standard Versions)
 B7507 (w/3 O-Rings)



P7302 Wire Mesh Lube Element with Lift Tab
Contains: By-Pass Valve
Replaces: Lombardini 560.2175.044;
 Woodgate WGL9124
O.D.: 1 1/16 (27.0)
I.D.: 3/8 (9.5) One End
Height: 3 1/32 (77.0)
A. Gskt: [1] Attached



P7303 Lube Element with Bail Handle
Contains: By-Pass Valve
Fits: Lombardini Engines
Replaces: Lombardini 710.275.138;
 Woodgate WGL9157
O.D.: 1 17/32 (38.9)
I.D.: 15/32 (11.9)
Height: 2 17/32 (64.3)
A. Gskt: [1] Attached



P7305 Lube Element
Fits: M.A.N. Trucks
Replaces: Mann & Hummel HU947/1n;
 Mercedes-Benz 3661801009, 3661801025,
 3661840125
O.D.: 3 9/32 (83.3)
I.D.: 15/16 (23.8)
Height: 7 19/32 (192.9)
F. Gskt: [1] Metal Washer
O-Ring: [2] Included



B7306 Lube Spin-on
Contains: 30 PSID By-Pass Valve
Fits: John Deere Engines, Tractors
Replaces: John Deere RE518977
Thread: M24 x 1.5
O.D.: 3 11/16 (93.7)
Height: 5 13/32 (137.3)
I.Gskt: G401



P7308 Lube Element
Fits: Volkswagen Automotive
Replaces: Volkswagen 74115562
O.D.: 2 17/32 (64.3)
I.D.: 21/32 (16.7)
Height: 6 1/32 (153.2)
A. Gskt: [2] Attached
O-Ring: [2] Included



BD7309 High Velocity Dual-Flow Lube Spin-on
Contains: Venturi-Type Cone
Fits: Cummins Engines
Replaces: Cummins 3401544
Thread: 2 1/4 -12
O.D.: 4 21/32 (118.3)
Height: 11 13/32 (289.7)
I.Gskt: [1] Included
Related To: BD103 (Standard Version)



BD7310 High Velocity Dual-Flow Lube Spin-on
Contains: Venturi-Type Cone
Fits: John Deere Equipment
Replaces: John Deere RE58935
Thread: M52 x 1.5
O.D.: 4 21/32 (118.3)
Height: 11 13/32 (289.7)
I.Gskt: G293-B



B7311-MPG Maximum Performance Glass Lube Spin-on
Contains: Anti-Drainback Valve
 8 PSID By-Pass Valve
Fits: Carrier Refrigeration Units
Replaces: Carrier 30-00450-00;
 Fleetguard LF3947
Thread: 3/4 -16
O.D.: 3 11/16 (93.7)
Height: 7 1/8 (181.0)
I.Gskt: G381-A



Measurements Are Shown In Inches And (Millimeters)

WARNING: These products can expose you to chemicals, including Diisononyl Phthalate, Carbon black extracts, Nickel, 1,3 Butadiene, Ethylene Oxide, Epichlorohydrin, which are known to the State of California to cause cancer, and Bisphenol, Ethylene Glycol, Ethylene Oxide, 1,3 Butadiene, Epichlorohydrin, which are known to the State of California to cause birth defects or other reproductive harm. For more information go to www.P65Warnings.ca.gov.

P7312



Lube Element

Notes: Inside-Out Flow Direction
Replaces: Wartsila 5611F185, 5611F216
O.D.: 4 31/32 (126.2)
I.D.: 9/16 (14.3) & 3 5/8 (92.1)
Height: 11 7/16 (290.5)
F. Gskt: [1] Included
O-Ring: [2] Included

P7319



Lube Element

Fits: Scania Generator Sets, Trucks
Replaces: Scania 1439036;
 Fleetguard LF3895
O.D.: 4 1/32 (102.4)
I.D.: 1 25/32 (45.2) One End
Height: 10 (254.0)
O-Ring: [1] Included

P7313



Lube Element

Fits: Ford, Mazda Automotive
Replaces: Ford 3M4Z-6744-AC;
 Mazda L321-14-302
O.D.: 2 9/16 (65.1)
I.D.: 31/32 (24.6)
Height: 2 7/8 (73.0)
O-Ring: [2] Included

B7320



Lube Spin-on

Contains: Anti-Drainback Valve
 40 PSID By-Pass Valve
Fits: Demag Compressors; Volvo Loaders
Replaces: Volvo 11700375;
 Mann & Hummel W940/18
Thread: 1 -12
O.D.: 3 11/16 (93.7)
Height: 5 3/8 (136.5)
I.Gskt: G381-A

B7314



Lube Spin-on

Contains: 35 PSID By-Pass Valve
Fits: International 4400 DurStar
Replaces: International 1842816-C2
Thread: M45 x 1.5
O.D.: 5 3/8 (136.5)
Height: 9 5/8 (244.5)
I.Gskt: [1] Included

P7321



Lube Element

Notes: Inside-Out Flow Direction
Replaces: Perkins 996452, CH10929
O.D.: 4 29/32 (124.6)
I.D.: 1 11/16 (42.9) One End
Height: 10 21/32 (270.7)
O-Ring: [1] Included

BT7316



Lube Spin-on

Contains: Anti-Drainback Valve
 30 PSID By-Pass Valve
 Standpipe
Fits: Case-International Tractors
Replaces: Case 47128196
Thread: 3/4 -16
O.D.: 4 1/4 (108.0)
Height: 5 13/16 (147.6)
I.Gskt: G381-A

B7322



Lube Spin-on

Fits: John Deere Equipment
Replaces: John Deere RE504836
Thread: M92 x 2.5
O.D.: 3 29/32 (99.2)
Height: 5 15/16 (150.8)
I.Gskt: [1] Included

BD7317



Dual-Flow Lube Spin-on

Contains: Venturi-Type Cone
Fits: Carrier Refrigeration Units
Replaces: Carrier 30-00463-00;
 Fleetguard LF9028
Thread: 1 -16
O.D.: 3 11/16 (93.7)
Height: 7 1/8 (181.0)
I.Gskt: [1] Included

B7324



Lube Spin-on

Contains: 14 PSID By-Pass Valve
Fits: J.C. Bamford Equipment with Isuzu
 Engines
Replaces: Isuzu 87610-006, 1-87610-006-0;
 J.C. Bamford 02/801481, 581/18096
Thread: 1 1/2 -12
O.D.: 4 21/32 (118.3)
Height: 8 3/32 (205.6)
I.Gskt: [1] Included

B7318



Lube Spin-on

Contains: Anti-Drainback Valve
 20 PSID By-Pass Valve
Fits: Volvo Excavators
Replaces: Volvo 7410062
Thread: M20 x 1.5
O.D.: 2 9/16 (65.1)
Height: 3 1/2 (88.9)
I.Gskt: [1] Included

BD7325



Dual-Flow Lube Spin-on

Fits: Hino, Nissan UD Trucks
Replaces: Hino 15607-2190
Thread: 1 1/2 -16
O.D.: 4 21/32 (118.3)
Height: 8 1/8 (206.4)
I.Gskt: [1] Included

Measurements Are Shown In Inches And (Millimeters)

WARNING: These products can expose you to chemicals, including Diisononyl Phthalate, Carbon black extracts, Nickel, 1,3 Butadiene, Ethylene Oxide, Epichlorohydrin, which are known to the State of California to cause cancer, and Bisphenol, Ethylene Glycol, Ethylene Oxide, 1,3 Butadiene, Epichlorohydrin, which are known to the State of California to cause birth defects or other reproductive harm. For more information go to www.P65Warnings.ca.gov.

BC7326 Centrifugal Lube Element
Fits: Freightliner, Kenworth, Peterbilt, Sterling Trucks; Mercedes-Benz, Paccar Engines
Replaces: Mercedes-Benz A9061810086; Fleetguard CS41008
O.D.: 3 11/16 (93.7)
I.D.: 1/4 (6.4) One End
Height: 5 13/16 (147.6)
O-Ring: [1] Included
Related To: BC7485 (Different O-Ring)



B7333 Lube Spin-on
Contains: Anti-Drainback Valve By-Pass Valve
Fits: Cushman Equipment
Replaces: Jacobsen 2701908; Suzuki 16510-82703
Thread: 3/4 -16
O.D.: 2 25/32 (70.6)
Height: 2 5/8 (66.7)
I.Gskt: [1] Included



B7327 Lube Spin-on
Contains: Anti-Drainback Valve
Fits: Case-International, New Holland Tractors
Replaces: Case 2854750, 87803206
Thread: M27 x 2.0
O.D.: 3 11/16 (93.7)
Height: 6 5/8 (168.3)
I.Gskt: G381-A



B7334 Lube Spin-on
Contains: Anti-Drainback Valve 14 PSID By-Pass Valve
Fits: Equipment with Cummins A1400, A1700, A2000, A2300 Engines
Replaces: Kukje HRA11020F4A3; Fleetguard LF16034
Thread: M20 x 1.5
O.D.: 3 1/32 (77.0)
Height: 3 7/16 (87.3)
I.Gskt: [1] Included



B7328 Lube Spin-on
Fits: New Holland Equipment
Replaces: New Holland 87803201
Thread: M27 x 2.0
O.D.: 3 23/32 (94.5)
Height: 3 7/8 (98.4)
I.Gskt: G381-A



B7335-MPG Maximum Performance Glass Lube Spin-on
Fits: John Deere Equipment
Replaces: John Deere RE521420; Fleetguard LF16106
Thread: 1 5/8 -12
O.D.: 5 1/16 (128.6)
Height: 6 31/32 (177.0)
F. Gskt: G369-B
O-Ring: G447



P7329 Lube Element
Fits: ERF Trucks; M.A.N. Engines, Trucks; R.V.I. Trucks; Volvo Engines, Trucks; Volvo-Penta Generators
Replaces: M.A.N. 51.05504.0107, 51.05504.0108
O.D.: 4 3/4 (120.7)
I.D.: 9/16 (14.3) & 2 1/16 (52.4)
Height: 7 7/8 (200.0)
A. Gskt: [1] Included
O-Ring: [1] Included



P7336 KIT Set of 2 Hydraulic Breather Elements
Fits: Iveco EuroCargo Trucks
Replaces: Iveco 2992447; Coopers AEM2940; Hengst EAS304MD152; Mann & Hummel C911X2
Each Element
O.D.: 2 3/32 (53.2) to 3 9/32 (83.3)
I.D.: 21/32 (16.7) One End
Height: 2 3/4 (69.9)
F. Gskt: [1] Included
Grommets: [1] Attached to Each Element



P7330 Lube Element
Fits: DAF Buses, Trucks
Replaces: DAF 1397765; Hengst E43HD97; Mann & Hummel HU1297X
O.D.: 4 7/16 (112.7)
I.D.: 2 19/32 (65.9)
Height: 8 17/32 (216.7)
A. Gskt: [2] Attached
O-Ring: [1] Included



P7337 2-Section Hydraulic Element
Replaces: Cummins 3420742; Fleetguard LF16031
O.D.: 7 21/32 (194.5)
I.D.: 4 21/32 (118.3)
Height: 16 (406.4)
A. Gskt: [2] Attached



PT7332 Full-Flow Lube or Hydraulic Element
Contains: Reinforced Centertube
Fits: American Hoist & Derrick, Caterpillar, Clark, Gardner Denver, Koehring, Komatsu LeRoi, Link-Belt Equipment
Replaces: Caterpillar 1R0659; Deutz 1161212; Komatsu 611-4505-100
O.D.: 3 15/16 (100)
I.D.: 1 19/32 (40.5)
Height: 9 9/32 (235.7)
F. Gskt: G171, G214, [1] Included
O. Gskt: G115-MSB, G342, G435
Related To: PT670 (with Paper Wrapper)



P7338 Lube Element
Fits: Volvo Automotive
Replaces: Volvo 12758116
O.D.: 2 7/8 (73.0)
I.D.: 1 1/32 (26.2)
Height: 3 5/32 (80.2)
O-Ring: [1] Included



Measurements Are Shown In Inches And (Millimeters)

WARNING: These products can expose you to chemicals, including Diisononyl Phthalate, Carbon black extracts, Nickel, 1,3 Butadiene, Ethylene Oxide, Epichlorohydrin, which are known to the State of California to cause cancer, and Bisphenol, Ethylene Glycol, Ethylene Oxide, 1,3 Butadiene, Epichlorohydrin, which are known to the State of California to cause birth defects or other reproductive harm. For more information go to www.P65Warnings.ca.gov.

BT7349

Lube Spin-on



Notes: BT7349 may be used in place of BT339. Do NOT substitute BT339 for BT7349. Can is fluted for improved installation.
Fits: Dodge Light-Duty Trucks with 5.9L and 6.7L Turbo Diesel Engines
Replaces: Chrysler 5083285AA
Thread: 1 -16
O.D.: 3 11/16 (93.7)
Height: 7 1/8 (181.0)
I.Gskt: G381-A

B7356

Lube Spin-on



Contains: Anti-Drainback Valve
8 PSID By-Pass Valve
Fits: Agco, Challenger, Massey Ferguson Tractors
Replaces: Agco 72201898; Massey Ferguson 3609410-M1, 3710280-M2
Thread: 3/4 -16
O.D.: 2 9/16 (65.1)
Height: 2 5/8 (66.7)
I.Gskt: [1] Included

B7350

Lube Spin-on



Contains: Anti-Drainback Valve
35 PSID By-Pass Valve
Check Valve
Fits: Gillisons GVF5000 Lift Truck; J.C. Bamford Generators, Equipment
Replaces: J.C. Bamford 320/04133; Alco SP-1294
Thread: M22 x 1.5
O.D.: 3 25/32 (96.0)
Height: 6 11/16 (169.9)
I.Gskt: [1] Included

B7357

Lube Spin-on



Contains: 30 PSID By-Pass Valve
Fits: Tata Engines
Replaces: Tata Cummins 252518130139; Fleetguard LF16060
Thread: 1 -14
O.D.: 3 23/32 (94.5)
Height: 8 1/8 (206.4)
I.Gskt: G401

B7351-MPG

Maximum Performance Glass Lube Spin-on



Fits: Komatsu Loaders
Replaces: Komatsu 6731525130
Thread: 1 -16
O.D.: 3 11/16 (93.7)
Height: 5 3/8 (136.5)
I.Gskt: G381-A

B7359

Lube Spin-on



Contains: 20 PSID By-Pass Valve
Fits: Tata Engines
Replaces: Tata Cummins 253418130165; Fleetguard LF16062
Thread: 13/16 -16
O.D.: 3 23/32 (94.5)
Height: 5 15/32 (138.9)
I.Gskt: G401

B7352

Lube Spin-on



Contains: Anti-Drainback Valve
11 PSID By-Pass Valve
Fits: R.V.I. Trucks
Replaces: Renault 7700720978, 7700734825, 7700856339, 7700867454, 7701349942
Thread: M20 x 1.5
O.D.: 3 1/8 (79.4)
Height: 3 17/32 (89.7)
I.Gskt: [1] Included

B7360

Lube Spin-on



Contains: Anti-Drainback Valve
40 PSID By-Pass Valve
Fits: Tata Engines
Replaces: Tata Cummins 253418130169; Fleetguard LF16056
Thread: M24 x 1.5
O.D.: 3 11/16 (93.7)
Height: 5 11/16 (144.5)
I.Gskt: G401

BD7353

Dual-Flow Lube Spin-on



Notes: OBSOLETE. Availability Limited to Dealer Stock. Replaced by BD40027.
Fits: John Deere Equipment
Replaces: John Deere RE530107; Fleetguard LF9032
Thread: M52 x 1.5
O.D.: 4 21/32 (118.3)
Height: 14 7/32 (361.2)
I.Gskt: [1] Included

B7361

Lube Spin-on



Contains: Anti-Drainback Valve
14 PSID By-Pass Valve
Fits: J.C. Bamford Equipment
Replaces: J.C. Bamford 2/630935, 2/630935A
Thread: 3/4 -16
O.D.: 3 (76.2)
Height: 3 17/32 (89.7)
I.Gskt: G449-B

BD7355

Dual-Flow Lube Spin-on



Fits: Komatsu Equipment
Replaces: Komatsu 600-211-1340; Fleetguard LF9018
Thread: M95 x 2.5
O.D.: 4 11/16 (119.1)
Height: 11 25/32 (299.2)
I.Gskt: [1] Included

B7362

Lube Spin-on



Contains: 30 PSID By-Pass Valve
Fits: Tata Engines
Replaces: Tata Cummins 252718130132; Fleetguard LF16061
Thread: 1 -16
O.D.: 3 11/16 (93.7)
Height: 6 9/16 (167.5)
I.Gskt: G381-A

Measurements Are Shown In Inches And (Millimeters)

WARNING: These products can expose you to chemicals, including Diisononyl Phthalate, Carbon black extracts, Nickel, 1,3 Butadiene, Ethylene Oxide, Epichlorohydrin, which are known to the State of California to cause cancer, and Bisphenol, Ethylene Glycol, Ethylene Oxide, 1,3 Butadiene, Epichlorohydrin, which are known to the State of California to cause birth defects or other reproductive harm. For more information go to www.P65Warnings.ca.gov.

B7363 Full-Flow Lube Spin-on
Contains: 50 PSID By-Pass Valve
 By-Pass Screen
Fits: Agco, Challenger, Massey Ferguson Tractors
Replaces: Agco V836862582; Sisu 836862582; Mann & Hummel W1374/7
Thread: 1 1/2 -16
O.D.: 5 3/8 (136.5)
Height: 7 (177.8)
I.Gskt: [1] Included



B7370 Lube Spin-on
Contains: Anti-Drainback Valve
 30 PSID By-Pass Valve
Fits: Dongfeng DF304G2 Tractors
Replaces: CLARCOR Filtration (China) JX0811A
Thread: 1 -12
O.D.: 3 19/32 (91.3)
Height: 5 1/8 (130.2)
I.Gskt: [1] Included



P7364 Lube Element
Fits: Hyundai Genesis, Sonata, Veracruz; Kia Sorento
Replaces: Hyundai 26320-3C250
O.D.: 2 9/16 (65.1)
I.D.: 1 1/16 (27.0)
Height: 4 7/32 (107.2)
I.Gskt: [2] Included
F. Gskt: [1] Metal Washer
O-Ring: [2] Included



P7371 Lube Element
Notes: OBSOLETE. Availability Limited to Dealer Stock.
Replaces: Cummins 3166556; Fleetguard India LF16030
O.D.: 4 31/32 (126.2)
I.D.: 1 9/16 (39.7)
Height: 4 15/16 (125.4)
A. Gskt: [2] Attached



P7365 Lube Element
Fits: Nissan Light Duty Trucks
Replaces: Nissan 15209-00QAC, 15209-2W200; Opel 4415218; Renault 7701057828
O.D.: 3 1/32 (77.0)
I.D.: 7/8 (22.2)
Height: 4 1/16 (103.2)
A. Gskt: [2] Attached
O-Ring: [1] Included



B7372 Lube Spin-on
Contains: Anti-Drainback Valve
Fits: Daewoo Excavators
Replaces: Doosan 47100093, 65055105028A
Thread: 1 -16
O.D.: 3 11/16 (93.7)
Height: 7 5/32 (181.8)
I.Gskt: G381-A



B7367 Lube Spin-on
Contains: Anti-Drainback Valve
 30 PSID By-Pass Valve
Replaces: CLARCOR Filtration (China) JX0818, WB236, Huafeng Power (Shandong Weichai Huafeng Power Co., Ltd.) 61000070005
Thread: 1 -12
O.D.: 3 19/32 (91.3)
Height: 8 1/8 (206.4)
I.Gskt: [1] Included



B7373 Lube Spin-on
Contains: Anti-Drainback Valve
 40 PSID By-Pass Valve
Replaces: Baudouin 15041680C; Fleetguard LF3808; Mann & Hummel W1140/8
Thread: 1 -12
O.D.: 4 1/4 (108.0)
Height: 4 3/4 (120.7)
I.Gskt: [1] Included



P7368 By-Pass Lube Element
Fits: Cummins Engines
Replaces: Cummins 3873576; Fleetguard LF16029
O.D.: 5 1/32 (127.8)
I.D.: 1 1/2 (38.1) One End
Height: 8 11/16 (220.7)
Grommets: [1] Attached



B7375 Lube Spin-on
Fits: Thermo King Refrigeration Units
Replaces: Thermo King 11-9182; Donaldson P550835; Fleetguard LF9030, LF16164
Thread: 1 1/8 -12
O.D.: 3 11/16 (93.7)
Height: 7 1/8 (181.0)
I.Gskt: [1] Included



B7369 Lube Spin-on
Contains: Anti-Drainback Valve
 20 PSID By-Pass Valve
Replaces: Weichai Power 12272453; CLARCOR Filtration (China) WB202B
Thread: 3/4 -16
O.D.: 3 19/32 (91.3)
Height: 5 1/8 (130.2)
I.Gskt: [1] Included



B7376 Lube Spin-on
Contains: Anti-Drainback Valve
 40 PSID By-Pass Valve
 Standpipe
Fits: Iveco Daily Trucks
Replaces: Iveco 2995561
Thread: M22 x 1.5
O.D.: 3 11/16 (93.7)
Height: 6 5/8 (168.3)
I.Gskt: G381-A



Measurements Are Shown In Inches And (Millimeters)

WARNING: These products can expose you to chemicals, including Diisononyl Phthalate, Carbon black extracts, Nickel, 1,3 Butadiene, Ethylene Oxide, Epichlorohydrin, which are known to the State of California to cause cancer, and Bisphenol, Ethylene Glycol, Ethylene Oxide, 1,3 Butadiene, Epichlorohydrin, which are known to the State of California to cause birth defects or other reproductive harm. For more information go to www.P65Warnings.ca.gov.

B7377 Lube Spin-on
Contains: Anti-Drainback Valve
 40 PSID By-Pass Valve
Fits: Citroen, Fiat, Iveco Daily Vans
Replaces: Citroen 1109Y6; Fiat 8093784;
 Iveco 2992188; Alco SP1269
Thread: M22 x 1.5
O.D.: 3 11/16 (93.7)
Height: 5 3/8 (136.5)
I.Gskt: G381-A



B7378 Lube Spin-on
Contains: Anti-Drainback Valve
 20 PSID By-Pass Valve
Fits: Caterpillar Equipment
Replaces: Caterpillar 269-8325;
 Donaldson P550920
Thread: M24 x 1.5
O.D.: 3 11/16 (93.7)
Height: 8 1/8 (206.4)
I.Gskt: G381-A



B7379 Lube Spin-on
Contains: Anti-Drainback Valve
 20 PSID By-Pass Valve
Fits: Ford Super Duty Pickups with V8-406
 (6.7L) Turbo Diesel Engine
Replaces: Motorcraft FL2051
Thread: 1 -16
O.D.: 3 11/16 (93.7)
Height: 6 7/16 (163.5)
I.Gskt: G381-A



P7380 Lube Element
Replaces: CLARCOR Filtration (China)
 12VB1810B; Jinan Diesel Engine Co.
 12VB1810B
O.D.: 5 23/32 (145.3)
I.D.: 2 7/16 (61.9)
Height: 5 5/8 (142.9)



P7381 Lube Element
Replaces: CLARCOR Filtration (China)
 30121810A; Jinan Diesel Engine Co. 30121810
O.D.: 5 3/4 (146.1)
I.D.: 2 3/8 (60.3)
Height: 11 7/16 (290.5)
A. Gskt: [1] Attached



B7383 Lube Spin-on
Contains: 35 PSID By-Pass Valve
Replaces: CLARCOR Filtration (China) JX1016;
 Sinotruk VG1246070031; Weichai Power
 612630010239
Thread: M30 x 2.0
O.D.: 4 1/4 (108.0)
Height: 7 11/16 (195.3)
I.Gskt: [1] Included



B7384 Lube Spin-on
Contains: 25 PSID By-Pass Valve
Replaces: CLARCOR Filtration (China)
 WB202E; FAW-Xichai 1012015AB010000
Thread: M20 x 1.5
O.D.: 3 19/32 (91.3)
Height: 4 13/16 (122.2)
I.Gskt: [1] Included



B7385 Lube Spin-on
Contains: 20 PSID By-Pass Valve
Replaces: CLARCOR Filtration (China)
 WB447S; FAW Xichai 1012101A020000A
Thread: 1 -12
O.D.: 4 1/4 (108.0)
Height: 4 13/32 (111.9)
I.Gskt: [1] Included



B7386 Lube Spin-on
Contains: 25 PSID By-Pass Valve
Replaces: CLARCOR Filtration (China)
 WB447SX; FAW-Xichai 1012101A020000W
Thread: 1 -12
O.D.: 4 1/4 (108.0)
Height: 4 13/32 (111.9)
I.Gskt: [1] Included



B7387 Lube Spin-on
Contains: Anti-Drainback Valve
 20 PSID By-Pass Valve
Replaces: CLARCOR Filtration (China) JX0814,
 WB7031; DCD JX4102B
Thread: 1 -12
O.D.: 3 19/32 (91.3)
Height: 6 5/8 (168.3)
I.Gskt: [1] Included



B7388 Lube Spin-on
Contains: Anti-Drainback Valve
 40 PSID By-Pass Valve
 Standpipe
Fits: Iveco Daily, Mitsubishi Trucks
Replaces: Iveco 2995655; Mitsubishi
 MK666096, MK667378
Thread: M22 x 1.5
O.D.: 3 11/16 (93.7)
Height: 5 3/8 (136.5)
A. Gskt: G381-A



B7389 Lube Spin-on
Contains: Anti-Drainback Valve
 20 PSID By-Pass Valve
Replaces: CLARCOR Filtration (China)
 WB7009; ShanDong HuaYuan Laidong Engine
 D495QB-092100
Thread: 1 -12
O.D.: 4 1/4 (108.0)
Height: 5 7/8 (149.2)
I.Gskt: [1] Included



B7390 Lube Spin-on
Contains: Anti-Drainback Valve
 18-20 PSID By-Pass Valve
Replaces: Faw-Xichai 1118105-051-0000;
 CLARCOR Filtration (China) WB178A
Thread: M20 x 1.5
O.D.: 3 3/32 (78.6)
Height: 4 27/32 (123.0)
I.Gskt: [1] Included



Measurements Are Shown In Inches And (Millimeters)

WARNING: These products can expose you to chemicals, including Diisononyl Phthalate, Carbon black extracts, Nickel, 1,3 Butadiene, Ethylene Oxide, Epichlorohydrin, which are known to the State of California to cause cancer, and Bisphenol, Ethylene Glycol, Ethylene Oxide, 1,3 Butadiene, Epichlorohydrin, which are known to the State of California to cause birth defects or other reproductive harm. For more information go to www.P65Warnings.ca.gov.

B7392

Lube Spin-on



Contains: Anti-Drainback Valve
30-41 PSID By-Pass Valve
Replaces: CLARCOR Filtration (China)
JX0818B; Foton Lovol 392000001
Thread: 1 -12
O.D.: 3 19/32 (91.3)
Height: 8 1/8 (206.4)
I.Gskt: [1] Included

P7398

Lube Element



Contains: [1] Plastic Drain Plug
Fits: Lexus, Toyota Automotive, Light-Duty Trucks
Replaces: Toyota 4152-31090
O.D.: 2 3/4 (69.9)
I.D.: 1 3/32 (27.8)
Height: 2 5/8 (66.7)
O-Ring: [2] Included

B7393

Lube Spin-on



Contains: Anti-Drainback Valve
20 PSID By-Pass Valve
Replaces: CLARCOR Filtration (China)
JX1012A; DCD (DongFeng Chaoyang Diesel)
4102AZL.14.40
Thread: M30 x 1.5
O.D.: 4 9/32 (108.7)
Height: 6 1/4 (158.8)
I.Gskt: [1] Included

P7399

Lube Element



Fits: Audi, Volkswagen Automotive
Replaces: Volkswagen 6D115466, 6D115562
O.D.: 2 1/2 (63.5)
I.D.: 1 7/32 (31.0)
Height: 4 15/16 (125.4)
F. Gskt: [1] Included

BC7394

Centrifugal by-Pass Lube Element



Fits: International Engines, Trucks
Replaces: International 1842825C91;
Donaldson P552231
O.D.: 3 27/32 (97.6)
I.D.: 3/8 (9.9) & 1/2 (12.7)
Height: 7 (177.8)
F. Gskt: [1] Included
O-Ring: [1] Included

P7400

Lube Element



Fits: Hyundai, Kia Automotive,
Light-Duty Trucks
Replaces: Hyundai 26320-3C100
O.D.: 2 7/8 (73.0)
I.D.: 1 3/8 (34.9)
Height: 5 3/32 (129.4)
A. Gskt: [2] Attached
O-Ring: [2] Included

B7395

Maximum Performance Glass Lube Spin-on



Fits: Quincy Compressors
Replaces: Quincy 128381050
Thread: 31/32 -20
O.D.: 3 21/32 (92.9)
Height: 5 3/8 (136.5)
A. Gskt: G381-A

B7401

Lube Spin-on



Contains: Anti-Drainback Valve
14 PSID By-Pass Valve
Fits: Chrysler, Dodge, Jeep Automotive,
Light-Duty Trucks
Replaces: Chrysler 4884900AB
Thread: M22 x 1.5
O.D.: 3 1/32 (77.0)
Height: 2 25/32 (70.6)
I.Gskt: [1] Included

B7396

Lube Spin-on



Notes: Can be used with OB1368, OB1369 bases.
Contains: Integral Post Seal
Fits: Aksa, Belaz, Cummins, Demag, Euclid,
Hitachi, Komatsu, Manitowoc, Unit Rig,
WABCO Equipment
Replaces: Cummins 3307885, 3310169,
3313282; Komatsu CU3307885, VS7692;
Liebherr 7369715; Renault 5000822872
Thread: 1 1/2 -12
O.D.: 4 11/16 (119.1)
Height: 11 9/32 (286.5)
I.Gskt: [1] Included

B7402

Lube Spin-on



Fits: Freightliner, Kenworth, Peterbilt Trucks
all with Caterpillar C11, C13, C18 Engines
Replaces: Caterpillar 249-2347
Thread: 1 1/2 -16
O.D.: 5 3/8 (136.5)
Height: 8 19/32 (218.3)
I.Gskt: [1] Included

B7397

Lube Spin-on



Fits: Case-International Tractors
Replaces: Case 87300047;
Fleetguard LF3593
Thread: 1 1/8 -16
O.D.: 4 1/4 (108.0)
Height: 7 3/8 (187.3)
I.Gskt: [1] Included

B7403

Lube Spin-on



Contains: Anti-Drainback Valve
20 PSID By-Pass Valve
Fits: Case, New Holland Wheel Loaders
Replaces: Case 285451A1;
Perkins 2654412
Thread: 3/4 -16
O.D.: 3 11/16 (93.7)
Height: 4 3/8 (111.1)
I.Gskt: G381-A

Measurements Are Shown In Inches And (Millimeters)

WARNING: These products can expose you to chemicals, including Diisononyl Phthalate, Carbon black extracts, Nickel, 1,3 Butadiene, Ethylene Oxide, Epichlorohydrin, which are known to the State of California to cause cancer, and Bisphenol, Ethylene Glycol, Ethylene Oxide, 1,3 Butadiene, Epichlorohydrin, which are known to the State of California to cause birth defects or other reproductive harm. For more information go to www.P65Warnings.ca.gov.

P7406



Lube Element

Contains: [1] Plastic Drain Tube
Fits: Toyota Light-Duty Trucks
Replaces: Toyota 4152-YZZA4
O.D.: 2 11/16 (68.3)
I.D.: 1 1/8 (28.6)
Height: 4 5/8 (117.5)
O-Ring: [2] Included

P7413



Lube Element

Fits: Jeep, Mercedes-Benz Light-Duty Trucks, Dodge, Mercedes-Benz Sprinter Vans
Replaces: Chrysler 5175571AA; Mercedes-Benz A6421800009; Fleetguard LF16231
O.D.: 2 13/16 (71.4)
I.D.: 1 7/32 (31.0)
Height: 3 3/4 (95.3)
O-Ring: [2] Included

B7407



Lube Spin-on

Contains: Anti-Drainback Valve
 20 PSID By-Pass Valve
Fits: Hitachi, John Deere Excavators
Replaces: Hitachi 4454526
Thread: M20 x 1.5
O.D.: 3 1/32 (77.0)
Height: 2 25/32 (70.6)
I.Gskt: [1] Included

P7414



Lube Element

Contains: [1] Circular Band Seal
Fits: Audi Automotive
Replaces: Audi 6E115562A; Wix 57204
O.D.: 2 9/16 (65.1)
I.D.: 1 1/4 (31.8)
Height: 6 3/32 (154.8)
I.Gskt: [2] Included
O-Ring: [1] Included

P7408



Lube Element

Fits: 2002-06 Mini Cooper, Cooper S
Replaces: BMW 11427509208, 11427512466
O.D.: 2 13/16 (71.4)
I.D.: 23/32 (18.3) & 1 3/32 (27.8)
Height: 3 3/16 (81.0)
A. Gskt: [2] Attached
O-Ring: [1] Included

P7415



Lube Element

Fits: Audi, Volkswagen Automotive, Light-Duty Trucks
Replaces: Volkswagen 71115562, 71115562A, 71115562B; ACDelco PF1708
O.D.: 2 25/32 (70.6)
I.D.: 5/8 (15.9) One End
Height: 5 9/16 (141.3)
O-Ring: [1] Attached

B7409



By-Pass Lube Spin-on

Fits: Mack MP7, MP8, MP10 Engines, Trucks
Replaces: Mack 20843764; Volvo 20843764
Thread: 1 3/8 -16
O.D.: 4 1/4 (108.0)
Height: 10 1/16 (255.6)
I.Gskt: [1] Included

B7416



Lube Spin-on

Contains: 14 PSID By-Pass Valve
Fits: Case Excavators
Replaces: Case 87327673; Isuzu 1-87610-006-1
Thread: 1 1/2 -12
O.D.: 4 21/32 (118.3)
Height: 8 3/32 (205.6)
I.Gskt: G498-D

B7410



Lube Spin-on

Contains: 40 PSID By-Pass Valve
Fits: Case Compactors; Deutz Engines
Replaces: Case ND103597; Deutz 1182236
Thread: 3/4 -16
O.D.: 3 1/32 (77.0)
Height: 2 5/16 (58.7)
I.Gskt: G449-B

P7417



Lube Element

Fits: Volvo Automotive
Replaces: Volvo 8642570
O.D.: 2 1/2 (63.5)
I.D.: 1 7/32 (31.0)
Height: 4 15/16 (125.4)
O-Ring: [1] Included

P7411



Lube Element

Fits: 2003-04 Cadillac CTS with V6-197 (3.2L) Engine
Replaces: GMC 24415388, 88894390
O.D.: 2 1/16 (52.4)
I.D.: 23/32 (18.3) One End
Height: 4 (101.6)
A. Gskt: [1] Attached
O-Ring: [2] Included

P7418









Lube Element

Contains: [1] Plastic Drain Plug
Fits: Lexus Automotive
Replaces: Toyota 4152-31060, 4152-YZZA5
O.D.: 2 3/4 (69.9)
I.D.: 1 3/32 (27.8)
Height: 3 7/32 (81.8)
O-Ring: [2] Included

Measurements Are Shown In Inches And (Millimeters)

! **WARNING:** These products can expose you to chemicals, including Diisononyl Phthalate, Carbon black extracts, Nickel, 1,3 Butadiene, Ethylene Oxide, Epichlorohydrin, which are known to the State of California to cause cancer, and Bisphenol, Ethylene Glycol, Ethylene Oxide, 1,3 Butadiene, Epichlorohydrin, which are known to the State of California to cause birth defects or other reproductive harm. For more information go to www.P65Warnings.ca.gov.

<p>B7419 Lube Spin-on Contains: Anti-Drainback Valve 20 PSID By-Pass Valve Fits: Suzuki ATVs, Motorcycles Replaces: Suzuki 16510-03G00, 16510-06B01 Thread: M20 x 1.0 O.D.: 2 21/32 (67.5) Height: 2 5/8 (66.7) I.Gskt: [1] Included</p> 	<p>P7427 Lube Element Fits: BMW Automotive Replaces: BMW 11427506677, 11427511161 O.D.: 2 7/8 (73.0) I.D.: 3/8 (9.5) & 1 1/4 (31.8) Height: 4 3/32 (104.0) A. Gskt: [1] Attached F. Gskt: [1] Metal Washer O-Ring: [2] Included</p> 
<p>B7420 Lube Spin-on Contains: Anti-Drainback Valve Fits: Komatsu Excavators Replaces: Komatsu 6732-51-5141, 6732-51-5142; Fleetguard LF3915 Thread: 1 -16 O.D.: 3 11/16 (93.7) Height: 5 3/8 (136.5) I.Gskt: G381-A</p> 	<p>B7428 Lube Spin-on Contains: Anti-Drainback Valve 25 PSID By-Pass Valve Fits: Citroen, Fiat, Peugeot Automotive Replaces: Peugeot 1109R0, 1109R1, 1109T0 Thread: M20 x 1.5 O.D.: 3 1/8 (79.4) Height: 3 17/32 (89.7) I.Gskt: [1] Included</p> 
<p>B7422 Lube Spin-on Contains: Anti-Drainback Valve 20 PSID By-Pass Valve Fits: General Motors, Suzuki Automotive Replaces: General Motors 12640445; Suzuki 16510-78J01 Thread: M22 x 1.5 O.D.: 3 (76.2) Height: 3 1/2 (88.9) I.Gskt: G449-B</p> 	<p>B7429 Lube Spin-on Contains: Anti-Drainback Valve 17 PSID By-Pass Valve Replaces: Fiat 46808398, 71736159; Wix Europe WL7083 Thread: M20 x 1.5 O.D.: 3 1/8 (79.4) Height: 2 7/8 (73.0) I.Gskt: [1] Included</p> 
<p>P7423 Lube Element Fits: International City Star Trucks; Workhorse Chassis all with IHC MaxxForce 5 (4.5L), VT275 (4.5L) Engines Replaces: International 1847174-C91 O.D.: 3 5/16 (84.9) I.D.: 1 9/16 (39.7) One End Height: 5 15/16 (150.8) O-Ring: [1] Included</p> 	<p>B7430 Lube Spin-on Contains: Anti-Drainback Valve 14 PSID By-Pass Valve Replaces: Fiat 5984044, 71736157; Wix Europe WL7091 Thread: M20 x 1.5 O.D.: 3 1/8 (79.4) Height: 4 1/32 (102.4) I.Gskt: [1] Included</p> 
<p>B7424 Lube Spin-on Contains: Anti-Drainback Valve 20 PSID By-Pass Valve Fits: Jaguar Automotive Replaces: Jaguar EAC1467 Thread: 1 -12 O.D.: 3 11/16 (93.7) Height: 4 7/16 (112.7) I.Gskt: G401</p> 	<p>B7431 Lube Spin-on Contains: Anti-Drainback Valve 16 PSID By-Pass Valve Fits: Nissan European Light-Duty Trucks Replaces: Nissan 15208-BN30A, 15208-BN300 Thread: 3/4 -16 O.D.: 3 3/4 (95.3) Height: 3 13/16 (96.8) I.Gskt: [1] Included</p> 
<p>P7426 Lube Element Fits: BMW Automotive Replaces: BMW 11421432097, 11421743398, 11421216192 O.D.: 2 17/32 (64.3) I.D.: 31/32 (24.6) Height: 4 1/32 (102.4) F. Gskt: [1] Copper Washer O-Ring: [3] Included</p> 	<p>B7432 Lube Spin-on Contains: Anti-Drainback Valve 18 PSID By-Pass Valve Fits: Renault Master I European Light-Duty Trucks Replaces: Renault 8200007832 Thread: M20 x 1.5 O.D.: 3 9/16 (90.5) Height: 3 15/32 (88.1) I.Gskt: [1] Included</p> 
	<p>B7433 Lube Spin-on Contains: Anti-Drainback Valve 14 PSID By-Pass Valve Replaces: Fiat 46805831, 71736160 Thread: 3/4 -16 O.D.: 3 1/8 (79.4) Height: 4 1/32 (102.4) I.Gskt: [1] Included</p> 

Measurements Are Shown In Inches And (Millimeters)

WARNING: These products can expose you to chemicals, including Diisononyl Phthalate, Carbon black extracts, Nickel, 1,3 Butadiene, Ethylene Oxide, Epichlorohydrin, which are known to the State of California to cause cancer, and Bisphenol, Ethylene Glycol, Ethylene Oxide, 1,3 Butadiene, Epichlorohydrin, which are known to the State of California to cause birth defects or other reproductive harm. For more information go to www.P65Warnings.ca.gov.

<p>B7434</p> 	<p>Chrome Lube Spin-on Contains: 17 PSID By-Pass Valve Fits: Harley-Davidson Motorcycles Replaces: Harley-Davidson 6379677A Thread: 3/4 -16 O.D.: 3 1/8 (79.4) Height: 3 21/32 (92.9) I.Gskt: [1] Included</p>	<p>P7442</p>  <p>Lube Element Fits: Chevrolet, Pontiac, Saturn Automotive Replaces: GM 12605566; ACDelco PF457G O.D.: 2 7/16 (61.9) I.D.: 1 3/8 (34.9) One End Height: 3 5/8 (92.1) I.Gskt: [1] Included O-Ring: [1] Included</p>
<p>B7435</p> 	<p>By-Pass Lube Spin-on Contains: Stud Thread: M16 x 1.5 Replaces: Fleetguard LF3882 O.D.: 5 1/16 (128.6) Height: 6 31/32 (177.0) F. Gskt: G372</p>	<p>B7443</p>  <p>Lube Spin-on Contains: Anti-Drainback Valve 8 PSID By-Pass Valve Fits: Chrysler, Dodge, Jeep Automotive Replaces: Chrysler 4892339AA; Mopar MO-339 Thread: M22 x 1.5 O.D.: 3 (76.2) Height: 3 1/2 (88.9) I.Gskt: G449-B</p>
<p>P7436</p> 	<p>Lube Element with Lid Fits: Ford, IHC Trucks and Buses Replaces: Wix 57312 O.D.: 3 1/4 (82.6) Lid 4 1/8 (104.8) I.D.: 1 1/2 (38.1) One End Height: 7 11/16 (195.3) Grommets: [1] Attached Related To: P7235 (without Lid)</p>	<p>B7444</p>  <p>Lube Spin-on Contains: Anti-Drainback Valve 8 PSID By-Pass Valve Fits: Dodge, Jeep, Mitsubishi Light-Duty Trucks Replaces: Chrysler 5184231AA; Mopar MO231 Thread: M22 x 1.5 O.D.: 3 (76.2) Height: 4 27/32 (123.0) I.Gskt: G449-B</p>
<p>P7437</p> 	<p>Lube Element with Lid Fits: Ford E-Services Vans with 6.0L Diesel Engine Replaces: Wix 57313, 57323 O.D.: 3 1/4 (82.6) Lid 4 1/8 (104.8) I.D.: 1 1/2 (38.1) One End Height: 7 17/32 (191.3) Grommets: [1] Attached Related To: P7235 (without Lid)</p>	<p>B7445</p>  <p>Lube Spin-on Contains: Anti-Drainback Valve 17 PSID By-Pass Valve Fits: Antonio Carraro Equipment Replaces: Fiat 71736158, 46805832; Mann & Hummel W714/4 Thread: M20 x 1.5 O.D.: 3 1/8 (79.4) Height: 3 5/8 (92.1) I.Gskt: [1] Included</p>
<p>P7438</p> 	<p>Lube Element Fits: BMW Automotive Replaces: BMW 11427566327 O.D.: 2 7/8 (73.0) I.D.: 1 5/8 (41.3) Height: 3 1/8 (79.4) F. Gskt: [1] Metal Washer O-Ring: [2] Included</p>	<p>B7446</p>  <p>Lube Spin-on Replaces: Hyster 1350036; Donaldson P550047 Thread: M18 x 1.5 O.D.: 2 29/32 (73.8) Height: 3 1/2 (88.9) I.Gskt: G449-B</p>
<p>B7440</p> 	<p>Lube Spin-on Contains: Anti-Drainback Valve Fits: Komatsu Equipment Replaces: Komatsu 6733-51-5142 Thread: 1 -16 O.D.: 3 11/16 (93.7) Height: 5 3/8 (136.5) I.Gskt: G381-A</p>	<p>B7449</p>  <p>Lube Spin-on Contains: Anti-Drainback Valve 20 PSID By-Pass Valve Fits: Buick, Cadillac, Chevrolet, Ford, GMC, Lincoln, Mazda, Mercury Automotive, Light-Duty Trucks Replaces: Ford AA5Z-6714-A; Mazda Z2C4-23-802 Thread: M22 x 1.5 O.D.: 3 (76.2) Height: 4 3/32 (104.0) I.Gskt: G449-B</p>
<p>B7441</p> 	<p>Lube Spin-on Contains: Anti-Drainback Valve 14 PSID By-Pass Valve Replaces: Fiat 46544820, 71736161; Wix Europe WL7134 Thread: M20 x 1.5 O.D.: 2 23/32 (69.1) Height: 3 13/32 (86.5) I.Gskt: [1] Included</p>	

Measurements Are Shown In Inches And (Millimeters)

! **WARNING:** These products can expose you to chemicals, including Diisononyl Phthalate, Carbon black extracts, Nickel, 1,3 Butadiene, Ethylene Oxide, Epichlorohydrin, which are known to the State of California to cause cancer, and Bisphenol, Ethylene Glycol, Ethylene Oxide, 1,3 Butadiene, Epichlorohydrin, which are known to the State of California to cause birth defects or other reproductive harm. For more information go to www.P65Warnings.ca.gov.

P7450

Lube Element



Fits: Mini Cooper Automotive
Replaces: BMW 11427557012
O.D.: 2 9/16 (65.1)
I.D.: 1 3/32 (27.8)
Height: 2 23/32 (69.1)
F. Gskt: [1] Brass Washer
O-Ring: [1] Included

BC7456 KIT

Paper Insert



Fits: Mack Trucks
Replaces: Spinner II 73165, 73187
O-Ring: [2] Included

B7451

Lube Spin-on



Contains: 20 PSID By-Pass Valve
Integral Post Seal
Fits: Foton FT404, FT504, Taishan TS554 Tractors
Replaces: CLARCOR Filtration (China) CX85100C, JX85100C, WB202C
Thread: M24 x 2.0
O.D.: 3 21/32 (92.9)
Height: 5 1/8 (130.2)
I.Gskt: [1] Included

B7457

Lube Spin-on



Contains: Anti-Drainback Valve
21-28 PSID By-Pass Valve
Replaces: CLARCOR Filtration (China) WB202D; FAW-Xichai 1012010/4K
Thread: 1 -12
O.D.: 3 19/32 (91.3)
Height: 5 5/8 (142.9)
I.Gskt: [1] Included

B7452

Lube Spin-on



Contains: Threaded Stud: M27 x 1.5
Front End Check Valve
35 PSID By-Pass Valve
Fits: Audi, Volkswagen Automotive
Replaces: Volkswagen 6J115403C, 6J115561B; Wix 57561
O.D.: 3 1/16 (77.8)
Height: 5 5/8 (142.9)
I.Gskt: [1] Included

B7458

Lube Spin-on



Contains: 18-20 PSID By-Pass Valve
Replaces: CLARCOR Filtration (China) WB178; Foton Lovol KM385T-09303
Thread: 3/4 -16
O.D.: 3 1/32 (77.0)
Height: 4 13/16 (122.2)
I.Gskt: [1] Included

B7453

Lube Spin-on



Contains: 20 PSID By-Pass Valve
Integral Post Seal
Fits: Kama, Taishan TS254C, TS354C Tractors
Replaces: CLARCOR Filtration (China) JX0707, WB173-S
Thread: M20 x 1.5
O.D.: 3 11/16 (93.7)
Height: 3 3/8 (85.7)
I.Gskt: [1] Included

B7459

Lube Spin-on



Contains: 30-42 PSID By-Pass Valve
Replaces: CLARCOR Filtration (China) WB218; Sinotruk VG1540070007; Weichai Power 610800070015
Thread: 1 1/8 -16
O.D.: 4 11/32 (110.3)
Height: 10 1/4 (260.4)
I.Gskt: [1] Included

P7454

Lube Element



Fits: Scion, Toyota Automotive
Replaces: Toyota 4152-YZZA6; Wix 57064
O.D.: 2 3/8 (60.3)
I.D.: 1 3/32 (27.8)
Height: 2 1/4 (57.2)
O-Ring: [1] Included

B7460

Lube Spin-on



Contains: 32-40 PSID By-Pass Valve
Replaces: FAW-Xichai 10120104000000M; Mann & Hummel W11102/16
Thread: 1 1/8 -16
O.D.: 4 9/32 (108.7)
Height: 10 7/16 (265.1)
I.Gskt: [1] Included

P7455

Lube Element



Fits: Nissan, Opel, Renault Light-Duty Trucks
Replaces: Nissan 15209-00QAA; Opel 4415941, 4506039, 93184133; Renault 7700109402, 7701472321, 8200004835
O.D.: 3 19/32 (91.3)
I.D.: 1 15/32 (37.3)
Height: 3 11/16 (93.7)
O-Ring: [1] Included

B7461

Lube Spin-on



Contains: 32-40 PSID By-Pass Valve
Replaces: FAW-Xichai 101201036D; Mann & Hummel W950/31
Thread: 1 -12
O.D.: 3 19/32 (91.3)
Height: 6 5/8 (168.3)
I.Gskt: [1] Included

Measurements Are Shown In Inches And (Millimeters)

WARNING: These products can expose you to chemicals, including Diisononyl Phthalate, Carbon black extracts, Nickel, 1,3 Butadiene, Ethylene Oxide, Epichlorohydrin, which are known to the State of California to cause cancer, and Bisphenol, Ethylene Glycol, Ethylene Oxide, 1,3 Butadiene, Epichlorohydrin, which are known to the State of California to cause birth defects or other reproductive harm. For more information go to www.P65Warnings.ca.gov.

B7462 Lube Spin-on
Contains: 21-28 PSID By-Pass Valve
Replaces: Huafeng Power WB202F; CLARCOR Filtration (China) WB202F
Thread: 1 -12
O.D.: 3 19/32 (91.3)
Height: 5 5/8 (142.9)
I.Gskt: [1] Included



B7469 Lube Spin-on
Contains: Anti-Drainback Valve
 20 PSID By-Pass Valve
Replaces: Huafeng Power JX0810; ShanDong Huayuan Laidong Engine JX0810; CLARCOR Filtration (China) JX0810
Thread: M20 x 1.5
O.D.: 3 19/32 (91.3)
Height: 5 1/8 (130.2)
I.Gskt: [1] Included



B7464 Lube Spin-on
Replaces: CLARCOR Filtration (China) JX0811A; Haufeng Power JX0811A
Thread: 1 -12
O.D.: 3 19/32 (91.3)
Height: 5 1/8 (130.2)
I.Gskt: [1] Included



B7470 Lube Spin-on
Contains: Anti-Drainback Valve
 14 PSID By-Pass Valve
Replaces: DCD (DongFeng Chaoyang Diesel) 1520843G00; CLARCOR Filtration (China) JX0811B
Thread: 3/4 -16
O.D.: 3 19/32 (91.3)
Height: 5 1/8 (130.2)
I.Gskt: [1] Included



B7465 Lube Spin-on
Contains: 21-28 PSID By-Pass Valve
Replaces: FAW-Xichai 101201029D; CLARCOR Filtration (China) WB255
Thread: 1 -12
O.D.: 3 19/32 (91.3)
Height: 5 7/16 (138.1)
I.Gskt: [1] Included



B7472 Lube Spin-on
Contains: Anti-Drainback Valve
 18-20 PSID By-Pass Valve
Replaces: Weichai Power JX0812; CLARCOR Filtration (China) JX0812
Thread: M24 x 2.0
O.D.: 3 19/32 (91.3)
Height: 5 13/16 (147.6)
I.Gskt: [1] Included



B7466 Lube Spin-on
Replaces: Huafeng Power WB218A; CLARCOR Filtration (China) WB218A
Thread: 1 1/8 -16
O.D.: 4 11/32 (110.3)
Height: 10 7/32 (259.6)
I.Gskt: [1] Included



B7473 Lube Spin-on
Contains: Anti-Drainback Valve
 11-17 PSID By-Pass Valve
Replaces: Tianjin Lovol Engines T64101001, T741010016, T741010017, T74105021; CLARCOR Filtration (China) BT2161
Thread: 3/4 -16
O.D.: 3 19/32 (91.3)
Height: 5 3/8 (136.5)
I.Gskt: [1] Included



B7467 Lube Spin-on
Contains: Anti-Drainback Valve
 8 PSID By-Pass Valve
 Standpipe
Fits: J.C. Bamford Equipment
Replaces: J.C. Bamford 2/100284, 2/100284A
Thread: 3/4 -16
O.D.: 3 11/16 (93.7)
Height: 5 3/8 (136.5)



B7474 Lube Spin-on
Contains: 20 PSID By-Pass Valve
Replaces: Yuchai Watyuan 1881012000
Thread: 1 -12
O.D.: 3 19/32 (91.3)
Height: 7 9/16 (192.1)
I.Gskt: [1] Included



B7468 Lube Spin-on
Contains: By-Pass Valve
Replaces: FAW-Xichai 1012015155YT50W; CLARCOR Filtration (China) JX1017
Thread: 1 1/8 -16
O.D.: 4 3/8 (111.1)
Height: 8 11/32 (211.9)
I.Gskt: [1] Included



B7475 Lube Spin-on
Contains: 28-30 PSID By-Pass Valve
Replaces: Yuchai Watyuan 6301012120A
Thread: 1 -12
O.D.: 3 19/32 (91.3)
Height: 8 1/8 (206.4)
I.Gskt: [1] Included



Measurements Are Shown In Inches And (Millimeters)

 **WARNING:** These products can expose you to chemicals, including Diisononyl Phthalate, Carbon black extracts, Nickel, 1,3 Butadiene, Ethylene Oxide, Epichlorohydrin, which are known to the State of California to cause cancer, and Bisphenol, Ethylene Glycol, Ethylene Oxide, 1,3 Butadiene, Epichlorohydrin, which are known to the State of California to cause birth defects or other reproductive harm. For more information go to www.P65Warnings.ca.gov.

B7476

Lube Spin-on



Contains: 18-20 PSID By-Pass Valve
Replaces: Weichai Power JX0814G;
 CLARCOR Filtration (China) JX0814G
Thread: M24 x 2.0
O.D.: 3 19/32 (91.3)
Height: 6 5/8 (168.3)
I.Gskt: [1] Included

P7484

Lube Element



Replaces: CLARCOR Filtration (China)
 J1018-1000; FAW-Xichai K1012001
O.D.: 3 15/16 (100.0)
I.D.: 1 3/4 (44.5)
Height: 7 3/16 (182.6)

B7477

Lube Spin-on



Contains: 18-20 PSID By-Pass Valve
Replaces: Weichai Power JX1010;
 CLARCOR Filtration (China) JX1010
Thread: M24 x 2.0
O.D.: 4 1/4 (108.0)
Height: 5 9/32 (134.1)
I.Gskt: [1] Included

BC7485

Centrifugal Lube Element



Fits: IHC MaxxFer 9, MaxxFer 10,
 MaxxFer 11, MaxxFer 13 Engines,
 ProStar, 4400 DuraStar, 7400 WorkStar,
 7500 WorkStar, 7600 WorkStar Trucks
Replaces: International 2606467-C91
O.D.: 3 11/16 (93.7)
I.D.: 1/4 (6.4) One End
Height: 5 13/16 (147.6)
O-Ring: [1] Included
Related To: BC7326 (Different O-Ring)

B7478

Lube Spin-on



Replaces: Foton Lovol DC238B1504;
 CLARCOR Filtration (China) B76A
Thread: 1 1/8 -16
O.D.: 4 9/32 (108.7)
Height: 7 3/32 (189.7)
I.Gskt: [1] Included

B7486

Lube Spin-on



Contains: Anti-Drainback Valve
 30 PSID By-Pass Valve
Fits: J.C. Bamford, Hitachi, John Deere,
 Kobelco, New Holland Excavators
Replaces: Isuzu 8-98075-676-0;
 J.C. Bamford 32/926119; SF-Filter SP4959
Thread: 3/4 -16
O.D.: 3 13/16 (96.8)
Height: 5 29/32 (150.0)
I.Gskt: [1] Included

B7481

Lube Spin-on



Contains: 30-42 PSID By-Pass Valve
Replaces: Yuchai Watyuan J65F11012020
Thread: 1 1/8 -16
O.D.: 4 11/32 (110.3)
Height: 8 11/32 (211.9)
I.Gskt: [1] Included

B7487

Lube Spin-on



Contains: Anti-Drainback Valve
 20 PSID By-Pass Valve
Fits: Case, Komatsu, Takeuchi, Yanmar
 Engines, Equipment
Replaces: Atlas Copco 2914920000; Isuzu
 5864015150; Komatsu YM12915035153;
 Yanmar 12915035153
Thread: M20 x 1.5
O.D.: 3 1/32 (77.0)
Height: 3 7/16 (87.3)
I.Gskt: [1] Included

B7482

Lube Spin-on



Contains: 40 PSID By-Pass Valve
Replaces: Yuchai Watyuan L30001012020,
 4301012020A; CLARCOR Filtration (China)
 JX1023-1000
Thread: 1 1/8 -16
O.D.: 4 9/32 (108.7)
Height: 10 7/16 (265.1)
I.Gskt: [1] Included

P7488

Lube Element



Fits: 2008-on Land Rover LR2; 2007-on Volvo
 S80, XC90, 2008-10 V70, 2008-on XC70,
 2009-on XC60, 2011-on S60
Replaces: Land Rover LR001419; Volvo
 3075001-3
O.D.: 3 9/32 (83.3)
I.D.: 1 11/16 (42.9)
Height: 4 1/32 (102.4)
O-Ring: [1] Included

B7483

Lube Spin-on



Contains: 30-42 PSID By-Pass Valve
Replaces: Yuchai Watyuan M30001012240A
Thread: 1 1/8 -16
O.D.: 4 9/32 (108.7)
Height: 6 7/32 (158.0)
I.Gskt: [1] Included

P7489

Lube Element



Fits: Chevrolet Aveo; Pontiac G3; Saturn Astra
Replaces: Fiat 71744410; General Motors
 93185674; Opel 5650359
O.D.: 2 1/4 (57.2)
I.D.: 5/8 (7.9) & 13/16 (20.6)
Height: 4 3/16 (106.4)
A. Gskt: [1] Included
F. Gskt: [1] Included

Measurements Are Shown In Inches And (Millimeters)

WARNING: These products can expose you to chemicals, including Diisononyl Phthalate, Carbon black extracts, Nickel, 1,3 Butadiene, Ethylene Oxide, Epichlorohydrin, which are known to the State of California to cause cancer, and Bisphenol, Ethylene Glycol, Ethylene Oxide, 1,3 Butadiene, Epichlorohydrin, which are known to the State of California to cause birth defects or other reproductive harm. For more information go to www.P65Warnings.ca.gov.

P7490

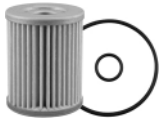

Lube Element

Contains: 30 PSID By-Pass Valve
Fits: Suzuki ATVs
Replaces: Suzuki 16510-24501, 16510-25000, 16510-25C00; Arctic Cat 3436-005
O.D.: 1 23/32 (43.7)
I.D.: 17/32 (13.5) One End
Height: 2 3/16 (55.6)
O-Ring: [2] Included

B7491



Lube Spin-on

Contains: 14 PSID By-Pass Valve
Fits: Ford, Mercury Automotive, Light-Duty Trucks
Replaces: Ford 1S7Z-6731-DA, BE8Z-6731-AB; Motorcraft EFL910, FL910, FL910S
Thread: 3/4 -16
O.D.: 3 (76.2)
Height: 3 17/32 (89.7)
I.Gskt: [1] Included

P7492



Lube Element

Fits: Chrysler, Dodge, Jeep, Ram Automotive, Light-Duty Trucks
Replaces: Chrysler 68079744AA, 68079744AB; Mopar MO744
O.D.: 2 1/16 (52.4)
I.D.: 5/8 (7.9) & 7/8 (22.2)
Height: 5 13/32 (137.3)
O-Ring: [1] Included

P7493



Lube Element

Fits: Mercedes-Benz Automotive
Replaces: Mercedes-Benz 1803109, A0001802609; Mahle OX345DECO
O.D.: 2 9/16 (65.1)
I.D.: 1 7/32 (31.0)
Height: 4 17/32 (115.1)
O-Ring: [5] Included

P7494



Lube Element

Fits: Caterpillar, IHC Trucks with MaxxForce 11, MaxxForce 13 Engines
Replaces: Caterpillar 3809364; International 3007498C92, 3007543C92, 3015784C1
O.D.: 4 23/32 (119.9)
I.D.: 1 3/4 (44.5) & 2 3/32 (52.9)
Height: 7 5/8 (193.7)
O-Ring: [1] Attached, [2] Included

P7495



Lube Element in Plastic Housing

Fits: Iveco Trucks; Case-International Steiger, New Holland Equipment
Replaces: Iveco 2996416, 500054654, 504213801; New Holland 504213800, 87495056; Hengst H311W
Element
O.D.: 4 3/32 (104.0) to 4 3/8 (111.1)
I.D.: 1 9/16 (39.7) One End
Height: 12 21/32 (321.5)
O-Ring: [1] Attached
Housing
O.D. 5 13/32 (111.9)
Thread: S125x4
Height 13 3/4 (349.3)

B7496



Lube Spin-on

Contains: Anti-Drainback Valve
 40 PSID By-Pass Valve
Fits: Iveco Trucks
Replaces: Iveco 2995811, 504091563; Fiat 8094872
Thread: M22 x 1.5
O.D.: 3 11/16 (93.7)
Height: 2 13/16 (71.4)
I.Gskt: G381-A

B7497



Lube Spin-on

Replaces: DongFeng Cummins Engine Co. 1012BF11-025; CLARCOR Filtration (China) WPPA01102
Thread: 1 1/8 -16
O.D.: 3 5/8 (92.1)
Height: 7 1/8 (181.0)
I.Gskt: [1] Included

B7499



Lube Spin-on

Contains: Anti-Drainback Valve
 30 PSID By-Pass Valve
 Standpipe
Fits: Case Loaders; Case-International Tractors
Replaces: Case 87679496; Iveco 504182581
Thread: M27 x 2.0
O.D.: 3 11/16 (93.7)
Height: 3 7/8 (98.4)
I.Gskt: G381-A

F7500



Fuel Element with Bail Handle

Fits: 750 Housings
O.D.: 7 11/16 (195.3)
I.D.: 7/8 (22.2)
Height: 15 3/32 (383.4)
O. Gskt: G155, G157, G238, G252, G309-B, ES1067, ES1068, ES1375, ES1376, ES1377
Related To: C750-E, C750-L, C750-L SINGLE (Depth-Pack or Vac-Cel By-Pass Lube Versions)

P7500

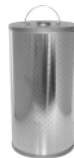

By-Pass Lube Element with Bail Handle

Fits: 750 Housings
O.D.: 7 11/16 (195.3)
I.D.: 7/8 (22.2)
Height: 15 3/32 (383.4)
O. Gskt: G155, G157, G238, G252, G309-B, ES1067, ES1068, ES1375, ES1376, ES1377
Related To: C750-E, C750-L, C750-L SINGLE (Depth-Pack or Vac-Cel By-Pass Lube Versions)

B7501



Lube Spin-on

Contains: 35 PSID By-Pass Valve
Fits: Fendt Tractors
Replaces: Agco F934201510320; Deutz 1182947; Fendt F934201510320; Mann & Hummel W1110228
Thread: 1 1/8 -16
O.D.: 4 1/4 (108.0)
Height: 10 1/16 (255.6)
I.Gskt: [1] Included

Measurements Are Shown In Inches And (Millimeters)



WARNING: These products can expose you to chemicals, including Diisononyl Phthalate, Carbon black extracts, Nickel, 1,3 Butadiene, Ethylene Oxide, Epichlorohydrin, which are known to the State of California to cause cancer, and Bisphenol, Ethylene Glycol, Ethylene Oxide, 1,3 Butadiene, Epichlorohydrin, which are known to the State of California to cause birth defects or other reproductive harm. For more information go to www.P65Warnings.ca.gov.

P7502

Lube Element



Fits: Scania Engines, Trucks
Replaces: Scania 1742037, 2022275; Fleetguard LF17486; Hengst E123HD194; Mahle OX562DECO; Mann HU10771X
O.D.: 3 9/16 (90.5)
I.D.: 1 3/4 (44.5) One End
Height: 11 1/8 (282.6)
O-Ring: [1] Included

B7507

High Efficiency Lube Spin-on



Fits: IHC MaxxForce 15 Engine, ProStar Truck
Replaces: Case-International 3014491C91
Thread: 1 1/2 -16
O.D.: 5 3/8 (136.5)
Height: 12 3/32 (307.2)
I.Gskt: [1] Included
O-Ring: [3] Included
Related To: B7299 (w/o O-Rings)

B7503

Lube Spin-on



Fits: International MaxxForce DT, MaxxForce 9, MaxxForce 10 Engines, DuraStar, WorkStar Trucks; Spartan ERV Series Fire Truck Chassis
Replaces: International Harvester 1884508-C1, 1884508-C2, 1889124-C91
Thread: 1 3/4 -12
O.D.: 4 9/16 (115.9)
Height: 11 13/32 (289.7)
I.Gskt: [1] Included

P7508

Lube Element



Fits: IHC MaxForce 11, MaxxForce 13 Engines; LoneStar, Prostar, 7600 WorkStar, 7700 WorkStar, 8600 WorkStar, 8600 TranStar Trucks
Replaces: International 3006874C91
O.D.: 4 3/4 (120.7)
I.D.: 2 (50.8) One End
Height: 8 3/32 (205.6)
A. Gskt: [1] Attached
O-Ring: [2] Included

BD7504

High Velocity Dual-Flow Lube Spin-on



Replaces: Cummins 4906635; Fleetguard LF9039
Thread: 2 1/4 -12
O.D.: 4 21/32 (118.3)
Height: 11 13/32 (289.7)
I.Gskt: [1] Included

BD7509

High Velocity Dual-Flow Lube Spin-on



Contains: Venturi-Type Cone
Fits: Equipment with Various Cummins ISM11, QSX15 Series engines
Replaces: Cummins 4906633; Fleetguard LF9031
Thread: M95 x 2.5
O.D.: 4 11/16 (119.1)
Height: 11 25/32 (299.2)
I.Gskt: [1] Included
Related To: BD7154 (Nitrile Gasket)

P7505

Lube Element



Contains: Offset By-Pass Valve
Fits: Freightliner Cascadia, Century Class S/T, Columbia, Coronado, Business Class M2, Sterling L-Line, L-Line 9500, Western Star 4900EX, 4900FA, 4900SA Trucks all with Detroit Diesel DD13, DD15 or DD16 Eng
Replaces: Detroit Diesel A4721800109, A4721800309; Mercedes-Benz A4721800309, A4721840525; Donaldson P551005
O.D.: 4 3/4 (120.7)
I.D.: 2 (50.8) One End
Height: 10 7/16 (265.1)
A. Gskt: [1] Attached
F. Gskt: [1] Copper Washer
O-Ring: [1] Included

P7510

Lube Element



Fits: Hino P11C Engine
Replaces: Hino S156072430
O.D.: 4 3/16 (106.4)
I.D.: 19/32 (15.1) & 2 (50.8)
Height: 7 3/8 (187.3)
A. Gskt: [1] Attached
F. Gskt: [1] Metal Washer
O-Ring: [3] Included
Grommets: [1] Attached

B7506

Lube Spin-on



Fits: International MaxxForce 7 Engines, DuraStar, TerraStar, TransStar Trucks
Replaces: International 1899332-C91; 1893553-C2
Thread: 1 -16
O.D.: 4 9/32 (108.7)
Height: 8 3/4 (22.3)
I.Gskt: [1] Included

B7511

Lube Spin-on



Contains: Anti-Drainback Valve
 14 PSID By-Pass Valve
Fits: Bobcat, Ingersoll-Rand Compactors
Replaces: Ingersoll-Rand 54477104
Thread: 3/4 -16
O.D.: 3 11/16 (93.7)
Height: 3 1/4 (82.6)
I.Gskt: [1] Included

P7512

Lube Element



Replaces: Hino S156072440
O.D.: 4 25/32 (121.4)
I.D.: 5/8 (15.9)
Height: 8 21/32 (219.9)
F. Gskt: [5] Included

Measurements Are Shown In Inches And (Millimeters)

WARNING: These products can expose you to chemicals, including Diisononyl Phthalate, Carbon black extracts, Nickel, 1,3 Butadiene, Ethylene Oxide, Epichlorohydrin, which are known to the State of California to cause cancer, and Bisphenol, Ethylene Glycol, Ethylene Oxide, 1,3 Butadiene, Epichlorohydrin, which are known to the State of California to cause birth defects or other reproductive harm. For more information go to www.P65Warnings.ca.gov.

B7513

Lube Spin-on



Fits: Hino Engines, Trucks
Replaces: Hino 15613E0030
Thread: 1 1/2 -16
O.D.: 4 21/32 (118.3)
Height: 8 3/32 (205.6)
I.Gskt: [1] Included

BF7528

Fuel Spin-on with Drain



Fits: Kubota, Thomas Equipment
Replaces: Kubota 70000-43170
Thread: M20 x 1.5
O.D.: 3 11/16 (93.7)
Height: 4 11/16 (119.1)
I.Gskt: G324-A

P7514

Lube Element



Fits: Caterpillar C175-16, C175-20 Gen Set
Replaces: Caterpillar 2492340, 3680066
O.D.: 7 13/32 (188.1)
I.D.: 3 13/32 (86.5)
Height: 13 21/32 (346.9)
A. Gskt: [2] Attached

BF7529

Fuel Spin-on



Contains: Integral Post Seal
Fits: Mitsubishi Trucks
Replaces: Mitsubishi ME035394
Thread: 1 -14
O.D.: 3 11/16 (93.7)
Height: 6 11/16 (169.9)
I.Gskt: G401

P7515

Lube Element



Fits: Hyundai, Kia Automotive
Replaces: Hyundai 263203CAA0;
 Kia 263203CAA0
O.D.: 2 19/32 (65.9)
I.D.: 27/32 (21.4) & 1 3/32 (27.8)
Height: 4 25/32 (121.4)
A. Gskt: [1] Included
F. Gskt: [1] Metal Washer
O-Ring: [1] Included

BF7531

Fuel Spin-on



Contains: Integral Post Seal
Fits: International Engines
Replaces: International 1820479-C1
Thread: 7/8 -14
O.D.: 3 (76.2)
Height: 5 7/8 (149.2)
I.Gskt: G449-B

P7517

Lube Element



Fits: Jeep Grand Cherokee; Ram 1500 Pickups
Replaces: Chrysler 68109834AA
O.D.: 2 19/32 (65.9)
I.D.: 3/4 (19.1) One End
Height: 4 7/8 (123.8)
O-Ring: [1] Attached, [1] Included

BF7532

Fuel/Water Separator Spin-on with Threaded Port



Notes: Inside-Out Flow Direction
Contains: Port Thread: M36 x 1.5
Fits: Nissan Trucks
Replaces: Nissan 16403-05E01,
 16403-59E00, 16405-05E01
Thread: 3/4 -16
O.D.: 3 9/16 (90.5)
Height: 5 7/16 (138.1)
I.Gskt: G381-A
F. Gskt: [1] Included

BF7519

Stainless Steel Screen In-Line Fuel Filter



Contains: [2] Rubber Seals
 [2] Brass Fittings
Fits: Case-International, John Deere Tractors
Replaces: Case A184963;
 John Deere AR103220
O.D.: 1 29/32 (48.4)
Inlet: 5/8-24
Outlet: 5/8-24
Length: 3 17/32 (89.7)

BF7534

Fuel/Water Separator Spin-on with Threaded Port



Notes: Inside-Out Flow Direction
Contains: Port Thread: M36 x 1.5
Fits: Chevrolet, Dodge, GMC, Isuzu,
 Mitsubishi Automotive, Light-Duty Trucks;
 Toro Lawn & Garden Tractors
Replaces: GMC 13240032; Isuzu
 8-94483-850-0; Mitsubishi MB228988;
 Toro 60-5470
Thread: M20 x 1.5
O.D.: 3 9/16 (90.5)
Height: 5 7/16 (138.1)
I.Gskt: G381-A
F. Gskt: [2] Included

BF7522

Fuel Element with Drain



Fits: Ford (Europe) Trucks
Replaces: Ford 6164913, 844F-9176-CAB
O.D.: 3 1/2 (88.9)
I.D.: 5/8 (15.9) One End
Height: 6 11/32 (161.1)
A. Gskt: [1] Attached

Measurements Are Shown In Inches And (Millimeters)

WARNING: These products can expose you to chemicals, including Diisononyl Phthalate, Carbon black extracts, Nickel, 1,3 Butadiene, Ethylene Oxide, Epichlorohydrin, which are known to the State of California to cause cancer, and Bisphenol, Ethylene Glycol, Ethylene Oxide, 1,3 Butadiene, Epichlorohydrin, which are known to the State of California to cause birth defects or other reproductive harm. For more information go to www.P65Warnings.ca.gov.

BF7535 Fuel/Water Separator Spin-on with Threaded Port



Notes: Inside-Out Flow Direction
Contains: Port Thread: M36 x 1.5
Fits: Nissan, Toyota Automotive; Toyota Lift Trucks
Replaces: Nissan 16403-G9900; Toyota 23303-56040
Thread: 3/4 -16
O.D.: 3 9/16 (90.5)
Height: 5 7/16 (138.1)
I.Gskt: G381-A
O-Ring: [1] Included

BF7537 Can-Type Fuel Filter



Replaces: Mazda SL07-23-570
O.D.: 3 7/16 (87.3)
I.D.: 3/4 (19.1) & 1 1/8 (28.6)
Height: 3 13/32 (86.5)
F. Gskt: [2] Included
O-Ring: [3] Included

BF7538 Fuel Spin-on



Contains: Integral Post Seal
Fits: Caterpillar Equipment
Replaces: Caterpillar 5I7951
Thread: M20 x 1.5
O.D.: 3 11/16 (93.7)
Height: 4 3/8 (111.1)
I.Gskt: G324-A

BF7541 Fuel Spin-on



Fits: Kobelco, MDI/Yutani Equipment
Replaces: Kobelco 2451U309-2
Thread: 3/4 -16
O.D.: 3 11/16 (93.7)
Height: 3 1/4 (82.6)
I.Gskt: G324-A

BF7544 Fuel Spin-on



Fits: Hino Engines; Kobelco Loaders
Replaces: Hino 23401-1381
Thread: M20 x 1.5
O.D.: 3 1/32 (77.0)
Height: 4 3/32 (104.0)
I.Gskt: [1] Included

PF7545 Fuel Element



Fits: Bolens, Case, Ford, International, New Holland, White Tractors
Replaces: Bolens 1876440; Ford SBA360720020; International 1273082-C1
O.D.: 1 1/8 (28.6)
I.D.: 17/32 (13.5) One End
Height: 2 9/32 (57.9)

BF7546 Fuel/Water Separator Spin-on with Drain



Notes: CAUTION: Furnished D-Ring must be installed on threaded bushing before installing filter on D60E-7, D65E-7 and D75S-3 machines with NH220 or NT855 engines. Do NOT use on other Komatsu engines.
Contains: Integral Post Seal
Fits: Hitachi, Komatsu Equipment
Replaces: Hitachi 4192631; Komatsu 600-311-8292
Thread: 1 -14
O.D.: 3 11/16 (93.7)
Height: 6 31/32 (177.0)
I.Gskt: G401
F. Gskt: ES24-D

PF7549 Fuel Element



Fits: Isuzu Engines
Replaces: Isuzu 5-87810-197-0
O.D.: 1 11/16 (42.9)
I.D.: 15/32 (11.9)
Height: 1 25/32 (45.2)
F. Gskt: [3] Included

PF7550 Fuel Element



Fits: Hino Buses, Trucks
Replaces: Hino 23401-1060
O.D.: 2 15/32 (62.7)
I.D.: 13/32 (10.3)
Height: 2 17/32 (64.3)
F. Gskt: [2] Included
Grommets: [2] Attached

PF7551 Fuel Element



Fits: Hino Equipment, Trucks; Hitachi Equipment
Replaces: Hino 23401-1040; Hitachi 4020429
O.D.: 2 7/8 (73.0)
I.D.: 17/32 (13.5) & 19/32 (15.1)
Height: 4 7/32 (107.2)
F. Gskt: ES1049, [1] Included
End Seals: [1] Attached
Grommets: [1] Attached

BF7552 Fuel Spin-on



Contains: Integral Post Seal
Fits: Caterpillar, Daewoo, Komatsu, Takeuchi, Yanmar Equipment; Mitsubishi Engines
Replaces: Caterpillar 94-7073; Mitsubishi ME006066
Thread: M20 x 1.5
O.D.: 3 11/16 (93.7)
Height: 2 27/32 (72.2)
A. Gskt: [1] Included

PF7553 Fuel Element



Fits: Nissan Trucks
Replaces: Nissan 16444-99026, 16444-99028
O.D.: 4 3/8 (111.1)
I.D.: 9/16 (14.3) & 1 (25.4)
Height: 5 1/2 (139.7)
I.Gskt: [2] Included
F. Gskt: [1] Included, [1] Washer

Measurements Are Shown In Inches And (Millimeters)

WARNING: These products can expose you to chemicals, including Diisononyl Phthalate, Carbon black extracts, Nickel, 1,3 Butadiene, Ethylene Oxide, Epichlorohydrin, which are known to the State of California to cause cancer, and Bisphenol, Ethylene Glycol, Ethylene Oxide, 1,3 Butadiene, Epichlorohydrin, which are known to the State of California to cause birth defects or other reproductive harm. For more information go to www.P65Warnings.ca.gov.

PF7554



Fuel Element

Fits: Nissan Trucks
Replaces: Nissan 16444-90027, 16444-99128
O.D.: 3 19/32 (91.3)
I.D.: 9/16 (14.3)
Height: 5 19/32 (142.1)
F. Gskt: [1] Included

PF7572

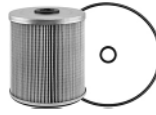

Fuel Element

Contains: Reinforced Centertube
Fits: Hino Tractors, Trucks; Hitachi Equipment
Replaces: Hino 23401-1020; Hitachi 4143271
O.D.: 3 15/16 (100.0)
I.D.: 19/32 (15.1) & 21/32 (16.7)
Height: 4 7/32 (107.2)
F. Gskt: [2] Included
End Seals: [1] Attached
Grommets: [1] Attached

PF7556



Fuel Element

Replaces: Nissan 16444-Z9027
O.D.: 3 19/32 (91.3)
I.D.: 9/16 (14.3)
Height: 6 5/8 (168.3)
F. Gskt: [1] Included
Grommets: [1] Included

BF7576



Box-Style Fuel Coalescer

Fits: Thermo King Refrigeration Units
Replaces: Thermo King 11-6286
Length: 4 21/32 (118.3)
Width: 2 27/32 (72.2)
Height: 2 15/32 (62.7)

BF7557



Extended Life Fuel Spin-on

Notes: CAUTION: Furnished D-Ring must be installed on post for seal. Can be used with FB1311 base.
Fits: Allis Chalmers, Taylor, Versatile Equipment; Cummins Engines
Replaces: Cummins 3300901
Thread: 1 -14
O.D.: 3 11/16 (93.7)
Height: 7 1/8 (181.0)
I.Gskt: G381-A
F. Gskt: ES24-D
Related To: BF948, BF957 (Short, Standard Versions)
 BF7558 (Long Version)

B7577



By-Pass Lube Spin-on

Notes: Can be used with OB1308 base.
Fits: Caterpillar, Cummins, GMC Engines
Replaces: Caterpillar 9Y4468; Cummins 3304232; Ford E3HZ-6731-A; GMC 25011187
Thread: 1 3/8 -16
O.D.: 4 11/16 (119.1)
Height: 9 15/16 (252.4)
I.Gskt: G498-D

BF7558



Extended Life Fuel Spin-on

Notes: CAUTION: Furnished D-Ring must be installed on post for seal. Can be used with FB1311 base.
Thread: 1 -14
O.D.: 3 11/16 (93.7)
Height: 8 23/32 (221.5)
I.Gskt: G381-A
F. Gskt: ES24-D
Related To: BF948, BF957 (Short, Standard Versions)
 BF7557 (Short Version)

BF7579



Box-Style Fuel Filter

Fits: Thermo King Refrigeration Units
Replaces: Thermo King 11-6285
Length: 4 21/32 (118.3)
Width: 2 27/32 (72.2)
Height: 2 15/32 (62.7)

BF7559



Fuel Spin-on

Fits: Isuzu Engines
Replaces: Isuzu X13240-024
Thread: 3/4 -16
O.D.: 3 11/16 (93.7)
Height: 4 3/8 (111.1)
I.Gskt: G381-A

PF7583



Fuel Element

Fits: Mitsubishi Equipment, Trucks
Replaces: Mitsubishi 47302-00291
O.D.: 3 19/32 (91.3)
I.D.: 9/16 (14.3)
Height: 5 9/16 (141.3)
F. Gskt: [2] Included
Grommets: [2] Attached

BF7571



Fuel Spin-on

Fits: Fuel Dispensing Pumps
Replaces: Cim-Tek 700-19, 800-10
Thread: 1 1/2 -16
O.D.: 5 1/16 (128.6)
Height: 10 3/4 (273.1)
F. Gskt: G369-B
O. Gskt: G286-C, G369-V, G372, G447, G483, G704, G710

BF7584



Fuel/Water Separator Spin-on with Drain

Contains: Integral Post Seal
Fits: International Engines
Replaces: International 1808623-C1
Thread: 7/8 -14
O.D.: 4 1/4 (108.0)
Height: 8 17/32 (216.7)
I.Gskt: G401
Related To: BF7629 (Fuel Version without Drain)

Measurements Are Shown In Inches And (Millimeters)

WARNING: These products can expose you to chemicals, including Diisononyl Phthalate, Carbon black extracts, Nickel, 1,3 Butadiene, Ethylene Oxide, Epichlorohydrin, which are known to the State of California to cause cancer, and Bisphenol, Ethylene Glycol, Ethylene Oxide, 1,3 Butadiene, Epichlorohydrin, which are known to the State of California to cause birth defects or other reproductive harm. For more information go to www.P65Warnings.ca.gov.

B7585 Lube Spin-on
Contains: Anti-Drainback Valve
 14 PSID By-Pass Valve
Fits: Isuzu Engines
Replaces: Isuzu 8-97024-607-0, 8-97024-607-1
Thread: M20 x 1.5
O.D.: 4 1/4 (108.0)
Height: 5 27/32 (148.4)
I.Gskt: [1] Included
F. Gskt: [2] Included



BF7593 Fuel Spin-on
Contains: Integral Post Seal
Fits: Iveco Buses, Trucks
Replaces: Iveco 1901607
Thread: 3/4 -16
O.D.: 4 1/4 (108.0)
Height: 3 15/16 (100.0)
I.Gskt: G381-A



BF7586 Fuel Storage Tank Spin-on
Contains: Water Absorbent Media
Fits: Various Fuel Islands
Replaces: Cim-Tek 400HS-10, 700-17
Thread: 1 1/2 -16
O.D.: 3 11/16 (93.7)
Height: 5 9/16 (141.3)
I.Gskt: [1] Included



PF7594 Fuel Element
Fits: Belarus Tractors
Replaces: Belarus A6501100-10
O.D.: 3 23/32 (94.5)
I.D.: 13/32 (10.3) One End
Height: 4 3/4 (120.7)
Grommets: [1] Attached



BF7587 High Efficiency Fuel Spin-on
Fits: Caterpillar Engines, Equipment; Ford, Freightliner, International, Kenworth, Peterbilt, Sterling, Western Star Trucks
Replaces: Caterpillar 1R0749, 3089679
Thread: 1 -14
O.D.: 3 11/16 (93.7)
Height: 10 1/2 (266.7)
I.Gskt: G381-A
Related To: BF614 (Standard Version)
 BF7633 (Short Version)



PF7595 Fuel Element
Fits: Belarus Tractors
Replaces: Belarus 501117030A
O.D.: 2 1/16 (52.4)
I.D.: 13/32 (10.3)
Height: 4 7/8 (123.8)
Grommets: [2] Attached



PF7588 Fuel Element
Fits: Hitachi, Komatsu Equipment
Replaces: Hitachi 4091472; Komatsu 600-311-8210
O.D.: 2 7/8 (73.0)
I.D.: 9/16 (14.3)
Height: 4 11/32 (110.3)
A. Gskt: [2] Attached
F. Gskt: [2] Included



PF7596 Fuel Element
Fits: Iveco, M.A.N., R.V.I. Buses, Trucks; Perkins Engines
Replaces: M.A.N. A50.00241.676; Renault 854975700
O.D.: 2 9/16 (65.1)
I.D.: 9/16 (14.3)
Height: 2 3/32 (53.2)
F. Gskt: [1] Included



BF7591-D Fuel/Water Separator Spin-on with Drain
Fits: Case, Hanomag, International Equipment
Replaces: Hanomag 114924144; International 1967094-C1
Thread: M16 x 1.5
O.D.: 3 1/32 (77.0)
Height: 6 1/8 (155.6)
A. Gskt: G449-B



PF7597 Fuel/Water Separator Element
Fits: Luber-finer F170 Housings
Replaces: Luber-finer 4666
O.D.: 4 1/2 (114.3)
I.D.: 7/8 (22.2)
Height: 8 3/16 (208.0)
A. Gskt: [2] Attached
F. Gskt: [1] Included



PF7592 Fuel Element
Fits: Mitsubishi Equipment, Trucks
Replaces: Mitsubishi 30062-65101, ME971550
O.D.: 3 19/32 (91.3)
I.D.: 9/16 (14.3)
Height: 5 3/8 (136.5)
F. Gskt: [3] Included
Grommets: [2] Attached



BF7598 Fuel Spin-on with Threaded Sensor Port
Contains: Port Thread: M10 x 1.5
Fits: Nissan Automotive, Light-Duty Trucks; Komatsu, Nissan Lift Trucks
Replaces: Komatsu 600-311-9620; Nissan 16405-34W25
Thread: 3/4 -16
O.D.: 3 5/16 (84.9)
Height: 4 5/8 (117.5)
I.Gskt: [1] Included



Measurements Are Shown In Inches And (Millimeters)

WARNING: These products can expose you to chemicals, including Diisononyl Phthalate, Carbon black extracts, Nickel, 1,3 Butadiene, Ethylene Oxide, Epichlorohydrin, which are known to the State of California to cause cancer, and Bisphenol, Ethylene Glycol, Ethylene Oxide, 1,3 Butadiene, Epichlorohydrin, which are known to the State of California to cause birth defects or other reproductive harm. For more information go to www.P65Warnings.ca.gov.

B7600

Full-Flow Lube Spin-on



Fits: Caterpillar Engines, Equipment
Replaces: Caterpillar 1R0739
Thread: 1 1/8 -16
O.D.: 4 1/4 (108.0)
Height: 10 1/16 (255.6)
I.Gskt: [1] Included
Related To: B76, B76-MPG, B76-SS (Long Versions)
 B7700 (High Efficiency Version)

B7600-SS

Severe Service Full-Flow Lube Spin-on



Fits: Caterpillar Engines, Equipment
Replaces: Caterpillar 1R0739
Thread: 1 1/8 -16
O.D.: 4 1/4 (108.0)
Height: 10 1/16 (255.6)
I.Gskt: [1] Included
Related To: B76, B76-MPG, B76-SS (Long Versions)
 B7700 (High Performance Version)

BF7602

Fuel Spin-on



Contains: Integral Post Seal
Fits: Case, Hitachi, Kawasaki, Koehring, Link-Belt Equipment; Chevrolet, GMC, Isuzu Trucks
Replaces: Hitachi 4206080; Isuzu 1-13240-079-1; Link-Belt 3H1750
Thread: 3/4 -16
O.D.: 3 11/16 (93.7)
Height: 4 3/8 (111.1)
I.Gskt: G324-A

BF7606

Fuel Spin-on



Fits: Volvo Equipment
Replaces: Volvo 795210
Thread: 1 -12
O.D.: 3 11/16 (93.7)
Height: 7 3/16 (182.6)
I.Gskt: G401

P7607

Lube Element



Fits: M.A.N. Trucks
Replaces: M.A.N. 85.48386, 81.05504.0037
O.D.: 3 7/32 (81.8)
I.D.: 1 1/16 (27.0)
Height: 5 31/32 (151.6)
A. Gskt: [2] Attached

BF7608

Fuel Spin-on



Notes: CAUTION: Furnished O-Ring must be installed on post for seal.
Fits: Ford Buses, Trucks; New Holland Equipment
Replaces: Ford E7HZ-9365-B
Thread: M16 x 1.5
O.D.: 3 1/32 (77.0)
Height: 4 3/32 (104.0)
I.Gskt: [1] Included
O-Ring: [1] Included

BF7609

Fuel Spin-on



Fits: Oil Burning Furnaces, Heaters
Replaces: Wix 24104
Thread: 1 -14
O.D.: 2 5/8 (66.7)
Height: 4 5/32 (105.6)
F. Gskt: [1] Metal Washer
O-Ring: [1] Included

BF7612

Fuel Spin-on



Contains: Integral Post Seal
Fits: Detroit Diesel Engines
Replaces: Fleetguard FF5227
Thread: 13/16 -12
O.D.: 4 1/4 (108.0)
Height: 7 5/8 (193.7)
I.Gskt: G381-A
Related To: BF7613 (Long Version)

BF7613

Fuel Spin-on



Contains: Integral Post Seal
Fits: Detroit Diesel Engines
Thread: 13/16 -12
O.D.: 4 1/4 (108.0)
Height: 10 7/16 (265.1)
I.Gskt: G381-A
Related To: BF7612 (Short Version)

BF7614

Fuel Spin-on



Notes: Inside-Out Flow Direction
Fits: Nissan Buses, Trucks
Replaces: Nissan 16403-05D00, FL403-05D00
Thread: 3/4 -16
O.D.: 3 11/16 (93.7)
Height: 5 3/8 (136.5)
I.Gskt: [1] Included
F. Gskt: [1] Included

P7615

Dual-Flow Lube Element with Bail Handle



Fits: Mercedes-Benz Automotive, Light-Duty Trucks
Replaces: Mercedes-Benz 6011800009, 6011800109, 6011800210
O.D.: 3 9/16 (90.5)
I.D.: 15/32 (11.9) & 31/32 (24.6)
Height: 6 11/16 (169.9)
F. Gskt: [3] Included
Grommets: [2] Attached

PT7616

Hydraulic Element



Fits: Caterpillar Excavators
Replaces: Caterpillar 5W5803
O.D.: 4 5/8 (117.5)
I.D.: 2 5/16 (58.7)
Height: 6 21/32 (169.1)
A. Gskt: [2] Attached

Measurements Are Shown In Inches And (Millimeters)



WARNING: These products can expose you to chemicals, including Diisononyl Phthalate, Carbon black extracts, Nickel, 1,3 Butadiene, Ethylene Oxide, Epichlorohydrin, which are known to the State of California to cause cancer, and Bisphenol, Ethylene Glycol, Ethylene Oxide, 1,3 Butadiene, Epichlorohydrin, which are known to the State of California to cause birth defects or other reproductive harm. For more information go to www.P65Warnings.ca.gov.

PT7617



Hydraulic Element

Replaces: Hyster 376066
O.D.: 4 (101.6)
I.D.: 1 1/4 (31.8) & 1 9/16 (39.7)
Height: 18 29/32 (480.2)
Grommets: [1] Attached

BF7626



In-Line Fuel Regulator Filter

Contains: [1] Hose Clamp
Fits: Dodge Light-Duty Trucks
Replaces: Chrysler 4864849
O.D.: 3 (76.2)
Inlet: 3/8
Outlet: 1/4
Height: 3 3/4 (95.3)

PF7618



Fuel Element

Fits: Isuzu, Nissan Trucks
Replaces: Nissan 16444-97001
O.D.: 4 11/32 (110.3)
I.D.: 19/32 (15.1) & 2 1/32 (51.6)
Height: 8 9/32 (210.3)
A. Gskt: [1] Attached
F. Gskt: [3] Copper Washers, [1] Gasket
O-Ring: [1] Included
Grommets: [1] Attached

PF7627



Fuel Element

Fits: Dodge Light-Duty Trucks, Vans
Replaces: Chrysler 4864307
O.D.: 5 (127.0)
I.D.: 3 9/32 (83.3) One End
Height: 1 3/4 (44.5)

BF7619



Fuel Spin-on

Contains: Integral Post Seal
Fits: Mercedes-Benz Automotive
Replaces: Mercedes-Benz 10922201, 10922301
Thread: M12 x 1.5
O.D.: 3 3/8 (85.7)
Height: 3 13/16 (96.8)
I.Gskt: [2] Included
F. Gskt: [2] Included

BF7628



Fuel Spin-on

Contains: Integral Post Seal
Fits: Carrier Refrigeration Units
Replaces: Carrier 30-01090-01
Thread: 1 -14
O.D.: 4 5/16 (109.5)
Height: 5 29/32 (150.0)
I.Gskt: [1] Included

BF7623



Fuel Storage Tank Spin-on

Fits: Fuel Dispensing Pumps
Replaces: Cim-Tek 700-20, 800-30
Thread: 1 1/2 -16
O.D.: 5 1/16 (128.6)
Height: 10 3/4 (273.1)
F. Gskt: G369-B
O. Gskt: G369-V, G704, G710

BF7629



Fuel Spin-on

Contains: Integral Post Seal
Fits: Terex Equipment; Detroit Diesel, International Engines
Replaces: International 1822588-C1
Thread: 7/8 -14
O.D.: 4 1/4 (108.0)
Height: 7 (177.8)
I.Gskt: G401
Related To: BF7584 (Fuel/Water Separator Version with Drain)

BF7624



Fuel Spin-on

Fits: Scania Trucks
Replaces: Scania 1361685, 1372444
Thread: M24 x 1.5
O.D.: 3 11/16 (93.7)
Height: 5 9/16 (141.3)
I.Gskt: G401

BF7630



In-Line Fuel Filter

Contains: [2] Nuts
 [1] Plastic Retainer Clip
Fits: Saturn Automotive
Replaces: Saturn 21007437, 21007438
O.D.: 2 5/32 (54.8)
Inlet: 3/8
Outlet: 3/8
Length: 16 15/16 (430.2)

BF7625



In-Line Fuel Filter

Contains: [2] 19/32 Inch Plastic Fittings
Fits: Toyota Light-Duty Trucks
Replaces: Toyota 23300-79535
O.D.: 2 11/32 (59.5)
Inlet: 1/4
Outlet: 1/4
Length: 2 31/32 (75.4)
F. Gskt: [2] Included

BF7631



High Efficiency Fuel Spin-on

Contains: Integral Post Seal
Fits: Caterpillar Equipment
Replaces: Caterpillar 1R0753
Thread: 7/8 -14
O.D.: 3 11/16 (93.7)
Height: 10 1/2 (266.7)
I.Gskt: G381-A

BF7632



High Efficiency Fuel Spin-on

Contains: Integral Post Seal
Fits: Caterpillar Engines, Equipment
Replaces: Caterpillar 1R0751
Thread: 7/8 -14
O.D.: 3 11/16 (93.7)
Height: 7 1/8 (181.0)
I.Gskt: G381-A

Measurements Are Shown In Inches And (Millimeters)

WARNING: These products can expose you to chemicals, including Diisononyl Phthalate, Carbon black extracts, Nickel, 1,3 Butadiene, Ethylene Oxide, Epichlorohydrin, which are known to the State of California to cause cancer, and Bisphenol, Ethylene Glycol, Ethylene Oxide, 1,3 Butadiene, Epichlorohydrin, which are known to the State of California to cause birth defects or other reproductive harm. For more information go to www.P65Warnings.ca.gov.

BF7633



High Efficiency Fuel Spin-on
Fits: Caterpillar Equipment
Replaces: Caterpillar 1R0750
Thread: 1 -14
O.D.: 3 11/16 (93.7)
Height: 7 1/8 (181.0)
I.Gskt: G381-A
Related To: BF7587 (Long Version)

BF7639-D



High Efficiency Fuel Spin-on with Drain
Contains: Integral Post Seal
Fits: Mining Applications Using Davco Mega Filter
Replaces: GMC 23512631
Thread: 1 3/8 -16
O.D.: 5 3/8 (136.5)
Height: 12 7/16 (315.9)
I.Gskt: [1] Included

BF7634



High Efficiency Fuel Spin-on
Fits: Caterpillar Engines
Replaces: Caterpillar 1R0759
Thread: 7/8 -14
O.D.: 3 (76.2)
Height: 7 1/8 (181.0)
I.Gskt: [1] Included

BF7640



Fuel Spin-on
Contains: Integral Post Seal
Fits: John Deere Equipment
Replaces: John Deere RE61552, RE501113
Thread: 13/16 -12
O.D.: 3 11/16 (93.7)
Height: 6 5/8 (168.3)
I.Gskt: [1] Included

BF7635



High Efficiency Fuel/Water Separator Spin-on with Drain
Contains: Integral Post Seal
Fits: Mining Applications in Cold Weather
Thread: 1 3/8 -16
O.D.: 5 3/8 (136.5)
Height: 10 9/16 (268.3)
I.Gskt: [1] Included

BF7641



In-Line Fuel Filter
Fits: BMW Automotive
Replaces: BMW 13321702632, 13321740985
O.D.: 2 15/32 (62.7)
Inlet: 5/16
Outlet: 5/16
Length: 11 13/16 (300.0)

B7637



Lube Spin-on
Replaces: Knecht OC246;
 Woodgate WGL3675
Thread: 1 1/8 -16
O.D.: 4 1/4 (108.0)
Height: 10 9/32 (261.1)
I.Gskt: [1] Included

BF7644



Fuel Spin-on
Contains: Integral Post Seal
Fits: Volvo Engines
Replaces: Volvo 420799
Thread: M18 x 1.5
O.D.: 3 11/16 (93.7)
Height: 8 1/8 (206.4)
I.Gskt: G381-A

BF7637



High Performance Fuel Spin-on
Fits: Caterpillar Equipment
Replaces: Caterpillar 1R0750
Thread: 1 -14
O.D.: 3 1/32 (77.0)
Height: 7 1/8 (181.0)
A. Gskt: G449-B

BF7645



Fuel Storage Tank Spin-on
Fits: Fuel Tanks
Replaces: Cim-Tek 400-10, 700-15
Thread: 1 1/2 -16
O.D.: 3 3/4 (95.3)
Height: 5 9/16 (141.3)
I.Gskt: [1] Included

BF7639



High Efficiency Fuel Spin-on
Contains: Integral Post Seal
Fits: Caterpillar Equipment, Industrial and Marine Engines
Replaces: Caterpillar 1R0755
Thread: 1 3/8 -16
O.D.: 5 3/8 (136.5)
Height: 12 3/32 (307.2)
I.Gskt: [1] Included

BF7648



Fuel Spin-on
Fits: GMC, Isuzu Trucks; Komatsu, Link-Belt Equipment
Replaces: GMC 97718401;
 Isuzu 5-87310-335-0
Thread: 3/4 -16
O.D.: 3 1/32 (77.0)
Height: 3 1/2 (88.9)
I.Gskt: [1] Included

Measurements Are Shown In Inches And (Millimeters)

WARNING: These products can expose you to chemicals, including Diisononyl Phthalate, Carbon black extracts, Nickel, 1,3 Butadiene, Ethylene Oxide, Epichlorohydrin, which are known to the State of California to cause cancer, and Bisphenol, Ethylene Glycol, Ethylene Oxide, 1,3 Butadiene, Epichlorohydrin, which are known to the State of California to cause birth defects or other reproductive harm. For more information go to www.P65Warnings.ca.gov.

BF7653

Fuel Spin-on



Contains: Integral Post Seal
Fits: Volvo, WhiteGMC Trucks
Replaces: Volvo 8193841
Thread: M18 x 1.5
O.D.: 3 11/16 (93.7)
Height: 8 1/8 (206.4)
I.Gskt: G381-A

BF7661

In-Line Fuel Filter



Fits: Lexus, Toyota Automotive
Replaces: Toyota 23300-20040
O.D.: 2 9/16 (65.1)
Inlet: M14 x 1.5
Outlet: 5/16
Length: 4 3/16 (106.4)

PF7655

Fuel Element



Contains: Reinforced Centertube
Fits: Caterpillar Engines
Replaces: Caterpillar 1R0718, 1R0756
O.D.: 3 15/16 (100.0)
I.D.: 1 5/8 (41.3)
Height: 9 7/32 (234.2)
A. Gskt: [2] Attached

BF7663

Fuel Spin-on



Fits: Iveco EuroCargo, EuroStar, EuroTech, EuroTrakker Series Trucks
Replaces: Iveco 1907640
Thread: M16 x 1.5
O.D.: 3 1/32 (77.0)
Height: 5 27/32 (148.4)
I.Gskt: G449-B

BF7656

Primary Fuel Spin-on



Contains: Integral Post Seal
Fits: Mack Engines, Trucks
Replaces: Mack 483GB470M
Thread: M22 x 1.5
O.D.: 4 1/4 (108.0)
Height: 7 19/32 (192.9)
I.Gskt: [1] Included

BF7664

Fuel Spin-on



Fits: DAF Trucks
Replaces: DAF 1318695
Thread: M16 x 1.5
O.D.: 3 11/16 (93.7)
Height: 5 3/8 (136.5)
I.Gskt: G381-A

BF7657

Secondary Fuel Spin-on



Contains: Integral Post Seal
Fits: Mack Engines, Trucks
Replaces: Mack 483GB471M
Thread: M30 x 1.5
O.D.: 4 1/4 (108.0)
Height: 10 7/16 (265.1)
I.Gskt: [1] Included

BF7666

Fuel/Water Separator Spin-on



Fits: Isuzu Engines; Link-Belt Backhoes
Replaces: Isuzu 8-94453-738-1, 8-94453-738-2
Thread: 3/4 -16
O.D.: 3 11/16 (93.7)
Height: 3 1/4 (82.6)
I.Gskt: G324-A

BF7658

In-Line Fuel Filter



Contains: [1] Plastic Retainer Clip
Fits: GMC, Isuzu Light-Duty Trucks
Replaces: GMC 25168594; Isuzu 8-25168-594-0
O.D.: 2 9/32 (57.9)
Inlet: M16 x 1.5
Outlet: 3/8
Length: 5 3/8 (136.5)

BF7667

In-Line Fuel Filter



Contains: [1] Plastic Retainer Clip
Fits: Cadillac Automotive
Replaces: GMC 25163684
O.D.: 2 5/32 (54.8)
Inlet: 3/8
Outlet: M14 x 1.5
Length: 5 13/32 (137.3)

BF7659

In-Line Fuel Filter



Fits: Chrysler, Dodge, Eagle, Mitsubishi Automotive
Replaces: GMC 25313814; Mitsubishi MR188221
O.D.: 2 17/32 (64.3)
Inlet: M12 x 1 1/4
Outlet: M12 x 1 1/4
Length: 3 31/32 (100.8)
F. Gskt: [4] Metal Washers

BF7668

In-Line Fuel Filter



Contains: [2] 3/8 Inch Clips
Fits: Ford, Jaguar, Lincoln, Mazda, Mercury Automotive, Light-Duty Trucks
Replaces: Ford F89Z-9155-A
O.D.: 2 7/32 (56.4)
Inlet: 5/16
Outlet: 5/16
Length: 7 3/32 (180.2)
Related To: BF7768 (5/16 In. Clips)

BF7669

In-Line Fuel Filter



Contains: 5/16 Inch Return Line Steel Braided Ground Wire
Fits: Chrysler Vans
Replaces: Chrysler 4682569, 4809117, 4809117-AB
O.D.: 1 29/32 (48.4)
Inlet: 3/8
Outlet: 5/16
Length: 30 (762.0)

Measurements Are Shown In Inches And (Millimeters)

WARNING: These products can expose you to chemicals, including Diisononyl Phthalate, Carbon black extracts, Nickel, 1,3 Butadiene, Ethylene Oxide, Epichlorohydrin, which are known to the State of California to cause cancer, and Bisphenol, Ethylene Glycol, Ethylene Oxide, 1,3 Butadiene, Epichlorohydrin, which are known to the State of California to cause birth defects or other reproductive harm. For more information go to www.P65Warnings.ca.gov.

BF7670

In-Line Fuel Filter



Fits: Audi, Volkswagen Automotive
Replaces: Volkswagen 1J0201511A
O.D.: 3 7/32 (81.8)
Inlet: 5/16
Outlet: 5/16
Length: 6 15/16 (176.2)

BF7671

In-Line Fuel Filter



Contains: 5/16 Inch Return Line
Fits: Chrysler Automotive
Replaces: Chrysler 4764210
O.D.: 2 11/32 (59.5)
Inlet: 3/8
Outlet: 5/16
Length: 8 11/32 (211.9)

BF7672-D

Primary Fuel/Water Coalescer Element with Drain



Notes: Tab/Keys are not needed for installation.
Fits: Caterpillar, John Deere Equipment
Use With: BF7673-D, BF7674-D
Replaces: Caterpillar 131-1812; John Deere RE53729, RE62421; Donaldson P550398; Fleetguard FS19554
O.D.: 3 9/32 (83.3)
I.D.: 2 1/32 (16.7) One End
Height: 5 31/32 (151.6)
Grommets: [1] Attached

BF7673-D

Secondary Fuel/Water Coalescer Element with Drain



Notes: Tab/Keys are not needed for installation.
Fits: John Deere Engines, Equipment
Use With: BF7672-D
Replaces: John Deere RE50455, RE58367, RE62418; Donaldson P550351; Fleetguard FS19516
O.D.: 3 9/32 (83.3)
I.D.: 2 1/32 (16.7) One End
Height: 5 7/32 (132.6)
F. Gskt: [1] Included
Grommets: [1] Attached

BF7674-D

Secondary Fuel/Water Separator Element with Drain



Notes: Tab/Keys are not needed for installation.
Fits: Caterpillar, Perkins Engines; John Deere Equipment
Use With: BF7672-D, BF7681-D
Replaces: Caterpillar 100-5593, 138-3098, 159-6102; GMC 12554082; John Deere RE52987, RE53400, RE62419, RE509031
O.D.: 3 9/32 (83.3)
I.D.: 2 1/32 (16.7) One End
Height: 5 31/32 (151.6)
F. Gskt: [1] Included
Grommets: [1] Attached

BF7675-D

Secondary Fuel/Water Separator Element with Drain



Notes: Tab/Keys are not needed for installation.
Fits: John Deere Power Tech Engines
Replaces: John Deere RE60021; Fleetguard FS19573
O.D.: 3 9/32 (83.3)
I.D.: 2 1/32 (16.7) One End
Height: 4 15/32 (113.5)

BF7677-D

Grommets: [1] Attached
 Secondary Fuel/Water Separator Element with Drain



Notes: Tab/Keys are not needed for installation.
Fits: Case-IH, Challenger, Massey Ferguson, New Holland Tractors; Caterpillar, John Deere Equipment
Replaces: John Deere RE62420; Stanadyne 32179
O.D.: 3 9/32 (83.3)
I.D.: 2 1/32 (16.7) One End
Height: 7 5/8 (193.7)
Grommets: [1] Attached

PF7678

Fuel Element with Lid



Notes: Lid Accepts 1/2 In. Square Driver
Fits: Ford Light-Duty Trucks, Vans
Replaces: Ford F4TZ-9N184-A, F4TZ-9N184-B
O.D.: 3 17/32 (89.7)
 Lid 4 7/8 (123.8)
I.D.: 9/16 (14.3) One End
Height: 4 17/32 (115.1)
O-Ring: [1] Attached
Grommets: [1] Attached

BF7679-D

Primary Fuel/Water Coalescer Element with Drain



Notes: Tab/Keys are not needed for installation.
Fits: Caterpillar, John Deere Equipment
Replaces: Caterpillar 117-4089; John Deere RE62424
O.D.: 3 9/32 (83.3)
I.D.: 2 1/32 (16.7) One End
Height: 5 31/32 (151.6)
Grommets: [1] Attached

PF7680

Fuel/Water Separator Element



Fits: Caterpillar, Cummins, Detroit Diesel, Mack Engines with Davco Housing
Replaces: Davco 380087; Detroit Diesel 23514049; Mack 301SD19A, 301SD19B
O.D.: 3 3/4 (95.3)
I.D.: 2 1/32 (16.7) One End
Height: 7 1/32 (178.6)
O-Ring: G445, ES3012
O. Gskt: G717 (for Webb Housing)
Grommets: [1] Attached

BF7681-D

Primary Fuel/Water Coalescer Element with Drain



Notes: Tab/Keys are not needed for installation.
Fits: Caterpillar, Perkins Engines; New Holland Tractors
Use With: BF7674-D
Replaces: Caterpillar 100-6374, 138-3100; New Holland 87840591
O.D.: 3 9/32 (83.3)
I.D.: 2 1/32 (16.7) One End
Height: 5 7/32 (132.6)
Grommets: [1] Attached

Measurements Are Shown In Inches And (Millimeters)

WARNING: These products can expose you to chemicals, including Diisononyl Phthalate, Carbon black extracts, Nickel, 1,3 Butadiene, Ethylene Oxide, Epichlorohydrin, which are known to the State of California to cause cancer, and Bisphenol, Ethylene Glycol, Ethylene Oxide, 1,3 Butadiene, Epichlorohydrin, which are known to the State of California to cause birth defects or other reproductive harm. For more information go to www.P65Warnings.ca.gov.

BF7682-D Primary Fuel/Water Coalescer Element with Drain
Notes: Tab/Keys are not needed for installation.
Fits: John Deere, Timberjack Equipment
Replaces: John Deere RE62423, RE65431; Timberjack 431892, F431892
O.D.: 3 9/32 (83.3)
I.D.: 21/32 (16.7) One End
Height: 7 5/8 (193.7)
Grommets: [1] Attached



BF7693 Steel Screen In-Line Fuel Strainer
Fits: Case-International, John Deere, Komatsu Equipment
Replaces: Case 194199A1; Komatsu 20704-A1100
O.D.: 1 29/32 (48.4)
Inlet: 1/2
Outlet: 1/2
Length: 4 1/4 (108.0)



BF7683 Fuel Spin-on
Fits: Kubota Engines, Equipment
Replaces: Kubota 70000-43081
Thread: M20 x 1.5
O.D.: 3 (76.2)
Height: 3 1/2 (88.9)
I.Gskt: G449-B



BF7695 Resin Ribbon Fuel Coalescer Spin-on with Drain
Fits: Cummins Natural Gas Engines
Replaces: Cummins 3606712, 3607140
Thread: 1 1/2 -16
O.D.: 3 11/16 (93.7)
Height: 7 3/16 (182.6)
I.Gskt: [1] Included



B7685 By-Pass Lube Spin-on
Fits: R.V.I., Volvo Buses, Engines, Equipment, Trucks
Replaces: V.M.E. 119962280; Volvo 477556, 477556-5
Thread: 1 3/8 -16
O.D.: 4 1/4 (108.0)
Height: 10 1/16 (255.6)
I.Gskt: [1] Included



BF7696 Fuel Spin-on
Fits: Iveco EuroTech Trucks with Cursor Engine
Replaces: Iveco 2991585
Thread: M16 x 1.5
O.D.: 3 11/16 (93.7)
Height: 8 1/8 (206.4)
I.Gskt: G381-A



BF7686 In-Line Fuel Filter
Fits: Kawasaki Motorcycles, Mules
Replaces: Kawasaki 490191055
O.D.: 1 7/16 (36.5)
Inlet: 5/16
Outlet: 5/16
Length: 3 27/32 (97.6)



BF7697 High Efficiency Fuel Spin-on
Contains: Integral Post Seal
Fits: Detroit Diesel Engines
Replaces: Detroit Diesel 23518529, 25013535
Thread: 1 1/16 -16
O.D.: 4 21/32 (118.3)
Height: 9 1/2 (243.7)
I.Gskt: [1] Included



PF7687 Fuel Element
Fits: Late Model Detroit Diesel Engines Equipped with Davco Fuel Filters
Replaces: Detroit Diesel 23519978, 23521527
O.D.: 3 7/16 (87.3)
I.D.: 21/32 (16.7) One End
Height: 4 23/32 (119.9)
F. Gskt: [4] Included
Grommets: [1] Attached



BF7698 Fuel Element with Lid
Notes: Lid Accepts 1/2 In. Square Driver
Fits: Ford Light-Duty Trucks
Replaces: Ford F81Z-9N184-AA
O.D.: 3 27/32 (97.6)
Lid 4 7/8 (123.8)
I.D.: 9/16 (14.3) One End
Height: 3 9/16 (90.5)
I.Gskt: [2] Included
Grommets: [1] Attached



BF7690 Steel Screen In-Line Fuel Strainer
Fits: John Deere Tractors
Replaces: John Deere RE38818
O.D.: 1 31/32 (50.0)
Inlet: 9/16-18
Outlet: 9/16-18
Length: 3 23/32 (94.5)



BF7699-D Primary Fuel/Water Coalescer Element with Drain
Notes: Reverse Flow
Tab/Keys are not needed for installation.
Fits: Barber Greene, Caterpillar Equipment
Replaces: Caterpillar 151-2409; Stanadyne 33748
O.D.: 3 9/32 (83.3)
I.D.: 21/32 (16.7) One End
Height: 5 7/32 (132.6)
Grommets: [1] Attached



BF7691 In-Line Fuel Filter
Fits: GMC Motor Homes with Portable Fuel Storage Tanks
Replaces: GMC 25055347
O.D.: 2 (50.8)
Inlet: 1/2
Outlet: 1/2
Length: 4 7/16 (112.7)



Measurements Are Shown In Inches And (Millimeters)

WARNING: These products can expose you to chemicals, including Diisononyl Phthalate, Carbon black extracts, Nickel, 1,3 Butadiene, Ethylene Oxide, Epichlorohydrin, which are known to the State of California to cause cancer, and Bisphenol, Ethylene Glycol, Ethylene Oxide, 1,3 Butadiene, Epichlorohydrin, which are known to the State of California to cause birth defects or other reproductive harm. For more information go to www.P65Warnings.ca.gov.

B7700



High Efficiency Lube Spin-on
Fits: Caterpillar Engines, Equipment
Replaces: Caterpillar 1R1807
Thread: 1 1/8 -16
O.D.: 4 1/4 (108.0)
Height: 10 1/16 (255.6)
I.Gskt: [1] Included
Related To: B76, B76-MPG, B76-SS (Long Versions)
 B7600, B7600-SS (Standard Versions)

PF7718



Fuel Element
Replaces: Fleetguard FS19559
O.D.: 4 11/32 (110.3)
I.D.: 21/32 (16.7) One End
Height: 6 1/2 (165.1)
O-Ring: [1] Included
Grommets: [1] Attached
Related To: PF7749 (Maximum Performance Glass Media Version)

BF7711



In-Line Fuel Filter
Contains: 3/8 Inch Quick Connect
 [1] Plastic Clip
Fits: Jeep Grand Cherokee
Replaces: Chrysler 52100283AC
O.D.: 2 5/32 (54.8)
Inlet: 5/16
Outlet: 3/8
Length: 6 3/4 (171.5)

BF7719



In-Line Fuel Filter
Contains: [1] Plastic Clip
Fits: Buick, Chevrolet, Oldsmobile, Pontiac Vans
Replaces: GMC 10290491
O.D.: 1 15/16 (49.2)
Inlet: 3/8 In.
Outlet: 3/8 In.
Length: 5 25/32 (146.8)

BF7713



In-Line Fuel Filter
Fits: Dodge Light-Duty Trucks, Vans
Replaces: Chrysler 4443452, 4443454, 4549712
O.D.: 2 1/8 (54.0)
Inlet: 5/16
Outlet: 5/16
Length: 4 13/16 (122.2)

BF7720



In-Line Fuel Filter
Fits: Geo, Suzuki Automotive
Replaces: Suzuki 15430-50G00
O.D.: 2 15/16 (74.6)
Inlet: 5/16
Outlet: 5/16
Length: 4 25/32 (121.4)

PF7715



Fuel Element
Fits: Railroad Applications
Replaces: Alco 1831113-2, 2321946; Clark FA1
O.D.: 5 1/16 (128.6)
I.D.: 11/16 (17.5) One End
Height: 11 7/8 (301.6)
A. Gskt: [1] Included
Spring: [1] Attached

BF7721



In-Line Fuel Filter
Fits: Acura Automotive
Replaces: Honda 16900-SD4-671
O.D.: 3 13/32 (86.5)
Inlet: M14 x 1.5
Outlet: M12 x 1 1/4
Length: 4 1/4 (108.0)
F. Gskt: [2] Copper Washers

PF7716



Fuel Element
Fits: Railroad Applications
Replaces: Alco 1831112-2; Clark FA2
O.D.: 5 1/16 (128.6)
I.D.: 11/16 (17.5) One End
Height: 20 15/16 (531.8)
A. Gskt: [1] Attached
Spring: [1] Attached

BF7725



Nylon Screen In-Line Fuel Filter
Fits: Mercedes-Benz Automotive
Replaces: Atlas Copco 29148002; John Deere AL78988; Mercedes-Benz 14772101, 14776901
O.D.: 1 13/32 (35.7)
Inlet: 5/16
Outlet: 5/16
Length: 4 5/32 (105.6)

BF7717



Secondary Fuel Spin-on
Fits: John Deere Equipment
Replaces: John Deere RE502204, RE506428
Thread: 7/8 -14
O.D.: 4 13/32 (111.9)
Height: 5 29/32 (150.0)
I.Gskt: [1] Included

BF7726



In-Line Fuel Filter
Contains: [2] Bleeder Plugs
 Reverse Flow Valve at Inlet
Fits: Allis Chalmers, Case, Continental, Hercules, Massey Ferguson, Oliver, Waukesha Equipment
Replaces: Case A57228; GMC 2449298
O.D.: 3 13/16 (96.8)
Inlet: 1/4-18
Outlet: 1/4-18
Length: 6 13/32 (162.7)

PF7733



Fuel/Water Separator Element
Replaces: Fleetguard FS1011; Donaldson P550447
O.D.: 4 11/32 (110.3)
I.D.: 21/32 (16.7) One End
Height: 6 7/16 (163.5)
O-Ring: [1] Included
Grommets: [1] Attached
Related To: PF7734 (Maximum Performance Media Version)

Measurements Are Shown In Inches And (Millimeters)

WARNING: These products can expose you to chemicals, including Diisononyl Phthalate, Carbon black extracts, Nickel, 1,3 Butadiene, Ethylene Oxide, Epichlorohydrin, which are known to the State of California to cause cancer, and Bisphenol, Ethylene Glycol, Ethylene Oxide, 1,3 Butadiene, Epichlorohydrin, which are known to the State of California to cause birth defects or other reproductive harm. For more information go to www.P65Warnings.ca.gov.

PF7734 Maximum Performance Fuel/Water Separator Element



Replaces: Fleetguard FS1020
O.D.: 4 11/32 (110.3)
I.D.: 21/32 (16.7)
Height: 6 1/2 (165.1)
O-Ring: [1] Included
Grommets: [1] Attached
Related To: PF7733 (Standard Media Version)

PF7735 Fuel Element



Fits: Claas, Demag, Grove Equipment; Freightliner, Sterling Trucks; Mercedes-Benz Engines, Trucks
Replaces: Mercedes-Benz A0000901551, A9060920305
O.D.: 3 5/8 (92.1)
I.D.: 1 3/32 (27.8)
Height: 4 1/16 (103.2)
O-Ring: [1] Included

BF7736 In-Line Fuel Filter



Fits: Bomag, Case, New Holland Equipment
Replaces: Wix 33002
O.D.: 2 1/8 (54.0)
Inlet: 5/16
Outlet: 5/16
Length: 3 21/32 (92.9)
Related To: BF840, BF840-K1 (Metal Versions)

BF7736-K1 Fuel Element in Plastic Housing



Contains: [4] Clips
 [2] Hoses
Replaces: Fiaam FT4648B; Woodgate WGF149-PK
O.D.: 2 1/8 (54.0)
Inlet: 5/16
Outlet: 1/4
Length: 4 11/16 (119.1)

BF7742 In-Line Fuel Filter



Contains: 5/16 Inch Return Line
Fits: Ford, Mercury Light-Duty Trucks
Replaces: Ford 2L2Z-9155-AB
O.D.: 2 1/4 (57.2)
Inlet: 3/8
Outlet: 3/8
Length: 7 (177.8)

PF7744 Fuel/Water Separator Element



Fits: Freightliner, International, Kenworth, Peterbilt, Sterling, Volvo Trucks
Replaces: Caterpillar 4176217; Detroit Diesel 23521528; General Motors 23521528; Fleetguard FF5369, FF5369W
O.D.: 3 3/4 (95.3)
I.D.: 21/32 (16.7) One End
Height: 6 29/32 (175.4)
O-Ring: G445
O. Gskt: G717
End Seals: ES3012
Grommets: [1] Attached

BF7745-D Secondary Fuel/Water Separator Element with Drain



Notes: Reverse Flow
 Tab/Keys are not needed for installation.
Fits: Ford, New Holland Equipment
Replaces: New Holland 87801434
O.D.: 3 9/32 (83.3)
I.D.: 21/32 (16.7) One End
Height: 4 15/32 (113.5)
Grommets: [1] Attached

BF7746-D Secondary Fuel/Water Separator Element with Drain



Notes: Reverse Flow
 Tab/Keys are not needed for installation.
Fits: Case, Caterpillar, New Holland Equipment
Replaces: Ford YC15-9176-AA; Stanadyne 34470, 35332
O.D.: 3 9/32 (83.3)
I.D.: 21/32 (16.7) One End
Height: 7 5/8 (193.7)
Grommets: [1] Attached

BF7747 Fuel Spin-on



Fits: DAF Trucks
Replaces: DAF 1345335; Fleetguard FF5366
Thread: M22 x 1.5
O.D.: 3 11/16 (93.7)
Height: 5 5/8 (142.9)
I.Gskt: G381-A

PF7748 Fuel/Water Separator Element



Contains: Relief Valve
Fits: Davco Fuel Pro
Replaces: Detroit Diesel 23529168; Davco 382114
O.D.: 3 3/4 (95.3)
I.D.: 21/32 (16.7) One End
Height: 7 1/32 (178.6)
F. Gskt: G402, G445, ES3012
Grommets: [1] Attached

PF7749 Maximum Performance Fuel/Water Separator Element



Fits: Fleetguard FH23000, FH23001, FH23002, FH23003, FH23300, FH23301 Assemblies
Replaces: Fleetguard FS1021, FS19557
O.D.: 4 23/32 (119.9)
I.D.: 21/32 (16.7) One End
Height: 6 15/32 (164.3)
O-Ring: [1] Included
Grommets: [1] Attached
Related To: PF7718 (Standard Media Version)

BF7750 Fuel Spin-on



Fits: Various Fuel Pumps
Replaces: Petro Clear 40510P
Thread: 1 -12
O.D.: 3 11/16 (93.7)
Height: 5 5/8 (142.9)
I.Gskt: G381-A

PF7751 Fuel/Water Separator Element with Lid



Fits: Dodge Light-Duty Trucks with 5.9L Turbo Diesel Engine
Replaces: Chrysler 4883963AC; Cummins 3990130; Fleetguard FS19598
O.D.: 3 19/32 (91.3)
 Lid 4 1/8 (104.8)
I.D.: 1 1/8 (28.6)
Height: 4 5/16 (109.5)
A. Gskt: [1] Attached
O-Ring: [1] Attached
Grommets: [1] Attached

Measurements Are Shown In Inches And (Millimeters)

WARNING: These products can expose you to chemicals, including Diisononyl Phthalate, Carbon black extracts, Nickel, 1,3 Butadiene, Ethylene Oxide, Epichlorohydrin, which are known to the State of California to cause cancer, and Bisphenol, Ethylene Glycol, Ethylene Oxide, 1,3 Butadiene, Epichlorohydrin, which are known to the State of California to cause birth defects or other reproductive harm. For more information go to www.P65Warnings.ca.gov.

BF7753



High Efficiency Fuel Spin-on
Fits: Caterpillar Engines, Equipment, Trucks
Replaces: Caterpillar 1R0762
Thread: 1 -14
O.D.: 3 11/16 (93.7)
Height: 10 1/2 (266.7)
I.Gskt: [1] Included

PF7761



Fuel Element
Fits: Demag, Grove Equipment; Freightliner, Mercedes-Benz, Sterling, Western Star Trucks; Mercedes-Benz Engines
Replaces: Mercedes-Benz 5410900151, A5410920305, A5410920805
O.D.: 3 23/32 (94.5)
I.D.: 1/2 (12.7) & 1 25/32 (45.2)
Height: 8 (203.2)
I.Gskt: [1] Included
A. Gskt: [1] Attached
O-Ring: [1] Included
Grommets: [1] Included

PF7755



Fuel/Water Separator Element
Contains: Relief Valve
Fits: Caterpillar, Cummins Engines; International, Kenworth, Peterbilt, Volvo Trucks
Replaces: Davco 382116; Donaldson P550737; Fleetguard FS19729
O.D.: 3 3/4 (95.3)
I.D.: 2 1/32 (16.7) One End
Height: 7 1/32 (178.6)
F. Gskt: G402, G445, ES3012
Grommets: [1] Attached

BF7762



In-Line Fuel Filter
Contains: [2] Plastic Clips
Fits: Chevrolet, GMC, Isuzu, Oldsmobile Light-Duty Trucks; Hummer H2
Replaces: GMC 15015509
O.D.: 2 5/32 (54.8)
Inlet: 3/8
Outlet: 3/8
Length: 4 27/32 (123.0)

BF7756



In-Line Fuel Element
Contains: 13/32 Inch Return
Fits: Mercedes-Benz Trucks
Replaces: Mercedes-Benz 6110920201, A6110920201
O.D.: 3 19/32 (91.3)
Inlet: 3/8
Outlet: 15/32
Height: 5 (127.0)
O-Ring: [1] Attached

BF7763



In-Line Fuel Filter
Contains: 5/16 Inch Return Line Ground Wire
Fits: Chrysler, Dodge Automotive
Replaces: Chrysler 4809118AC, 4809118AD
O.D.: 1 31/32 (50.0)
Inlet: 3/8
Outlet: 5/16
Length: 24 (609.6)

PF7758



Fuel Element
Fits: Mitsubishi Engines
Replaces: Mitsubishi ME036459, ME036478; Donaldson P550054
O.D.: 3 5/8 (92.1)
I.D.: 19/32 (15.1)
Height: 4 11/32 (110.3)
F. Gskt: [1] Included
Grommets: [2] Attached

BF7765



In-Line Fuel Filter
Contains: Mounting Bracket with M8 x 1 1/4 Threaded Stud
 3/8 Inch Return Line
Fits: Ford, Mazda Light-Duty Trucks
Replaces: Ford 1L5E-9155-BA, 2L5Z-9155-AA
O.D.: 3 5/8 (92.1)
Inlet: 5/16
Outlet: 5/16
Length: 6 5/8 (168.3)

BF7759



Stainless Steel Mesh Fuel Strainer with Drain
Contains: 200 Mesh Media
Fits: GMC Trucks; Detroit Diesel Engines
Replaces: GMC 15152281; Racor S6484
Thread: 1 -12
O.D.: 3 11/16 (93.7)
Height: 7 13/32 (188.1)
I.Gskt: [1] Included

BF7766



Fuel Spin-on
Fits: Cummins ISX Series Engines; International, Kenworth, Mack, Peterbilt, Volvo Trucks
Replaces: Cummins 4088272; Fleetguard FF2200
Thread: M72 x 2.0
O.D.: 3 23/32 (94.5)
Height: 9 5/32 (232.6)
I.Gskt: [1] Included

BF7760



Wire Mesh Fuel Spin-on
Fits: International, Kenworth, Peterbilt Trucks with ISX Engine
Replaces: Cummins 4010476; Fleetguard FF2203
Thread: 1 -14
O.D.: 3 11/16 (93.7)
Height: 5 11/16 (144.5)
I.Gskt: G401
O-Ring: [1] Included

PF7767



Fuel Element
Fits: DAF Trucks
Replaces: DAF 1397766
O.D.: 3 31/32 (100.8)
I.D.: 1/2 (12.7) & 1 3/4 (44.5)
Height: 8 (203.2)
A. Gskt: [1] Attached
O-Ring: [1] Included
Grommets: [2] Attached

Measurements Are Shown In Inches And (Millimeters)

WARNING: These products can expose you to chemicals, including Diisononyl Phthalate, Carbon black extracts, Nickel, 1,3 Butadiene, Ethylene Oxide, Epichlorohydrin, which are known to the State of California to cause cancer, and Bisphenol, Ethylene Glycol, Ethylene Oxide, 1,3 Butadiene, Epichlorohydrin, which are known to the State of California to cause birth defects or other reproductive harm. For more information go to www.P65Warnings.ca.gov.

BF7768 In-Line Fuel Filter
Contains: [2] 5/16 Inch Clips
Fits: Ford Automotive
Replaces: Motorcraft FG986B
O.D.: 2 7/32 (56.4)
Inlet: 5/16
Outlet: 5/16
Length: 7 1/32 (178.6)
Related To: BF7668 (3/8 In. Clips)



BF7774 Fuel Spin-on
Fits: Detroit Diesel Engines
Replaces: Detroit Diesel 23530641
Thread: 1 -12
O.D.: 3 11/16 (93.7)
Height: 5 11/32 (135.7)
I.Gskt: [1] Included



BF7769 In-Line Fuel Filter
Contains: [2] Plastic Retainer Clips
Fits: Buick, Chevrolet, Oldsmobile, Pontiac, Saturn Automotive, Light-Duty Trucks
Replaces: GMC 10333072
O.D.: 1 31/32 (50.0)
Inlet: 3/8
Outlet: 3/8
Length: 6 27/32 (173.8)



BF7775 In-Line Fuel Filter
Contains: 3/8 Inch Universal Return Line
Fits: Pontiac Automotive
Replaces: GMC 10337405; ACDelco GF872
O.D.: 2 1/8 (54.0)
Inlet: M16 x 1.5
Outlet: 3/8
Length: 6 9/16 (166.7)



PF7770 Dual-Flow Fuel Element
Fits: John Deere Engines, Equipment
Replaces: John Deere RE507284
O.D.: 4 5/8 (117.5)
Lid: 5 3/8 (136.5)
I.D.: 7/8 (22.2) One End
Height: 8 3/8 (212.7)
A. Gskt: [1] Attached
Grommets: [1] Attached



BF7776 In-Line Fuel Filter
Contains: 5/16 Inch Universal Return Line
Fits: Cadillac Automotive
Replaces: GMC 25763176; ACDelco GF897
O.D.: 2 1/8 (54.0)
Inlet: M16 x 1.5
Outlet: 3/8
Length: 6 1/4 (158.8)



BF7771 In-Line Fuel Filter
Contains: [2] Plastic Retainer Clips
 5/16 Inch Return Line
 Plastic Mounting Band
 Screw and Washer
Fits: Saturn Automotive
Replaces: GMC 22633313, 22633314
O.D.: 2 5/32 (54.8)
Inlet: 3/8
Outlet: 3/8
Length: 6 7/8 (174.6)



PF7777 Fuel/Water Separator Element
Fits: Cummins ISB Series Engines; Dodge Light-Duty Trucks; Ford, Freightliner, Kenworth, Peterbilt, Sterling Trucks
Replaces: Chrysler 5015581AA; Cummins 3942470; Fleetguard FS19579
O.D.: 3 3/8 (85.7)
I.D.: 13/16 (20.6) One End
Height: 4 3/32 (104.0)
O-Ring: [1] Included
Grommets: [1] Attached



BF7772 Fuel/Water Separator Spin-on with Drain
Fits: Case Equipment; Gehl Loaders
Replaces: Gehl 132024
Thread: M16 x 1.5
O.D.: 3 1/32 (77.0)
Height: 6 21/32 (169.1)
A. Gskt: G449-B
F. Gskt: [1] Included



BF7778 Fuel/Water Separator Element with Drain
Contains: 1/2 Inch Universal Return Port
 Pressure Relief Screw
Fits: Dodge, Freightliner Sprinter Vans; Mercedes-Benz Engines
Replaces: Mercedes-Benz 6120920001, A6120920001
O.D.: 3 19/32 (91.3)
Inlet: 13/32
Outlet: 1/2
Height: 4 23/32 (119.9)



BF7773 Fuel Spin-on
Contains: Integral Post Seal
Fits: Mack Engines, Trucks
Replaces: Mack 483GB476M
Thread: M30 x 1.5
O.D.: 4 1/4 (108.0)
Height: 7 19/32 (192.9)
I.Gskt: [1] Included



PF7779 Fuel/Water Separator Element
Fits: International Engines, Trucks
Replaces: International 1842638-C91; Fleetguard FS19684
O.D.: 3 3/4 (95.3)
I.D.: 13/16 (20.6) One End
Height: 5 11/16 (144.5)
O-Ring: [2] Included
Grommets: [1] Attached



BF7780 In-Line Fuel Filter
Contains: 3/8 Inch Quick Connect
Fits: Jeep Grand Cherokee
Replaces: Chrysler 52100283AG
O.D.: 2 5/32 (54.8)
Inlet: 5/16
Outlet: 3/8
Length: 6 13/16 (173.0)



Measurements Are Shown In Inches And (Millimeters)

WARNING: These products can expose you to chemicals, including Diisononyl Phthalate, Carbon black extracts, Nickel, 1,3 Butadiene, Ethylene Oxide, Epichlorohydrin, which are known to the State of California to cause cancer, and Bisphenol, Ethylene Glycol, Ethylene Oxide, 1,3 Butadiene, Epichlorohydrin, which are known to the State of California to cause birth defects or other reproductive harm. For more information go to www.P65Warnings.ca.gov.

PF7782



Fuel/Water Separator Element with Relief Valve
Fits: Cummins ISX Engines; Davco Fuel Pro FH230 Series, 382 Series Housings
Replaces: Davco 382119; Fleetguard FS19728
O.D.: 3 27/32 (97.6)
I.D.: 21/32 (16.7) One End
Height: 7 1/32 (178.6)
O-Ring: [3] Included
Grommets: [1] Attached

PF7788



Secondary Fuel Element
Use With: PF7787 (Primary)
Replaces: Zetor 931209; Woodgate WGF9002
O.D.: 2 27/32 (72.2)
I.D.: 13/16 (20.6)
Height: 5 3/16 (131.8)

BF7783-D



Primary Fuel/Water Coalescer Element with Drain
Notes: Tab/Keys are not needed for installation.
Fits: Massey Ferguson Tractors
Replaces: Agco 3780931M1; J.C. Bamford 32/921001; Fleetguard FS19585
O.D.: 3 9/32 (83.3)
I.D.: 21/32 (16.7) One End
Height: 5 7/32 (132.6)
Grommets: [2] Attached

BF7798-SP



Fuel/Water Separator Spin-on with Drain and Sensor Port
Notes: CAUTION: Furnished D-Ring must be installed on post for seal. Can be used with FB1311.
Contains: Sensor Port Thread: 1/2-20
Fits: Caterpillar Engines
Replaces: Caterpillar 198-6378
Thread: 1 -14
O.D.: 3 11/16 (93.7)
Height: 9 17/32 (242.1)
I.Gskt: G401
F. Gskt: [1] Included
O-Ring: [1] Included

BF7784-D



Primary Fuel/Water Separator Element with Drain
Notes: Reverse Flow
 Tab/Keys are not needed for installation.
Fits: John Deere Equipment
Replaces: Case/New Holland 87802332; John Deere RE517181
O.D.: 3 9/32 (83.3)
I.D.: 21/32 (16.7) One End
Height: 5 31/32 (151.6)
Grommets: [1] Attached

PF7799



Fuel Element
Fits: Caterpillar Industrial, Marine Engines
Replaces: Caterpillar 1R0725, 1R0766, 1W4056
O.D.: 5 1/16 (128.6)
I.D.: 2 3/32 (53.2)
Height: 10 7/16 (265.1)
A. Gskt: [2] Attached

BF7785-D



Primary Fuel/Water Separator Element with Drain
Notes: Reverse Flow
 Tab/Keys are not needed for installation.
Fits: John Deere Equipment
Replaces: John Deere RE509036, RE517180
O.D.: 3 9/32 (83.3)
I.D.: 21/32 (16.7) One End
Height: 7 5/8 (193.7)
Grommets: [1] Attached

BF7800



In-Line Fuel Filter
Fits: Lincoln Light-Duty Trucks
Replaces: Ford 2L7Z-9155-AA; Motorcraft FG1062
O.D.: 2 1/4 (57.2)
Inlet: 3/8
Outlet: 3/8
Length: 7 1/4 (184.2)

BF7786-D



Secondary Fuel/Water Separator Element with Drain
Notes: Tab/Keys are not needed for installation.
Fits: John Deere Equipment
Replaces: John Deere RE509032
O.D.: 3 9/32 (83.3)
I.D.: 21/32 (16.7) One End
Height: 7 5/8 (193.7)
Grommets: [1] Attached

BF7801



In-Line Fuel Filter
Contains: 3/8 Inch Return Line
Fits: Ford Automotive, Light-Duty Trucks
Replaces: Ford 1F1Z-9155-AD, 1F1Z-9155-CA
O.D.: 2 9/32 (57.9)
Inlet: 5/16
Outlet: 5/16
Length: 6 9/16 (166.7)

PF7787



Primary Fuel Element
Use With: PF7788 (Secondary)
Replaces: Zetor 931207; Fleetguard FF5197; Woodgate WGF9001
O.D.: 2 27/32 (72.2)
I.D.: 27/32 (21.4)
Height: 5 5/32 (131.0)

BF7802



In-Line Fuel Filter
Fits: Ford, Lincoln, Mercury Automotive, Light-Duty Trucks
Replaces: Ford 2C5Z-9155-AA
O.D.: 2 9/32 (57.9)
Inlet: 3/8
Outlet: 3/8
Length: 6 29/32 (175.4)

Measurements Are Shown In Inches And (Millimeters)

WARNING: These products can expose you to chemicals, including Diisononyl Phthalate, Carbon black extracts, Nickel, 1,3 Butadiene, Ethylene Oxide, Epichlorohydrin, which are known to the State of California to cause cancer, and Bisphenol, Ethylene Glycol, Ethylene Oxide, 1,3 Butadiene, Epichlorohydrin, which are known to the State of California to cause birth defects or other reproductive harm. For more information go to www.P65Warnings.ca.gov.

BF7803 In-Line Fuel Filter
Contains: 3/8 Inch Vapor Diverter
Fits: Ford, Mazda Light-Duty Trucks
Replaces: Ford 1L2Z-9155-BA
O.D.: 3 5/32 (80.2)
Inlet: 5/16
Outlet: 5/16
Length: 6 11/16 (169.9)



BF7804 In-Line Fuel Filter
Contains: 3/8 Inch Vapor Diverter
Fits: Ford Light-Duty Trucks
Replaces: Ford YF1Z-9155-BA
O.D.: 3 5/32 (80.2)
Inlet: 5/16
Outlet: 5/16
Length: 6 3/16 (157.2)



BF7805 In-Line Fuel Filter
Contains: 5/16 Inch Vapor Diverter
Fits: Ford Light-Duty Trucks
Replaces: Ford 2L1Z-9155-AA
O.D.: 2 1/4 (57.2)
Inlet: 3/8
Outlet: 3/8
Length: 7 27/32 (199.2)



BF7806 Fuel/Water Separator Spin-on with Drain
Contains: Front End Check Valve
Fits: Caterpillar Engines; Ford Trucks
Replaces: Ford YC35-9176-AA, YC3Z-9176-AA, YC3Z-9365-AA; Motorcraft FD4597, FG998
Thread: 1 -14
O.D.: 3 11/16 (93.7)
Height: 6 7/32 (158.0)
I.Gskt: [1] Included



BF7807 In-Line Fuel Filter
Fits: Chevrolet, Toyota Automotive; Toyota Light-Duty Trucks
Replaces: Toyota 23300-15010
O.D.: 2 1/4 (57.2)
Inlet: 9/32
Outlet: 9/32
Length: 2 1/4 (57.2)



BF7808 In-Line Fuel Filter
Fits: Chevrolet, GMC Light-Duty Trucks
Replaces: GMC 25164003
O.D.: 2 5/16 (58.7)
Inlet: M16 x 1.5
Outlet: 3/8
Length: 5 11/32 (135.7)



BF7809 In-Line Fuel Filter
Contains: [2] Plastic Clips
Fits: Ford, Mercury Automotive
Replaces: Ford YF1Z-9155-CA
O.D.: 3 3/32 (78.6)
Inlet: 5/16
Outlet: 5/16
Length: 5 23/32 (145.3)



PF7812 KIT Set of 2 Fuel Elements
Contains: [1] Primary Fuel Element
 [1] Secondary Fuel Element
Fits: Ford Light-Duty Trucks; International Engines
Replaces: Ford 3C3Z-9N184-CA
Primary
O.D.: 3 5/16 (84.1)
I.D.: 1 19/32 (40.5)
Height: 4 3/16 (106.4)
O-Ring: [2] Included
Secondary
O.D. 2 1/4
I.D. 21/32
Height 5 5/8



BF7813 Fuel Spin-on
Fits: Cummins Engines; DAF, Iveco Trucks
Replaces: Cummins 4897833; DAF 1399760; Fleetguard FF5420, FF5485
Thread: M20 x 1.5
O.D.: 3 11/16 (93.7)
Height: 7 1/8 (181.0)
A. Gskt: G381-A



BF7814 Fuel Spin-on
Fits: Mack Engines, Trucks; R.V.I. Trucks; Volvo Buses, Engines, Trucks
Replaces: Volvo 20430751; Donaldson P550739
Thread: M32 x 1.5
O.D.: 4 1/4 (108.0)
Height: 10 15/32 (265.9)
I.Gskt: [1] Included



BF7815 High Efficiency Fuel Spin-on
Fits: Cummins Engines; Kenworth, Mack, Peterbilt, Sterling Trucks
Replaces: Cummins 3959612; Fleetguard FF5488
Thread: 7/8 -14
O.D.: 3 23/32 (94.5)
Height: 7 5/32 (181.8)
I.Gskt: G381-A
F. Gskt: [1] Included



PF7816 Fuel Element with Threaded Lid
Replaces: Kubota 11420-43012; Woodgate WGF9327
O.D.: 1 1/4 (31.8)
 Lid 2 9/32 (57.9)
I.D.: 1/4 (6.4)
Height: 4 5/8 (117.5)



PF7817 Fuel Element
Fits: Citroen Automotive
Replaces: Peugeot 190629; Woodgate WGF9355
O.D.: 2 19/32 (65.9)
 Flange 3 5/32 (80.2)
I.D.: 3/4 (19.1)
Height: 2 11/32 (59.5)
O-Ring: [1] Attached



Measurements Are Shown In Inches And (Millimeters)

WARNING: These products can expose you to chemicals, including Diisononyl Phthalate, Carbon black extracts, Nickel, 1,3 Butadiene, Ethylene Oxide, Epichlorohydrin, which are known to the State of California to cause cancer, and Bisphenol, Ethylene Glycol, Ethylene Oxide, 1,3 Butadiene, Epichlorohydrin, which are known to the State of California to cause birth defects or other reproductive harm. For more information go to www.P65Warnings.ca.gov.

PF7818



Fuel Element

Fits: Hatz Engines
Replaces: Hatz 50474300;
 Woodgate WGF9306
O.D.: 1 1/8 (28.6)
I.D.: 5/8 (7.9) One End
Height: 2 7/32 (56.4)
Grommets: [1] Attached

PF7824



Fuel Element

Fits: Caterpillar, Mitsubishi Lift Trucks;
 Toro Lawn & Garden Tractors
Replaces: Mitsubishi ME408992;
 Fleetguard FF5131; Woodgate WGF9103
O.D.: 1 19/32 (40.5)
I.D.: 31/32 (24.6)
Height: 1 13/32 (35.7)

PF7819



Nylon Screen Fuel Element

Replaces: Mercedes-Benz 900150;
 Woodgate WGF9316
O.D.: 7/8 (22.2)
I.D.: 3/8 (9.5)
Height: 1 13/16 (46.0)

PF7825



Fuel Element

Fits: Honda Engines
Replaces: Honda 17682-ZG3-003;
 Woodgate WGF9201
O.D.: 2 (50.8)
I.D.: 5/8 (15.9) & 1 15/32 (37.3)
Height: 5 13/32 (137.3)
O-Ring: [1] Attached

PF7820



Fuel Element with Threaded Stud

Fits: Lister-Petter Engines
Replaces: AP-Lockheed LK65300;
 Fleetguard FF5044; Woodgate WGF5044
O.D.: 1 1/8 (28.6)
I.D.: 3/16 (4.8)
Height: 3 (76.2)
F. Gskt: [1] Rubber Washer

PF7826



Fuel Element

Contains: [2] Threaded Bolts
Fits: Yanmar Engines
Replaces: Yanmar 114250-55120;
 Woodgate WGF9202
O.D.: 1 9/16 (39.7)
I.D.: 11/32 (8.7)
Height: 5 1/8 (130.2)
A. Gskt: [1] Included
Related To: PF7828, PF7876 (Long Versions)

BF7821



Fuel Element with Drain

Fits: Ford Light-Duty Trucks
Replaces: Motorcraft EFG319;
 Fleetguard FF5483; Woodgate WGF850-2
O.D.: 3 9/16 (90.5)
I.D.: 1 15/32 (37.3)
Height: 5 9/32 (134.1)

PF7828



Fuel Element

Contains: [2] Threaded Bolts
Fits: Yanmar Carriers
Replaces: Yanmar 114650-55120;
 Woodgate WGF9203
O.D.: 1 9/16 (39.7)
I.D.: 5/8 (7.9) One End
Height: 7 13/16 (198.4)
A. Gskt: [1] Included
Related To: PF7826, PF7876 (Short Versions)

PF7822



Fuel Element

Replaces: Robin 2286211008;
 Woodgate WGF9065
O.D.: 1 3/8 (34.9)
I.D.: 15/32 (11.9) One End
Height: 1 3/4 (44.5)
O-Ring: [1] Attached

PF7829



Fuel Element

Replaces: Coopers FEM4130;
 Woodgate WGF9311
O.D.: 2 23/32 (69.1)
I.D.: 1 5/32 (29.4)
Height: 3 3/4 (95.3)
F. Gskt: [2] Included
Grommets: [2] Attached

PF7823



Fuel Element

Replaces: Honda 17682-ZG5-003;
 Woodgate WGF9067
O.D.: 1 31/32 (50.0)
I.D.: 13/32 (10.3) One End
Height: 3 25/32 (96.0)
O-Ring: [1] Attached

PF7830



Nylon Screen Fuel Strainer

Fits: Komatsu Equipment; Yanmar Excavators
Replaces: Yanmar 121850-55710;
 Woodgate WGF9347
O.D.: 1 3/8 (34.9)
I.D.: 15/32 (11.9) One End
Height: 2 3/4 (69.9)
O-Ring: [1] Attached

Measurements Are Shown In Inches And (Millimeters)



WARNING: These products can expose you to chemicals, including Diisononyl Phthalate, Carbon black extracts, Nickel, 1,3 Butadiene, Ethylene Oxide, Epichlorohydrin, which are known to the State of California to cause cancer, and Bisphenol, Ethylene Glycol, Ethylene Oxide, 1,3 Butadiene, Epichlorohydrin, which are known to the State of California to cause birth defects or other reproductive harm. For more information go to www.P65Warnings.ca.gov.

PF7832



Fuel Element

Fits: Kubota Excavators
Replaces: Yanmar 10590G-55710;
 Woodgate WGF9369
O.D.: 1 31/32 (50.0)
I.D.: 25/32 (19.8) One End
Height: 3 1/8 (79.4)

BF7839



Wound Fuel Spin-on with Threaded Port

Contains: Port Thread: M36 x 1.5
Replaces: Coopers FSM4135;
 Woodgate WGF9368
Thread: 3/4 -16
O.D.: 2 3/32 (53.2) to 2 27/32 (72.2)
Height: 4 25/32 (121.4)
I.Gskt: [1] Included

PF7833



Fuel Element

Replaces: Renault 5000590728;
 Fleetguard FF5057; Woodgate WGF5057
O.D.: 2 1/32 (51.6)
I.D.: 1/2 (12.7)
Height: 2 21/32 (67.5)
End Seals: [2] Attached

BF7840



Fuel Spin-on

Replaces: J.C. Bamford 8943254630;
 Woodgate WGF5114
Thread: 3/4 -16
O.D.: 3 1/8 (79.4)
Height: 3 (76.2)
I.Gskt: [1] Included

PF7834



Oval Fuel Element

Notes: Cap contains 10 tabs.
Replaces: Purflux C446; Woodgate WGF9312
O.D.: 2 25/32 (70.6)
 Top 3 3/4 (95.3)
I.D.: 1 1/32 (26.2) One End
Height: 3 1/8 (79.4)
O-Ring: [1] Attached

BF7841



Fuel Spin-on

Fits: Hitachi, Takeuchi Excavators
Replaces: Nissan 16403-J6500;
 Woodgate WGF5141
Thread: 3/4 -16
O.D.: 3 1/8 (79.4)
Height: 3 7/8 (98.4)
I.Gskt: [1] Included

PF7836



Fuel Element

Fits: Lister-Petter Engines
Replaces: Lister 203-32470;
 Fleetguard FF5099; Woodgate WGF5099
O.D.: 2 5/32 (54.8)
I.D.: 5/8 (7.9) & 15/16 (23.8)
Height: 2 15/32 (62.7)
F. Gskt: [3] Included

BF7842



Wound Fuel Spin-on with Threaded Port

Contains: Port Thread: M22 x 1.5
Fits: Mitsubishi Trucks
Replaces: Mitsubishi ME132525;
 Woodgate WGF9377
Thread: M20 x 1.5
O.D.: 3 27/32 (97.6)
Height: 5 19/32 (142.1)
I.Gskt: [1] Included
O-Ring: [1] Attached

BF7837



Fuel Spin-on

Fits: Kubota Engines
Replaces: Woodgate WGF9071
Thread: M20 x 1.5
O.D.: 3 3/32 (78.6)
Height: 2 21/32 (67.5)
I.Gskt: [1] Included

BF7843



In-Line Fuel Filter in Plastic Housing

Replaces: Mann & Hummel WK21;
 Woodgate WGF9304
O.D.: 3/4 (19.1)
Inlet: 3/16
Outlet: 3/16
Length: 2 3/8 (60.3)

BF7838



Wound Fuel Spin-on with Threaded Port

Contains: Port Thread: M22 x 1.5
Fits: Hitachi Excavators; Komatsu Lift Trucks
Replaces: Daihatsu 23303-87781;
 Fleetguard FF5229; Woodgate WGF9223
Thread: M20 x 1.5
O.D.: 3 7/32 (81.8)
Height: 4 25/32 (121.4)
I.Gskt: [1] Included
O-Ring: [1] Included

BF7844



In-Line Fuel Filter with Drain

Fits: Kubota Excavators
Replaces: Kubota 19099-11151;
 Woodgate WGF842-3
O.D.: 3 3/8 (85.7)
Inlet: 5/16
Outlet: 5/16
Length: 6 21/32 (169.1)

BF7845



Plastic In-Line Fuel Filter

Contains: [2] Bleed Screws
Fits: Mitsubishi Engines
Replaces: Mitsubishi MM304900;
 Woodgate WGF9060
O.D.: 1 25/32 (45.2)
Inlet: 5/16
Outlet: 11/32
Length: 3 27/32 (97.6)

Measurements Are Shown In Inches And (Millimeters)

WARNING: These products can expose you to chemicals, including Diisononyl Phthalate, Carbon black extracts, Nickel, 1,3 Butadiene, Ethylene Oxide, Epichlorohydrin, which are known to the State of California to cause cancer, and Bisphenol, Ethylene Glycol, Ethylene Oxide, 1,3 Butadiene, Epichlorohydrin, which are known to the State of California to cause birth defects or other reproductive harm. For more information go to www.P65Warnings.ca.gov.

BF7847

Plastic In-Line Fuel Filter



Contains: Inlet, Outlet and Return Lines
Bleed Screw
Fits: Robin Engines
Replaces: Robin 2436210120;
Woodgate WGF9341
O.D.: 2 9/32 (57.9)
Length: 4 1/32 (102.4)

BF7848

In-Line Fuel Filter



Fits: Mercedes-Benz Automotive
Replaces: Mercedes-Benz 14777901;
Woodgate WGF31-5
O.D.: 1 13/32 (35.7)
Inlet: 5/16
Outlet: 5/16
Length: 4 3/32 (104.0)

BF7849

Plastic In-Line Fuel Filter



Contains: 9/32 Inch Return Line
Fits: Lombardini Engines
Replaces: Lombardini 196.3730.096;
Woodgate WGF9229
O.D.: 1 27/32 (46.8)
Inlet: 9/32
Outlet: 9/32
Length: 3 3/8 (85.7)

BF7850

Nylon In-Line Fuel Filter



Replaces: Woodgate WGF9301
O.D.: 2 (50.8)
Inlet: 5/16 or 3/8 In. Universal
Outlet: 5/16 or 3/8 In. Universal
Length: 8 1/8 (206.4)

BF7851

Wire Mesh In-Line Fuel Filter in Plastic Housing



Replaces: Woodgate WGF9303
O.D.: 1 15/32 (37.3)
Inlet: 1/4 or 5/16 In. Universal
Outlet: 1/4 or 5/16 In. Universal
Length: 4 7/32 (107.2)

PF7852 KIT

Set of 2 Fuel Elements



Fits: Ford Vans
Replaces: Ford 4C2Z-9N184-BA; International
1845626-C91; Motorcraft FD4606
Primary
O.D.: 3 3/4 (95.3)
I.D.: 1 1/2 (38.1) One End
Height: 3 1/8 (79.4)
O-Ring: [2] Included
Secondary
O.D. 2 5/16
I.D. 15/16
Height 2 5/8

BF7853

Secondary Fuel Spin-on with Drain



Contains: Integral Post Seal
Fits: John Deere Engines, Equipment, Trucks
Replaces: John Deere RE522688
Thread: 7/8 -14
O.D.: 4 1/4 (108.0)
Height: 6 11/16 (169.9)
I.Gskt: [1] Included

BF7855

In-Line Fuel Filter



Replaces: Stihl 3503500; Woodgate WGF9310
O.D.: 13/16 (20.6)
Inlet: 1/4
Outlet: 1/4
Length: 1 3/4 (44.5)

BF7857

In-Line Fuel Filter with Felt Wrap



Replaces: Partner 506096001;
Woodgate WGF9326
O.D.: 27/32 (21.4)
Inlet: 3/16
Outlet: 3/16
Length: 1 7/16 (36.5)

BF7859

In-Line Fuel/Water Separator with Drain



Contains: 5/16 Inch Return Line
Replaces: Honda 17670-ZG3-901;
Woodgate WGF9373
O.D.: 2 1/16 (52.4)
Inlet: 5/16
Outlet: 11/32
Length: 4 17/32 (115.1)

BF7860

In-Line Fuel Filter with Felt Wrap



Replaces: Woodgate WGF9383
O.D.: 25/32 (19.8)
Inlet: 5/32
Outlet: 5/32
Length: 1 5/8 (41.3)

BF7861

In-Line Fuel Filter



Replaces: Woodgate WGF9384
O.D.: 1 1/8 (28.6)
Inlet: 5/16
Outlet: 5/16
Length: 3 3/32 (78.6)

BF7863

In-Line Mesh Fuel Filter



Fits: Hatz Engines
Replaces: Woodgate WGF9149
O.D.: 2 1/16 (52.4)
Inlet: 1/4 or 5/16 In. Universal
Outlet: 1/4 or 5/16 In. Universal
Length: 4 3/4 (120.7)

BF7864

Plastic In-Line Fuel Filter



Fits: Ford Lawn & Garden Tractors
Replaces: Briggs & Stratton 298090;
Woodgate WGF9334
O.D.: 1 5/16 (33.3)
Inlet: 5/16
Outlet: 5/16
Length: 1 3/4 (44.5)

BF7865

Plastic In-Line Fuel Filter



Replaces: M.A.N. 81.12503.0056;
Woodgate WGF31-2
O.D.: 1 3/16 (30.2) to 1 3/8 (34.9)
Inlet: 5/16
Outlet: 5/16
Length: 4 7/32 (107.2)

BF7866

Wire Mesh Fuel Strainer with Bail Handle



Fits: Bobcat Excavators
Replaces: Deutz 1319869;
Fleetguard FF5584; Woodgate WGF9069
O.D.: 3 5/16 (84.1)
I.D.: 17/32 (13.5)
Height: 4 21/32 (118.3)
Grommets: [2] Attached

Measurements Are Shown In Inches And (Millimeters)

WARNING: These products can expose you to chemicals, including Diisononyl Phthalate, Carbon black extracts, Nickel, 1,3 Butadiene, Ethylene Oxide, Epichlorohydrin, which are known to the State of California to cause cancer, and Bisphenol, Ethylene Glycol, Ethylene Oxide, 1,3 Butadiene, Epichlorohydrin, which are known to the State of California to cause birth defects or other reproductive harm. For more information go to www.P65Warnings.ca.gov.

PF7869

Fuel Screen



Fits: Kobelco, Takeuchi, Terex Excavators
Replaces: Yanmar 171081-55910;
 Fleetguard FF5386; Woodgate WGF9302
O.D.: 1 3/8 (34.9)
I.D.: 15/32 (11.9) One End
Height: 2 1/32 (51.6)
O-Ring: [1] Attached

PF7875

Fuel Element



Fits: Lombardini Engines
Replaces: Lombardini 2175.108;
 Fleetguard FF5281; Woodgate WGF9322
O.D.: 1 31/32 (50.0)
I.D.: 3/8 (9.5) & 9/16 (14.3)
Height: 2 1/16 (52.4)

BF7870

Can-Type Fuel Filter



Replaces: Renault 5000811111;
 Fleetguard FF5048; Woodgate WGF156
O.D.: 3 15/32 (88.1)
I.D.: 29/32 (23.0) & 1 9/32 (32.5)
Height: 4 (101.6)
F. Gskt: [2] Included
O-Ring: [1] Included

PF7876

Fuel Element



Contains: [2] Threaded Bolts
Fits: Komatsu PC02-1 Excavators
Replaces: Yanmar 114350-55120;
 Woodgate WGF9325
O.D.: 1 9/16 (39.7)
I.D.: 5/8 (7.9) One End
Height: 6 5/32 (156.4)
A. Gskt: [1] Included
Related To: PF7826 (Short Version)
 PF7828 (Long Version)

BF7871

Can-Type Fuel Filter



Fits: M.A.N. Trucks
Replaces: Renault 5000043443;
 Woodgate WGF5049
O.D.: 3 15/32 (88.1)
I.D.: 29/32 (23.0) & 1 9/32 (32.5)
Height: 2 25/32 (70.6)
F. Gskt: [2] Included
O-Ring: [1] Included

PF7877

Fuel Element



Fits: Yanmar Engines, Generators
Replaces: Yanmar 105370-55710;
 Woodgate WGF9374
O.D.: 1 3/16 (30.2)
I.D.: 5/8 (7.9) One End
Height: 3 13/32 (86.5)
O-Ring: [1] Attached

PF7872

Fuel Element



Fits: Hatz Engines; Wacker Equipment
Replaces: Bomag 5723413;
 Woodgate WGF9300
O.D.: 1 17/32 (38.9)
I.D.: 9/16 (14.3)
Height: 5 11/32 (135.7)
Grommets: [2] Attached

PF7878

Fuel Element



Fits: M.A.N. Trucks
Replaces: Mann & Hummel PU855X;
 Fleetguard FF5481
O.D.: 3 (76.2)
I.D.: 7/16 (11.1) & 1 1/32 (26.2)
Height: 9 3/32 (231.0)
O-Ring: [1] Included
Grommets: [1] Attached

PF7873

Fuel Element



Fits: Yanmar Engines
Replaces: Yanmar 104200-55710;
 Fleetguard FF5170; Woodgate WGF9062
O.D.: 1 3/8 (34.9)
I.D.: 1/2 (12.7) One End
Height: 1 3/4 (44.5)
O-Ring: [1] Attached

BF7879

Fuel Spin-on



Notes: CAUTION: Furnished O-Ring must be installed on post for seal.
Fits: Cummins Marine Engines
Replaces: Cummins 3890017;
 Fleetguard FF5285
Thread: 13/16 -18
O.D.: 3 11/16 (93.7)
Height: 5 13/32 (137.3)
I.Gskt: G401
O-Ring: [1] Included
Related To: BF1280 (with Drain)

PF7874

Fuel Element



Fits: Lombardini Engines
Replaces: Lombardini 2175.112;
 Fleetguard FF5280; Woodgate WGF9321
O.D.: 1 5/8 (41.3)
I.D.: 3/8 (9.5) & 9/16 (14.3)
Height: 2 1/16 (52.4)

BF7880

Fuel Spin-on



Fits: Ruggerini Engines
Replaces: Ruggerini 17520;
 Woodgate WGF9362
Thread: M16 x 1.5
O.D.: 2 31/32 (75.4)
Height: 2 31/32 (75.4)
I.Gskt: [1] Included

Measurements Are Shown In Inches And (Millimeters)

WARNING: These products can expose you to chemicals, including Diisononyl Phthalate, Carbon black extracts, Nickel, 1,3 Butadiene, Ethylene Oxide, Epichlorohydrin, which are known to the State of California to cause cancer, and Bisphenol, Ethylene Glycol, Ethylene Oxide, 1,3 Butadiene, Epichlorohydrin, which are known to the State of California to cause birth defects or other reproductive harm. For more information go to www.P65Warnings.ca.gov.

BF7881



Box-Style Fuel Filter with Bail Handle
Replaces: Case 336430-A1; Separ 53050;
 Woodgate WGFS5305
Length: 2 31/32 (75.4)
Width: 2 31/32 (75.4)
Height: 2 1/8 (54.0)

PF7882



Nylon Mesh Fuel Screen with Lid
Contains: [1] Bolt
Replaces: M.A.N. 81.12106.0004;
 Woodgate WGF9370
O.D.: 1 7/32 (31.0)
 Lid 1 5/8 (41.3)
I.D.: 3/16 (4.8) & 1 1/16 (27.0)
Height: 15/16 (23.8)
O-Ring: [1] Included

BF7883



Fuel Spin-on
Fits: Volvo Excavators, Loaders,
 Motor Graders
Replaces: Volvo 11708555
Thread: M16 x 1.5
O.D.: 3 11/16 (93.7)
Height: 4 3/8 (111.1)
I.Gskt: G381-A

BF7886



Fuel Spin-on
Notes: External Post Seal Included.
Fits: Renault Engines, Trucks
Replaces: Mann WK940-20;
 Renault 5001853860, 5010412350
Thread: M18 x 1.5
O.D.: 3 11/16 (93.7)
Height: 5 5/8 (142.9)
I.Gskt: [1] Included
F. Gskt: [1] Included

BF7888



Fuel Spin-on
Fits: Volvo Equipment
Replaces: Volvo 11711074
Thread: M16 x 1.5
O.D.: 3 11/16 (93.7)
Height: 5 13/32 (137.3)
I.Gskt: G401

PF7889



Fuel Element with Bail Handle
Contains: Emergency By-Pass Tab
Fits: Racor 900 Series Housings
Replaces: Racor 2040 Series
O.D.: 4 5/16 (109.5)
I.D.: 5/8 (15.9) & 13/16 (20.6)
Height: 3 29/32 (99.2)
F. Gskt: G240
O-Ring: [1] Included
End Seals: [1] Included
Related To: PF7889-10, PF7889-30 (Media
 Difference)

PF7889-10

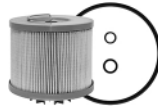

Fuel Element with Bail Handle
Contains: Emergency By-Pass Tab
Fits: Racor 900 Series Housings
Replaces: Racor 2040 Series
O.D.: 4 5/16 (109.5)
I.D.: 5/8 (15.9) & 13/16 (20.6)
Height: 3 29/32 (99.2)
F. Gskt: G240
O-Ring: [1] Included
End Seals: [1] Included
Related To: PF7889, PF7889-30 (Media
 Difference)

PF7889-30

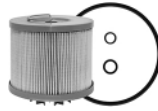

Fuel Element with Bail Handle
Contains: Emergency By-Pass Tab
Fits: Racor 900 Series Housings
Replaces: Racor 2040 Series
O.D.: 4 5/16 (109.5)
I.D.: 5/8 (15.9) & 13/16 (20.6)
Height: 3 29/32 (99.2)
F. Gskt: G240
O-Ring: [1] Included
End Seals: [1] Included
Related To: PF7889, PF7889-10 (Media
 Difference)

PF7890



Fuel/Water Separator Element with Bail Handle
Contains: Emergency By-Pass Tab
Fits: Racor 1000FH Series Housings
Replaces: Racor 2020 Series
O.D.: 4 5/16 (109.5)
I.D.: 5/8 (15.9) & 13/16 (20.6)
Height: 8 29/32 (226.2)
F. Gskt: G240 & [1] Included
O-Ring: [1] Included
Related To: PF7890-10, PF7890-30 (Media
 Difference)

PF7890-10



Fuel/Water Separator Element with Bail Handle
Contains: Emergency By-Pass Tab
Fits: Racor 1000FH Series Housings
Replaces: Racor 2020 Series
O.D.: 4 5/16 (109.5)
I.D.: 5/8 (15.9) & 13/16 (20.6)
Height: 8 29/32 (226.2)
F. Gskt: G240 & [1] Included
O-Ring: [1] Included
Related To: PF7890, PF7890-30 (Media
 Difference)

PF7890-30



Fuel/Water Separator Element with Bail Handle
Contains: Emergency By-Pass Tab
Fits: Racor 1000FH Series Housings
Replaces: Racor 2020 Series
O.D.: 4 5/16 (109.5)
I.D.: 5/8 (15.9) & 13/16 (20.6)
Height: 8 29/32 (226.2)
F. Gskt: G240 & [1] Included
O-Ring: [1] Included
Related To: PF7890, PF7890-10 (Media
 Difference)

BF7892



Fuel Spin-on
Fits: Komatsu Equipment
Replaces: Komatsu 600-311-8222
Thread: 3/4 -16
O.D.: 3 1/32 (77.0)
Height: 4 3/32 (104.0)
I.Gskt: G449-B

Measurements Are Shown In Inches And (Millimeters)

! WARNING: These products can expose you to chemicals, including Diisononyl Phthalate, Carbon black extracts, Nickel, 1,3 Butadiene, Ethylene Oxide, Epichlorohydrin, which are known to the State of California to cause cancer, and Bisphenol, Ethylene Glycol, Ethylene Oxide, 1,3 Butadiene, Epichlorohydrin, which are known to the State of California to cause birth defects or other reproductive harm. For more information go to www.P65Warnings.ca.gov.

PF7894 Fuel/Water Separator Element with Relief Valve
Fits: Davco FH230 Fuel Pro, 233 Series, FH233 Diesel Pro Series Housings, 382 Series Housings
Replaces: Davco 102529; Fleetguard FS19761
O.D.: 3 13/16 (96.8)
I.D.: 21/32 (16.7) One End
Height: 7 1/32 (178.6)
O-Ring: [3] Included
Grommets: [1] Attached



PF7895 Fuel/Water Separator Element with Relief Valve
Fits: Davco FH230 Series, 233 Series, FH233 Series, 382 Series Housings
Replaces: Fleetguard FS19727
O.D.: 3 13/16 (96.8)
I.D.: 21/32 (16.7) One End
Height: 7 1/32 (178.6)
O-Ring: [3] Included
Grommets: [1] Attached



PF7896 Fuel Element
Fits: Scania Generator Sets, Trucks
Replaces: Scania 1446432; Fleetguard FF5423
O.D.: 3 5/16 (84.9)
I.D.: 1 3/8 (34.9) One End
Height: 7 7/32 (183.4)
O-Ring: [1] Included



BF7898-D Secondary Fuel/Water Separator Element with Drain
Fits: Caterpillar Skid Steer Loaders
Replaces: Caterpillar 223-0702
O.D.: 3 9/32 (83.3)
I.D.: 21/32 (16.7) One End
Height: 7 5/8 (193.7)
Grommets: [1] Attached



PF7899 Fuel Element
Contains: Viton O-Ring for high heat applications.
Fits: Perkins Engines
Replaces: Perkins CH10930, 996453
O.D.: 4 19/32 (116.7)
I.D.: 2 5/32 (54.8) One End
Height: 9 9/32 (235.7)
O-Ring: [1] Viton Included



PF7900 Fuel Element
Contains: Viton O-Ring for high heat applications.
Fits: Perkins Engines
Replaces: Perkins CH10931, 996454
O.D.: 4 29/32 (124.6)
I.D.: 2 1/16 (52.4) One End
Height: 10 5/16 (261.9)
O-Ring: [1] Viton Included



BF7903 In-Line Fuel Filter
Fits: Aston Martin, BMW, Fiat, Peugeot Automotive; Poulan Lawn Tractors
Replaces: Hastings GF95; Wix 33011
O.D.: 1 13/32 (35.7)
Inlet: 1/4
Outlet: 1/4
Length: 4 5/32 (105.6)



BF7904-D Secondary Fuel/Water Separator Element with Drain
Notes: Reverse Flow
 Tab/Keys are not needed for installation.
Fits: John Deere Engines, Equipment
Replaces: John Deere RE50820
O.D.: 3 3/8 (85.7)
I.D.: 11/16 (17.5) One End
Height: 6 1/32 (153.2)
Grommets: [1] Attached



BF7905-D Secondary Fuel/Water Separator Element with Drain
Notes: Tab/Keys are not needed for installation.
Fits: Kubota Engines; Volvo Loaders
Replaces: Omnicup 8320269; Volvo 11711183
O.D.: 3 9/32 (83.3)
I.D.: 21/32 (16.7) One End
Height: 5 31/32 (151.6)
Grommets: [1] Attached



BF7906-D Secondary Fuel/Water Separator Element with Drain
Notes: Reverse Flow
 Tab/Keys are not needed for installation.
Fits: Caterpillar Equipment
Replaces: Caterpillar 233-9856
O.D.: 3 9/32 (83.3)
I.D.: 21/32 (16.7) One End
Height: 5 31/32 (151.6)
Grommets: [1] Attached



BF7907 Fuel Spin-on
Contains: Integral Post Seal
Fits: Volvo Excavators
Replaces: Volvo 11713240, 14520542, 14520578
Thread: M20 x 1.5
O.D.: 3 11/16 (93.7)
Height: 5 5/8 (142.9)
I.Gskt: G324-A



BF7908 Fuel Spin-on
Fits: Generator Sets with Scania DC12 Engine, Trucks
Replaces: Scania 1411894; Fleetguard FF5424
Thread: M24 x 1.5
O.D.: 3 11/16 (93.7)
Height: 5 21/32 (143.7)
I.Gskt: [1] Included



BF7909 Fuel Spin-on
Fits: Deutz Engines; Volvo Loaders
Replaces: KHD Deutz 1052175138; Volvo 2900777
Thread: M16 x 1.5
O.D.: 3 1/32 (77.0)
Height: 2 27/32 (72.2)
I.Gskt: G449-B



Measurements Are Shown In Inches And (Millimeters)

WARNING: These products can expose you to chemicals, including Diisononyl Phthalate, Carbon black extracts, Nickel, 1,3 Butadiene, Ethylene Oxide, Epichlorohydrin, which are known to the State of California to cause cancer, and Bisphenol, Ethylene Glycol, Ethylene Oxide, 1,3 Butadiene, Epichlorohydrin, which are known to the State of California to cause birth defects or other reproductive harm. For more information go to www.P65Warnings.ca.gov.

PF7910



Fuel Element with Bail Handle
Fits: Daewoo Excavators
Replaces: Daewoo 65125035001; Donaldson P550860
O.D.: 2 5/16 (58.7)
I.D.: 1/2 (12.7)
Height: 4 13/32 (111.9)
F. Gskt: [1] Included
Grommets: [1] Attached

PF7916



Fuel Element
Fits: Volvo Excavators
Replaces: Volvo 11708554, 11988962, VOE11988962
O.D.: 2 7/8 (73.0)
I.D.: 3/8 (9.5) & 1 7/16 (36.5)
Height: 3 7/8 (98.4)
A. Gskt: [2] Attached
O-Ring: [1] Included

BF7911



Wire Mesh Supported Maximum Performance Glass Fuel Spin-on
Contains: Integral Post Seal
Replaces: Donaldson P550218; Fleetguard FF5347
Thread: 7/8 -16
O.D.: 4 1/4 (108.0)
Height: 7 11/32 (186.5)
I.Gskt: G381-A

BF7917



Fuel Spin-on
Notes: CAUTION: Furnished O-Ring must be installed on post for seal.
Contains: Integral Post Seal
Fits: Cummins Engines; Hyundai Equipment
Replaces: Cummins 3973232; Fleetguard FF5580
Thread: 7/8 -14
O.D.: 3 11/16 (93.7)
Height: 7 1/8 (181.0)
I.Gskt: G381-A
O-Ring: [1] Included

BF7912



Box-Style Fuel Element with Bail Handle
Fits: M.A.N. Trucks; Volvo Excavators
Replaces: Deutz 01319822; Volvo 14514238; Fleetguard FS19605
Length: 3 15/32 (88.1)
Width: 3 7/16 (87.3)
Height: 2 1/8 (54.0)
A. Gskt: [1] Attached

BF7919



Fuel Spin-on
Fits: John Deere Crawler Dozers, Crawler Loaders
Replaces: John Deere AT279824
Thread: M16 x 1.5
O.D.: 3 11/16 (93.7)
Height: 5 1/4 (133.4)
I.Gskt: G381-A
F. Gskt: [1] Included

BF7913



High Efficiency Fuel Spin-on
Contains: Integral Post Seal
Fits: Komatsu Equipment
Replaces: Komatsu 600-311-3310, 600-311-3510, 600-319-3510
Thread: 1 1/4 -12
O.D.: 4 21/32 (118.3)
Height: 11 7/32 (285.0)
I.Gskt: [1] Included

BF7921



Fuel/Water Separator Spin-on with Drain
Fits: New Holland Loaders
Replaces: New Holland 87803264
Thread: M16 x 1.5
O.D.: 3 1/32 (77.0)
Height: 5 11/16 (144.5)
I.Gskt: G449-B

PF7914



Water Absorbing Fuel Storage Tank Element
Fits: Fuel Storage Tanks
Replaces: Cim-Tek EHS10, 30033; Fleetguard FS19751; Wix 24841
O.D.: 4 19/32 (116.7)
I.D.: 9/16 (14.3) & 1 3/32 (27.8)
Height: 9 5/16 (236.5)
F. Gskt: [2] Included, [1] Metal Washer
Grommets: [1] Attached

BF7922



Fuel Spin-on
Notes: CAUTION: Furnished O-Ring must be installed on post for seal.
Fits: Case; Case-International, New Holland Equipment
Replaces: Case 87803200; Fleetguard FF5612
Thread: M20 x 1.5
O.D.: 3 11/16 (93.7)
Height: 7 7/32 (183.4)
A. Gskt: G401
F. Gskt: [1] Included

BF7915



Fuel Spin-on
Fits: Hatz Engines
Replaces: Hatz 50251500; Donaldson P550345; Fleetguard FF5040
Thread: M16 x 1.5
O.D.: 3 1/32 (77.0)
Height: 2 27/32 (72.2)
A. Gskt: G449-B
Related To: BF790 Tall Version

BF7923



Fuel Spin-on
Contains: Integral Post Seal
Fits: John Deere 600C LC Excavator
Replaces: John Deere AT308578
Thread: 1 -14
O.D.: 3 11/16 (93.7)
Height: 6 11/16 (169.9)
I.Gskt: G401

Measurements Are Shown In Inches And (Millimeters)

! WARNING: These products can expose you to chemicals, including Diisononyl Phthalate, Carbon black extracts, Nickel, 1,3 Butadiene, Ethylene Oxide, Epichlorohydrin, which are known to the State of California to cause cancer, and Bisphenol, Ethylene Glycol, Ethylene Oxide, 1,3 Butadiene, Epichlorohydrin, which are known to the State of California to cause birth defects or other reproductive harm. For more information go to www.P65Warnings.ca.gov.

BF7924

Fuel Spin-on



Notes: CAUTION: Furnished D-Ring must be installed on post for seal.
Contains: Integral Post Seal
Fits: Freightliner, Kenworth, Peterbilt Trucks
Replaces: Cummins 4940647; Fleetguard FF5636
Thread: 7/8 -14
O.D.: 3 23/32 (94.5)
Height: 7 5/32 (181.8)
I.Gskt: G381-A
O-Ring: [1] Included

BF7925

Fuel/Water Separator Spin-on with Drain



Notes: Use with Conversion Adapter FD7926 on first installation only. See Form 349 for installation instructions.
Fits: Bobcat, Caterpillar, Gehl, J.C. Bamford, Manitou, Massey Ferguson, Terex Equipment
Replaces: Caterpillar 1R1804; Gehl 184223, J.C. Bamford 32/925423; Massey Ferguson 4224811M1; Perkins 934181, 26560201
Thread: M24 x 2.0
O.D.: 3 11/16 (93.7)
Height: 6 5/32 (156.4)
I.Gskt: G381-A

FD7926

Fuel Filter Adapter



Notes: Converts base from element/housing to spin-on.
Contains: [1] Tube Saf-T-Lok
Use With: BF7925
Replaces: Caterpillar 1R1804; Gehl 184223, J.C. Bamford 32/925423; Massey Ferguson 4224811M1; Perkins 934181, 26560201
Thread: M24 x 2.0
O.D.: 3 3/8 (85.7)
Length: 1 1/2 (38.1)
O-Ring: [1] Included

BF7927

Fuel Spin-on



Fits: Case-International, New Holland Equipment; Iveco Trucks
Replaces: Case 84818745; Iveco 500315480, 2994048; New Holland 1931108
Thread: M16 x 1.5
O.D.: 4 1/4 (108.0)
Height: 7 (177.8)
I.Gskt: G401

PF7928

Fuel Element



Contains: Relief Valve
Fits: Davco FH230, FH234, DI9100 Housings
Replaces: Davco 102011, 102526, Fleetguard FS19763
O.D.: 4 3/16 (106.4)
I.D.: 2 1/32 (16.7) One End
Height: 7 1/32 (178.6)
O-Ring: [2] Included
Grommets: [1] Attached

BF7929 KIT

Set of 2 Fuel Filters



Contains: [1] Element
 [1] Spin-on with Drain
Fits: John Deere Equipment
Replaces: John Deere RE520906, RE523236, RE525523, RE541747; SF-Filter SK3188-SET
Spin-on
Thread: 1 -14
O.D.: 4 5/16 (109.5)
Height: 6 25/32 (172.2)
I.Gskt: [1] Included
Element
O.D. 3 23/32
I.D. 1 19/32
Height 6 9/32
O-Ring [1] Included

PF7930

Fuel/Water Separator Element



Contains: Relief Valve
Fits: Davco FH230 Series Fuel Pro, FH234 Series Industrial Pro
Replaces: Davco 102528; Paccar 382951PAC25; Volvo 21737499, 85120233; Fleetguard FS19765
O.D.: 4 3/16 (106.4)
I.D.: 2 1/32 (16.7) One End
Height: 6 15/16 (176.2)
O-Ring: [2] Included
Grommets: [1] Attached

BF7931

Fuel Spin-on



Fits: Equipment and Trucks with Various Deutz Diesel Engines
Replaces: Deutz 1174423
Thread: M16 x 1.5
O.D.: 3 1/32 (77.0)
Height: 4 27/32 (123.0)
I.Gskt: [1] Included

BF7932

Fuel Spin-on



Fits: Cummins QSK 19 (Tier 3) Engine
Replaces: Cummins 4964100; Fleetguard FF5607, FF5634, FF5644
Thread: 2 1/4 -12
O.D.: 4 21/32 (118.3)
Height: 10 5/16 (261.9)
I.Gskt: [1] Included
Related To: BF46002 (Upgrade)

PF7934 KIT

Set of 2 Fuel Elements



Contains: [1] Primary Fuel Element
 [1] Secondary Fuel Element
Fits: Ford Super Duty Pickups with V8-391 (6.4L) DI Turbo Diesel Engine
Replaces: Ford 8C3Z-9N184-A; Motorcraft FD4609; Wix 33950
Primary
O.D.: 3 5/16 (84.9)
I.D.: 1 19/32 (40.5)
Height: 4 13/32 (111.9)
O-Ring: [2] Included
Secondary
O.D. 3 9/16
I.D. 3/4
Height 4 23/32

Measurements Are Shown In Inches And (Millimeters)

WARNING: These products can expose you to chemicals, including Diisononyl Phthalate, Carbon black extracts, Nickel, 1,3 Butadiene, Ethylene Oxide, Epichlorohydrin, which are known to the State of California to cause cancer, and Bisphenol, Ethylene Glycol, Ethylene Oxide, 1,3 Butadiene, Epichlorohydrin, which are known to the State of California to cause birth defects or other reproductive harm. For more information go to www.P65Warnings.ca.gov.

PF7935



Fuel Element

Fits: M.A.N. Trucks
Replaces: M.A.N. 51.12503.0061, 51.12503.0063; Donaldson P785373; Fleetguard FF5629
O.D.: 3 3/4 (95.3)
I.D.: 9/16 (14.3) & 1 13/16 (46.0)
Height: 6 27/32 (173.8)
A. Gskt: [1] Attached
O-Ring: [1] Included
Grommets: [2] Attached

BF7941



Fuel/Water Separator Spin-on with Sensor Port

Contains: Integral Post Seal
 Sensor Port Thread: M10 x 1.5
Fits: Cummins ISBE Engine; DAF Trucks
Replaces: DAF 1437070; Fleetguard FS19584
Thread: M20 x 1.5
O.D.: 3 23/32 (94.5)
Height: 7 9/32 (184.9)
I.Gskt: G381-A

PF7936



Fuel Element

Fits: Scania Trucks
Replaces: Scania 1459762; Donaldson P550653; Fleetguard FF5463, FF5684
O.D.: 3 13/32 (86.5)
I.D.: 1 1/2 (38.1) One End
Height: 7 7/32 (183.4)
O-Ring: [1] Included
Grommets: [1] Attached

BF7942



Fuel/Water Separator Spin-on with Sensor Port

Contains: Integral Post Seal
 Sensor Port Thread: M14 x 2.0
Fits: Cummins ISBE Engine; DAF, Kenworth, Peterbilt Trucks
Replaces: DAF 1618993; Fleetguard FS19689
Thread: M20 x 1.5
O.D.: 3 23/32 (94.5)
Height: 7 5/16 (185.7)
I.Gskt: G381-A

BF7937



In-Line Fuel Filter

Contains: 5/16 Inch Return Line
Fits: Chevrolet, GMC Light-Duty Trucks
Replaces: GMC 15077584; Wix 33100
O.D.: 2 11/32 (59.5)
Inlet: 3/8
Outlet: 3/8
Length: 7 1/2 (190.5)

BF7943



Fuel Spin-on

Fits: Mack, Volvo Trucks
Replaces: Mack 20972295; Volvo 20972293
Thread: M32 x 1.5
O.D.: 4 1/4 (108.0)
Height: 10 15/32 (265.9)
I.Gskt: [1] Included

PF7938



Fuel Element

Fits: R.V.I., Volvo Trucks
Replaces: Deutz 2931530, 4901031; Renault 2931711, 7420796772, 7420998806; Volvo 2931712, 20796775, 20998805
O.D.: 3 23/32 (94.5)
I.D.: 1 7/8 (47.6) One End
Height: 6 3/8 (161.9)
O-Ring: [1] Included

BF7944



In-Line Fuel Filter

Contains: [2] Plastic Caps
Fits: Cushman Equipment
Replaces: Jacobsen 2701898; Suzuki 15410-72F01
O.D.: 2 3/4 (69.9)
Inlet: 3/8
Outlet: 3/8
Length: 4 1/4 (108.0)

PF7939



Nylon Screen Fuel Element

Fits: Freightliner, M.A.N., Sterling Trucks
Replaces: M.A.N. 51.12503.0062; Freightliner 902051; Mercedes-Benz 902051, A0000902051
O.D.: 1 31/32 (50.0)
I.D.: 29/32 (23.0) & 1 19/32 (40.5)
Height: 1 5/8 (41.3)
O-Ring: [1] Included
Related To: PF7974 (Different O-Ring)

BF7945



In-Line Fuel Filter

Fits: Hyundai Automotive
Replaces: GMC 25313807; Hyundai 31911-29000
O.D.: 2 3/4 (69.9)
Inlet: M14 x 1.5
Outlet: 7/16
Length: 4 1/8 (104.8)

BF7940



Fuel Spin-on

Notes: CAUTION: Furnished End Seal must be installed on post for seal.
Contains: Integral Post Seal
Fits: Ford, Freightliner, Kenworth, Peterbilt, Sterling Trucks; Cummins ISB Engine
Replaces: Cummins 4934845; Fleetguard FF5632
Thread: M20 x 1.5
O.D.: 3 11/16 (93.7)
Height: 7 7/32 (183.4)
A. Gskt: G401
F. Gskt: [1] Included

PF7946



Fuel Element

Fits: DAF Trucks
Replaces: DAF 1450184
O.D.: 3 9/16 (90.5)
I.D.: 3/4 (19.1) & 1 7/8 (45.3)
Height: 9 3/4 (247.7)
O-Ring: [1] Included

Measurements Are Shown In Inches And (Millimeters)

WARNING: These products can expose you to chemicals, including Diisononyl Phthalate, Carbon black extracts, Nickel, 1,3 Butadiene, Ethylene Oxide, Epichlorohydrin, which are known to the State of California to cause cancer, and Bisphenol, Ethylene Glycol, Ethylene Oxide, 1,3 Butadiene, Epichlorohydrin, which are known to the State of California to cause birth defects or other reproductive harm. For more information go to www.P65Warnings.ca.gov.

PF7947



Fuel Element

Fits: DAF Engines, Trucks
Replaces: DAF 1616361, 1643080, 1699168
O.D.: 3 9/16 (90.5)
I.D.: 3/4 (19.1) & 1 3/4 (44.5)
Height: 9 13/16 (249.2)
O-Ring: [1] Included
Grommets: [2] Attached

BF7952-D



Secondary Fuel/Water Separator Element with Removable Drain

Fits: John Deere Tractors
Replaces: John Deere RE522868
O.D.: 3 1/2 (88.9)
I.D.: 1 5/32 (29.4) One End
Height: 6 (152.4)
Grommets: [1] Attached

BF7948



Fuel Spin-on

Contains: Integral Post Seal
Fits: Komatsu Equipment
Replaces: Komatsu 600-319-3520, 600-319-3550
Thread: 1 5/8 -12
O.D.: 4 11/16 (119.1)
Height: 11 9/32 (286.5)
I.Gskt: [1] Included

BF7954-D



Primary Fuel/Water Separator Element with Removable Drain

Fits: Case, Case-International, John Deere, New Holland Equipment
Replaces: Case 87803445; New Holland 87803444
O.D.: 3 1/2 (88.9)
I.D.: 1 5/32 (29.4) One End
Height: 5 3/4 (146.1)
Grommets: [1] Attached

BF7949-D



Secondary Fuel/Water Separator Element with Removable Drain

Fits: John Deere Equipment
Replaces: John Deere RE522878
O.D.: 3 1/2 (88.9)
I.D.: 1 5/32 (29.4) One End
Height: 7 21/32 (194.5)
Grommets: [1] Attached

BF7955



Fuel Spin-on

Fits: Liebherr Equipment
Replaces: Liebherr 7382045; Fleetguard FF5427
Thread: M16 x 1.5
O.D.: 3 23/32 (94.5)
Height: 5 3/8 (136.5)
I.Gskt: G381-A
F. Gskt: [1] Included

BF7949-DM



Secondary Fuel Element with Drain Plug

Fits: John Deere PowerTech 6068TFM (6.8L) Marine Engine
Replaces: John Deere RE521538
O.D.: 3 5/16 (84.1)
I.D.: 1 5/32 (29.4) One End
Height: 7 11/32 (186.5)
F. Gskt: [1] Included
Grommets: [1] Attached

BF7956-D



Primary Fuel/Water Separator Element with Removable Drain

Fits: J.C. Bamford Equipment with 444 Diesel Max Engine
Replaces: J.C. Bamford 32/925694
O.D.: 3 1/2 (88.9)
I.D.: 1 5/32 (29.4) One End
Height: 5 (127.0)
Grommets: [1] Attached

BF7950-D



Primary Fuel/Water Separator Element with Removable Drain

Fits: John Deere Equipment
Replaces: John Deere RE529643
O.D.: 3 1/2 (88.9)
I.D.: 1 5/32 (29.4) One End
Height: 7 21/32 (194.5)
Grommets: [1] Attached

BF7957



Fuel Spin-on

Contains: Integral Post Seal
Fits: Komatsu Equipment
Replaces: Komatsu 6754-79-6130, 6754-79-6140
Thread: M20 x 1.5
O.D.: 3 11/16 (93.7)
Height: 6 23/32 (170.7)
I.Gskt: G401
F. Gskt: [1] Included

BF7951-D



Secondary Fuel/Water Separator Element with Removable Drain

Fits: Agco, Case-International, J.C. Bamford, Massey Ferguson, New Holland, Valtra Equipment; Iveco Engines
Replaces: Iveco 504107584
O.D.: 3 1/2 (88.9)
I.D.: 1 5/32 (29.4) One End
Height: 7 3/8 (187.3)
Grommets: [1] Attached

BF7958



In-Line Fuel Filter with Drain

Fits: Volkswagen Automotive
Replaces: Volkswagen 1J0127401A, 1J0127401B; Wix 33619
O.D.: 3 15/32 (88.1)
Inlet: 5/16
Outlet: 5/16
Length: 7 13/16 (198.4)
O-Ring: [2] Included

BF7959



In-Line Fuel Filter

Contains: 5/16 Inch Return Line
Fits: Kia Automotive
Replaces: Kia K2A1-20-490A, OK2A11-20-490A; Wix 33598
O.D.: 2 23/32 (69.1)
Inlet: 5/16
Outlet: 5/16
Length: 6 3/16 (157.2)

Measurements Are Shown In Inches And (Millimeters)

WARNING: These products can expose you to chemicals, including Diisononyl Phthalate, Carbon black extracts, Nickel, 1,3 Butadiene, Ethylene Oxide, Epichlorohydrin, which are known to the State of California to cause cancer, and Bisphenol, Ethylene Glycol, Ethylene Oxide, 1,3 Butadiene, Epichlorohydrin, which are known to the State of California to cause birth defects or other reproductive harm. For more information go to www.P65Warnings.ca.gov.

BF7960

In-Line Fuel Filter



Fits: Ford, Mazda Light-Duty Trucks
Replaces: Ford XF5Z-9155-AA, XL5E-9155-AB; Mazda ZZP1-13-470, ZZR0-13-470
O.D.: 2 7/32 (56.4)
Inlet: 3/8
Outlet: 5/16
Length: 7 3/32 (180.2)

BF7961

In-Line Fuel Filter



Fits: Toyota Light-Duty Trucks
Replaces: Toyota 23030-62010; Wix 33236
O.D.: 2 17/32 (64.3)
Inlet: M14 x 1.5
Outlet: M14 x 1.5
Length: 3 3/4 (95.3)

BF7962

In-Line Fuel Filter



Contains: 5/16 Inch Return Line
Fits: Kia Automotive
Replaces: Kia K32A-20-490; ACDelco GF782
O.D.: 2 13/16 (71.4)
Inlet: 5/16
Outlet: 5/16
Length: 7 1/16 (179.4)

BF7963

In-Line Fuel Filter



Fits: 1999-2004 Chevrolet Tracker
Replaces: GMC 30020673; ACDelco GF826
O.D.: 2 15/16 (74.6)
Inlet: 5/16
Outlet: 5/16
Length: 5 1/4 (133.4)

BF7964-D

Secondary Fuel/Water Separator Element with Removable Drain



Notes: Reverse Flow
 Tab/Keys are not needed for installation.
Replaces: Ford 2C11-9176-AA, 4386518; Motorcraft EFG331
O.D.: 3 9/32 (83.3)
I.D.: 2 1/32 (16.7) One End
Height: 6 25/32 (172.2)
Grommets: [1] Attached

BF7965

In-Line Fuel/Water Separator with Drain



Fits: J.C. Bamford Equipment
Replaces: J.C. Bamford 320/07057, 320/07155; Donaldson P765325
O.D.: 3 3/8 (85.7)
Inlet: 5/16
Outlet: 3/8
Length: 7 (177.8)

BF7966

Fuel Spin-on



Notes: CAUTION: Furnished O-Ring must be installed on post for seal.
Fits: Freightliner S2 Bus Chassis; Kawasaki 70ZV Loader; Kenworth Trucks
Replaces: Cummins 3978040, 4897897; Fleetguard FF5421
Thread: M20 x 1.5
O.D.: 3 11/16 (93.7)
Height: 7 7/32 (183.4)
I.Gskt: G381-A
F. Gskt: [1] Included

BF7967

Fuel Spin-on



Fits: Hino Trucks
Replaces: Hino 23401-1510, S23401-1510
Thread: 3/4 -16
O.D.: 3 3/32 (78.6)
Height: 3 31/32 (100.8)
I.Gskt: [1] Included

BF7968

Fuel Spin-on



Fits: OMC Engines
Replaces: Evinrude 502905, 174144; Johnson Marine 502905, 174144
Thread: 1 -12
O.D.: 3 11/16 (93.7)
Height: 4 3/8 (111.1)
I.Gskt: G381-A

BF7968-O

Fuel/Water Separator Spin-on with Open Port for Bowl



Contains: Port Thread: 3 1/8-10 UN 1B
Fits: Racor B32012, B32014 Marine Fuel Systems
Replaces: Racor S3214
Thread: 1 -12
O.D.: 3 25/32 (96.0)
Height: 4 1/32 (102.4)
F. Gskt: [2] Included
O-Ring: [1] Included
Related To: BF7968

BF7969

Fuel Spin-on



Contains: Integral Post Seal
Fits: Volvo-Penta Marine Engines
Replaces: Volvo-Penta 38512182, 3852413, 3862228; Wix 33247
Thread: 13/16 -18
O.D.: 3 (76.2)
Height: 3 15/32 (88.1)
I.Gskt: G449-B

BF7970

Fuel Spin-on with Drain



Fits: Jeep Liberty; Iveco Light-Duty Trucks
Replaces: Chrysler 52129238AA; Iveco 2992300, 504018807; Fleetguard FS19781
Thread: M16 x 1.5
O.D.: 3 3/8 (85.7)
Height: 6 23/32 (170.7)
I.Gskt: [1] Included
Grommets: [1] Included

BF7971-D

Fuel Element with Removable Drain



Notes: Reverse Flow
Fits: John Deere Equipment
Replaces: John Deere RE522966
O.D.: 3 5/16 (84.1)
I.D.: 1 5/32 (29.4) One End
Height: 7 5/8 (193.7)
Grommets: [1] Attached

Measurements Are Shown In Inches And (Millimeters)

WARNING: These products can expose you to chemicals, including Diisononyl Phthalate, Carbon black extracts, Nickel, 1,3 Butadiene, Ethylene Oxide, Epichlorohydrin, which are known to the State of California to cause cancer, and Bisphenol, Ethylene Glycol, Ethylene Oxide, 1,3 Butadiene, Epichlorohydrin, which are known to the State of California to cause birth defects or other reproductive harm. For more information go to www.P65Warnings.ca.gov.

BF7971-DM



Primary Fuel Element with Removable Drain
Notes: Reverse Flow
Fits: John Deere PowerTech 6068TFM (6.8L) Marine Engine
Replaces: John Deere RE521540
O.D.: 3 5/16 (84.1)
I.D.: 1 5/32 (29.4) One End
Height: 7 11/32 (186.5)
A. Gskt: [1] Included
Grommets: [1] Attached

BF7972



In-Line Fuel Filter with Sensor Port
Notes: Sensor must be removed from old filter and reinstalled on BF7972.
Contains: 5/16 Inch Drainback Valve Plastic Filter Collar
Fits: Dodge, Freightliner, Mercedes-Benz Sprinter Vans; Jeep Grand Cherokee
Replaces: Chrysler 5117494AA, 5170896AA, 5170896AB, 5175429AB; Mercedes-Benz A6420920101, A6460920701
O.D.: 3 19/32 (91.3)
Inlet: 3/8
Height: 5 (127.0)
O-Ring: [2] Included

PF7973



Fuel Element
Contains: Integral Housing Lid
Fits: John Deere Engines, Equipment, Gen Sets
Replaces: John Deere RE515345
O.D.: 4 5/8 (117.5)
Lid 6 (152.4)
I.D.: 13/16 (20.6) One End
Height: 9 19/32 (243.7)
I.Gskt: [1] Included
Grommets: [1] Attached

PF7974



Nylon Screen Fuel Element
Fits: Freightliner, Sterling Trucks; Mercedes-Benz Engines
Replaces: Mercedes-Benz 901351, A0000901351; Freightliner 901351
O.D.: 1 31/32 (50.0)
I.D.: 29/32 (23.0) & 1 19/32 (40.5)
Height: 1 5/8 (41.3)
O-Ring: [1] Included
Related To: PF7939 (Different O-Ring)

PF7975



Nylon Fuel Element
Fits: Volvo Excavators
Replaces: Volvo 7412921
O.D.: 1 3/8 (34.9)
I.D.: 7/16 (11.1) One End
Height: 1 15/16 (49.2)
O-Ring: [1] Attached

BF7976



Fuel/Water Separator Spin-on with Drain
Fits: Citroen, Fiat, Peugeot Vans
Replaces: Citroen 190666, 190667; Fiat 46797378
Thread: M16 x 1.5
O.D.: 3 9/32 (83.3)
Height: 6 3/16 (157.2)
I.Gskt: [1] Included
Grommets: [1] Attached

PF7977



Fuel/Water Separator Element
Fits: Dodge Light-Duty Trucks with Cummins 5.9L Diesel Engine
Replaces: Fleetguard FS19800
O.D.: 3 3/8 (85.7)
I.D.: 13/16 (20.6) One End
Height: 4 3/32 (104.0)
O-Ring: [1] Included
Grommets: [1] Attached

PF7978



Fuel/Water Separator Element
Fits: International Engines, Trucks
Replaces: International 1878042-C91; Donaldson P550824; Fleetguard FS19947
O.D.: 3 9/32 (83.3)
I.D.: 1/2 (12.7) One End
Height: 5 7/16 (138.1)
O-Ring: [2] Included
Grommets: [1] Attached

BF7979



Fuel/Water Separator Spin-on with Drain
Notes: CAUTION: Furnished Post Seal must be installed on post for seal.
Replaces: Ashok Leyland F8835100; Fleetguard FS19636
Thread: M20 x 1.5
O.D.: 3 23/32 (94.5)
Height: 7 31/32 (202.4)
I.Gskt: G401

PF7980



Fuel/Water Separator Element
Replaces: Cummins 4084133; Fleetguard FF5511
O.D.: 5 27/32 (148.4)
I.D.: 1 3/8 (34.9)
Height: 9 7/8 (250.8)
Grommets: [2] Attached

BF7981



Fuel Spin-on with Sensor Port
Notes: CAUTION: Furnished O-Ring must be installed on post for seal.
Contains: Sensor Port Thread: M14 x 2.0
Replaces: Tata Cummins 278607989916; Fleetguard FS1275
Thread: 13/16 -18
O.D.: 3 11/16 (93.7)
Height: 6 1/8 (155.6)
I.Gskt: G401
O-Ring: [2] Included

PF7982



Fuel Element
Fits: Case, Hitachi, J.C. Bamford, John Deere, Link-Belt Excavators; Mitsubishi Trucks
Replaces: Hitachi 4642641; Isuzu 8-98008-840-0; S-F Filter SK3160
O.D.: 3 23/32 (94.5)
I.D.: 1 1/32 (26.2) One End
Height: 5 15/32 (138.9)
O-Ring: [3] Included
Grommets: [1] Attached
Related To: PF9803 (Short Version) PF7983, PF7984 (Long Versions)

Measurements Are Shown In Inches And (Millimeters)

WARNING: These products can expose you to chemicals, including Diisononyl Phthalate, Carbon black extracts, Nickel, 1,3 Butadiene, Ethylene Oxide, Epichlorohydrin, which are known to the State of California to cause cancer, and Bisphenol, Ethylene Glycol, Ethylene Oxide, 1,3 Butadiene, Epichlorohydrin, which are known to the State of California to cause birth defects or other reproductive harm. For more information go to www.P65Warnings.ca.gov.

PF7983



Fuel Element

Fits: Hitachi, John Deere Equipment
Replaces: Hitachi 4649267, 4676385; Kobelco YN21P01068R100
O.D.: 3 23/32 (94.5)
I.D.: 1 1/32 (26.2) One End
Height: 6 13/32 (162.7)
O-Ring: [2] Included
Grommets: [1] Attached
Related To: PF7982, PF9803 (Short Versions) PF7984 (Long Version) PF9868 (With Furnished O-Rings)

PF7984



Fuel Element

Fits: John Deere Excavators
Replaces: Hitachi 4679981; Isuzu 8-98074-288-0; S-F Filter SK3022
O.D.: 3 23/32 (94.5)
I.D.: 1 1/32 (26.2) One End
Height: 7 15/16 (201.6)
F. Gskt: [1] Included
O-Ring: [1] Included
Grommets: [1] Attached
Related To: PF7982, PF7983, PF9803 (Short Versions)

BF7985



Fuel/Water Separator Spin-on with Sensor Port

Notes: CAUTION: Furnished O-Ring must be installed on post for seal.
Contains: Sensor Port Thread: 1 1/4-12
Replaces: Cummins 3890063; Tata Cummins 278609119903; Fleetguard FS1299
Thread: 13/16 -18
O.D.: 3 11/16 (93.7)
Height: 5 5/16 (134.9)
I.Gskt: G401
F. Gskt: [1] Included
O-Ring: [1] Included

PF7986



Fuel Element

Fits: International Engines, Trucks
Replaces: International 3004473-C91; Donaldson P550821
O.D.: 3 23/32 (94.5)
I.D.: 1/2 (12.7) & 1 3/4 (44.5)
Height: 6 27/32 (173.8)
O-Ring: [2] Included
Grommets: [2] Attached

BF7987



Fuel Spin-on

Contains: Integral Post Seal
Fits: M.T.U. 12V2000, 16V2000, 18V2000 Engines
Replaces: M.T.U. 20920601; Fleetguard FF5641; Mahle KC231; Mann & Hummel WK940/17
Thread: 1 -12
O.D.: 3 23/32 (94.5)
Height: 5 21/32 (143.7)
I.Gskt: G401

BF7988



Fuel Spin-on

Contains: Integral Post Seal
Fits: M.T.U. 12V2000, 12V4000 Engines
Replaces: M.T.U. 20921901; Fleetguard FF5642; Mann & Hummel WK940/23
Thread: 1 -12
O.D.: 3 23/32 (94.5)
Height: 5 21/32 (143.7)
I.Gskt: G401

BF7989-D



Fuel/Water Separator Element with Removable Drain

Fits: 11/2001-on R.V.I. Midlum Trucks all with dCi16 Engine
Replaces: Renault 5001846015; Fleetguard FS19810
O.D.: 3 9/32 (83.3)
I.D.: 21/32 (16.7) One End
Height: 6 25/32 (172.2)
Grommets: [1] Attached

BF7990



Fuel Spin-on

Contains: Integral Post Seal
Fits: Caterpillar Equipment
Replaces: Agco 525517D1; Caterpillar 299-8229
Thread: M12 x 1.5
O.D.: 3 1/16 (77.8)
Height: 5 1/2 (139.7)
I.Gskt: [1] Included
O-Ring: [1] Included

BF7993



Fuel Spin-on

Contains: Integral Post Seal
Fits: Furukawa, Kato, Kobelco, Link-Belt, MDI/Yutani, Sumitomo, Tadano Equipment; Mitsubishi Engines, Trucks
Replaces: Mitsubishi ME056670
Thread: M24 x 1.5
O.D.: 3 11/16 (93.7)
Height: 6 9/16 (167.5)
I.Gskt: [1] Included

BF7994



Nylon Mesh Fuel Strainer

Fits: International Trucks all with MaxxForce DT, MaxxForce 7, MaxxForce 9, MaxxForce 10 Engines
Replaces: International 1873910-C91
O.D.: 1 11/16 (42.9)
I.D.: 1 13/32 (35.7) One End
Height: 2 27/32 (72.2)
O-Ring: [1] Included

BF7995



Fuel Storage Tank Spin-on

Replaces: Partmo A70015
Thread: 1 1/2 -16
O.D.: 3 3/4 (95.3)
Height: 5 9/16 (141.3)
I.Gskt: [1] Included

BF7996



Fuel Spin-on

Contains: Integral Post Seal
Fits: M.T.U. 20V8000 Engine
Replaces: M.T.U. 20922101; Donaldson P765199; Fleetguard FF5710
Thread: M39 x 1.5
O.D.: 5 3/8 (136.5)
Height: 12 1/8 (308.0)
I.Gskt: [1] Included

Measurements Are Shown In Inches And (Millimeters)

WARNING: These products can expose you to chemicals, including Diisononyl Phthalate, Carbon black extracts, Nickel, 1,3 Butadiene, Ethylene Oxide, Epichlorohydrin, which are known to the State of California to cause cancer, and Bisphenol, Ethylene Glycol, Ethylene Oxide, 1,3 Butadiene, Epichlorohydrin, which are known to the State of California to cause birth defects or other reproductive harm. For more information go to www.P65Warnings.ca.gov.

BF7997

Fuel Spin-on



Fits: Fendt Tractors; Volvo Equipment
Replaces: Bomag 5717966; Deutz 1182672, 1182674; Fendt F934201060010; Volvo 20805349
Thread: M18 x 1.5
O.D.: 3 23/32 (94.5)
Height: 8 5/32 (207.2)
I.Gskt: [1] Included

PT8306-10

Hydraulic Element



Fits: Zinga Hydraulic Applications
Replaces: Elgin 1032085; Zinga RE409-10
O.D.: 3 15/16 (100.0)
I.D.: 1 15/16 (49.2)
Height: 9 1/4 (235.0)
End Seals: [2] Attached
Related To: PT8306-25 (Media Difference)

BF7998

Fuel/Water Separator Spin-on with Sensor Port



Notes: CAUTION: Furnished post seal must be installed on post for seal.
Contains: Post Seal
 Sensor Port Thread: M14 x 2.0
Fits: Case-International, New Holland Tractors
Replaces: Case 87803189; New Holland 87803187
Thread: M16 x 1.5
O.D.: 3 1/32 (77.0)
Height: 6 1/2 (165.1)
I.Gskt: G449-B

PT8306-25

Hydraulic Element



Fits: Zinga Hydraulic Applications
Replaces: Zinga RE409-25
O.D.: 3 15/16 (100.0)
I.D.: 1 15/16 (49.2)
Height: 9 1/4 (235.0)
End Seals: [2] Attached
Related To: PT8306-10 (Media Difference)

BT8301

Hydraulic Spin-on



Fits: Bolens, Ford, Hitachi, Husky, John Deere Equipment
Replaces: John Deere AM39653
Thread: 3/4 -16
O.D.: 3 3/4 (95.3)
Height: 3 31/32 (100.8)
I.Gskt: G381-A

BT8307-MPG

Maximum Performance Glass Hydraulic Spin-on



Fits: Gleaner, Swinger, Vermeer Equipment
Use With: OB1314 and OB1316 bases (requires optional G286-C gasket).
Replaces: Hycon MFE16010BN2; International 1976934-C3; Pall HC7500SUN4H, HC7500SUS4H
Thread: 1 1/2 -16
O.D.: 5 1/16 (128.6)
Height: 6 31/32 (177.0)
F. Gskt: G369-B
O. Gskt: G286-C, G369-V, G372, G447, G483, G704, G710
Related To: BT8421-MPG (Micron Difference)

BT8302

Hydraulic Spin-on



Contains: Anti-Drainback Valve
 30 PSID By-Pass Valve
 Standpipe
Fits: Fiat-Allis Equipment
Replaces: Fiat 79026104
Thread: 1 -12
O.D.: 4 1/4 (108.0)
Height: 9 3/16 (233.4)
I.Gskt: G401

BT8308-MPG

Maximum Performance Glass Hydraulic Spin-on



Fits: Ag-Chem, Agco, Case, Volvo Equipment; Ingersoll-Rand Compressors
Use With: OB1314 and OB1316 bases (requires optional G286-C gasket).
Replaces: Case A177614, A177615; Gradall 91143144; Ingersoll-Rand 51608503; Pall HC7500SUN8H
Thread: 1 1/2 -16
O.D.: 5 1/16 (128.6)
Height: 10 3/4 (273.1)
F. Gskt: G369-B
O-Ring: G447
O. Gskt: G286-C, G369-V, G372, G483, G704, G710
Related To: BT8422-MPG (High Efficiency Version)

BT8304

Hydraulic Spin-on



Fits: Joy Compressors
Replaces: Joy 1228337-20
Thread: M38 x 2.0
O.D.: 3 11/16 (93.7)
Height: 5 9/16 (141.3)
I.Gskt: [1] Included

BT8308-MPG KI

Set of 2 Maximum Performance Glass Hydraulic Spin-ons



Fits: Ag-Chem, Agco, Case, Volvo Equipment; Ingersoll-Rand Compressors
Use With: OB1314 and OB1316 bases (requires optional G286-C gasket).
Replaces: Case A177614, A177615; Ingersoll-Rand 51608503; Pall HC7500SUN8H
Thread: 1 1/2 -16
O.D.: 5 1/16 (128.6)
Height: 10 3/4 (273.1)
F. Gskt: G369-B, G447
O. Gskt: G286-C, G369-V, G372, G483, G704, G710
Related To: BT8422-MPG (High Efficiency Version)

PT8305

Hydraulic Element



Fits: Vickers Hydraulic Applications
Replaces: Vickers 404211
O.D.: 3 15/16 (100.0)
I.D.: 2 9/32 (57.9) One End
Height: 17 15/16 (455.6)

Measurements Are Shown In Inches And (Millimeters)

WARNING: These products can expose you to chemicals, including Diisononyl Phthalate, Carbon black extracts, Nickel, 1,3 Butadiene, Ethylene Oxide, Epichlorohydrin, which are known to the State of California to cause cancer, and Bisphenol, Ethylene Glycol, Ethylene Oxide, 1,3 Butadiene, Epichlorohydrin, which are known to the State of California to cause birth defects or other reproductive harm. For more information go to www.P65Warnings.ca.gov.

BT8309-MPG Maximum Performance Glass Hydraulic Spin-on
Fits: John Deere Equipment
Use With: OB1314 and OB1316 bases (requires optional G286-C gasket).
Replaces: John Deere AT100973, RE45864
Thread: 1 1/2 -16
O.D.: 5 1/16 (128.6)
Height: 6 31/32 (177.0)
F. Gskt: G369-B, G447
O. Gskt: G286-C, G369-V, G372, G483, G704, G710



PT8319 Hydraulic Element
Fits: Fiat, Fiat-Allis, Hitachi Equipment
Replaces: Fiat 71402469; Hitachi 4207841, 4207841A
O.D.: 1 31/32 (50.0)
I.D.: 27/32 (21.4)
Height: 5 29/32 (150.0)
O-Ring: [1] Included
Grommets: [1] Attached

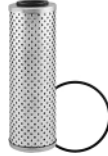

BT8310-MPG Maximum Performance Glass Hydraulic Spin-on
Fits: Champion Equipment
Use With: OB1314 and OB1316 bases (requires optional G286-C gasket).
Replaces: Pall HC7500SUT8H
Thread: 1 1/2 -16
O.D.: 5 1/16 (128.6)
Height: 10 3/4 (273.1)
F. Gskt: G369-B
O. Gskt: G286-C, G369-V, G372, G447, G483, G704, G710



BT8320 Hydraulic Spin-on
Fits: Case, John Deere, New Holland Equipment
Use With: OB8711, OB8712, OB8720, OB8721, OB8722, OB8724, OB8731, OB8732, OB8741, OB8742, OB8743, OB8744, OB8745, OB8746 filter bases.
Replaces: Case D149921
Thread: 1 3/8 -12
O.D.: 4 23/32 (119.9)
Height: 11 17/32 (292.9)
I.Gskt: [1] Included



BT8312 Hydraulic Spin-on
Fits: Case Equipment
Use With: OB8711, OB8712, OB8720, OB8721, OB8722, OB8724, OB8731, OB8732, OB8741, OB8742, OB8743, OB8744, OB8745, OB8746 filter bases.
Replaces: Case L36242
Thread: 1 3/8 -12
O.D.: 3 3/4 (95.3)
Height: 9 19/32 (243.7)
I.Gskt: [1] Included



BT8323 Hydraulic Spin-on
Contains: 20 PSID By-Pass Valve
Fits: Bush Hog Lawn Tractors; Zinga Hydraulic Systems
Replaces: Zinga BE10-18
Thread: 3/4 -16
O.D.: 3 1/32 (77.0)
Height: 3 1/2 (88.9)
I.Gskt: [1] Included



BT8314 Hydraulic Spin-on
Fits: Caterpillar Equipment
Replaces: Caterpillar 4T6915
Thread: 1 1/8 -16
O.D.: 3 11/16 (93.7)
Height: 5 5/8 (142.9)
I.Gskt: G381-A



BT8328 Hydraulic Spin-on
Contains: Anti-Drainback Valve
8 PSID By-Pass Valve
Fits: Ford Light-Duty Trucks, Vans; Sellick Lift Trucks
Replaces: Sellick 131559
Thread: 3/4 -16
O.D.: 3 11/16 (93.7)
Height: 5 15/32 (138.9)
I.Gskt: G401



BT8316-MPG Maximum Performance Glass Transmission Spin-on
Fits: Allison Transmissions
Replaces: Allison 23042062
Thread: 1 1/2 -16
O.D.: 3 11/16 (93.7)
Height: 5 9/16 (141.3)
O-Ring: [1] Included



PT8329 Hydraulic Element
Contains: Spring Reinforced Centertube
Fits: Tamrock Drills
Replaces: Schroeder CC3
O.D.: 2 7/8 (73.0)
I.D.: 1 (25.4) One End
Height: 9 5/8 (244.5)
O-Ring: [1] Attached



PT8318-MPG Maximum Performance Glass Transmission Element
Fits: John Deere Equipment
Replaces: John Deere RE15472
O.D.: 4 9/16 (115.9)
I.D.: 2 7/32 (56.4)
Height: 5 15/32 (138.9)
A. Gskt: [2] Attached



PT8330-MPG Maximum Performance Glass Hydraulic Element
Fits: Allison Transmissions
Replaces: Allison 23040988
O.D.: 3 7/32 (81.8)
I.D.: 1 7/16 (36.5) One End
Height: 8 1/8 (206.4)
O-Ring: [1] Attached



Measurements Are Shown In Inches And (Millimeters)

! **WARNING:** These products can expose you to chemicals, including Diisononyl Phthalate, Carbon black extracts, Nickel, 1,3 Butadiene, Ethylene Oxide, Epichlorohydrin, which are known to the State of California to cause cancer, and Bisphenol, Ethylene Glycol, Ethylene Oxide, 1,3 Butadiene, Epichlorohydrin, which are known to the State of California to cause birth defects or other reproductive harm. For more information go to www.P65Warnings.ca.gov.

PT8331-MPG Maximum Performance Glass Hydraulic Element



Contains: Reinforced Centertube
Fits: Case Equipment
Replaces: Case L52029, R51643
O.D.: 4 1/2 (114.3)
I.D.: 15/32 (11.9) & 2 1/4 (57.2)
Height: 9 (228.6)
F. Gskt: [1] Included
Grommets: [1] Attached Small End

PT8341 Hydraulic Element



Fits: Caterpillar Equipment
Replaces: Caterpillar 96-6431, 99-7352
O.D.: 1 31/32 (50.0)
I.D.: 27/32 (21.4) One End
Height: 3 3/32 (78.6)
O-Ring: [1] Included
Grommets: [1] Attached

BT8333 Hydraulic Spin-on



Notes: Rated 2000 PSI minimum burst
Contains: Integral Post Seal
Fits: Caterpillar Equipment
Replaces: Caterpillar 4I3948
Thread: 2 -12
O.D.: 3 1/8 (79.4)
Height: 5 17/32 (140.5)

PT8344 Hydraulic Element



Fits: Belarus Tractors
Replaces: Belarus 761000000
O.D.: 3 21/32 (92.9)
I.D.: 1 23/32 (43.7)
Height: 7 7/8 (200.0)

PT8334 By-Pass Lube Element with Bail Handle



Contains: Reinforced Centertube
Fits: Hitachi Excavators
Replaces: Hitachi 4208241
Thread: M16 x 1.0
O.D.: 6 1/2 (165.1)
Height: 7 3/4 (196.9)
F. Gskt: [1] Included
O-Ring: [2] Included

PT8345 Hydraulic Element



Fits: Kobelco Loaders
Replaces: Kobelco 2446U139-F1
O.D.: 3 3/4 (95.3)
I.D.: 19/32 (15.1) & 1 5/16 (33.3)
Height: 6 1/8 (155.6)
F. Gskt: [3] Included
End Seals: [1] Attached
Grommets: [1] Attached

PT8335 Lube Element



Contains: Bleed Hole
Fits: Kobelco Loaders; Nissan Trucks
Replaces: Kobelco 2451R131-1B;
 Nissan 15274-99027
O.D.: 5 1/16 (128.6)
I.D.: 19/32 (15.1)
Height: 9 3/8 (238.1)
F. Gskt: [3] Included
Grommets: [2] Attached

BT8347 Hydraulic Spin-on



Fits: John Deere Tractors
Replaces: John Deere AL56469
Thread: 1 -12
O.D.: 3 23/32 (94.5)
Height: 7 7/32 (183.4)
I.Gskt: G401

PT8338 Transmission Element



Fits: Kawasaki, Kobelco Equipment
Replaces: Kawasaki KL49060-70010
O.D.: 4 7/32 (107.2)
I.D.: 1 13/16 (46.0)
Height: 9 1/32 (229.4)
F. Gskt: [3] Included
End Seals: [2] Attached

PT8350 Hydraulic Element



Fits: Caterpillar Equipment
Replaces: Caterpillar 1R0746
O.D.: 2 7/8 (73.0)
I.D.: 1 1/16 (27.0) One End
Height: 5 5/8 (142.9)
End Seals: [1] Attached

PT8339 Hydraulic Element



Fits: Caterpillar Excavators
Replaces: Caterpillar 95-5481
O.D.: 4 1/2 (114.3)
I.D.: 2 9/32 (57.9) One End
Height: 7 3/16 (182.6)
F. Gskt: [1] Included
End Seals: [1] Attached

PT8351 Hydraulic Element



Fits: Hitachi Equipment
Replaces: Hitachi 3021593
O.D.: 2 7/8 (73.0)
I.D.: 1 11/32 (34.1)
Height: 7 15/16 (201.6)
A. Gskt: [2] Attached
F. Gskt: [1] Included

Measurements Are Shown In Inches And (Millimeters)

WARNING: These products can expose you to chemicals, including Diisononyl Phthalate, Carbon black extracts, Nickel, 1,3 Butadiene, Ethylene Oxide, Epichlorohydrin, which are known to the State of California to cause cancer, and Bisphenol, Ethylene Glycol, Ethylene Oxide, 1,3 Butadiene, Epichlorohydrin, which are known to the State of California to cause birth defects or other reproductive harm. For more information go to www.P65Warnings.ca.gov.

PT8352

Hydraulic Element



Fits: Daewoo, Hitachi Equipment
Replaces: Hitachi 4159320
O.D.: 2 7/8 (73.0)
I.D.: 1 11/32 (34.1) One End
Height: 4 25/32 (121.4)
A. Gskt: [2] Attached
F. Gskt: G283, [1] Included

PT8353

Hydraulic Element



Notes: Inside-Out Flow Direction
Fits: Atlas-Weyhausen, Poclairn, Volvo, Zettelmeyer Equipment
Replaces: Poclairn N0250574; Volvo 6638403; Zettelmeyer 2165400
O.D.: 4 5/32 (105.6)
I.D.: 13/32 (10.3) & 2 3/4 (69.9)
Height: 10 1/4 (260.4)
Grommets: [1] Attached

PT8354

Hydraulic Element



Fits: Kobelco Loaders
Replaces: Kobelco 2446U126
O.D.: 2 7/8 (73.0)
I.D.: 1 11/32 (34.1) One End
Height: 6 9/32 (159.5)
A. Gskt: [1] Attached
F. Gskt: [1] Included

PT8355

Hydraulic Element



Fits: Kobelco Equipment
Replaces: Kobelco 2446R204-S3
O.D.: 2 7/8 (73.0)
I.D.: 1 11/32 (34.1) One End
Height: 5 15/32 (138.9)
A. Gskt: [1] Attached

PT8356

Hydraulic Element



Fits: Kobelco Equipment
Replaces: Kobelco 2451R124-1
O.D.: 3 19/32 (91.3)
I.D.: 21/32 (16.7)
Height: 6 5/8 (168.3)
F. Gskt: [2] Included
Grommets: [2] Attached

BT8357

Hydraulic Spin-on



Contains: 20 PSID By-Pass Valve
Fits: Ford, New Holland Tractors
Replaces: Ford F0NN-B486-AA
Thread: 1 1/8 -16
O.D.: 3 11/16 (93.7)
Height: 6 5/8 (168.3)
I.Gskt: G381-A

PT8359

Hydraulic Element

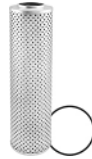

Fits: Daewoo, Hitachi Equipment
Replaces: Hitachi 3502410N
O.D.: 3 3/8 (85.7)
I.D.: 1 7/8 (47.6)
Height: 11 7/16 (290.5)
F. Gskt: G162
O-Ring: [2] Attached

PT8361

Hydraulic Element



Fits: Bantam, John Deere, Koehring, Lorain Equipment
Replaces: Koehring 708-6449
O.D.: 6 1/2 (165.1)
I.D.: 3 15/32 (88.1)
Height: 15 1/4 (387.4)
O-Ring: [2] Attached

PT8363

Hydraulic Element

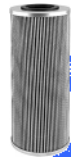

Fits: Caterpillar, Grove Equipment; Schroeder Hydraulic Systems
Replaces: Caterpillar 837905; Grove 9437100641; Pall HC9700FDS9H; Schroeder KS7, KZ10
O.D.: 3 15/16 (100.0)
I.D.: 1 9/16 (39.7)
Height: 9 5/32 (232.6)
Grommets: [2] Attached

PT8366

Hydraulic Element



Fits: Caterpillar, Hitachi, Kobelco, Komatsu, MDI/Yutani, Mitsubishi Equipment
Replaces: Caterpillar 94-4412; Hitachi 4219713; Komatsu 178-611-4160
O.D.: 5 29/32 (150.0)
I.D.: 4 11/32 (110.3)
Height: 17 23/32 (450.1)
F. Gskt: [1] Included
O. Gskt: ES3231

BT8368

Stainless Steel Mesh Hydraulic Spin-on



Fits: Fiat-Allis Equipment
Use With: OB1313, OB1314, OB1315, OB1316 bases (requires optional G286-C gasket).
Replaces: Fiat 73133001; Zinga LE100
Thread: 1 1/2 -16
O.D.: 5 1/16 (128.6)
Height: 10 3/4 (273.1)
F. Gskt: G369-B
O. Gskt: G286-C, G369-V, G372, G447, G483, G704, G710

PT8370-MPG

Maximum Performance Glass Hydraulic Element



Fits: Schroeder Hydraulic Systems
Replaces: Pall HC9700FDP9H, HC9700FKP9H, HC9700FUP9H; Parker 925778; Schroeder KS1
O.D.: 3 29/32 (99.2)
I.D.: 1 13/16 (46.0)
Height: 9 3/32 (231.0)
Grommets: [2] Attached

Measurements Are Shown In Inches And (Millimeters)

WARNING: These products can expose you to chemicals, including Diisononyl Phthalate, Carbon black extracts, Nickel, 1,3 Butadiene, Ethylene Oxide, Epichlorohydrin, which are known to the State of California to cause cancer, and Bisphenol, Ethylene Glycol, Ethylene Oxide, 1,3 Butadiene, Epichlorohydrin, which are known to the State of California to cause birth defects or other reproductive harm. For more information go to www.P65Warnings.ca.gov.

PT8371-MPG Maximum Performance Glass Hydraulic Element



Fits: Donaldson Assemblies
Replaces: Donaldson P165628
O.D.: 4 3/8 (111.1)
I.D.: 2 7/16 (61.9)
Height: 16 (406.4)
A. Gskt: [1] Attached
Grommets: [1] Attached

BT8381 Hydraulic Spin-on



Fits: Dresser Equipment
Replaces: Dresser 1214275-H2
Thread: 1 1/2 -16
O.D.: 5 (127.0)
Height: 11 3/4 (298.5)
I.Gskt: [1] Included

PT8372 Hydraulic Element



Fits: Kobelco, MDI/Yutani Equipment
Replaces: Kobelco R36P0019
O.D.: 1 21/32 (42.1)
I.D.: 29/32 (23.0) One End
Height: 3 15/32 (88.1)
O-Ring: [1] Attached

BT8382 Hydraulic Spin-on



Contains: 15 PSID By-Pass Valve
Fits: Ford, New Holland Tractors
Replaces: Ford F0NN-B486-BB;
New Holland 82005016
Thread: 1 3/4 -16
O.D.: 5 3/8 (136.5)
Height: 9 5/8 (244.5)
I.Gskt: [1] Included

PT8375-MPG Maximum Performance Glass Hydraulic Element



Fits: Timberjack Logging Equipment
Replaces: Timberjack 411531
O.D.: 4 3/8 (111.1)
I.D.: 2 1/32 (51.6) One End
Height: 8 (203.2)
O-Ring: [1] Attached

PT8383 Hydraulic Element

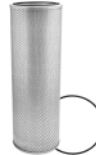

Contains: Reinforced Centertube
Fits: Hitachi Excavators
Replaces: Hitachi 4325820
O.D.: 5 29/32 (150.0)
I.D.: 4 11/32 (110.3)
Height: 17 29/32 (454.8)
A. Gskt: [2] Attached
F. Gskt: [1] Included

PT8376-MPG Maximum Performance Glass Hydraulic Element



Replaces: Parker 908649
O.D.: 5 11/16 (144.5)
I.D.: 4 3/32 (104.0)
Height: 12 1/8 (308.0)
A. Gskt: [2] Attached

BT8384 Hydraulic Spin-on



Contains: 50 PSID By-Pass Valve
Fits: Liebherr, VogeLe Equipment
Replaces: Case 45144600; Linde 983-06-13,
983-06-18, 983-06-23
Thread: 3/4 -16
O.D.: 3 1/32 (77.0)
Height: 5 1/2 (139.7)
I.Gskt: [1] Included

PT8378-MPG Maximum Performance Glass Hydraulic Element



Fits: Leach Packers
Replaces: Leach 100815, 107408
O.D.: 3 23/32 (94.5)
I.D.: 1 23/32 (43.7) One End
Height: 9 1/16 (230.2)
Grommets: [1] Attached

PT8385 Hydraulic Element



Fits: DAF, Iveco, M.A.N., R.V.I., Volvo Trucks
Replaces: Volvo 1193281, 1193281-1
O.D.: 2 23/32 (69.1)
I.D.: 1 3/8 (34.9) One End
Height: 4 1/16 (103.2)
F. Gskt: [2] Included

PT8380 Wire Mesh Supported Hydraulic Element

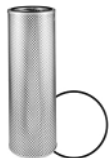

Fits: Hitachi, John Deere Equipment
Replaces: John Deere AT127608, AT147343
O.D.: 5 29/32 (150.0)
I.D.: 4 11/32 (110.3)
Height: 17 7/8 (454.0)
A. Gskt: [2] Attached
F. Gskt: [1] Included

BT8386 Hydraulic Breather Element



Fits: Clark Lift Trucks
Replaces: Clark 2370631
O.D.: 3 1/32 (77.0)
I.D.: 1 19/32 (40.5)
Height: 2 7/32 (56.4)

Measurements Are Shown In Inches And (Millimeters)

WARNING: These products can expose you to chemicals, including Diisononyl Phthalate, Carbon black extracts, Nickel, 1,3 Butadiene, Ethylene Oxide, Epichlorohydrin, which are known to the State of California to cause cancer, and Bisphenol, Ethylene Glycol, Ethylene Oxide, 1,3 Butadiene, Epichlorohydrin, which are known to the State of California to cause birth defects or other reproductive harm. For more information go to www.P65Warnings.ca.gov.

PT8387 Hydraulic Element
Contains: Reinforced Centertube
Fits: Kobelco, MDI/Yutani Equipment
Replaces: Kobelco 24046Z15
O.D.: 4 13/32 (111.9)
I.D.: 2 3/4 (69.9)
Height: 17 11/16 (449.3)
F. Gskt: [1] Included



PT8394-MPG Maximum Performance Glass Hydraulic Element
Replaces: Parker 924795
O.D.: 3 21/32 (92.4)
I.D.: 1 3/4 (44.5)
Height: 18 1/2 (469.9)
Grommets: [2] Attached



PT8388 Hydraulic Element
Contains: Reinforced Centertube
Fits: Daewoo Equipment; Hitachi Excavators
Replaces: Hitachi 4227353
O.D.: 4 13/32 (111.9)
I.D.: 2 9/16 (65.1)
Height: 18 1/32 (458.0)
A. Gskt: [2] Attached
F. Gskt: [2] Included



PT8395 Hydraulic Element
Fits: Dresser, Hough Loaders
Replaces: International 940241-C2
O.D.: 7 7/16 (188.9)
I.D.: 4 13/16 (122.2)
Height: 18 1/16 (458.8)
A. Gskt: [2] Attached



PT8389 Hydraulic Element
Contains: Reinforced Centertube
Fits: Hitachi Equipment
Replaces: Hitachi 4159319
O.D.: 4 13/32 (111.9)
I.D.: 2 9/16 (65.1)
Height: 18 1/32 (458.0)
A. Gskt: [2] Attached
F. Gskt: [1] Included



PT8396 Hydraulic Element
Fits: V.M.E., Volvo Loaders
Replaces: Volvo M2560232
O.D.: 7 7/16 (188.9)
I.D.: 4 13/16 (122.2)
Height: 18 5/32 (461.2)
A. Gskt: [2] Attached



BT8391 Hydraulic Spin-on
Fits: Ford, New Holland Tractors
Replaces: Ford SBA340500610;
 New Holland 9846407
Thread: 1 1/8 -16
O.D.: 3 11/16 (93.7)
Height: 5 21/32 (143.7)
I.Gskt: G401



BT8397-MPG Maximum Performance Glass Hydraulic Spin-on
Fits: John Deere Equipment
Replaces: John Deere AT147496
Thread: 1 1/2 -16
O.D.: 3 15/16 (100.0)
Height: 9 1/2 (241.3)
I.Gskt: [1] Included



PT8392 Hydraulic Element
Fits: Bobcat, Case, Daewoo, Hitachi, Hyundai,
 Volvo Equipment
Replaces: Case 153233A1; Clark 6655066;
 Hyundai 31E30018
O.D.: 1 21/32 (42.1)
I.D.: 27/32 (21.4) One End
Height: 3 7/16 (87.3)
I.Gskt: [1] Included
O-Ring: [1] Included



BT8398-MPG Maximum Performance Glass Hydraulic Spin-on
Replaces: Pall MC7400SDN4Z
Thread: 1 1/2 -16
O.D.: 3 11/16 (93.7)
Height: 5 9/16 (141.3)
I.Gskt: [1] Included



BT8393 Hydraulic Spin-on
Contains: 15 PSID By-Pass Valve
Fits: Ford, New Holland Tractors
Replaces: Ford F0NN-3N976-AA;
 New Holland 81869132
Thread: 1 1/8 -16
O.D.: 3 11/16 (93.7)
Height: 8 3/16 (208.0)
I.Gskt: G401



PT8400-MPG Maximum Performance Glass Hydraulic Element
Fits: J.C. Bamford Equipment
Replaces: J.C. Bamford 581/05601, 581/06301
O.D.: 2 27/32 (72.2)
I.D.: 9/32 (7.1) & 1 25/32 (45.2)
Height: 11 13/16 (300.0)



Measurements Are Shown In Inches And (Millimeters)

WARNING: These products can expose you to chemicals, including Diisononyl Phthalate, Carbon black extracts, Nickel, 1,3 Butadiene, Ethylene Oxide, Epichlorohydrin, which are known to the State of California to cause cancer, and Bisphenol, Ethylene Glycol, Ethylene Oxide, 1,3 Butadiene, Epichlorohydrin, which are known to the State of California to cause birth defects or other reproductive harm. For more information go to www.P65Warnings.ca.gov.

BT8401-MPG Maximum Performance Glass Hydraulic Spin-on
Fits: Ingersoll-Rand Compressors
Use With: OB8771, OB8772, OB8773 filter bases.
Replaces: Ingersoll-Rand 39796982
Thread: 1 3/4 -12
O.D.: 4 23/32 (119.9)
Height: 11 17/32 (292.9)
I.Gskt: [1] Included



BT8409 Lube or Transmission Spin-on
Contains: Anti-Drainback Valve
 14 PSID By-Pass Valve
Fits: 2011 Mazda Tribute; Case, Case-International, Komatsu, New Holland, Vermeer Equipment
Replaces: Agco 700723604; Case 87409203; Komatsu 600-211-2110; New Holland 87415600
Thread: 3/4 -16
O.D.: 3 (76.2)
Height: 3 17/32 (89.7)
I.Gskt: [1] Included



PT8402-MPG Maximum Performance Glass Hydraulic Element
Contains: Reinforced Centertube
Fits: Fiat-Allis Equipment
Replaces: Fiat-Allis 73148371
O.D.: 4 9/16 (115.9)
I.D.: 2 7/32 (56.4)
Height: 12 7/8 (327.0)
End Seals: [2] Attached



PT8410 Hydraulic Element
Contains: Reinforced Centertube
Fits: J.C. Bamford Equipment
Replaces: J.C. Bamford 581/01801
O.D.: 6 7/8 (174.6)
I.D.: 3 5/8 (92.1)
Height: 14 3/16 (360.4)
A. Gskt: [2] Attached



PT8403-MPG Maximum Performance Glass Hydraulic Element
Contains: Reinforced Centertube
Fits: Caterpillar Equipment
Replaces: Caterpillar 132-8875
O.D.: 3 15/16 (100.0)
I.D.: 2 9/32 (57.9)
Height: 9 5/16 (236.5)
End Seals: [2] Attached



PT8411 Hydraulic Element
Contains: Reinforced Centertube
Fits: J.C. Bamford Equipment
Replaces: J.C. Bamford 32/901200
O.D.: 6 29/32 (175.4)
I.D.: 2 1/32 (16.7) & 3 5/8 (92.1)
Height: 9 13/32 (238.9)
A. Gskt: [1] Attached



PT8404-MPG Maximum Performance Glass Hydraulic Element
Fits: Kobelco, MDI/Yutani Equipment
Replaces: Kobelco 2446U233-S2
O.D.: 3 23/32 (94.5)
I.D.: 1 15/16 (49.2) One End
Height: 9 3/16 (233.4)
A. Gskt: [1] Attached



BT8412 In-Line Hydraulic Filter
Contains: 15 PSID By-Pass Valve
Fits: Toyota Lift Trucks
Replaces: Toyota 67502-23000-71
O.D.: 4 1/4 (108.0)
Inlet: 1-14
Outlet: 1 1/16
Length: 5 11/32 (135.7)



PT8407 Power Steering Element
Contains: 8 PSID By-Pass Valve
Fits: Freightliner, International Buses, Trucks
Replaces: Ford F0HZ-3C602-A; International 1681202-C91
O.D.: 4 1/32 (102.4)
I.D.: 7/16 (11.1) & 2 7/16 (61.9)
Height: 4 5/32 (105.6)
A. Gskt: [1] Attached



BT8413 Transmission Spin-on
Fits: Saturn Automotive
Replaces: Saturn 21002303, 21002496, 21003298
Thread: 3/4 -20
O.D.: 3 1/32 (77.0)
Height: 3 1/2 (88.9)
I.Gskt: [1] Included



PT8408 Hydraulic Element
Contains: Reinforced Centertube
Fits: John Deere Equipment
Replaces: John Deere TH103699, TH111010
O.D.: 4 13/32 (111.9)
I.D.: 2 19/32 (65.9)
Height: 18 (457.2)
O-Ring: [2] Included



PT8414-MPG Maximum Performance Glass Hydraulic Element
Fits: Broyt, V.M.E., Volvo Equipment
Replaces: Volvo 6210359, 6635975, 11026934-7, 11996150-6
O.D.: 4 31/32 (126.2)
I.D.: 13/32 (10.3) & 3 5/8 (92.1)
Height: 11 7/16 (290.5)
Related To: PT722 (Standard Media Version)



Measurements Are Shown In Inches And (Millimeters)

WARNING: These products can expose you to chemicals, including Diisononyl Phthalate, Carbon black extracts, Nickel, 1,3 Butadiene, Ethylene Oxide, Epichlorohydrin, which are known to the State of California to cause cancer, and Bisphenol, Ethylene Glycol, Ethylene Oxide, 1,3 Butadiene, Epichlorohydrin, which are known to the State of California to cause birth defects or other reproductive harm. For more information go to www.P65Warnings.ca.gov.

BT8415

Transmission Spin-on



Contains: 30 PSID By-Pass Valve
Stud Thread: M24 x 1.5
Fits: John Deere Equipment
Replaces: John Deere AT179323
Thread: 1 -12
O.D.: 3 11/16 (93.7)
Height: 6 1/16 (154.0)
I.Gskt: G401

BT8416

Hydraulic Spin-on



Fits: John Deere, Toro Lawn & Garden Equipment; Bobcat Equipment
Use With: OB8711, OB8712, OB8720, OB8721, OB8722, OB8724, OB8731, OB8732, OB8741, OB8742, OB8743, OB8744, OB8745, OB8746 filter bases.
Replaces: John Deere AM102723; Stens 120842; Toro 75-1330
Thread: 1 3/8 -12
O.D.: 3 3/4 (95.3)
Height: 4 17/32 (115.1)
I.Gskt: [1] Included

BT8417

Transmission Spin-on



Contains: 30 PSID By-Pass Valve
Fits: Caterpillar, Manitou, New Holland Equipment
Replaces: Caterpillar 6E0924, 119-4740; New Holland 9968353, 9969450
Thread: 13/16 -16
O.D.: 3 1/32 (77.0)
Height: 4 13/16 (122.2)
I.Gskt: G449-B

BT8418

Hydraulic Spin-on



Notes: 2000 PSI minimum burst
Fits: Caterpillar Equipment
Replaces: Caterpillar 4I3950
Thread: 2 -12
O.D.: 3 1/8 (79.4)
Height: 9 17/32 (242.1)
I.Gskt: [1] Included

PT8419

In-Tank Hydraulic Element



Notes: Inside-Out Flow Direction.
 For use on return side.
Contains: 21-24 PSID By-Pass Valve
Fits: Komatsu Lift Trucks
Replaces: Komatsu 3EB66-11711, 3EB66-11711L
O.D.: 3 9/16 (90.5)
Inlet: 3/4 In. NPT
Height: 6 17/32 (165.9)

BT8420

Wire Mesh Hydraulic Spin-on



Fits: Barber-Greene Equipment
Use With: OB1317, OB1318, OB1319, OB1320 bases.
Replaces: Zinga AE100
Thread: 1 -12
O.D.: 3 11/16 (93.7)
Height: 5 13/32 (137.3)
I.Gskt: G401
Related To: BT839, BT839-10 (Standard Versions)

BT8421-MPG

Maximum Performance Glass Hydraulic Spin-on



Fits: Donaldson HBK05 Assembly
Use With: OB1314 and OB1316 bases (requires optional G286-C gasket).
Replaces: Hycon MFE16003BN2; Ingersoll-Rand 59700674; Pall HC7500SDP4H; Donaldson P169430
Thread: 1 1/2 -16
O.D.: 5 1/16 (128.6)
Height: 6 31/32 (177.0)
F. Gskt: G369-B
O. Gskt: G286-C, G369-V, G372, G447, G483, G704, G710
Related To: BT8307-MPG (Micron Difference)

BT8422-MPG

High Efficiency Maximum Performance Glass Hydraulic Spin-on



Fits: Donaldson HBK05 Assembly
Use With: OB1314 and OB1316 bases (requires optional G286-C gasket).
Replaces: Hycon MFE160103BN2; Pall HC7500SUP8H; Donaldson P167832
Thread: 1 1/2 -16
O.D.: 5 1/16 (128.6)
Height: 10 3/4 (273.1)
F. Gskt: G369-B
O. Gskt: G286-C, G369-V, G372, G447, G483, G704, G710
Related To: BT8308-MPG (Standard Version)

BT8423

Wire Mesh Hydraulic Spin-on



Fits: Ingersoll-Rand Compressors
Use With: OB1313, OB1314, OB1315, OB1316 bases (requires optional G286-C gasket).
Replaces: Ingersoll-Rand 59879247; Zinga SE100
Thread: 1 1/2 -16
O.D.: 5 1/16 (128.6)
Height: 6 31/32 (177.0)
F. Gskt: G369-B
O. Gskt: G286-C, G369-V, G372, G447, G483, G704, G710

BT8424-MPG

Maximum Performance Glass Hydraulic Spin-on



Fits: Vermeer Equipment
Use With: OB1314 and OB1316 bases (requires optional G286-C gasket).
Replaces: Vermeer 201805001
Thread: 1 1/2 -16
O.D.: 5 1/16 (128.6)
Height: 6 31/32 (177.0)
F. Gskt: G286-C, G369-B
O. Gskt: G369-V, G372, G447, G483, G704, G710

PT8425

Hydraulic Element



Fits: John Deere, Takeuchi Loaders
Replaces: John Deere AT204010; Takeuchi 1551101001
O.D.: 2 (50.8)
I.D.: 31/32 (24.6) One End
Height: 8 7/32 (208.8)
I.Gskt: [1] Included
O-Ring: [1] Included

Measurements Are Shown In Inches And (Millimeters)

WARNING: These products can expose you to chemicals, including Diisononyl Phthalate, Carbon black extracts, Nickel, 1,3 Butadiene, Ethylene Oxide, Epichlorohydrin, which are known to the State of California to cause cancer, and Bisphenol, Ethylene Glycol, Ethylene Oxide, 1,3 Butadiene, Epichlorohydrin, which are known to the State of California to cause birth defects or other reproductive harm. For more information go to www.P65Warnings.ca.gov.

BT8426-MPG Maximum Performance Glass Hydraulic Spin-on
Contains: 50 PSID By-Pass Valve
Fits: Caterpillar, Grove Equipment
Replaces: Clark 4202505; Gehl L99184
Thread: 2 -16
O.D.: 3 3/4 (95.3)
Height: 6 3/32 (154.8)
I.Gskt: [1] Included



PT8435-MPG Maximum Performance Glass In-Line Hydraulic Filter
Contains: 25 PSID By-Pass Valve
Fits: Hyster Lift Trucks
Replaces: Hyster 1337159
O.D.: 4 1/32 (102.4)
Inlet: 1
Outlet: 1
Length: 7 31/32 (202.4)
Related To: PT716 (Standard Media Version with No By-Pass Valve)



PT8427 Hydraulic Element
Fits: Bros Compactors
Replaces: GMC 25313910; Iowa Manufacturing 4517750903
O.D.: 4 3/8 (111.1)
I.D.: 1 7/8 (47.6)
Height: 10 3/32 (256.4)
I.Gskt: [2] Included

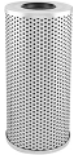

PT8436 Hydraulic Element
Contains: Reinforced Centertube
Fits: Caterpillar Equipment
Replaces: Caterpillar 126-2081
O.D.: 5 19/32 (142.1)
I.D.: 3 27/32 (97.6)
Height: 16 23/32 (424.7)
I.Gskt: [2] Included



BT8428-MPG Maximum Performance Glass Hydraulic Spin-on
Notes: Can be used with OB1318 and OB1320 bases.
Fits: Various Hydraulic Applications
Replaces: LHA SPE15BTA10
Thread: 1 -12
O.D.: 3 11/16 (93.7)
Height: 5 15/32 (138.9)
I.Gskt: G401
Related To: BT839, BT839-10 (Standard Versions)



BT8437 Hydraulic Spin-on
Contains: 25 PSID By-Pass Valve
Fits: Voith Transmissions
Replaces: Voith 90.4399.10, 90.4399.11
Thread: 1 1/2 -16
O.D.: 5 1/2 (139.7)
Height: 7 (177.8)
I.Gskt: [1] Included



BT8429 Air Breather Element
Fits: Caterpillar Lift Trucks
Replaces: Caterpillar 9Y5011
O.D.: 3 1/32 (77.0)
I.D.: 1 15/32 (37.3) One End
Height: 2 7/32 (56.4)



BT8439-MPG Maximum Performance Glass Hydraulic or Transmission Spin-on
Fits: Case, Komatsu, Volvo Loaders
Replaces: Case 181167A1, 254686A1
Thread: 13/16 -16
O.D.: 3 3/4 (95.3)
Height: 6 1/32 (153.2)
I.Gskt: [1] Included



BT8432-MPG Maximum Performance Glass Hydraulic Spin-on
Fits: Caterpillar Equipment
Use With: OB8711, OB8712, OB8720, OB8721, OB8722, OB8724, OB8731, OB8732, OB8741, OB8742, OB8743, OB8744, OB8745, OB8746 filter bases.
Replaces: Caterpillar 6E6408
Thread: 1 3/8 -12
O.D.: 4 23/32 (119.9)
Height: 11 17/32 (292.9)
I.Gskt: [1] Included



BT8440-MPG Maximum Performance Glass Hydraulic Spin-on
Contains: 25 PSID By-Pass Valve
Fits: Sullair Compressors
Replaces: Sullair 250026-982, 250028-032
Thread: 31/32 -20
O.D.: 3 21/32 (92.9)
Height: 5 5/8 (142.9)
I.Gskt: [1] Included



PT8433-MPG Maximum Performance Glass Hydraulic Element
Fits: V.M.E., Volvo Loaders
Replaces: Volvo 11026936, 11026936-2
O.D.: 4 31/32 (126.2)
I.D.: 13/32 (10.3) & 3 5/8 (92.1)
Height: 15 11/32 (389.7)
O-Ring: [1] Attached



PT8441 Hydraulic Element
Fits: Caterpillar Compactors
Replaces: Caterpillar 77-3092
O.D.: 4 3/8 (111.1)
I.D.: 1 7/8 (47.6)
Height: 13 1/8 (333.4)
I.Gskt: [2] Included



Measurements Are Shown In Inches And (Millimeters)

WARNING: These products can expose you to chemicals, including Diisononyl Phthalate, Carbon black extracts, Nickel, 1,3 Butadiene, Ethylene Oxide, Epichlorohydrin, which are known to the State of California to cause cancer, and Bisphenol, Ethylene Glycol, Ethylene Oxide, 1,3 Butadiene, Epichlorohydrin, which are known to the State of California to cause birth defects or other reproductive harm. For more information go to www.P65Warnings.ca.gov.

PT8442



Hydraulic Element

Fits: Ingersoll-Rand Compressors
Replaces: Ingersoll-Rand 39123229, 39123237
O.D.: 4 3/8 (111.1)
I.D.: 11/16 (17.5) & 2 7/16 (61.9)
Height: 16 1/32 (407.2)
A. Gskt: [1] Attached
Grommets: [1] Attached

P8448



Hydraulic Element

Replaces: Fleetguard HFKW800T
O.D.: 5 (127.0)
I.D.: 3/8 (9.5) & 7/8 (22.2)
Height: 4 5/32 (105.6)
A. Gskt: [1] Attached
F. Gskt: [1] Included

BT8443



Hydraulic or Lube Spin-on

Notes: Can be used with OB1318 and OB1320 bases.
Fits: Zinga Hydraulic Heads
Replaces: LHA SPE25-10; Zinga AE10L
Thread: 1 -12
O.D.: 3 23/32 (94.5)
Height: 8 3/16 (208.0)
I.Gskt: G401

BT8449



Hydraulic Spin-on

Fits: Allis Chalmers, Barber-Greene, Case, Grove, John Deere, Steiger Equipment; Eaton Lift Trucks
Replaces: Marvel 451217-5125
Thread: 1 5/16 -12
O.D.: 3 7/8 (98.4)
Height: 5 25/32 (146.8)
F. Gskt: [1] Included
O-Ring: G247

BT8444



Hydraulic Spin-on

Fits: Dynapac Rollers
Replaces: Dynapac 499519; Gehl 334609074830; Voith 90.6103.10
Thread: 1 -12
O.D.: 3 23/32 (94.5)
Height: 8 3/16 (208.0)
I.Gskt: [1] Included

BT8449-10



Hydraulic Spin-on

Fits: Allis Chalmers, Barber-Greene, Case, Grove, John Deere, Steiger Equipment; Eaton Lift Trucks
Replaces: Marvel 451217-1110, 451217-5110
Thread: 1 5/16 -12
O.D.: 3 7/8 (98.4)
Height: 5 25/32 (146.8)
F. Gskt: [1] Included
O-Ring: G247

BT8445



Hydraulic Spin-on

Fits: Joy Compressors
Replaces: Sullivan 190052012
Thread: 1 -12
O.D.: 3 11/16 (93.7)
Height: 5 3/8 (136.5)
I.Gskt: G381-A

BT8450



Hydraulic Spin-on

Contains: Anti-Drainback Valve
 15 PSID By-Pass Valve
Fits: New Holland Equipment
Replaces: U.C.C. UC2418; Donaldson P550269
Thread: 1 1/4 -11 BSP-PL
O.D.: 5 (127.0)
Height: 7 3/32 (180.2)
I.Gskt: [1] Included
Related To: BT351 (without Anti-Drainback, By-Pass Valve)
 BT8475 (Micron Difference)
 BT8476, BT8477 (Long Versions, Micron Difference)

PT8446-MPG



Maximum Performance Glass Hydraulic Element

Fits: Heil Garbage Packer
Replaces: Schroeder 18LS7, 18LZ10
O.D.: 3 7/8 (98.4)
I.D.: 2 1/4 (57.2)
Height: 18 1/2 (469.9)
I.Gskt: [2] Included

PT8451-MPG



Wire Mesh Supported Maximum Performance Glass Hydraulic Element

Fits: Hitachi, John Deere Equipment
Replaces: John Deere AT147821, AT186554
O.D.: 1 31/32 (50.0)
I.D.: 29/32 (23.0) One End
Height: 6 (152.4)
I.Gskt: [1] Included
O-Ring: [2] Included

PT8447-MPG



Maximum Performance Glass Hydraulic Element

Fits: CMI Slip Form Paver, Rotomill
Replaces: Pall HC8900FDN16H, HC8900FKN16H, HC8900FUN16H
O.D.: 3 25/32 (96.0)
I.D.: 2 7/32 (56.4) One End
Height: 16 7/8 (428.6)
I.Gskt: [1] Included

PT8452



Hydraulic Element

Notes: Inside-Out Flow Direction
Fits: Barko Garbage Trucks
Replaces: Parker 924450
O.D.: 3 1/2 (88.9)
I.D.: 1 9/16 (39.7)
Height: 9 9/32 (235.7)
Grommets: [2] Attached
Related To: PT8489 (Double-Length Version)

Measurements Are Shown In Inches And (Millimeters)



WARNING: These products can expose you to chemicals, including Diisononyl Phthalate, Carbon black extracts, Nickel, 1,3 Butadiene, Ethylene Oxide, Epichlorohydrin, which are known to the State of California to cause cancer, and Bisphenol, Ethylene Glycol, Ethylene Oxide, 1,3 Butadiene, Epichlorohydrin, which are known to the State of California to cause birth defects or other reproductive harm. For more information go to www.P65Warnings.ca.gov.

PT8453 Hydraulic Element
Fits: John Deere Equipment
Replaces: John Deere TH111011
O.D.: 3 1/2 (88.9)
I.D.: 1 27/32 (46.8)
Height: 13 7/8 (352.4)
O-Ring: [2] Included
Grommets: [2] Attached



BT8460 Transmission Spin-on
Contains: 9 PSID By-Pass Valve
Fits: Allison Transmissions; Ford, Freightliner, GMC, Hino, International, Kenworth, Mack, Nissan, Peterbilt Trucks
Replaces: GMC 29537268, 29539579
Thread: 3/4 -20
O.D.: 2 7/8 (73.0)
Height: 3 (76.2)
I.Gskt: [1] Included



PT8455-MPG Maximum Performance Glass Hydraulic Element
Notes: Inside-Out Flow Direction
Fits: J.C. Bamford 426 Series, 434S, 436 Series, 456 Series Loaders; John Deere 1063 Tree Harvester; F106, F106A Motor Graders
Replaces: Heil 7571101
O.D.: 4 5/32 (105.6)
I.D.: 13/32 (10.3) & 2 27/32 (72.2)
Height: 18 5/16 (465.1)
O-Ring: [1] Attached



PT8461 Hydraulic Element
Notes: Inside-Out Flow Direction
Fits: Caterpillar Graders
Replaces: Caterpillar 1R0774
O.D.: 5 1/8 (130.2)
I.D.: 3 11/32 (84.9)
Height: 11 1/16 (281.0)
A. Gskt: [2] Attached



PT8456-MPG Wire Mesh Supported Maximum Performance Glass Hydraulic Element
Notes: Inside-Out Flow Direction
Fits: Various Hydraulic Applications
Replaces: Parker 924453; Donaldson P169557
O.D.: 3 23/32 (94.5)
I.D.: 1 23/32 (43.7)
Height: 9 1/16 (230.2)
Grommets: [2] Attached



PT8462-MPG Maximum Performance Glass Hydraulic Element
Notes: Inside-Out Flow Direction
Fits: Donaldson HAK05, HDK06 Assemblies
Replaces: Donaldson P163859
O.D.: 4 3/8 (111.1)
I.D.: 3/4 (19.1) & 2 7/16 (61.9)
Height: 5 (127.0)
A. Gskt: [1] Attached



BT8457-MPG Maximum Performance Glass Hydraulic Spin-on
Fits: John Deere Equipment
Replaces: John Deere AT180249
Thread: 1 1/2 -16
O.D.: 4 13/16 (122.2)
Height: 11 29/32 (302.4)
I.Gskt: [1] Included



BT8463-MPG Maximum Performance Glass Hydraulic Spin-on
Fits: Various Hydraulic Applications
Use With: OB8711, OB8712, OB8720, OB8721, OB8722, OB8724, OB8731, OB8732, OB8741, OB8742, OB8743, OB8744, OB8745, OB8746 filter bases.
Replaces: Donaldson P165335; Fleetguard HF6556
Thread: 1 3/8 -12
O.D.: 3 3/4 (95.3)
Height: 6 1/8 (155.6)
I.Gskt: [1] Included



PT8458-MPG Wire Mesh Supported Maximum Performance Glass Hydraulic Element
Contains: Viton O-Ring for high heat applications.
Replaces: Parker 925837; Heil 757051, 7559101
O.D.: 2 3/8 (60.3)
I.D.: 1 (25.4) One End
Height: 9 21/32 (245.3)
O-Ring: [1] Attached



BT8464 Hydraulic Spin-on
Fits: Various Hydraulic Applications
Use With: OB8711, OB8712, OB8720, OB8721, OB8722, OB8724, OB8731, OB8732, OB8741, OB8742, OB8743, OB8744, OB8745, OB8746 filter bases.
Replaces: Donaldson P163405; Fleetguard HF6560
Thread: 1 3/8 -12
O.D.: 3 3/4 (95.3)
Height: 6 1/8 (155.6)
I.Gskt: [1] Included



PT8459 Hydraulic Element
Replaces: Argo P2092301; Renault 6005019557
O.D.: 3 9/32 (83.3)
I.D.: 1 31/32 (50.0)
Height: 8 15/16 (227.0)



BT8465 Hydraulic Spin-on
Fits: Various Hydraulic Applications
Use With: OB8711, OB8712, OB8720, OB8721, OB8722, OB8724, OB8731, OB8732, OB8741, OB8742, OB8743, OB8744, OB8745, OB8746 filter bases.
Replaces: Donaldson P163558; Fleetguard HF6577
Thread: 1 3/8 -12
O.D.: 3 3/4 (95.3)
Height: 9 19/32 (243.7)
I.Gskt: [1] Included



Measurements Are Shown In Inches And (Millimeters)

WARNING: These products can expose you to chemicals, including Diisononyl Phthalate, Carbon black extracts, Nickel, 1,3 Butadiene, Ethylene Oxide, Epichlorohydrin, which are known to the State of California to cause cancer, and Bisphenol, Ethylene Glycol, Ethylene Oxide, 1,3 Butadiene, Epichlorohydrin, which are known to the State of California to cause birth defects or other reproductive harm. For more information go to www.P65Warnings.ca.gov.

BT8466-MPG



Maximum Performance Glass Hydraulic Spin-on
Fits: Various Hydraulic Applications
Use With: OB8711, OB8712, OB8720, OB8721, OB8722, OB8724, OB8731, OB8732, OB8741, OB8742, OB8743, OB8744, OB8745, OB8746 filter bases.
Replaces: Donaldson P163546; Fleetguard HF6578
Thread: 1 3/8 -12
O.D.: 3 15/16 (100.0)
Height: 9 7/16 (239.7)
I.Gskt: [1] Included

BT8473



Hydraulic Spin-on
Replaces: MP Filtri CS070P10A
Thread: 3/4 -14 BSP-PL
O.D.: 3 11/16 (93.7)
Height: 8 5/32 (207.2)
I.Gskt: G381-A

PT8467



Hydraulic Element
Fits: Parker Hannifin Hydraulic Systems
Replaces: Heil 7557201; Parker 926326
O.D.: 4 7/16 (112.7)
I.D.: 1 11/16 (42.9) One End
Height: 9 1/2 (241.3)
F. Gskt: [1] Included
O-Ring: [1] Attached

BT8474



Hydraulic Spin-on
Replaces: MP Filtri CS070P25A
Thread: 3/4 -14 BSP-PL
O.D.: 3 11/16 (93.7)
Height: 8 5/32 (207.2)
I.Gskt: G381-A

PT8468



Hydraulic Element
Replaces: Parker 926566; Schroeder A3
O.D.: 3 (76.2)
I.D.: 1 1/16 (27.0)
Height: 4 11/16 (119.1)
A. Gskt: [2] Attached

BT8475



Hydraulic Spin-on
Replaces: MP Filtri CS100P25A; U.C.C. UCMX1591425; Zinga SE25G
Thread: 1 1/4 -11 BSP-PL
O.D.: 5 (127.0)
Height: 7 3/32 (180.2)
I.Gskt: [1] Included
Related To: BT8450 (with Anti-Drainback Valve, 15 PSID By-Pass Valve)

PT8470



Hydraulic Element
Replaces: Parker 924451
O.D.: 3 1/2 (88.9)
I.D.: 1 9/16 (39.7)
Height: 9 9/32 (235.7)
Grommets: [2] Attached
Related To: PT8511 (Double-Length Version)

BT8475-MPG



Wire Mesh Supported Maximum Performance Glass Hydraulic Spin-on
Replaces: MP Filtri CS100A25; Woodgate WGH9176
Thread: 1 1/4 -11 BSP-PL
O.D.: 5 1/16 (128.6)
Height: 7 1/16 (179.4)

BT8471-MPG



Maximum Performance Glass Hydraulic Spin-on
Fits: Gradall Material Handlers
Replaces: Gradall 91143144
Thread: 1 1/2 -16
O.D.: 5 1/16 (128.6)
Height: 10 3/4 (273.1)
F. Gskt: [1] Included
O. Gskt: G369-V, G704, G710

BT8476



Hydraulic Spin-on
Fits: Belloli Trucks; Liebherr Loaders
Replaces: Liebherr 7010930; MP Filtri CS150P10A
Thread: 1 1/4 -11 BSP-PL
O.D.: 5 1/8 (130.2)
Height: 8 11/16 (220.7)
I.Gskt: [1] Included

BT8472



Hydraulic Spin-on
Fits: Afron Manlift
Replaces: MP Filtri CS050P25A
Thread: 3/4 -14 BSP-PL
O.D.: 3 11/16 (93.7)
Height: 5 3/8 (136.5)
I.Gskt: G381-A

BT8476-MPG



Maximum Performance Glass Hydraulic Spin-on
Fits: Belloli Trucks; Liebherr Loaders
Replaces: MP Filtri CS150A10
Thread: 1 1/4 -11 BSP-PL
O.D.: 5 1/8 (130.2)
Height: 8 11/16 (220.7)
I.Gskt: [1] Included

Measurements Are Shown In Inches And (Millimeters)

! **WARNING:** These products can expose you to chemicals, including Diisononyl Phthalate, Carbon black extracts, Nickel, 1,3 Butadiene, Ethylene Oxide, Epichlorohydrin, which are known to the State of California to cause cancer, and Bisphenol, Ethylene Glycol, Ethylene Oxide, 1,3 Butadiene, Epichlorohydrin, which are known to the State of California to cause birth defects or other reproductive harm. For more information go to www.P65Warnings.ca.gov.

BT8477 Hydraulic Spin-on
Fits: Case Tractors; Manitou Equipment; TCL Topper Hedgers
Replaces: Manitou 485695; MP Filtri CS150P25A
Thread: 1 1/4 -11 BSP-PL
O.D.: 5 1/8 (130.2)
Height: 8 11/16 (220.7)
I.Gskt: [1] Included



PT8484 Hydraulic Element with Bail Handle
Contains: 43.5 PSID By-Pass Valve
Fits: J.C. Bamford Equipment
Replaces: J.C. Bamford 32/910100, 32/913500
O.D.: 2 9/16 (65.1)
I.D.: 1 9/32 (32.5) One End
Height: 8 31/32 (227.8)



BT8477-MPG Wire Mesh Supported Maximum Performance Glass Hydraulic Spin-on
Fits: Manitou Loaders; TCL Topper Hedgers
Replaces: MP Filtri CS150A25; Woodgate WGH9182
Thread: 1 1/4 -11 BSP-PL
O.D.: 5 1/32 (127.8)
Height: 8 15/16 (227.0)



PT8485 Hydraulic Element
Fits: Schroeder Hydraulic Systems
Replaces: Schroeder N10
O.D.: 1 25/32 (45.2)
I.D.: 23/32 (18.3) One End
Height: 5 9/32 (134.1)



PT8478 High Pressure Hydraulic Element
Contains: Reinforced Centertube
Fits: Hitachi, John Deere, Komatsu Equipment
Replaces: Hitachi 4333469; Komatsu 7063-01-383, 2086-06-1150; Fiat 4287634, 76580323
O.D.: 7 (177.8)
I.D.: 4 5/16 (109.5)
Height: 17 3/4 (450.9)
O-Ring: [1] Included



BT8486 Transmission Spin-on
Fits: Cub Cadet Lawn & Garden Tractors
Replaces: Cub Cadet 7233014, 9233014
Thread: 3/4 -16
O.D.: 3 3/4 (95.3)
Height: 3 31/32 (100.8)
I.Gskt: G381-A



PT8479 Hydraulic Element
Contains: Reinforced Centertube
Fits: Hitachi Excavators
Replaces: Hitachi 3501404
O.D.: 3 17/32 (89.7)
I.D.: 1 29/32 (48.4)
Height: 11 7/16 (290.5)
F. Gskt: [1] Included
O-Ring: [2] Attached

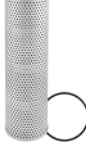

PT8487 Power Steering Element
Notes: Inside-Out Flow Direction
Fits: Freightliner, Peterbilt Trucks
Replaces: Donaldson P550698; Nelson 83284D
O.D.: 4 (101.6)
I.D.: 1 3/32 (27.8) & 1 15/32 (37.3)
Height: 5 7/32 (132.6)
A. Gskt: [2] Attached



PT8480 Depth-Pack 2-Section In-Line Hydraulic Element
Fits: Hitachi Excavators
Replaces: Hitachi 4185299
O.D.: 5 1/2 (139.7)
Inlet: 7/8
Outlet: 7/8
Length: 11 15/16 (303.2)
O-Ring: [2] Attached, [1] Included
Grommets: [2] Attached



BT8488 Hydraulic Spin-on
Fits: Case-International, Kubota, New Holland Tractors
Replaces: Kubota 33960-82631
Thread: 1 1/8 -16
O.D.: 3 23/32 (94.5)
Height: 7 1/32 (178.6)
I.Gskt: [1] Included



PT8481 Hydraulic Element
Replaces: Parker 924732, 924734
O.D.: 2 3/4 (69.9)
I.D.: 1 5/8 (41.3)
Height: 8 27/32 (224.6)
End Seals: [2] Attached



PT8489 2-Section Hydraulic Element
Notes: Inside-Out Flow Direction
Contains: Grommet Seal Between Sections
Fits: Various Equipment with Parker Hydraulic Systems
Replaces: Parker 924792
O.D.: 3 1/2 (88.9)
I.D.: 1 9/16 (39.7)
Height: 18 9/16 (471.5)
Grommets: [3] Attached
Related To: PT8452 (Single-Length Version)



Measurements Are Shown In Inches And (Millimeters)

WARNING: These products can expose you to chemicals, including Diisononyl Phthalate, Carbon black extracts, Nickel, 1,3 Butadiene, Ethylene Oxide, Epichlorohydrin, which are known to the State of California to cause cancer, and Bisphenol, Ethylene Glycol, Ethylene Oxide, 1,3 Butadiene, Epichlorohydrin, which are known to the State of California to cause birth defects or other reproductive harm. For more information go to www.P65Warnings.ca.gov.

PT8490-MPG Maximum Performance Glass Hydraulic Element with Bail Handle



Contains: Nylon Mesh Media
Replaces: Dresser AK3570
O.D.: 4 1/8 (104.8)
I.D.: 2 13/32 (61.1)
Height: 12 5/16 (312.7)
O-Ring: [2] Attached

PT8496-MPG Maximum Performance Glass Hydraulic Element



Contains: Reinforced Centertube
Fits: Caterpillar Equipment
Replaces: Caterpillar 132-8876
O.D.: 5 1/8 (130.2)
I.D.: 3 3/8 (85.7)
Height: 9 1/16 (230.2)
A. Gskt: [2] Attached

PT8491 Hydraulic Element



Notes: Inside-Out Flow Direction
Fits: Donaldson HFK08 Housing; Wagner Mining Equipment
Replaces: Donaldson P161365; Fleetguard HF6489
O.D.: 6 (152.4)
I.D.: 23/32 (18.3) & 3 17/32 (89.7)
Height: 18 1/32 (458.0)
Grommets: [1] Attached

BT8497-MPG Wire Mesh Supported Maximum Performance Glass Hydraulic Spin-on



Fits: John Deere Skidders
Replaces: John Deere AT182209
Thread: 1 -12
O.D.: 3 23/32 (94.5)
Height: 8 1/8 (206.4)
I.Gskt: [1] Included

PT8492 High Pressure Hydraulic Element



Contains: Reinforced Centertube
Fits: John Deere Excavators; Samsung, Volvo Equipment
Replaces: John Deere AT201793
O.D.: 7 (177.8)
I.D.: 4 5/16 (109.5)
Height: 17 3/4 (450.9)
O-Ring: [1] Included

PT8498 Hydraulic Element



Contains: Viton O-Ring for high heat applications
Fits: Blue Bird Buses with Allison Transmissions
Replaces: Parker 925835
O.D.: 2 3/8 (60.3)
I.D.: 1 (25.4) One End
Height: 9 5/8 (244.5)
O-Ring: [1] Attached

BT8493 Hydraulic or Transmission Spin-on



Contains: Anti-Drainback Valve
 14 PSID By-Pass Valve
Fits: Eaton Lift Trucks
Replaces: Hyster 8500023; Yale 518801624
Thread: 3/4 -16
O.D.: 3 11/16 (93.7)
Height: 2 29/32 (73.8)
I.Gskt: G401

BT8499 Hydraulic Spin-on



Fits: John Deere Lawn & Garden Tractors
Replaces: John Deere AM116156
Thread: 1 -14
O.D.: 3 11/16 (93.7)
Height: 3 13/16 (96.8)
I.Gskt: G381-A

PT8494 Wire Mesh Supported Hydraulic Element



Notes: Inside-Out Flow Direction
Fits: Case Excavators; Donaldson HAK05 Assembly
Replaces: Case S104929; Donaldson P160516
O.D.: 4 3/8 (111.1)
I.D.: 23/32 (18.3) & 2 13/32 (61.1)
Height: 16 1/16 (408.0)
A. Gskt: [1] Attached
Grommets: [1] Attached

BT8501-MPG Maximum Performance Glass Hydraulic Spin-on



Fits: John Deere Equipment
Replaces: John Deere RE17380; Donaldson P551234
Thread: 1 -12
O.D.: 3 11/16 (93.7)
Height: 5 13/32 (137.3)
I.Gskt: G401

PT8495-MPG Nylon Mesh Supported Maximum Performance Glass Hydraulic Element



Fits: Haulpak Trucks
Replaces: Dresser AK3572
O.D.: 3 1/8 (79.4)
I.D.: 1 15/16 (49.2) One End
Height: 16 17/32 (419.9)
O-Ring: [1] Attached

BT8502 Hydraulic Spin-on



Replaces: Parker 926543; Donaldson P551550; Fleetguard HF6500
Thread: 1 -12
O.D.: 3 11/16 (93.7)
Height: 5 13/32 (137.3)
I.Gskt: G401

BT8503-MPG Maximum Performance Glass Hydraulic Spin-on





Fits: New Holland, Versatile Tractors
Replaces: New Holland 86016760; Fleetguard HF29000
Thread: M90 x 2.0
O.D.: 4 23/32 (119.9)
Height: 7 11/16 (195.3)
I.Gskt: [1] Included

Measurements Are Shown In Inches And (Millimeters)

WARNING: These products can expose you to chemicals, including Diisononyl Phthalate, Carbon black extracts, Nickel, 1,3 Butadiene, Ethylene Oxide, Epichlorohydrin, which are known to the State of California to cause cancer, and Bisphenol, Ethylene Glycol, Ethylene Oxide, 1,3 Butadiene, Epichlorohydrin, which are known to the State of California to cause birth defects or other reproductive harm. For more information go to www.P65Warnings.ca.gov.

BT8504 Transmission Spin-on

Contains: 8 PSID By-Pass Valve
Fits: Ford, New Holland Tractors
Replaces: Ford D8NN-B486-CA
Thread: 1 1/8 -16
O.D.: 3 11/16 (93.7)
Height: 6 5/8 (168.3)
I.Gskt: G381-A

PT8511 Hydraulic Element

Contains: Grommet Seal Between Sections
Replaces: Parker 924790; Donaldson P169558; Fleetguard HF7779
O.D.: 3 1/2 (88.9)
I.D.: 1 9/16 (39.7)
Height: 18 9/16 (471.5)
Grommets: [2] Attached
Related To: PT8470 (Single-Length Version)

BT8505 Hydraulic Spin-on

Fits: Ford, New Holland Tractors
Replaces: Ford SBA340500410, 83939935
Thread: 1 1/8 -16
O.D.: 3 11/16 (93.7)
Height: 5 21/32 (143.7)
I.Gskt: G401

BT8512 Hydraulic Spin-on

Contains: 40 PSID By-Pass Valve
Fits: Claas, Hamm, Liebherr Equipment
Replaces: Liebherr 5612546, 7004209; Rottne 480101; Fleetguard HF28989
Thread: 1 -12
O.D.: 3 23/32 (94.5)
Height: 6 23/32 (170.7)
I.Gskt: G401

PT8506-MPG Maximum Performance Glass Hydraulic Element

Contains: Reinforced Centertube
Fits: Komatsu Excavators
Replaces: Komatsu 7063-51-100
O.D.: 5 1/8 (130.2)
I.D.: 3 3/8 (85.7)
Height: 11 17/32 (292.9)

PT8517-MPG Wire Mesh Supported Maximum Performance Glass Hydraulic Element

Replaces: Blount 31001609, 31004339; Donaldson P560402
O.D.: 3 29/32 (99.2)
I.D.: 1 5/8 (41.3) & 1 27/32 (46.8)
Height: 18 1/2 (469.9)
A. Gskt: G310
O-Ring: [1] Included
End Seals: ES1039 Attached

PT8507-MPG Maximum Performance Glass Hydraulic Element

Fits: Komatsu Excavators
Replaces: Komatsu 7063-51-054
O.D.: 3 15/16 (100.0)
I.D.: 2 11/32 (59.5)
Height: 8 5/16 (211.1)

PT8519-MPG Wire Mesh Supported Maximum Performance Glass Hydraulic Element

Contains: Viton O-Ring for high heat applications.
Replaces: Pall HC8200FKS16H; Purolator Facet 8200EAL122N3; Donaldson P174547
O.D.: 3 3/32 (78.6)
I.D.: 1 1/2 (38.1) One End
Height: 16 7/8 (428.6)
O-Ring: [1] Attached

BT8509-MPG Maximum Performance Glass Hydraulic Spin-on

Replaces: Pall HC7400SKN8H; PTI F4F040HCB; Donaldson P169392
Thread: 1 1/2 -16
O.D.: 3 11/16 (93.7)
Height: 8 1/16 (204.8)
I.Gskt: [1] Included

OV8700 Heavy-Duty Hydraulic Indicator

Contains: Pop-Up Button
Use With: By-Pass Valve Pressure of 25 PSID
Replaces: Donaldson P162696

OV8701 Heavy-Duty Hydraulic Indicator

Contains: Pop-up Button
Use With: By-Pass Valve Pressure of 50 PSID
Replaces: Donaldson P167580

BT8510-MPG Maximum Performance Glass Hydraulic Spin-on

Fits: Hypac, Tigercat Equipment; Taylor Lift Trucks
Replaces: Pall HC7500SKT8H
Thread: 1 1/2 -16
O.D.: 5 1/16 (128.6)
Height: 10 3/4 (273.1)
F. Gskt: [1] Included

OS8703 Heavy-Duty Hydraulic Indicator

Notes: 2-Wire AC/DC
Use With: By-Pass Valve Pressure of 50 PSID
Replaces: Donaldson P171087

OS8704 Single Post Electrical Hydraulic Indicator

Notes: Normally Open
Use With: By-Pass Valve Pressure of 25 PSID
Replaces: Donaldson P162400

Measurements Are Shown In Inches And (Millimeters)

WARNING: These products can expose you to chemicals, including Diisononyl Phthalate, Carbon black extracts, Nickel, 1,3 Butadiene, Ethylene Oxide, Epichlorohydrin, which are known to the State of California to cause cancer, and Bisphenol, Ethylene Glycol, Ethylene Oxide, 1,3 Butadiene, Epichlorohydrin, which are known to the State of California to cause birth defects or other reproductive harm. For more information go to www.P65Warnings.ca.gov.

OS8705

Single Post Electrical Hydraulic Indicator



Notes: Normally Open
Use With: By-Pass Valve Pressure of 50 PSID
Replaces: Donaldson P165194

OS8706

Heavy-Duty Hydraulic Indicator



Notes: 3-Wire AC/DC
Use With: By-Pass Valve Pressure of 25 PSID
Replaces: Donaldson P173944

OS8707

Heavy-Duty Hydraulic Indicator



Notes: 3-Wire AC/DC
Use With: By-Pass Valve Pressure of 50 PSID
Replaces: Donaldson P173893

OP8709

Hydraulic Plug



Notes: To be used with PureForce Hydraulic Bases where an indicator port plug is needed.
Replaces: Donaldson P165983
Thread: 9/16 -18
Length: 1 3/16 (27.8)
O-Ring: [2] Included

OB8711

Hydraulic Filter Base



Contains: 25 PSID By-Pass Valve
Threaded Stud: 1 3/8-12
[2] Indicator Ports with Plugs
Use With: 4 Inch O.D. PureForce Filters
Replaces: Donaldson P169317
O.D.: 3 31/32 (100.8)
Inlet: 3/4 In. NPT
Outlet: 3/4 In. NPT
Height: 4 (101.6)

OB8712

Hydraulic Filter Base with Indicator



Contains: 25 PSID By-Pass Valve
Threaded Stud: 1 3/8-12
[2] Indicator Ports
Visual Indicator Mounted on Left Side
Use With: 4 Inch O.D. PureForce Filters
Replaces: Donaldson P169310
O.D.: 3 31/32 (100.8)
Inlet: 3/4 In. NPT
Outlet: 3/4 In. NPT
Height: 4 (101.6)

OS8717

Single Post Electrical Hydraulic Indicator



Notes: Normally Closed
Use With: By-Pass Valve Pressure of 25 PSID
Replaces: Donaldson P163839

OB8720

Hydraulic Filter Base



Contains: Threaded Stud: 1 3/8-12
Use With: 4 Inch O.D. PureForce Filters
Replaces: Donaldson P165434
O.D.: 3 31/32 (100.8)
Inlet: 3/4 In. SAE O-Ring
Outlet: 3/4 In. SAE O-Ring
Height: 4 (101.6)

OB8721

Hydraulic Filter Base



Contains: 25 PSID By-Pass Valve
Threaded Stud: 1 3/8-12
[2] Indicator Ports with Plugs
Use With: 4 Inch O.D. PureForce Filters
Replaces: Donaldson P167473
O.D.: 3 31/32 (100.8)
Inlet: 3/4 In. SAE O-Ring
Outlet: 3/4 In. SAE O-Ring
Height: 4 (101.6)

OB8722

Hydraulic Filter Base with Indicator



Contains: 25 PSID By-Pass Valve
Threaded Stud: 1 3/8-12
[2] Indicator Ports
Visual Indicator Mounted on Left Side
Use With: 4 Inch O.D. PureForce Filters
Replaces: Donaldson P166387
O.D.: 3 31/32 (100.8)
Inlet: 3/4 In. SAE O-Ring
Outlet: 3/4 In. SAE O-Ring
Height: 4 (101.6)

OB8724

Hydraulic Filter Base



Contains: 50 PSID By-Pass Valve
Threaded Stud: 1 3/8-12
[2] Indicator Ports
Use With: 4 Inch O.D. PureForce Filters
O.D.: 3 3/8 (85.7)
Inlet: 3/4 In. SAE O-Ring
Outlet: 3/4 In. SAE O-Ring
Height: 4 (101.6)

OV8728

Heavy-Duty Hydraulic Indicator



Contains: Auto Reset Pop-up Button
Button Dust Cover
Use With: By-Pass Valve Pressure of 50 PSID
Replaces: Donaldson P167580

OB8731

Hydraulic Filter Base



Contains: 25 PSID By-Pass Valve
Threaded Stud: 1 3/8-12
[2] Indicator Ports with Plugs
Use With: 4 Inch O.D. PureForce Filters
O.D.: 3 31/32 (100.8)
Inlet: 1 In. NPT
Outlet: 1 In. NPT
Height: 4 (101.6)

OB8732

Hydraulic Filter Base with Indicator



Contains: 25 PSID By-Pass Valve
Threaded Stud: 1 3/8-12
[2] Indicator Ports
Visual Indicator Mounted on Left Side
Use With: 4 Inch O.D. PureForce Filters
Replaces: Donaldson P166416
O.D.: 3 31/32 (100.8)
Inlet: 1 In. NPT
Outlet: 1 In. NPT
Height: 4 (101.6)

OB8741

Hydraulic Filter Base



Contains: 25 PSID By-Pass Valve
Threaded Stud: 1 3/8-12
[2] Indicator Ports with Plugs
Use With: 4 Inch O.D. PureForce Filters
Replaces: Donaldson P163681
O.D.: 3 31/32 (100.8)
Inlet: 1 In. SAE O-Ring
Outlet: 1 In. SAE O-Ring
Height: 4 (101.6)

OB8742

Hydraulic Filter Base with Indicator



Contains: 25 PSID By-Pass Valve
Threaded Stud: 1 3/8-12
[2] Indicator Ports
Visual Indicator Mounted on Left Side
Use With: 4 Inch O.D. PureForce Filters
Replaces: Donaldson P166417
O.D.: 3 31/32 (100.8)
Inlet: 1 In. SAE O-Ring
Outlet: 1 In. SAE O-Ring
Height: 4 (101.6)

Measurements Are Shown In Inches And (Millimeters)

! **WARNING:** These products can expose you to chemicals, including Diisononyl Phthalate, Carbon black extracts, Nickel, 1,3 Butadiene, Ethylene Oxide, Epichlorohydrin, which are known to the State of California to cause cancer, and Bisphenol, Ethylene Glycol, Ethylene Oxide, 1,3 Butadiene, Epichlorohydrin, which are known to the State of California to cause birth defects or other reproductive harm. For more information go to www.P65Warnings.ca.gov.

OB8743 Hydraulic Filter Base with Indicator
Notes: Normally Open
Contains: 25 PSID By-Pass Valve
 Threaded Stud: 1 3/8-12
 [2] Indicator Ports
 Single Post Indicator Mounted on Left Side
Use With: 4 Inch O.D. PureForce Filters
Replaces: Donaldson P165537
O.D.: 3 31/32 (100.8)
Inlet: 1 In. SAE O-Ring
Outlet: 1 In. SAE O-Ring
Height: 4 (101.6)



OP8752 Hex Head Plug
Notes: Optional for BF1204-SP, BF1205-SP, BF1249-SP, BF1283-SP, BF1346-SP, BF1348-SP, BF1355-SP
Thread: 1/2 -20
Length: 11/16 (17.5)
O-Ring: [1] Included



OB8744 Hydraulic Filter Base
Contains: 50 PSID By-Pass Valve
 Threaded Stud: 1 3/8-12
 [2] Indicator Ports with Plugs
Use With: 4 Inch O.D. PureForce Filters
Replaces: Donaldson P167201
O.D.: 3 3/8 (85.7)
Inlet: 1 In. SAE O-Ring
Outlet: 1 In. SAE O-Ring
Height: 4 (101.6)



OP8753 Hex Head Plug
Notes: Optional for BF1274-SP, BF1277-SP, BF1378-SPS
Thread: M14 x 2.0
Length: 11/16 (17.5)
O-Ring: [1] Included



OB8745 Hydraulic Filter Base with Indicator
Contains: 50 PSID By-Pass Valve
 Threaded Stud: 1 3/8-12
 [2] Indicator Ports
 Visual Indicator Mounted on Left Side
Use With: 4 Inch O.D. PureForce Filters
O.D.: 3 31/32 (100.8)
Inlet: 1 In. SAE O-Ring
Outlet: 1 In. SAE O-Ring
Height: 4 (101.6)



OB8771 Hydraulic Filter Base
Contains: 25 PSID By-Pass Valve
 Threaded Stud: 1 3/4-12
 [2] Indicator Ports with Plugs
Use With: 5 Inch O.D. PureForce Filters
O.D.: 4 1/2 (114.3)
Inlet: 1 1/4 In. NPT
Outlet: 1 1/4 In. NPT
Height: 5 (127.0)



OB8746 Hydraulic Filter Base with Indicator
Notes: Normally Open
 OBSOLETE. Availability limited to dealer stock.
Contains: 50 PSID By-Pass Valve
 Threaded Stud: 1 3/8-12
 [2] Indicator Ports
 Single Post Indicator Mounted on Left Side
Use With: 4 Inch O.D. PureForce Filters
Replaces: Donaldson P166862
O.D.: 3 31/32 (100.8)
Inlet: 1 In. SAE O-Ring
Outlet: 1 In. SAE O-Ring
Height: 4 (101.6)



OB8772 Hydraulic Filter Base
Contains: 25 PSID By-Pass Valve
 Threaded Stud: 1 3/4-12
 [2] Indicator Ports
 Visual Indicator Mounted on Left Side
Use With: 5 Inch O.D. PureForce Filters
O.D.: 4 1/2 (114.3)
Inlet: 1 1/4 In. NPT
Outlet: 1 1/4 In. NPT
Height: 5 (127.0)



OP8750 Hex Head Plug
Notes: Optional for BF1223-SP, BF1329-SP.
 Furnished with: BF1284-SP, BF1330-SP, BF1351-SP, BF1358-SP, BF1374-SP, BF1382-SP
Thread: 9/16 -18
Length: 11/16 (17.5)
O-Ring: [1] Included



OB8773 Hydraulic Filter Base with Indicator
Notes: Normally Open
Contains: 25 PSID By-Pass Valve
 Threaded Stud: 1 3/4-12
 [2] Indicator Ports
 Single Post Indicator Mounted on Left Side
Use With: 5 Inch O.D. PureForce Filters
Replaces: Donaldson P167621
O.D.: 4 1/2 (114.3)
Inlet: 1 1/4 In. NPT
Outlet: 1 1/4 In. NPT
Height: 5 (127.0)



OP8751 Hex Head Plug
Notes: Optional for BF1222-SP, BF1345-SP
Thread: 7/16 -20
Length: 11/16 (17.5)
O-Ring: [1] Included

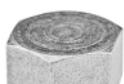

CFB8784 Dual Coolant Filter Base
Contains: Threaded Stud: 11/16-16
 [2] Brass Plugs
Fits: All Coolant Spin-ons with 11/16-16 Thread
Inlet: 3/8-18 NPT
Outlet: 3/8-18 NPT
Length: 8 3/16 (208.0)
Height: 2 17/32 (64.3)



Measurements Are Shown In Inches And (Millimeters)

WARNING: These products can expose you to chemicals, including Diisononyl Phthalate, Carbon black extracts, Nickel, 1,3 Butadiene, Ethylene Oxide, Epichlorohydrin, which are known to the State of California to cause cancer, and Bisphenol, Ethylene Glycol, Ethylene Oxide, 1,3 Butadiene, Epichlorohydrin, which are known to the State of California to cause birth defects or other reproductive harm. For more information go to www.P65Warnings.ca.gov.

BT8800-MPG

Maximum Performance Glass Hydraulic Spin-on



Notes: Uses 2 filters per application.
Fits: John Deere Equipment
Replaces: John Deere AT209204, AT210148
Thread: 1 1/2 -16
O.D.: 4 13/16 (122.2)
Height: 11 9/16 (293.7)
I.Gskt: [1] Included

BT8813-MPG

Maximum Performance Glass Hydraulic Spin-on



Fits: John Deere Equipment
Replaces: John Deere AT140315
Thread: 1 1/2 -16
O.D.: 4 13/16 (122.2)
Height: 11 9/16 (293.7)
I.Gskt: [1] Included

BT8801-MPG

Maximum Performance Glass Hydraulic Spin-on



Fits: John Deere Equipment
Replaces: John Deere AT184206; Komatsu 1233914-H1, 1233914-H2, 1233914-H4
Thread: 1 1/2 -16
O.D.: 4 13/16 (122.2)
Height: 7 15/32 (189.7)
I.Gskt: [1] Included

BT8830

Transmission Spin-on



Contains: 20 PSID By-Pass Valve
Fits: Case, Clark, Fiat-Allis, Gradall, Volvo Equipment
Replaces: Clark 247050; Fiat 73118171; Volvo 11993686, 11993682
Thread: 2 -16
O.D.: 3 11/16 (93.7)
Height: 5 21/32 (143.7)
I.Gskt: G401

BT8802-MPG

Maximum Performance Glass Hydraulic Spin-on



Fits: John Deere Equipment
Replaces: John Deere AT103193
Thread: 1 1/2 -16
O.D.: 4 13/16 (122.2)
Height: 7 15/32 (189.7)
I.Gskt: [1] Included

BT8831

Hydraulic Spin-on



Fits: Clark Lift Trucks
Replaces: Clark 2366807
Thread: 2 -16
O.D.: 3 11/16 (93.7)
Height: 7 7/32 (183.4)
I.Gskt: G401

BT8803-MPG

Maximum Performance Glass Hydraulic Spin-on



Fits: Hitachi Loaders
Replaces: Hitachi 4230344
Thread: 1 1/2 -16
O.D.: 4 13/16 (122.2)
Height: 11 9/16 (293.7)
I.Gskt: [1] Included

BT8832

Hydraulic Spin-on



Contains: 20 PSID By-Pass Valve
Fits: Hitachi Equipment; Hyster Lift Trucks
Replaces: Hyster 1315621
Thread: 2 -16
O.D.: 3 11/16 (93.7)
Height: 7 7/32 (183.4)
I.Gskt: G401

BT8805-MPG

Maximum Performance Glass Transmission Spin-on



Fits: John Deere Equipment
Replaces: John Deere AT167763, AT172912
Thread: 1 1/2 -16
O.D.: 4 13/16 (122.2)
Height: 11 15/32 (291.3)
I.Gskt: [1] Included

BT8833

Hydraulic or Transmission Spin-on



Contains: 35 PSID By-Pass Valve
Fits: Hyundai Loaders
Replaces: Clark 247052; Taylor 3939002
Thread: 2 -16
O.D.: 3 11/16 (93.7)
Height: 7 7/32 (183.4)
I.Gskt: G401

BT8812-MPG

Maximum Performance Glass Hydraulic Spin-on



Fits: John Deere Equipment
Replaces: John Deere AT144879
Thread: 1 1/2 -16
O.D.: 4 13/16 (122.2)
Height: 7 15/32 (189.7)
I.Gskt: [1] Included

BT8834-MPG

Maximum Performance Glass Hydraulic Spin-on



Contains: Viton gasket for high heat applications
Fits: Caterpillar Equipment; Freeman Hay Balers
Use With: OB8711, OB8712, OB8720, OB8721, OB8722, OB8724, OB8731, OB8732, OB8741, OB8742, OB8743, OB8744, OB8745, OB8746 filter bases.
Replaces: Ingersoll-Rand 39911615
Thread: 1 3/8 -12
O.D.: 3 13/16 (96.8)
Height: 9 7/16 (239.7)
I.Gskt: [1] Included

Measurements Are Shown In Inches And (Millimeters)

WARNING: These products can expose you to chemicals, including Diisononyl Phthalate, Carbon black extracts, Nickel, 1,3 Butadiene, Ethylene Oxide, Epichlorohydrin, which are known to the State of California to cause cancer, and Bisphenol, Ethylene Glycol, Ethylene Oxide, 1,3 Butadiene, Epichlorohydrin, which are known to the State of California to cause birth defects or other reproductive harm. For more information go to www.P65Warnings.ca.gov.

BT8840-MPG Maximum Performance Glass Hydraulic Spin-on
Notes: Rated 1000 PSI minimum burst.
Fits: Bobcat, Case, Caterpillar, Ingram, John Deere, Vermeer Equipment
Use With: OB8711, OB8712, OB8720, OB8721, OB8722, OB8724, OB8731, OB8732, OB8741, OB8742, OB8743, OB8744, OB8745, OB8746 filter bases.
Replaces: Case A165029; Clark 6630977; Melroe-Bobcat 6661248; Vermeer 81902001
Thread: 1 3/8 -12
O.D.: 3 3/4 (95.3)
Height: 6 1/8 (155.6)
I.Gskt: [1] Included



BT8841-MPG Maximum Performance Glass Hydraulic Spin-on
Notes: Rated 1000 PSI minimum burst.
Fits: J.C. Bamford, John Deere, Komatsu Equipment; Ingersoll-Rand Compressors
Use With: OB8711, OB8712, OB8720, OB8721, OB8722, OB8724, OB8731, OB8732, OB8741, OB8742, OB8743, OB8744, OB8745, OB8746 filter bases.
Replaces: Ingersoll-Rand 58887936; J.C. Bamford 32/905501; John Deere AL77061; New Holland 82003166
Thread: 1 3/8 -12
O.D.: 3 3/4 (95.3)
Height: 6 3/32 (154.8)
I.Gskt: [1] Included



BT8842-MPG Maximum Performance Glass Hydraulic Spin-on
Notes: Rated 1000 PSI minimum burst.
Fits: Case, Caterpillar Equipment; Swinger Loaders; Thermo King Compressors
Use With: OB8711, OB8712, OB8720, OB8721, OB8722, OB8724, OB8731, OB8732, OB8741, OB8742, OB8743, OB8744, OB8745, OB8746 filter bases.
Replaces: Ford 3576-P165354; Thermo King 66-4917
Thread: 1 3/8 -12
O.D.: 3 3/4 (95.3)
Height: 6 1/8 (155.6)
I.Gskt: [1] Included



BT8843-MPG Maximum Performance Glass Hydraulic Spin-on
Contains: 50 PSID Front-End By-Pass Valve By-Pass Screen
Replaces: Clark 2792962
Thread: 7/8 -14
O.D.: 3 3/4 (95.3)
Height: 6 1/32 (153.2)
I.Gskt: [1] Included



BT8844 Hydraulic Spin-on
Notes: Rated 1000 PSI minimum burst.
Fits: Bobcat, Michigan, TCM Loaders
Use With: OB8711, OB8712, OB8720, OB8721, OB8722, OB8724, OB8731, OB8732, OB8741, OB8742, OB8743, OB8744, OB8745, OB8746 filter bases.
Replaces: Clark 6599543
Thread: 1 3/8 -12
O.D.: 3 3/4 (95.3)
Height: 6 1/8 (155.6)
I.Gskt: [1] Included



BT8845 Hydraulic Spin-on
Notes: Rated 1000 PSI minimum burst.
Fits: Caterpillar, Dynapac Equipment
Use With: OB8711, OB8712, OB8720, OB8721, OB8722, OB8724, OB8731, OB8732, OB8741, OB8742, OB8743, OB8744, OB8745, OB8746 filter bases.
Replaces: Caterpillar 90-2900
Thread: 1 3/8 -12
O.D.: 3 3/4 (95.3)
Height: 6 1/8 (155.6)
I.Gskt: [1] Included



BT8846 Hydraulic Spin-on
Notes: Rated 1000 PSI minimum burst.
Fits: Case, Ditch Witch, Magnum, Vermeer Equipment
Use With: OB8711, OB8712, OB8720, OB8721, OB8722, OB8724, OB8731, OB8732, OB8741, OB8742, OB8743, OB8744, OB8745, OB8746 filter bases.
Replaces: Case D122562; Vermeer 67581001
Thread: 1 3/8 -12
O.D.: 3 3/4 (95.3)
Height: 6 1/8 (155.6)
I.Gskt: [1] Included



BT8847 Hydraulic Spin-on
Notes: Rated 1000 PSI minimum burst.
Fits: Toro Equipment
Use With: OB8711, OB8712, OB8720, OB8721, OB8722, OB8724, OB8731, OB8732, OB8741, OB8742, OB8743, OB8744, OB8745, OB8746 filter bases.
Replaces: Ingersoll-Rand 39136650
Thread: 1 3/8 -12
O.D.: 3 3/4 (95.3)
Height: 6 1/8 (155.6)
I.Gskt: [1] Included



BT8848-MPG Maximum Performance Glass Hydraulic Spin-on
Notes: Rated 1000 PSI minimum burst.
Fits: John Deere, New Holland Loaders
Use With: OB8711, OB8712, OB8720, OB8721, OB8722, OB8724, OB8731, OB8732, OB8741, OB8742, OB8743, OB8744, OB8745, OB8746 filter bases.
Replaces: John Deere M124541; New Holland 9800633, 9842392, 89842392
Thread: 1 3/8 -12
O.D.: 3 3/4 (95.3)
Height: 8 1/32 (204.0)
I.Gskt: [1] Included



BT8849-MPG Maximum Performance Glass Hydraulic Spin-on
Notes: Rated 1000 PSI minimum burst.
Use With: OB8711, OB8712, OB8720, OB8721, OB8722, OB8724, OB8731, OB8732, OB8741, OB8742, OB8743, OB8744, OB8745, OB8746 filter bases.
Thread: 1 3/8 -12
O.D.: 3 3/4 (95.3)
Height: 6 3/32 (154.8)
I.Gskt: [1] Included



Measurements Are Shown In Inches And (Millimeters)

WARNING: These products can expose you to chemicals, including Diisononyl Phthalate, Carbon black extracts, Nickel, 1,3 Butadiene, Ethylene Oxide, Epichlorohydrin, which are known to the State of California to cause cancer, and Bisphenol, Ethylene Glycol, Ethylene Oxide, 1,3 Butadiene, Epichlorohydrin, which are known to the State of California to cause birth defects or other reproductive harm. For more information go to www.P65Warnings.ca.gov.

BT8850-MPG



Maximum Performance Glass Hydraulic Spin-on
Notes: Rated 1000 PSI minimum burst.
 NOT interchangeable with BT8851-MPG.
Fits: Case, Case-International, Caterpillar, Daewoo, Fiat-Allis, John Deere, Kawasaki, New Holland, Steiger, Thomas Equipment
Use With: OB8711, OB8712, OB8720, OB8721, OB8722, OB8724, OB8731, OB8732, OB8741, OB8742, OB8743, OB8744, OB8745, OB8746 filter bases.
Replaces: Case D94236; Caterpillar 9T5916; Fiat 73144499; John Deere RE34958
Thread: 1 3/8 -12
O.D.: 3 3/4 (95.3)
Height: 9 17/32 (242.1)
I.Gskt: [1] Included

BT8851-MPG



Maximum Performance Glass Hydraulic Spin-on
Notes: Rated 1000 PSI minimum burst.
 NOT interchangeable with BT8850-MPG.
Fits: Agco, Caterpillar, Cedarapids, Ford, Gehl, John Deere, New Holland, Vermeer, V.M.E., Volvo Equipment
Use With: OB8711, OB8712, OB8720, OB8721, OB8722, OB8724, OB8731, OB8732, OB8741, OB8742, OB8743, OB8744, OB8745, OB8746 filter bases.
Replaces: Agco 303506819; Caterpillar 1G8878; Cedarapids 451750014101; John Deere RE47313; New Holland 89821387; Vermeer 73113001; V.M.E. 110366077
Thread: 1 3/8 -12
O.D.: 3 3/4 (95.3)
Height: 9 19/32 (243.7)
I.Gskt: [1] Included

BT8852-MPG



Maximum Performance Glass Hydraulic Spin-on
Notes: Rated 1000 PSI minimum burst.
Fits: John Deere Equipment
Use With: OB8711, OB8712, OB8720, OB8721, OB8722, OB8724, OB8731, OB8732, OB8741, OB8742, OB8743, OB8744, OB8745, OB8746 filter bases.
Replaces: John Deere AH128449
Thread: 1 3/8 -12
O.D.: 3 3/4 (95.3)
Height: 9 19/32 (243.7)
I.Gskt: [1] Included

BT8853-MPG



Maximum Performance Glass Hydraulic Spin-on
Notes: Rated 1000 PSI minimum burst.
Fits: Case, Caterpillar Equipment
Use With: OB8711, OB8712, OB8720, OB8721, OB8722, OB8724, OB8731, OB8732, OB8741, OB8742, OB8743, OB8744, OB8745, OB8746 filter bases.
Replaces: Case N14232; John Deere RE39390
Thread: 1 3/8 -12
O.D.: 3 3/4 (95.3)
Height: 9 17/32 (242.1)
I.Gskt: [1] Included

BT8855-MPG



Maximum Performance Glass Hydraulic Spin-on
Notes: Rated 1000 PSI minimum burst.
Fits: Various Hydraulic Applications
Use With: OB8711, OB8712, OB8720, OB8721, OB8722, OB8724, OB8731, OB8732, OB8741, OB8742, OB8743, OB8744, OB8745, OB8746 filter bases.
Replaces: Donaldson P167590
Thread: 1 3/8 -12
O.D.: 3 3/4 (95.3)
Height: 9 19/32 (243.7)
I.Gskt: [1] Included

BT8856-MPG



Maximum Performance Glass Hydraulic Spin-on
Notes: Rated 1000 PSI minimum burst.
Fits: Sakai Equipment
Use With: OB8711, OB8712, OB8720, OB8721, OB8722, OB8724, OB8731, OB8732, OB8741, OB8742, OB8743, OB8744, OB8745, OB8746 filter bases.
Replaces: Koehring 853531235, 8535301235
Thread: 1 3/8 -12
O.D.: 3 3/4 (95.3)
Height: 9 19/32 (243.7)
I.Gskt: [1] Included

BT8861



Hydraulic Spin-on
Notes: Rated 1000 PSI minimum burst.
Fits: Bobcat Loaders; Case Equipment
Use With: OB8711, OB8712, OB8720, OB8721, OB8722, OB8724, OB8731, OB8732, OB8741, OB8742, OB8743, OB8744, OB8745, OB8746 filter bases.
Replaces: Case D126922; Champion 44419; Timberjack 8428088; Versatile 79446
Thread: 1 3/8 -12
O.D.: 3 3/4 (95.3)
Height: 9 19/32 (243.7)
I.Gskt: [1] Included

BT8862



Hydraulic Spin-on
Notes: Rated 1000 PSI minimum burst.
Fits: Champion, Versatile Equipment
Use With: OB8711, OB8712, OB8720, OB8721, OB8722, OB8724, OB8731, OB8732, OB8741, OB8742, OB8743, OB8744, OB8745, OB8746 filter bases.
Replaces: Case N7332
Thread: 1 3/8 -12
O.D.: 3 3/4 (95.3)
Height: 9 19/32 (243.7)
I.Gskt: [1] Included

BT8863



Hydraulic Spin-on
Notes: Rated 1000 PSI minimum burst.
Fits: Timberjack Logging Equipment
Use With: OB8711, OB8712, OB8720, OB8721, OB8722, OB8724, OB8731, OB8732, OB8741, OB8742, OB8743, OB8744, OB8745, OB8746 filter bases.
Replaces: Case D89909
Thread: 1 3/8 -12
O.D.: 3 3/4 (95.3)
Height: 9 19/32 (243.7)
I.Gskt: [1] Included

Measurements Are Shown In Inches And (Millimeters)

WARNING: These products can expose you to chemicals, including Diisononyl Phthalate, Carbon black extracts, Nickel, 1,3 Butadiene, Ethylene Oxide, Epichlorohydrin, which are known to the State of California to cause cancer, and Bisphenol, Ethylene Glycol, Ethylene Oxide, 1,3 Butadiene, Epichlorohydrin, which are known to the State of California to cause birth defects or other reproductive harm. For more information go to www.P65Warnings.ca.gov.

BT8870-MPG Maximum Performance Glass Hydraulic Spin-on
Fits: Case-International, Caterpillar, John Deere Equipment
Use With: OB8771, OB8772, OB8773 filter bases.
Replaces: International 1971728-C1; John Deere RE51797
Thread: 1 3/4 -12
O.D.: 4 23/32 (119.9)
Height: 14 1/8 (358.8)
I.Gskt: [1] Included
Related To: BT9560-MPG (Micron Difference)



BT8878-MPG Maximum Performance Glass Hydraulic Spin-on
Fits: Caterpillar, Champion Equipment
Use With: OB8771, OB8772, OB8773 filter bases.
Replaces: Champion 45543
Thread: 1 3/4 -12
O.D.: 4 23/32 (119.9)
Height: 11 17/32 (292.9)
I.Gskt: [1] Included



BT8873 Hydraulic Spin-on
Fits: Champion, Clark, Daewoo, Link-Belt, V.M.E., Volvo Equipment
Use With: OB8771, OB8772, OB8773 filter bases.
Replaces: Champion 37104; Clark 243622, 965899
Thread: 1 3/4 -12
O.D.: 4 3/4 (120.7)
Height: 11 17/32 (292.9)
I.Gskt: [1] Included



BT8879-MPG Maximum Performance Glass Hydraulic Spin-on
Fits: Caterpillar, Timberjack, Volvo Equipment
Use With: OB8771, OB8772, OB8773 filter bases.
Replaces: Timberjack F434370
Thread: 1 3/4 -12
O.D.: 4 23/32 (119.9)
Height: 11 17/32 (292.9)
I.Gskt: [1] Included



BT8874-MPG Maximum Performance Glass Hydraulic Spin-on
Fits: Case, Ford, John Deere, New Holland, Versatile Equipment
Use With: OB8771, OB8772, OB8773 filter bases.
Replaces: Case N9086, A49386; John Deere AT112393; New Holland 9821388
Thread: 1 3/4 -12
O.D.: 4 23/32 (119.9)
Height: 11 17/32 (292.9)
I.Gskt: [1] Included



BT8880-MPG Maximum Performance Glass Hydraulic Spin-on
Fits: Ford, New Holland Equipment; Versatile Tractors
Use With: OB8771, OB8772, OB8773 filter bases.
Replaces: New Holland 9706161, 89706161
Thread: 1 3/4 -12
O.D.: 4 23/32 (119.9)
Height: 7 3/4 (196.9)
I.Gskt: [1] Included



BT8875-MPG Maximum Performance Glass Hydraulic Spin-on
Fits: Caterpillar Crawler Tractors
Use With: OB8771, OB8772, OB8773 filter bases.
Replaces: Caterpillar 9T6636
Thread: 1 3/4 -12
O.D.: 4 23/32 (119.9)
Height: 7 3/4 (196.9)
I.Gskt: [1] Included



PT8883 Hydraulic Element
Fits: Drott Equipment; Poclain Excavators
Replaces: Case R1050586
O.D.: 3 25/32 (96.0)
I.D.: 13/32 (10.3) & 2 11/16 (68.3)
Height: 6 23/32 (170.7)
A. Gskt: [1] Attached



BT8876-MPG Maximum Performance Glass Hydraulic Spin-on
Fits: Caterpillar, Champion Equipment; Ingersoll-Rand Compressors; Volvo Motor Graders
Use With: OB8771, OB8772, OB8773 filter bases.
Replaces: Caterpillar 9T0973; Champion 49076; Ingersoll-Rand 51302214
Thread: 1 3/4 -12
O.D.: 4 3/4 (120.7)
Height: 11 19/32 (294.5)
I.Gskt: [1] Included



PT8884-MPG Wire Mesh Supported Maximum Performance Glass Hydraulic Element
Contains: Viton O-Ring for high heat applications.
Replaces: Parker 932636Q, 983061
O.D.: 3 19/32 (91.3)
I.D.: 1 29/32 (48.4) One End
Height: 7 27/32 (199.2)
O-Ring: [1] Included



BT8877-MPG Maximum Performance Glass Hydraulic Spin-on
Fits: Various Hydraulic Applications
Use With: OB8771, OB8772, OB8773 filter bases.
Replaces: Donaldson P170906
Thread: 1 3/4 -12
O.D.: 4 23/32 (119.9)
Height: 11 17/32 (292.9)
I.Gskt: [1] Included



PT8885-MPG Wire Mesh Supported Maximum Performance Glass Hydraulic Element
Replaces: Schroeder KZ25
O.D.: 3 29/32 (99.2)
I.D.: 1 5/8 (41.3)
Height: 9 1/8 (231.8)
Grommets: [2] Attached



Measurements Are Shown In Inches And (Millimeters)

WARNING: These products can expose you to chemicals, including Diisononyl Phthalate, Carbon black extracts, Nickel, 1,3 Butadiene, Ethylene Oxide, Epichlorohydrin, which are known to the State of California to cause cancer, and Bisphenol, Ethylene Glycol, Ethylene Oxide, 1,3 Butadiene, Epichlorohydrin, which are known to the State of California to cause birth defects or other reproductive harm. For more information go to www.P65Warnings.ca.gov.

BT8886-MPG

Maximum Performance Glass Hydraulic Spin-on



Fits: Ag-Chem Ro-Gators;
Caterpillar Equipment
Replaces: Ag-Chem 714122;
Donaldson P173702
Thread: 2 -12
O.D.: 3 1/8 (79.4)
Height: 9 17/32 (242.1)

BT8892-MPG

Maximum Performance Glass Hydraulic Spin-on



Fits: Ingersoll-Rand Compressors
Use With: OB8771, OB8772, OB8773 filter
bases.
Replaces: Ingersoll-Rand 36860336;
Donaldson P165672
Thread: 1 3/4 -12
O.D.: 4 23/32 (119.9)
Height: 11 17/32 (292.9)
I.Gskt: [1] Included

PT8887

Hydraulic Element



Contains: Viton O-Ring for high heat
applications
Fits: Terex Equipment
Replaces: Parker 922625;
Donaldson P164556; Fleetguard HF7739
O.D.: 2 3/8 (60.3)
I.D.: 1 (25.4) One End
Height: 5 5/16 (134.9)
O-Ring: [1] Attached

PT8893

Hydraulic Element



Fits: Caterpillar Excavators
Replaces: Caterpillar 93-5369
O.D.: 4 13/32 (111.9)
I.D.: 2 3/4 (69.9)
Height: 11 9/16 (293.7)

PT8888

Hydraulic Element



Replaces: Schroeder CC10;
Donaldson P171315; Fleetguard HF7314
O.D.: 2 7/8 (73.0)
I.D.: 1 (25.4) One End
Height: 9 5/8 (244.5)
I.Gskt: [1] Included

PT8894-MPG

Wire Mesh Supported Maximum Performance
Glass Hydraulic Element



Fits: Liebherr Excavators
Replaces: Liebherr 7363107
O.D.: 1 27/32 (46.8)
I.D.: 7/8 (22.2) One End
Height: 3 5/16 (84.1)
O-Ring: [1] Attached

PT8889

Hydraulic Element



Fits: Caterpillar Excavators
Replaces: Caterpillar 94-3229
O.D.: 5 29/32 (150.0)
I.D.: 4 11/32 (110.3)
Height: 11 13/16 (300.0)
F. Gskt: [1] Included

PT8895-MPG

Wire Mesh Supported Maximum Performance
Glass Hydraulic Element



Fits: Case-International, New Holland Tractors
Replaces: Case N3150506;
Fleetguard HF30196
O.D.: 2 3/32 (53.2)
I.D.: 7/8 (22.2) One End
Height: 4 9/16 (115.9)
O-Ring: [1] Attached

BT8890-MPG

Maximum Performance Glass Hydraulic Spin-on



Fits: John Deere Compact Utility Tractors
Replaces: John Deere LVA11522
Thread: 1 1/2 -16
O.D.: 4 21/32 (118.3)
Height: 6 9/32 (159.5)
I.Gskt: [1] Included

PT8896

Hydraulic Element



Fits: Samsung, Volvo Excavators
Replaces: Volvo 104100130
O.D.: 5 29/32 (150.0)
I.D.: 4 11/32 (110.3)
Height: 17 23/32 (450.1)

PT8891-MPG

Maximum Performance Glass 2-Section
Hydraulic Element



Contains: Grommet Between Sections
Fits: Hood Forestry Equipment
Replaces: Parker 932410, 932694Q;
Donaldson P174914; Fleetguard HF35000
O.D.: 3 11/16 (93.7)
I.D.: 1 9/16 (39.7) One End
Height: 18 15/16 (481.0)
Grommets: [1] Attached

PT8897-MPG

Wire Mesh Supported Maximum Performance
Glass Hydraulic Element



Contains: 87 PSID By-Pass Valve
Fits: Case Excavators
Replaces: Case C2950511
O.D.: 2 7/8 (73.0)
I.D.: 1 11/32 (34.1) One End
Height: 15 5/32 (385.0)
O-Ring: [1] Attached

Measurements Are Shown In Inches And (Millimeters)

! WARNING: These products can expose you to chemicals, including Diisononyl Phthalate, Carbon black extracts, Nickel, 1,3 Butadiene, Ethylene Oxide, Epichlorohydrin, which are known to the State of California to cause cancer, and Bisphenol, Ethylene Glycol, Ethylene Oxide, 1,3 Butadiene, Epichlorohydrin, which are known to the State of California to cause birth defects or other reproductive harm. For more information go to www.P65Warnings.ca.gov.

BT8898 Hydraulic Spin-on
Fits: Hitachi, Kubota Excavators, Loaders
Replaces: Kubota 6813-16-2130
Thread: 1 1/8 -16
O.D.: 3 11/16 (93.7)
Height: 5 21/32 (143.7)
I.Gskt: G401



BT8904-MPG Maximum Performance Glass Hydraulic Spin-on
Notes: Rated 1000 PSI minimum burst.
 Dome end accepts 1/2 In. socket driver.
Fits: John Deere Tractors
Replaces: John Deere AL156625;
 Mann & Hummel WH945
Thread: 1 3/8 -12
O.D.: 3 3/4 (95.3)
Height: 6 11/32 (161.1)
I.Gskt: [1] Included



BT8899 Hydraulic Spin-on
Contains: 15 PSID By-Pass Valve
 By-Pass Screen
Fits: New Holland Tractors
Replaces: New Holland 5174044
Thread: 1 3/4 -16
O.D.: 5 3/8 (136.5)
Height: 7 (177.8)
I.Gskt: [1] Included



BT8905 Hydraulic Spin-on
Fits: Case-International, Ford, New Holland
 Mowers, Tractors
Replaces: Ford SBA340500770,
 SBA340500890; New Holland 87300195,
 87300196; Fleetguard HF35254
Thread: 3/4 -16
O.D.: 3 23/32 (94.5)
Height: 3 7/8 (98.4)
I.Gskt: G324-A



BT8900 Stainless Steel Mesh Hydraulic Spin-on
Contains: 100 Mesh Media
Fits: Kubota Tractors
Replaces: Kubota 35861-82630
Thread: 1 -12
O.D.: 3 11/16 (93.7)
Height: 7 3/16 (182.6)
I.Gskt: G401



BT8906 Hydraulic Spin-on
Contains: Retainer Ring
Fits: Samsung, Volvo Excavators
Replaces: Volvo 104207040;
 Fleetguard HF7935
Thread: M48 x 2.0
O.D.: 5 9/32 (134.1)
Height: 6 27/32 (173.8)
I.Gskt: [1] Included



BT8901-MPG Maximum Performance Glass Hydraulic Spin-on
Fits: Case-International Tractors
Replaces: Case 1976934C4, 1976934C5
Thread: 1 1/2 -16
O.D.: 5 1/32 (127.8)
Height: 6 31/32 (177.0)
F. Gskt: G369-B, G372, G447



PT8907-MPG Wire Mesh Supported Maximum Performance
 Glass Hydraulic Element
Fits: Case-International Tractors
Replaces: Case 93402-C1, 93413-C1
O.D.: 5 3/32 (129.4)
I.D.: 2 9/16 (65.1)
Height: 3 (76.2)
A. Gskt: [2] Attached
O-Ring: [3] Included
Related To: PT565 (Standard Media Version)



BT8902 Hydraulic Spin-on
Fits: Kubota Tractors
Replaces: Kubota 67955-37710
Thread: M20 x 1.5
O.D.: 3 (76.2)
Height: 4 13/16 (122.2)
I.Gskt: [1] Included



BT8908 Hydraulic Spin-on
Fits: Kubota Excavators
Replaces: Kubota 68051-62220;
 Yanmar 172638-73730
Thread: 3/4 -16
O.D.: 3 1/32 (77.0)
Height: 4 3/32 (104.0)
I.Gskt: [1] Included



BT8903 Hydraulic Spin-on
Fits: Industrial Applications
Replaces: LHA SPE25-25; PTI F4E04DCB;
 Donaldson P550256
Thread: 1 -12
O.D.: 3 11/16 (93.7)
Height: 8 25/32 (223.0)
I.Gskt: G401



PT8909 Hydraulic Element
Fits: Link-Belt, Sumitomo Excavators
Replaces: Case 159274A1;
 Link-Belt KRJ3836
O.D.: 5 29/32 (150.0)
I.D.: 4 11/32 (110.3)
Height: 17 29/32 (454.8)
A. Gskt: [2] Attached



Measurements Are Shown In Inches And (Millimeters)

WARNING: These products can expose you to chemicals, including Diisononyl Phthalate, Carbon black extracts, Nickel, 1,3 Butadiene, Ethylene Oxide, Epichlorohydrin, which are known to the State of California to cause cancer, and Bisphenol, Ethylene Glycol, Ethylene Oxide, 1,3 Butadiene, Epichlorohydrin, which are known to the State of California to cause birth defects or other reproductive harm. For more information go to www.P65Warnings.ca.gov.

BT8910-MPG

Maximum Performance Glass Hydraulic Spin-on



Fits: John Deere Tractors
Use With: OB8771, OB8772, OB8773 filter bases.
Replaces: John Deere RE38965; Donaldson P173521
Thread: 1 3/4 -12
O.D.: 4 23/32 (119.9)
Height: 11 17/32 (292.9)
I.Gskt: [1] Included

BT8911-MPG

Maximum Performance Glass Hydraulic Spin-on



Fits: New Holland Loaders
Use With: OB8771, OB8772, OB8773 filter bases.
Replaces: New Holland 85802793; Donaldson P176779
Thread: 1 3/4 -12
O.D.: 4 23/32 (119.9)
Height: 11 17/32 (292.9)
I.Gskt: [1] Included

PT8912

Hydraulic Element



Fits: Fiat-Allis, New Holland Motor Graders
Replaces: New Holland 73125853
O.D.: 5 1/8 (130.2)
I.D.: 3 3/8 (85.7)
Height: 9 (228.6)

BT8913-MPG

Maximum Performance Glass Hydraulic Spin-on



Replaces: MP Filtri CS50A25; Woodgate WGH9166
Thread: 3/4 -14 BSP-PL
O.D.: 3 3/4 (95.3)
Height: 5 23/32 (145.3)

BT8914

Hydraulic Spin-on



Contains: Threaded hex nut for removal.
Replaces: Fairey-Arlon CXX3-10; Fleetguard HF35135; Woodgate WGCX3-10
Thread: M60 x 1.5
O.D.: 3 31/32 (100.8)
Height: 7 1/4 (184.2)

BT8915

Hydraulic Spin-on



Contains: Water Absorbent Media
Replaces: Filtrec A121CW10; Woodgate WGH1792
Thread: 1 1/4 -11 BSP-PL
O.D.: 5 1/8 (130.2)
Height: 8 29/32 (226.2)
I.Gskt: [1] Included

BT8916

Hydraulic Spin-on



Replaces: New Holland 87761096; Woodgate WGH1819
Thread: 3/4 -16
O.D.: 3 11/16 (93.7)
Height: 4 1/16 (103.2)
I.Gskt: [1] Included

BT8917

Hydraulic Spin-on



Replaces: Mitsubishi 4060100260; Woodgate WGH1825
Thread: M20 x 1.5
O.D.: 3 1/8 (79.4)
Height: 3 (76.2)
I.Gskt: [1] Included

BT8918

Hydraulic Spin-on



Contains: Threaded hex nut for removal.
Fits: Toro Lawn & Garden Tractors
Replaces: Toro 67-8110; Fleetguard HF6357; Woodgate WGH1835
Thread: 1 -12
O.D.: 3 21/32 (92.9)
Height: 4 1/4 (108.0)
I.Gskt: [1] Included

BT8919

Hydraulic Spin-on



Fits: Kato Excavators
Replaces: Kato 68935703032; Woodgate WGH1844
Thread: M22 x 1.5
O.D.: 3 7/8 (98.4)
Height: 5 7/32 (132.6)
I.Gskt: [1] Included

BT8920

Hydraulic Spin-on



Fits: Case-International, New Holland Tractors
Replaces: Fiat-Iveco 1930986; Fleetguard HF28833; Woodgate WGH1906
Thread: M40 x 2.0
O.D.: 4 3/16 (106.4)
Height: 7 1/16 (179.4)
I.Gskt: [1] Included

BT8921

Hydraulic Spin-on



Contains: 3 PSID By-Pass Valve
Fits: Deutz Tractors
Replaces: Deutz 4411047; Woodgate WGH1915
Thread: 1 1/2 -16
O.D.: 5 11/32 (135.7)
Height: 7 1/32 (178.6)
I.Gskt: [1] Included

BT8922

Hydraulic Spin-on



Contains: 36 PSID By-Pass Valve
Replaces: Manitou 137658; Fleetguard HF6315; Woodgate WGH6315
Thread: 3/4 -16
O.D.: 3 3/4 (95.3)
Height: 5 25/32 (146.8)
I.Gskt: [1] Included

Measurements Are Shown In Inches And (Millimeters)



WARNING: These products can expose you to chemicals, including Diisononyl Phthalate, Carbon black extracts, Nickel, 1,3 Butadiene, Ethylene Oxide, Epichlorohydrin, which are known to the State of California to cause cancer, and Bisphenol, Ethylene Glycol, Ethylene Oxide, 1,3 Butadiene, Epichlorohydrin, which are known to the State of California to cause birth defects or other reproductive harm. For more information go to www.P65Warnings.ca.gov.

BT8926 Hydraulic Spin-on
Contains: 51 PSID By-Pass Valve
Fits: Deutz Tractors
Replaces: Deutz 4399525; Fleetguard HF28818; Woodgate WGH950-5
Thread: 1 -12
O.D.: 3 21/32 (92.9)
Height: 6 25/32 (172.2)
I.Gskt: [1] Included



BT8937 Hydraulic Spin-on
Replaces: Benford 17032; Fleetguard HF6327; Woodgate WGH9994
Thread: 1 1/2 -11 BSP-PL
O.D.: 5 1/32 (127.8)
Height: 7 19/32 (192.9)



BT8927 Hydraulic Spin-on
Fits: Hitachi Equipment; Kubota Excavators
Replaces: Woodgate WGH9996
Thread: 1 7/8 -12
O.D.: 5 7/32 (132.6)
Height: 6 7/8 (174.6)
I.Gskt: [1] Included



PT8938-MPG Wire Mesh Supported Maximum Performance Glass Hydraulic Element
Replaces: Fairey-Arlon FTXW10RCC10; Woodgate WGFW10RCC-10
O.D.: 7 15/16 (201.6)
I.D.: 5 7/8 (149.2)
Height: 13 (330.2)



BT8928 Hydraulic Spin-on
Replaces: MP Filtri CS50M60; Woodgate WGH9168
Thread: 3/4 -14 BSP-PL
O.D.: 3 3/4 (95.3)
Height: 5 3/4 (146.1)



PT8939-MPG Wire Mesh Supported Maximum Performance Glass Hydraulic Element
Fits: Demag Cranes
Replaces: Demag 69022273; Fleetguard HF35271; Woodgate WGH1736
O.D.: 4 21/32 (118.3)
I.D.: 2 11/32 (59.5)
Height: 6 9/16 (167.5)
O-Ring: [2] Attached



BT8930 Wire Mesh Hydraulic Spin-on
Replaces: MP Filtri CS100M125; Woodgate WGH9177
Thread: 1 1/4 -11 BSP-PL
O.D.: 5 1/16 (128.6)
Height: 7 3/32 (180.2)
I.Gskt: [1] Included



PT8940-MPG Wire Mesh Supported Maximum Performance Glass Hydraulic Element
Fits: Manitou Equipment
Replaces: Manitou 563483; Woodgate WGH1794
O.D.: 2 23/32 (69.1)
I.D.: 1 5/32 (29.4)
Height: 6 29/32 (175.4)
O-Ring: [1] Attached



BT8931 Wire Mesh Hydraulic Spin-on
Replaces: MP Filtri CS150M60; Woodgate WGH9184
Thread: 1 1/4 -11 BSP-PL
O.D.: 5 1/16 (128.6)
Height: 9 (228.6)



PT8941-MPG Wire Mesh Supported Maximum Performance Glass Hydraulic Element
Replaces: Finn FC1073F025BS; Woodgate WGH1818
O.D.: 4 5/32 (105.6)
I.D.: 1 1/4 (31.8) & 2 27/32 (72.2)
Height: 19 7/16 (493.7)
O-Ring: [1] Attached



BT8935 Hydraulic Spin-on
Contains: 25 PSID By-Pass Valve
Fits: New Holland Equipment
Replaces: U.C.C. UC2408; Fleetguard HF7901; Woodgate WGUC2408
Thread: 3/4 -14 BSP-PL
O.D.: 3 3/4 (95.3)
Height: 5 3/4 (146.1)
I.Gskt: [1] Included



PT8943-MPG Wire Mesh Supported Maximum Performance Glass Hydraulic Element
Replaces: Demag 694400; Woodgate WGH1960
O.D.: 9 (228.6)
I.D.: 7 3/32 (180.2)
Height: 21 1/2 (546.1)
A. Gskt: [2] Attached



Measurements Are Shown In Inches And (Millimeters)

 **WARNING:** These products can expose you to chemicals, including Diisononyl Phthalate, Carbon black extracts, Nickel, 1,3 Butadiene, Ethylene Oxide, Epichlorohydrin, which are known to the State of California to cause cancer, and Bisphenol, Ethylene Glycol, Ethylene Oxide, 1,3 Butadiene, Epichlorohydrin, which are known to the State of California to cause birth defects or other reproductive harm. For more information go to www.P65Warnings.ca.gov.

PT8945-MPG

Wire Mesh Supported Maximum Performance
Glass Hydraulic Element



Replaces: Argo V3092308;
Woodgate WGH3208
O.D.: 3 17/32 (89.7)
I.D.: 1 9/16 (39.7) One End
Height: 9 5/32 (232.6)
O-Ring: [1] Attached

PT8952-MPG

Wire Mesh Supported Maximum Performance
Glass Hydraulic Element



Replaces: Stauff SL014E10B;
Woodgate WGH9860
O.D.: 1 27/32 (46.8)
I.D.: 1 (25.4) One End
Height: 3 11/16 (93.7)

PT8946-MPG

Wire Mesh Supported Maximum Performance
Glass Hydraulic Element



Contains: 36 PSID By-Pass Valve
Replaces: Argo V3052056;
Woodgate WGH3556
O.D.: 1 13/16 (46.0)
I.D.: 3/4 (19.1) One End
Height: 7 27/32 (199.2)
O-Ring: [1] Attached

PT8954-MPG

Wire Mesh Supported Maximum Performance
Glass Hydraulic Element



Fits: Liebherr Equipment
Replaces: Hydac 110D020BNHC;
Woodgate WGH11020DB
O.D.: 1 27/32 (46.8)
I.D.: 13/16 (20.6) One End
Height: 6 1/32 (153.2)
O-Ring: [1] Attached

PT8947-MPG

Wire Mesh Supported Maximum Performance
Glass Hydraulic Element



Fits: Caterpillar Excavators
Replaces: Atlas Copco 8231-1018-04;
Woodgate WGH9164
O.D.: 4 21/32 (118.3)
I.D.: 2 11/32 (59.5)
Height: 6 13/32 (162.7)
O-Ring: [2] Attached

PT8955-MPG

Wire Mesh Supported Maximum Performance
Glass Hydraulic Element



Fits: Roadtec Equipment
Replaces: Hydac 160D010BH;
Woodgate WGH16010DH
O.D.: 2 23/32 (69.1)
I.D.: 1 11/32 (34.2) One End
Height: 4 17/32 (115.1)
O-Ring: [1] Attached

PT8948-MPG

Maximum Performance Glass Hydraulic
Element with Bail Handle



Contains: 25 PSID By-Pass Valve
Replaces: MP Filtri MF1003AA10HB;
Woodgate WGH9528
O.D.: 2 3/4 (69.9)
I.D.: 1 5/8 (41.3) One End
Height: 8 1/16 (204.8)
O-Ring: [1] Attached, [1] Included
Spring: [1] Included

PT8956-MPG

Wire Mesh Supported Maximum Performance
Glass Hydraulic Element with Bail Handle



Contains: 43 PSID By-Pass Valve
Replaces: Hydac 160R010BNHC;
Woodgate WGH16010RB
O.D.: 2 7/8 (73.0)
I.D.: 1 13/32 (35.7) One End
Height: 5 21/32 (143.7)

PT8950-MPG

Wire Mesh Supported Maximum Performance
Glass Hydraulic Element with Bail Handle



Contains: 72 PSID By-Pass Valve
Replaces: MP Filtri MF7501AA25HB;
Fleetguard HF35220; Woodgate WGH9592
O.D.: 5 1/8 (130.2)
I.D.: 2 15/32 (62.7) One End
Height: 16 7/32 (412.0)
Spring: [1] Included
Grommets: [1] Attached

PT8957-MPG

Wire Mesh Supported Maximum Performance
Glass Hydraulic Element



Replaces: Hydac 160D020BNHC; Fleetguard
HF30702; Woodgate WGH16020DB
O.D.: 2 23/32 (69.1)
I.D.: 1 5/16 (33.3) One End
Height: 4 9/16 (115.9)
O-Ring: [1] Attached

PT8951-MPG

Wire Mesh Supported Maximum Performance
Glass Hydraulic Element



Replaces: MP Filtri CU630A25NA;
Woodgate WGH9651
O.D.: 5 1/8 (130.2)
I.D.: 2 29/32 (73.8)
Height: 9 13/16 (249.2)
O-Ring: [2] Attached

PT8958-MPG

Wire Mesh Supported Maximum Performance
Glass Hydraulic Element with Bail Handle



Contains: 43 PSID By-Pass Valve
Replaces: Hydac 165R020BN3HC;
Woodgate WGH165020RB
O.D.: 2 3/8 (60.3)
I.D.: 1 13/32 (35.7) One End
Height: 9 (228.6)

Measurements Are Shown In Inches And (Millimeters)

WARNING: These products can expose you to chemicals, including Diisononyl Phthalate, Carbon black extracts, Nickel, 1,3 Butadiene, Ethylene Oxide, Epichlorohydrin, which are known to the State of California to cause cancer, and Bisphenol, Ethylene Glycol, Ethylene Oxide, 1,3 Butadiene, Epichlorohydrin, which are known to the State of California to cause birth defects or other reproductive harm. For more information go to www.P65Warnings.ca.gov.

PT8959-MPG

Wire Mesh Supported Maximum Performance
Glass Hydraulic Element



Replaces: Hydac 240D005BNHC;
Woodgate WGHH24005DB
O.D.: 2 23/32 (69.1)
I.D.: 1 9/32 (32.5) One End
Height: 6 27/32 (173.8)
O-Ring: [1] Attached

PT8970-MPG

Wire Mesh Supported Maximum Performance
Glass Hydraulic Element



Notes: Inside-Out Flow Direction
Replaces: Fairey-Arlon TXW8BCC10;
Fleetguard HF7958; Woodgate WGTW8BCC-10
O.D.: 4 31/32 (126.2)
I.D.: 13/32 (10.3) & 3 5/8 (92.1)
Height: 15 11/32 (389.7)

PT8960-MPG

Wire Mesh Supported Maximum Performance
Glass Hydraulic Element



Replaces: Hydac 30D010BNHC; Fleetguard
HF30348; Woodgate WGHH30010DB
O.D.: 1 3/8 (34.9)
I.D.: 1/2 (12.7) One End
Height: 3 21/32 (92.9)
O-Ring: [1] Attached

PT8971-MPG

Wire Mesh Supported Maximum Performance
Glass Hydraulic Element



Notes: Inside-Out Flow Direction
Replaces: Fairey-Arlon TXW8CCC10;
Fleetguard HF7964; Woodgate WGTW8CCC-10
O.D.: 4 31/32 (126.2)
I.D.: 13/32 (10.3) & 3 5/8 (92.1)
Height: 18 29/32 (480.2)
O-Ring: [1] Attached

PT8962-MPG

Wire Mesh Supported Maximum Performance
Glass Hydraulic Element



Fits: Telesco Pelle Loaders
Replaces: Hydac 60D010BNHC; Fleetguard
HF30710; Woodgate WGHH60010DB
O.D.: 1 27/32 (46.8)
I.D.: 7/8 (22.2) One End
Height: 3 5/16 (84.1)
O-Ring: [1] Attached

PT8972-MPG

Wire Mesh Supported Maximum Performance
Glass Hydraulic Element



Fits: Caterpillar Equipment
Replaces: Argo V3051008;
Woodgate WGH1939
O.D.: 1 25/32 (45.2)
I.D.: 13/16 (20.6) One End
Height: 4 3/32 (104.0)
O-Ring: [1] Attached

PT8963-MPG

Wire Mesh Supported Maximum Performance
Glass Hydraulic Element



Replaces: Woodgate WGTW3CC-25
O.D.: 2 27/32 (72.2)
I.D.: 11/32 (8.7) & 2 1/32 (51.6)
Height: 5 29/32 (150.0)
O-Ring: [1] Attached

PT8974-MPG

Wire Mesh Supported Maximum Performance
Glass Hydraulic Element



Replaces: Terex 15266831;
Woodgate WGH1964
O.D.: 2 3/8 (60.3)
I.D.: 1 13/32 (35.7) One End
Height: 5 11/32 (135.7)
O-Ring: [1] Attached

PT8967-MPG

Wire Mesh Supported Maximum Performance
Glass Hydraulic Element



Notes: Inside-Out Flow Direction
Replaces: Fairey-Arlon TXW5CC25;
Woodgate WGTW5CC-25
O.D.: 4 3/16 (106.4)
I.D.: 13/32 (10.3) & 2 27/32 (72.2)
Height: 10 9/32 (261.1)
O-Ring: [1] Attached

PT8975-MPG

Wire Mesh Supported Maximum Performance
Glass Hydraulic Element



Fits: Caterpillar, Fiat-Hitachi Excavators;
Volvo Dump Trucks
Replaces: Argo V3060708;
Woodgate WGH3708
O.D.: 2 3/16 (55.6)
I.D.: 1 1/8 (28.6) One End
Height: 2 23/32 (69.1)
O-Ring: [1] Attached

PT8969-MPG

Wire Mesh Supported Maximum Performance
Glass Hydraulic Element



Notes: Inside-Out Flow Direction
Replaces: Fairey-Arlon TXW8ACC25;
Woodgate WGTW8ACC-25
O.D.: 4 31/32 (126.2)
I.D.: 13/32 (10.3) & 3 5/8 (92.1)
Height: 11 7/16 (290.5)
O-Ring: [1] Attached

PT8978-MPG











Wire Mesh Supported Maximum Performance
Glass Hydraulic Element

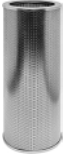

Replaces: MP Filtri HP1352A25NA;
Woodgate WGH9268
O.D.: 2 3/32 (53.2)
I.D.: 1 1/32 (26.2) One End
Height: 9 1/16 (230.2)
O-Ring: [1] Attached

Measurements Are Shown In Inches And (Millimeters)

WARNING: These products can expose you to chemicals, including Diisononyl Phthalate, Carbon black extracts, Nickel, 1,3 Butadiene, Ethylene Oxide, Epichlorohydrin, which are known to the State of California to cause cancer, and Bisphenol, Ethylene Glycol, Ethylene Oxide, 1,3 Butadiene, Epichlorohydrin, which are known to the State of California to cause birth defects or other reproductive harm. For more information go to www.P65Warnings.ca.gov.

<p>PT8980-MPG</p> 	<p>Wire Mesh Supported Maximum Performance Glass Hydraulic Element Replaces: MP Filtri HP3202A06NA; Woodgate WGH9336 O.D.: 3 1/16 (77.8) I.D.: 1 17/32 (38.9) One End Height: 9 1/4 (235.0) O-Ring: [1] Attached</p>	<p>PT8986-MPG</p>  <p>Wire Mesh Supported Maximum Performance Glass Hydraulic Element Replaces: Fairey-Arlon TXW3CC10; Woodgate WGTW3CC-10 O.D.: 2 27/32 (72.2) I.D.: 5/8 (7.9) & 1 25/32 (45.2) Height: 5 29/32 (150.0) O-Ring: [1] Attached</p>
<p>PT8981-MPG</p> 	<p>Wire Mesh Supported Maximum Performance Glass Hydraulic Element with Bail Handle Contains: 43 PSID By-Pass Valve Replaces: Hydac 660R010BNHC; Donaldson P170619; Woodgate WGH66010RB O.D.: 4 1/2 (114.3) I.D.: 2 11/16 (68.3) One End Height: 13 1/8 (333.4)</p>	<p>PT8987-MPG</p>  <p>Maximum Performance Glass Hydraulic Element Notes: Inside-Out Flow Direction Replaces: Fairey-Arlon TXW2CC10; Woodgate WGTW2CC-10 O.D.: 2 27/32 (72.2) I.D.: 9/32 (7.1) & 2 (50.8) Height: 4 3/16 (106.4) O-Ring: [1] Attached</p>
<p>PT8982-MPG</p> 	<p>Wire Mesh Supported Maximum Performance Glass Hydraulic Element Notes: Inside-Out Flow Direction Replaces: Fairey-Arlon TXW4CC25; Woodgate WGTW4CC-25 O.D.: 4 5/32 (105.6) I.D.: 5/8 (7.9) & 2 27/32 (72.9) Height: 7 7/16 (188.9) O-Ring: [1] Attached</p>	<p>PT8989-MPG</p>  <p>Maximum Performance Glass Hydraulic Element with 2 Bail Handles Replaces: J.C. Bamford 32/910801; Fleetguard HF35203; Woodgate WGH9520 O.D.: 2 3/4 (69.9) I.D.: 1 3/32 (27.8) One End Height: 5 7/32 (132.6) O-Ring: [1] Attached Spring: [1] Included</p>
<p>PT8984-MPG</p> 	<p>Wire Mesh Supported Maximum Performance Glass Hydraulic Element Contains: Viton gaskets for high heat applications Spring Locator Replaces: Fairey-Arlon 270Z105A; Woodgate WGAZ2715 O.D.: 2 29/32 (73.8) I.D.: 1 1/4 (31.8) One End Height: 4 1/8 (104.8) O-Ring: [1] Viton O-Ring Attached, [1] Viton O-Ring Included</p>	<p>PT8990-MPG</p>  <p>Wire Mesh Supported Maximum Performance Glass Hydraulic Element Replaces: Fairey-Arlon TXW12CC10; Fleetguard HF7966; Woodgate WGTW12CC-10 O.D.: 7 31/32 (202.4) I.D.: 1/2 (12.7) & 6 3/16 (157.2) Height: 21 15/32 (545.3) O-Ring: [1] Attached</p>
<p>PT8985-MPG</p> 	<p>Wire Mesh Supported Maximum Performance Glass Hydraulic Element Contains: Viton gaskets for high heat applications Spring Locator Replaces: Fairey-Arlon 270Z215A; Woodgate WGAZ2721 O.D.: 2 29/32 (73.8) I.D.: 1 1/4 (31.8) One End Height: 9 11/32 (237.3) O-Ring: [1] Viton O-Ring Attached, [1] Viton O-Ring Included</p>	<p>PT8991-MPG</p>  <p>Wire Mesh Supported Maximum Performance Glass Hydraulic Element Replaces: Fairey-Arlon 170L210A; Woodgate WGAL1721 O.D.: 2 5/32 (54.8) I.D.: 23/32 (18.3) One End Height: 4 29/32 (124.6) O-Ring: [1] Attached, [1] Included</p>
		<p>PT8992-MPG</p>  <p>Wire Mesh Supported Maximum Performance Glass Hydraulic Element Replaces: Fairey-Arlon 370Z205A; Woodgate WGAZ3725 O.D.: 3 11/16 (93.7) I.D.: 1 29/32 (48.4) One End Height: 7 27/32 (199.2) O-Ring: [1] Attached, [1] Included</p>

Measurements Are Shown In Inches And (Millimeters)

 **WARNING:** These products can expose you to chemicals, including Diisononyl Phthalate, Carbon black extracts, Nickel, 1,3 Butadiene, Ethylene Oxide, Epichlorohydrin, which are known to the State of California to cause cancer, and Bisphenol, Ethylene Glycol, Ethylene Oxide, 1,3 Butadiene, Epichlorohydrin, which are known to the State of California to cause birth defects or other reproductive harm. For more information go to www.P65Warnings.ca.gov.

PT8993-MPG Wire Mesh Supported Maximum Performance Glass Hydraulic Element
Replaces: Liebherr 7211191; Fleetguard HF6248; Woodgate WGH2504
O.D.: 3 15/16 (100.0)
I.D.: 1 7/8 (47.6) & 3 1/8 (79.4)
Height: 13 5/8 (346.1)
A. Gskt: [2] Attached



PT8999-MPG Wire Mesh Supported Maximum Performance Glass Hydraulic Element
Replaces: Fairey-Arlon TXW3DCC25; Woodgate WGTW3DCC-25
O.D.: 2 27/32 (72.2)
I.D.: 5/8 (7.9) & 1 25/32 (45.2)
Height: 7 29/32 (200.8)
O-Ring: [1] Attached



PT8994-MPG Wire Mesh Supported Maximum Performance Glass Hydraulic Element
Replaces: Orenstein & Koppel 1771469; Fleetguard HF7560; Woodgate WGH4020
O.D.: 5 3/8 (136.5)
Flange 5 15/16 (150.8)
I.D.: 3 5/32 (80.2) One End
Height: 14 3/32 (358.0)
A. Gskt: [1] Attached



H9001 Wire Mesh Supported Hydraulic Element
Contains: Reinforced Centertube
Fits: Terex Dump Trucks
Replaces: Pall HC8300FKN8H, HC8300FUN8H; Terex 15265318
O.D.: 5 31/32 (151.6)
I.D.: 4 1/8 (104.8)
Height: 8 3/16 (208.0)
I.Gskt: [2] Included



PT8995-MPG Wire Mesh Supported Maximum Performance Glass Hydraulic Element
Replaces: MP Filtri HP651A10NA; Woodgate WGH9191
O.D.: 1 25/32 (45.2)
I.D.: 1 1/32 (26.2) One End
Height: 3 11/32 (84.9)
O-Ring: [1] Attached



H9007 Wire Mesh Supported Hydraulic Element
Contains: Reinforced Centertube
Replaces: Pall HC8300FKN16H, HC8300FUN16H
O.D.: 5 31/32 (151.6)
I.D.: 4 1/8 (104.8)
Height: 16 27/32 (427.8)
I.Gskt: [2] Included



PT8996-MPG Wire Mesh Supported Maximum Performance Glass Hydraulic Element
Replaces: MP Filtri HP1351A25NA; Woodgate WGH9252
O.D.: 2 3/32 (53.2)
I.D.: 1 3/32 (27.8) One End
Height: 4 11/16 (119.1)
O-Ring: [1] Attached



H9013 Wire Mesh Supported Hydraulic Element
Contains: Reinforced Centertube
Replaces: Pall HC8300FKN39H, HC8300FUN39H
O.D.: 5 31/32 (151.6)
I.D.: 4 1/8 (104.8)
Height: 38 11/16 (982.7)
I.Gskt: [2] Included



PT8997-MPG Wire Mesh Supported Maximum Performance Glass Hydraulic Element with Attached Spring
Contains: By-Pass Valve
Replaces: MP Filtri MF1801AA10HB; Woodgate WGH9533
O.D.: 3 29/32 (99.2)
I.D.: 1 9/16 (39.7) One End
Height: 8 29/32 (226.2)
O-Ring: [1] Included
Spring: [1] Attached



H9014 Wire Mesh Supported Hydraulic Element
Contains: Reinforced Centertube
Replaces: Pall HC8300FKS39H, HC8300FUS39H
O.D.: 5 31/32 (151.6)
I.D.: 4 5/32 (105.6)
Height: 38 11/16 (982.7)
I.Gskt: [2] Included



PT8998-MPG Wire Mesh Supported Maximum Performance Glass Hydraulic Element
Replaces: Fairey-Arlon 170L110A; Fleetguard HF30668; Woodgate WGH1711
O.D.: 2 5/32 (54.8)
I.D.: 1 1/16 (17.5) One End
Height: 2 23/32 (69.1)
O-Ring: [1] Attached, [1] Included















H9020 Wire Mesh Supported Hydraulic Element
Replaces: Pall HC8400FKN16H, HC8400FUN16H
O.D.: 6 (152.4)
I.D.: 3 1/4 (82.6)
Height: 16 7/8 (428.6)
I.Gskt: [2] Included



Measurements Are Shown In Inches And (Millimeters)

 **WARNING:** These products can expose you to chemicals, including Diisononyl Phthalate, Carbon black extracts, Nickel, 1,3 Butadiene, Ethylene Oxide, Epichlorohydrin, which are known to the State of California to cause cancer, and Bisphenol, Ethylene Glycol, Ethylene Oxide, 1,3 Butadiene, Epichlorohydrin, which are known to the State of California to cause birth defects or other reproductive harm. For more information go to www.P65Warnings.ca.gov.

<p>H9021</p> 	<p>Wire Mesh Supported Hydraulic Element Contains: Reinforced Centertube Replaces: Pall HC8400FKS16H, HC8400FUS16H O.D.: 6 (152.4) I.D.: 3 1/4 (82.6) Height: 16 7/8 (428.6) I.Gskt: [2] Included</p>	<p>H9042</p>  <p>Wire Mesh Supported Hydraulic Element Fits: Caterpillar Off-Highway Trucks Replaces: Pall HC9020FKN4H, HC9020FUN4H O.D.: 1 3/4 (44.5) I.D.: 1 1/32 (26.2) One End Height: 4 15/32 (113.5) I.Gskt: [1] Included</p>
<p>H9024</p> 	<p>Wire Mesh Supported Hydraulic Element Contains: Reinforced Centertube Replaces: Pall HC8400FKN26H, HC8400FUN26H O.D.: 6 (152.4) I.D.: 3 1/4 (82.6) Height: 25 5/8 (650.9) I.Gskt: [2] Included</p>	<p>H9043</p>  <p>Wire Mesh Supported Hydraulic Element Replaces: Pall HC9020FKS4H, HC9020FUS4H O.D.: 1 3/4 (44.5) I.D.: 1 1/32 (26.2) One End Height: 4 15/32 (113.5) I.Gskt: [1] Included</p>
<p>H9036</p> 	<p>Wire Mesh Supported Hydraulic Element Replaces: Pall HC8500FKN13H, HC8500FUN13H O.D.: 3 13/16 (96.8) I.D.: 1 11/16 (42.9) Height: 12 27/32 (326.2) I.Gskt: [2] Included</p>	<p>H9043-V</p>  <p>Wire Mesh Supported Hydraulic Element Contains: Viton O-Ring for high heat applications. Fits: Volvo Dump Trucks Replaces: Volvo 11707525; Fleetguard HF30200 O.D.: 1 25/32 (45.2) I.D.: 1 1/32 (26.2) One End Height: 4 1/2 (114.3) O-Ring: [1] Viton Attached</p>
<p>H9037</p> 	<p>Wire Mesh Supported Hydraulic Element Replaces: Pall HC8500FKT13H, HC8500FUT13H O.D.: 3 13/16 (96.8) I.D.: 1 11/16 (42.9) Height: 12 27/32 (326.2) I.Gskt: [2] Included</p>	<p>H9044</p>  <p>Wire Mesh Supported Hydraulic Element Fits: Massey Ferguson Equipment Replaces: Pall HC9020FKT4H, HC9020FUT4H O.D.: 1 3/4 (44.5) I.D.: 1 1/32 (26.2) One End Height: 4 15/32 (113.5) I.Gskt: [1] Included</p>
<p>H9039</p> 	<p>Wire Mesh Supported Hydraulic Element Fits: Tamrock Drills Replaces: Pall HC8500FKN26H, HC8500FUN26H O.D.: 3 13/16 (96.8) I.D.: 1 11/16 (42.9) Height: 25 21/32 (651.7) I.Gskt: [2] Included</p>	<p>H9045</p>  <p>Wire Mesh Supported Hydraulic Element Replaces: Pall HC9020FKP8H, HC9020FUP8H O.D.: 1 3/4 (44.5) I.D.: 1 1/32 (26.2) One End Height: 8 7/32 (208.8) I.Gskt: [1] Included</p>
<p>H9041</p> 	<p>Wire Mesh Supported Hydraulic Element Replaces: Pall HC9020FKP4H, HC9020FUP4H O.D.: 1 25/32 (45.2) I.D.: 1 1/32 (26.2) One End Height: 4 1/2 (114.3) I.Gskt: [1] Included</p>	<p>H9046</p>  <p>Wire Mesh Supported Hydraulic Element Replaces: Pall HC9020FKN8H, HC9020FUN8H O.D.: 1 3/4 (44.5) I.D.: 1 1/32 (26.2) One End Height: 8 7/32 (208.8) I.Gskt: [1] Included</p>

Measurements Are Shown In Inches And (Millimeters)

 **WARNING:** These products can expose you to chemicals, including Diisononyl Phthalate, Carbon black extracts, Nickel, 1,3 Butadiene, Ethylene Oxide, Epichlorohydrin, which are known to the State of California to cause cancer, and Bisphenol, Ethylene Glycol, Ethylene Oxide, 1,3 Butadiene, Epichlorohydrin, which are known to the State of California to cause birth defects or other reproductive harm. For more information go to www.P65Warnings.ca.gov.

H9047



Wire Mesh Supported Hydraulic Element

Replaces: Pall HC9020FKS8H, HC9020FUS8H
O.D.: 1 3/4 (44.5)
I.D.: 1 1/32 (26.2) One End
Height: 8 7/32 (208.8)
I.Gskt: [1] Included
Related To: H9052 (with Viton Gasket)

H9054



Wire Mesh Supported Hydraulic Element

Replaces: Pall HC9021FKT4Z, HC9021FUT4Z
O.D.: 1 3/4 (44.5)
I.D.: 1 (25.4) One End
Height: 4 1/2 (114.3)
I.Gskt: [1] Included

H9048



Wire Mesh Supported Hydraulic Element

Replaces: Pall HC9020FKT8H, HC9020FUT8H
O.D.: 1 3/4 (44.5)
I.D.: 1 1/32 (26.2) One End
Height: 8 7/32 (208.8)
I.Gskt: [1] Included

H9055



Wire Mesh Supported Hydraulic Element

Replaces: Pall HC9021FKT8H, HC9021FUT8H
O.D.: 1 3/4 (44.5)
I.D.: 1 (25.4) One End
Height: 8 7/32 (208.8)
I.Gskt: [1] Included
Related To: H9056 (with Viton Seal)

H9049



Wire Mesh Supported Hydraulic Element

Replaces: Pall HC9021FKP4H, HC9021FUP4H
O.D.: 1 3/4 (44.5)
I.D.: 1 (25.4) One End
Height: 4 1/2 (114.3)
I.Gskt: [1] Included

H9056



Wire Mesh Supported Hydraulic Element

Replaces: Pall HC9021FKT8Z, HC9021FUT8Z
O.D.: 1 25/32 (45.2)
I.D.: 1 1/32 (26.2) One End
Height: 8 5/32 (207.2)
I.Gskt: [1] Included
Related To: H9055 (with Nitrile Seal)

H9050



Wire Mesh Supported Hydraulic Element

Replaces: Pall HC9021FKP4Z, HC9021FUP4Z
O.D.: 1 3/4 (44.5)
I.D.: 1 (25.4) One End
Height: 4 1/2 (114.3)
I.Gskt: [1] Included

H9057



Wire Mesh Supported Hydraulic Element

Notes: OBSOLETE. Availability Limited to Dealer Stock.
Replaces: Pall HC9400FKP13H, HC9400FUP13H
O.D.: 3 25/32 (96.0)
I.D.: 2 3/16 (55.6)
Height: 13 7/32 (335.8)
I.Gskt: [2] Included

H9051



Wire Mesh Supported Hydraulic Element

Replaces: Pall HC9021FKP8H, HC9021FUP8H
O.D.: 1 3/4 (44.5)
I.D.: 1 (25.4) One End
Height: 8 7/32 (208.8)
I.Gskt: [1] Included

H9058

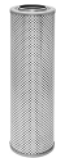

Wire Mesh Supported Hydraulic Element

Replaces: Pall HC9400FKN13H, HC9400FUN13H
O.D.: 3 25/32 (96.0)
I.D.: 2 3/16 (55.6)
Height: 13 3/16 (335.0)
I.Gskt: [2] Included

H9052



Wire Mesh Supported Hydraulic Element

Contains: Viton gasket for high heat applications
Replaces: Parker 932618Q; Fleetguard HF30237
O.D.: 1 25/32 (45.2)
I.D.: 1 (25.4) One End
Height: 8 7/32 (208.8)
I.Gskt: [1] Included
Related To: H9047 (with Buna N Gasket)

H9060



Wire Mesh Supported Hydraulic Element

Replaces: Pall HC9400FKT13H, HC9400FUT13H
O.D.: 3 25/32 (96.0)
I.D.: 2 3/16 (55.6)
Height: 13 3/16 (335.0)
I.Gskt: [2] Included

Measurements Are Shown In Inches And (Millimeters)

WARNING: These products can expose you to chemicals, including Diisononyl Phthalate, Carbon black extracts, Nickel, 1,3 Butadiene, Ethylene Oxide, Epichlorohydrin, which are known to the State of California to cause cancer, and Bisphenol, Ethylene Glycol, Ethylene Oxide, 1,3 Butadiene, Epichlorohydrin, which are known to the State of California to cause birth defects or other reproductive harm. For more information go to www.P65Warnings.ca.gov.

H9062



Wire Mesh Supported Hydraulic Element

Replaces: Pall HC9400FKN26H, HC9400FUN26H
O.D.: 3 25/32 (96.0)
I.D.: 2 3/16 (55.6)
Height: 25 15/16 (658.8)
I.Gskt: [2] Included

H9073



Wire Mesh Supported Hydraulic Element

Fits: Caterpillar, CMI Equipment
Replaces: Pall HC9600FKP8H, HC9600FUP8H
O.D.: 3 1/8 (79.4)
I.D.: 1 11/16 (42.9) One End
Height: 8 1/4 (209.6)
I.Gskt: [1] Included

H9069



Wire Mesh Supported Hydraulic Element

Replaces: Pall HC9600FKP4H, HC9600FUP4H
O.D.: 3 1/8 (79.4)
I.D.: 1 11/16 (42.9) One End
Height: 4 5/8 (117.5)
I.Gskt: [1] Included

H9074



Wire Mesh Supported Hydraulic Element

Fits: Bomag, Massey Ferguson, White Equipment
Replaces: Bomag 7993014; Pall HC9600FKN8H, HC9600FUN8H
O.D.: 3 1/8 (79.4)
I.D.: 1 11/16 (42.9) One End
Height: 8 1/4 (209.6)
I.Gskt: [1] Included

H9070



Wire Mesh Supported Hydraulic Element

Replaces: Pall HC9600FKN4H, HC9600FUN4H
O.D.: 3 1/8 (79.4)
I.D.: 1 11/16 (42.9) One End
Height: 4 5/8 (117.5)
I.Gskt: [1] Included

H9075



Wire Mesh Supported Hydraulic Element

Fits: Bomag, Caterpillar, John Deere, Massey Ferguson, Tamrock Equipment
Replaces: Pall HC9600FKS8H, HC9600FUS8H
O.D.: 3 1/8 (79.4)
I.D.: 1 11/16 (42.9) One End
Height: 8 1/4 (209.6)
I.Gskt: [1] Included

H9071



Wire Mesh Supported Hydraulic Element

Fits: Bomag Paving Equipment; J.C. Bamford, V.M.E., Volvo Equipment
Replaces: Pall HC9600FKS4H, HC9600FUS4H; V.M.E. 4881701; Volvo 1191331
O.D.: 3 1/8 (79.4)
I.D.: 1 11/16 (42.9) One End
Height: 4 5/8 (117.5)
I.Gskt: [1] Included

H9075-V



Wire Mesh Supported Hydraulic Element

Contains: Viton gasket for high heat applications.
Fits: Volvo Motor Graders
Replaces: Volvo 12733419; Parker 932655Q; Donaldson P164365
O.D.: 3 1/8 (79.4)
I.D.: 1 11/16 (42.9) One End
Height: 8 1/4 (209.6)
I.Gskt: [1] Viton

H9072



Wire Mesh Supported Hydraulic Element

Fits: Case, John Deere Tractors
Replaces: Case K946095; Pall HC9600FKT4H, HC9600FUT4H
O.D.: 3 1/8 (79.4)
I.D.: 1 11/16 (42.9) One End
Height: 4 5/8 (117.5)
I.Gskt: [1] Included

H9076



Wire Mesh Supported Hydraulic Element

Replaces: Pall HC9600FKT8H, HC9600FUT8H
O.D.: 3 1/8 (79.4)
I.D.: 1 11/16 (42.9) One End
Height: 8 1/4 (209.6)
I.Gskt: [1] Included

H9072-V



Wire Mesh Supported Hydraulic Element

Contains: Viton gasket for high heat applications
Fits: Case Tractors
Replaces: Pall HC9600FUT4Z; Woodgate WGPT9604Z
O.D.: 3 3/32 (78.6)
I.D.: 1 11/16 (42.9) One End
Height: 4 19/32 (116.7)
I.Gskt: [1] Included

H9076-V



Wire Mesh Supported Hydraulic Element

Contains: Viton gasket for high heat applications
Replaces: Pall HC9600FUT8Z; WGPT9608Z
O.D.: 3 3/32 (78.6)
I.D.: 1 21/32 (42.1) One End
Height: 8 3/16 (208.0)
I.Gskt: [1] Included
O-Ring: [1] Included

Measurements Are Shown In Inches And (Millimeters)

! **WARNING:** These products can expose you to chemicals, including Diisononyl Phthalate, Carbon black extracts, Nickel, 1,3 Butadiene, Ethylene Oxide, Epichlorohydrin, which are known to the State of California to cause cancer, and Bisphenol, Ethylene Glycol, Ethylene Oxide, 1,3 Butadiene, Epichlorohydrin, which are known to the State of California to cause birth defects or other reproductive harm. For more information go to www.P65Warnings.ca.gov.

H9077



Wire Mesh Supported Hydraulic Element

Replaces: Pall HC9600FKP13H,
HC9600FUP13H
O.D.: 3 1/8 (79.4)
I.D.: 1 11/16 (42.9) One End
Height: 12 31/32 (329.4)
I.Gskt: [1] Included

H9082



Wire Mesh Supported Hydraulic Element

Replaces: Pall HC9600FKS13Z,
HC9600FUS13Z
O.D.: 3 1/8 (79.4)
I.D.: 1 11/16 (42.9) One End
Height: 12 31/32 (329.4)
I.Gskt: [1] Included

H9078



Wire Mesh Supported Hydraulic Element

Fits: Wirtgen Milling Machines
Replaces: Pall HC9600FKN13H,
HC9600FUN13H
O.D.: 3 1/8 (79.4)
I.D.: 1 11/16 (42.9) One End
Height: 12 31/32 (329.4)
I.Gskt: [1] Included

H9083



Wire Mesh Supported Hydraulic Element

Replaces: Pall HC9600FKP16H,
HC9600FUP16H
O.D.: 3 1/8 (79.4)
I.D.: 1 11/16 (42.9) One End
Height: 16 7/8 (428.6)
I.Gskt: [1] Included

H9078-V



Wire Mesh Supported Hydraulic Element

Contains: Viton gasket for high heat applications
Replaces: Case 78660C1; General Motors 23049373; International 78660-C1; Parker G01982; Schroeder SBG96001383
O.D.: 3 5/32 (80.2)
I.D.: 1 23/32 (43.7) One End
Height: 12 15/16 (328.6)
I.Gskt: [1] Included

H9084



Wire Mesh Supported Hydraulic Element

Replaces: Pall HC9600FKN16H,
HC9600FUN16H
O.D.: 3 1/8 (79.4)
I.D.: 1 11/16 (42.9) One End
Height: 16 7/8 (428.6)
I.Gskt: [1] Included

H9079



Wire Mesh Supported Hydraulic Element

Replaces: Pall HC9600FKS13H,
HC9600FUS13H
O.D.: 3 1/8 (79.4)
I.D.: 1 11/16 (42.9) One End
Height: 12 31/32 (329.4)
I.Gskt: [1] Included

H9085



Wire Mesh Supported Hydraulic Element

Replaces: Pall HC9600FUS16H,
HC9600KUS16H
O.D.: 3 1/8 (79.4)
I.D.: 1 11/16 (42.9) One End
Height: 16 7/8 (428.6)
I.Gskt: [1] Included

H9080



Wire Mesh Supported Hydraulic Element

Replaces: Pall HC9600FKT13H,
HC9600FUT13H
O.D.: 3 1/8 (79.4)
I.D.: 1 11/16 (42.9) One End
Height: 12 31/32 (329.4)
I.Gskt: [1] Included

H9086



Wire Mesh Supported Hydraulic Element

Replaces: Pall HC9600FKT16H,
HC9600FUT16H
O.D.: 3 1/8 (79.4)
I.D.: 1 11/16 (42.9) One End
Height: 16 7/8 (428.6)
I.Gskt: [1] Included
Related To: H9087 (with Viton Gasket)

H9081



Wire Mesh Supported Hydraulic Element

Replaces: Pall HC9600FKP13Z,
HC9600FUP13Z
O.D.: 3 1/8 (79.4)
I.D.: 1 11/16 (42.9) One End
Height: 12 31/32 (329.4)
I.Gskt: [1] Included

H9087



Wire Mesh Supported Hydraulic Element

Contains: Viton gasket for high heat applications
Replaces: Pall HC9600FKT16Z,
HC9600FUT16Z
O.D.: 3 1/8 (79.4)
I.D.: 1 11/16 (42.9) One End
Height: 16 7/8 (428.6)
O-Ring: [1] Attached
Related To: H9086 (with Buna N Gasket)

Measurements Are Shown In Inches And (Millimeters)

WARNING: These products can expose you to chemicals, including Diisononyl Phthalate, Carbon black extracts, Nickel, 1,3 Butadiene, Ethylene Oxide, Epichlorohydrin, which are known to the State of California to cause cancer, and Bisphenol, Ethylene Glycol, Ethylene Oxide, 1,3 Butadiene, Epichlorohydrin, which are known to the State of California to cause birth defects or other reproductive harm. For more information go to www.P65Warnings.ca.gov.

H9092



Wire Mesh Supported Hydraulic Element
Contains: Reinforced Centertube
Replaces: Pall HC9601FKT8H, HC9601FUT8H
O.D.: 3 5/32 (80.2)
I.D.: 1 11/16 (42.9) One End
Height: 8 1/4 (209.6)
I.Gskt: [1] Included

H9108



Wire Mesh Supported Hydraulic Element
Replaces: Pall HC9800FKN4H, HC9800FUN4H
O.D.: 2 (50.8)
I.D.: 15/16 (23.8) One End
Height: 4 1/2 (114.3)
I.Gskt: [1] Included

H9093



Wire Mesh Supported Hydraulic Element
Contains: Reinforced Centertube
Replaces: Pall HC9601FKT13H, HC9601FUT13H
O.D.: 3 5/32 (80.2)
I.D.: 1 11/16 (42.9) One End
Height: 12 29/32 (327.8)
I.Gskt: [1] Included

H9110



Wire Mesh Supported Hydraulic Element
Fits: Renault Engines
Replaces: Pall HC9800FKT4H, HC9800FUT4H
O.D.: 2 (50.8)
I.D.: 15/16 (23.8) One End
Height: 4 1/2 (114.3)
I.Gskt: [1] Included

H9096



Wire Mesh Supported Hydraulic Element
Replaces: Pall HC9650FKN8H, HC9650FUN8H
O.D.: 3 1/8 (79.4)
I.D.: 1 23/32 (43.7)
Height: 8 3/8 (212.7)
I.Gskt: [2] Included

H9111



Wire Mesh Supported Hydraulic Element
Replaces: Pall HC9800FKP8H, HC9800FUP8H
O.D.: 2 (50.8)
I.D.: 15/16 (23.8) One End
Height: 8 7/32 (208.8)
I.Gskt: [1] Included

H9097



Wire Mesh Supported Hydraulic Element
Replaces: Pall HC9650FKS8H, HC9650FUS8H
O.D.: 3 1/8 (79.4)
I.D.: 1 23/32 (43.7)
Height: 8 3/8 (212.7)
I.Gskt: [2] Included

H9112



Wire Mesh Supported Hydraulic Element
Fits: Massey Ferguson, Renault Tractors
Replaces: Pall HC9800FKN8H, HC9800FUN8H
O.D.: 2 (50.8)
I.D.: 15/16 (23.8) One End
Height: 8 7/32 (208.8)
I.Gskt: [1] Included

H9103



Wire Mesh Supported Hydraulic Element
Contains: Reinforced Centertube
Replaces: Pall HC9651FKP8H, HC9651FUP8H
O.D.: 3 5/32 (80.2)
I.D.: 1 11/16 (42.9)
Height: 8 3/16 (208.0)
I.Gskt: [2] Included

H9113



Wire Mesh Supported Hydraulic Element
Replaces: Pall HC9800FKS8H, HC9800FUS8H
O.D.: 2 (50.8)
I.D.: 15/16 (23.8) One End
Height: 8 7/32 (208.8)
I.Gskt: [1] Included

H9107



Wire Mesh Supported Hydraulic Element
Replaces: Pall HC9800FKP4H, HC9800FUP4H
O.D.: 2 (50.8)
I.D.: 15/16 (23.8) One End
Height: 4 1/2 (114.3)
I.Gskt: [1] Included

H9114



Wire Mesh Supported Hydraulic Element
Replaces: Pall HC9800FKT8H, HC9800FUT8H
O.D.: 2 (50.8)
I.D.: 15/16 (23.8) One End
Height: 8 7/32 (208.8)
I.Gskt: [1] Included

Measurements Are Shown In Inches And (Millimeters)

WARNING: These products can expose you to chemicals, including Diisononyl Phthalate, Carbon black extracts, Nickel, 1,3 Butadiene, Ethylene Oxide, Epichlorohydrin, which are known to the State of California to cause cancer, and Bisphenol, Ethylene Glycol, Ethylene Oxide, 1,3 Butadiene, Epichlorohydrin, which are known to the State of California to cause birth defects or other reproductive harm. For more information go to www.P65Warnings.ca.gov.

H9123



Wire Mesh Supported Hydraulic Element

Replaces: Pall HC8800FDN16H,
HC8800FKN16H
O.D.: 3 13/32 (86.5)
I.D.: 1 15/16 (49.2) One End
Height: 16 27/32 (427.8)
I.Gskt: [1] Included

PT9131



Hydraulic Element

Contains: Spring Locator
Fits: Volvo Trucks
Replaces: Volvo 15036627;
Fleetguard HF6278; Woodgate WGH6278
O.D.: 2 5/16 (58.7)
I.D.: 1/2 (12.7)
Height: 4 19/32 (116.7)
Grommets: [2] Attached

PT9125-MPG



Wire Mesh Supported Maximum Performance
Glass Hydraulic Element

Fits: Timberjack Logging Equipment
Replaces: Fairey-Arlon TXW10CC10;
Fleetguard HF7957; Woodgate WGTW10CC-10
O.D.: 8 (203.2)
I.D.: 9/16 (14.3) & 6 3/16 (157.2)
Height: 12 31/32 (329.4)
O-Ring: [1] Attached

PT9132



Hydraulic Element

Replaces: Fairey-Arlon FXX110;
Fleetguard HF6273; Woodgate WGF1-10
O.D.: 2 27/32 (72.2)
I.D.: 2 1/32 (51.6)
Height: 11 27/32 (300.8)

PT9126



Hydraulic Element

Contains: By-Pass Valve
Replaces: Argo P3051062;
Woodgate WGH1062
O.D.: 1 3/4 (44.5)
I.D.: 3/4 (19.1) One End
Height: 4 1/8 (104.8)
O-Ring: [1] Attached

PT9134



Hydraulic Element

Replaces: Argo P3051005;
Woodgate WGH1005
O.D.: 1 25/32 (45.2)
I.D.: 3/4 (19.1) One End
Height: 4 1/16 (103.2)
O-Ring: [1] Attached

PT9127



Hydraulic Element

Replaces: Argo P2061302;
Woodgate WGH1302
O.D.: 2 11/32 (59.5)
I.D.: 1 5/32 (29.4)
Height: 5 5/16 (134.9)
A. Gskt: [2] Attached

PT9135



Hydraulic Element

Replaces: Argo P3071301; Fleetguard
HF28802; Woodgate WGH1301
O.D.: 2 3/4 (69.9)
I.D.: 1 31/32 (50.0) One End
Height: 5 9/32 (134.1)
O-Ring: [1] Attached, [1] Included

PT9129



Hydraulic Element with Lift Tab

Contains: By-Pass Valve
Replaces: Argo K3102652;
Woodgate WGH1937
O.D.: 3 29/32 (99.2)
Flange 4 1/4 (108.0)
I.D.: 13/32 (10.3) & 3/4 (19.1)
Height: 10 31/32 (278.6)

PT9136



Hydraulic Element

Contains: By-Pass Valve
Replaces: Argo P3061352; Fleetguard
HF35194; Woodgate WGH1352
O.D.: 2 1/4 (57.2)
I.D.: 1 1/16 (27.0) One End
Height: 5 3/8 (136.5)
O-Ring: [1] Attached

PT9130



Wire Mesh Hydraulic Element

Replaces: Woodgate WGH1780
O.D.: 5 29/32 (150.0)
I.D.: 7/16 (11.1) & 3 15/32 (88.1)
Height: 5 13/32 (137.3)
O-Ring: [1] Attached

PT9137



Hydraulic Element

Replaces: Orenstein & Koppel 1433860;
Woodgate WGH1433
O.D.: 1 25/32 (45.2)
I.D.: 15/16 (23.8) One End
Height: 4 15/32 (113.5)
O-Ring: [1] Attached

Measurements Are Shown In Inches And (Millimeters)

WARNING: These products can expose you to chemicals, including Diisononyl Phthalate, Carbon black extracts, Nickel, 1,3 Butadiene, Ethylene Oxide, Epichlorohydrin, which are known to the State of California to cause cancer, and Bisphenol, Ethylene Glycol, Ethylene Oxide, 1,3 Butadiene, Epichlorohydrin, which are known to the State of California to cause birth defects or other reproductive harm. For more information go to www.P65Warnings.ca.gov.

PT9139



Hydraulic Element

Contains: Threaded hex nut for removal.
Fits: Kubota Excavators
Replaces: Kubota 6948162210;
 Woodgate WGH1788
Thread: 1 1/2 -BSP-PL
O.D.: 3 29/32 (99.2)
Height: 5 5/32 (131.0)

PT9147



Hydraulic Element

Contains: By-Pass Valve
Replaces: U.C.C. Hydraulics MGR2143;
 Woodgate WGH1907
O.D.: 1 25/32 (45.2)
I.D.: 3/4 (19.1)
Height: 4 25/32 (121.4)
O-Ring: [1] Attached

PT9140



Hydraulic Element

Replaces: U.C.C. EIL1115;
 Woodgate WGH1800
O.D.: 2 11/32 (59.5)
I.D.: 13/32 (10.3) & 1 1/2 (38.1)
Height: 4 13/16 (122.2)

PT9148



Hydraulic Element

Fits: Manitou Equipment
Replaces: Manitou 46028;
 Woodgate WGH1934
O.D.: 3 9/16 (90.5)
I.D.: 1 5/8 (41.3) One End
Height: 11 13/16 (300.0)
A. Gskt: [1] Attached

PT9142



Hydraulic Element with Bail Handle

Contains: 25 PSID By-Pass Valve
Replaces: J.C. Bamford PP1775, PPP17775;
 MP Filtri MF0301P25N, MF0301P25NB;
 Woodgate WGH1860
O.D.: 2 1/16 (52.4)
I.D.: 31/32 (24.6) One End
Height: 2 7/8 (73.0)

PT9149



Hydraulic Element

Fits: Komatsu Excavators
Replaces: Demag 76184073;
 Woodgate WGH1958
O.D.: 2 23/32 (69.1)
I.D.: 1 9/32 (32.5) One End
Height: 4 9/16 (115.9)
O-Ring: [1] Attached

PT9143



Hydraulic Element with Bail Handle

Contains: By-Pass Valve
Replaces: MP Filtri MF0202P10NB;
 Woodgate WGH1882
O.D.: 1 23/32 (47.7)
I.D.: 27/32 (21.4)
Height: 6 23/32 (170.7)
O-Ring: [1] Attached

PT9150



Wire Mesh Supported Hydraulic Element

Replaces: Finn FC1260F025XS;
 Woodgate WGH1992
O.D.: 2 27/32 (72.2)
I.D.: 5/8 (7.9) & 1 3/4 (44.5)
Height: 10 7/32 (259.6)

PT9144



Hydraulic Element with Bail Handle

Contains: By-Pass Valve
Replaces: Schroeder 8Z10;
 Woodgate WGH1899
O.D.: 3 3/32 (78.6)
I.D.: 1 5/8 (41.3) One End
Height: 8 1/8 (206.4)

PT9152



Hydraulic Element

Replaces: Argo P2092022; Fleetguard
 HF35266; Woodgate WGH2022
O.D.: 3 9/32 (83.3)
I.D.: 1 9/16 (39.7)
Height: 7 25/32 (197.6)
A. Gskt: [2] Attached

PT9145



Wire Mesh Supported Hydraulic Element

Replaces: Finn FFP AVL1102825AB; Woodgate
 WGH1902
O.D.: 2 27/32 (72.2)
I.D.: 11/32 (8.7) & 1 25/32 (45.2)
Height: 5 29/32 (150.0)

PT9153



Hydraulic Element

Contains: By-Pass Valve
Replaces: Argo P3062051; Fleetguard
 HF28796; Woodgate WGH2051
O.D.: 2 5/16 (58.7)
I.D.: 1 1/16 (27.0)
Height: 7 27/32 (199.2)
O-Ring: [1] Attached

Measurements Are Shown In Inches And (Millimeters)



WARNING: These products can expose you to chemicals, including Diisononyl Phthalate, Carbon black extracts, Nickel, 1,3 Butadiene, Ethylene Oxide, Epichlorohydrin, which are known to the State of California to cause cancer, and Bisphenol, Ethylene Glycol, Ethylene Oxide, 1,3 Butadiene, Epichlorohydrin, which are known to the State of California to cause birth defects or other reproductive harm. For more information go to www.P65Warnings.ca.gov.

PT9154



Hydraulic Element

Replaces: Argo P3072302;
Woodgate WGH2302
O.D.: 2 17/32 (64.3)
I.D.: 1 1/8 (28.6)
Height: 9 1/16 (230.2)

PT9162



Hydraulic Element

Fits: Kato Excavators
Replaces: Mitsubishi 68937001001; Fleetguard HF6305; Woodgate WGH6305
O.D.: 4 15/32 (113.5)
I.D.: 2 27/32 (72.2)
Height: 14 7/8 (377.8)
A. Gskt: [2] Attached

PT9155



Hydraulic Element

Replaces: Argo P2112311; Fleetguard HF35272; Woodgate WGH2311
O.D.: 4 11/32 (110.3)
I.D.: 1 13/16 (46.0)
Height: 8 29/32 (226.2)

PT9163



Hydraulic Element

Replaces: Leyland 10871096; Fleetguard HF6527; Woodgate WGH6527
O.D.: 2 19/32 (65.9)
I.D.: 1 5/16 (33.3)
Height: 5 17/32 (140.5)
Grommets: [2] Attached

PT9157



Hydraulic Element

Contains: By-Pass Valve
Replaces: Argo P3072062;
Woodgate WGH3062
O.D.: 2 3/4 (69.9)
I.D.: 1 1/4 (31.8) One End
Height: 7 27/32 (199.2)
O-Ring: [1] Attached

BT9164



Hydraulic Spin-on

Fits: Massey Ferguson Tractors
Replaces: Massey Ferguson 3581032-M2;
Fleetguard HF7541; Woodgate WGH7541
Thread: M42 x 2.0
O.D.: 5 13/32 (137.3)
Height: 7 1/8 (181.0)
I.Gskt: [1] Included

PT9158



Wire Mesh Hydraulic Element

Fits: Vibromax Equipment
Replaces: Argo V3072308;
Woodgate WGH3308
O.D.: 2 1/2 (63.5)
I.D.: 1 1/16 (27.0)
Height: 9 3/32 (231.0)
O-Ring: [1] Attached

PT9165



Hydraulic Element

Replaces: Massey Ferguson 2951149-M91;
Woodgate WGH7552
O.D.: 2 17/32 (64.3)
I.D.: 1 1/16 (27.0) One End
Height: 5 13/16 (147.6)
O-Ring: [1] Attached

PT9159



Hydraulic Element

Replaces: Argo P2123411;
Woodgate WGH3411
O.D.: 4 21/32 (118.3)
I.D.: 2 3/8 (60.3)
Height: 13 (330.2)
A. Gskt: [2] Attached

PT9167



Hydraulic Element with Attached Spring

Contains: By-Pass Valve
Replaces: MP Filtri MF1002AP25NB;
Fleetguard HF7904; Woodgate WGH9100
O.D.: 2 3/4 (69.9)
I.D.: 1 3/32 (27.8) One End
Height: 5 11/32 (135.7)
O-Ring: [1] Attached
Spring: [1] Attached

PT9161



Wire Mesh Supported Hydraulic Element

Fits: Bobcat, Komatsu, Krone, Terex
Equipment
Replaces: Argo V3093308; Fleetguard HF28809; Woodgate WGH3908
O.D.: 3 17/32 (89.7)
I.D.: 1 17/32 (38.9) One End
Height: 13 3/32 (332.6)
O-Ring: [1] Attached

PT9168



Hydraulic Element with Attached Spring

Contains: By-Pass Valve
Fits: Liebherr Cranes
Replaces: Liebherr 510670108; Fleetguard HF7911; Woodgate WGH9101
O.D.: 5 1/8 (130.2)
I.D.: 1 15/16 (49.2) One End
Height: 8 3/16 (208.0)
O-Ring: [1] Included
Spring: [1] Attached

Measurements Are Shown In Inches And (Millimeters)

WARNING: These products can expose you to chemicals, including Diisononyl Phthalate, Carbon black extracts, Nickel, 1,3 Butadiene, Ethylene Oxide, Epichlorohydrin, which are known to the State of California to cause cancer, and Bisphenol, Ethylene Glycol, Ethylene Oxide, 1,3 Butadiene, Epichlorohydrin, which are known to the State of California to cause birth defects or other reproductive harm. For more information go to www.P65Warnings.ca.gov.

PT9169



Hydraulic Element

Fits: Takeuchi Excavators; Yanmar Carriers
Replaces: Yanmar 155110-0700;
 Woodgate WGH9104
O.D.: 4 13/32 (111.9)
I.D.: 2 3/4 (69.9)
Height: 8 13/16 (223.8)
A. Gskt: [2] Attached
O-Ring: [1] Included

PT9176



Hydraulic Element with Bail Handle

Contains: By-Pass Valve
Fits: Manitou Equipment
Replaces: Komatsu 21D6011130; Fleetguard
 HF7909, HF35216; Woodgate WGH9150
O.D.: 5 5/32 (131.0)
I.D.: 2 15/32 (62.7) One End
Height: 8 9/32 (210.3)
Spring: [1] Included

PT9170



Hydraulic Element

Fits: Link-Belt, Volvo, Yanmar Excavators
Replaces: Yanmar 172112-74911;
 Woodgate WGH9108
O.D.: 4 5/16 (109.5)
I.D.: 2 3/4 (69.9)
Height: 8 11/16 (220.7)

PT9178



Hydraulic Element with Attached Spring

Contains: By-Pass Valve
Fits: Manitou Equipment
Replaces: Manitou 23091;
 Fleetguard HF7984; Woodgate WGH9160
O.D.: 2 3/4 (69.9)
I.D.: 1 5/8 (41.3) One End
Height: 3 31/32 (100.8)
Spring: [1] Attached

PT9171



Wire Mesh Supported Hydraulic Element

Fits: Liebherr Equipment
Replaces: Liebherr 7001636;
 Woodgate WGH9128
O.D.: 4 19/32 (116.7)
I.D.: 1 17/32 (38.9) & 2 5/16 (58.7)
Height: 14 1/2 (368.3)
A. Gskt: [2] Attached

PT9179



Hydraulic Element with Attached Spring

Contains: By-Pass Valve
Replaces: MP Filtri MF0301AP25NB;
 Woodgate WGH9500
O.D.: 1 31/32 (50.0)
I.D.: 15/16 (23.8) One End
Height: 3 (76.2)
O-Ring: [1] Attached
Spring: [1] Attached

PT9172



Hydraulic Element

Fits: Hitachi, John Deere, Kubota Excavators,
 Loaders
Replaces: Hitachi 4225846;
 Woodgate WGH9134
O.D.: 3 17/32 (89.7)
I.D.: 1 27/32 (46.8)
Height: 14 1/8 (358.8)
O-Ring: [2] Attached, [3] Included

PT9180



Hydraulic Element with 2 Bail Handles

Contains: By-Pass Valve
Replaces: MP Filtri MF1001P10NB;
 Fleetguard HF35201; Woodgate WGH9505
O.D.: 2 3/4 (69.9)
I.D.: 1 3/32 (27.8) One End
Height: 3 5/8 (92.1)
O-Ring: [1] Attached
Spring: [1] Included

PT9174



Hydraulic Element with Attached Spring

Contains: By-Pass Valve
Replaces: MP Filtri MF1002AM60NB;
 Woodgate WGH9146
O.D.: 2 3/4 (69.9)
I.D.: 1 3/32 (27.8) One End
Height: 5 11/32 (135.7)
Spring: [1] Attached

PT9181



Hydraulic Element with Attached Spring

Contains: By-Pass Valve
Fits: Telesco Pelle Loaders
Replaces: MP Filtri MF1801AP10NB;
 Fleetguard HF35209; Woodgate WGH9532
O.D.: 3 29/32 (99.2)
I.D.: 1 25/32 (45.2) One End
Height: 8 5/8 (219.1)
O-Ring: [1] Attached
Spring: [1] Included

PT9175



Hydraulic Element with Attached Spring

Contains: By-Pass Valve
Replaces: J.C. Bamford 32/925100;
 Fleetguard HF7906, HF35210;
 Woodgate WGH9147
O.D.: 3 29/32 (99.2)
I.D.: 1 9/16 (39.7) One End
Height: 8 5/8 (219.1)
I.Gskt: [1] Included
Spring: [1] Attached

PT9182



Hydraulic Element with Attached Spring

Contains: By-Pass Valve
Replaces: Liebherr 5106639;
 Woodgate WGH9550
O.D.: 5 1/8 (130.2)
I.D.: 1 31/32 (50.0) One End
Height: 8 3/16 (208.0)
O-Ring: [1] Included
Spring: [1] Attached

Measurements Are Shown In Inches And (Millimeters)



WARNING: These products can expose you to chemicals, including Diisononyl Phthalate, Carbon black extracts, Nickel, 1,3 Butadiene, Ethylene Oxide, Epichlorohydrin, which are known to the State of California to cause cancer, and Bisphenol, Ethylene Glycol, Ethylene Oxide, 1,3 Butadiene, Epichlorohydrin, which are known to the State of California to cause birth defects or other reproductive harm. For more information go to www.P65Warnings.ca.gov.

PT9183



Hydraulic Element with Attached Spring

Contains: By-Pass Valve
Replaces: Lieherr 510665208;
 Woodgate WGH9554
O.D.: 5 11/32 (135.7)
I.D.: 2 9/16 (65.1) One End
Height: 7 7/8 (200.0)
O-Ring: [1] Attached
Spring: [1] Attached

PT9190



Hydraulic Element

Replaces: Fairey-Arlon TXX8B10; Fleetguard
 HF6310; Woodgate WGTX8B-10
O.D.: 4 31/32 (126.2)
I.D.: 13/32 (10.3) & 3 5/8 (92.1)
Height: 15 1/4 (387.4)
O-Ring: [1] Attached

PT9185



Hydraulic Element

Replaces: Fairey-Arlon TXX2-10; Fleetguard
 HF35111; Woodgate WGTX2-10
O.D.: 2 27/32 (72.2)
I.D.: 11/32 (8.7) & 1 25/32 (44.5)
Height: 4 5/32 (105.6)
O-Ring: [1] Attached

PT9191



Hydraulic Element

Fits: Case, Drott Equipment
Replaces: Fairey-Arlon TXX8C10; Fleetguard
 HF6311; Woodgate WGTX8C-10
O.D.: 4 15/16 (125.4)
I.D.: 13/32 (10.3) & 3 5/8 (92.1)
Height: 18 13/16 (477.8)
O-Ring: [1] Attached

PT9186



Hydraulic Element

Replaces: Fairey-Arlon TXX310; Fleetguard
 HF6306; Woodgate WGTX3-10
O.D.: 2 27/32 (72.2)
I.D.: 9/32 (7.1) & 1 3/4 (44.5)
Height: 5 7/8 (149.2)
O-Ring: [1] Attached

PT9193



Hydraulic Element

Notes: For suction side
Contains: Threaded hex nut for removal.
Replaces: J.C. Bamford 92/912004;
 Woodgate WGH1900
Thread: 3/4 -BSP-PL
O.D.: 2 3/4 (69.9)
Height: 3 3/4 (95.3)

PT9187



Hydraulic Element

Replaces: J.C. Bamford 581/05702; Fleetguard
 HF6307; Woodgate WGTX3D-10
O.D.: 2 27/32 (72.2)
I.D.: 5/8 (7.9) & 2 1/16 (52.4)
Height: 7 7/8 (200.0)
O-Ring: [1] Attached

PT9195



Hydraulic Element

Contains: 22 PSID By-Pass Valve
Replaces: Argo P3051051; Fleetguard
 HF35267; Woodgate WGH1051
O.D.: 1 25/32 (45.2)
I.D.: 13/16 (20.6) One End
Height: 4 3/32 (104.0)
O-Ring: [1] Attached

PT9188



Hydraulic Element

Replaces: Fairey-Arlon TXX410; Fleetguard
 HF6308; Woodgate WGTX4-10
O.D.: 4 5/32 (105.6)
I.D.: 13/32 (10.3) & 2 27/32 (72.2)
Height: 7 9/16 (192.1)
O-Ring: [1] Attached

PT9196



Hydraulic Element

Notes: Inside-Out Flow Direction
Contains: 2 PSID By-Pass Valve
 Threaded hex nut for removal.
Fits: Caterpillar Lift Trucks; Kubota
 Excavators; Mitsubishi Equipment
Replaces: Kubota 6978162120; Fleetguard
 HF7929; Woodgate WGH1965
Thread: 3/4 NPT
O.D.: 3 17/32 (89.7)
Height: 6 9/16 (166.7)

PT9189



Hydraulic Element

Notes: Inside-Out Flow Direction
Replaces: J.C. Bamford 32/100301; Fleetguard
 HF6309; Woodgate WGTX5A-10
O.D.: 4 5/32 (105.6)
I.D.: 13/32 (10.3) & 2 27/32 (72.2)
Height: 18 9/32 (464.3)
O-Ring: [1] Attached

PT9197



Hydraulic Element

Contains: 22 PSID By-Pass Valve
Replaces: Argo P3062052; Fleetguard
 HF35263; Woodgate WGH2052
O.D.: 2 5/16 (58.7)
I.D.: 1 1/32 (26.2) One End
Height: 7 7/8 (200.0)
O-Ring: [1] Attached

Measurements Are Shown In Inches And (Millimeters)

WARNING: These products can expose you to chemicals, including Diisononyl Phthalate, Carbon black extracts, Nickel, 1,3 Butadiene, Ethylene Oxide, Epichlorohydrin, which are known to the State of California to cause cancer, and Bisphenol, Ethylene Glycol, Ethylene Oxide, 1,3 Butadiene, Epichlorohydrin, which are known to the State of California to cause birth defects or other reproductive harm. For more information go to www.P65Warnings.ca.gov.

PT9198



Hydraulic Element

Contains: 14 PSID By-Pass Valve
Replaces: Argo P3052062;
 Woodgate WGH2062
O.D.: 1 25/32 (45.2)
I.D.: 13/16 (20.6) One End
Height: 7 7/8 (200.0)
O-Ring: [1] Attached

PT9206



Wire Mesh Supported Hydraulic Element

Replaces: MP Filtri HP651P25NA;
 Woodgate WGH9186
O.D.: 1 25/32 (45.2)
I.D.: 15/16 (23.8) One End
Height: 3 3/8 (85.7)
O-Ring: [1] Attached

PT9199



Hydraulic Element

Replaces: Argo P2093301;
 Woodgate WGH3301
O.D.: 3 1/2 (88.9)
I.D.: 1 31/32 (50.0)
Height: 12 29/32 (327.8)

PT9207



Wire Mesh Supported Hydraulic Element

Replaces: MP Filtri CH802CD11;
 Woodgate WGH9286
O.D.: 3 1/16 (77.8)
I.D.: 1 11/16 (42.9) One End
Height: 8 9/32 (210.3)
O-Ring: [1] Attached

PT9200



Wire Mesh Supported Hydraulic Element

Replaces: Mahle 9700066103;
 Woodgate WGH9724
O.D.: 2 9/32 (57.9)
I.D.: 31/32 (24.6) & 1 7/32 (31.0)
Height: 7 1/8 (181.0)
O-Ring: [1] Attached
End Seals: [1] Attached

PT9208



Wire Mesh Supported Hydraulic Element

Replaces: MP Filtri HP0371P10AN;
 Woodgate WGH9410
O.D.: 1 5/8 (41.3)
I.D.: 27/32 (21.4) One End
Height: 3 17/32 (89.7)
O-Ring: [1] Attached

PT9202



Wire Mesh Supported Hydraulic Element

Fits: Case Excavators
Replaces: Fairey-Arlon TXX1110; Fleetguard
 HF6312; Woodgate WGTX11-10
O.D.: 7 15/16 (201.6)
I.D.: 9/16 (14.3) & 6 3/16 (157.2)
Height: 17 5/16 (439.7)
O-Ring: [1] Attached

PT9209



Hydraulic Element

Replaces: MP Filtri HP0371P25;
 Woodgate WGH9411
O.D.: 1 5/8 (41.3)
I.D.: 29/32 (23.0) One End
Height: 3 19/32 (91.3)
O-Ring: [1] Attached

PT9203



Wire Mesh Supported Hydraulic Element

Replaces: Parker GO1284; Fleetguard HF7738;
 Woodgate WGH1983
O.D.: 1 15/32 (37.3) & 2 3/8 (60.3)
I.D.: 1 (25.4) One End
Height: 5 5/16 (134.9)
O-Ring: [1] Attached

PT9210



Hydraulic Element

Replaces: Argo P3052001;
 Woodgate WGH9434
O.D.: 1 25/32 (45.2)
I.D.: 3/4 (19.1) One End
Height: 7 27/32 (199.2)
O-Ring: [1] Attached

PT9205



Wire Mesh Supported Hydraulic Element

Replaces: Argo P3082301;
 Woodgate WGH8301
O.D.: 3 1/16 (77.8)
I.D.: 1 9/16 (39.7) One End
Height: 9 1/8 (231.8)
O-Ring: [1] Attached

BT9211



Hydraulic Spin-on

Notes: Obsolete. Availability limited to dealer
 stock. Replaced by BT8474
Replaces: MP Filtri CS70P25A;
 Woodgate WGH9170
Thread: 3/4 -14 BSP-PL
O.D.: 3 13/16 (96.8)
Height: 8 9/32 (210.3)

Measurements Are Shown In Inches And (Millimeters)

WARNING: These products can expose you to chemicals, including Diisononyl Phthalate, Carbon black extracts, Nickel, 1,3 Butadiene, Ethylene Oxide, Epichlorohydrin, which are known to the State of California to cause cancer, and Bisphenol, Ethylene Glycol, Ethylene Oxide, 1,3 Butadiene, Epichlorohydrin, which are known to the State of California to cause birth defects or other reproductive harm. For more information go to www.P65Warnings.ca.gov.

PT9212



Hydraulic Element

Replaces: Putzmeister 222895006;
Woodgate WGH1901
O.D.: 4 (101.6)
I.D.: 2 7/16 (61.9)
Height: 13 3/16 (335.0)
O-Ring: [2] Attached

PT9222



Wire Mesh Hydraulic Element

Notes: For suction side
Contains: Threaded hex nut for removal.
Replaces: U.C.C. UCSE1319;
Woodgate WGSE1319
Thread: 1/2 -14 BSP-PL
O.D.: 1 13/16 (43.0)
Height: 4 5/32 (105.6)

PT9213



Hydraulic Element

Notes: For suction side
Contains: 2 PSID By-Pass Valve
Threaded hex nut for removal.
Fits: Kubota Excavators
Replaces: Kubota RB10162190;
Woodgate WGH1918
O.D.: 3 17/32 (89.7)
Height: 3 27/32 (97.6)

PT9223



Wire Mesh Hydraulic Element

Notes: For suction side
Contains: Threaded hex nut for removal.
Replaces: U.C.C. UCSE1320; Fleetguard
HF35159; Woodgate WGSE1320
Thread: 3/4 -14 BSP-PL
O.D.: 2 17/32 (64.3)
Height: 4 5/16 (109.5)

PT9214



Wire Mesh Hydraulic Element with Bail Handle

Replaces: Tamrock 4701416;
Woodgate WGH1954
O.D.: 3 5/16 (84.1)
I.D.: 9/16 (14.3)
Height: 4 23/32 (119.9)
F. Gskt: [1] Included, [1] Washer
O-Ring: [1] Included
Grommets: [2] Attached

PT9224



Wire Mesh Hydraulic Element

Contains: Threaded hex nut for removal.
Replaces: U.C.C. UCSE1324; Fleetguard
HF6254; Woodgate WGSE1324
Thread: 1 1/2 -11 BSP-PL
O.D.: 3 5/16 (84.1)
Height: 7 7/8 (200.0)

PT9215



Wire Mesh Hydraulic Element

Fits: Massey Ferguson Wheel Tractors
Replaces: Massey Ferguson 1674984M92;
Woodgate WGH9139
O.D.: 2 7/8 (73.0)
I.D.: 13/32 (10.3) & 1 13/32 (35.7)
Height: 6 7/32 (158.0)

PT9225



Wire Mesh Hydraulic Element

Contains: Threaded hex nut for removal.
Fits: Kubota Excavators
Replaces: U.C.C. UCSE1457; Fleetguard
HF7444; Woodgate WGSE1457
Thread: 1 -11 BSP-PL
O.D.: 2 17/32 (64.3)
Height: 5 7/16 (138.1)

PT9217



Wire Mesh Hydraulic Element with Attached Spring

Contains: 25 PSID By-Pass Valve
Replaces: MP Filtri MF4002AM125NB;
Woodgate WGH9561
O.D.: 5 1/8 (130.2)
I.D.: 2 9/16 (65.1) One End
Height: 7 7/8 (200.0)
O-Ring: [1] Included
Spring: [1] Attached

PT9227



Wire Mesh Hydraulic Element with Bail Handle

Contains: 25 PSID By-Pass Valve
Replaces: MP Filtri MF1801AM60NB;
Fleetguard HF28869; Woodgate WGH9144
O.D.: 3 29/32 (99.2)
I.D.: 1 9/16 (39.7) One End
Height: 8 7/8 (225.4)
Spring: [1] Included

PT9221



Wire Mesh Hydraulic Element

Replaces: Hydac 30D025W;
Woodgate WGH30025DW
O.D.: 1 3/8 (34.9)
I.D.: 7/16 (11.1) One End
Height: 3 11/16 (93.7)
O-Ring: [1] Attached

PT9228



Wire Mesh Hydraulic Element

Replaces: MP Filtri MR1001M90;
Woodgate WGST120
O.D.: 2 27/32 (72.2)
I.D.: 11/32 (8.7) & 1 25/32 (45.2)
Height: 2 3/16 (55.6)
O-Ring: [1] Attached

Measurements Are Shown In Inches And (Millimeters)

 **WARNING:** These products can expose you to chemicals, including Diisononyl Phthalate, Carbon black extracts, Nickel, 1,3 Butadiene, Ethylene Oxide, Epichlorohydrin, which are known to the State of California to cause cancer, and Bisphenol, Ethylene Glycol, Ethylene Oxide, 1,3 Butadiene, Epichlorohydrin, which are known to the State of California to cause birth defects or other reproductive harm. For more information go to www.P65Warnings.ca.gov.

H9231



Wire Mesh Supported Hydraulic Element
Contains: Viton O-Ring for high heat applications
Replaces: MP Filtri HP0653A06AN; Woodgate WGNP9208Z
O.D.: 1 25/32 (45.2)
I.D.: 15/16 (23.8) One End
Height: 8 7/32 (208.8)
O-Ring: [1] Viton Attached

PT9242



Wire Mesh Supported Hydraulic Element with Bail Handle
Contains: By-Pass Valve
Replaces: MP Filtri MF1002AM125NB; Woodgate WGH9524
O.D.: 2 3/4 (69.9)
I.D.: 1 1/8 (28.6) One End
Height: 5 1/8 (130.2)
O-Ring: [1] Included
Spring: [1] Included

PT9236-MPG



Wire Mesh Supported Hydraulic Element with Attached Spring
Contains: By-Pass Valve
Replaces: Woodgate WGH9502
O.D.: 1 31/32 (50.0)
I.D.: 1 1/32 (26.2) One End
Height: 3 (76.2)
O-Ring: [1] Included
Spring: [1] Attached

PT9244



Hydraulic Element
Replaces: Finn FC1073F010BS; Woodgate WGH1817
O.D.: 4 5/32 (105.6)
I.D.: 1 1/8 (28.6) & 2 27/32 (72.2)
Height: 20 1/2 (520.7)
O-Ring: [1] Attached

PT9237



Wire Mesh Supported Hydraulic Element with Attached Spring
Contains: By-Pass Valve
Replaces: MP Filtri MF1002AP10NB; Woodgate WGH9517
O.D.: 2 3/4 (69.9)
I.D.: 1 1/8 (28.6) One End
Height: 5 7/32 (132.6)
I.Gskt: [1] Included
O-Ring: [1] Included
Spring: [1] Attached

PT9245



Wire Mesh Hydraulic Element
Fits: Daewoo, Doosan Excavators, Loaders
Replaces: Daewoo 24749016A; Woodgate WGH1864
O.D.: 5 7/8 (149.2)
I.D.: 2 15/16 (74.6) One End
Height: 6 1/16 (154.0)
O-Ring: [1] Attached

PT9238



Hydraulic Element
Contains: By-Pass Valve
 Threaded hex nut for removal.
Fits: Kubota, Takeuchi Excavators
Replaces: Kubota 6865162120; Fleetguard HF28946; Woodgate WGH1982
Thread: 1 NPT
O.D.: 3 9/16 (90.5)
Height: 7 7/8 (200.0)

PT9246



Hydraulic Element
Replaces: Argo P2121702; Woodgate WGH2702
O.D.: 4 21/32 (118.3)
I.D.: 2 3/8 (60.3)
Height: 6 9/16 (167.5)
O-Ring: [2] Included

PT9239



Wire Mesh Supported Hydraulic Element with Attached Spring
Contains: By-Pass Valve
Replaces: MP Filtri MF1001P25NB; Woodgate WGH9507
O.D.: 2 3/4 (69.9)
I.D.: 1 3/32 (27.8) One End
Height: 3 19/32 (91.3)
O-Ring: [1] Attached
Spring: [1] Attached

PT9247



Wire Mesh Supported Hydraulic Element
Fits: Liebherr Excavators
Replaces: Liebherr 7211188; Fleetguard HF6301; Woodgate WGH9130
O.D.: 5 31/32 (151.6)
I.D.: 1 25/32 (45.2) & 3 1/2 (88.9)
Height: 24 1/2 (622.3)
A. Gskt: [2] Attached

PT9240



Wire Mesh Supported Hydraulic Element with Attached Spring
Contains: By-Pass Valve
Replaces: MP Filtri MF0301AP10NB; Fleetguard HF35199; Woodgate WGH9499
O.D.: 2 1/16 (52.4)
I.D.: 29/32 (23.0) One End
Height: 2 31/32 (75.4)
O-Ring: [1] Included
Spring: [1] Attached

PT9248



Hydraulic Element
Contains: By-Pass Valve
Fits: Manitou Equipment
Replaces: Manitou 21967; Fleetguard HF7981; Woodgate WGH9159
O.D.: 2 3/4 (69.9)
I.D.: 1 21/32 (42.1) One End
Height: 7 15/16 (201.6)

Measurements Are Shown In Inches And (Millimeters)

WARNING: These products can expose you to chemicals, including Diisononyl Phthalate, Carbon black extracts, Nickel, 1,3 Butadiene, Ethylene Oxide, Epichlorohydrin, which are known to the State of California to cause cancer, and Bisphenol, Ethylene Glycol, Ethylene Oxide, 1,3 Butadiene, Epichlorohydrin, which are known to the State of California to cause birth defects or other reproductive harm. For more information go to www.P65Warnings.ca.gov.

PT9250



Wire Mesh Supported Hydraulic Element with Bail Handle

Contains: By-Pass Valve
Replaces: MP Filtri MF7501AP25NB;
 Woodgate WGH9590
O.D.: 5 1/8 (130.2)
I.D.: 2 17/32 (64.3) One End
Height: 16 5/32 (410.4)
O-Ring: [1] Included
Spring: [1] Included

PT9258



Hydraulic Element

Fits: Hyundai Excavators
Replaces: Hyundai 31EE01060;
 Woodgate WGH1808
O.D.: 4 23/32 (119.9)
I.D.: 2 15/16 (74.6)
Height: 8 15/16 (227.0)
A. Gskt: [2] Attached

PT9251



Hydraulic Element

Contains: Threaded hex nut for removal.
Replaces: Woodgate WGSE1371
Thread: 2 1/2 -11 BSP-PL
O.D.: 5 1/8 (130.2)
Height: 11 (279.4)

PT9259



Hydraulic Element

Contains: 29 PSID By-Pass Valve
Replaces: Schaeff 5380657025;
 Woodgate WGH1826
O.D.: 2 3/4 (69.9)
I.D.: 1 5/8 (41.3) One End
Height: 12 7/32 (310.4)
O-Ring: [1] Included

PT9254



Hydraulic Element

Replaces: Fairey-Arlon FXX310;
 Woodgate WGF3-10
O.D.: 4 31/32 (126.2)
I.D.: 3 5/8 (92.1)
Height: 11 7/16 (290.5)

PT9260



Hydraulic Element

Replaces: Sumitomo CEJ1357;
 Woodgate WGH1832
O.D.: 3 (76.2)
I.D.: 1 13/16 (46.0)
Height: 5 17/32 (140.5)
O-Ring: [1] Attached

PT9255



Wire Mesh Supported Hydraulic Element

Replaces: Liebherr 5106622;
 Woodgate WGH9855
O.D.: 1 27/32 (46.8)
I.D.: 1 1/32 (26.2) One End
Height: 3 11/16 (93.7)

PT9261-MPG



Wire Mesh Supported Hydraulic Element

Contains: By-Pass Valve
Replaces: MP Filtri MF4003AA10HB;
 Woodgate WGH9580
O.D.: 5 1/8 (130.2)
I.D.: 2 17/32 (64.3) One End
Height: 10 3/16 (258.8)
O-Ring: [1] Included
Spring: [1] Included

PT9256-MPG



Wire Mesh Supported Hydraulic Element with Attached Spring

Contains: By-Pass Valve
Replaces: MP Filtri MF1002AA25HB;
 Fleetguard HF35204; Woodgate WGH9522
O.D.: 2 25/32 (70.6)
I.D.: 1 7/32 (31.0) One End
Height: 5 7/32 (132.6)
Spring: [1] Attached

PT9264



Wire Mesh Supported Hydraulic Element

Contains: By-Pass Valve
Replaces: MP Filtri MF1003AP10NB;
 Woodgate WGH1991
O.D.: 2 3/4 (69.9)
I.D.: 1 19/32 (40.5) One End
Height: 8 7/16 (214.3)
O-Ring: [1] Included
Spring: [1] Included

PT9257



Hydraulic Element

Replaces: Fairey-Arlon TX3B10;
 Woodgate WGTX3B-10
O.D.: 4 1/8 (104.8)
I.D.: 3/8 (9.5) & 3 11/32 (84.9)
Height: 5 9/16 (141.3)

PT9266















Hydraulic Element

Replaces: Parker GO2836;
 Woodgate WGH9876
O.D.: 1 27/32 (46.8)
I.D.: 1 (25.4) One End
Height: 6 25/32 (172.2)

Measurements Are Shown In Inches And (Millimeters)

WARNING: These products can expose you to chemicals, including Diisononyl Phthalate, Carbon black extracts, Nickel, 1,3 Butadiene, Ethylene Oxide, Epichlorohydrin, which are known to the State of California to cause cancer, and Bisphenol, Ethylene Glycol, Ethylene Oxide, 1,3 Butadiene, Epichlorohydrin, which are known to the State of California to cause birth defects or other reproductive harm. For more information go to www.P65Warnings.ca.gov.

<p>PT9267</p> 	<p>Wire Mesh Supported Hydraulic Element Replaces: Stauff SL020D20B; Woodgate WGH9877 O.D.: 1 27/32 (46.8) I.D.: 1 (25.4) One End Height: 6 3/4 (171.5)</p>	<p>PT9282-MPG Wire Mesh Supported Maximum Performance Glass Hydraulic Element Contains: 29 PSID By-Pass Valve Replaces: Internormen 300123VG10; Woodgate WGH1793 O.D.: 2 3/16 (55.6) I.D.: 1 1/16 (27.0) One End Height: 6 27/32 (173.8) O-Ring: [1] Included</p> 
<p>PT9268</p> 	<p>Wire Mesh Supported Hydraulic Element with Bail Handle Contains: By-Pass Valve Replaces: Hydac 330R010P; Woodgate WGH33010RP O.D.: 3 23/32 (94.5) I.D.: 1 27/32 (46.8) One End Height: 7 5/8 (193.7) O-Ring: [1] Attached</p>	<p>PT9283-MPG Wire Mesh Supported Maximum Performance Glass Hydraulic Element Fits: Caterpillar Excavators Replaces: Caterpillar 1097287; Woodgate WGH1843 O.D.: 4 21/32 (118.3) I.D.: 2 11/32 (59.5) Height: 23 5/8 (600.1) O-Ring: [2] Attached</p> 
<p>PT9272</p> 	<p>Wire Mesh Hydraulic Element Contains: 24 PSID By-Pass Valve Replaces: MP Filtri MF4002AM60NB; Fleetguard HF28874, HF35217; Woodgate WGH9145 O.D.: 5 1/8 (130.2) I.D.: 2 9/16 (65.1) One End Height: 7 7/8 (200.0) O-Ring: [1] Included</p>	<p>PT9284-MPG Wire Mesh Supported Maximum Performance Glass Hydraulic Element Replaces: Argo V2092008; Woodgate WGH2008 O.D.: 3 1/4 (82.6) I.D.: 1 19/32 (40.5) Height: 7 25/32 (197.6) A. Gskt: [2] Attached</p> 
<p>PT9277</p> 	<p>Wire Mesh Hydraulic Element Notes: For suction side Contains: Threaded hex nut for removal. Replaces: U.C.C. UCSE1219; Woodgate WGSE1219 Thread: 2 -11 BSP-PL O.D.: 5 29/32 (150.0) Height: 5 15/16 (150.8)</p>	<p>PT9285-MPG Wire Mesh Supported Maximum Performance Glass Hydraulic Element Contains: 36 PSID By-Pass Valve Replaces: Demag 42211122; Woodgate WGH2056 O.D.: 2 5/16 (58.7) I.D.: 1 1/32 (26.2) One End Height: 7 7/8 (200.0) O-Ring: [1] Attached</p> 
<p>PT9278</p> 	<p>Wire Mesh Hydraulic Element Contains: Threaded hex nut for removal. Replaces: U.C.C. UCSE1323 Thread: 1 1/2 -11 BSP-PL O.D.: 3 3/8 (85.7) Height: 5 15/32 (138.9)</p>	<p>PT9286-MPG Wire Mesh Supported Maximum Performance Glass Hydraulic Element Contains: 36 PSID By-Pass Valve Replaces: Argo V3062058; Woodgate WGH2058 O.D.: 2 5/16 (58.7) I.D.: 1 1/32 (26.2) One End Height: 7 7/8 (200.0) O-Ring: [1] Attached</p> 
<p>PT9279</p> 	<p>Wire Mesh Hydraulic Element Notes: For suction side Contains: Threaded hex nut for removal. Replaces: Woodgate WGSE1360 Thread: 1 1/2 -11 BSP-PL O.D.: 3 3/8 (85.7) Height: 7 7/8 (200.0)</p>	<p>PT9287-MPG Wire Mesh Supported Maximum Performance Glass Hydraulic Element Contains: 36 PSID By-Pass Valve Fits: Thwaites Dump Trucks Replaces: Argo V3052058; Woodgate WGH3557 O.D.: 1 25/32 (45.2) I.D.: 25/32 (19.8) One End Height: 7 13/16 (198.4) O-Ring: [1] Attached</p> 

Measurements Are Shown In Inches And (Millimeters)

 **WARNING:** These products can expose you to chemicals, including Diisononyl Phthalate, Carbon black extracts, Nickel, 1,3 Butadiene, Ethylene Oxide, Epichlorohydrin, which are known to the State of California to cause cancer, and Bisphenol, Ethylene Glycol, Ethylene Oxide, 1,3 Butadiene, Epichlorohydrin, which are known to the State of California to cause birth defects or other reproductive harm. For more information go to www.P65Warnings.ca.gov.

PT9288-MPG Wire Mesh Supported Maximum Performance Glass Hydraulic Element
Contains: Venturi-Type Cone
Fits: Liebherr Equipment
Replaces: Liebherr 7360470; Fleetguard HF6247; Woodgate WGH470
O.D.: 3 15/16 (100.0)
I.D.: 2 11/32 (59.5) & 2 17/32 (64.3)
Height: 18 9/32 (464.3)
A. Gskt: [2] Attached



PT9296-MPG Wire Mesh Supported Maximum Performance Glass Hydraulic Element
Replaces: Stauff SL020E10B; Woodgate WGH9880
O.D.: 1 27/32 (46.8)
I.D.: 1 (25.4) One End
Height: 6 3/4 (171.5)



PT9289-MPG Maximum Performance Glass Hydraulic Element with 2 Bail Handles
Contains: 24 PSID By-Pass Valve
Replaces: MP Filtri MF1001AA25HB; Woodgate WGH9511
O.D.: 2 25/32 (70.6)
I.D.: 1 3/32 (27.8) One End
Height: 3 1/2 (88.9)
O-Ring: [1] Included
Spring: [1] Included



PT9297-MPG Wire Mesh Supported Maximum Performance Glass Hydraulic Element
Replaces: Stauff SL090E10B; Woodgate WGH9961
O.D.: 3 29/32 (99.2)
I.D.: 1 5/8 (41.3) One End
Height: 9 1/4 (235.0)



PT9290-MPG Wire Mesh Supported Maximum Performance Glass Hydraulic Element
Contains: 24 PSID By-Pass Valve
Fits: Fiat-Allis, Fiat-Hitachi Loaders
Replaces: MP Filtri MF4003AA25HB; Woodgate WGH9581
O.D.: 5 1/8 (130.2)
I.D.: 2 15/32 (62.7) One End
Height: 10 1/4 (260.4)
O-Ring: [1] Included



PT9300-MPG Wire Mesh Supported Maximum Performance Glass Hydraulic Element with Bail Handle
Contains: 43 PSID By-Pass Valve
Replaces: Hydac 240R020BNHC; Woodgate WGH24020RB
O.D.: 2 29/32 (73.8)
I.D.: 1 13/32 (35.7) One End
Height: 8 (203.2)
O-Ring: [1] Attached



PT9291-MPG Wire Mesh Supported Maximum Performance Glass Hydraulic Element
Replaces: MP Filtri CU250A10NA; Woodgate WGH9633
O.D.: 3 29/32 (99.2)
I.D.: 2 1/16 (52.4)
Height: 8 5/16 (211.1)
O-Ring: [2] Included



PT9302-MPG Wire Mesh Supported Maximum Performance Glass Hydraulic Element
Replaces: Hydac 60D010BHHC; Woodgate WGH60010DH
O.D.: 1 27/32 (46.8)
I.D.: 13/16 (20.6) One End
Height: 3 9/32 (83.3)
O-Ring: [1] Attached



PT9293-MPG Wire Mesh Supported Maximum Performance Glass Hydraulic Element
Replaces: Parker GO2005; Woodgate WGH9698
O.D.: 2 3/8 (60.3)
I.D.: 1 5/32 (29.4) & 1 7/16 (36.5)
Height: 5 9/32 (134.1)
O-Ring: [2] Attached



PT9303-MPG Wire Mesh Supported Maximum Performance Glass Hydraulic Element
Replaces: Hydac 660D010BNHC; Woodgate WGH66010DB
O.D.: 3 9/16 (90.5)
I.D.: 1 23/32 (43.7) One End
Height: 12 15/16 (328.6)
O-Ring: [1] Attached



PT9295-MPG Wire Mesh Supported Maximum Performance Glass Hydraulic Element
Replaces: Stauff SL010E20B; Woodgate WGH9839
O.D.: 1 13/16 (46.0)
I.D.: 15/16 (23.8) One End
Height: 4 15/32 (113.5)
O-Ring: [1] Attached



PT9304-MPG Wire Mesh Supported Maximum Performance Glass Hydraulic Element
Replaces: Genie 60857; Hydac 75D005BNHC; Woodgate WGH75005DB
O.D.: 2 7/32 (56.4)
I.D.: 15/16 (23.8) One End
Height: 6 21/32 (169.1)
O-Ring: [1] Attached



Measurements Are Shown In Inches And (Millimeters)

WARNING: These products can expose you to chemicals, including Diisononyl Phthalate, Carbon black extracts, Nickel, 1,3 Butadiene, Ethylene Oxide, Epichlorohydrin, which are known to the State of California to cause cancer, and Bisphenol, Ethylene Glycol, Ethylene Oxide, 1,3 Butadiene, Epichlorohydrin, which are known to the State of California to cause birth defects or other reproductive harm. For more information go to www.P65Warnings.ca.gov.

PT9306-MPG Wire Mesh Supported Maximum Performance Glass Hydraulic Element
Replaces: Fairey-Arlon TXW8CCC25; Fleetguard HF7991; Woodgate WGTW8CCC-25
O.D.: 4 31/32 (126.2)
I.D.: 13/32 (10.3) & 3 5/8 (92.1)
Height: 18 29/32 (480.2)
O-Ring: [1] Attached



PT9312-MPG Wire Mesh Supported Maximum Performance Glass Hydraulic Element
Replaces: MP Filtri HP3201A10NA; Woodgate WGH9322
O.D.: 3 1/16 (77.8)
I.D.: 1 9/16 (39.7) One End
Height: 4 19/32 (116.7)
O-Ring: [1] Attached



PT9307-MPG Wire Mesh Supported Maximum Performance Glass Hydraulic Element
Replaces: Demag 76204273; Woodgate WGH1708
O.D.: 3 1/16 (77.8)
I.D.: 1 9/16 (39.7) One End
Height: 6 11/16 (169.9)
O-Ring: [1] Attached



PT9313-MPG Wire Mesh Supported Maximum Performance Glass Hydraulic Element
Replaces: MP Filtri HP3202A25NA; Woodgate WGH9340
O.D.: 3 1/16 (77.8)
I.D.: 1 9/16 (39.7) One End
Height: 9 9/32 (235.7)
O-Ring: [1] Attached



PT9308-MPG Wire Mesh Supported Maximum Performance Glass Hydraulic Element
Fits: Daewoo Loaders; New Holland Equipment
Replaces: Volvo 3114655; Fleetguard HF7658; Woodgate WGH1810
O.D.: 2 7/32 (56.4)
I.D.: 15/16 (23.8) One End
Height: 4 1/8 (104.8)
O-Ring: [1] Attached



PT9315 KIT Set of 2 Hydraulic Elements
Contains: By-Pass Valve
Replaces: Palfinger EA1412; Woodgate WGH1783
Larger Element
O.D.: 2 3/4 (69.9)
Height: 5 11/32 (135.7)
O-Ring: [1] Included
Spring: [1] Included
Smaller Element
O.D.: 1 5/8
Height: 1 11/32



PT9309-MPG Wire Mesh Supported Maximum Performance Glass Hydraulic Element
Fits: Massey Ferguson Equipment
Replaces: Massey Ferguson 3104387M1; Woodgate WGH1994
O.D.: 2 3/8 (60.3)
I.D.: 1 1/32 (26.2) One End
Height: 5 5/16 (134.9)
O-Ring: [1] Attached



BT9316-MPG Maximum Performance Glass Hydraulic Spin-on
Replaces: MP Filtri CS70A10; Woodgate WGH9171
Thread: 3/4 -14 BSP-PL
O.D.: 3 25/32 (96.0)
Height: 7 19/32 (192.9)
I.Gskt: [1] Included



PT9310-MPG Wire Mesh Supported Maximum Performance Glass Hydraulic Element
Replaces: MP Filtri HP0651A25AN; Woodgate WGH9193
O.D.: 1 25/32 (45.2)
I.D.: 15/16 (23.8) One End
Height: 3 13/32 (86.5)
O-Ring: [1] Attached



BT9318 Hydraulic Spin-on
Contains: Anti-Drainback Valve
 29 PSID By-Pass Valve
Fits: Scania Trucks
Replaces: Scania 1301696; Fleetguard HF7535; Woodgate WGH7535
Thread: M23 x 1.5
O.D.: 3 13/16 (96.8)
Height: 4 5/16 (109.5)
I.Gskt: G381-A



PT9311-MPG Wire Mesh Supported Maximum Performance Glass Hydraulic Element
Replaces: MP Filtri HP1351P10AN; Woodgate WGH9250
O.D.: 2 3/32 (53.2)
I.D.: 1 (25.4) One End
Height: 4 11/16 (119.1)
O-Ring: [1] Attached



BT9320 Wire Mesh Supported Hydraulic Spin-on with Removal Nut
Contains: 14 PSID By-Pass Valve
Replaces: CompAir 9826279; Fleetguard HF6329; Woodgate WGH6329
Thread: 1 1/2 -11 BSP-PL
O.D.: 4 15/16 (125.4)
Height: 7 17/32 (191.3)
F. Gskt: [1] Included



Measurements Are Shown In Inches And (Millimeters)

WARNING: These products can expose you to chemicals, including Diisononyl Phthalate, Carbon black extracts, Nickel, 1,3 Butadiene, Ethylene Oxide, Epichlorohydrin, which are known to the State of California to cause cancer, and Bisphenol, Ethylene Glycol, Ethylene Oxide, 1,3 Butadiene, Epichlorohydrin, which are known to the State of California to cause birth defects or other reproductive harm. For more information go to www.P65Warnings.ca.gov.

BT9321

Hydraulic Spin-on



Fits: Kobelco Excavators; Kubota Equipment
Replaces: Kobelco S15510-35110;
 Yanmar 155103-5110; 172179-7372
Thread: 1 1/8 -16
O.D.: 3 23/32 (94.5)
Height: 6 13/16 (173.0)
I.Gskt: [1] Included

PT9330-MPG

Wire Mesh Supported Maximum Performance
Glass Hydraulic Element



Fits: Bomag Paving Equipment;
 JLG Equipment
Replaces: Hydac 110D010BNHC;
 Woodgate WGH11010DB
O.D.: 1 7/8 (47.6)
I.D.: 13/16 (20.6) One End
Height: 6 1/32 (153.2)
O-Ring: [1] Attached

BT9324

Stainless Steel Mesh Hydraulic Spin-on



Replaces: MP Filtri CS100M60;
 Woodgate WGH9178
Thread: 1 1/4 -11 BSP-PL
O.D.: 5 1/32 (127.8)
Height: 7 7/32 (183.4)
I.Gskt: [1] Included

PT9331

Hydraulic Element



Contains: Threaded hex nut for removal.
Replaces: U.C.C. UCSE1326;
 Woodgate WGSE1326
Thread: 2 -11 BSP-PL
O.D.: 3 5/16 (84.1)
Height: 10 7/32 (259.6)

BT9326

Air Breather Spin-on



Replaces: Woodgate WGUC4930
Thread: 3/4 -14 BSP-PL
O.D.: 3 3/4 (95.3)
Height: 2 5/16 (58.7)
I.Gskt: [1] Included

PT9332

Hydraulic Element



Replaces: J.C. Bamford 581/05609;
 Woodgate WGTX3ER-10
O.D.: 2 7/8 (73.0)
I.D.: 5/8 (7.9) & 1 25/32 (45.2)
Height: 11 27/32 (300.8)

H9327

Wire Mesh Supported Hydraulic Element



Fits: Massey Ferguson Tractors
Replaces: Massey Ferguson 3619594-M1;
 Fleetguard HF28811
O.D.: 2 (50.8)
I.D.: 15/16 (23.8) One End
Height: 6 5/16 (160.3)
O-Ring: [1] Attached

PT9335-MPG

Maximum Performance Glass Hydraulic
Element



Replaces: Parker GO1098;
 Woodgate WGH1851
O.D.: 3 19/32 (91.3)
I.D.: 2 15/32 (62.7)
Height: 12 15/32 (316.7)

PT9328-MPG

Maximum Performance Glass Hydraulic
Element



Fits: Liebherr R984 Li Excavator
Replaces: Liebherr 7366869; Fleetguard
 HF28848; Woodgate WGH1921
O.D.: 5 31/32 (151.6)
I.D.: 1 5/8 (41.3) & 3 7/16 (87.3)
Height: 32 11/16 (830.3)
A. Gskt: [2] Attached

PT9337-MPG

Wire Mesh Supported Maximum Performance
Glass Hydraulic Element



Fits: Liebherr Equipment
Replaces: Caterpillar 109-7293;
 Liebherr 7362910; Donaldson P173188;
 Fleetguard HF7834
O.D.: 1 3/8 (34.9)
I.D.: 1/2 (12.7) One End
Height: 3 11/16 (93.7)
O-Ring: [1] Attached

PT9329

Hydraulic Element with Attached Spring



Fits: Renault Tractors
Replaces: Renault 7701015558;
 Fleetguard HF6186
O.D.: 2 3/4 (69.9)
I.D.: 1 (25.4) One End
Height: 5 1/2 (139.7)
O-Ring: [1] Included
Spring: [1] Attached

PT9338-MPG

Wire Mesh Supported Maximum Performance
Glass Hydraulic Element



Fits: John Deere Equipment
Replaces: John Deere AT162766;
 Fleetguard HF7989
O.D.: 5 29/32 (150.0)
I.D.: 4 11/32 (110.3)
Height: 17 23/32 (450.1)
A. Gskt: [2] Attached
O-Ring: [1] Included

Measurements Are Shown In Inches And (Millimeters)

WARNING: These products can expose you to chemicals, including Diisononyl Phthalate, Carbon black extracts, Nickel, 1,3 Butadiene, Ethylene Oxide, Epichlorohydrin, which are known to the State of California to cause cancer, and Bisphenol, Ethylene Glycol, Ethylene Oxide, 1,3 Butadiene, Epichlorohydrin, which are known to the State of California to cause birth defects or other reproductive harm. For more information go to www.P65Warnings.ca.gov.

PT9340-MPG

Wire Mesh Supported Maximum Performance Glass Hydraulic Element



Notes: Inside-Out Flow Direction
Fits: Bomag Compactors; Case Excavators; Versatile Tractors
Replaces: Donaldson P164699; Fleetguard HF35021
O.D.: 4 3/8 (111.1)
I.D.: 3/4 (19.1) & 2 7/16 (61.9)
Height: 16 1/32 (407.2)
A. Gskt: [1] Attached
Grommets: [1] Attached

PT9341

Hydraulic Element with Attached Spring



Fits: Daewoo Equipment
Replaces: Daewoo 65-05504-5021
O.D.: 4 11/32 (110.3)
I.D.: 2 3/16 (55.6) One End
Height: 11 1/8 (282.6)
A. Gskt: [1] Attached
O-Ring: [2] Included

PT9342-MPG

Wire Mesh Supported Maximum Performance Glass Hydraulic Element



Fits: Skytrak Telehandlers
Replaces: Koehring 8320265; Parker 932000
O.D.: 3 11/16 (93.7)
I.D.: 1 19/32 (40.5)
Height: 8 1/4 (209.6)
Grommets: [2] Attached

BT9343-MPG

Maximum Performance Glass Hydraulic Spin-on



Fits: John Deere Motor Graders
Replaces: John Deere AT193883; Fleetguard HF6840
Thread: 1 1/2 -16
O.D.: 4 13/16 (122.2)
Height: 7 15/32 (189.7)
I.Gskt: [1] Included

PT9344

Hydraulic Element



Notes: Inside-Out Flow Direction
Replaces: Gillig 5322412002; Fleetguard HF8140
O.D.: 4 (101.6)
I.D.: 1 3/32 (27.8) & 1 15/32 (37.3)
Height: 5 7/32 (132.6)
A. Gskt: [2] Attached

BT9345

Hydraulic Spin-on



Fits: Ransomes Jacobsen HR6010 Mower
Replaces: Ransomes Jacobsen 178025
Thread: 1 1/2 -16
O.D.: 5 1/16 (128.6)
Height: 10 3/4 (273.1)
I.Gskt: G369-B

BT9346-MPG

Wire Mesh Supported Maximum Performance Glass Hydraulic Spin-on



Contains: 15 PSID By-Pass Valve
Fits: John Deere Tractors
Replaces: John Deere RE27284
Thread: 1 1/2 -16
O.D.: 3 11/16 (93.7)
Height: 5 9/16 (141.3)
I.Gskt: [1] Included

BT9347-MPG

Maximum Performance Glass Hydraulic Spin-on



Fits: Hitachi, John Deere Loaders
Replaces: John Deere AT189924, AT195915, AT228474, AT310905
Thread: M90 x 2.0
O.D.: 4 23/32 (119.9)
Height: 11 23/32 (297.7)
I.Gskt: [1] Included

PT9348-MPG

Wire Mesh Supported Maximum Performance Glass Hydraulic Element with Handle



Contains: 25 PSID By-Pass Valve Bleed Hole Reinforced Centertube
Fits: Hitachi Excavators
Replaces: Hitachi 4448160, 4450003
O.D.: 6 1/8 (155.6)
I.D.: 3 15/16 (100.0) One End
Height: 18 5/32 (461.2)
I.Gskt: [1] Included
A. Gskt: [1] Attached
O-Ring: [1] Included

BT9349-MPG

Maximum Performance Glass Hydraulic Spin-on



Fits: Caterpillar Equipment
Replaces: Caterpillar 184-3931; Donaldson P170310
Thread: 2 -12
O.D.: 3 1/8 (79.4)
Height: 5 17/32 (140.5)

PT9350-MPG

Wire Mesh Supported Maximum Performance Glass Hydraulic Element



Replaces: O&K 1717467; Donaldson P173081; Fleetguard HF7833; Woodgate WGH4060
O.D.: 6 (152.4)
I.D.: 3 15/16 (100.0) One End
Height: 25 1/2 (647.7)

PT9351-MPG

Wire Mesh Supported Maximum Performance Glass Hydraulic Element



Fits: Komatsu Equipment
Replaces: Komatsu 207-607-1180
O.D.: 5 15/16 (150.8)
I.D.: 3 19/32 (91.3)
Height: 7 7/8 (200.0)
Related To: PT9399-MPG (Long Version)

Measurements Are Shown In Inches And (Millimeters)



WARNING: These products can expose you to chemicals, including Diisononyl Phthalate, Carbon black extracts, Nickel, 1,3 Butadiene, Ethylene Oxide, Epichlorohydrin, which are known to the State of California to cause cancer, and Bisphenol, Ethylene Glycol, Ethylene Oxide, 1,3 Butadiene, Epichlorohydrin, which are known to the State of California to cause birth defects or other reproductive harm. For more information go to www.P65Warnings.ca.gov.

PT9352

Wire Mesh Hydraulic Element



Notes: Has M10 x 1.5 threaded bushing in closed end.
Fits: Fiat-Hitachi, Hitachi Equipment
Replaces: Hitachi 4210224, 4385915; John Deere TH110133
O.D.: 5 29/32 (150.0)
I.D.: 3 13/32 (86.5) One End
Height: 5 5/16 (134.9)
O-Ring: [1] Attached

BT9358

Transmission Spin-on



Contains: Reinforced Centertube
Fits: Kubota Equipment
Replaces: Kubota TA240-59900, TA240-59901
Thread: 1 1/8 -16
O.D.: 3 25/32 (96.0)
Height: 6 15/32 (164.3)
I.Gskt: [1] Included

BT9353-MPG

Maximum Performance Glass Hydraulic Spin-on



Fits: Caterpillar, John Deere Equipment
Use With: OB8771, OB8772, OB8773 filter bases.
Replaces: Caterpillar 225-4118
Thread: 1 3/4 -12
O.D.: 4 23/32 (119.9)
Height: 11 17/32 (292.9)
I.Gskt: [1] Included

PT9359-MPG

Wire Mesh Supported Maximum Performance Glass Hydraulic Element with Bail Handle



Contains: 43.5 PSID By-Pass Valve
Replaces: McNeilus 1137725; Schroeder SBF0500RZ10B; Donaldson P173173
O.D.: 3 23/32 (94.5)
I.D.: 1 29/32 (48.4) One End
Height: 10 7/8 (276.2)
O-Ring: [1] Attached

PT9354-MPG

Wire Mesh Supported Maximum Performance Glass Hydraulic Element



Fits: Freightliner, International, Kenworth, Mack, Peterbilt, Sterling Trucks
Replaces: International 1698964-C92; Nelson 87904M
O.D.: 3 3/8 (85.7)
I.D.: 1 1/8 (28.6)
Height: 2 23/32 (69.1)
Grommets: [2] Attached

BT9360

Hydraulic Spin-on



Fits: Komatsu Equipment
Replaces: Komatsu 4196-03-5152
Thread: M120 x 2.0
O.D.: 5 3/32 (129.4)
Height: 11 (279.4)
A. Gskt: [1] Attached
O-Ring: [1] Included

PT9355-MPG

2-Section Maximum Performance Glass Hydraulic Element with Bail Handle



Contains: Strainer Basket
Fits: Liebherr Excavators
Replaces: Liebherr 7373878; Fleetguard HF35109
O.D.: 6 1/8 (155.6)
I.D.: 3 5/32 (80.2) & 3 15/16 (100.0)
Height: 20 1/2 (520.7)
I.Gskt: [2] Included

PT9361

Hydraulic Element



Notes: Inside-Out Flow Direction
Replaces: Zinga WE51810; Donaldson P550582
O.D.: 5 7/32 (132.6)
I.D.: 3 3/8 (85.7)
Height: 18 7/16 (468.3)
Grommets: [2] Attached

BT9356

Hydraulic Spin-on



Fits: Case-International, New Holland Equipment
Replaces: New Holland 86632018, 87027973
Thread: 1 1/2 -16
O.D.: 5 1/16 (128.6)
Height: 6 31/32 (177.0)
F. Gskt: G369-B
O. Gskt: G286-C, G369-V, G372, G447, G483, G704, G710

BT9362-MPG

Maximum Performance Glass Hydraulic Spin-on



Fits: Case, New Holland Dozers; Case-International Combines, Tractors
Use With: OB8711, OB8712, OB8720, OB8721, OB8722, OB8724, OB8731, OB8732, OB8741, OB8742, OB8743, OB8744, OB8745, OB8746 filter bases.
Replaces: Case 254353A1
Thread: 1 3/8 -12
O.D.: 4 23/32 (119.9)
Height: 11 17/32 (292.9)
O-Ring: [1] Included

PT9357

Hydraulic Element



Fits: Volvo Excavators
Replaces: Volvo 14509379
O.D.: 5 29/32 (150.0)
I.D.: 4 11/32 (110.3)
Height: 17 23/32 (450.1)
O-Ring: [1] Included

BT9363-MPG

Maximum Performance Glass Hydraulic Spin-on



Fits: Volvo Excavators
Use With: OB8711, OB8712, OB8720, OB8721, OB8722, OB8724, OB8731, OB8732, OB8741, OB8742, OB8743, OB8744, OB8745, OB8746 filter bases.
Replaces: Volvo 11802677
Thread: 1 3/8 -12
O.D.: 3 3/4 (95.3)
Height: 9 19/32 (243.7)
I.Gskt: [1] Included

Measurements Are Shown In Inches And (Millimeters)

WARNING: These products can expose you to chemicals, including Diisononyl Phthalate, Carbon black extracts, Nickel, 1,3 Butadiene, Ethylene Oxide, Epichlorohydrin, which are known to the State of California to cause cancer, and Bisphenol, Ethylene Glycol, Ethylene Oxide, 1,3 Butadiene, Epichlorohydrin, which are known to the State of California to cause birth defects or other reproductive harm. For more information go to www.P65Warnings.ca.gov.

BT9364

Hydraulic Spin-on



Contains: 50 PSID By-Pass Valve
By-Pass Screen
Fits: Bobcat Loaders with Kubota Engine
Use With: OB8711, OB8712, OB8720, OB8721,
OB8722, OB8724, OB8731, OB8732, OB8741,
OB8742, OB8743, OB8744, OB8745, OB8746
filter bases.
Replaces: Melroe-Bobcat 6677652
Thread: 1 3/8 -12
O.D.: 3 3/4 (95.3)
Height: 6 1/8 (155.6)
I.Gskt: [1] Included

BT9365-MPG

Maximum Performance Glass Hydraulic Spin-on



Fits: Caterpillar Equipment
Use With: OB8771, OB8772, OB8773 filter
bases.
Replaces: Caterpillar 134-3014
Thread: 1 3/4 -12
O.D.: 4 23/32 (119.9)
Height: 11 1/2 (292.1)
I.Gskt: [1] Included

BT9366-MPG

Maximum Performance Glass Hydraulic Spin-on



Fits: Caterpillar Equipment, Trucks
Replaces: Caterpillar 156-0214
Thread: 1 3/8 -12
O.D.: 3 11/16 (93.7)
Height: 9 19/32 (243.7)
I.Gskt: [1] Viton

BT9367-MPG

Maximum Performance Glass Hydraulic Spin-on



Fits: John Deere Equipment
Replaces: John Deere AT308274;
Fleetguard HF29033
Thread: M90 x 2.0
O.D.: 4 23/32 (119.9)
Height: 11 29/32 (302.4)
I.Gskt: [1] Included

BT9368-MPG

Maximum Performance Glass Hydraulic Spin-on



Fits: John Deere Motor Graders, Skidders
Replaces: John Deere AT306605
Thread: M72 x 2.0
O.D.: 3 7/8 (98.4)
Height: 9 3/16 (233.4)
I.Gskt: [1] Included

BT9369-MPG

Maximum Performance Glass Hydraulic Spin-on



Fits: John Deere Motor Graders
Replaces: John Deere AT305049;
Fleetguard HF29035
Thread: M90 x 2.0
O.D.: 4 23/32 (119.9)
Height: 8 29/32 (226.2)
I.Gskt: [1] Included

BT9370-MPG

Maximum Performance Glass Hydraulic Spin-on



Notes: Rated 1000 PSI minimum burst.
Dome end accepts 1/2 In. socket driver.
Fits: John Deere Mowers, Tractors
Use With: OB8711, OB8712, OB8720,
OB8721, OB8722, OB8724, OB8726, OB8731,
OB8732, OB8740, OB8741, OB8742, OB8743,
OB8744, OB8745, OB8746 Filter bases.
Replaces: John Deere RE205726
Thread: 1 3/8 -12
O.D.: 3 3/4 (95.3)
Height: 9 27/32 (250.0)
I.Gskt: [1] Included

BT9371-MPG

Maximum Performance Glass Hydraulic Spin-on



Notes: Can be used with OB1313, OB1314,
OB1315, OB1316 bases (requires optional
G286-C gasket).
Fits: Caterpillar, Ditch Witch Equipment;
Caterpillar Off-Highway Trucks
Replaces: Caterpillar 144-0832;
Donaldson P167162; Fleetguard HF6777
Thread: 1 1/2 -16
O.D.: 5 1/16 (128.6)
Height: 6 31/32 (177.0)
F. Gskt: G447

PT9372

Wire Supported Hydraulic Element with Bail
Handle



Contains: 14.5 PSID By-Pass Valve
Fits: Volvo Excavators
Replaces: Volvo 14375005
O.D.: 2 3/8 (60.3)
I.D.: 25/32 (19.8) One End
Height: 9 (228.6)
O-Ring: [1] Attached
Spring: [1] Included

PT9373-MPG

Wire Mesh Supported Maximum Performance
Glass Hydraulic Element



Contains: 30 PSI By-Pass Valve
Fits: Bobcat Excavators; Terex Equipment
Replaces: Melroe-Bobcat 5380658088
O.D.: 3 9/32 (83.3)
I.D.: 1 3/4 (44.5) One End
Height: 12 5/16 (312.7)
O-Ring: [1] Included

PT9374

Hydraulic Element



Fits: Scania Trucks
Replaces: Scania 1329876, 1381235;
Donaldson P550220
O.D.: 3 7/16 (87.3)
I.D.: 23/32 (18.3) One End
Height: 4 3/16 (106.4)
Grommets: [1] Attached

Measurements Are Shown In Inches And (Millimeters)

WARNING: These products can expose you to chemicals, including Diisononyl Phthalate, Carbon black extracts, Nickel, 1,3 Butadiene, Ethylene Oxide, Epichlorohydrin, which are known to the State of California to cause cancer, and Bisphenol, Ethylene Glycol, Ethylene Oxide, 1,3 Butadiene, Epichlorohydrin, which are known to the State of California to cause birth defects or other reproductive harm. For more information go to www.P65Warnings.ca.gov.

PT9375

Hydraulic Element



Fits: Hyundai Excavators
Replaces: Hyundai 31E-34527
O.D.: 5 29/32 (150.0)
I.D.: 3 5/16 (84.1)
Height: 11 13/16 (300.0)
A. Gskt: [2] Attached

PT9381-MPG

Wire Supported Maximum Performance Glass Hydraulic Element with Bail Handle



Fits: Volvo Loaders
Replaces: Volvo 2906601, ZM2906601
O.D.: 3 1/16 (77.8)
I.D.: 1 23/32 (43.7) One End
Height: 12 5/16 (312.7)
O-Ring: [1] Attached

PT9376

Hydraulic Element



Fits: John Deere Excavators, Loaders
Replaces: Hitachi 4129280;
John Deere AT308568
O.D.: 3 1/2 (88.9)
I.D.: 1 7/8 (47.6)
Height: 14 3/16 (360.4)
O-Ring: [2] Included
Grommets: [2] Attached

BT9382

Hydraulic Spin-on



Contains: Hex nut for easy removal
Fits: Hitachi Excavators
Replaces: Hitachi 4252563; John Deere 4252563; Donaldson P550542; Fleetguard HF7553
Thread: 1 1/8 -16
O.D.: 3 11/16 (93.7)
Height: 5 7/8 (149.2)
I.Gskt: G381-A

BT9377

Hydraulic Spin-on



Fits: Komatsu Dozers, Excavators
Replaces: Komatsu 21N-60-12210; Fleetguard HF28894
Thread: M48 x 2.0
O.D.: 5 9/32 (134.1)
Height: 11 15/32 (291.3)
I.Gskt: [1] Included

PT9383-MPG

Maximum Performance Glass Hydraulic Element with Spring and Bail Handle



Contains: 65 PSID By-Pass Valve
Fits: Volvo Excavators
Replaces: Volvo 14375006
O.D.: 4 1/2 (114.3)
I.D.: 2 1/2 (63.5) One End
Height: 16 7/32 (412.0)
Spring: [1] Included

PT9378-MPG

Wire Mesh Supported Maximum Performance Glass Hydraulic Element



Fits: Ransomes Jacobsen HR6010 Mower
Replaces: Ransomes Jacobsen 8089620; Woodgate WGH1774
O.D.: 2 3/32 (53.2)
I.D.: 1 3/32 (27.8)
Height: 6 3/32 (154.8)
O-Ring: [1] Attached

PT9384-MPG

Wire Supported Maximum Performance Glass Hydraulic Element



Contains: 20 PSID By-Pass Valve
Fits: Volvo Loaders
Replaces: Volvo 2289977; Fleetguard HF28816
O.D.: 2 3/4 (69.9)
I.D.: 1 5/8 (41.3) One End
Height: 8 7/8 (225.4)
O-Ring: [1] Included
Grommets: [1] Attached

PT9379

Hydraulic Element



Fits: Komatsu Equipment
Replaces: Komatsu 7063-51-383
O.D.: 7 (177.8)
I.D.: 4 5/16 (109.5)
Height: 17 3/4 (450.9)
O-Ring: [1] Included

PT9385-MPG

Maximum Performance Glass Hydraulic Element



Replaces: Ingersoll-Rand 52263209; Donaldson P161571; Fleetguard HF6297
O.D.: 4 3/8 (111.1)
I.D.: 23/32 (18.3) & 2 13/32 (61.1)
Height: 16 1/16 (408.0)
A. Gskt: [1] Attached
Grommets: [1] Attached

PT9380-MPG

Wire Mesh Supported Maximum Performance Glass Hydraulic Element



Fits: Caterpillar Equipment
Replaces: Caterpillar 139-1537
O.D.: 5 1/8 (130.2)
I.D.: 3 3/8 (85.7)
Height: 6 31/32 (177.0)
A. Gskt: [2] Attached

PT9386-MPG

Wire Supported Maximum Performance Glass Hydraulic Element



Notes: Inside-Out Flow Direction
Fits: Freightliner, Kenworth, Peterbilt Trucks
Replaces: Nelson 87972A
O.D.: 5 (127.0)
I.D.: 7/8 (22.2) & 1 7/16 (36.5)
Height: 4 1/16 (103.2)
A. Gskt: [2] Attached

Measurements Are Shown In Inches And (Millimeters)

WARNING: These products can expose you to chemicals, including Diisononyl Phthalate, Carbon black extracts, Nickel, 1,3 Butadiene, Ethylene Oxide, Epichlorohydrin, which are known to the State of California to cause cancer, and Bisphenol, Ethylene Glycol, Ethylene Oxide, 1,3 Butadiene, Epichlorohydrin, which are known to the State of California to cause birth defects or other reproductive harm. For more information go to www.P65Warnings.ca.gov.

BT9387

Hydraulic Spin-on



Contains: 10 PSID By-Pass Valve
By-Pass Screen
Fits: Massey Ferguson Tractors
Replaces: AGCO 3383386M92; Massey
Ferguson 3383386-M92; Fleetguard HF7950
Thread: M42 x 2.0
O.D.: 5 3/8 (136.5)
Height: 8 5/8 (219.1)
I.Gskt: [1] Included

BT9393-MPG

Maximum Performance Glass Hydraulic Spin-on



Fits: Caterpillar Equipment, Off-Highway
Trucks
Replaces: Caterpillar 126-1813;
Donaldson P170308
Thread: 2 -12
O.D.: 3 1/8 (79.4)
Height: 5 17/32 (140.5)
I.Gskt: [1] Included

BT9388

Power Steering Spin-on



Contains: 20 PSID By-Pass Valve
Fits: International Thomas, Buses; Ford,
Freightliner, International, Sterling,
Western Star Trucks
Replaces: Ford 4C4Z-3C602-AA,
F8HZ-3C602-AA; Freightliner T1808D,
VMLT1808D; International 2503221-C1
Thread: 3/4 -16
O.D.: 2 21/32 (67.5)
Height: 3 1/2 (88.9)
I.Gskt: [1] Included

PT9394-MPG

Wire Supported Maximum Performance Glass
Power Steering Element



Notes: Inside-Out Flow Direction
Fits: Kenworth, Mack Trucks
Replaces: Mack 5839870678A; Nelson 870678A
O.D.: 3 3/8 (85.7)
I.D.: 13/16 (20.6)
Height: 4 1/8 (104.8)
Grommets: [2] Attached

PT9389-MPG

Wire Mesh Supported Maximum Performance
Glass Hydraulic Element



Fits: John Deere Motor Graders
Replaces: John Deere AT181127;
Fleetguard HF28999
O.D.: 2 7/8 (73.0)
I.D.: 1 15/32 (37.3) One End
Height: 9 17/32 (242.1)
O-Ring: [1] Attached

PT9395-MPG

Maximum Performance Glass Hydraulic
Element



Fits: Case-International, Fendt, J.C. Bamford,
Massey Ferguson Tractors
Replaces: Case 192200280705;
Fleetguard HF35320
O.D.: 2 3/4 (69.9)
I.D.: 1 (25.4) One End
Height: 7 29/32 (200.8)
I.Gskt: [1] Included

PT9390-MPG

Wire Mesh Supported Maximum Performance
Glass Hydraulic Element with Bail Handle



Contains: 43.5 PSID By-Pass Valve
Fits: Caterpillar Equipment
Replaces: Caterpillar 143-2849;
Fleetguard ST1264
O.D.: 3 23/32 (94.5)
I.D.: 1 13/16 (46.0) One End
Height: 7 5/8 (193.7)

PT9396

Hydraulic Element



Fits: Case, Kobelco, New Holland Excavators
Replaces: Kobelco PA33H01040P1;
New Holland PA33H01040P1
O.D.: 2 3/4 (69.9)
I.D.: 1 5/8 (41.3)
Height: 4 29/32 (124.6)

BT9391-MPG

Maximum Performance Glass Hydraulic Spin-on



Fits: Case-International, New Holland Tractors
Replaces: New Holland 86018758
Thread: 1 3/8 -12
O.D.: 4 23/32 (119.9)
Height: 11 17/32 (292.9)
I.Gskt: [1] Included

PT9397-MPG

Wire Mesh Supported Maximum Performance
Glass Hydraulic Element



Fits: Barber-Greene, Caterpillar Paving
Equipment
Replaces: Caterpillar 77-5479
O.D.: 3 29/32 (99.2)
I.D.: 1 5/8 (41.3)
Height: 9 9/32 (235.7)
Grommets: [2] Attached

BT9392-MPG

Maximum Performance Glass Hydraulic Spin-on



Fits: Caterpillar Equipment, Off-Highway
Trucks
Replaces: Caterpillar 126-1814;
Donaldson P170309; Wix 57397
Thread: 2 -12
O.D.: 3 1/8 (79.4)
Height: 9 17/32 (242.1)
I.Gskt: [2] Included

BT9398-MPG

Maximum Performance Glass
Hydraulic/Transmission Spin-on





Fits: John Deere Tractors
Replaces: John Deere AL156624, RE55801;
Donaldson P178619; Fleetguard HF35339
Thread: 1 3/8 -12
O.D.: 3 3/4 (95.3)
Height: 4 25/32 (121.4)
I.Gskt: [1] Included

Measurements Are Shown In Inches And (Millimeters)

WARNING: These products can expose you to chemicals, including Diisononyl Phthalate, Carbon black extracts, Nickel, 1,3 Butadiene, Ethylene Oxide, Epichlorohydrin, which are known to the State of California to cause cancer, and Bisphenol, Ethylene Glycol, Ethylene Oxide, 1,3 Butadiene, Epichlorohydrin, which are known to the State of California to cause birth defects or other reproductive harm. For more information go to www.P65Warnings.ca.gov.

PT9399-MPG Maximum Performance Glass Hydraulic Element

Fits: Komatsu Excavators, Loaders
Replaces: Komatsu 209-60-77531
O.D.: 5 15/16 (150.8)
I.D.: 3 19/32 (91.3)
Height: 15 3/4 (400.1)
Related To: PT9351-MPG (Short Version)

PT9405 Hydraulic Element

Fits: Caterpillar Lift Trucks
Replaces: Caterpillar 92-2568; Donaldson P161413; Fleetguard HF6465
O.D.: 4 3/8 (111.1)
I.D.: 2 7/16 (61.9)
Height: 8 1/8 (206.4)
A. Gskt: [2] Attached

BT9400-MPG Maximum Performance Glass Hydraulic Spin-on

Notes: Rated 1000 PSID Minimum Burst.
Contains: 50 PSID By-Pass Valve By-Pass Screen
Replaces: Dana 4209440; Kalmar 9210280007
Thread: 2 -16
O.D.: 3 3/4 (95.3)
Height: 7 7/32 (183.4)
O-Ring: [2] Attached

PT9406-MPG Maximum Performance Glass Hydraulic Element

Fits: Caterpillar Paving Equipment
Replaces: Caterpillar 1G5459
O.D.: 1 25/32 (45.2)
I.D.: 1 (25.4) One End
Height: 8 3/16 (208.0)
O-Ring: [1] Attached

PT9401 Wire Mesh Supported Hydraulic Element

Contains: 3/8-16 Threaded Nut on Closed End
Fits: Hitachi Excavators
Replaces: Hitachi 4333464
O.D.: 7 7/8 (200.0)
I.D.: 4 15/32 (113.5) One End
Height: 5 15/32 (138.9)
O-Ring: [1] Attached

PT9407-MPG Maximum Performance Glass Hydraulic Element

Fits: Caterpillar Equipment, Off-Highway Trucks
Replaces: Caterpillar 1R1809
O.D.: 4 29/32 (124.6)
I.D.: 2 1/16 (52.4)
Height: 10 15/32 (265.9)
I.Gskt: [1] Viton
O-Ring: [1] Included

BT9402 Transmission Spin-on

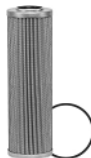
Contains: 50 PSID By-Pass Valve
Fits: Case, New Holland Equipment
Replaces: New Holland 85817004
Thread: 13/16 -16
O.D.: 3 1/32 (77.0)
Height: 5 1/2 (139.7)
I.Gskt: [1] Included

BT9408 Air Coalescer Spin-on

Fits: Iveco Trucks; Mack CHN613 Truck
Replaces: Cummins 3682984; Mack 279GB43M; Donaldson P566130; Fleetguard AF26113
Thread: M16 x 1.5
O.D.: 3 1/32 (77.0)
Height: 2 5/16 (58.7)
I.Gskt: G449-B

PT9403-MPG Wire Mesh Supported Maximum Performance Glass Hydraulic Element with Bail Handle

Contains: 22 PSID By-Pass Valve
Fits: John Deere, Timberjack Equipment
Replaces: John Deere F061786; Donaldson P173178
O.D.: 4 1/2 (114.3)
I.D.: 2 3/4 (69.9) One End
Height: 16 3/16 (411.2)
O-Ring: [1] Attached

PT9409-MPG Wire Supported Maximum Performance Glass Hydraulic Element

Fits: John Deere Tractors
Replaces: John Deere AL160316, AL160771; Fleetguard HF35343
O.D.: 3 3/32 (78.6)
I.D.: 1 21/32 (42.1)
Height: 10 1/4 (260.4)
O-Ring: [2] Attached, [1] Included

PT9404-MPG Maximum Performance Glass Hydraulic Element

Fits: Case Tractors
Replaces: Case K210049; Fleetguard HF28939
O.D.: 3 1/8 (79.4)
I.D.: 1 11/16 (42.9) One End
Height: 4 5/8 (117.5)
O-Ring: [1] Attached

PT9410-MPG Wire Supported Maximum Performance Glass Hydraulic Element

Notes: Inside-Out Flow Direction
Fits: Lull Lift Trucks
Replaces: Lull 10727810, P27810
O.D.: 4 5/32 (105.6)
I.D.: 13/32 (10.3) & 2 13/16 (71.4)
Height: 7 15/32 (189.7)
Grommets: [1] Attached

Measurements Are Shown In Inches And (Millimeters)

 **WARNING:** These products can expose you to chemicals, including Diisononyl Phthalate, Carbon black extracts, Nickel, 1,3 Butadiene, Ethylene Oxide, Epichlorohydrin, which are known to the State of California to cause cancer, and Bisphenol, Ethylene Glycol, Ethylene Oxide, 1,3 Butadiene, Epichlorohydrin, which are known to the State of California to cause birth defects or other reproductive harm. For more information go to www.P65Warnings.ca.gov.

PT9411-MPG

Maximum Performance Glass Hydraulic Element



Fits: Komatsu Dozers, Excavators
Replaces: Komatsu 2076-07-1182
O.D.: 5 15/16 (150.8)
I.D.: 3 19/32 (91.3)
Height: 7 7/8 (200.0)

PT9412-MPG

Wire Supported Maximum Performance Glass Hydraulic Element



Replaces: Zinga S0910HN; Fleetguard HF30462; Purolator-Facet 9800EAH124N2
O.D.: 2 1/32 (51.6)
I.D.: 29/32 (23.0) One End
Height: 8 5/32 (207.2)
O-Ring: [1] Attached

PT9413-MPG

Maximum Performance Glass Hydraulic Element



Fits: Komatsu Equipment
Replaces: Komatsu 14X6031150
O.D.: 4 3/8 (111.1)
I.D.: 2 13/32 (61.1)
Height: 7 27/32 (199.2)

PT9414-MPG

Wire Supported Maximum Performance Glass Hydraulic Element



Fits: John Deere Forwarders, Wheeled Harvesters
Replaces: John Deere F058437; Timberjack F058437; Fleetguard HF35198
O.D.: 2 3/4 (69.9)
I.D.: 1 5/16 (33.3) One End
Height: 5 (127.0)
O-Ring: [1] Attached

PT9415-MPG KIT

Set of 2 Maximum Performance Glass Transmission Elements



Notes: High capacity filters.
Fits: Allison World Transmissions with 4 Inch Sump
Replaces: Allison 29545779; GMC 29506337; John Deere AT327883; Fleetguard HF28943
Each Element:
O.D.: 3 7/32 (81.8)
I.D.: 1 17/32 (38.9) One End
Height: 5 15/16 (150.8)
F. Gskt: [2] Irregular, [2] Square Cut
O-Ring: [6] Viton Included

PT9416-MPG KIT

Set of 2 Maximum Performance Glass Transmission Elements



Notes: High capacity filters.
Fits: Allison World Transmissions with 2 In. or 7 In. Sump
Replaces: Allison 29545776; Donaldson P179206, P560972; Fleetguard HF28944, HF35153
Each Element:
O.D.: 3 7/32 (81.8)
I.D.: 1 17/32 (38.9) One End
Height: 4 3/16 (106.4)
I.Gskt: [1] Included Each Element
F. Gskt: [2] Irregular, [2] Square Cut
O-Ring: [6] Viton Included

PT9417

Transmission Element



Fits: R.V.I., Volvo Trucks
Replaces: Renault 7401521527, 7485105048, 7485108176; Volvo 1521527, 20776259, 85108176, 85105048
O.D.: 2 17/32 (64.3)
I.D.: 1 7/32 (31.0)
Height: 5 7/8 (149.2)
A. Gskt: [2] Attached

PT9418

Hydraulic Element



Contains: Reinforced Centertube
Fits: Caterpillar Equipment
Replaces: Caterpillar 1R0778
O.D.: 5 1/8 (130.2)
I.D.: 3 3/8 (85.7)
Height: 9 (228.6)

PT9419-MPG

Maximum Performance Glass Hydraulic Element



Notes: Inside-Out Flow Direction
Fits: IHC Trucks
Replaces: International 1695528-C1; Nelson 87795A
O.D.: 2 15/32 (62.7)
I.D.: 1 11/32 (8.7) & 1 3/32 (27.8)
Height: 5 1/32 (127.8)

PT9420-MPG

Maximum Performance Glass Hydraulic Element



Fits: Komatsu CD110R-2 Crawler Carrier, D61EX-15EO, D61PX-15 Dozers, PC40MR-2, PC50MR-2, PC78MR-6, PC78US-6 Excavators
Replaces: Komatsu 21W-60-4112
O.D.: 4 3/8 (111.1)
I.D.: 2 7/16 (61.9)
Height: 3 31/32 (100.8)

Measurements Are Shown In Inches And (Millimeters)



WARNING: These products can expose you to chemicals, including Diisononyl Phthalate, Carbon black extracts, Nickel, 1,3 Butadiene, Ethylene Oxide, Epichlorohydrin, which are known to the State of California to cause cancer, and Bisphenol, Ethylene Glycol, Ethylene Oxide, 1,3 Butadiene, Epichlorohydrin, which are known to the State of California to cause birth defects or other reproductive harm. For more information go to www.P65Warnings.ca.gov.

BT9421-MPG



Maximum Performance Glass Hydraulic Spin-on
Fits: Case Dozers; Case-International Tractors
Replaces: Case 47131182, 87404986
Thread: 1 3/8 -12
O.D.: 4 23/32 (119.9)
Height: 11 17/32 (292.9)
I.Gskt: [1] Included

PT9427-MPG



Maximum Performance Glass Hydraulic Element
Notes: Inside-Out Flow Direction
Fits: Caterpillar D10T, D11T Crawler Tractors, 793D Off-Highway Truck, 587T Pipelayer, 657G Wheel Tractor
Replaces: Caterpillar 249-2337
O.D.: 6 25/32 (172.2)
I.D.: 4 1/4 (108.0)
Height: 9 (228.6)
A. Gskt: [2] Attached

BT9422



Hydraulic Spin-on
Contains: Stud Thread: M24 x 1.5
Fits: John Deere Equipment
Replaces: ZF 050132315401, 075013106101; Case/New Holland 332202A1, 8603535; John Deere AT336140
O.D.: 3 3/4 (95.3)
Height: 8 1/32 (204.0)
I.Gskt: [1] Included

PT9429-MPG



Maximum Performance Glass Hydraulic Element
Fits: Caterpillar Equipment, Off-Highway Trucks
Replaces: Caterpillar 328-3655
O.D.: 4 29/32 (124.6)
I.D.: 2 (50.8) One End
Height: 10 15/32 (265.9)
O-Ring: [1] Viton Attached

PT9423



Hydraulic Element
Fits: Mercedes-Benz Trucks, Vans
Replaces: Mercedes-Benz 2690321, A0002690321; Donaldson P550744
O.D.: 2 5/16 (58.7)
I.D.: 5/8 (15.9) One End
Height: 4 1/32 (102.4)
A. Gskt: [1] Attached

PT9430-MPG



Maximum Performance Glass Hydraulic Element
Notes: Inside-Out Flow Direction
Fits: Caterpillar Equipment
Replaces: Caterpillar 104-6931
O.D.: 5 1/8 (130.2)
I.D.: 3 3/8 (85.7)
Height: 7 (177.8)

PT9424



Hydraulic Element
Fits: Hitachi, John Deere Kubota Excavators
Replaces: Hitachi 4294130; John Deere 4294130
O.D.: 1 21/32 (42.1)
I.D.: 27/32 (21.4) One End
Height: 2 1/16 (52.4)
O-Ring: [1] Attached

PT9432-MPG



Maximum Performance Glass Hydraulic Element
Replaces: Euclid E12635052, E4099537; Hitachi 12635052, 4099537
O.D.: 3 25/32 (96.0)
I.D.: 2 1/8 (54.0) One End
Height: 12 15/16 (328.6)
I.Gskt: [1] Viton
O-Ring: [2] Included

PT9425-MPG



Maximum Performance Glass Hydraulic Element
Fits: Barber-Greene, Caterpillar Asphalt Pavers
Replaces: Caterpillar 123-2873
O.D.: 3 25/32 (96.0)
I.D.: 2 1/8 (54.0)
Height: 8 5/32 (207.2)
O-Ring: [1] Attached

BT9433



Hydraulic Spin-on
Fits: Caterpillar Dozers, Loaders
Replaces: Caterpillar 222-6713
Thread: 1 3/8 -12
O.D.: 3 3/4 (95.3)
Height: 9 17/32 (242.1)
O-Ring: [1] Attached

PT9426



Hydraulic Breather Element
Fits: Komatsu Compactors, Dump Trucks, Excavators, Loaders
Replaces: Komatsu 285-62-17320; Fleetguard HF28928
O.D.: 2 1/32 (51.6)
I.D.: 1 15/32 (37.3)
Height: 2 1/32 (51.6)

PT9434



Hydraulic Element
Contains: 35 PSID By-Pass Valve
Fits: Renault R212, R312, R322 Buses
Replaces: Renault 5000293901; Mann & Hummel H616/1
O.D.: 2 11/32 (59.5)
I.D.: 1 3/16 (30.2) One End
Height: 7 3/8 (187.3)
O-Ring: [1] Attached

Measurements Are Shown In Inches And (Millimeters)

WARNING: These products can expose you to chemicals, including Diisononyl Phthalate, Carbon black extracts, Nickel, 1,3 Butadiene, Ethylene Oxide, Epichlorohydrin, which are known to the State of California to cause cancer, and Bisphenol, Ethylene Glycol, Ethylene Oxide, 1,3 Butadiene, Epichlorohydrin, which are known to the State of California to cause birth defects or other reproductive harm. For more information go to www.P65Warnings.ca.gov.

PT9435-MPG

Maximum Performance Glass Hydraulic Element



Fits: Volvo Dump Trucks, T450D Articulated Scraper Hauler
Replaces: Volvo 11707544
O.D.: 2 3/32 (53.2)
I.D.: 29/32 (23.0) One End
Height: 4 15/32 (113.5)
I.Gskt: [1] Included
O-Ring: [1] Included

BT9442-MPG

Maximum Performance Glass Hydraulic Spin-on



Fits: Volvo Excavators, Forestry Carriers
Replaces: Volvo 14532687
Thread: 1 1/8 -16
O.D.: 3 11/16 (93.7)
Height: 5 3/8 (136.5)
I.Gskt: G381-A

BT9436-MPG

Maximum Performance Glass Hydraulic Spin-on



Fits: J.C. Bamford Equipment
Replaces: J.C. Bamford 32/909000
Thread: 1 3/8 -12
O.D.: 3 3/4 (95.3)
Height: 6 1/8 (155.6)
I.Gskt: [1] Included

PT9443

Hydraulic Element with Lift Bar



Fits: Hitachi, John Deere Excavators
Replaces: Hitachi 4443596, 4448401
O.D.: 4 13/32 (111.9)
I.D.: 2 1/8 (54.0) One End
Height: 20 11/16 (525.5)
I.Gskt: [1] Included
O-Ring: [1] Included

BT9437

Hydraulic Spin-on



Contains: By-Pass Valve
Replaces: CLARCOR Filtration (China) B7158B; Foton Lovol B7158B
Thread: M82 x 1.5
O.D.: 4 1/4 (108.0)
Height: 8 7/8 (225.4)
I.Gskt: [1] Included

PT9444-MPG

Maximum Performance Glass Hydraulic Element



Fits: Caterpillar Equipment, Off-Highway Trucks
Replaces: Caterpillar 1672009; Donaldson P550924
O.D.: 6 25/32 (172.2)
I.D.: 3 15/16 (100.0)
Height: 9 1/16 (230.2)
A. Gskt: [2] Attached

BT9439

Hydraulic Spin-on



Contains: 14 PSID By-Pass Valve
Fits: Ford, New Holland Tractors
Replaces: New Holland 82983474
Thread: 1 3/4 -16
O.D.: 4 21/32 (118.3)
Height: 9 15/16 (252.4)
I.Gskt: [1] Included

PT9445-MPG

Maximum Performance Glass Hydraulic Element



Fits: John Deere Dump Trucks
Replaces: John Deere TT222389; Donaldson P763016
O.D.: 4 31/32 (126.2)
I.D.: 3/8 (9.5) & 3 5/8 (92.1)
Height: 18 29/32 (480.2)
O-Ring: [1] Attached

BT9440

Hydraulic Spin-on



Contains: Hex nut for removal
Fits: Hitachi Excavators, John Deere Excavators, Forestry Swing Machines
Replaces: Hitachi 4630525
Thread: M68 x 2.0
O.D.: 3 7/16 (87.3)
Height: 6 13/32 (162.7)
O-Ring: [2] Attached

PT9446

Hydraulic Element



Notes: Inside-Out Flow Direction
Contains: By-Pass Valve
Fits: Caterpillar, Mitsubishi Lift Trucks
Replaces: Caterpillar 9257614100; Mitsubishi 9257614100
Thread: 1 -11 BSP
O.D.: 3 17/32 (89.7)
Height: 11 11/16 (296.9)

PT9441-MPG

Maximum Performance Glass Hydraulic Element



Fits: Caterpillar Equipment, Off-Highway Trucks
Replaces: Caterpillar 4T3133
O.D.: 6 25/32 (172.2)
I.D.: 3 15/16 (100.0)
Height: 9 1/16 (230.2)
A. Gskt: [2] Viton Attached

PT9447

Hydraulic Element



Contains: By-Pass Valve
Fits: Caterpillar, Mitsubishi Lift Trucks
Replaces: Caterpillar 9187505900, 9187511400; Mitsubishi 9187505900
Thread: 1 -11.5 NPT
O.D.: 3 3/32 (78.6)
Height: 7 17/32 (191.3)

Measurements Are Shown In Inches And (Millimeters)

WARNING: These products can expose you to chemicals, including Diisononyl Phthalate, Carbon black extracts, Nickel, 1,3 Butadiene, Ethylene Oxide, Epichlorohydrin, which are known to the State of California to cause cancer, and Bisphenol, Ethylene Glycol, Ethylene Oxide, 1,3 Butadiene, Epichlorohydrin, which are known to the State of California to cause birth defects or other reproductive harm. For more information go to www.P65Warnings.ca.gov.

PT9448

Hydraulic Element



Notes: Inside-Out Flow Direction
Contains: By-Pass Valve
Fits: Caterpillar, Mitsubishi Lift Trucks
Replaces: Caterpillar 9137503800;
 Mitsubishi 9137503800
Thread: 1 -11 BSP
O.D.: 3 17/32 (89.7)
Height: 6 5/16 (160.3)

BT9454

Hydraulic Spin-on with Removal Nut



Fits: Komatsu Equipment
Replaces: Komatsu 7140728711,
 7140728712, 7140728713
Thread: M60 x 2.0
O.D.: 4 5/32 (105.6)
Height: 10 3/8 (263.5)
I.Gskt: [1] Included
O-Ring: [2] Attached

PT9449

Power Steering Element



Fits: Mack CH612 Truck
Replaces: Mack 583983213F;
 Nelson 83213
O.D.: 3 3/8 (85.7)
I.D.: 2 (50.8)
Height: 2 23/32 (69.1)
Grommets: [2] Attached

BT9456

Transmission Spin-on



Contains: Anti-Drainback Valve
 30 PSID By-Pass Valve
Fits: J.C. Bamford Equipment
Replaces: ITL 58118062;
 J.C. Bamford 58118062
Thread: 1 -12
O.D.: 3 23/32 (94.4)
Height: 3 5/16 (84.1)
I.Gskt: G401

PT9450-MPG

Maximum Performance Glass Hydraulic Element



Fits: Kalmar Lift Trucks
Replaces: Kalmar 9216890007
O.D.: 3 19/32 (91.3)
I.D.: 1 29/32 (48.4) One End
Height: 7 3/4 (196.9)
I.Gskt: [1] Included
O-Ring: [3] Included

PT9459-MPG

2-Section Maximum Performance Glass Hydraulic Element with Bail Handle



Fits: Liebherr R984B, R984C Excavators
Replaces: Liebherr 7373884; Filtrec WG633;
 Fleetguard HF35367; Wix Industrial W01AG633
O.D.: 6 1/8 (155.6)
I.D.: 3 5/32 (80.2) & 3 29/32 (99.2)
Height: 37 3/8 (949.3)
O-Ring: [2] Attached

PT9451-MPG

Maximum Performance Glass Hydraulic Stacked Element with Bail Handle



Contains: Wire Mesh Strainer Basket
Fits: Liebherr Excavators
Replaces: Liebherr 7373881;
 Donaldson P784037
O.D.: 6 1/8 (155.6)
I.D.: 3 29/32 (99.2) One End
Height: 24 13/16 (630.2)
I.Gskt: [2] Included

PT9462

Hydraulic Element



Fits: Agco, Challenger Tractors
Replaces: Agco 3792287M1
O.D.: 1 21/32 (42.1)
I.D.: 27/32 (21.4) One End
Height: 3 1/2 (88.9)
O-Ring: [1] Attached

PT9452

Hydraulic Element



Fits: Hitachi Excavators, Loaders; John Deere
 Excavators, Forestry Swing Machines
Replaces: Hitachi 4656608;
 John Deere 4656608
O.D.: 6 1/16 (154.0)
I.D.: 3 3/4 (95.3)
Height: 17 1/4 (438.2)
A. Gskt: [2] Attached
O-Ring: [2] Included

PT9463

Hydraulic Element



Replaces: Force America SRE40910AZ
O.D.: 3 1/2 (88.9)
I.D.: 1 9/16 (39.7)
Height: 9 9/32 (235.7)
Grommets: [2] Attached

PT9453-MPG

Maximum Performance Glass Hydraulic Element



Replaces: Pall HC8900FKS16Z;
 Donaldson P167891, DT89001614UM;
 Fleetguard HF30317,
 Purolator-Facet 8900EAL122F3
O.D.: 3 25/32 (96.0)
I.D.: 2 3/16 (55.6) One End
Height: 16 7/8 (428.6)
O-Ring: [1] Attached

BT9464

Hydraulic Spin-on



Fits: Caterpillar Equipment
Replaces: Caterpillar 518670, 518670X
Thread: M45 x 2.0
O.D.: 3 7/16 (87.3)
Height: 6 1/16 (154.0)
I.Gskt: [1] Included
O-Ring: [1] Included

Measurements Are Shown In Inches And (Millimeters)

WARNING: These products can expose you to chemicals, including Diisononyl Phthalate, Carbon black extracts, Nickel, 1,3 Butadiene, Ethylene Oxide, Epichlorohydrin, which are known to the State of California to cause cancer, and Bisphenol, Ethylene Glycol, Ethylene Oxide, 1,3 Butadiene, Epichlorohydrin, which are known to the State of California to cause birth defects or other reproductive harm. For more information go to www.P65Warnings.ca.gov.

BT9465

Hydraulic Spin-on

Replaces: Raymond 52050901
Thread: 1 -12
O.D.: 3 11/16 (93.7)
Height: 5 15/32 (138.9)
I.Gskt: [1] Included



PT9473

In-Line Hydraulic Element

Fits: New Holland Combines
Replaces: New Holland 86525899
Thread: 1 3/16 -12
O.D.: 2 11/32 (59.5)
Length: 6 5/32 (156.4)
O-Ring: [2] Included



BT9466-MPG

Maximum Performance Glass Hydraulic Spin-on

Fits: Caterpillar Equipment
Replaces: Caterpillar 3416643;
 Donaldson P573360, P763535;
 Mann & Hummel WH9803
Thread: 1 3/8 -12
O.D.: 3 3/4 (95.3)
Height: 9 17/32 (242.1)
I.Gskt: [1] Included



PT9474

In-Line Hydraulic Filter

Fits: John Deere Lawn & Garden Equipment
Replaces: John Deere AM120916
O.D.: 2 3/16 (55.6)
Inlet: 11/16-16
Outlet: 13/16-16
Length: 3 11/16 (93.7)



PT9468

In-Line Hydraulic Spin-on

Fits: Bobcat Excavators, Loaders;
 John Deere Loaders
Replaces: Bobcat 6661022;
 John Deere KV13414
Thread: 9/16 -18
O.D.: 1 1/2 (38.1) to 1 23/32 (43.7)
Length: 3 3/16 (81.0)



S9475

Set of 2 Foam Hydraulic Tank Breathers

Fits: Komatsu Equipment
Replaces: Komatsu 20Y6021470;
 Donaldson P502518
O.D.: 2 7/16 (61.9)
I.D.: 1 31/32 (50.0)
Height: 15/16 (23.8)



PT9469

In-Line Hydraulic Filter

Fits: John Deere Loggers, Excavators;
 Hitachi Zaxis 350L Excavator
Replaces: John Deere 4452326
O.D.: 7/8 (22.2)
Inlet: 5/16
Outlet: 7/32
Length: 1 15/32 (37.3)
O-Ring: [1] Attached



PT9476-MPG

Maximum Performance Glass Hydraulic Element

Fits: Kobelco, New Holland Excavators
Replaces: Case YN52V01020P1; Kobelco
 YN52V01020P1, YN52V01011P1, YN52V01011P2;
 New Holland YN52V01020P1
O.D.: 5 23/32 (177.5)
I.D.: 3 13/16 (96.8)
Height: 5 1/4 (133.4)



PT9470

In-Line Hydraulic Filter

Fits: John Deere Equipment
Replaces: John Deere AT183869
O.D.: 1 1/2 (38.1)
Inlet: 11/16-16
Outlet: 13/16-16
Length: 2 13/16 (71.4)
O-Ring: [1] Attached



PT9477

Stainless Steel Mesh Hydraulic Element

Fits: Case, Fiat, Ford, New Holland Tractors
Replaces: Case 1909143;
 New Holland 1909143
O.D.: 1 3/4 (44.5)
I.D.: 1 (25.4) One End
Height: 3 15/16 (100.0)
A. Gskt: [1] Attached



BT9471

Hydraulic Spin-on

Contains: 40 PSID By-Pass Valve
Fits: Valtra Tractors
Replaces: Agco 836536797, 836579590;
 Valmet 20410800; Valtra V836536797
Thread: M24 x 1.5
O.D.: 3 23/32 (94.5)
Height: 4 3/16 (106.4)
I.Gskt: [1] Included



PT9478-MPG

Maximum Performance Glass Hydraulic Element

Fits: Fiat-Allis, Fiat-Hitachi,
 New Holland Loaders
Replaces: Case 76028203;
 New Holland 76028203;
 Donaldson P171733; Filtrec D132G25A
O.D.: 2 3/32 (53.2)
I.D.: 1 3/32 (27.8) One End
Height: 3 11/32 (84.9)
O-Ring: [1] Attached



PT9472

Hydraulic Element

Fits: Case, Link-Belt Excavators
Replaces: Case 159282A1;
 Link-Belt KHJ0738
O.D.: 6 13/32 (162.7)
I.D.: 9/16 (14.3) One End
Height: 9 7/16 (239.7)



PT9479-MPG

Maximum Performance Glass Hydraulic Element

Fits: J.C Bamford Loaders; MacDonald
 Johnston Trash Loaders
Replaces: J.C. Bamford 58100012;
 Donaldson P171825; Filtrec R714G10
O.D.: 2 27/32 (72.2)
I.D.: 11/32 (8.7) & 1 25/32 (45.2)
Height: 11 13/16 (300.0)



Measurements Are Shown In Inches And (Millimeters)



WARNING: These products can expose you to chemicals, including Diisononyl Phthalate, Carbon black extracts, Nickel, 1,3 Butadiene, Ethylene Oxide, Epichlorohydrin, which are known to the State of California to cause cancer, and Bisphenol, Ethylene Glycol, Ethylene Oxide, 1,3 Butadiene, Epichlorohydrin, which are known to the State of California to cause birth defects or other reproductive harm. For more information go to www.P65Warnings.ca.gov.

PT9480-MPG Maximum Performance Glass Hydraulic Element



Fits: Liebherr Dozers, Excavators
Replaces: Liebherr 7211198;
 Donaldson P173483; Filtrec WG140
O.D.: 5 31/32 (151.6)
I.D.: 1 11/16 (42.9) & 3 1/2 (88.9)
Height: 16 17/32 (419.9)
A. Gskt: [2] Attached

PT9486-MPG Maximum Performance Glass Hydraulic Element



Replaces: Donaldson P171742;
 Filtrec D154G25A
O.D.: 3 1/16 (77.8)
I.D.: 1 19/32 (40.5) One End
Height: 5 1/2 (139.7)
O-Ring: [1] Attached

PT9481-MPG Maximum Performance Glass Hydraulic Element



Fits: Komatsu Excavators, Loaders
Replaces: Komatsu 2076051410;
 Filtrec WG194
O.D.: 2 7/16 (61.9)
 Flange 2 15/16 (74.6)
I.D.: 31/32 (24.6) & 1 3/16 (30.2)
Height: 1 3/8 (34.9)

PT9487-MPG Maximum Performance Glass Hydraulic Element



Replaces: Schroeder KKS3;
 Donaldson P174247; Fleetguard HF30121
O.D.: 3 29/32 (99.2)
I.D.: 1 5/8 (41.3)
Height: 18 1/2 (469.9)

PT9482-MPG Maximum Performance Glass Hydraulic Element



Fits: Liebherr Excavators
Replaces: Liebherr 5618166;
 Filtrec WG426; Fleetguard HF35454
O.D.: 2 3/8 (60.3)
I.D.: 15/16 (23.8) One End
Height: 4 1/8 (104.8)
O-Ring: [1] Attached

PT9488-MPG Maximum Performance Glass Hydraulic Element



Replaces: Parker 931020Q; Donaldson
 P174260, P566277; Filtrec D651G25AV
O.D.: 3 29/32 (99.2)
I.D.: 1 5/8 (41.3)
Height: 18 1/2 (469.9)

PT9483-MPG Maximum Performance Glass Hydraulic Element



Fits: Caterpillar Equipment, Off-Highway
 Trucks
Replaces: Caterpillar 3434465;
 Donaldson P165239; Filtrec WG917
O.D.: 5 1/8 (130.2)
I.D.: 3 5/16 (84.1)
Height: 8 15/16 (227.0)
A. Gskt: [2] Viton Attached

PT9489-MPG Maximum Performance Glass Hydraulic Element



Replaces: Parker 929927Q; Donaldson
 P566498; Filtrec D761G25AV
O.D.: 3 25/32 (96.0)
I.D.: 2 7/32 (56.4) One End
Height: 12 31/32 (329.4)
O-Ring: [1] Viton Attached

PT9484-MPG Maximum Performance Glass Hydraulic Element



Fits: Case, New Holland Excavators
Replaces: Case 8914671; New Holland
 8914671; Filtrec D120G25B
O.D.: 2 (50.8)
I.D.: 15/16 (23.8) One End
Height: 4 1/2 (114.3)
O-Ring: [1] Attached

PT9490-MPG Maximum Performance Glass Hydraulic Element



Replaces: Hydac 240D010BNHC; Donaldson
 P170608, P566672; Filtrec DHD240G10B
O.D.: 2 23/32 (69.1)
I.D.: 1 11/32 (34.1) One End
Height: 6 13/16 (173.0)
O-Ring: [1] Attached

PT9485-MPG Maximum Performance Glass Hydraulic Element



Replaces: Separation Technologies
 3960SGHB04; Filtrec D140G10B
O.D.: 3 1/16 (77.8)
I.D.: 1 11/16 (42.9) One End
Height: 4 21/32 (118.3)
O-Ring: [1] Attached

PT9491-MPG Maximum Performance Glass Hydraulic Element



Replaces: Liebherr 7364597;
 Donaldson P177002, P566673
O.D.: 2 29/32 (73.8)
I.D.: 2 23/32 (69.1)
Height: 6 13/16 (173.0)
O-Ring: [1] Attached

Measurements Are Shown In Inches And (Millimeters)

WARNING: These products can expose you to chemicals, including Diisononyl Phthalate, Carbon black extracts, Nickel, 1,3 Butadiene, Ethylene Oxide, Epichlorohydrin, which are known to the State of California to cause cancer, and Bisphenol, Ethylene Glycol, Ethylene Oxide, 1,3 Butadiene, Epichlorohydrin, which are known to the State of California to cause birth defects or other reproductive harm. For more information go to www.P65Warnings.ca.gov.

PT9492-MPG	<p>Maximum Performance Glass Hydraulic Element</p> <p>Replaces: Hydac 330D010BH3HC; Donaldson P170595, P566701; Filtrec DHD330H10B</p> <p>O.D.: 3 9/16 (90.5)</p> <p>I.D.: 1 29/32 (48.4) One End</p> <p>Height: 6 3/8 (161.9)</p> <p>O-Ring: [1] Attached</p>	PT9498-MPG	<p>Maximum Performance Glass Hydraulic Element</p> <p>Replaces: Donaldson P165158; Filtrec R450G06; Fleetguard HF30073</p> <p>O.D.: 3 13/16 (96.8)</p> <p>I.D.: 1 11/16 (42.9) One End</p> <p>Height: 8 5/32 (207.2)</p> <p>O-Ring: [2] Attached</p>
PT9493-MPG	<p>Maximum Performance Glass Hydraulic Element</p> <p>Replaces: Donaldson P564860 Filtrec DHD75G10B</p> <p>O.D.: 2 7/32 (56.4)</p> <p>I.D.: 1 (25.4) One End</p> <p>Height: 6 11/16 (169.9)</p> <p>O-Ring: [1] Attached</p>	PT9499-MPG	<p>Maximum Performance Glass Hydraulic Element with Bail Handle</p> <p>Fits: Fendt Tractors</p> <p>Replaces: Fendt G716860060310; Filtrec R631G10</p> <p>O.D.: 2 1/2 (63.5)</p> <p>I.D.: 1 1/8 (28.6) One End</p> <p>Height: 12 3/16 (309.6)</p> <p>O-Ring: [1] Attached</p>
PT9494-MPG	<p>Maximum Performance Glass Hydraulic Element</p> <p>Replaces: Donaldson P174297; Filtrec DMD0030E20B</p> <p>O.D.: 3 9/32 (83.3)</p> <p>I.D.: 1 7/8 (47.6) One End</p> <p>Height: 10 1/32 (254.8)</p>	PT9500-MPG	<p>Maximum Performance Glass Hydraulic Element with Bail Handle</p> <p>Replaces: Hydac 950R010BNHC; Donaldson P170891; Filtrec RHR950G10B</p> <p>O.D.: 5 21/32 (143.7)</p> <p>I.D.: 3 3/4 (95.3) One End</p> <p>Height: 14 9/32 (362.7)</p>
PT9495-MPG	<p>Maximum Performance Glass Hydraulic Element</p> <p>Replaces: Donaldson P174300; Filtrec DMD0045E10B; Mann & Hummel HD976</p> <p>O.D.: 3 9/32 (83.3)</p> <p>I.D.: 1 7/8 (47.6) One End</p> <p>Height: 14 11/16 (373.1)</p>	PT9501-MPG	<p>Maximum Performance Glass Hydraulic Element</p> <p>Fits: Komatsu Excavators</p> <p>Replaces: Komatsu 2079705120; Filtrec WG239</p> <p>O.D.: 3 15/16 (100.0)</p> <p>I.D.: 1 29/32 (48.4) One End</p> <p>Height: 8 9/32 (210.3)</p> <p>O-Ring: [1] Attached</p>
PT9496-MPG	<p>Maximum Performance Glass Hydraulic Element</p> <p>Replaces: Pall HC6400FDP26H; Filtrec R426G03</p> <p>O.D.: 3 3/8 (85.7)</p> <p>I.D.: 2 (50.8) One End</p> <p>Height: 25 21/32 (651.7)</p> <p>O-Ring: [1] Attached</p>	PT9502-MPG	<p>Maximum Performance Glass Hydraulic Element with Bail Handle</p> <p>Contains: By-Pass Valve</p> <p>Fits: J.C. Bamford 520-50 Telescopic Handler</p> <p>Replaces: J.C. Bamford 32/918500; Filtrec WG326</p> <p>O.D.: 2 3/8 (60.3)</p> <p>I.D.: 1 11/32 (34.1) One End</p> <p>Height: 10 1/32 (254.8)</p> <p>O-Ring: [1] Attached</p>
PT9497-MPG	<p>Maximum Performance Glass Hydraulic Element</p> <p>Replaces: Pall HC6400FDS26H; Donaldson P569622; Fleetguard HF30325</p> <p>O.D.: 3 3/8 (85.7)</p> <p>I.D.: 2 (50.8) One End</p> <p>Height: 25 21/32 (651.7)</p> <p>O-Ring: [1] Attached</p>	PT9503-MPG	<p>Maximum Performance Glass Hydraulic Element with Bail Handle</p> <p>Fits: Terex Excavators</p> <p>Replaces: Terex 5368655680</p> <p>O.D.: 2 9/16 (65.1)</p> <p>I.D.: 1 5/16 (33.3) One End</p> <p>Height: 11 9/16 (293.7)</p> <p>O-Ring: [1] Attached</p>

Measurements Are Shown In Inches And (Millimeters)

 **WARNING:** These products can expose you to chemicals, including Diisononyl Phthalate, Carbon black extracts, Nickel, 1,3 Butadiene, Ethylene Oxide, Epichlorohydrin, which are known to the State of California to cause cancer, and Bisphenol, Ethylene Glycol, Ethylene Oxide, 1,3 Butadiene, Epichlorohydrin, which are known to the State of California to cause birth defects or other reproductive harm. For more information go to www.P65Warnings.ca.gov.

PT9504-MPG

Maximum Performance Glass Hydraulic Element



Fits: Kubota Excavators
Replaces: Kubota RG23862190
O.D.: 3 1/4 (82.6)
I.D.: 7/8 (22.2) One End
Height: 9 5/8 (244.5)
O-Ring: [1] Attached

PT9510

Hydraulic Element



Replaces: Parker 925572; Filtrec D111T40AV
O.D.: 1 25/32 (45.2)
I.D.: 1 (25.4) One End
Height: 4 7/16 (112.7)
O-Ring: [1] Attached

PT9505-MPG

Maximum Performance Glass Hydraulic Element



Fits: Case Excavators
Replaces: Case 159705A1; Filtrec WG544
O.D.: 3 7/32 (81.8)
I.D.: 1 25/32 (45.2) One End
Height: 8 (203.2)
O-Ring: [1] Attached

PT9511

Hydraulic Element



Replaces: Donaldson P173781; Filtrec D650T60A
O.D.: 3 1/2 (88.9)
I.D.: 1 5/8 (41.3) One End
Height: 9 1/4 (235.0)
O-Ring: [2] Attached

PT9506

Hydraulic Element



Replaces: Parker G01101; Filtrec D731C10A
O.D.: 3 19/32 (91.3)
I.D.: 2 1/2 (63.5) One End
Height: 12 5/8 (320.7)
O-Ring: [1] Attached

PT9512

Hydraulic Element



Replaces: Hydac 110D050WHC; Filtrec DHD110S50B
O.D.: 1 27/32 (46.8)
I.D.: 7/8 (22.2) One End
Height: 6 1/32 (153.2)
O-Ring: [1] Attached

PT9507

Hydraulic Element with Bail Handle



Contains: By-Pass Valve
Replaces: Donaldson P171557; Filtrec R151C10B
O.D.: 5 1/8 (130.2)
I.D.: 2 1/16 (52.4) One End
Height: 7 7/8 (200.0)
Spring: [1] Included

PT9513

Hydraulic Element



Replaces: Parker 909299; Filtrec R590T149
O.D.: 4 1/4 (108.0)
I.D.: 3 1/8 (79.4) One End
Height: 9 3/4 (247.7)
A. Gskt: [2] Attached
F. Gskt: [1] Included

PT9508

Hydraulic Element



Replaces: Donaldson P171310; Filtrec WP412
O.D.: 2 7/8 (73.0)
I.D.: 1 1/16 (27.0) One End
Height: 4 21/32 (118.3)
O-Ring: [1] Attached

PT9514

Hydraulic Element



Replaces: Fairey-Arlon ST360; Donaldson P171795; Filtrec R712T60
O.D.: 2 27/32 (72.2)
I.D.: 11/32 (8.7) & 1 25/32 (45.2)
Height: 5 29/32 (150.0)

PT9509

Hydraulic Element



Replaces: U.C.C. UCSE1220; Donaldson P169019; Filtrec FS142B9T125; Fleetguard HF35164
Thread: 2 1/2 -11 BSP-PL
O.D.: 5 29/32 (150.0)
Height: 8 5/16 (211.1)

PT9515

Hydraulic Element



Replaces: Parker 901755; Filtrec S440T149
O.D.: 5 31/32 (151.6)
I.D.: 3 5/8 (92.1)
Height: 9 7/8 (250.8)

Measurements Are Shown In Inches And (Millimeters)

WARNING: These products can expose you to chemicals, including Diisononyl Phthalate, Carbon black extracts, Nickel, 1,3 Butadiene, Ethylene Oxide, Epichlorohydrin, which are known to the State of California to cause cancer, and Bisphenol, Ethylene Glycol, Ethylene Oxide, 1,3 Butadiene, Epichlorohydrin, which are known to the State of California to cause birth defects or other reproductive harm. For more information go to www.P65Warnings.ca.gov.

PT9516



Wire Mesh Hydraulic Element
Fits: Massey Ferguson Tractors
Replaces: Massey Ferguson 1870199M92
O.D.: 2 1/2 (63.5)
I.D.: 7/16 (11.1) & 1 11/16 (42.9)
Height: 3 1/2 (88.9)
A. Gskt: [1] Attached
F. Gskt: [1] Included

PT9523-MPG



Maximum Performance Glass Hydraulic Element with Bail Handle
Fits: Bobcat, Terex Excavators
Replaces: Terex 5368632568
O.D.: 3 5/16 (84.1)
I.D.: 1 1/2 (38.1) One End
Height: 16 1/8 (409.6)
O-Ring: [1] Attached, [1] Included

PT9517



Wire Mesh Hydraulic Element
Replaces: Donaldson P173585; Filtrec WT1180; Wix W03AT1180
O.D.: 5 1/2 (139.7)
I.D.: 4 (101.6)
Height: 8 5/8 (219.1)
O-Ring: [2] Attached

PT9524-MPG



Maximum Performance Glass Hydraulic Element
Fits: Komatsu Excavators
Replaces: Komatsu 76754473
O.D.: 8 15/16 (227.0)
I.D.: 7 1/16 (179.4)
Height: 21 9/16 (547.7)
A. Gskt: [1] Attached

PT9518-MPG



Maximum Performance Glass Hydraulic Element
Fits: Komatsu Equipment
Replaces: Komatsu 2086071122, 2086071123
O.D.: 7 (177.8)
I.D.: 4 5/16 (109.5)
Height: 7 7/8 (200.0)

PT9525-MPG



Maximum Performance Glass Hydraulic Element
Fits: John Deere Forwarders, Wheel Harvesters
Replaces: John Deere F071978
O.D.: 3 5/8 (92.1)
I.D.: 1 13/16 (46.0) One End
Height: 10 7/8 (276.2)
O-Ring: [1] Attached

PT9519-MPG



Maximum Performance Glass Hydraulic Element
Fits: Volvo Excavators
Replaces: Volvo 14510898
O.D.: 2 7/8 (73.0)
I.D.: 1 5/16 (33.3) One End
Height: 12 1/2 (317.5)
O-Ring: [1] Attached

PT9526-MPG



Maximum Performance Glass Hydraulic Element with Bail Handle
Fits: JLG Industries Aerial Work Platforms
Replaces: JLG 7024375
O.D.: 2 5/8 (66.7)
I.D.: 1 1/4 (31.8) One End
Height: 11 5/8 (295.3)
O-Ring: [1] Attached

PT9520-MPG



Maximum Performance Glass Hydraulic Element
Fits: Case, New Holland Excavators
Replaces: Case 72111326; NewHolland 72111326
O.D.: 4 15/16 (125.4)
I.D.: 5/8 (7.9) & 3 1/4 (82.6)
Height: 22 13/16 (579.4)

PT9528



Hydraulic Element
Fits: J.C. Bamford JS290, JS330 Excavators
Replaces: J.C. Bamford JSJ0075
O.D.: 7 (177.8)
I.D.: 4 3/8 (111.1)
Height: 13 1/8 (333.4)
A. Gskt: [2] Attached

PT9522-MPG



Maximum Performance Glass Hydraulic Element with Bail Handle
Fits: J.C. Bamford 409ZX Loader, Telescopic Handlers
Replaces: J.C. Bamford 32/925341
O.D.: 2 9/16 (65.1)
I.D.: 1 5/16 (33.3) One End
Height: 9 1/8 (231.8)
O-Ring: [1] Attached

PT9529



Hydraulic Element
Fits: Komatsu Excavators
Replaces: Komatsu 21U6032210
O.D.: 3 1/4 (82.6)
I.D.: 1 5/8 (41.3)
Height: 13 1/2 (342.9)

Measurements Are Shown In Inches And (Millimeters)

! **WARNING:** These products can expose you to chemicals, including Diisononyl Phthalate, Carbon black extracts, Nickel, 1,3 Butadiene, Ethylene Oxide, Epichlorohydrin, which are known to the State of California to cause cancer, and Bisphenol, Ethylene Glycol, Ethylene Oxide, 1,3 Butadiene, Epichlorohydrin, which are known to the State of California to cause birth defects or other reproductive harm. For more information go to www.P65Warnings.ca.gov.

PT9530



Hydraulic Element with Bail Handle
Fits: Agco, Challenger, Fendt, Massey Ferguson Tractors
Replaces: Massey Ferguson F916100490010
O.D.: 3 1/4 (82.6)
I.D.: 1 3/8 (34.9) One End
Height: 15 3/8 (390.5)
O-Ring: [1] Attached

PT9537-MPG



Maximum Performance Glass Hydraulic Element
Fits: Volvo Equipment
Replaces: Volvo 14532686
O.D.: 1 21/32 (42.1)
I.D.: 27/32 (21.4) One End
Height: 3 7/16 (87.3)
O-Ring: [1] Attached

PT9531



Hydraulic Element
Contains: Threaded End
Fits: Case-IH, New Holland Tractors
Replaces: Case 192310280014; New Holland 192310280014
O.D.: 4 5/16 (109.5)
Height: 5 1/8 (130.2)

BT9553



Transmission Spin-on
Contains: Anti-Drainback Valve
 30 PSID By-Pass Valve
Fits: J.C. Bamford Equipment
Replaces: J.C. Bamford 581/18076
Thread: 1 -12
O.D.: 3 25/32 (96.0)
Height: 4 27/32 (123.0)
I.Gskt: [1] Included

PT9532



Hydraulic Element
Fits: Caterpillar Off-Highway Trucks
Replaces: Caterpillar 6E1473; Fleetguard HF35501
O.D.: 4 (101.6)
I.D.: 2 5/16 (58.7)
Height: 9 9/32 (235.7)

PT9554-MPG



Wire Supported Maximum Performance Glass Hydraulic Element
Fits: Link-Belt Hydraulic Truck Cranes
Replaces: Link-Belt D7J0149
O.D.: 5 (127.0)
I.D.: 3 1/4 (82.6)
Height: 18 5/16 (465.1)
End Seals: [2] Attached

BT9533



Hydraulic Spin-on
Fits: Agco, Challenger, Massey Ferguson Tractors
Replaces: Agco 4300400M1; Claas 6005028192; Massey Ferguson 3619712M1
Thread: M45 x 2.0
O.D.: 5 7/16 (138.1)
Height: 6 15/16 (176.2)
I.Gskt: [1] Included

PT9555



Hydraulic Element
Contains: Reinforced Centertube
Fits: Caterpillar Equipment, Off-Highway Trucks
Replaces: Caterpillar 1R0773; Donaldson P165238
O.D.: 3 15/16 (100.0)
I.D.: 2 9/32 (57.9)
Height: 9 1/4 (235.0)
A. Gskt: [2] Attached

PT9535-MPG



Maximum Performance Glass Hydraulic Element
Fits: Valmet Forestry Equipment; Valmet, Valtra Tractors
Replaces: Agco 20639610; Donaldson P763757; Valmet 31549610
O.D.: 2 15/16 (74.6)
I.D.: 1 1/4 (31.8) One End
Height: 7 3/32 (180.2)
O-Ring: [1] Attached, [1] Included

PT9556-MPG



Wire Supported Maximum Performance Glass Hydraulic Element
Fits: Caterpillar Equipment
Replaces: Caterpillar 179-9806, 179-9806X; Fleetguard HF35440
O.D.: 5 19/32 (142.1)
I.D.: 3 7/8 (98.4)
Height: 16 11/16 (423.9)
O-Ring: [2] Attached

PT9536-MPG



Maximum Performance Glass Hydraulic Element
Fits: Caterpillar Applications
Replaces: Caterpillar 3481861
O.D.: 3 1/4 (82.5)
I.D.: 1 1/4 (31.7) & 1 7/8 (47.6)
Height: 8 7/8 (225.4)
F. Gskt: [1] Included
O-Ring: [2] Attached

PT9557



Hydraulic Element
Contains: 20 PSID By-Pass Valve
Fits: Hitachi Excavators; John Deere Excavators, Loaders
Replaces: Hitachi 4448402, 4443773; Donaldson P502270; Fleetguard HF7691
O.D.: 6 1/8 (155.6)
I.D.: 4 13/16 (122.2) One End
Height: 16 31/32 (431.0)
A. Gskt: [1] Attached

Measurements Are Shown In Inches And (Millimeters)

WARNING: These products can expose you to chemicals, including Diisononyl Phthalate, Carbon black extracts, Nickel, 1,3 Butadiene, Ethylene Oxide, Epichlorohydrin, which are known to the State of California to cause cancer, and Bisphenol, Ethylene Glycol, Ethylene Oxide, 1,3 Butadiene, Epichlorohydrin, which are known to the State of California to cause birth defects or other reproductive harm. For more information go to www.P65Warnings.ca.gov.

BT9558-MPG Maximum Performance Glass Hydraulic Spin-on
Contains: Integral Post Seal
Replaces: Quincy 142136
Thread: 1 1/4 -11 BSP-PL
O.D.: 4 21/32 (118.3)
Height: 8 3/32 (205.6)
I.Gskt: G498-A



PT9559-MPG Wire Mesh Supported Maximum Performance Glass Hydraulic Element
Notes: Inside-Out Flow Direction
Fits: Euclid, Hitachi Dump Trucks
Replaces: Euclid 4099538, E4099538; Hitachi E4099538; Donaldson P560404; Fleetguard HF30357
O.D.: 3 5/32 (80.2)
I.D.: 1 9/16 (39.7) One End
Height: 12 15/16 (328.6)
O-Ring: [1] Attached



BT9560-MPG Maximum Performance Glass Hydraulic Spin-on
Fits: Caterpillar Equipment
Replaces: Caterpillar 207-5035; Donaldson P179763
Thread: 1 3/4 -12
O.D.: 4 23/32 (119.9)
Height: 14 3/32 (358.0)
I.Gskt: [1] Included
Related To: BT8870--MPG (Micron Difference)



BT9561 Hydraulic Spin-on
Contains: Anti-Drainback Valve
 22 PSID By-Pass Valve
Fits: J.C. Bamford Lift Trucks, Loaders
Replaces: J.C. Bamford 581/18063
Thread: 1 -12
O.D.: 3 13/16 (96.8)
Height: 3 13/16 (96.8)
I.Gskt: [1] Included



P9600 Lube Element
Fits: Chrysler, Dodge, Ram Automotive, Jeep
Replaces: Chrysler 68191349AA
O.D.: 1 31/32 (50.0)
I.D.: 7/8 (22.2)
Height: 6 5/32 (156.4)
O-Ring: [1] Attached, [1] Included



B9601 Lube Spin-on
Contains: 36 PSID By-Pass Valve
Fits: Atlas, Deutz-Fahr, Ditch Witch, Mecalac, Voegle Equipment; Deutz Engines; Putzmeister Pumps
Replaces: Claas 13022760; Deutz 1182552, 1183574, 1183575; Voegle 4912911424; Volvo 21640514
Thread: 1 -12
O.D.: 3 23/32 (94.5)
Height: 8 9/32 (210.3)
I.Gskt: [1] Included



P9602 Lube Element
Fits: Honda ATVs
Replaces: Honda 15412KEA003
O.D.: 2 11/16 (68.3)
I.D.: 13/16 (20.6)
Height: 1 27/32 (46.8)
O-Ring: [2] Included
Grommets: [2] Attached



P9603 Lube Element
Contains: 25 PSID By-Pass Valve
Fits: Honda TRX450ER, TRX450R ATVs
Replaces: Honda 15412-MEB-671, 15412-MEN-671
O.D.: 1 9/16 (39.7)
I.D.: 15/32 (11.9) One End
Height: 1 7/16 (36.5)
O-Ring: [1] Included
Grommets: [1] Attached



B9604 Lube Spin-on
Fits: Ariel Compressors
Replaces: Ariel A661, A-0661; Donaldson P554004
Thread: 1 1/8 -16
O.D.: 4 1/4 (108.0)
Height: 10 15/32 (265.9)
I.Gskt: [1] Included



P9605 Lube Element
Fits: Dodge Dart, Jeep Renegade; Fiat 500
Replaces: Chrysler 68102241AA; Fiat 73500049; Ford 1565248; General Motors 93177787; Suzuki 1651185C00, 1651185E00
O.D.: 2 9/16 (65.1)
I.D.: 31/32 (24.6)
Height: 3 9/32 (83.3)
O-Ring: [1] Included



B9606 Full-Flow Lube Spin-on
Fits: Volvo-Penta Engines
Replaces: Volvo 21632664
Thread: 1 1/8 -16 UN-2B
O.D.: 4 1/2 (114.3)
Height: 7 5/16 (185.7)
I.Gskt: [1] Included



B9607 By-Pass Lube Spin-on
Fits: Volvo-Penta Engines
Replaces: Volvo 21632667
Thread: 1 3/8 -16 UN-2B
O.D.: 4 11/32 (110.3)
Height: 7 5/16 (185.7)
I.Gskt: [1] Included



Measurements Are Shown In Inches And (Millimeters)

 **WARNING:** These products can expose you to chemicals, including Diisononyl Phthalate, Carbon black extracts, Nickel, 1,3 Butadiene, Ethylene Oxide, Epichlorohydrin, which are known to the State of California to cause cancer, and Bisphenol, Ethylene Glycol, Ethylene Oxide, 1,3 Butadiene, Epichlorohydrin, which are known to the State of California to cause birth defects or other reproductive harm. For more information go to www.P65Warnings.ca.gov.

BF9800

Fuel Spin-on



Contains: Integral Post Seal
Fits: M.T.U. 12V4000, 16V4000, 20V4000 Diesel Engines
Replaces: M.T.U. 20922801, X00012879
Thread: M32 x 1.5
O.D.: 4 1/4 (108.0)
Height: 10 15/32 (265.9)
I.Gskt: [1] Included

PF9801

Fuel Element



Fits: Nissan, Opel, Renault Trucks
Replaces: Nissan 16405-00QAB; Opel 4411637; Renault 7701207667
O.D.: 2 25/32 (70.6)
I.D.: 25/32 (19.8)
Height: 4 23/32 (119.9)
O-Ring: [2] Included

BF9802

Fuel Spin-on



Fits: Equipment with M.T.U. 8V2000 M92, 8V2000 M93, 10V2000 M92, 10V2000 M93 (2004-on), 10V2000 M72 (2005-on), 16V4000R41 (2002-on), 20V4000 Engines with Common Rail Injection Systems
Replaces: M.T.U. X00042421; Mann & Humel WDK11102/10
Thread: M32 x 1.5
O.D.: 4 1/4 (108.0)
Height: 10 15/32 (265.9)
I.Gskt: [1] Included

PF9803

Fuel Element



Fits: Mitsubishi BE64D Bus, FE120, FE125, FD140, FG140, FD145, FD180 Trucks; Sterling 360 Truck all with Mitsubishi 4M50 Engine
Replaces: Mitsubishi ME222133, ME222135; Nissan 16403-WK900
O.D.: 3 23/32 (94.5)
I.D.: 1 1/32 (26.2) One End
Height: 3 11/16 (93.7)
F. Gskt: [1] Included
O-Ring: [1] Included
Grommets: [1] Attached
Related To: PF7982, PF7983, PF7984 (Long Versions)

PF9804

Fuel/Water Separator Element



Fits: Freightliner Cascadia, Columbia, Business Class M2 all with Detroit Diesel DD13, DD15 Engines
Replaces: Alliance ABP/N10G-FS19915; Detroit Diesel FS19915WE, A0000903651, A4720921205
O.D.: 5 27/32 (148.4)
I.D.: 1 1/32 (26.2) One End
Height: 7 19/32 (192.9)
O-Ring: [2] Included
Grommets: [1] Attached

BF9805

In-Line Fuel Filter



Contains: 1/4 Inch Vapor Line
Fits: Audi, Volkswagen Automotive, Light-Duty Trucks
Replaces: Volkswagen 6Q0201051C
O.D.: 2 13/32 (61.1)
Inlet: 1/4
Outlet: 1/4
Length: 6 15/32 (164.3)

BF9807

In-Line Fuel Filter



Fits: John Deere Tractors
Replaces: John Deere AL153517
O.D.: 2 1/8 (54.0)
Inlet: 3/16
Outlet: 3/16
Length: 4 5/8 (117.5)

BF9808-D

Secondary Fuel Element with Drain



Fits: John Deere Forwarders, Tractors
Replaces: John Deere RE526557; Stanadyne 37013; Fleetguard FS19978
O.D.: 3 3/16 (81.0)
I.D.: 1/2 (12.7) One End
Height: 6 1/16 (154.0)
Grommets: [1] Attached

BF9809-D

Secondary Fuel Element with Drain



Notes: Reverse Flow
Fits: 7/2006-on Ford Transit
Replaces: Ford 1370779, 6C11-9176-AA; Stanadyne 38034, 38640
O.D.: 3 3/16 (81.0)
I.D.: 13/16 (20.6) One End
Height: 7 25/32 (197.6)
Grommets: [1] Attached

BF9810-D

Secondary Fuel Element with Drain



Notes: Reverse Flow
Fits: 11/2004-on Ford Transit 2.0 DI TDE, 3/2004-on Transit 2.4 TDE Van
Replaces: Ford 4537952, 4669224, 3C11-9176-BB; Motorcraft EFC335; Stanadyne 36621, 36994
O.D.: 3 3/16 (81.0)
I.D.: 13/16 (20.6) One End
Height: 7 25/32 (197.6)
Grommets: [1] Attached

BF9811-SP

Fuel/Water Separator Spin-on with Drain and Sensor Port



Notes: CAUTION: Furnished O-Ring must be installed on post for seal.
Contains: Sensor Port Thread: 9/16-18 Standpipe
Fits: Caterpillar Equipment
Replaces: Caterpillar 326-1642
Thread: 1 -14
O.D.: 4 1/4 (108.0)
Height: 7 15/32 (189.7)
I.Gskt: [1] Included
O-Ring: [1] Included

BF9812

Fuel Spin-on with Drain



Contains: Integral Post Seal
Replaces: CLARCOR Filtration (China) CX180, S1117040; Sinotruk VG1408739A
Thread: M16 x 1.5
O.D.: 3 5/32 (80.2)
Height: 7 5/16 (185.7)
I.Gskt: [1] Included

Measurements Are Shown In Inches And (Millimeters)

WARNING: These products can expose you to chemicals, including Diisononyl Phthalate, Carbon black extracts, Nickel, 1,3 Butadiene, Ethylene Oxide, Epichlorohydrin, which are known to the State of California to cause cancer, and Bisphenol, Ethylene Glycol, Ethylene Oxide, 1,3 Butadiene, Epichlorohydrin, which are known to the State of California to cause birth defects or other reproductive harm. For more information go to www.P65Warnings.ca.gov.

BF9813

Fuel Spin-on with Drain



Contains: Integral Post Seal
Replaces: CLARCOR Filtration (China)
 CX180A; Sinotruk VG1408740A
Thread: M16 x 1.5
O.D.: 3 9/32 (83.3)
Height: 7 15/32 (189.7)

BF9819

Fuel Spin-on



Replaces: CLARCOR Filtration (China)
 WBF7608; FAW-Xichai 1117010B010000W
Thread: M16 x 1.5
O.D.: 3 1/32 (77.0)
Height: 4 11/32 (110.3)
I.Gskt: [1] Included

PF9814

Fuel/Water Separator Element



Contains: Burp Valve
Fits: Freightliner, IHC, Kenworth, Peterbilt
 Trucks
Replaces: Fleetguard FS19764; Davco 102527
O.D.: 4 3/16 (106.4)
I.D.: 2 1/32 (16.7) One End
Height: 7 1/32 (178.6)
O-Ring: [2] Included

BF9820

Fuel Spin-on



Replaces: CLARCOR Filtration (China)
 WBF7886
Thread: M18 x 1.5
O.D.: 3 11/16 (93.7)
Height: 5 25/32 (146.8)
I.Gskt: [1] Included

BF9815

Fuel Spin-on



Replaces: CLARCOR Filtration (China)
 CX0815; Weichai Power 612600081334
Thread: M20 x 1.5
O.D.: 3 19/32 (91.3)
Height: 7 1/8 (181.0)
I.Gskt: [1] Included

BF9821

Fuel Spin-on with Drain



Replaces: CLARCOR Filtration (China)
 CX0710B4
Thread: M20 x 1.5
O.D.: 3 1/32 (77.0)
Height: 6 1/16 (154.0)
I.Gskt: [1] Included

BF9816

Fuel Spin-on



Contains: Integral Post Seal
Replaces: CLARCOR Filtration (China)
 CX1012; DCD 4102H1510
Thread: 1 -14
O.D.: 4 1/4 (108.0)
Height: 5 11/16 (144.5)
I.Gskt: [1] Included

BF9822-D

Fuel/Water Coalescer Element with Removable Drain



Notes: Reverse Flow
Fits: J.C. Bamford Generators, Super Loaders
Replaces: J.C. Bamford 32/925975;
 Stanadyne 38695
O.D.: 3 7/32 (81.8)
I.D.: 1/2 (12.7) One End
Height: 5 9/32 (134.1)
Grommets: [1] Attached

BF9817

Fuel Spin-on



Replaces: CLARCOR Filtration (China)
 WBF220; Weichai Power 612630080087
Thread: M32 x 1.5
O.D.: 4 9/32 (108.7)
Height: 10 11/32 (262.7)
I.Gskt: [1] Included

PF9823

Fuel Element with Bail Handle



Replaces: CLARCOR Filtration (China) C0607;
 Weichai Power 13022685
O.D.: 2 17/32 (64.3)
I.D.: 1/2 (12.7)
Height: 3 (76.2)

BF9818

Fuel Spin-on with Drain



Replaces: CLARCOR Filtration (China)
 WBF1260A, WFB1260A
Thread: 1 -14
O.D.: 4 9/32 (108.7)
Height: 10 25/32 (273.8)
I.Gskt: [1] Included

PF9824

Fuel Element with Bail Handle



Replaces: CLARCOR Filtration (China)
 C0913S; Sinotruk 614080295A
O.D.: 3 17/32 (89.7)
I.D.: 17/32 (13.5)
Height: 5 7/16 (138.1)
Grommets: [2] Attached

Measurements Are Shown In Inches And (Millimeters)



WARNING: These products can expose you to chemicals, including Diisononyl Phthalate, Carbon black extracts, Nickel, 1,3 Butadiene, Ethylene Oxide, Epichlorohydrin, which are known to the State of California to cause cancer, and Bisphenol, Ethylene Glycol, Ethylene Oxide, 1,3 Butadiene, Epichlorohydrin, which are known to the State of California to cause birth defects or other reproductive harm. For more information go to www.P65Warnings.ca.gov.

PF9825



Fuel Element

Replaces: CLARCOR Filtration (China) 61021520; DCD 61021520
O.D.: 2 29/32 (73.8)
I.D.: 5/8 (15.9)
Height: 4 3/16 (106.4)

BF9830-D



Fuel/Water Coalescer with Drain

Fits: J.C. Bamford Generators, Lift Trucks, Loaders all with Dieselmex (Tier2) 444 Engine
Replaces: J.C. Bamford 32/925705; Donaldson P551426
O.D.: 3 7/32 (81.8)
I.D.: 7/8 (22.2) One End
Height: 5 9/32 (134.1)
Grommets: [1] Attached

PF9826



Fuel Element

Replaces: CLARCOR Filtration (China) 12V1030A; Jicai 12VB1030A
O.D.: 4 3/8 (111.1)
I.D.: 31/32 (24.6)
Height: 7 1/8 (181.0)
Grommets: [2] Attached

BF9831



Fuel/Water Separator Spin-on with Drain

Contains: Integral Post Seal
Replaces: CLARCOR Filtration (China) WBF1212; Foton Lovol 1106339100104; Weifang Hualing Diesel Power 1125AD-5705
Thread: 1 -14
O.D.: 3 19/32 (91.3)
Height: 7 7/8 (200.0)
I.Gskt: [1] Included

BF9827-D



Secondary Fuel/Water Separator Element with Drain

Notes: Reverse Flow
Fits: Ford Transit Vans
Replaces: Ford 3C11-9176-AA; 4537951; Stanadyne 36620, 36995
O.D.: 3 7/32 (81.8)
I.D.: 7/8 (22.2) One End
Height: 6 13/16 (173.0)
Grommets: [1] Attached

BF9832



Fuel Spin-on

Contains: Integral Post Seal
Replaces: CLARCOR Filtration (China) CX1014B; Faw-Xichai 1117101-A34-0000W
Thread: 1 -14
O.D.: 4 9/32 (108.7)
Height: 7 3/32 (180.2)
I.Gskt: [1] Included

BF9828-D



Primary Fuel/Water Separator Element with Removable Drain

Notes: Reverse Flow
Fits: JCB Loaders
Replaces: J.C. Bamford 32/925915; Stanadyne 38461
O.D.: 3 7/32 (81.8)
I.D.: 1/2 (12.7) One End
Height: 5 9/32 (134.1)
Grommets: [1] Attached

BF9833-D



Primary Fuel Element with Drain

Fits: J.C. Bamford Excavators
Replaces: J.C. Bamford 32/925760; Stanadyne 37932
O.D.: 3 7/32 (81.8)
I.D.: 7/8 (22.2) One End
Height: 6 1/16 (154.0)
Grommets: [1] Attached

PF9829 KIT



Set of 2 Fuel Elements

Contains: Primary and Secondary Elements - not sold separately
Fits: 10/07-on Scania P230, P280, P320, P360, P400, R400, R440, R480 Trucks all with Scania DC9, DC13 Series Engine
Replaces: Scania 1736248, 1736250, 1794863
Primary
O.D.: 3 5/16 (84.9)
I.D.: 1 1/2 (38.1)
Height: 8 15/16 (227.0)
O-Ring: [2] Included
Secondary
O.D.: 3 3/4 (95.3)
I.D.: 1 13/16 (46.0)
Height: 8 5/32 (207.2)

BF9834



Fuel Spin-on

Fits: E.M.D. Marine Engines
Replaces: Clark Filters FJ-33S; E.M.D. 40052587
Thread: 1 1/4 -12
O.D.: 3 11/16 (93.7)
Height: 8 23/32 (221.5)
I.Gskt: G381-A

Measurements Are Shown In Inches And (Millimeters)

WARNING: These products can expose you to chemicals, including Diisononyl Phthalate, Carbon black extracts, Nickel, 1,3 Butadiene, Ethylene Oxide, Epichlorohydrin, which are known to the State of California to cause cancer, and Bisphenol, Ethylene Glycol, Ethylene Oxide, 1,3 Butadiene, Epichlorohydrin, which are known to the State of California to cause birth defects or other reproductive harm. For more information go to www.P65Warnings.ca.gov.

BF9835-D



Secondary Fuel Element with Drain
Fits: Magnum Light Towers
Replaces: Magnum Products 17647
O.D.: 3 3/16 (81.0)
I.D.: 5/8 (15.9) One End
Height: 5 9/32 (134.1)

BF9841



Fuel Spin-on
Replaces: CLARCOR Filtration (China) CX0710A; Faw-Xichai K1117001A; Weichai Power K1117001A
Thread: M16 x 1.5
O.D.: 3 1/32 (77.0)
Height: 4 13/16 (122.2)
I.Gskt: [1] Included

BF9836-D



Secondary Fuel Element with Drain
Fits: J.C. Bamford Excavators
Replaces: J.C. Bamford 32/925666; Mitsubishi D07-0015; Stanadyne 37130
O.D.: 3 7/32 (81.8)
I.D.: 1/2 (12.7) One End
Height: 4 17/32 (115.1)
Grommets: [1] Attached

BF9842



Fuel Spin-on with Drain
Fits: Foton Trucks
Replaces: Foton Lovol 1106611400005, T64101003; CLARCOR Filtration (China) WBF1235
Thread: M16 x 1.5
O.D.: 3 1/16 (77.8)
Height: 5 25/32 (146.8)
I.Gskt: [1] Included

BF9837-D



Primary Fuel Element with Drain
Notes: Reverse Flow
Fits: Agco, Challenger, Massey Ferguson, Valtra Tractors all with Sisu 4.4L, 6.6L, 7.4L, 8.4L Diesel Engines
Replaces: Agco V836862600; Case 162000080882; Sisu 836862600; Valtra 20366575
O.D.: 3 9/32 (83.3)
I.D.: 21/32 (16.7) One End
Height: 6 25/32 (172.2)
Grommets: [1] Attached

BF9843



Fuel Spin-on
Replaces: CLARCOR Filtration (China) CX0810; Foton Lovol 1103911500001
Thread: 3/4 -16
O.D.: 3 19/32 (91.3)
Height: 5 1/8 (130.2)
I.Gskt: [1] Included

PF9838



Fuel Element with Bail Handle
Replaces: Sinotruk WG9725550002001; CLARCOR Filtration (China) 500FG-1000
O.D.: 3 5/32 (80.2)
I.D.: 21/32 (16.7)
Height: 2 25/32 (70.6)
Grommets: [2] Attached

BF9844



Fuel Spin-on
Replaces: Yuchai Watyuan G58001105140C
Thread: 1 -14
O.D.: 4 9/32 (108.7)
Height: 8 1/32 (204.0)
I.Gskt: [1] Included

BF9839-D



Primary Fuel Element with Drain
Notes: Reverse Flow
Fits: Agco, Challenger, Massey Ferguson, Valtra Equipment all with Sisu 6.6L, 7.4L, 8.4L Engines
Replaces: Agco V836867591; Sisu 836867591
O.D.: 3 3/16 (81.0)
I.D.: 3/4 (19.1) One End
Height: 6 23/32 (170.7)
Grommets: [1] Attached

PF9845



Fuel Element
Replaces: Foton Lovol F500840, G20D5223; CLARCOR Filtration (China) C0810C-10110
O.D.: 3 11/32 (84.9)
I.D.: 1 9/16 (39.7)
Height: 3 15/16 (100.0)

BF9840



Fuel Spin-on with Drain
Replaces: Foton Lovol T750010021, T750010022; CLARCOR Filtration (China) CX0710B3
Thread: M16 x 1.5
O.D.: 3 1/16 (77.8)
Height: 6 1/16 (154.0)
I.Gskt: [1] Included

BF9846



In-Line Fuel Filter
Fits: Mercedes-Benz Automotive, Engines, Vans
Replaces: Chrysler 5174056AA; Mercedes-Benz 6460920001, 6460920301, 6460920501
O.D.: 3 5/8 (92.1)
Inlet: 7/16
Outlet: 3/8
Length: 4 29/32 (124.6)

Measurements Are Shown In Inches And (Millimeters)

WARNING: These products can expose you to chemicals, including Diisononyl Phthalate, Carbon black extracts, Nickel, 1,3 Butadiene, Ethylene Oxide, Epichlorohydrin, which are known to the State of California to cause cancer, and Bisphenol, Ethylene Glycol, Ethylene Oxide, 1,3 Butadiene, Epichlorohydrin, which are known to the State of California to cause birth defects or other reproductive harm. For more information go to www.P65Warnings.ca.gov.

BF9847-D Secondary Fuel Element with Drain
Fits: John Deere Equipment
Replaces: John Deere RE533026; Donaldson P551432
O.D.: 3 3/16 (81.0)
I.D.: 1/2 (12.7) One End
Height: 6 1/16 (154.0)
Grommets: [1] Attached



BF9853 Fuel Spin-on with Drain
Replaces: FAW-Xichai WBF1235B; CLARCOR Filtration (China) WBF1235B
Thread: M16 x 1.5
O.D.: 3 1/32 (77.0)
Height: 5 11/32 (135.7)
I.Gskt: [1] Included



BF9848 In-Line Fuel Filter
Contains: 3/8 Inch Return Line
Fits: 2005-07 Chevrolet Cobalt; 2005-06 Pontiac Pursuit, 2010 G5; 2003-07 Saturn ION, 2004-07 ION Red Line
Replaces: Saturn 22734980; ACDelco GF824
O.D.: 2 5/32 (54.8)
Inlet: 5/16
Outlet: 5/16
Length: 4 29/32 (124.6)



BF9854 Fuel Spin-on with Drain
Replaces: Foton Lovol 1307211500006, DG2001464, F582011150003; CLARCOR Filtration (China) FT0810
Thread: 1 -14
O.D.: 3 19/32 (91.3)
Height: 6 23/32 (170.7)
I.Gskt: [1] Included



BF9849 Fuel/Water Separator Spin-on with Drain
Replaces: Foton Lovol 1104339100138, 1106911500012; CLARCOR Filtration (China) FT7535A
Thread: 3/4 -16
O.D.: 3 19/32 (91.3)
Height: 6 3/4 (171.5)
I.Gskt: [1] Included



BF9857 In-Line Fuel Filter
Contains: [2] Plastic Clips
Fits: John Deere Lawn and Garden Tractors, Utility Vehicles
Replaces: John Deere AM117584, AM118131
O.D.: 3 5/16 (84.1)
Inlet: 3/8
Outlet: 3/8
Length: 6 15/16 (176.2)



BF9850 Fuel Spin-on
Contains: Port for Drain/Sensor Bowl
 Port Thread: M36 x 1.5
Replaces: Weichai Power CX0812; CLARCOR Filtration (China) CX0812
Thread: M20 x 1.5
O.D.: 3 9/16 (90.5)
Height: 7 (177.8)
I.Gskt: [1] Included



BF9858 KIT Set of 2 Fuel Filters
Contains: Port Thread: 3 3/4-10
 [1] BF1390-O Spin-on with Open Port for Bowl
 [1] Element
 Not Sold Individually
Fits: IHC MaxxFace DT, MaxxFace 7 Engines, CD, RXT, 3200, 4300 DuraStar Trucks
Replaces: International 1848671-C1, 1876533-C93, 1877516-C1
BF1390-O
Thread: 1 -14
O.D.: 4 11/32 (110.3)
Height: 6 3/16 (157.2)
I.Gskt: [1] Included
O-Ring: [1] Included
Element:
O.D. 3 9/16
I.D. 17/32
Height 4 25/32
O-Ring [1] Included



BF9851 In-Line Fuel Filter
Contains: [2] 3/8 Inch Plastic Clips
 [1] 5/16 Inch Plastic Clip
 5/16 Inch Return Line
Fits: 1998-2001 Saturn SW1, SW2, 1998-2002 SC1, SL1, SC2, SL2, 2000-02 SL
Replaces: Saturn 21009427
O.D.: 2 11/32 (59.5)
Inlet: 3/8
Outlet: 3/8
Length: 8 15/32 (215.1)



BF9860 Fuel Spin-on
Notes: Fill Plug pre-installed in filter. Remove plug after pre-filling filter with fuel prior to installation on application.
Fits: Peterbilt 386 Truck; Cummins QSX15 Engine
Replaces: Cummins 3685306; Fleetguard FF5686
Thread: M90 x 2.0
O.D.: 4 23/32 (119.9)
Height: 11 9/16 (293.7)
I.Gskt: [1] Included
Related To: BF9885 (Short Version)



BF9852 Fuel Spin-on with Drain
Replaces: Weichai Power 612600080934; CLARCOR Filtration (China) WBF1352
Thread: M20 x 1.5
O.D.: 3 19/32 (91.3)
Height: 7 7/8 (200.0)
I.Gskt: [1] Included



Measurements Are Shown In Inches And (Millimeters)

WARNING: These products can expose you to chemicals, including Diisononyl Phthalate, Carbon black extracts, Nickel, 1,3 Butadiene, Ethylene Oxide, Epichlorohydrin, which are known to the State of California to cause cancer, and Bisphenol, Ethylene Glycol, Ethylene Oxide, 1,3 Butadiene, Epichlorohydrin, which are known to the State of California to cause birth defects or other reproductive harm. For more information go to www.P65Warnings.ca.gov.

PF9861

Fuel Element



Fits: Volkswagen Beetle, Golf, Jetta
Replaces: Volkswagen 1K0127434B
O.D.: 3 9/32 (83.3)
I.D.: 3/4 (19.4) One End
Height: 4 9/16 (115.9)
O-Ring: [1] Included
Grommets: [1] Attached

PF9862

Fuel/Water Separator Element



Fits: New Holland E70, E70SR, E80 Excavators
Replaces: Komatsu YM02P01039R100;
 New Holland YM02P01039R100,
 YM02P01039S002
O.D.: 1 7/8 (47.6)
 Flange 2 9/16 (65.1)
I.D.: 13/16 (20.6) One End
Height: 2 19/32 (65.9)
O-Ring: [1] Included
Grommets: [1] Attached

BF9863

In-Line Fuel Filter



Fits: Volvo Excavators
Replaces: Volvo 7410170
O.D.: 3 7/16 (87.3)
Inlet: 1/8
Outlet: 3/16
Length: 3 19/32 (91.3)

BF9864

Fuel Spin-on



Contains: Integral Post Seal
Replaces: Jinan Diesel B30121010;
 CLARCOR Filtration (China) BF596A
Thread: 1 1/2 -12
O.D.: 4 21/32 (118.3)
Height: 11 5/16 (287.3)
I.Gskt: [1] Included

PF9865

Fuel Element



Fits: Iveco Trucks
Replaces: Iveco 504170771
O.D.: 3 3/16 (81.0)
I.D.: 1/2 (12.7) One End
Height: 5 27/32 (148.4)
O-Ring: [1] Included

BF9866-O

Fuel/Water Separator Spin-on with Open Port for Bowl



Contains: Port Thread: M95 x 2.5
 Integral Post Seal
Fits: John Deere Equipment
Replaces: John Deere RE532952, RE539465
Thread: 7/8 -14
O.D.: 4 3/8 (111.1)
Height: 8 11/16 (220.7)
I.Gskt: [1] Included
F. Gskt: [1] Included

BF9867-O

Fuel Spin-on with Open Port for Bowl



Contains: Port Thread: M95 x 2.5
 Integral Post Seal
Fits: Evobus Citaro Buses; Mercedes-Benz,
 Renault Trucks; Bomag Paving Equipment
Replaces: Bomag 05825015; Renault
 7420754418; Racor R160TDMAX
Thread: 1 -14
O.D.: 4 13/32 (111.9)
Height: 8 21/32 (219.9)
I.Gskt: [1] Included
F. Gskt: [1] Included

PF9868

Fuel Element



Fits: Case, Link-Belt Excavators
Replaces: New Holland KHH12030
O.D.: 3 23/32 (94.5)
I.D.: 1 1/32 (26.2) One End
Height: 6 13/32 (162.7)
O-Ring: [2] Included
Grommets: [1] Attached
Related To: PF7983 (Without Furnished
 O-Rings)

BF9869

Fuel Spin-on with Drain



Replaces: Yuchai Watyuan 1501105020A;
 Donaldson P502484
Thread: 1 -14
O.D.: 4 9/32 (108.7)
Height: 7 1/8 (181.0)
I.Gskt: [1] Included

PF9870

Fuel Element



Fits: Dodge Pickups, 4500, 5500 Chassis
 Cabs; Ram Pickups, 4500HD, 5500HD Chassis
 Cabs all with 6-408 (6.7L) FI Turbo Diesel
 Engine
Replaces: Chrysler 68065608AA;
 Cummins 4947561; Mopar MO608
O.D.: 4 7/32 (107.2)
I.D.: 1 9/16 (39.7) One End
Height: 5 17/32 (140.5)
O-Ring: [1] Included

BF9871-O

Fuel/Water Separator Spin-on with Open Port for Bowl



Contains: Port Thread: 3 3/4-10 2B Buttress
 Integral Post Seal
Fits: Freightliner, Sterling, Western Star
 Trucks
Replaces: Alliance ABPN122BR90FRT10;
 Freightliner BR90FRT10, RAIBR90FRT10;
 Donaldson P551066
Thread: 1 -14
O.D.: 4 5/16 (109.5)
Height: 6 5/16 (160.3)
I.Gskt: [1] Included
F. Gskt: [1] Included

Measurements Are Shown In Inches And (Millimeters)



WARNING: These products can expose you to chemicals, including Diisononyl Phthalate, Carbon black extracts, Nickel, 1,3 Butadiene, Ethylene Oxide, Epichlorohydrin, which are known to the State of California to cause cancer, and Bisphenol, Ethylene Glycol, Ethylene Oxide, 1,3 Butadiene, Epichlorohydrin, which are known to the State of California to cause birth defects or other reproductive harm. For more information go to www.P65Warnings.ca.gov.

PF9872 Fuel Element
Fits: Volkswagen Jetta, Beetle, Golf
Replaces: Volkswagen 1K0127434A
O.D.: 3 1/4 (82.6)
I.D.: 1 1/2 (38.1)
Height: 5 19/32 (142.1)
F. Gskt: [2] Included, [1] Aluminum Washer
O-Ring: [2] Attached



BF9877 Fuel Spin-on
Fits: J.C. Bamford Excavators with Isuzu 4GB1T, 6BG1T or J.C. Bamford Dieselmax 444 Engines
Replaces: J.C. Bamford 32925856
Thread: 3/4 -16
O.D.: 3 11/16 (93.7)
Height: 4 11/32 (110.3)
I.Gskt: G381-A



PF9873 Fuel Strainer
Fits: Doosan, Hitachi, John Deere, Kobelco, New Holland Excavators
Replaces: Hitachi 8972133810; John Deere 8972133810
O.D.: 1 7/16 (36.5)
I.D.: 15/32 (11.9) One End
Height: 1 15/16 (49.2)
O-Ring: [1] Attached, [1] Included



BF9878 Fuel Spin-on with Drain
Fits: DongFeng Trucks
Replaces: DongFeng-Cummins 1025BF11020; CLARCOR Filtration (China) WPPA01101
Thread: M20 x 1.5
O.D.: 3 5/8 (92.1)
Height: 6 11/16 (169.9)
I.Gskt: [1] Included
F. Gskt: [1] Included



BF9874-DM Primary Fuel/Water Separator Element
Contains: Drain Nut
Fits: John Deere Power Tech 4045DFM, 4045TFM Marine Engines
Replaces: John Deere RE521248; Stanadyne 36559
O.D.: 3 5/32 (80.2)
I.D.: 15/16 (23.8) One End
Height: 5 5/16 (134.9)
F. Gskt: [1] Included
Grommets: [1] Attached



PF9879 Fuel Element
Fits: M.A.N. D28V V8-750, V10-900, V12-1100 Engines
Replaces: M.A.N. 51125030069; Hengst E420KPD72
O.D.: 3 9/32 (83.3)
I.D.: 1/2 (12.7) One End
Height: 10 15/32 (265.9)
O-Ring: [1] Included

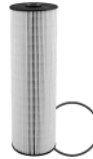

BF9875-DM Secondary Fuel/Water Separator Element
Contains: Drain Nut
Fits: John Deere Power Tech 4045DFM, 4045TFM Marine Engines
Replaces: John Deere RE520842; Stanadyne 36503
O.D.: 3 5/32 (80.2)
I.D.: 15/16 (23.8) One End
Height: 5 5/16 (134.9)
F. Gskt: [1] Included
Grommets: [1] Attached



BF9880 Fuel Spin-on with Open Port
Contains: Port Thread: M36 x 1.5
Fits: Yuchai Diesel YC6G240-30 Truck Engine
Replaces: Yuchai Watyuan G58001105240C
Thread: 1 -14
O.D.: 4 11/32 (110.3)
Height: 9 11/16 (246.1)
I.Gskt: [1] Included
F. Gskt: [1] Included



BF9876 Fuel Spin-on with Drain
Replaces: Yuchai Watyuan A30001105020
Thread: 1 -14
O.D.: 3 1/4 (82.6)
Height: 6 21/32 (169.1)
I.Gskt: [1] Included



BF9881 In-Line Fuel Filter with Drain
Fits: J.C. Bamford Engines, Rollers, Telescopic Handlers
Replaces: J.C. Bamford 32007138
O.D.: 3 3/8 (85.7)
Inlet: 3/8
Outlet: 3/8
Length: 7 5/32 (181.8)



Measurements Are Shown In Inches And (Millimeters)

WARNING: These products can expose you to chemicals, including Diisononyl Phthalate, Carbon black extracts, Nickel, 1,3 Butadiene, Ethylene Oxide, Epichlorohydrin, which are known to the State of California to cause cancer, and Bisphenol, Ethylene Glycol, Ethylene Oxide, 1,3 Butadiene, Epichlorohydrin, which are known to the State of California to cause birth defects or other reproductive harm. For more information go to www.P65Warnings.ca.gov.

BF9882



Fuel/Water Separator Spin-on with Open Port
Notes: Fender removal recommended for proper installation.
Contains: Port Thread: M36 x 1.5
Fits: Chevrolet, GMC Light-Duty Trucks, Trucks with 6.6L Turbo Diesel Engine
Replaces: General Motors 12633243, 12646512, 19255090; ACDelco TP3012
Thread: 3 3/8 -8 UN Buttress
O.D.: 4 1/32 (102.4)
Height: 6 1/2 (165.1)
O-Ring: [2] Included
Grommets: [1] Attached
Related To: BF46062 (Upgrade)

BF9883



Fuel Spin-on with Drain
Contains: Integral Post Seal
Fits: Case-IHC Farmall 65A, 65C, 75C, Workmaster 65 Tractors
Replaces: Iveco 504287000
Thread: M16 x 1.5
O.D.: 3 9/32 (83.3)
Height: 7 15/32 (189.7)
I.Gskt: [1] Included

BF9884



Nylon In-Line Fuel Filter in Plastic Housing
Fits: John Deere Tractors
Replaces: John Deere AL67975; Mann & Hummel WK3111
O.D.: 1 17/32 (38.9)
Inlet: 5/16
Outlet: 5/16
Length: 4 9/32 (108.7)

BF9885



Fuel Spin-on
Notes: Fill Plug pre-installed in filter. Remove after pre-filling filter with fuel prior to installation on application. CAUTION: Not to be used on X15 Engines.
Fits: Kenworth, Peterbilt Trucks with Cummins ISX11.9, QSX11.9 Engines
Replaces: Cummins 2864993, 2893612; Donaldson P555776; Fleetguard FF5776; Mann WK12003
Thread: M90 x 2.0
O.D.: 4 23/32 (119.9)
Height: 8 27/32 (224.6)
I.Gskt: [1] Included
Related To: BF9860 (Long Version) BF46129 (Upgrade Version)

BF9886



In-Line Fuel Filter
Fits: John Deere Loaders, Tractors
Replaces: John Deere RE176732
O.D.: 1 29/32 (48.4)
Inlet: 9/16-18
Outlet: 9/16-18
Length: 3 7/8 (98.4)

BF9887



Fuel Spin-on
Contains: Integral Post Seal
Fits: John Deere Equipment
Replaces: John Deere MIU800645; Yanmar 11980255800, 11980255801
Thread: M20 x 1.5
O.D.: 3 11/16 (93.7)
Height: 3 1/4 (82.6)
I.Gskt: [1] Included

BF9888



Fuel Spin-on
Contains: Integral Post Seal
Replaces: Clark FL-3WS0
Thread: 1 1/2 -12
O.D.: 4 21/32 (118.3)
Height: 9 15/16 (252.4)
I.Gskt: [1] Included

PF9889

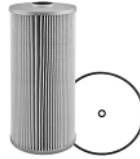

Fuel Element
Replaces: Hino S234011790
O.D.: 3 3/4 (95.3)
I.D.: 1 1/16 (27.0) One End
Height: 7 5/8 (193.7)
I.Gskt: [1] Included
O-Ring: [2] Included

PF9890



Fuel Element
Fits: Mitsubishi Trucks
Replaces: Mitsubishi ME300361; Donaldson P502226
O.D.: 3 3/4 (95.3)
I.D.: 1 1/16 (27.0) One End
Height: 3 7/8 (98.4)
I.Gskt: [1] Included
O-Ring: [3] Included

BF9891-D



Primary Fuel Element with Drain
Notes: Reverse Flow
Fits: John Deere Engines, Equipment
Replaces: John Deere RE541922
O.D.: 3 3/16 (81.0)
I.D.: 9/16 (14.3) One End
Height: 7 11/16 (195.3)
Grommets: [1] Attached

BF9892-D



Secondary Fuel Element with Drain
Fits: John Deere Engines, Equipment
Replaces: John Deere RE544394
O.D.: 3 3/16 (81.0)
I.D.: 9/16 (14.3) One End
Height: 6 1/16 (154.0)

BF9893



Fuel Spin-on
Replaces: Thermo King 11-9954, 12-9954
Thread: M22 x 1.5
O.D.: 3 11/16 (93.7)
Height: 6 5/32 (156.4)
A. Gskt: G381-A

Measurements Are Shown In Inches And (Millimeters)

WARNING: These products can expose you to chemicals, including Diisononyl Phthalate, Carbon black extracts, Nickel, 1,3 Butadiene, Ethylene Oxide, Epichlorohydrin, which are known to the State of California to cause cancer, and Bisphenol, Ethylene Glycol, Ethylene Oxide, 1,3 Butadiene, Epichlorohydrin, which are known to the State of California to cause birth defects or other reproductive harm. For more information go to www.P65Warnings.ca.gov.

BF9894 Fuel/Water Separator Spin-on
Fits: Thermo King Refrigeration Units
Replaces: Thermo King 11-8047, 11-9342, 12-9342; ACDelco TP1362
Thread: M22 x 1.5
O.D.: 3 11/16 (93.7)
Height: 4 3/8 (111.1)
A. Gskt: G381-A



PF9900 Fuel Element
Fits: Mitsubishi FV51JK Truck with 6M70 Engine
Replaces: Mitsubishi ME165323; Donaldson P502371
O.D.: 3 11/16 (93.7)
I.D.: 19/32 (15.1) One End
Height: 5 11/32 (135.7)
O-Ring: [2] Included
Grommets: [1] Attached



BF9895 KIT Set of 2 Fuel Elements
Fits: Ford Super Duty Trucks with V8-406 (6.7L) FI Turbo Diesel Engine
Replaces: Ford BC3Z-9N184-B; Mptprcraft FD4615
Element
O.D.: 4 (101.6)
I.D.: 1 3/8 (34.9) One End
Height: 5 1/4 (133.4)
A. Gskt: [1] Attached
O-Ring: [1] Included
In-Line
O.D. 3 15/16
Inlet 1/2 (12.7)
Height 4 9/32



PF9901 KIT Fuel Filter Kit
Contains: [1] Fuel Filter [1] Strainer
Fits: Freightliner Trucks
Replaces: Freightliner A0000902751
Element
O.D.: 2 13/32 (61.1)
I.D.: 17/32 (13.5) One End
Height: 5 9/16 (141.3)
O-Ring: [2] Included
Strainer
O.D. 2 (50.8)
I.D. 17/32 (13.5)
Height 2 15/16 (74.6)



PF9896 KIT Set of 3 Fuel Elements
Contains: [1] Coalescer Filter [1] Final Filter [1] Pre-Screen Filter
Fits: Mercedes-Benz Actros Euro 5/6 Trucks
Replaces: Mercedes-Benz A0000901752, A4720921305 (Screen only), A4720921105 (Final only), A720921005 (Coalescer only)
Coalescer
O.D.: 2 19/32 (65.9)
Height: 7 5/8 (193.7)
O-Ring: [3] Included
Final
O.D. 4 3/16
Height 9 11/32



PF9902 Nylon Fuel Strainer
Fits: Case, Kobelco, New Holland Excavators
Replaces: Kobelco 2446R326; New Holland 2446R326
O.D.: 3 1/16 (77.8)
I.D.: 2 1/8 (54.0) One End
Height: 5 3/16 (131.8)



PF9897 Fuel Element
Fits: Isuzu, Mitsubishi Trucks
Replaces: General Motors 97726081; Isuzu 1132401940; Mitsubishi ME300647
O.D.: 3 3/4 (95.3)
I.D.: 1 3/32 (27.8) One End
Height: 3 7/8 (98.4)
O-Ring: [1] Attached, [3] Included



BF9903-SP Fuel/Water Separator Spin-on with Drain and Sensor Port
Notes: CAUTION: Furnished O-Ring must be installed on Post for Seal
Contains: Standpipe
Sensor Port Thread: 9/16-18
Fits: Caterpillar Equipment; Kenworth, Western Star Trucks
Replaces: Caterpillar 3261641; Fleetguard FS19968
Thread: 1 -14
O.D.: 4 1/4 (108.0)
Height: 9 7/32 (234.2)
I.Gskt: [1] Included
O-Ring: [2] Included



BF9898-O Fuel/Water Separator Spin-on with Open Port for Bowl
Contains: Port Thread: M95 x 2.5 Integral Post Seal
Fits: Freightliner Cascadia, FLD, Business Class M2 Trucks
Replaces: Alliance ABPN/122R-50418; Fleetguard FS19593
Thread: 1 -14
O.D.: 4 1/4 (108.0)
Height: 6 5/16 (160.3)
I.Gskt: [1] Included
F. Gskt: [1] Included



BF9904 Fuel Spin-on with Drain
Fits: Nissan Trucks
Replaces: Nissan 16400BN303, 164037F40a, 164037F400, 164037F401
Thread: 3/4 -16
O.D.: 3 3/4 (95.3)
Height: 6 9/32 (159.5)
I.Gskt: [1] Included



PF9899 Fuel Element
Replaces: Hino S234011800
O.D.: 3 17/32 (89.7)
I.D.: 3/4 (19.1)
Height: 5 3/8 (136.5)
O-Ring: [2] Included
Grommets: [2] Attached



BF9905 In-Line Fuel Filter
Fits: Case, New Holland Loaders
Replaces: Case 87019604, 87548612; New Holland 87548612
O.D.: 1 29/32 (48.4)
Inlet: 3/8
Outlet: 3/8
Length: 5 5/8 (142.9)



Measurements Are Shown In Inches And (Millimeters)

WARNING: These products can expose you to chemicals, including Diisononyl Phthalate, Carbon black extracts, Nickel, 1,3 Butadiene, Ethylene Oxide, Epichlorohydrin, which are known to the State of California to cause cancer, and Bisphenol, Ethylene Glycol, Ethylene Oxide, 1,3 Butadiene, Epichlorohydrin, which are known to the State of California to cause birth defects or other reproductive harm. For more information go to www.P65Warnings.ca.gov.

BF9906

In-Line Fuel Filter



Fits: Kobelco, Komatsu, Yanmar Equipment
Replaces: Kobelco VV12905255630; New Holland YJ21P01008P2; Yanmar 12905255630
O.D.: 2 9/16 (65.1)
Inlet: 11/32
Outlet: 11/32
Length: 3 7/32 (81.8)

PF9911

Fuel Element



Fits: Kubota Tractors, Utility Vehicles
Replaces: Kubota 6A32059930
O.D.: 1 13/16 (46.0)
I.D.: 1/32 (0.8) One End
Height: 2 1/8 (54.0)
O-Ring: [1] Included

PF9907

In-Line Fuel Strainer with Housing



Fits: International CD, 3600 Buses, I530E Engine
Replaces: International 1817677C91; Fleetguard FF257
Strainer
O.D.: 23/32 (18.3)
I.D.: 5/8 (15.9) One End
Height: 3 1/8 (79.4)
O-Ring: [1] Included
Housing
O.D. 1 5/8 (41.3)
I.D. 1 1/32 (26.2)
Height 2 27/32 (72.2)

BF9912-O

Fuel/Water Separator Spin-on with Open Port for Bowl



Contains: Port Thread: 3 3/4-10 Buttress Integral Post Seal
Replaces: Atlas Copco 2914809200; Fleetguard FS19775
Thread: 1 -14
O.D.: 4 1/4 (108.0)
Height: 3 15/32 (88.1)
I.Gskt: [1] Included
F. Gskt: [1] Included

PF9908 KIT

Fuel Filter Kit



Contains: [1] Fuel Filter
 [1] Strainer
 [1] Grease Tube
Fits: Freightliner, Western Star Trucks with Detroit Diesel DD13, DD15, DDD16 Engines
Replaces: Detroit Diesel A4720900451, A4720900551
Element
O.D.: 4 19/32 (116.7)
I.D.: 1 9/16 (39.7)
Height: 10 (254.0)
O-Ring: [2] Included
Strainer
O.D. 2 11/32 (59.5)
I.D. 1 9/16 (39.7)
Height 3 1/16 (77.8)

BF9913

Fuel Spin-on



Contains: Water Absorbent Media
Replaces: Cim-Tek 70067, CT70067; Fleetguard FS19748
Thread: 1 -12
O.D.: 3 11/16 (93.7)
Height: 8 23/32 (221.5)
I.Gskt: [1] Included

PF9909

Fuel Element



Fits: Citroen, Ducato, Peugeot Vans
Replaces: Citroen 190698, 1906C4; Fiat 71746975, 71753841, 77362340; Peugeot 190697
O.D.: 2 5/8 (66.7)
I.D.: 7/16 (11.1) One End
Height: 3 31/32 (100.8)
O-Ring: [1] Included
Grommets: [1] Attached

PF9914 KIT

Set of 2 Fuel Elements



Fits: International TerraStar, 4300 Trucks with MaxxForce 7 (6.4L) Engine
Replaces: International 1884207C91, 1884207C92; Racor R33286
Primary
O.D.: 3 5/8 (92.1)
I.D.: 1 11/16 (42.9) One End
Height: 6 9/16 (167.5)
O-Ring: [1] Attached, [1] Included
Secondary
O.D. 3 11/32
I.D. 9/16
Height 6 3/16
O-Ring [1] Attached, [1] Included

BF9910

Fuel Spin-on



Contains: Integral Post Seal
Fits: Cummins QSB3.3 (Tier 4) Engines; Dynapac Rollers; Komatsu Engines, Excavators; Skytrak Telehandlers
Replaces: Cummins 4942437, 4946635; Komatsu 600-311-3530, 600-319-3530
Thread: M22 x 1.5
O.D.: 3 3/32 (78.6)
Height: 5 1/2 (114.3)
I.Gskt: [1] Included

BF9915

Can-Type Fuel Element



Fits: Caterpillar, Gehl, Manitou, Massey Ferguson, Merlo Equipment
Replaces: Caterpillar 2526338; Massey Ferguson 4225526M1; Perkins 26550005
O.D.: 3 7/16 (87.3)
I.D.: 3/4 (19.1) & 1 7/16 (36.5)
Height: 2 13/16 (71.4)
F. Gskt: [3] Included
O-Ring: [2] Included

BF9916

Wire Mesh In-Line Fuel Strainer



Fits: John Deere Compact Track Loaders, Skid Steer Loaders
Replaces: John Deere T257865
O.D.: 1 29/32 (48.4)
Inlet: 5/16
Outlet: 5/16
Length: 3 29/32 (99.2)

Measurements Are Shown In Inches And (Millimeters)

WARNING: These products can expose you to chemicals, including Diisononyl Phthalate, Carbon black extracts, Nickel, 1,3 Butadiene, Ethylene Oxide, Epichlorohydrin, which are known to the State of California to cause cancer, and Bisphenol, Ethylene Glycol, Ethylene Oxide, 1,3 Butadiene, Epichlorohydrin, which are known to the State of California to cause birth defects or other reproductive harm. For more information go to www.P65Warnings.ca.gov.

BF9917



High Efficiency Fuel Spin-on
Contains: Integral Post Seal
Fits: John Deere Equipment
Replaces: John Deere RE533910
Thread: 1 -14
O.D.: 4 11/32 (110.3)
Height: 9 1/4 (235.0)
I.Gskt: [1] Included

BF9918 KIT



Set of 2 Fuel Filters
Notes: Port Thread: M36 x 1.5
Contains: [1] BF9882
 [1] Element, not sold separately
Fits: Chevrolet Express Vans, GMC Savana Vans, all with V8-400 (6.6L) Turbo Diesel Engine
Replaces: General Motors 19149845; ACDelco TP3013, TP1537; Baldwin BF7933 KIT
BF9882
Thread: 3 3/8 -8 UN Buttress
O.D.: 4 1/32 (102.4)
I.D.: 1 5/8
Height: 6 1/2 (165.1)
O-Ring: [3] Included
Grommets: [1] Attached
Element
O.D. 3 11/16 (93.7)
I.D. 1 5/8 (41.3)
Height 3 15/16 (100.0)

PF9919



Fuel Element
Fits: Chevrolet, GMC, Isuzu Trucks
Replaces: General Motors 98037011; Isuzu 8982035990, 8981628970, 8980370110
O.D.: 3 25/32 (96.0)
I.D.: 15/32 (11.9) One End
Height: 4 9/16 (115.9)
A. Gskt: [1] Attached
O-Ring: [1] Included
Grommets: [1] Attached

BF9920



Fuel/Water Separator Spin-on with Drain
Fits: Case-IH, New Holland Tractors; Wirtgen Paving Equipment
Replaces: Case 84477362, 87366406, 87395356; New Holland 84477362, 87366406, 87395356
Thread: M85 x 2.0
O.D.: 4 11/16 (119.1)
Height: 11 1/8 (282.6)
I.Gskt: [1] Included

BF9921-O



Fuel/Water Separator Spin-on with Open Port for Bowl
Contains: Pre-Fill Cup
 Integral Post Seal
 Port Thread: M95 x 2.5
Fits: John Deere Industrial, Marine Engines
Replaces: John Deere RE503676
Thread: 1 -14
O.D.: 4 1/4 (108.0)
Height: 8 21/32 (219.9)
I.Gskt: [1] Included
O-Ring: [1] Included
Grommets: [1] Attached

BF9922-O



Fuel/Water Separator Spin-on with Open Port for Bowl
Notes: Inside-Out Flow Direction
Contains: Port Thread: M80 x 2.5
 Integral Post Seal
Fits: Mercedes-Benz Latin America Buses, Trucks
Replaces: Mercedes-Benz A3820927005; Racor R20P
Thread: 1 -14
O.D.: 3 21/32 (92.9)
Height: 4 1/8 (104.8)
I.Gskt: [1] Included
O-Ring: [1] Included
Related To: BF46021-O, BF46022-O (Micron Difference)

BF9923-O



Fuel Spin-on with Threaded Port
Contains: Port Thread: 1 1/4-10
Fits: Atlas Copco, Bomag Equipment; Dynapac Rollers; Komatsu Excavators
Replaces: Cummins 4941237; Komatsu 600-319-4110
Thread: M24 x 1.5
O.D.: 3 3/4 (95.3)
Height: 5 1/4 (133.4)
I.Gskt: [1] Included
O-Ring: [1] Included

PF9924 KIT



Fuel Filter Kit
Notes: Parts Not Sold Separately
Fits: Detroit Diesel DD13 (12.8L), DD15 (14.8L), DD16 (15.6L) Engines; Freightliner, Sterling, Western Star Trucks
Replaces: Detroit Diesel A0000904251
Coalescer
O.D.: 4 3/16 (106.4)
Height: 9 11/32 (237.3)
O-Ring: [3] Included
Final Filter
O.D. 2 5/8 (66.7)
Height 7 5/32 (181.8)

BF9925-O



Fuel/Water Separator Spin-on with Open Port for Bowl
Contains: Port Thread: M95 x 2.5
Replaces: Racor S6464; Donaldson P551034; Fleetguard FS19538
Thread: 1 -14
O.D.: 4 1/4 (108.0)
Height: 6 5/16 (160.3)
F. Gskt: [2] Included

BF9926-O



Fuel/Water Separator Spin-on with Open Port for Bowl
Contains: Port Thread: M80 x 2.5
 Integral Post Seal
Fits: Yanmar Engines
Replaces: Yanmar 12065055020
Thread: 1 -14
O.D.: 3 11/16 (93.7)
Height: 4 1/8 (104.8)
I.Gskt: [1] Included
O-Ring: [1] Included

Measurements Are Shown In Inches And (Millimeters)

WARNING: These products can expose you to chemicals, including Diisononyl Phthalate, Carbon black extracts, Nickel, 1,3 Butadiene, Ethylene Oxide, Epichlorohydrin, which are known to the State of California to cause cancer, and Bisphenol, Ethylene Glycol, Ethylene Oxide, 1,3 Butadiene, Epichlorohydrin, which are known to the State of California to cause birth defects or other reproductive harm. For more information go to www.P65Warnings.ca.gov.

BF9927



High Efficiency Fuel Spin-on
Fits: Kenworth, Peterbilt Trucks with Paccar MX Engines
Replaces: Paccar 1655115; Donaldson P551004; Fleetguard FF252
Thread: 1 -14
O.D.: 3 23/32 (94.5)
Height: 8 7/32 (208.8)
I.Gskt: G401

PF9928



Fuel/Water Separator Element
Fits: Kenworth, Peterbilt Trucks with Cummins ISL, ISX, Paccar MX, MX-13 Engines
Replaces: Paccar K371004
O.D.: 4 1/8 (104.8)
Height: 7 1/2 (190.5)
F. Gskt: [1] Included
Grommets: [1] Attached

PF9929



Fuel/Water Separator Element
Fits: Kenworth, Peterbilt Trucks with Paccar MX-13 Engine
Replaces: Paccar K371009
O.D.: 4 1/8 (104.8)
Height: 7 1/2 (190.5)
F. Gskt: [1] Included
Grommets: [1] Attached

PA10000



Panel Air Element
Fits: Mitsubishi Lancer, Outlander Sport
Replaces: Mitsubishi 1500A513
Length: 10 5/32 (258.0)
Width: 8 3/16 (208.0)
Height: 2 3/32 (53.2)

PA10001

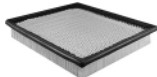

Panel Air Element
Fits: Cadillac XTS; Chevrolet Impala
Replaces: General Motors 22753242
Length: 11 5/16 (287.3)
Width: 10 (254.0)
Height: 1 25/32 (45.2)

PA10002

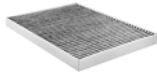

Cabin Air Element
Contains: Charcoal Impregnated Media for Odor Control
Fits: Buick, Chevrolet, GMC, Saturn Automotive, Light-Duty Trucks
Replaces: ACDelco CF179C
Length: 9 9/32 (235.7)
Width: 6 25/32 (172.2)
Height: 23/32 (18.3)

PA10003



Panel Air Element
Fits: Ford Fiesta
Replaces: Ford CN1Z9601A; Motorcraft FA1914
Length: 7 3/4 (196.9)
Width: 6 5/16 (160.3)
Height: 2 3/4 (69.9)

PA10004

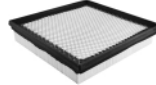

Panel Air Element
Fits: Chrysler 200, Dodge Avenger, Journey
Replaces: Chrysler 68081249AC
Length: 9 7/32 (234.2)
Width: 8 15/16 (227.0)
Height: 1 13/16 (46.0)

RS10005



Radial Seal Air Element
Fits: Dodge Caliber; Jeep Compass, Patriot
Replaces: Chrysler 4593914AB
O.D.: 5 11/32 (135.7)
I.D.: 3 5/32 (80.2) One End
Height: 6 15/16 (176.2)

PA10006

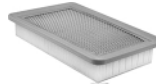

Panel Air Element with Foam Pad
Fits: Chrysler 200 with V6-220 (3.6L) FI Engine
Replaces: Chrysler 6824545AA
Length: 11 15/16 (303.2)
Width: 7 1/8 (181.0)
Height: 1 7/8 (47.6)

PA10007



Panel Air Element with Foam Pad
Fits: Renault Kangoo Vans
Replaces: Renault 7701477208
Length: 14 31/32 (380.2)
Width: 3 9/32 (83.3)
Height: 2 5/16 (58.7)

PA10008

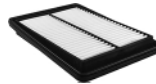

Panel Air Element
Fits: Nissan Rogue
Replaces: Nissan 165464BA1A
Length: 9 31/32 (253.2)
Width: 6 25/32 (172.2)
Height: 1 13/32 (35.7)
A. Gskt: [1] Attached

PA10009

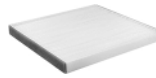

Cabin Air Element
Fits: Chrysler 200; Jeep Cherokee
Replaces: Chrysler 68223044AA
Length: 9 9/32 (235.7)
Width: 8 19/32 (218.3)
Height: 25/32 (19.8)
A. Gskt: [2] Attached

PA10010

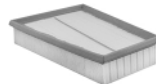

Panel Air Element
Fits: 2010 Renault Megane with 4-1998cc (2.0L) Engine
Replaces: Renault 820371661
Length: 9 9/16 (242.9)
Width: 5 9/32 (134.1) to 7 15/32 (189.7)
Height: 2 3/16 (55.6)

PA10011

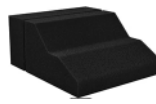

Foam Air Pre-Cleaner
Contains: Flame Retardant Media
Fits: Ford Super Duty Pickups with V8-406 (6.7L) FI Turbo Diesel Engine
Replaces: Motorcraft FA1909
Length: 7 3/8 (187.3)
Width: 6 3/8 (161.9)
Height: 3 1/4 (82.6)

Measurements Are Shown In Inches And (Millimeters)

! **WARNING:** These products can expose you to chemicals, including Diisononyl Phthalate, Carbon black extracts, Nickel, 1,3 Butadiene, Ethylene Oxide, Epichlorohydrin, which are known to the State of California to cause cancer, and Bisphenol, Ethylene Glycol, Ethylene Oxide, 1,3 Butadiene, Epichlorohydrin, which are known to the State of California to cause birth defects or other reproductive harm. For more information go to www.P65Warnings.ca.gov.

PA10012 Panel Air Element with Foam Pad
Fits: Opel Movano A 3.0 CDTI; Renault Master III 3.0 DCI European Light-Duty Vehicles
Replaces: Renault 8200488878, 8200283082; Nissan 1654600Q0G, 1654600QAM; Opel 4415430, 4417325, 93190266, 93181231
Length: 14 5/32 (359.6)
Width: 10 3/8 (263.5)
Height: 2 1/8 (54.0)

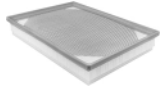

PA10013 Air with Foam Pad
Replaces: Fiat 51925027
Length: 14 1/32 (356.4)
Width: 5 5/32 (131)
Height: 2 (50.8)



PA10014 Cabin Air Element
Fits: Chevrolet Colorado; GMC Canyon
Replaces: General Motors 23135671; ACDelco CF196
Length: 9 7/16 (239.7)
Width: 8 (203.2)
Height: 1 3/16 (30.2)



PA10015 Panel Air Element
Fits: Chevrolet Colorado, GMC Canyon
Replaces: General Motors 94775933; ACDelco A3195C
Length: 10 11/16 (271.5)
Width: 10 3/32 (256.4)
Height: 1 9/16 (39.7)

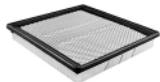

PA10016 Cabin Air Element
Notes: Single filter version of the PA4460 KIT Requires 2 filters per application.
Fits: Jeep Wrangler
Replaces: Chrysler 68233626AA
Length: 5 27/32 (148.4)
Width: 5 27/32 (148.4)
Height: 25/32 (19.8)



PA10017 Cabin Air Element
Fits: Ram ProMaster 1500, ProMaster 2500, ProMaster 3500 Vans
Replaces: Chrysler 68169308AA
Length: 9 15/16 (252.4) to 11 31/32 (304.0)
Width: 8 21/32 (219.9)
Height: 1/2 (12.7)



PA10018 Cabin Air Element
Contains: Charcoal Impregnated Media for Odor Control
Fits: Audi, Porsche, Volkswagen Automotive
Replaces: Volkswagen 7HO819631A; Porsche 95557221910
Length: 10 29/32 (277.0)
Width: 8 5/8 (219.1)
Height: 1 11/32 (34.1)
Related To: PA10034 (without Charcoal)

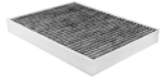

PA10020 Cabin Air Element with Lift Tab
Fits: 1996-2001 Volkswagen Eurovan
Replaces: Volkswagen 7D0819989
O.D.: 7 13/32 (188.1)
I.D.: 4 11/32 (110.3) One End
Height: 4 1/32 (102.4)



RS10021 Radial Seal Air Element
Fits: Ram ProMaster 1500, ProMaster 2500, ProMaster 3500 Vans with V6-220 (3.6L) FI Engine
Replaces: Ram 4861865AA, 52022424AA
O.D.: 6 17/32 (165.9)
I.D.: 4 1/2 (114.3) One End
Height: 12 3/8 (314.3)



PA10022 Panel Air Element
Fits: Ram Light-Duty Trucks with V6-182 (3.0L) FI Turbo Diesel, V8-392 (6.4L) FI Engines
Replaces: Chrysler 68190705AA
Length: 13 7/8 (352.4)
Width: 9 3/8 (238.1)
Height: 2 9/32 (57.9)

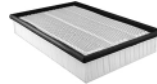

PA10023 Panel Air Element
Fits: Nissan Altima
Replaces: Nissan 165463TA0A
Length: 11 3/8 (288.9)
Width: 11 3/8 (288.9)
Height: 1 3/32 (27.8)
A. Gskt: [1] Included



PA10024 Panel Air Element
Fits: Acura TLX, Honda Accord with 4-2356cc (2.4L) Engine
Replaces: Honda 172205A2A00
Length: 12 1/16 (306.4)
Width: 7 5/8 (193.7)
Height: 2 9/32 (57.9)
A. Gskt: [1] Included



PA10025 Panel Air Element
Fits: Mazda Automotive
Replaces: Mazda PE07133A0A
Length: 10 21/32 (273.1)
Width: 7 1/16 (179.4)
Height: 1 5/16 (33.3)
A. Gskt: [1] Included



PA10026 Panel Air Element
Fits: Honda Odyssey
Replaces: Honda 17220-RV0A00
Length: 11 29/32 (302.4)
Width: 6 23/32 (170.7)
Height: 2 3/32 (53.2)
A. Gskt: [1] Included



PA10027 Panel Air Element
Fits: Hyundai Tucson; Kia Sportage
Replaces: Hyundai 28113-2S000; Kia 28113-2S000
Length: 10 5/32 (258.0)
Width: 6 13/32 (162.7)
Height: 1 7/8 (47.6)



PA10028 Panel Air Element
Fits: Lexus CT200h; Toyota Prius
Replaces: Toyota 17801-37020
Length: 8 3/4 (222.3)
Width: 7 3/8 (187.3)
Height: 1 13/32 (35.7)



Measurements Are Shown In Inches And (Millimeters)

WARNING: These products can expose you to chemicals, including Diisononyl Phthalate, Carbon black extracts, Nickel, 1,3 Butadiene, Ethylene Oxide, Epichlorohydrin, which are known to the State of California to cause cancer, and Bisphenol, Ethylene Glycol, Ethylene Oxide, 1,3 Butadiene, Epichlorohydrin, which are known to the State of California to cause birth defects or other reproductive harm. For more information go to www.P65Warnings.ca.gov.



<p>PA10030</p> 	<p>Cabin Air Element Fits: Chrysler Town & Country, Dodge Grand Caravan, Ram Cargo Vans Replaces: Chrysler 68127809AA Length: 8 15/16 (227.0) Width: 7 7/8 (200.0) Height: 1 3/16 (30.2)</p>	<p>PA10039</p>  <p>Panel Air Element Fits: Chevrolet Sonic Replaces: General Motors 96950990 Length: 9 17/32 (242.1) Width: 6 25/32 Height: 1 31/32 (50.0)</p>
<p>PA10031</p> 	<p>Cabin Air Element Fits: Infiniti JX35, QX60; Nissan Altima, Murano, Pathfinder Replaces: Nissan 272773JC1A Length: 11 1/16 (281.0) Width: 9 21/32 (245.3) Height: 3/4 (19.1)</p>	<p>PA10040</p>  <p>Panel Air Element Fits: Lexus, Toyota Automotive Replaces: Toyota 17801-38010 Length: 10 5/8 (269.9) Width: 7 3/32 (180.2) Height: 1 3/8 (180.2)</p>
<p>PA10032</p> 	<p>Cabin Air Element Fits: Mazda CX5, Mazda 3, Mazda 6 Replaces: Mazda KD4561J6X Length: 8 7/8 (225.4) Width: 7 3/4 (196.9) Height: 13/16 (20.6) A. Gskt: [1] Included</p>	<p>PA10041</p>  <p>Cabin Air Element Fits: Subaru Impreza, Forester, Outback Sport, WRX, WRX Sti Replaces: Subaru 72880FG000, 72880FG0009P Length: 9 3/16 (233.4) Width: 8 13/16 (233.8) Height: 2 1/4 (57.2) A. Gskt: [1] Included</p>
<p>PA10033</p> 	<p>Panel Air Element Contains: Flame Retardant Media Fits: Ford Mustang Replaces: Ford FR3Z-9601-A; Motorcraft FA1918 Length: 11 3/16 (284.2) Width: 10 3/16 (258.8) Height: 2 9/32 (57.9)</p>	<p>PA10042</p>  <p>Cabin Air Element Fits: Hyundai Santa Fe; Kia Sorento Replaces: Hyundai 1UF79AQ000, 2BF79AQ000, 971331U000 Length: 10 5/16 (261.9) Width: 8 7/32 (208.8) Height: 1 3/16 (30.2)</p>
<p>PA10034</p> 	<p>Cabin Air Element Fits: Audi, Porsche, Volkswagen Automotive Replaces: Volkswagen 7H0819631 Length: 10 29/32 (277.0) Width: 8 5/8 (219.1) Height: 1 11/32 (34.1) Related To: PA10018 (Charcoal Version)</p>	<p>PA10043</p>  <p>Cabin Air Element Fits: Chrysler 300, Dodge Challenger, Charger Replaces: Chrysler 68071668AA Length: 10 7/8 (276.2) Width: 7 7/8 (200) Height: 1 3/16 (30.2)</p>
<p>RS10035</p> 	<p>Radial Seal Air Element Fits: Ford Rangers; Mazda, Toyota Light-Duty Trucks Replaces: Toyota 178010C010, 178010C01000, 178010C020; Donaldson P902609; Fleetguard AF26501 O.D.: 8 1/2 (215.9) I.D.: 4 5/8 (117.5) One End Height: 6 3/4 (171.5)</p>	<p>PA10044</p>  <p>Panel Air Element with Pull Tabs Fits: Hyundai Sonata; Kia Optima Replaces: Hyundai 28113C1100, 28113D3300 Length: 10 29/32 (277) Width: 7 27/32 (199.2) Height: 1 11/16 (42.9)</p>
<p>PA10036</p> 	<p>Cabin Air Element Contains: Charcoal Impregnated Media for Odor Control Fits: Mercedes-Benz Automotive Replaces: Mercedes-Benz 2468300018, A2468300018 Length: 10 3/32 (256.4) Width: 10 1/32 (254.8) Height: 1 3/4 (44.5)</p>	<p>PA10045</p>  <p>Panel Air Element with Foam Pad Fits: Toyota Sequoia, Tacoma, Tundra Replaces: Toyota 178010S020, 178010P100 Length: 11 25/32 (299.2) Width: 10 7/32 (259.6) Height: 2 9/16 (65.1)</p>
<p>PA10037</p> 	<p>Panel Air Element Fits: Mercedes-Benz Automotive Replaces: Mercedes-Benz 2700940004 Length: 10 5/16 (261.9) Width: 3 13/16 (96.8) Height: 2 9/32 (57.9)</p>	<p>PA10046</p>  <p>Panel Air Element Fits: Jeep Renegade; Ram ProMaster City; Fiat 500X Replaces: Chrysler 68247339AA, K68247339AA; Fiat 51977574 Length: 8 3/16 (208) Width: 7 13/32 (188.1) Height: 2 17/32 (64.3)</p>
<p>PA10038</p> 	<p>Panel Air Element Fits: Chevrolet Spark Replaces: General Motors 96910360 Length: 11 13/32 (289.7) Width: 6 1/8 (155.6) Height: 1 1/8 (28.6) A. Gskt: [1] Included</p>	<p>PA10047</p>  <p>Panel Air Element Fits: Honda CRV with (2.4L) Engines Replaces: Honda 172205LAA00 Length: 11 1/8 (282.6) Width: 7 1/2 (190.5) Height: 2 (50.8) A. Gskt: [1] Included</p>

Measurements Are Shown In Inches And (Millimeters)

 **WARNING:** These products can expose you to chemicals, including Diisononyl Phthalate, Carbon black extracts, Nickel, 1,3 Butadiene, Ethylene Oxide, Epichlorohydrin, which are known to the State of California to cause cancer, and Bisphenol, Ethylene Glycol, Ethylene Oxide, 1,3 Butadiene, Epichlorohydrin, which are known to the State of California to cause birth defects or other reproductive harm. For more information go to www.P65Warnings.ca.gov.

<p>PA10057 Panel Air Element  Fits: Honda Civic, CR-V Replaces: Honda 172205AAA00 Length: 9 11/16 (246.1) Width: 5 5/8 (142.9) Height: 2 5/16 (58.7) A. Gskt: [1] Included</p>	<p>PA10068 Oval Air Element  Fits: Ford Super Duty Trucks with (6.2L), (6.8L) Engines Replaces: Ford HC3Z9601B; Motorcraft FA1928 O.D.: 6 29/32 (175.4) to 9 7/8 (250.8) I.D.: 3 23/32 (94.5) & 6 11/16 (169.9) Height: 9 9/16 (242.9)</p>
<p>PA10058 Panel Air Element  Fits: Acura, Honda Automotive, Light-Duty Trucks Replaces: Honda 172205J6A10 Length: 11 9/16 (293.7) Width: 6 1/2 (165.1) Height: 1 7/8 (47.6) A. Gskt: [1] Included</p>	<p>PA10070 Panel Air Element  Fits: Ford C-Max, Fusion, Lincoln MKZ all with 4-122 (2.0L) FI Hybrid Engine Replaces: Ford DG9Z-9601-A; Motorcraft FA1911 Length: 9 1/4 (235.0) Width: 8 1/8 (206.4) Height: 1 5/8 (41.3)</p>
<p>PA10060 Panel Air Element  Fits: Chevrolet Caprice, SS; Pontiac G8 Replaces: General Motors 92066873 Length: 12 31/32 (329.4) Width: 6 (152.4) to 9 15/32 (240.5) Height: 2 1/32 (51.6)</p>	<p>PA10071 Panel Air Element  Fits: Infiniti M35, M37, Q70 Replaces: Nissan 16546EJ70A Length: 8 3/16 (208) Width: 6 31/32 (177) Height: 1 3/4 (44.5) A. Gskt: [1] Included</p>
<p>PA10061 Oval Air Element with Foam  Notes: O.D. Includes Foam Fits: Ford Super-Duty Trucks with (6.7L) Engines Replaces: Ford HC3Z9601A; Motorcraft FA1927 O.D.: 8 1/16 (204.8) to 11 1/32 (280.2) I.D.: 3 23/32 (94.5) & 6 11/16 (169.9) Height: 9 9/16 (242.9)</p>	<p>PA10072 Panel Air Element  Fits: Acura RDX Replaces: Honda 17220R8AA01 Length: 11 15/16 (303.2) Width: 7 29/32 (200.8) Height: 1 5/8 (41.3) A. Gskt: [1] Included</p>
<p>PA10062 Air Element with Foam Wrap  Contains: Sensor Port Fits: Chevrolet Cruze Replaces: General Motors 39030321; ACDelco A3220C O.D.: 5 21/32 (143.8) to 6 7/32 (158.0) Height: 6 13/16 (173)</p>	<p>PA10073 Panel Air Element  Fits: Acura MDX Replaces: Acura 172205J6A00 Length: 11 5/8 (295.3) Width: 6 7/8 (174.6) Height: 1 5/8 (41.3)</p>
<p>PA10064 Panel Air Element  Fits: Honda HR-V with (1.8L) Engine Replaces: Honda 1722051BH00 Length: 9 (228.6) Width: 8 19/32 (218.3) Height: 1 15/16 (49.2) A. Gskt: [1] Included</p>	<p>CV15000 Crankcase Breather  Fits: Autocar, Cummins, Freightliner, IHC, Kenworth, Mack, Peterbilt, Volvo Trucks with Cummins ISM, ISX Engines Replaces: Cummins 3683918, 3685528, 391476, 4312011, 4312013; Fleetguard CV50031, CV50633, CV50634, CV50617, CV50601, CV50607 Length: 11 1/8 (282.6) Width: 8 15/16 (227.0) Height: 2 21/32 (67.5) A. Gskt: [2] Attached</p>
<p>PA10066 Panel Air Element  Fits: Kia Soul, Soul EV Replaces: Kia 97133B2000 Length: 8 1/4 (209.6) Width: 6 15/32 (164.3) Height: 1 (25.4)</p>	<p>CV15001 Crankcase Breather  Fits: Mercedes-Benz Actros I Series, Actros II Series Trucks with Mercedes-Benz OM501LA, OM502LA Engines Replaces: Mercedes-Benz 5410100080 O.D.: 2 1/4 (57.2) I.D.: 1 3/4 (44.5) One End Height: 4 13/16 (122.2) O-Ring: [1] Attached, [1] Included</p>
<p>PA10067 Cabin Air Element  Contains: Charcoal impregnated media for odor control. Fits: Kia Sorento Replaces: Kia C6C79AC000 Length: 10 9/32 (261.1) Width: 7 29/32 (200.8) Height: 1 3/16 (30.2)</p>	<p>CV15002 Crankcase Breather  Fits: Case Dump Trucks; Case-IH Steiger; Steiger Tractors; New Holland Combines Replaces: Iveco 504209107; Alco MD8464 Length: 10 11/32 (262.7) Width: 5 15/32 (1338.9) Height: 31/32 (24.6) A. Gskt: [2] Attached</p>

Measurements Are Shown In Inches And (Millimeters)

 **WARNING:** These products can expose you to chemicals, including Diisononyl Phthalate, Carbon black extracts, Nickel, 1,3 Butadiene, Ethylene Oxide, Epichlorohydrin, which are known to the State of California to cause cancer, and Bisphenol, Ethylene Glycol, Ethylene Oxide, 1,3 Butadiene, Epichlorohydrin, which are known to the State of California to cause birth defects or other reproductive harm. For more information go to www.P65Warnings.ca.gov.

CV15003



Crankcase Breather
Fits: Detroit Diesel Series 50, Series 60 Engines
Replaces: Detroit Diesel 23522898; Racor CCV5524808
O.D.: 3 25/32 (96.0)
I.D.: 7/8 (22.2) One End
Height: 5 31/32 (151.6)
O-Ring: [2] Included

CV15004



Crankcase Breather
Fits: Spiracle Crankcase Ventilation Systems for Various Diesel Trucks and Equipment
Replaces: Donaldson P607673
O.D.: 5 3/32 (129.4)
I.D.: 2 1/8 (54.0) One End
Height: 7 19/32 (192.9)

CV15005



Crankcase Breather
Fits: Caterpillar, John Deere Marine Engines
Replaces: John Deere RE530346; Fleetguard CV55018
O.D.: 5 1/16 (128.6)
I.D.: 1 1/4 (31.8) One End
Height: 8 1/16 (204.8)
O-Ring: [2] Included

CV15006



Crankcase Breather
Contains: Instruction Sheet
 Foam
 Tubing
 Cap Replacement
 Washer
Fits: Case Dozers; Case-International Tractors; New Holland Dozers, Motor Graders; Steyr Tractors
Replaces: Case 87304662; New Holland 87304662
Thread: 1 -173
O.D.: 5 3/4 (146.1)
Height: 3 5/16 (84.1)
O-Ring: [2] Included

BA16000



Air Dryer Filter
Contains: [4] Bolts and Nuts
 [4] Locking Pins
Fits: Volvo Dump Trucks, Excavators; European FH Serie Trucks
Replaces: Evobus 4294695; Haldex 78964, 83212, 92528, 93522; Iveco 42535061; Renault 5001826800; Volvo 20424148, 20546795, 20773824
O.D.: 6 (152.4)
Height: 6 3/8 (161.9)
O-Ring: [1] Included

PE17001



Diesel Exhaust Fluid Strainer
Fits: Mack, Nissan UD, Volvo Trucks
Replaces: Mack 82269261; Nissan 5282269261
O.D.: 15/16 (23.8) & 1 13/16 (46.0)
I.D.: 25/32 (19.8) One End
Height: 7 17/32 (191.3)

18003



Transmission Filter
Notes: Pan gasket contains [13] bolt holes.
Fits: Chrysler, Eagle Automotive with Torque-Flite 42LE (A606) Transmission (FWD 4 Spd.)
Replaces: Chrysler 4626449
Length: 7 3/16 (182.6)
Width: 6 7/8 (174.6)
O-Ring: [1] Included
Pan Gasket: [1] Included

18004



Transmission Filter
Notes: Pan gasket contains [14] bolt holes.
Fits: Chrysler, Eagle, Mitsubishi Automotive, Vans with Torque-Flite 40TE, 41AE, 41TE, (A604) Transmissions (FWD, 4 Spd. with Overdrive)
Replaces: Chrysler 4505048
Length: 7 3/16 (182.6)
Width: 6 29/32 (175.4)
O-Ring: [1] Included
Pan Gasket: [1] Included

18007



Transmission Filter
Contains: [1] Plastic Neck Seal
 [1] Information Sheet
Fits: 1991-96 Chevrolet, GMC Light-Duty Trucks, Vans, 1994-99 AM General, 1993-97 Jaguar Automotive with 4L80-E Electronic Transmission (RWD, 4 Spd.)
Replaces: GMC 8684221
Length: 8 17/32 (216.7)
Width: 7 (177.8)

18010



Transmission Filter
Notes: Pan gasket contains [16] bolt holes.
Contains: [1] Plastic Neck Seal
 [1] Information Sheet
Fits: 1994-96, 2004-07 Buick, 1994-2006 Cadillac, 1993-on Chevrolet, 1996-2000, 2003-08 Isuzu, 1993-2004 Oldsmobile, 1993-2002 Pontiac, 2006-09 Saab Automotive; 1993-on GMC Light-Duty Trucks, Vans, with 4L6
Replaces: GMC 24200796
Length: 9 1/2 (241.3)
Width: 7 17/32 (191.3)
Height: 3 3/4 (95.3)
Pan Gasket: [1] Included

18015



Transmission Filter
Notes: Pan gasket contains [17] bolt holes.
Contains: [1] Filter-to-Valve Metal Body Gasket
Fits: Ford Light-Duty Trucks, Vans with C-6 Transmission (4WD, RWD, Deep Pan)
Replaces: Ford D3TZ-7A098-B; Mptprcraft FT48
Length: 8 13/16 (223.8)
Width: 7 5/16 (185.7)
F. Gskt: [1] Included
Pan Gasket: [1] Included

Measurements Are Shown In Inches And (Millimeters)

WARNING: These products can expose you to chemicals, including Diisononyl Phthalate, Carbon black extracts, Nickel, 1,3 Butadiene, Ethylene Oxide, Epichlorohydrin, which are known to the State of California to cause cancer, and Bisphenol, Ethylene Glycol, Ethylene Oxide, 1,3 Butadiene, Epichlorohydrin, which are known to the State of California to cause birth defects or other reproductive harm. For more information go to www.P65Warnings.ca.gov.

18022 Transmission Filter
Notes: Can only be used with 2 1/4 In. deep pan.
Contains: [1] Plastic Neck Seal
 Instruction Sheet
Fits: 1991-2011 Buick, Chevrolet, 1991-95 Cadillac, 1991-2004 Oldsmobile, 1992-2009 Pontiac, 2005-09 Saturn Automotive with 4T60-E Electronic Transmissions (FWD, 4 Spd.)
Replaces: GMC 24206433
Length: 10 19/32 (269.1)
Width: 6 13/16 (173.0)
Height: 2 5/32 (54.8)
Related To: 20014 (with Pan Gasket)



18032 Transmission Filter
Notes: Both pan gaskets contain [14] bolt holes.
Fits: AMC, Chrysler, Mitsubishi Automotive, Light-Duty Trucks, Vans, International Light-Duty Trucks, Jeep with Torque-Flite "6" (904), "6" (999), "8" (727) Transmissions (RWD)
Replaces: Chrysler 3515966, 3515996; International 732931-C2; Jeep J8123042
Length: 7 3/32 (180.2)
Width: 6 5/8 (168.3)
Pan Gasket: [2] Included

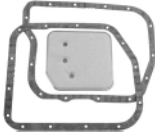

18024 Transmission Filter
Notes: Pan gasket contains [18] bolt holes.
Contains: [1] Mounting Bolt
 [1] Rubber Seal
Fits: 1989-on Ford Automotive, Light-Duty Trucks, 1991-2009 Mazda Light-Duty Trucks, 1998-2001 Mercury Mountaineer with A4LD Transmission (RWD, 4 Spd.)
Replaces: Ford F9TZ-7A098-C; Mazda ZL2-21-500
Length: 11 1/2 (292.1)
Width: 5 15/32 (138.9)
Height: 1 1/16 (27.0)
O-Ring: [2] Attached
Pan Gasket: [1] Included



18033 Transmission Filter
Notes: [1] Pan gasket contains [17] bolt holes.
 [1] Pan gasket contains [19] bolt holes.
Contains: Mounting Bracket
Fits: Ford Automotive with AX4N, AX4S Transmissions (FWD, 4 Spd., Deep Pan)
Replaces: Ford F5DZ-7A098-A
Length: 7 13/32 (188.1)
Width: 7 1/16 (179.4)
Height: 2 7/32 (56.4)
Pan Gasket: [2] Included



18025 Transmission Filter
Notes: Pan gasket contains [18] bolt holes.
Contains: [1] Mounting Bolt
 [1] Rubber Seal
Fits: Ford, Mazda Automotive, Light-Duty Trucks, Vans with A4LD Transmission (4WD, RWD, 4 Spd., Deep Pan)
Replaces: Ford 85GT-7A098-AC; Mazda ZL2-21-500
Length: 11 1/2 (292.1)
Width: 5 15/32 (138.9)
Height: 2 9/32 (57.9)
Pan Gasket: [1] Included



18034 Transmission Filter
Notes: Pan gasket contains [19] bolt holes.
Fits: Ford, Mercury Automotive, Vans with AX4S, AX4N Transmissions (Shallow Pan)
Replaces: Ford F6DZ-7A098-A
Length: 7 13/32 (188.1)
Width: 7 1/16 (179.4)
Pan Gasket: [1] Included



18027 Transmission Filter
Notes: Reuse OEM gasket.
Contains: [1] Plastic Neck Seal
Fits: 2000-04 AM General, 2002-06 Cadillac Escalade, 1997-on Chevrolet, GMC Light-Duty Trucks, Vans with 4L80-E Electronic Transmission (RWD, 4 Spd.)
Replaces: GMC 24208847
Length: 8 17/32 (216.7)
Width: 7 1/8 (181.0)
Height: 1 1/8 (28.6)



18055 Transmission Filter
Notes: Both pan gaskets contain [14] bolt holes.
Fits: Dodge Automotive, Light-Duty Trucks, Vans, Jeep Light-Duty Trucks with 42RE, 46RE, 47RE Transmissions
Replaces: Chrysler 52118789
Length: 7 3/16 (182.6)
Width: 7 1/8 (181.0)
Height: 31/32 (24.6)
Pan Gasket: [2] Included



18029 Transmission Filter
Notes: Pan gasket contains [14] bolt holes.
Fits: 1994-on Ford, 1996-2011 Lincoln, Mercury Automotive with AOD-E Transmission (4WD, RWD)
Replaces: Ford F4TZ-7A098-A, F6AZ-7A098-A
Length: 9 9/16 (242.9)
Width: 7 1/8 (181.0)
Height: 2 3/4 (69.9)
Grommets: [1] Attached
Pan Gasket: [1] Included



18056 Transmission Filter
Notes: Pan gasket contains [16] bolt holes.
Contains: [1] Plastic Neck Seal
Fits: 2004-07 Buick Rainier, 1999-2006 Cadillac Escalade, 1998-on Chevrolet, GMC Light-Duty Trucks, Vans, 2003-07 Hummer H2, 1998-2008 Isuzu, 1993-2004 Oldsmobile Bravada, 2004-06 Pontiac GTO, 2005-09 Saab
Replaces: GMC 24208576
Length: 9 7/16 (239.7)
Width: 7 17/32 (191.3)
Height: 4 23/32 (119.9)
Pan Gasket: [1] Included



18057 Transmission Filter
Notes: Pan gasket contains [12] bolt holes.
Contains: [1] Plastic Neck Seal
Fits: GMC, Saturn Automotive with 4T40E Transmission
Replaces: GMC 8685185, 24203770
Length: 13 3/8 (339.7)
Width: 8 1/16 (204.8)
Height: 1 25/32 (45.2)
Pan Gasket: [1] Included



Measurements Are Shown In Inches And (Millimeters)

WARNING: These products can expose you to chemicals, including Diisononyl Phthalate, Carbon black extracts, Nickel, 1,3 Butadiene, Ethylene Oxide, Epichlorohydrin, which are known to the State of California to cause cancer, and Bisphenol, Ethylene Glycol, Ethylene Oxide, 1,3 Butadiene, Epichlorohydrin, which are known to the State of California to cause birth defects or other reproductive harm. For more information go to www.P65Warnings.ca.gov.

18104

Transmission Filter



Notes: Can only be used with 2 1/4 In. deep pan.
Pan gasket contains [14] bolt holes.
Fits: Chrysler Automotive, Vans with Torque-Flite 30TH A404 Transmissions (FWD, 3 Spd., Deep Pan)
Replaces: Chrysler 4269649
Length: 7 3/16 (182.6)
Width: 6 1/16 (154.0)
Height: 11/16 (17.5)
F. Gskt: [1] Included
Pan Gasket: [1] Included

18155

Transmission Filter



Notes: Pan gasket contains [16] bolt holes.
Fits: 1987-91 Avanti II; 1986-93 Buick, 1991-93 Cadillac, 1982-95 Chevrolet, 1988-93 Oldsmobile, 1983-93 Pontiac Automotive, 1982-93 GMC Light-Duty Trucks with 4L60 (THM700-R4) Transmission (RWD, 4 Spd. with Overdrive)
Replaces: GMC 25011237
Length: 8 1/16 (204.8)
Width: 7 7/8 (200.0)
Height: 4 1/4 (108.0)
Pan Gasket: [1] Included

18171

Transmission Filter



Notes: Pan gasket contains [17] bolt holes.
Contains: [1] Metal Mounting Bracket
Fits: Ford Automotive, Vans with AXOD, AX4N Transmissions (FWD, 4 Spd.)
Replaces: Ford E6DZ-7A098-A
Length: 7 11/32 (186.5)
Width: 7 1/16 (179.4)
Height: 2 11/16 (68.3)
Pan Gasket: [1] Included

18198

Transmission Filter



Notes: Pan gasket contains [14] bolt holes.
Fits: Ford Light-Duty Trucks, Vans with AOD, AOT Transmissions (4WD, RWD, 4 Spd.)
Replaces: Ford E5TZ-7A098-C
Length: 8 31/32 (227.8)
Width: 6 15/16 (176.2)
Height: 2 5/32 (54.8)
F. Gskt: [1] Included
Pan Gasket: [1] Included

18236

Transmission Filter



Notes: Pan gasket contains [21] bolt holes.
Fits: Allison AT540 Series Transmissions (RWD)
Replaces: GMC 6884270
Length: 11 3/4 (298.5)
Width: 6 1/2 (165.1)
O-Ring: [1] Included
O. Gskt: G1973
Pan Gasket: G1972
Related To: 19992 (Different Media)

18245

Transmission Filter



Notes: Pan gasket contains [19] bolt holes.
Fits: Jeep with AW4 Transmission (RWD)
Replaces: Chrysler 83504032
Length: 9 11/16 (246.1)
Width: 5 1/8 (130.2)
Height: 25/32 (19.8)
Pan Gasket: [1] Included

18264

Transmission Filter



Notes: Pan gasket contains [20] bolt holes.
Fits: Ford Automotive, Light-Duty Trucks, Vans with E40D, 4R100 Transmissions (2WD, RWD, Shallow Pan)
Replaces: Ford YC3Z-7A098-AA
Length: 11 1/2 (292.1)
Width: 6 29/32 (175.4)
Height: 4 3/16 (106.4)
Pan Gasket: [1] Included

18265

Transmission Filter



Notes: Pan gasket contains [20] bolt holes.
Contains: [1] Rubber Neck Seal
Fits: Ford Automotive, Light-Duty Trucks, Vans with E40D, 4R100 Transmissions (4WD, RWD, Deep Pan)
Replaces: Ford YC3Z-7A098-BA
Length: 11 15/32 (291.3)
Width: 6 29/32 (175.4)
Height: 4 3/16 (106.4)
Pan Gasket: [1] Included

18267

Transmission Filter



Notes: Pan gasket contains [20] bolt holes.
Fits: Ford, Mazda Automotive with 4F27E, J39A Transmissions (FWD, 4 Spd. with Overdrive)
Replaces: Ford XS4Z-7A098-AB; Mazda FN01-21-500
Length: 7 (177.8)
Width: 4 29/32 (124.6)
Height: 2 1/16 (52.4)
Pan Gasket: [1] Included

19593

Transmission Filter



Notes: Pan gasket contains [16] bolt holes.
Contains: [1] Plastic Neck Seal
Fits: 1980-96 Buick, Oldsmobile, 1982-88 Cadillac, 1980-2001 Chevrolet, Pontiac Automotive with 3T40 (TH125C) Transmissions (FWD, 3 Spd.)
Replaces: GMC 8634223
Length: 11 3/8 (288.9)
Width: 5 13/16 (147.6)
Height: 1 7/8 (47.6)
Pan Gasket: [1] Included

19739

Transmission Filter

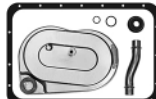

Notes: Pan gasket contains [21] bolt holes.
Contains: [1] 7 Inch Outlet Tube
Fits: Allison MT640, MT650 Series Transmissions (RWD, Deep Pan)
Replaces: Allison 29502302; GMC 6834831
Length: 12 5/8 (320.7)
Width: 8 19/32 (218.3)
Height: 1 1/4 (31.8)
O-Ring: [2] Included
O. Gskt: G1973 (Fiber Gasket)
Grommets: [1] Attached
Pan Gasket: G1972
Related To: 19992 (Shallow Pan)

Measurements Are Shown In Inches And (Millimeters)



WARNING: These products can expose you to chemicals, including Diisononyl Phthalate, Carbon black extracts, Nickel, 1,3 Butadiene, Ethylene Oxide, Epichlorohydrin, which are known to the State of California to cause cancer, and Bisphenol, Ethylene Glycol, Ethylene Oxide, 1,3 Butadiene, Epichlorohydrin, which are known to the State of California to cause birth defects or other reproductive harm. For more information go to www.P65Warnings.ca.gov.

19828

Transmission Filter



Notes: Pan gasket contains [17] bolt holes.
Contains: [1] Filter-to-Valve Metal Body Gasket
Fits: Ford Automotive, Light-Duty Trucks, Vans with C-6 Transmission (Late, 2WD, RWD, Shallow Pan, Aluminum Case)
Replaces: Ford D5AZ-7A098-BA
Length: 9 3/16 (233.4)
Width: 6 13/16 (173.0)
F. Gskt: [1] Included
Pan Gasket: [1] Included

19992

Transmission Filter



Notes: Pan gasket contains [21] bolt holes.
Fits: Allison AT540 Series Transmissions (RWD, Mesh Screen, Shallow Pan)
Replaces: Allison 29503617; GMC 6837428
Length: 11 3/4 (298.5)
Width: 6 1/2 (165.1)
O-Ring: [1] Included
Pan Gasket: G1972
Related To: 18236 (Different Media) 19739 (Deep Pan)

19996

Transmission Filter



Notes: Pan gasket contains [19] bolt holes.
Fits: Lexus, Toyota Automotive, Light-Duty Trucks all with A343F Transmission
Replaces: Toyota 35330-60030
Length: 12 (304.8)
Width: 5 5/16 (134.9)
Height: 2 3/32 (53.2)
Pan Gasket: [1] Included

19999

Transmission Filter Kit



Notes: Pan gasket contains [15] bolt holes.
Contains: [1] Transmission Filter [1] Spin-on Spin-on has Anti-Drainback Valve
Fits: 2007 Chrysler 300C SRT8, 2007-09 Aspen, 2000-11 Dodge Dakota, 2000-09 Durango, 2002-10 Jeep Grand Cherokee, Liberty, 2004 TJ, Wrangler, 2007 Mitsubishi Ranger with 45RFE, 55RFE Transmissions (2WD, RWD, Multi-Spd.with Overdrive)
Replaces: Chrysler 4799662, 4800029AA
Spin-on
Thread: M20 x 1.5
O.D.: 2 11/16 (68.3)
Height: 4 (101.6)
I.Gskt: [1] Included
Pan-Type
Length 11 11/16 (296.9)
Width 6 3/32 (154.8)
Height 4 7/32 (107.2)
O-Ring [1] Grommet, [1] Pan Gasket
Pan Gasket: [1] Included

20000

Transmission Filter Kit



Notes: Pan gasket contains [15] bolt holes.
Contains: [1] Transmission Filter [1] Spin-on Spin-on has Anti-Drainback Valve
Fits: 2007 Chrysler 300C SRT8, 2007-09 Aspen, 2000-11 Dodge Dakota, 2000-09 Durango, 2001-10 Jeep Grand Cherokee, 2002-07 Liberty, 2004 TJ, Wrangler, 2006-07 Mitsubishi Raider with 45RFE, 55RFE Transmission
Replaces: Chrysler 4799507, 4799662
Spin-on
Thread: M20 x 1.5
O.D.: 2 11/16 (68.3)
Height: 4 5/8 (101.6)
I.Gskt: [1] Included
Pan Gasket: [1] Included
Pan-Type
Width 5 19/32 (142.1)
Length 11 11/16 (296.9)
Height 4 5/8 (117.5)
O-Ring [1] Grommet, [1] Pan Gasket

20001

Transmission Filter



Notes: Pan gasket contains [20] bolt holes.
Fits: 1998-2009 Nissan Frontier, 2009 Suzuki Equator with RL4R01A Transmission (4 Spd.)
Replaces: Nissan 31728-48X01
Length: 8 27/32 (224.6)
Width: 6 17/32 (165.9)
Height: 1 27/32 (46.8)
O-Ring: [1] Included
Pan Gasket: [1] Included

20002

Transmission Filter



Fits: Ford, Lincoln, Mercury Light-Duty Trucks all with 5R55W Transmission
Replaces: Motorcraft FT140
Length: 13 13/32 (340.5)
Width: 6 21/32 (169.1)
Height: 3 7/16 (87.3)

20003

Transmission Filter



Fits: 2002-06 Chevrolet Avalanche, 2001-11 Silverado, GMC Sierra Series Light-Duty Trucks, 2001-06 Chevrolet Suburban, GMC Yukon, 2001, 2003 Chevrolet Tahoe, 2006 Hummer H1 with LCT 1000, 2000, 2400 Series
Replaces: Allison 29537966
Length: 9 7/16 (239.7)
Width: 6 13/32 (162.7)
Height: 5 1/8 (130.2)
Related To: 20017 (with Pan Gasket)

20004

Transmission Filter



Fits: 2002-06 Chevrolet Avalanche, 2001-11 Silverado, GMC Sierra Series Light-Duty Trucks, 2001-06 Chevrolet Suburban, GMC Yukon, 2001, 2003 Chevrolet Tahoe, 2006 Hummer H1 with LCT 1000, 2000, 2400 Series
Replaces: Allison 29537965
Length: 9 7/16 (239.7)
Width: 6 13/32 (162.7)
Height: 4 21/32 (118.3)
Related To: 20016 (with Pan Gasket)

Measurements Are Shown In Inches And (Millimeters)

WARNING: These products can expose you to chemicals, including Diisononyl Phthalate, Carbon black extracts, Nickel, 1,3 Butadiene, Ethylene Oxide, Epichlorohydrin, which are known to the State of California to cause cancer, and Bisphenol, Ethylene Glycol, Ethylene Oxide, 1,3 Butadiene, Epichlorohydrin, which are known to the State of California to cause birth defects or other reproductive harm. For more information go to www.P65Warnings.ca.gov.

20005

Transmission Filter



Contains: [1] Plastic Neck Seal
Fits: Ford E Series Vans, F Series Super Duty Pickups
Replaces: Ford 3C3P-7G186-AF, 3C3Z-7A098-AA; Motorcraft FT144
Length: 11 7/16 (290.5)
Width: 4 1/16 (103.2)
Height: 6 3/32 (154.8)

20013

Transmission Filter



Notes: Pan gasket contains [20] bolt holes.
Fits: 2000-04, 2006 Mitsubishi Montero, 2003-04 Montero Sport with AW30-40LE Transmission (RWD, 4 Spd.)
Replaces: Mitsubishi MR528836
Length: 11 19/32 (294.5)
Width: 5 15/16 (150.8)
Height: 1 3/4 (44.5)
Pan Gasket: [1] Included

20008

Transmission Filter



Notes: Pan gasket contains [18] bolt holes.
Fits: Lexus, Toyota Automotive
Replaces: Toyota 35330-08010
Length: 7 3/32 (180.2)
Width: 6 19/32 (167.5)
Height: 1 3/16 (30.2)
O-Ring: [1] Included
Pan Gasket: [1] Included

20014

Transmission Filter



Notes: Pan gasket contains [20] bolt holes.
CAUTION: Can only be used with 2 1/4 In. pan.
Fits: 1991-2011 Buick, Chevrolet, 1991-95 Cadillac, 1991-2004 Oldsmobile, 1992-09 Pontiac, 2005-09 Saturn Automotive with 4T60-E Electronic Transmissions (FWD, 4 Spd.)
Replaces: Wix 58837
Length: 10 19/32 (269.1)
Width: 6 13/16 (173.0)
Height: 2 5/32 (54.8)
Pan Gasket: [1] Included
Related To: 18022 (without Pan Gasket)

20009

Transmission Filter



Notes: Pan gasket contains [19] bolt holes.
Fits: Toyota 4Runner, Tundra
Replaces: Toyota 35330-30020
Length: 8 1/32 (204.0)
Width: 10 5/8 (269.9)
Height: 13/16 (20.6)
Pan Gasket: [1] Included

20015

Transmission Filter



Notes: Pan gasket contains [18] bolt holes.
Fits: Lexus, Scion, Toyota Automotive, Light-Duty Trucks
Replaces: Toyota 35330-06010; 35330-0W010
Length: 7 19/32 (192.9)
Width: 7 1/32 (178.6)
Height: 1 5/8 (41.3)
O-Ring: [1] Included
Pan Gasket: [1] Included

20010

Transmission Filter



Notes: Pan gasket contains [13] bolt holes.
Fits: Hyundai Elantra, Accent
Replaces: Hyundai 46321-22731
Length: 7 1/16 (179.4)
Width: 6 15/16 (176.2)
Height: 21/32 (16.7)
Pan Gasket: [1] Included

20016

Transmission Filter



Notes: Pan gasket contains [12] bolt holes.
Contains: Rubber Neck Seal
Fits: 2002-06 Chevrolet Avalanche, 2001-on Silverado, GMC Sierra Light-Duty Trucks; 2001-06 Chevrolet Suburban, GMC Yukon; 2006 Hummer H1 with 2400 Series Transmissions (Shallow Pan)
Replaces: Allison 29537965; General Motors 29537965
Length: 9 7/16 (239.7)
Width: 6 13/32 (162.7)
Height: 4 21/32 (118.3)
Pan Gasket: [1] Included
Related To: 20004 (without Pan Gasket)

20011

Transmission Filter



Notes: Pan gasket contains [13] bolt holes.
Fits: 2005 Chrysler 300C, 2005-10 300; 2004-11 Dodge Dakota, 2003-10 Jeep Liberty, 2004-06 TJ, 2004-09 Wrangler; 2011-on Dodge Pickups, 2006-10 Charger, 2006-09 Durango; 2006-on Mitsubishi Raider
Replaces: Chrysler 52852913AB
Length: 7 1/4 (184.2)
Width: 6 7/8 (174.6)
Height: 1 7/16 (36.5)
O-Ring: [1] Included
Pan Gasket: [1] Included

20017

Transmission Filter

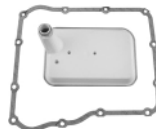

Notes: Pan gasket contains [12] bolt holes.
Contains: Rubber Neck Seal
Fits: 2002-06 Chevrolet Avalanche, 2001-on Silverado, GMC Sierra Light-Duty Trucks; 2001-06 Chevrolet Suburban, GMC Yukon; 2006 Hummer H1 with 2400 Series Transmissions (Deep Pan)
Replaces: Allison 29537966; General Motors 29537966
Length: 9 7/16 (239.7)
Width: 6 13/32 (162.7)
Height: 4 29/32 (124.6)
Pan Gasket: [1] Included
Related To: 20003 (without Pan Gasket)

20012

Transmission Filter



Notes: Pan gasket contains [20] bolt holes.
Fits: 1998-2001 Mitsubishi Montero, 1999-2002 Montero Sport with V5A517 Transmission (FWD, 5 Spd.)
Replaces: Mitsubishi MR357710
Length: 10 7/8 (276.2)
Width: 5 15/16 (150.8)
Height: 1 3/4 (44.5)
Pan Gasket: [1] Included

Measurements Are Shown In Inches And (Millimeters)



WARNING: These products can expose you to chemicals, including Diisononyl Phthalate, Carbon black extracts, Nickel, 1,3 Butadiene, Ethylene Oxide, Epichlorohydrin, which are known to the State of California to cause cancer, and Bisphenol, Ethylene Glycol, Ethylene Oxide, 1,3 Butadiene, Epichlorohydrin, which are known to the State of California to cause birth defects or other reproductive harm. For more information go to www.P65Warnings.ca.gov.

20019

Transmission Filter



Notes: Pan gasket contains [21] bolt holes.
Contains: Rubber Neck Seal
Fits: 2008-on Ford Expedition, Expedition EL, 2008 Explorer, Mercury Mountaineer
Replaces: Ford 7L1Z-7A098-A; Motorcraft FT171; Wix 58099
Length: 9 7/8 (250.8)
Width: 9 1/16 (230.2)
Height: 3 3/4 (95.3)
Pan Gasket: [1] Included

20025

Transmission Filter



Fits: 2008-10 Dodge Light-Duty Trucks; 2011-14 Ram Light-Duty Trucks, 4500HD, 5500HD Chassis Cab; 2008 Sterling Bullet all with 6-408 (6.7L) FI Turbo Diesel Engine with 6 Speed 68 RFE Transmission
Replaces: Chrysler 68019688AA
Length: 9 9/16 (242.9)
Width: 7 3/4 (196.9)
Height: 2 23/32 (69.1)
Grommets: [1] Attached

20020

Transmission Filter



Notes: Pan gasket contains [16] bolt holes.
Contains: Plastic Neck Seal
Fits: 2004-12 Chevrolet Colorado, GMC Canyon; 2009 GMC Envoy, Envoy Denali; 2006-10 Hummer H3, H3 SUT; 2006-08 Isuzu
Replaces: General Motors 24225323; Isuzu 8-24225-323-6
Length: 9 7/16 (239.7)
Width: 6 3/8 (161.9)
Height: 4 23/32 (119.9)
Pan Gasket: [1] Included

BW21000

Coolant Spin-on without Chemicals



Fits: Long Life Used with Extended Service Coolant.
Replaces: Donaldson DBC4086; Fleetguard WF2130
Thread: M16 x 1.5
O.D.: 3 11/16 (93.7)
Height: 5 7/16 (138.1)
I.Gskt: [1] Included

20021

Transmission Filter



Contains: [1] Rubber Neck Seal
Fits: Blue Bird Micro Bird Buses, Collins Buses, Ford F53 Motorhome Chassis, Light-Duty Trucks and Vans, IHC City Star CF500, CF600 Trucks all with 5R110W-HI/Torque Transmission
Replaces: Ford 8C3Z-7A098-D; Motorcraft FT180
Length: 11 17/32 (292.9)
Width: 4 11/32 (110.3)
Height: 6 1/4 (158.8)
A. Gskt: [1] Attached

PT23000

Hydraulic Element with Bail Handle



Fits: FBO Hydraulic Systems
Replaces: FBO CR6001; MP Filtri MF4003P25NB; Donaldson P171576
O.D.: 5 1/8 (130.2)
I.D.: 2 1/2 (63.5) One End
Height: 10 3/16 (258.8)
I.Gskt: [1] Included
Spring: [1] Included

20022

Transmission Filter



Notes: Pan gasket contains [18] bolt holes.
Contains: [1] Metal Neck Seal
Fits: Cadillac; Chevrolet Light-Duty Trucks; GMC Sierra Series Light-Duty Trucks
Replaces: General Motors 24236933
Length: 8 3/4 (222.3)
Width: 6 1/2 (165.1)
Height: 6 5/16 (160.3)
Pan Gasket: [1] Included

PT23001

Hydraulic Element with Bail Handle



Fits: MP Filtri Hydraulic Systems
Replaces: MP Filtri MF4003P10NB
O.D.: 5 1/8 (130.2)
I.D.: 2 9/16 (65.1) One End
Height: 10 3/16 (258.8)
I.Gskt: [1] Included
Spring: [1] Included

20023

Transmission Filter



Notes: Pan gasket contains [20] bolt holes.
Fits: Lexus, Toyota Light-Duty Trucks
Replaces: Toyota 35330-60050
Length: 10 3/16 (258.8)
Width: 6 3/16 (157.2)
Height: 2 3/32 (53.2)
Pan Gasket: [1] Included

PT23002

Hydraulic Element



Fits: Mahle Applications
Replaces: Mahle PI1015MIC25; Filtrec DMD0015D20B
O.D.: 3 1/4 (82.6)
I.D.: 1 7/8 (47.6) One End
Height: 5 9/16 (141.2)

20024

Transmission Filter



Notes: Pan gasket contains [12] bolt holes.
Contains: [1] Metal Neck Seal
Replaces: Chrysler 5078555AA
Length: 7 3/32 (180.2)
Width: 6 3/16 (157.2)
Height: 3 31/32 (100.8)
Pan Gasket: [1] Included

PT23003

Hydraulic Element with Bail Handle



Fits: FBO Hydraulic Systems
Replaces: FBO CR2501
O.D.: 5 1/8 (130.2)
I.D.: 2 (50.8) One End
Height: 6 (152.4)
I.Gskt: [1] Included
Spring: [1] Included

Measurements Are Shown In Inches And (Millimeters)

WARNING: These products can expose you to chemicals, including Diisononyl Phthalate, Carbon black extracts, Nickel, 1,3 Butadiene, Ethylene Oxide, Epichlorohydrin, which are known to the State of California to cause cancer, and Bisphenol, Ethylene Glycol, Ethylene Oxide, 1,3 Butadiene, Epichlorohydrin, which are known to the State of California to cause birth defects or other reproductive harm. For more information go to www.P65Warnings.ca.gov.

PT23004



Hydraulic Element with Bail Handle
Fits: Eppensteiner Hydraulic Systems
Replaces: Eppensteiner 6300P10S0000
O.D.: 3 9/16 (90.5)
I.D.: 4 1/4 (108.0) One End
Height: 15 3/8 (390.5)
I.Gskt: [1] Included

PT23010



Hydraulic Element
Fits: Liebherr Applications
Replaces: Liebherr 10044538
O.D.: 3 1/2 (88.9)
I.D.: 1 9/16 (39.7)
Height: 12 15/16 (328.6)
O-Ring: [2] Attached

PT23005



Hydraulic Element with Bail Handle
Fits: MP Filtri Hydraulic Systems
Replaces: MP Filtri MF1003P25NB
O.D.: 2 11/16 (68.3)
I.D.: 1 9/16 (39.7)
Height: 8 1/2 (215.9)
I.Gskt: [1] Included
Spring: [1] Included

PT23011



Hydraulic Element
Contains: 3-11 Inch BSP Threaded Stud
Fits: U.C.C. Hydraulic Systems
Replaces: U.C.C. UCSE1221
O.D.: 5 13/16 (147.6)
I.D.: 3 1/2 (88.9)
Height: 10 11/16 (271.5)
I.Gskt: [2] Included

PT23006



Hydraulic Element
Fits: Argo Hydraulic Systems
Replaces: Argo P3052051
O.D.: 1 13/16 (46.0)
I.D.: 13/16 (20.6) One End
Height: 7 7/8 (200.0)
I.Gskt: [1] Included

PT23012



Hydraulic Element
Fits: MP Filtri Hydraulic Systems
Replaces: MP Filtri CU250M90N
O.D.: 3 29/32 (99.2)
I.D.: 2 1/16 (52.4)
Height: 8 3/16 (208.0)
I.Gskt: [2] Included

PT23007



Hydraulic Element
Fits: Argo Hydraulic Systems
Replaces: Argo P3052052
O.D.: 1 13/16 (46.0)
I.D.: 13/16 (20.6) One End
Height: 7 7/8 (200.0)
I.Gskt: [1] Included

PT23013



Hydraulic Element with Bail Handle
Contains: By-Pass Valve
Fits: Donaldson FHK Assemblies
Replaces: Donaldson P171536
O.D.: 3 29/32 (99.2)
I.D.: 1 5/8 (41.3)
Height: 8 1/16 (204.8)
I.Gskt: [1] Included
Spring: [1] Included

PT23008



Hydraulic Element
Fits: Eppensteiner Hydraulic Systems
Replaces: Eppensteiner 1063P10A000P
O.D.: 2 9/32 (57.9)
I.D.: 1 9/32 (32.5)
Height: 6 5/16 (160.3)
I.Gskt: [2] Included

PT23014



Hydraulic Element
Fits: Mahle Applications
Replaces: Mahle PI8530DRG100
O.D.: 3 3/16 (81.0)
I.D.: 1 7/8 (47.6) One End
Height: 10 1/16 (255.6)

PT23009



Hydraulic Element
Fits: Mahle Hydraulic Systems
Replaces: Mahle PL13030RN
O.D.: 2 1/4 (57.2)
I.D.: 1 3/16 (30.2)
Height: 9 3/4 (247.7)
I.Gskt: [2] Included

PT23015



Hydraulic Element
Contains: Stud Thread: 1-11 BSP
Fits: OMT Hydraulic Systems
Replaces: OMT SP86A100GR125
O.D.: 3 29/32 (99.2)
I.D.: 1 5/8 (41.3)
Height: 8 1/16 (204.8)

Measurements Are Shown In Inches And (Millimeters)

! **WARNING:** These products can expose you to chemicals, including Diisononyl Phthalate, Carbon black extracts, Nickel, 1,3 Butadiene, Ethylene Oxide, Epichlorohydrin, which are known to the State of California to cause cancer, and Bisphenol, Ethylene Glycol, Ethylene Oxide, 1,3 Butadiene, Epichlorohydrin, which are known to the State of California to cause birth defects or other reproductive harm. For more information go to www.P65Warnings.ca.gov.

PT23016

Hydraulic Element



Contains: Threaded Stud
Fits: OMT Hydraulic Systems
Replaces: OMT SP86A114GR125
O.D.: 3 1/4 (82.6)
I.D.: 1 5/8 (41.3)
Height: 5 1/2 (139.7)

PT23022

Hydraulic Element



Fits: Mahle Applications
Replaces: Mahle PI8430DRG60;
Filtrec DMD0030B60B
O.D.: 3 3/16 (81.0)
I.D.: 1 7/8 (47.6) One End
Height: 10 1/16 (255.6)

PT23017

Hydraulic Element with Bail Handle



Fits: Donaldson FHK/FSK Assemblies
Replaces: Donaldson P171529
O.D.: 2 3/4 (69.9)
I.D.: 1 5/32 (29.4) One End
Height: 3 5/32 (80.2)
I.Gskt: [1] Included
Spring: [1] Included

PT23023

Hydraulic Element



Fits: Mahle Applications
Replaces: Mahle PI8445DRG60;
Filtrec DMD0045B60B
O.D.: 3 1/4 (82.6)
I.D.: 1 7/8 (47.6) One End
Height: 14 5/8 (371.5)

PT23018

Hydraulic Element



Fits: MP Filtri Hydraulic Assemblies
Replaces: MP Filtri HP0652M60NA
O.D.: 1 25/32 (45.2)
I.D.: 1 (25.4)
Height: 4 15/32 (113.5)
I.Gskt: [1] Included

PT23024

Hydraulic Element



Fits: MP Filtri Hydraulic Assemblies
Replaces: MP Filtri CU250M60N
O.D.: 3 13/32 (86.5)
I.D.: 2 1/8 (54.0)
Height: 8 3/8 (212.7)
I.Gskt: [2] Included

PT23019

Hydraulic Element with Bail Handle



Contains: By-Pass Valve
Fits: MP Filtri Applications
Replaces: MP Filtri MF4003M60NB;
Filtrec R164T60B
O.D.: 5 1/16 (128.6)
I.D.: 2 1/2 (63.5) One End
Height: 10 3/8 (263.5)
O-Ring: [1] Attached
Spring: [1] Included

PT23025

Hydraulic Element



Fits: Eppensteiner Applications
Replaces: Eppensteiner 2225G25A000P;
Filtrec DVD2225B25B
O.D.: 2 7/8 (73.0)
I.D.: 1 9/16 (39.7) One End
Height: 8 13/16 (223.8)
O-Ring: [1] Attached

PT23020

Hydraulic Element



Fits: Mahle Hydraulic Assemblies
Replaces: Mahle PI8330DKG40
O.D.: 3 3/16 (81.0)
I.D.: 1 7/8 (47.6) One End
Height: 10 1/32 (254.8)

PT23026

Hydraulic Element



Fits: MP Filtri Applications
Replaces: MP Filtri HP3202M60NA;
Filtrec D151T60A
O.D.: 3 1/16 (77.8)
I.D.: 1 1/2 (38.1) One End
Height: 9 3/16 (233.4)
O-Ring: [1] Attached

PT23021

Hydraulic Element



Fits: Mahle Hydraulic Assemblies
Replaces: Mahle PI8408DRG60
O.D.: 1 27/32 (46.8)
I.D.: 1 (25.4) One End
Height: 6 25/32 (172.2)

PT23027

Hydraulic Element with Bail Handle



Fits: Parker Hydraulic Assemblies
Replaces: Parker 939893Q
O.D.: 9 1/8 (231.8)
I.D.: 4 1/4 (108.0) One End
Height: 11 (279.4)

Measurements Are Shown In Inches And (Millimeters)

WARNING: These products can expose you to chemicals, including Diisononyl Phthalate, Carbon black extracts, Nickel, 1,3 Butadiene, Ethylene Oxide, Epichlorohydrin, which are known to the State of California to cause cancer, and Bisphenol, Ethylene Glycol, Ethylene Oxide, 1,3 Butadiene, Epichlorohydrin, which are known to the State of California to cause birth defects or other reproductive harm. For more information go to www.P65Warnings.ca.gov.

PT23028-MPG Maximum Performance Glass Hydraulic Element



Fits: Hydac Applications
Replaces: Hydac 240D010BHHC
O.D.: 2 11/16 (68.3)
I.D.: 1 5/16 (33.3) One End
Height: 6 13/16 (173.0)
O-Ring: [1] Attached

PT23034-MPG Maximum Performance Glass Hydraulic Element



Fits: Parker Hydraulic Assemblies
Replaces: Parker G01068
O.D.: 3 3/8 (85.7)
I.D.: 2 1/8 (54.0) One End
Height: 7 3/4 (196.9)
I.Gskt: [1] Included

PT23029-MPG Maximum Performance Glass Hydraulic Element



Fits: MP Filtri Applications
Replaces: MP Filtri HP3202A10NA
O.D.: 3 1/16 (77.8)
I.D.: 1 1/2 (38.1) One End
Height: 9 1/4 (235.0)
O-Ring: [1] Attached

PT23035-MPG Maximum Performance Glass Hydraulic Element with Bail Handle



Fits: MP Filtri Hydraulic Assemblies
Replaces: MP Filtri 1003A25HB
O.D.: 2 5/8 (66.7)
I.D.: 1 3/8 (34.9) One End
Height: 8 1/8 (206.4)
I.Gskt: [1] Included
Spring: [1] Included

PT23030-MPG Maximum Performance Glass Hydraulic Element



Fits: Pall Applications
Replaces: Pall HC8800FKS16H
O.D.: 3 3/8 (85.7)
I.D.: 1 15/16 (49.2) One End
Height: 16 7/8 (428.6)
O-Ring: [1] Attached

PT23036-MPG Maximum Performance Glass Hydraulic Element



Fits: MP Filtri Hydraulic Assemblies
Replaces: MP Filtri HP0371A10A
O.D.: 1 3/8 (34.9)
I.D.: 1 1/4 (31.8)
Height: 3 1/2 (88.9)
I.Gskt: [1] Included

PT23031-MPG Maximum Performance Glass Hydraulic Element



Fits: Hydac Hydraulic Assemblies
Replaces: Hydac 60103D10BN
O.D.: 2 1/8 (54.0)
I.D.: 25/32 (19.8)
Height: 2 5/8 (66.7)
A. Gskt: [1] Attached
F. Gskt: [1] Included

PT23037-MPG Maximum Performance Glass Hydraulic Element



Fits: Hydac Hydraulic Assemblies
Replaces: Hydac 60D005BNHC
O.D.: 1 27/32 (46.8)
I.D.: 7/8 (22.2) One End
Height: 3 5/16 (84.1)
I.Gskt: [1] Included

PT23032-MPG Maximum Performance Glass Hydraulic Element



Fits: Argo Equipment
Replaces: Argo V3060706
O.D.: 2 1/8 (54.0)
I.D.: 1 1/8 (28.6) One End
Height: 2 23/32 (69.1)
I.Gskt: [1] Included

PT23038-MPG Maximum Performance Glass Hydraulic Element



Fits: Hydac Hydraulic Assemblies
Replaces: Hydac 110D005BNHC
O.D.: 13/16 (20.6)
I.D.: 1 13/16 (46.0) One End
Height: 5 7/8 (149.2)
I.Gskt: [1] Included

PT23033-MPG Maximum Performance Glass Hydraulic Element



Fits: Vogele Hydraulic Assemblies
Replaces: Vogele 9624541001
O.D.: 4 1/2 (114.3)
I.D.: 2 23/32 (69.1)
Height: 15 23/32 (399.3)
I.Gskt: [2] Included

PT23039-MPG Maximum Performance Glass Hydraulic Element with Bail Handle



Contains: By-Pass Valve
Fits: Hydac Hydraulic Assemblies
Replaces: Hydac 110R010BNHC
O.D.: 2 (50.8)
I.D.: 13/16 (20.6) One End
Height: 6 3/8 (161.9)
I.Gskt: [1] Included

Measurements Are Shown In Inches And (Millimeters)

WARNING: These products can expose you to chemicals, including Diisononyl Phthalate, Carbon black extracts, Nickel, 1,3 Butadiene, Ethylene Oxide, Epichlorohydrin, which are known to the State of California to cause cancer, and Bisphenol, Ethylene Glycol, Ethylene Oxide, 1,3 Butadiene, Epichlorohydrin, which are known to the State of California to cause birth defects or other reproductive harm. For more information go to www.P65Warnings.ca.gov.

PT23040-MPG Maximum Performance Glass Hydraulic Element



Fits: Mahle Applications
Replaces: Mahle PI3115SM10
O.D.: 3 3/16 (81.0)
I.D.: 1 7/8 (47.6) One End
Height: 5 5/8 (142.9)

PT23046-MPG Maximum Performance Glass Hydraulic Element



Fits: Hydac Hydraulic Assemblies
Replaces: Hydac 330D020BNHC
O.D.: 3 1/2 (88.9)
I.D.: 1 15/16 (49.2)
Height: 6 1/4 (158.8)
I.Gskt: [1] Included

PT23041-MPG Maximum Performance Glass Hydraulic Element with Bail Handle



Fits: MP Filtri Hydraulic Assemblies
Replaces: MP Filtri MF180A25HB, Filtrec WG440
O.D.: 4 (101.6)
I.D.: 1 7/16 (36.5) One End
Height: 8 1/2 (215.9)
I.Gskt: [1] Included
Spring: [1] Included

PT23047-MPG Maximum Performance Glass Hydraulic Element



Fits: MP Filtri Hydraulic Assemblies
Replaces: MP Filtri HP1352A10NA
O.D.: 2 1/8 (54.0)
I.D.: 1 1/8 (28.6) One End
Height: 9 1/8 (231.8)
I.Gskt: [1] Included

PT23042-MPG Maximum Performance Glass Hydraulic Element



Fits: Tamrock Equipment
Replaces: Tamrock 4004080
O.D.: 2 13/16 (71.4)
I.D.: 1 13/16 (46.0) One End
Height: 13 3/4 (349.3)

PT23048-MPG Maximum Performance Glass Hydraulic Element with Bail Handle



Fits: Donaldson Housings
Replaces: Donaldson P171561; Filtrec R160G10B
O.D.: 5 1/8 (130.2)
I.D.: 2 9/16 (65.1) One End
Height: 7 7/8 (200.0)
O-Ring: [1] Attached
Spring: [1] Included

PT23043-MPG Maximum Performance Glass Hydraulic Element



Fits: Hydac Hydraulic Assemblies
Replaces: Hydac 10D010BHHC
O.D.: 1 13/16 (46.0)
I.D.: 13/16 (20.6)
Height: 6 (152.4)
I.Gskt: [1] Included

PT23049-MPG Maximum Performance Glass Hydraulic Element



Fits: Mahle Applications
Replaces: Mahle PI4145SM25; Filtrec DMD0045E20B
O.D.: 3 1/4 (82.6)
I.D.: 1 7/8 (47.6) One End
Height: 14 9/16 (369.9)

PT23044-MPG Maximum Performance Glass Hydraulic Element



Fits: MP Filtri Hydraulic Assemblies
Replaces: MP Filtri CU250A25N
O.D.: 3 29/32 (99.2)
I.D.: 2 1/16 (52.4)
Height: 8 3/8 (212.7)
I.Gskt: [2] Included

PT23050-MPG Maximum Performance Glass Hydraulic Element



Fits: MP Filtri Applications
Replaces: MP Filtri HP3203A10NA; Filtrec D152G10A
O.D.: 3 1/16 (77.8)
I.D.: 1 9/16 (39.7) One End
Height: 14 13/16 (376.2)
O-Ring: [1] Attached

PT23045-MPG Maximum Performance Glass Hydraulic Element



Fits: Hydac Hydraulic Assemblies
Replaces: Hydac 330D010BNHC
O.D.: 3 1/2 (88.9)
I.D.: 1 15/16 (49.2)
Height: 6 5/16 (160.3)
I.Gskt: [1] Included













PT23051-MPG Maximum Performance Glass Hydraulic Element



Fits: Tamrock Equipment
Replaces: Tamrock 400479
O.D.: 7 7/8 (200.0)
I.D.: 1/2 (12.7) & 6 5/8 (168.3)
Height: 26 (660.4)

Measurements Are Shown In Inches And (Millimeters)

WARNING: These products can expose you to chemicals, including Diisononyl Phthalate, Carbon black extracts, Nickel, 1,3 Butadiene, Ethylene Oxide, Epichlorohydrin, which are known to the State of California to cause cancer, and Bisphenol, Ethylene Glycol, Ethylene Oxide, 1,3 Butadiene, Epichlorohydrin, which are known to the State of California to cause birth defects or other reproductive harm. For more information go to www.P65Warnings.ca.gov.

<p>PT23052-MPG Maximum Performance Glass Hydraulic Element</p>  <p>Fits: Hydac Hydraulic Assemblies Replaces: Hydac 660D010BHHC O.D.: 3 3/8 (85.7) I.D.: 1 7/8 (47.6) Height: 13 (330.2) I.Gskt: [1] Included</p>	<p>PT23058-MPG Maximum Performance Glass Hydraulic Element</p>  <p>Fits: Parker Hydraulic Assemblies Replaces: Parker G02832 O.D.: 1 27/32 (46.8) I.D.: 1 (25.4) One End Height: 3 23/32 (94.5)</p>
<p>PT23053-MPG Maximum Performance Glass Hydraulic Element</p>  <p>Fits: Eppensteiner Hydraulic Assemblies Replaces: Eppensteiner 2460H10SLC00P O.D.: 3 1/8 (79.4) I.D.: 1 1/2 (38.1) Height: 15 (381.0) I.Gskt: [1] Included</p>	<p>PT23059-MPG Maximum Performance Glass Hydraulic Element</p>  <p>Fits: Kalmer Applications Replaces: Kalmer 9239440053 O.D.: 2 5/8 (66.7) I.D.: 1 1/8 (28.6) Height: 9 5/8 (244.5) I.Gskt: [1] Included F. Gskt: [1] Included, [1] Backup Ring</p>
<p>PT23054-MPG Maximum Performance Glass Hydraulic Element</p>  <p>Fits: Eppensteiner Applications Replaces: Eppensteiner 2460H10SLA000P O.D.: 2 7/8 (73.0) I.D.: 1 9/16 (39.7) One End Height: 14 3/4 (374.7) O-Ring: [1] Attached</p>	<p>PT23060-MPG Maximum Performance Glass Hydraulic Element with Bail Handle</p>  <p>Fits: Hydac Applications Replaces: Hydac 240R010BNHC O.D.: 2 3/4 (69.9) I.D.: 1 5/8 (41.3) One End Height: 7 11/16 (195.3) O-Ring: [1] Attached</p>
<p>PT23055-MPG Maximum Performance Glass Hydraulic Element</p>  <p>Fits: Eppensteiner Applications Replaces: Eppensteiner 232H10XLA00P O.D.: 1 5/8 (41.3) I.D.: 5/8 (15.9) One End Height: 3 1/8 (79.4) O-Ring: [1] Attached</p>	<p>PT23061-MPG Maximum Performance Glass Hydraulic Element with Bail Handle</p>  <p>Fits: Hydac Applications Replaces: Hydac 330R010BNHC O.D.: 3 3/8 (85.7) I.D.: 1 7/8 (47.6) One End Height: 7 7/8 (200.0)</p>
<p>PT23056-MPG Maximum Performance Glass Hydraulic Element</p>  <p>Fits: Eppensteiner Applications Replaces: Eppensteiner 225H10XLC000P O.D.: 3 (76.2) I.D.: 1 9/16 (39.7) One End Height: 9 1/8 (231.8) O-Ring: [1] Attached</p>	<p>PT23062-MPG Maximum Performance Glass Hydraulic Element with Bail Handle</p>  <p>Fits: Hydac Applications Replaces: Hydac 1300R010BNHC; Filtrec RHR1300610B O.D.: 5 5/16 (134.9) I.D.: 3 3/4 (95.3) One End Height: 19 7/16 (493.7) I.Gskt: [1] Included</p>
<p>PT23057-MPG Maximum Performance Glass Hydraulic Element</p>  <p>Fits: Eppensteiner Applications Replaces: Eppensteiner 2460H20LLH000P O.D.: 3 (76.2) I.D.: 1 9/16 (39.7) One End Height: 14 3/4 (374.7) O-Ring: [1] Attached</p>	<p>PT23063-MPG Maximum Performance Glass Hydraulic Element with Bail Handle</p>  <p>Replaces: Donaldson P171544 O.D.: 3 29/32 (99.2) I.D.: 1 5/8 (41.3) One End Height: 9 27/32 (250.0) I.Gskt: [1] Included Spring: [1] Included</p>

Measurements Are Shown In Inches And (Millimeters)

 **WARNING:** These products can expose you to chemicals, including Diisononyl Phthalate, Carbon black extracts, Nickel, 1,3 Butadiene, Ethylene Oxide, Epichlorohydrin, which are known to the State of California to cause cancer, and Bisphenol, Ethylene Glycol, Ethylene Oxide, 1,3 Butadiene, Epichlorohydrin, which are known to the State of California to cause birth defects or other reproductive harm. For more information go to www.P65Warnings.ca.gov.

PT23064-MPG Maximum Performance Glass Hydraulic Element



Fits: MP Filtri Hydraulic Systems
Replaces: MP Filtri HP0372A10A
O.D.: 1 3/8 (34.9)
I.D.: 13/16 (20.6) One End
Height: 7 (177.8)
I.Gskt: [1] Included

PT23070-MPG Maximum Performance Glass Hydraulic Element



Fits: Pall Hydraulic Systems
Replaces: Pall HC2252FKT19H
O.D.: 3 5/8 (92.1)
I.D.: 1 3/4 (44.5) & 2 1/8 (54.0)
Height: 18 7/8 (479.4)
I.Gskt: [1] Included

PT23065-MPG Maximum Performance Glass Hydraulic Element with Bail Handle



Fits: Hydac Applications
Replaces: Hydac 2600R010BNHC
O.D.: 5 1/2 (139.7)
I.D.: 3 3/4 (95.3)
Height: 36 11/16 (931.9)
I.Gskt: [1] Included

PT23071-MPG Maximum Performance Glass Hydraulic Element



Fits: Parker Hydraulic Systems
Replaces: Parker 939905Q
O.D.: 3 (76.2)
I.D.: 1 (25.4)
Height: 5 7/8 (149.2)
I.Gskt: [1] Included

PT23066-MPG Maximum Performance Glass Hydraulic Element



Fits: Hydac Hydraulic Systems
Replaces: Hydac 140D010BNHC
O.D.: 1 13/16 (46.0)
I.D.: 13/16 (20.6) One End
Height: 7 3/8 (187.3)
I.Gskt: [1] Included

PT23072-MPG Maximum Performance Glass Hydraulic Element



Contains: By-Pass Valve
Fits: Eppensteiner Hydraulic Systems
Replaces: Eppensteiner 20330H10SLS004P
O.D.: 4 (101.6)
I.D.: 2 3/8 (60.3) One End
Height: 10 7/8 (276.2)
End Seals: [1] Attached

PT23067-MPG Maximum Performance Glass Hydraulic Element



Fits: Hydac Hydraulic Systems
Replaces: Hydac 140D020BNHC
O.D.: 1 13/16 (46.0)
I.D.: 1 1/8 (28.6) One End
Height: 7 3/8 (187.3)
I.Gskt: [1] Included

PT23073-MPG Maximum Performance Glass Hydraulic Element



Fits: MP Filtri Hydraulic Systems
Replaces: MP Filtri HP0201A10HA
O.D.: 1 1/8 (28.6)
I.D.: 21/32 (16.7)
Height: 3 15/16 (100.0)
I.Gskt: [1] Included

PT23068-MPG Maximum Performance Glass Hydraulic Element



Fits: Eppensteiner Applications
Replaces: Eppensteiner 20045H10XLA000P, 20045H10SLA000P; Filtrac DVD20045E10B
O.D.: 3 1/8 (79.4)
I.D.: 1 5/8 (41.3) One End
Height: 15 11/16 (398.5)
O-Ring: [1] Attached

PT23074-MPG Maximum Performance Glass Hydraulic Element



Fits: Pall Hydraulic Systems
Replaces: Pall HC9021FKS4H
O.D.: 1 3/4 (44.5)
I.D.: 1 1/8 (28.6)
Height: 4 1/2 (114.3)
I.Gskt: [1] Included

PT23069-MPG Maximum Performance Glass Hydraulic Element



Fits: Parker Applications
Replaces: Parker 939903Q
O.D.: 1 13/16 (46.0)
I.D.: 5/8 (15.9) One End
Height: 1 5/16 (33.3)
O-Ring: [1] Attached

PT23075-MPG Maximum Performance Glass Hydraulic Element



Fits: MP Filtri Hydraulic Systems
Replaces: MP Filtri HP1352A10HA
O.D.: 2 (50.8)
I.D.: 1 1/4 (31.8) One End
Height: 9 1/4 (235.0)
I.Gskt: [1] Included

Measurements Are Shown In Inches And (Millimeters)

WARNING: These products can expose you to chemicals, including Diisononyl Phthalate, Carbon black extracts, Nickel, 1,3 Butadiene, Ethylene Oxide, Epichlorohydrin, which are known to the State of California to cause cancer, and Bisphenol, Ethylene Glycol, Ethylene Oxide, 1,3 Butadiene, Epichlorohydrin, which are known to the State of California to cause birth defects or other reproductive harm. For more information go to www.P65Warnings.ca.gov.

PT23076-MPG Maximum Performance Glass Hydraulic Element



Fits: Pall Hydraulic Systems
Replaces: Pall HC9100FKS8Z
O.D.: 2 3/4 (69.9)
I.D.: 1 5/16 (33.3)
Height: 8 1/4 (209.6)
I.Gskt: [1] Included

PT23082-MPG Maximum Performance Glass Hydraulic Element



Fits: Argo Hydraulic Systems
Replaces: Argo V3052006
O.D.: 1 3/4 (44.5)
I.D.: 3/4 (19.1) One End
Height: 7 13/16 (198.4)
O-Ring: [1] Attached

PT23077-MPG Maximum Performance Glass Hydraulic Element



Fits: MP Filtri Hydraulic Systems
Replaces: MP Filtri HP0372A06A
O.D.: 1 5/8 (41.3)
I.D.: 13/16 (20.6)
Height: 7 (177.8)
I.Gskt: [1] Included

PT23083-MPG Maximum Performance Glass Hydraulic Element



Fits: Argo Hydraulic Systems
Replaces: Argo V3052008
O.D.: 1 3/4 (44.5)
I.D.: 3/4 (19.1) One End
Height: 7 3/4 (196.9)
O-Ring: [1] Attached

PT23078-MPG Maximum Performance Glass Hydraulic Element



Fits: Parker Hydraulic Systems
Replaces: Parker G01938Q
O.D.: 2 5/8 (66.7)
I.D.: 1 1/8 (28.6)
Height: 9 5/8 (244.5)
O-Ring: [1] Attached

PT23084-MPG Maximum Performance Glass Hydraulic Element



Fits: Argo Hydraulic Systems
Replaces: Argo V3062306
O.D.: 2 1/8 (54.0)
I.D.: 1 1/8 (28.6) One End
Height: 9 1/8 (231.8)
O-Ring: [1] Attached

PT23079-MPG Maximum Performance Glass Hydraulic Element



Fits: Parker Applications
Replaces: Parker G01946
O.D.: 3 9/16 (90.5)
I.D.: 1 7/8 (47.6) One End
Height: 7 7/8 (200.0)
O-Ring: [1] Attached

PT23085-MPG Maximum Performance Glass Hydraulic Element



Fits: Argo Applications
Replaces: Argo V308330; Filtrec D841G10A
O.D.: 3 1/16 (77.8)
I.D.: 1 1/2 (38.1) One End
Height: 9 3/16 (233.4)
O-Ring: [1] Attached

PT23080-MPG Maximum Performance Glass Hydraulic Element



Fits: Parker Applications
Replaces: Parker G04276
O.D.: 3 11/16 (93.7)
I.D.: 1 13/16 (46.0)
Height: 7 15/16 (201.6)
F. Gskt: [1] Included, [1] Backup Ring
O-Ring: [2] Included

PT23086-MPG Maximum Performance Glass Hydraulic Element



Fits: Hydac Hydraulic Systems
Replaces: Hydac 30D010BH3HC
O.D.: 1 1/4 (31.8)
I.D.: 3/8 (9.5) One End
Height: 3 5/8 (92.1)
O-Ring: [1] Attached

PT23081-MPG Maximum Performance Glass Hydraulic Element



Fits: Parker Applications
Replaces: Parker G04284
O.D.: 3 11/16 (93.7)
I.D.: 1 3/4 (44.5)
Height: 12 9/16 (319.1)
F. Gskt: [1] Included, [1] Backup Ring
O-Ring: [2] Included

PT23087-MPG Maximum Performance Glass Hydraulic Element



Fits: Hydac Hydraulic Systems
Replaces: Hydac 35D003BNHC
O.D.: 2 1/4 (57.2)
I.D.: 15/16 (23.8) One End
Height: 2 13/16 (71.4)
O-Ring: [1] Attached

Measurements Are Shown In Inches And (Millimeters)

 **WARNING:** These products can expose you to chemicals, including Diisononyl Phthalate, Carbon black extracts, Nickel, 1,3 Butadiene, Ethylene Oxide, Epichlorohydrin, which are known to the State of California to cause cancer, and Bisphenol, Ethylene Glycol, Ethylene Oxide, 1,3 Butadiene, Epichlorohydrin, which are known to the State of California to cause birth defects or other reproductive harm. For more information go to www.P65Warnings.ca.gov.

PT23088-MPG Maximum Performance Glass Hydraulic Element



Fits: Hydac Hydraulic Systems
Replaces: Hydac 35D010BNHC
O.D.: 2 1/8 (54.0)
I.D.: 15/16 (23.8) One End
Height: 2 3/4 (69.9)
O-Ring: [1] Attached

PT23094-MPG Maximum Performance Glass Hydraulic Element



Fits: Internormen Hydraulic Systems
Replaces: Internormen 1E36010VG30EP
O.D.: 2 5/8 (66.7)
I.D.: 15/16 (23.8) One End
Height: 12 1/8 (308.0)
O-Ring: [1] Attached

PT23089-MPG Maximum Performance Glass Hydraulic Element



Fits: Hydac Hydraulic Systems
Replaces: Hydac 500D010BNHC
O.D.: 3 1/2 (88.9)
I.D.: 1 7/8 (47.6) One End
Height: 10 (254.0)
O-Ring: [1] Attached

PT23095-MPG Maximum Performance Glass Hydraulic Element



Fits: Internormen Hydraulic Systems
Replaces: Internormen 1E9010VG30EP
O.D.: 1 3/4 (44.5)
I.D.: 13/16 (20.6) One End
Height: 6 3/4 (171.5)
O-Ring: [1] Attached

PT23090-MPG Maximum Performance Glass Hydraulic Element



Fits: Hydac Hydraulic Systems
Replaces: Hydac 55D010BNHC
O.D.: 2 1/8 (54.0)
I.D.: 15/16 (23.8) One End
Height: 4 5/8 (117.5)
O-Ring: [1] Attached

PT23096-MPG Maximum Performance Glass Hydraulic Element



Fits: Eppensteiner Hydraulic Systems
Replaces: Eppensteiner 232H10XLC000P
O.D.: 1 13/16 (46.0)
I.D.: 15/16 (23.8) One End
Height: 3 1/8 (79.4)
O-Ring: [1] Attached

PT23091-MPG Maximum Performance Glass Hydraulic Element



Fits: Hydac Hydraulic Systems
Replaces: Hydac 95D010BNHC
O.D.: 2 1/8 (54.0)
I.D.: 15/16 (23.8) One End
Height: 8 1/8 (206.4)
O-Ring: [1] Attached

PT23097-MPG Maximum Performance Glass Hydraulic Element with Bail Handle



Fits: MP Filtri Hydraulic Systems
Replaces: MP Filtri MF0301A10NB
O.D.: 2 (50.8)
I.D.: 15/16 (23.8) One End
Height: 3 (76.2)
I.Gskt: [1] Included
Spring: [1] Included

PT23092-MPG Maximum Performance Glass Hydraulic Element



Fits: Parker Hydraulic Systems
Replaces: Parker 938309Q
O.D.: 2 1/8 (54.0)
I.D.: 15/16 (23.8) One End
Height: 8 1/8 (206.4)
O-Ring: [1] Attached

PT23098-MPG Maximum Performance Glass Hydraulic Element with Bail Handle



Fits: MP Filtri Hydraulic Systems
Replaces: MP Filtri MF1802A10NB
O.D.: 3 7/8 (98.4)
I.D.: 1 1/2 (38.1) One End
Height: 17 1/8 (435.0)
I.Gskt: [1] Included
Spring: [1] Included

PT23093-MPG Maximum Performance Glass Hydraulic Element



Fits: Internormen Applications
Replaces: Internormen 1E24010VG30EP
O.D.: 2 3/8 (60.3)
I.D.: 1 5/16 (33.3)
Height: 9 (228.6)
O-Ring: [1] Attached

PT23099-MPG Maximum Performance Glass Hydraulic Element with Bail Handle



Fits: MP Filtri Applications
Replaces: MP Filtri MF4002A03NB
O.D.: 5 1/16 (128.6)
I.D.: 2 1/2 (63.5) One End
Height: 8 5/16 (211.1)
O-Ring: [1] Attached
Spring: [1] Included

Measurements Are Shown In Inches And (Millimeters)

WARNING: These products can expose you to chemicals, including Diisononyl Phthalate, Carbon black extracts, Nickel, 1,3 Butadiene, Ethylene Oxide, Epichlorohydrin, which are known to the State of California to cause cancer, and Bisphenol, Ethylene Glycol, Ethylene Oxide, 1,3 Butadiene, Epichlorohydrin, which are known to the State of California to cause birth defects or other reproductive harm. For more information go to www.P65Warnings.ca.gov.

PT23100-MPG Maximum Performance Glass Hydraulic Element



Fits: Argo Hydraulic Systems
Replaces: Argo V3051056
O.D.: 1 11/16 (42.9)
I.D.: 3/4 (19.1) One End
Height: 4 1/8 (104.8)
I.Gskt: [1] Included

PT23106-MPG Maximum Performance Glass Hydraulic Element with Bail Handle



Contains: By-Pass Valve
Fits: Hydac Hydraulic Systems
Replaces: Hydac 660R020BNHC
O.D.: 4 1/2 (114.3)
I.D.: 2 11/16 (68.3) One End
Height: 13 1/8 (333.4)
I.Gskt: [1] Included

PT23101-MPG Maximum Performance Glass Hydraulic Element



Fits: Parker Hydraulic Systems
Replaces: Parker 1181289070
O.D.: 4 1/8 (104.8)
I.D.: 1 1/8 (28.6) & 2 13/16 (74.1)
Height: 15 3/4 (400.1)
I.Gskt: [1] Included

PT23107-MPG Maximum Performance Glass Hydraulic Element



Fits: Hydac Hydraulic Systems
Replaces: Hydac 40DN010BNHC
O.D.: 1 3/4 (44.5)
I.D.: 3/4 (19.1)
Height: 3 13/16 (96.8)
I.Gskt: [1] Included

PT23102-MPG Maximum Performance Glass Hydraulic Element with Bail Handle



Fits: Hydac Hydraulic Systems
Replaces: Hydac 160R020BNHC
O.D.: 2 13/16 (71.4)
I.D.: 1 5/16 (33.3) One End
Height: 5 3/8 (136.5)
I.Gskt: [1] Included

PT23108-MPG Maximum Performance Glass Hydraulic Element



Fits: Hydac Hydraulic Systems
Replaces: Hydac 100DN010BNHC
O.D.: 1 3/4 (44.5)
I.D.: 13/16 (20.6)
Height: 9 3/4 (247.7)
I.Gskt: [1] Included

PT23103-MPG Maximum Performance Glass Hydraulic Element with Bail Handle



Fits: Hydac Hydraulic Systems
Replaces: Hydac 165R010BN3HC
O.D.: 2 1/4 (57.2)
I.D.: 1 5/16 (33.3) One End
Height: 9 (228.6)
I.Gskt: [1] Included

PT23109-MPG Maximum Performance Glass Hydraulic Element



Fits: Hydac Hydraulic Systems
Replaces: Hydac 100DN025BNHC
O.D.: 1 3/4 (44.5)
I.D.: 13/16 (20.6)
Height: 9 3/4 (247.7)
I.Gskt: [1] Included

PT23104-MPG Maximum Performance Glass Hydraulic Element with Bail Handle



Contains: By-Pass Valve
Fits: Hydac Hydraulic Systems
Replaces: Hydac 2600R005BNHC
O.D.: 5 1/2 (139.7)
I.D.: 3 13/16 (96.8) One End
Height: 36 11/16 (931.9)
I.Gskt: [1] Included

PT23110-MPG Maximum Performance Glass Hydraulic Element



Fits: Hydac Applications
Replaces: Hydac 160DN010BNHC, 1268869; Eppensteiner 20160H10SLA000P, 20160H10XLA000P; Filtrec XD160G10A
O.D.: 3 1/16 (77.8)
I.D.: 1 19/32 (40.5) One End
Height: 6 3/16 (157.2)
O-Ring: [1] Attached

PT23105-MPG Maximum Performance Glass Hydraulic Element with Bail Handle



Contains: By-Pass Valve
Fits: Hydac Hydraulic Assemblies
Replaces: Hydac 60R010BNHC
O.D.: 1 15/16 (49.2)
I.D.: 13/16 (20.6) One End
Height: 4 (101.6)
I.Gskt: [1] Included

PT23111-MPG Maximum Performance Glass Hydraulic Element



Fits: Hydac Applications
Replaces: Hydac 250DN010BNHC
O.D.: 3 1/16 (77.8)
I.D.: 1 9/16 (39.7)
Height: 9 3/4 (247.7)
O-Ring: [1] Attached

Measurements Are Shown In Inches And (Millimeters)

WARNING: These products can expose you to chemicals, including Diisononyl Phthalate, Carbon black extracts, Nickel, 1,3 Butadiene, Ethylene Oxide, Epichlorohydrin, which are known to the State of California to cause cancer, and Bisphenol, Ethylene Glycol, Ethylene Oxide, 1,3 Butadiene, Epichlorohydrin, which are known to the State of California to cause birth defects or other reproductive harm. For more information go to www.P65Warnings.ca.gov.

PT23112-MPG Maximum Performance Glass Hydraulic Element



Fits: Hydac Applications
Replaces: Hydac 250DN025BNHC
O.D.: 3 (76.2)
I.D.: 1 9/16 (39.7) One End
Height: 9 9/16 (242.9)
O-Ring: [1] Attached

PT23118-MPG Maximum Performance Glass Hydraulic Element



Fits: Hydac Hydraulic Systems
Replaces: Hydac 160RN010BNHC
O.D.: 3 15/16 (100.0)
I.D.: 2 (50.8)
Height: 6 1/4 (158.8)
I.Gskt: [2] Included

PT23113-MPG Maximum Performance Glass Hydraulic Element



Fits: Hydac Applications
Replaces: Hydac 400DN006BNHC
O.D.: 3 1/16 (77.8)
I.D.: 1 1/2 (38.1) One End
Height: 15 11/16 (398.5)
O-Ring: [1] Attached

PT23119-MPG Maximum Performance Glass Hydraulic Element

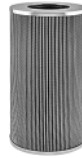

Fits: Hydac Applications
Replaces: Hydac 400RN010BNHC
O.D.: 5 1/16 (128.6)
I.D.: 2 3/4 (69.9) One End
Height: 9 3/4 (247.7)
O-Ring: [2] Attached

PT23114-MPG Maximum Performance Glass Hydraulic Element



Fits: Hydac Hydraulic Systems
Replaces: Hydac 400DN010BNHC
O.D.: 3 1/8 (79.4)
I.D.: 1 1/2 (38.1) One End
Height: 15 11/16 (398.5)
I.Gskt: [1] Included

PT23120-MPG Maximum Performance Glass Hydraulic Element



Fits: Hydac Hydraulic Systems
Replaces: Hydac 630RN010BNHC
O.D.: 5 1/8 (130.2)
I.D.: 2 11/16 (68.3)
Height: 15 3/4 (400.1)
I.Gskt: [2] Included

PT23115-MPG Maximum Performance Glass Hydraulic Element



Fits: Hydac Hydraulic Systems
Replaces: Hydac 63RN010BNHC
O.D.: 2 1/8 (54.0)
I.D.: 1 1/8 (28.6)
Height: 6 1/4 (158.8)
I.Gskt: [2] Included

PT23122

Hydraulic Strainer



Contains: 3 PSID By-Pass Valve
Threaded Hex Nut
Replaces: Schroeder SS150100
O.D.: 3 7/32 (81.8)
Height: 8 9/16 (217.5)

PT23116-MPG Maximum Performance Glass Hydraulic Element



Fits: Pall Hydraulic Systems
Replaces: Pall HC0600FKS16H
O.D.: 6 (152.4)
I.D.: 3 1/2 (88.9)
Height: 15 11/16 (398.5)
I.Gskt: [2] Included

PT23123

Hydraulic Strainer



Contains: 3 PSID By-Pass Valve
Threaded Hex Nut
Replaces: Schroeder SS125100
O.D.: 3 3/16 (81)
Height: 6 9/16 (166.7)

PT23117-MPG Maximum Performance Glass Hydraulic Element



Fits: Hydac Hydraulic Systems
Replaces: Hydac 100RN010BNHC
O.D.: 2 1/4 (57.2)
I.D.: 1 1/8 (28.6)
Height: 9 13/16 (249.2)
I.Gskt: [2] Included

PT23124

Hydraulic Strainer



Contains: 3 PSID By-Pass Valve
Threaded Nut: 2 Inch NPT
Fits: Schroeder Industries Hydraulic Systems
Replaces: Schroeder SS2100;
Fleetguard HF6264; Wix 57453
O.D.: 4 3/16 (106.4)
Height: 7 7/32 (183.4)

Measurements Are Shown In Inches And (Millimeters)

WARNING: These products can expose you to chemicals, including Diisononyl Phthalate, Carbon black extracts, Nickel, 1,3 Butadiene, Ethylene Oxide, Epichlorohydrin, which are known to the State of California to cause cancer, and Bisphenol, Ethylene Glycol, Ethylene Oxide, 1,3 Butadiene, Epichlorohydrin, which are known to the State of California to cause birth defects or other reproductive harm. For more information go to www.P65Warnings.ca.gov.

PT23125-MPG Maximum Performance Glass Hydraulic Element



Fits: Schroeder Industries Hydraulic Systems
Replaces: Schroeder KSX3V;
 Donaldson P566412
O.D.: 3 3/16 (81)
I.D.: 1 19/32 (40.5)
Height: 9 5/16 (236.5)
I.Gskt: [2] Included

PT23132-MPG Maximum Performance Glass Hydraulic Element



Fits: Hydac Applications
Replaces: Hydac 110D003BH3HC;
 Fleetguard ST1038
O.D.: 1 27/32 (46.8)
I.D.: 7/8 (22.2) One End
Height: 6 1/32 (153.2)
I.Gskt: [1] Included

PT23126-MPG Maximum Glass Performance Hydraulic Element



Fits: Pall Hydraulic Applications
Replaces: Pall HC9021FUS4H
O.D.: 1 25/32 (45.2)
I.D.: 1 (25.4) One End
Height: 4 1/2 (114.3)
I.Gskt: [1] Included

PT23133-MPG Maximum Performance Glass Hydraulic Element



Fits: Various Pall Hydraulic Applications
Replaces: Pall HC2618FKP18H;
 Parker 934179Q; Donaldson P566705
O.D.: 6 (152.4)
I.D.: 2 5/8 (66.7)
Height: 17 13/16 (452.4)

PT23127-MPG Maximum Performance Glass Hydraulic Element



Fits: Allison EV40, EV50 Transmission
Replaces: General Motors Corp. 29545785
O.D.: 3 7/32 (81.8)
I.D.: 1 17/32 (38.9)
Height: 4 3/16 (106.4)
O-Ring: [2] Included

PT23134-MPG Maximum Performance Glass Hydraulic Element



Notes: OBSOLETE. Availability Limited to Dealer Stock.
Fits: Heil Equipment
O.D.: 4 5/32 (105.6)
I.D.: 13/32 (10.2) & 2 17/32 (64.3)
Height: 18 5/16 (465.1)

PT23128-MPG Maximum Performance Glass Hydraulic Element



Fits: Hydac Applications
O.D.: 1 27/32 (46.8)
I.D.: 7/8 (22.2) One End
Height: 6 1/32 (153.1)
O-Ring: [1] Attached

PT23135-MPG Maximum Performance Glass Hydraulic Element



Fits: Parker Hydraulic Systems
Replaces: Parker 932633Q
O.D.: 2 3/8 (60.3)
I.D.: 31/32 (24.6) One End
Height: 9 23/32 (246.9)
O-Ring: [1] Attached

PT23129-MPG Maximum Performance Glass Hydraulic Element



Fits: Hydac Hydraulic Applications
Replaces: Hydac 24D020BN3HCV
O.D.: 2 3/4 (69.9)
I.D.: 1 11/32 (34.1) One End
Height: 6 13/16 (173)
I.Gskt: [1] Included

PT23136 Hydraulic Element



Contains: Threaded Nut: 7/8-14
Fits: Ford Tractors
Replaces: Ford C5NN7B155A
O.D.: 3 15/32 (88.1)
I.D.: 5/8 (15.9)
Height: 4 31/32 (126.2)
A. Gskt: [1] Included
F. Gskt: [1] Included

PT23131-MPG Maximum Performance Glass Hydraulic Element



Fits: Schroeder Hydraulic Applications
Replaces: Schroeder 8TSX7
O.D.: 3 1/16 (77.8)
I.D.: 1 11/16 (42.9) One End
Height: 8 9/32 (210.3)
I.Gskt: [1] Included

PT23137 Hydraulic Element

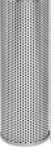

Fits: Driltech Equipment
Replaces: Driltech 318553; ACDelco PF1770;
 Donaldson P161917
O.D.: 4 3/8 (11.1)
I.D.: 23/32 (18.3) & 2 7/16 (61.9)
Height: 13 1/32 (331)
A. Gskt: [1] Included
Grommets: [1] Attached

Measurements Are Shown In Inches And (Millimeters)

 **WARNING:** These products can expose you to chemicals, including Diisononyl Phthalate, Carbon black extracts, Nickel, 1,3 Butadiene, Ethylene Oxide, Epichlorohydrin, which are known to the State of California to cause cancer, and Bisphenol, Ethylene Glycol, Ethylene Oxide, 1,3 Butadiene, Epichlorohydrin, which are known to the State of California to cause birth defects or other reproductive harm. For more information go to www.P65Warnings.ca.gov.

PT23138

Hydraulic Element



Fits: Deutz-Fahr Tractors
Replaces: SDF 4417454; Hengst E84H;
Mann & Hummel H10592
O.D.: 3 7/8 (98.4)
I.D.: 2 5/16 (58.7)
Height: 9 (228.6)

PT23144

Hydraulic Element



Fits: Domange Applications
Replaces: Domange FD45P10
O.D.: 3 5/8 (92.1)
I.D.: 3/8 (9.5) & 2 1/2 (63.5)
Height: 8 7/8 (225.4)
Grommets: [1] Attached

PT23139-MPG

Maximum Performance Glass Hydraulic Element



Fits: Heil Hydraulic Systems
Replaces: Heil 750912030
O.D.: 4 7/8 (123.8)
I.D.: 2 3/4 (69.9) One End
Height: 19 7/8 (504.8)
F. Gskt: [1] Included
O-Ring: [2] Attached

PT23145

Hydraulic Element



Fits: Parker Applications
Replaces: Parker HPR1619
O.D.: 1 7/16 (36.5)
I.D.: 1/2 (12.7)
Height: 1 9/16 (39.7)

BT23140-MPG

Maximum Performance Glass Hydraulic Spin-on



Fits: Ditchwitch, Genie, Pall, Vickers Hydraulic Systems
Replaces: Pall HC7500SUP4Z
Thread: 1 1/2 -16
O.D.: 5 3/32 (129.4)
Height: 6 21/32 (169.1)
F. Gskt: [2] Included

PT23146

Hydraulic Element



Contains: By-Pass Valve
Fits: Argo Applications
Replaces: Argo K3092062; Filtrec WP457
O.D.: 3 1/4 (82.6)
I.D.: 1 1/2 (38.1) One End
Height: 7 13/16 (198.4)
O-Ring: [1] Attached

PT23141

Hydraulic Element with Bail Handle



Contains: By-Pass Valve
Fits: Purolator Applications
Replaces: Purolator LI2692;
Filtrec 142C25BG
O.D.: 3 7/8 (98.4)
I.D.: 1 1/2 (38.1) One End
Height: 7 3/16 (182.5)
O-Ring: [1] Attached
Spring: [1] Included

PT23147

Hydraulic Element with Bail Handle



Contains: 22 PSID By-Pass Valve
Fits: Manitou Applications
Replaces: Mahle 7686470, 852369MIC25;
MP Filtri MF4001P25NB
O.D.: 5 1/2 (139.7)
I.D.: 2 1/16 (52.4)
Height: 5 11/32 (135.7)
O-Ring: [1] Included
Spring: [1] Included

PT23142

Hydraulic Element



Fits: Schroeder Applications
Replaces: Schroeder C10; Filtrec WP603
O.D.: 2 15/16 (74.6)
I.D.: 1 (25.4) One End
Height: 4 15/16 (125.4)
O-Ring: [1] Attached

PT23148

Hydraulic Element



Fits: Fairey-Arlon Applications
Replaces: Fairey-Arlon TXX3B10;
Parker PR4392
O.D.: 4 3/16 (106.4)
I.D.: 2 7/8 (73.0) One End
Height: 5 1/2 (139.7)

PT23143

Hydraulic Element



Fits: Schroeder Applications
Replaces: Schroeder N3
O.D.: 1 13/16 (46.0)
I.D.: 13/16 (20.6) One End
Height: 5 5/16 (134.9)
O-Ring: [1] Attached

PT23149

Hydraulic Element



Fits: Liebherr Applications
Replaces: Liebherr 7367204
O.D.: 3 5/16 (84.1)
I.D.: 1 11/16 (42.9)
Height: 7 1/2 (190.5)
End Seals: [2] Attached

Measurements Are Shown In Inches And (Millimeters)

WARNING: These products can expose you to chemicals, including Diisononyl Phthalate, Carbon black extracts, Nickel, 1,3 Butadiene, Ethylene Oxide, Epichlorohydrin, which are known to the State of California to cause cancer, and Bisphenol, Ethylene Glycol, Ethylene Oxide, 1,3 Butadiene, Epichlorohydrin, which are known to the State of California to cause birth defects or other reproductive harm. For more information go to www.P65Warnings.ca.gov.

PT23150	<p>Hydraulic Element</p> <p>Fits: Parker Applications</p> <p>Replaces: Caterpillar 311536; Parker 924449</p> <p>O.D.: 3 5/8 (92.1)</p> <p>I.D.: 1 3/4 (44.5)</p> <p>Height: 9 5/16 (236.5)</p> <p>Grommets: [2] Attached</p>	PT23157	<p>Hydraulic Stacked Element</p> <p>Fits: Parker Applications</p> <p>Replaces: Parker 937733, PR4434, TXX1410B</p> <p>O.D.: 8 9/32 (210.3)</p> <p>I.D.: 6 5/32 (156.3) One End</p> <p>Height: 32 15/32 (824.7)</p>
PT23151	<p>Hydraulic Element</p> <p>Fits: Argo Applications</p> <p>Replaces: Arco K3134062</p> <p>O.D.: 5 (127.0)</p> <p>I.D.: 3 1/2 (88.9) One End</p> <p>Height: 18 (457.2)</p> <p>O-Ring: [1] Attached</p> <p>Spring: [1] Attached</p>	PT23158	<p>Hydraulic Element</p> <p>Fits: Domange Applications</p> <p>Replaces: Domange FD66P10</p> <p>O.D.: 4 31/32 (126.2)</p> <p>I.D.: 1/2 (12.7) & 3 5/8 (92.1)</p> <p>Height: 13 13/16 (351.0)</p> <p>Grommets: [1] Attached</p>
PT23152	<p>Hydraulic Element with Bail Handle</p> <p>Contains: By-Pass Valve</p> <p>Fits: MP Filtri Applications</p> <p>Replaces: MP Filtri MF7501P10NB; Donaldson P171581</p> <p>O.D.: 5 5/16 (134.9)</p> <p>I.D.: 2 1/2 (63.5)</p> <p>Height: 16 (406.4)</p> <p>Spring: [1] Included</p>	PT23159	<p>Hydraulic Element</p> <p>Fits: Voegele Applications</p> <p>Replaces: Voegele 9606671002</p> <p>O.D.: 4 1/32 (102.4)</p> <p>I.D.: 1/4 (6.3)</p> <p>Height: 12 11/16 (322.2)</p>
PT23154	<p>Hydraulic Element</p> <p>Fits: Parker Applications</p> <p>Replaces: Parker 908642</p> <p>O.D.: 3 15/16 (100.0)</p> <p>I.D.: 2 3/8 (60.3)</p> <p>Height: 13 1/16 (331.7)</p> <p>A. Gskt: [2] Attached</p> <p>F. Gskt: [1] Included</p>	PT23160	<p>Hydraulic Element</p> <p>Fits: PTI Applications</p> <p>Replaces: Bosch 1457431909, 1457431109, 1457431914; PTI PG050CH; Donaldson P174293</p> <p>O.D.: 3 1/4 (82.6)</p> <p>I.D.: 1 7/8 (47.6) One End</p> <p>Height: 5 5/8 (142.8)</p>
PT23155	<p>Hydraulic Element</p> <p>Fits: PTI Applications</p> <p>Replaces: PTI PG120DH; Donaldson P174298; Eppensteiner 18.1045P25E000P</p> <p>O.D.: 3 5/16 (84.1)</p> <p>I.D.: 2 (50.8) One End</p> <p>Height: 14 11/16 (373.1)</p>	PT23161	<p>Hydraulic Element</p> <p>Fits: Parker Applications</p> <p>Replaces: Parker 907233, G01070; Donaldson P170095</p> <p>O.D.: 3 1/2 (88.9)</p> <p>I.D.: 2 3/16 (55.6) One End</p> <p>Height: 8 1/16 (204.7)</p> <p>O-Ring: [1] Attached</p>
PT23156	<p>Hydraulic Element</p> <p>Fits: Caterpillar Applications</p> <p>Replaces: Caterpillar 311714; Fleetguard HF7728</p> <p>O.D.: 5 5/8 (142.9)</p> <p>I.D.: 4 (101.6)</p> <p>Height: 12 3/16 (309.6)</p> <p>A. Gskt: [2] Attached</p> <p>F. Gskt: [1] Included (Adhesive Backed)</p>	PT23162	<p>Hydraulic Element</p> <p>Fits: Argo Applications</p> <p>Replaces: Argo P2072301</p> <p>O.D.: 2 1/2 (63.5)</p> <p>I.D.: 1 3/16 (30.2)</p> <p>Height: 9 (228.6)</p>

Measurements Are Shown In Inches And (Millimeters)

 **WARNING:** These products can expose you to chemicals, including Diisononyl Phthalate, Carbon black extracts, Nickel, 1,3 Butadiene, Ethylene Oxide, Epichlorohydrin, which are known to the State of California to cause cancer, and Bisphenol, Ethylene Glycol, Ethylene Oxide, 1,3 Butadiene, Epichlorohydrin, which are known to the State of California to cause birth defects or other reproductive harm. For more information go to www.P65Warnings.ca.gov.

PT23163

Hydraulic Element



Fits: Fairey-Arlon Applications
Replaces: Fairey-Arlon TXX3ER10
O.D.: 2 13/16 (71.4)
I.D.: 1/4 (6.4) & 1 3/4 (44.4)
Height: 11 13/16 (300.0)

PT23169

Hydraulic Element



Fits: Argo Applications
Replaces: Argo K6123452
O.D.: 4 1/2 (114.3)
I.D.: 2 5/16 (58.7)
Height: 13 1/4 (336.5)

PT23164

Hydraulic Element



Fits: Argo Applications
Replaces: Argo P3051052
O.D.: 1 13/16 (46.0)
I.D.: 13/16 (20.6) One End
Height: 4 3/16 (106.3)
O-Ring: [1] Attached

PT23170

Hydraulic Element



Fits: Parker Applications
Replaces: Parker 924467
O.D.: 5 9/16 (141.2)
I.D.: 4 (101.6)
Height: 12 1/8 (308.0)
A. Gskt: [2] Attached
F. Gskt: [1] Included (Adhesive Backed)

PT23165

Hydraulic Element



Contains: By-Pass Valve
Fits: Argo Applications
Replaces: Argo K3092552
O.D.: 3 9/16 (90.5)
I.D.: 2 5/16 (58.7) One End
Height: 11 1/8 (282.6)
O-Ring: [1] Attached

PT23171

Hydraulic Element



Fits: Argo Applications
Replaces: Argo P3051011
O.D.: 1 7/8 (47.6)
I.D.: 3/4 (19.1) One End
Height: 4 1/8 (104.8)
O-Ring: [1] Attached

PT23166

Hydraulic Element



Fits: Parker Applications
Replaces: Parker 907234, G01071;
Donaldson P170096
O.D.: 3 1/2 (88.9)
I.D.: 2 3/16 (55.6) One End
Height: 8 1/16 (204.7)
O-Ring: [1] Attached

PT23172

Hydraulic Element



Fits: Parker Applications
Replaces: Parker 924730
O.D.: 2 3/4 (69.9)
I.D.: 1 13/16 (46.0)
Height: 9 (228.6)
A. Gskt: [2] Attached

PT23167

Hydraulic Element



Contains: By-Pass Valve
Fits: Argo Applications
Replaces: Argo K9123752; Filtrec WP461
O.D.: 4 1/4 (108.0)
I.D.: 2 7/16 (61.9) One End
Height: 14 1/2 (368.3)
O-Ring: [1] Attached

PT23173

Hydraulic Element



Fits: Parker Applications
Replaces: Parker 922787
O.D.: 5 13/16 (147.6)
I.D.: 4 1/16 (103.1)
Height: 12 1/8 (308.0)
A. Gskt: [2] Attached

PT23168

Hydraulic Element



Fits: PTI Applications
Replaces: Bosch 1457431911;
PTI PG120CH
O.D.: 3 3/8 (85.7)
I.D.: 1 7/8 (47.6) One End
Height: 14 3/4 (374.6)

PT23174

Hydraulic Element with Bail Handle



Fits: Hydac Applications
Replaces: Hydac 270R015MM
O.D.: 3 1/2 (88.9)
I.D.: 1 1/2 (38.1) One End
Height: 16 1/4 (412.7)
O-Ring: [1] Attached

Measurements Are Shown In Inches And (Millimeters)

WARNING: These products can expose you to chemicals, including Diisononyl Phthalate, Carbon black extracts, Nickel, 1,3 Butadiene, Ethylene Oxide, Epichlorohydrin, which are known to the State of California to cause cancer, and Bisphenol, Ethylene Glycol, Ethylene Oxide, 1,3 Butadiene, Epichlorohydrin, which are known to the State of California to cause birth defects or other reproductive harm. For more information go to www.P65Warnings.ca.gov.

PT23175



Hydraulic Element

Contains: By-Pass Valve
Threaded End
Fits: U.C.C. Applications
Replaces: U.C.C. UCSE5102
O.D.: 2 1/2 (63.5)
I.D.: 1 3/8 (34.9) One End
Height: 5 13/16 (147.6)

PT23182



Hydraulic Element

Fits: Parker Applications
Replaces: Parker 924456
O.D.: 3 13/16 (96.8)
I.D.: 2 (50.8)
Height: 9 3/8 (238.1)
Grommets: [2] Attached

PT23176



Hydraulic Element with Bail Handle

Contains: By-Pass Valve
Fits: MP Filtri Applications
Replaces: MP Filtri MF1003M60NB
O.D.: 2 13/16 (71.4)
I.D.: 1 9/16 (39.7) One End
Height: 8 7/8 (225.4)
O-Ring: [1] Attached
Spring: [1] Included

PT23183



Hydraulic Element

Fits: Vickers Applications
Replaces: Vickers 941056
O.D.: 4 (101.6)
I.D.: 2 15/16 (74.6)
Height: 6 15/16 (176.2)
O-Ring: [2] Attached, [1] Included

PT23178



Wire Supported Hydraulic Element

Contains: By-Pass Valve
Threaded Stud
Fits: U.C.C. Applications
Replaces: U.C.C. UCSE5104
O.D.: 3 5/16 (84.1)
Height: 8 1/16 (204.7)

PT23184



Hydraulic Element

Fits: Vickers Applications
Replaces: Vickers 36192
O.D.: 4 (101.6)
I.D.: 2 15/16 (74.6)
Height: 6 15/16 (176.2)
O-Ring: [2] Attached, [1] Included

PT23179



Hydraulic Element

Contains: By-Pass Valve
Fits: U.C.C. Applications
Replaces: U.C.C. UCSE5105
O.D.: 3 1/2 (88.9)
I.D.: 2 1/2 (63.5) One End
Height: 10 5/16 (262.0)

PT23185



Hydraulic Element

Fits: MP Filtri Applications
Replaces: MP Filtri CU630M90N
O.D.: 5 5/16 (134.9)
I.D.: 3 (76.2)
Height: 9 13/16 (249.2)
O-Ring: [2] Attached

PT23180



Hydraulic Element

Contains: By-Pass Valve
Fits: U.C.C. Applications
Replaces: U.C.C. UCSE5107
O.D.: 5 15/16 (150.8)
I.D.: 3 (76.2) One End
Height: 8 1/2 (216.0)

PT23186



Hydraulic Element

Contains: Stud Thread: 2-11 BSP
Fits: MP Filtri Applications
Replaces: MP Filtri MPA280G1M90, STR1403SG1M90; Donaldson FIOA500, P171897
O.D.: 5 5/32 (131.0)
Height: 10 15/16 (277.8)
O-Ring: [1] Attached

PT23181



Hydraulic Element

Fits: Parker Applications
Replaces: Parker 924455
O.D.: 3 13/16 (96.8)
I.D.: 2 (50.8)
Height: 9 3/8 (238.1)
Grommets: [2] Attached

PT23187



Hydraulic Element

Fits: Fairey-Arlon Applications
Replaces: Fairey-Arlon ST560
O.D.: 4 1/4 (108.0)
I.D.: 3 (76.2) One End
Height: 10 1/8 (257.2)

Measurements Are Shown In Inches And (Millimeters)



WARNING: These products can expose you to chemicals, including Diisononyl Phthalate, Carbon black extracts, Nickel, 1,3 Butadiene, Ethylene Oxide, Epichlorohydrin, which are known to the State of California to cause cancer, and Bisphenol, Ethylene Glycol, Ethylene Oxide, 1,3 Butadiene, Epichlorohydrin, which are known to the State of California to cause birth defects or other reproductive harm. For more information go to www.P65Warnings.ca.gov.

PT23188 Hydraulic Element with Bail Handle
Contains: By-Pass Valve
Fits: MP Filtri Applications
Replaces: MP Filtri MF4001M60NB
O.D.: 5 3/16 (131.8)
I.D.: 2 (50.8)
Height: 6 (152.4)
O-Ring: [1] Attached
Spring: [1] Included



PT23197-MPG Maximum Performance Glass Hydraulic Element
Fits: Fairey-Arlon Applications
Replaces: Fairey-Arlon 370L122A
O.D.: 3 11/16 (93.7)
I.D.: 1 29/32 (48.4) One End
Height: 3 29/32 (99.2)
O-Ring: [1] Included



PT23189 Hydraulic Element
Fits: Argo Applications
Replaces: Argo S2092000
O.D.: 3 5/16 (84.1)
I.D.: 2 7/16 (61.9)
Height: 7 11/16 (195.2)



PT23198-MPG Maximum Performance Glass Hydraulic Element
Contains: By-Pass Valve
Fits: Fendt Applications
Replaces: Argo V3062088;
 Fendt G178860060030
O.D.: 2 1/2 (63.5)
I.D.: 1 3/16 (30.2) One End
Height: 9 1/4 (235.0)
O-Ring: [1] Attached



PT23190 Hydraulic Element
Fits: Komatsu Applications
Replaces: Komatsu 79560373
O.D.: 2 13/16 (71.4)
I.D.: 1 1/2 (38.1) One End
Height: 4 1/16 (103.2)
O-Ring: [1] Attached



PT23200-MPG Maximum Performance Glass Hydraulic Element
Fits: Fairey-Arlon Applications
Replaces: Fairey-Arlon MXW2GDL10;
 Filtrec D411G10
O.D.: 2 5/16 (58.7)
I.D.: 1 1/16 (27.0) One End
Height: 9 3/4 (247.7)
O-Ring: [1] Attached



PT23193-MPG Maximum Performance Glass Hydraulic Element
Contains: By-Pass Valve
 Backup O-Ring
Fits: International Applications
Replaces: International 3224623-R1,
 3405722-R1, 3405722-R2, 3405729-R1
O.D.: 2 3/8 (60.3)
I.D.: 15/16 (23.8) One End
Height: 2 13/16 (71.4)
O-Ring: [1] Attached, [1] Included



PT23201-MPG Maximum Performance Glass Hydraulic Element
Fits: Fairey-Arlon Applications
Replaces: Fairey-Arlon TXW3DCC10,
 TXW3DGDL10
O.D.: 2 7/8 (73.0)
I.D.: 3/8 (9.5) & 1 15/16 (49.2)
Height: 7 7/8 (200.0)



PT23195-MPG Maximum Performance Glass Hydraulic Element
Fits: Fairey-Arlon Applications
Replaces: Fairey-Arlon MW1GDL20;
 Filtrec D410G25
O.D.: 2 5/16 (58.7)
I.D.: 1 1/16 (27.0) One End
Height: 4 13/16 (122.2)
O-Ring: [1] Attached



PT23202-MPG Maximum Performance Glass Hydraulic Element
Fits: Schroeder Hydraulic Systems
Replaces: Schroeder NS7, NZ10;
 Fleetguard HF7351
O.D.: 1 3/4 (44.5)
I.D.: 3/4 (19.1) One End
Height: 5 3/8 (136.5)
O-Ring: [1] Attached



PT23196-MPG Maximum Performance Glass Hydraulic Element
Fits: Fairey-Arlon Applications
Replaces: Fairey-Arlon TXW3CC25,
 TXW3GDL20
O.D.: 2 13/16 (71.4)
I.D.: 1 13/16 (46.0)
Height: 5 7/8 (149.2)



PT23203-MPG Maximum Performance Glass Hydraulic Element
Fits: Schroeder Applications
Replaces: Schroeder CS7, CZ10;
 Donaldson P171311
O.D.: 2 3/4 (69.9)
I.D.: 1 (25.4) One End
Height: 4 3/4 (120.6)
O-Ring: [1] Attached



Measurements Are Shown In Inches And (Millimeters)

WARNING: These products can expose you to chemicals, including Diisononyl Phthalate, Carbon black extracts, Nickel, 1,3 Butadiene, Ethylene Oxide, Epichlorohydrin, which are known to the State of California to cause cancer, and Bisphenol, Ethylene Glycol, Ethylene Oxide, 1,3 Butadiene, Epichlorohydrin, which are known to the State of California to cause birth defects or other reproductive harm. For more information go to www.P65Warnings.ca.gov.

PT23204-MPG Maximum Performance Glass Hydraulic Element



Fits: P.T.I. Applications
Replaces: P.T.I. PG050JH; Donaldson P174293
O.D.: 3 5/16 (84.1)
I.D.: 2 (50.8) One End
Height: 5 9/16 (141.2)
O-Ring: [1] Attached

PT23211-MPG Maximum Performance Glass Hydraulic Element



Fits: Schroeder Applications
Replaces: Schroeder KKS1, KKZ3; Cim-Tek 30144
O.D.: 3 7/8 (98.4)
I.D.: 1 5/8 (41.3)
Height: 18 1/2 (469.9)
F. Gskt: [1] Included
O-Ring: [2] Attached

PT23205-MPG Maximum Performance Glass Hydraulic Element



Fits: Pall Applications
Replaces: Pall HC9800FDS4Z, HC9800FKS4Z; Donaldson P566394
O.D.: 2 (50.8)
I.D.: 15/16 (23.8) One End
Height: 4 1/2 (114.3)
O-Ring: [1] Attached

PT23212-MPG Maximum Performance Glass Hydraulic Element



Fits: Parker Applications
Replaces: Parker 940054Q
O.D.: 2 3/4 (69.9)
I.D.: 1 3/8 (34.9) One End
Height: 5 (127.0)
O-Ring: [1] Attached

PT23206-MPG Maximum Performance Glass Hydraulic Element



Fits: Hydac Applications
Replaces: Hydac 160D010BNHC
O.D.: 2 11/16 (68.3)
I.D.: 1 1/4 (31.8) One End
Height: 4 9/16 (115.8)
O-Ring: [1] Attached

PT23213-MPG Maximum Performance Glass Hydraulic Element



Fits: Parker Applications
Replaces: Parker 924452, 924452Q
O.D.: 3 11/16 (93.7)
I.D.: 2 (50.8)
Height: 9 1/8 (231.7)
Grommets: [2] Attached

PT23207-MPG Maximum Performance Glass Hydraulic Element



Fits: Hydac Applications
Replaces: Hydac 160D005BNHC
O.D.: 2 3/4 (69.9)
I.D.: 1 7/16 (36.5) One End
Height: 4 5/8 (117.4)
F. Gskt: [1] Included
O-Ring: [1] Attached, [1] Backup O-Ring

PT23214-MPG Maximum Performance Glass Hydraulic Element



Fits: Fairey-Arlon Applications
Replaces: Fairey-Arlon TXW5GDL6; Donaldson P763010
O.D.: 4 1/8 (104.8)
I.D.: 5/8 (7.9) & 2 13/16 (71.4)
Height: 10 1/4 (260.4)

PT23208-MPG Maximum Performance Glass Hydraulic Element



Fits: MP Filtri Applications
Replaces: MP Filtri HP1351A06NA; Airfil AFKOV241A3
O.D.: 2 1/8 (54.0)
I.D.: 1 (25.4) One End
Height: 4 5/8 (117.4)
O-Ring: [1] Attached

PT23215-MPG Maximum Performance Glass Hydraulic Element



Fits: Fairey-Arlon Applications
Replaces: Fairey-Arlon TXW4CC10, TXW4GDL10; Donaldson P171826
O.D.: 4 5/16 (109.5)
I.D.: 3 (76.2) One End
Height: 7 9/16 (192.1)

PT23209-MPG Maximum Performance Glass Hydraulic Element



Fits: Pall Applications
Replaces: Pall HC2252FKS10H
O.D.: 3 15/16 (100.0)
I.D.: 1 7/8 (47.6) One End
Height: 9 3/16 (233.4)
Grommets: [1] Attached

PT23216-MPG Maximum Performance Glass Hydraulic Element



Fits: Fairey-Arlon Applications
Replaces: Fairey-Arlon 370L222A
O.D.: 3 11/16 (93.5)
I.D.: 1 29/32 (48.4) One End
Height: 7 2/32 (199.2)
F. Gskt: [1] Included
O-Ring: [1] Attached

Measurements Are Shown In Inches And (Millimeters)

 **WARNING:** These products can expose you to chemicals, including Diisononyl Phthalate, Carbon black extracts, Nickel, 1,3 Butadiene, Ethylene Oxide, Epichlorohydrin, which are known to the State of California to cause cancer, and Bisphenol, Ethylene Glycol, Ethylene Oxide, 1,3 Butadiene, Epichlorohydrin, which are known to the State of California to cause birth defects or other reproductive harm. For more information go to www.P65Warnings.ca.gov.

PT23217-MPG Maximum Performance Glass Hydraulic Element



Fits: Pall Applications
Replaces: Pall HC9604FKS8Z
O.D.: 1 5/32 (29.4)
I.D.: 2 (50.8) One End
Height: 8 (203.2)
O-Ring: [1] Attached

PT23224-MPG Maximum Performance Glass Hydraulic Element



Fits: Pall Applications
Replaces: Pall HC8900FDT13H, HC8900FKT13H, HC8900FUT13H
O.D.: 3 3/4 (95.3)
I.D.: 2 1/8 (54.0) One End
Height: 12 7/8 (327.0)
O-Ring: [1] Attached

PT23218-MPG Maximum Performance Glass Hydraulic Element



Fits: Pall Applications
Replaces: Pall HC9021FKS4Z
O.D.: 1 5/8 (41.3)
I.D.: 15/16 (23.8) One End
Height: 4 1/2 (114.3)
O-Ring: [1] Attached

PT23225-MPG Maximum Performance Glass Hydraulic Element



Fits: Pall Applications
Replaces: Pall HC6400FDN8H, HC6400FKN8H, HC6400FUN8H
O.D.: 3 3/8 (85.7)
I.D.: 1 15/16 (49.2) One End
Height: 8 1/16 (204.8)
O-Ring: [1] Attached

PT23219-MPG Maximum Performance Glass Hydraulic Element



Fits: Pall Applications
Replaces: Pall HC9600FDS4Z, HC9600FKS4Z, HC9600FUS4Z
O.D.: 3 5/32 (80.2)
I.D.: 1 1/8 (28.6) One End
Height: 4 7/32 (107.2)

PT23226-MPG Maximum Performance Glass Hydraulic Element



Fits: Pall Applications
Replaces: Pall HC9604FL516Z
O.D.: 3 1/8 (79.4)
I.D.: 2 (50.8)
Height: 16 9/16 (420.6)
O-Ring: [1] Attached

PT23220-MPG Maximum Performance Glass Hydraulic Element



Fits: Hydac Applications
Replaces: Hydac 1262386, 280D010BNHC, 280D010BN3HC; Donaldson P560141
O.D.: 2 3/4 (69.9)
I.D.: 1 3/8 (34.9) One End
Height: 14 (355.6)
O-Ring: [1] Attached

PT23227-MPG Maximum Performance Glass Hydraulic Element



Fits: Schroeder Applications
Replaces: Schroeder 27KS15, 27KZ25, KKK15, KKK25
O.D.: 4 (101.6)
I.D.: 1 15/16 (49.2)
Height: 27 11/16 (703.2)
O-Ring: [2] Attached

PT23221-MPG Maximum Performance Glass Hydraulic Element



Fits: Fairey-Arlon Applications
Replaces: Fairey-Arlon 370L323A, 370P310, 370Z310A, 370Z323A, 820P325, 820P335, 870P310
O.D.: 3 3/4 (95.3)
I.D.: 1 7/8 (47.6) One End
Height: 12 5/8 (320.6)
F. Gskt: [1] Included
O-Ring: [1] Attached

PT23228-MPG Maximum Performance Glass Hydraulic Element



Fits: Pall Applications
Replaces: Pall HC8900FDP13H, HC8900FKP13H, HC8900FUP13H
O.D.: 3 3/4 (95.3)
I.D.: 2 1/8 (54.0) One End
Height: 12 7/8 (327.0)
O-Ring: [1] Attached

PT23223-MPG Maximum Performance Glass Hydraulic Element



Fits: Pall, Parker Applications
Replaces: Pall HC8900FUS13H; Filtrec D612G10
O.D.: 3 3/4 (95.3)
I.D.: 2 1/4 (57.2) One End
Height: 12 7/8 (327.0)
O-Ring: [1] Attached

PT23229-MPG Maximum Performance Glass Hydraulic Element with Bail Handle



Fits: MP Filtri Applications
Replaces: MP Filtri MF4002A25HB, MF4002A25NB
O.D.: 5 5/16 (134.9)
I.D.: 2 1/2 (63.5) One End
Height: 8 5/16 (211.1)
O-Ring: [1] Attached
Spring: [1] Included

Measurements Are Shown In Inches And (Millimeters)

WARNING: These products can expose you to chemicals, including Diisononyl Phthalate, Carbon black extracts, Nickel, 1,3 Butadiene, Ethylene Oxide, Epichlorohydrin, which are known to the State of California to cause cancer, and Bisphenol, Ethylene Glycol, Ethylene Oxide, 1,3 Butadiene, Epichlorohydrin, which are known to the State of California to cause birth defects or other reproductive harm. For more information go to www.P65Warnings.ca.gov.

PT23230-MPG Maximum Performance Glass Hydraulic Element



Fits: Parker Applications
Replaces: Parker 976191, G01069
O.D.: 3 1/2 (88.9)
I.D.: 2 1/4 (57.2) One End
Height: 7 7/8 (200.0)
O-Ring: [1] Attached

PT23236-MPG Maximum Performance Glass Hydraulic Element with Bail Handle



Fits: Pall Applications
Replaces: Pall HC8904FKS1Z
O.D.: 3 27/32 (97.6)
I.D.: 2 17/32 (64.3) One End
Height: 16 11/32 (415.1)
O-Ring: [1] Attached

PT23231-MPG Maximum Performance Glass Hydraulic Element



Fits: Pall Applications
Replaces: Pall HC8900FDN13H, HC8900FKN13H, HC8900FUN13H
O.D.: 3 3/4 (95.3)
I.D.: 2 1/8 (54.0) One End
Height: 12 7/8 (327.0)
O-Ring: [1] Attached

PT23237-MPG Maximum Performance Glass Hydraulic Element



Fits: Pall Applications
Replaces: Pall HC6400FDS16H, HC6400FKS16H, HC6400FUS16H
O.D.: 3 3/8 (85.7)
I.D.: 1 15/16 (49.2)
Height: 16 13/16 (427.0)
O-Ring: [1] Attached

PT23232-MPG Maximum Performance Glass Hydraulic Element



Fits: Fairey-Arlon Applications
Replaces: Fairey-Arlon TXW5AGDL6
O.D.: 4 1/8 (104.8)
I.D.: 3/8 (9.5) & 2 3/4 (69.9)
Height: 18 1/4 (463.5)

PT23238-MPG Maximum Performance Glass Hydraulic Element



Fits: Pall Applications
Replaces: Pall HC6400FDN13H, HC6400FKN13H, HC6400FUN13H
O.D.: 3 7/16 (87.3)
I.D.: 2 (50.8) One End
Height: 12 7/8 (327.0)
O-Ring: [1] Attached

PT23233-MPG Maximum Performance Glass Hydraulic Element



Fits: Parker Applications
Replaces: Parker FTBE1B10Q, G02070
O.D.: 2 7/32 (56.4)
I.D.: 1 3/32 (27.8)
Height: 5 7/32 (132.6)
O-Ring: [2] Attached

PT23239-MPG Maximum Performance Glass Hydraulic Element



Fits: Pall Applications
Replaces: Pall HC8300FKT16H
O.D.: 5 7/8 (149.2)
I.D.: 4 1/2 (114.3)
Height: 20 9/32 (515.1)
O-Ring: [2] Attached

PT23234-MPG Maximum Performance Glass Hydraulic Element



Fits: Fairey-Arlon Applications
Replaces: Fairey-Arlon TXW8CCC3, TXW8CGDL3; Donaldson P174573
O.D.: 5 (127.0)
I.D.: 7/16 (11.1) & 3 9/16 (90.4)
Height: 18 7/8 (479.4)

PT23240-MPG Maximum Performance Glass Hydraulic Element



Fits: Pall Applications
Replaces: Pall HC9801FDS8Z, HC9801FKS8Z, HC9801FUS8Z
O.D.: 2 (50.8)
I.D.: 1 (25.4) One End
Height: 8 9/16 (217.5)
O-Ring: [1] Attached

PT23235-MPG Maximum Performance Glass Hydraulic Element with Bail Handle



Fits: Pall Applications
Replaces: Pall HF8904FKS16H
O.D.: 3 27/32 (97.6)
I.D.: 2 17/32 (64.3) One End
Height: 16 11/32 (415.1)
O-Ring: [1] Attached

PT23241-MPG Maximum Performance Glass Hydraulic Element



Fits: Hydac Applications
Replaces: Hydac 2055748, 660D020BN3HC, 660D020BNHC2
O.D.: 3 3/4 (95.3)
I.D.: 2 1/8 (54.0) One End
Height: 12 7/8 (327.0)
O-Ring: [1] Attached

Measurements Are Shown In Inches And (Millimeters)

! **WARNING:** These products can expose you to chemicals, including Diisononyl Phthalate, Carbon black extracts, Nickel, 1,3 Butadiene, Ethylene Oxide, Epichlorohydrin, which are known to the State of California to cause cancer, and Bisphenol, Ethylene Glycol, Ethylene Oxide, 1,3 Butadiene, Epichlorohydrin, which are known to the State of California to cause birth defects or other reproductive harm. For more information go to www.P65Warnings.ca.gov.

PT23242-MPG Maximum Performance Glass Hydraulic Element



Fits: Pall Applications
Replaces: Pall HC6400FDN16H, HC6400FKN16H, HC6400FUN16H
O.D.: 3 3/8 (85.7)
I.D.: 1 15/16 (49.2) One End
Height: 16 13/16 (427.0)
O-Ring: [1] Attached

PT23248-MPG Maximum Performance Glass Hydraulic Element



Fits: Pall Applications
Replaces: Pall HC8300FDT39Z, HC8300FKT39Z, HF8300FUT39Z
O.D.: 6 (152.4)
I.D.: 4 1/2 (114.3)
Height: 38 1/2 (978.0)
O-Ring: [2] Attached

PT23243-MPG Maximum Performance Glass Hydraulic Element with Bail Handle



Fits: Hydac Applications
Replaces: Hydac 2066373, 500R020BN3HC, 500R020BNHC2
O.D.: 3 11/16 (93.6)
I.D.: 1 7/8 (47.6) One End
Height: 10 13/16 (274.6)
O-Ring: [1] Attached

PT23249-MPG Maximum Performance Glass Hydraulic Element



Fits: Pall Applications
Replaces: Pall HC8300FDS16H, HC8300FKS16H, HC8300FUS16H
O.D.: 6 (152.4)
I.D.: 4 1/32 (102.4)
Height: 16 7/8 (428.6)
O-Ring: [2] Attached

PT23244-MPG Maximum Performance Glass Hydraulic Element



Fits: Hydac Applications
Replaces: Hydac 1252802, 1260899, 2055746, 660D005BN3HC, 660D005BNHC
O.D.: 3 9/16 (90.5)
I.D.: 1 13/16 (46.0) One End
Height: 12 7/8 (327.0)
O-Ring: [1] Attached

PT23250-MPG Maximum Performance Glass Hydraulic Element



Fits: Pall Applications
Replaces: Pall HC6400FDN26H, HC6400FKN26H, HC6400FUN26H
O.D.: 3 7/16 (87.3)
I.D.: 1 7/8 (47.6) One End
Height: 25 11/16 (652.5)
O-Ring: [1] Attached

PT23245-MPG Maximum Performance Glass Hydraulic Element



Fits: Argo Applications
Replaces: Argo V5124006
O.D.: 4 3/4 (120.6)
 Flange 5 3/8 (136.5)
I.D.: 2 5/16 (58.7) & 3 (76.2)
Height: 18 (457.2)
O-Ring: [2] Attached

PT23251-MPG Maximum Performance Glass Hydraulic Element



Fits: Parker Applications
Replaces: Parker 933802Q, 987141, G00801
O.D.: 5 9/16 (141.3)
I.D.: 4 (101.6)
Height: 12 1/8 (308.0)
A. Gskt: [2] Attached
F. Gskt: [1] Included (Adhesive Backed)

PT23246-MPG Maximum Performance Glass Hydraulic Element



Fits: Pall Applications
Replaces: Pall HC9600FDN8Z, HC9600FKN8Z, HC9600FUN8Z
O.D.: 3 1/2 (88.9)
I.D.: 1 9/16 (39.7) One End
Height: 8 3/8 (212.7)
O-Ring: [1] Attached

PT23252-MPG Maximum Performance Glass Hydraulic Element with Bail Handle



Fits: Volvo EC160, EW160 Excavators
Replaces: Volvo 11705962
O.D.: 3 11/16 (93.7)
I.D.: 1 13/16 (46.0) One End
Height: 17 1/2 (444.5)
O-Ring: [1] Attached

PT23247-MPG Maximum Performance Glass Hydraulic Element



Fits: Parker Applications
Replaces: Parker G02088, FTCE2B10Q
O.D.: 3 11/16 (93.7)
I.D.: 1 13/16 (46.0) & 1 15/16 (49.2)
Height: 12 3/4 (323.9)
O-Ring: [2] Attached

PT23253-MPG Maximum Performance Glass Hydraulic Element with Bail Handle



Fits: Hydac Applications
Replaces: Hydac 2059112, 1300R020BNHC, 1300R020BN3HC, 1300R020BNHC2
O.D.: 5 5/8 (142.8)
I.D.: 3 3/4 (95.3) One End
Height: 18 7/8 (479.4)
O-Ring: [1] Attached

Measurements Are Shown In Inches And (Millimeters)

WARNING: These products can expose you to chemicals, including Diisononyl Phthalate, Carbon black extracts, Nickel, 1,3 Butadiene, Ethylene Oxide, Epichlorohydrin, which are known to the State of California to cause cancer, and Bisphenol, Ethylene Glycol, Ethylene Oxide, 1,3 Butadiene, Epichlorohydrin, which are known to the State of California to cause birth defects or other reproductive harm. For more information go to www.P65Warnings.ca.gov.

PT23254-MPG Maximum Performance Glass Hydraulic Element



Fits: Mahle Applications
Replaces: Mahle PI2245SMXVST3, PI2245SMVST3
O.D.: 3 1/4 (82.6)
I.D.: 1 13/16 (46.0) One End
Height: 14 11/16 (373.0)

PT23260-MPG Maximum Performance Glass Hydraulic Element



Fits: Pall Applications
Replaces: HC9020FDP4Z, HC9020FKP4Z, HC9020FUP4Z
O.D.: 1 3/4 (44.5)
I.D.: 15/16 (23.8) One End
Height: 4 3/8 (111.1)

PT23255-MPG Maximum Performance Glass Hydraulic Element



Contains: Reinforced Centertube
Fits: Pall Applications
Replaces: Pall HC8300FDP39Z, HC8300FKP39Z, HC8300FUP39Z
O.D.: 6 (152.4)
I.D.: 4 1/32 (102.4)
Height: 38 5/8 (981.0)
O-Ring: [2] Attached

PT23261-MPG Maximum Performance Glass Hydraulic Element



Fits: Fairey-Arlon Applications
Replaces: Fairey-Arlon 270L201A, 270L221A, 270Z221A
O.D.: 3 (76.2)
I.D.: 1 7/16 (36.5) One End
Height: 9 1/2 (241.3)
O-Ring: [1] Attached, [1] Included

PT23256-MPG Maximum Performance Glass Hydraulic Element



Fits: Fairey-Arlon Applications
Replaces: Fairey-Arlon TXW13CC10, TXW13GDL10
O.D.: 8 (203.2)
I.D.: 6 1/4 (158.8) One End
Height: 32 1/2 (825.5)
O-Ring: [1] Attached

PT23262-MPG Maximum Performance Glass Hydraulic Element



Fits: Pall Applications
Replaces: HC9650FDN16Z, HC9650FKN16Z, HC9650FUN16Z
O.D.: 3 1/32 (77.0)
I.D.: 2 1/32 (51.6)
Height: 17 (431.8)
O-Ring: [2] Attached

PT23257-MPG Maximum Performance Glass Hydraulic Element



Fits: Hydac Applications
Replaces: Hydac 1277896, 3106934015M
O.D.: 3 3/4 (95.3)
I.D.: 2 1/4 (57.2) One End
Height: 9 7/16 (239.7)

PT23263-MPG Maximum Performance Glass Hydraulic Element



Fits: Pall Applications
Replaces: HC9801FDS4H, HC9801FKS4H
O.D.: 2 (50.8)
I.D.: 7/8 (22.2) One End
Height: 4 1/2 (114.3)
O-Ring: [1] Attached

PT23258-MPG Maximum Performance Glass Hydraulic Element



Fits: Mahle Applications
Replaces: Mahle 852126SMVST25, 852126SMXVST25
O.D.: 1 3/4 (44.5)
I.D.: 15/16 (23.8) One End
Height: 4 1/2 (114.3)
O-Ring: [1] Attached

PT23264-MPG Maximum Performance Glass Hydraulic Element



Fits: Hydac Applications
Replaces: Hydac 1277952, 201RK015BN3HC
O.D.: 3 15/32 (88.1)
I.D.: 1 19/32 (40.5)
Height: 12 29/32 (327.8)
O-Ring: [2] Attached

PT23259-MPG Maximum Performance Glass Hydraulic Element with Bail Handle



Fits: Hydac Applications
Replaces: Hydac 660R003BNHC
O.D.: 4 3/8 (111.1)
I.D.: 2 9/16 (65.1) One End
Height: 13 (330.2)
O-Ring: [1] Attached

PT23265-MPG Maximum Performance Glass Hydraulic Element



Fits: Hydac Applications
Replaces: Hydac 1252797, 280D005BN3HC, 280D005BNHC, 280D005BNHC3
O.D.: 2 3/8 (60.3)
I.D.: 1 1/32 (26.2) One End
Height: 14 (355.6)
O-Ring: [1] Attached

Measurements Are Shown In Inches And (Millimeters)

WARNING: These products can expose you to chemicals, including Diisononyl Phthalate, Carbon black extracts, Nickel, 1,3 Butadiene, Ethylene Oxide, Epichlorohydrin, which are known to the State of California to cause cancer, and Bisphenol, Ethylene Glycol, Ethylene Oxide, 1,3 Butadiene, Epichlorohydrin, which are known to the State of California to cause birth defects or other reproductive harm. For more information go to www.P65Warnings.ca.gov.

PT23266-MPG Maximum Performance Glass Hydraulic Element



Fits: Pall Applications
Replaces: Pall HC9800FDP8Z, HF9800FKP8Z, HF9800FUP8Z
O.D.: 2 1/16 (52.3)
I.D.: 1 (25.4) One End
Height: 8 1/8 (206.4)
O-Ring: [1] Attached

PT23272-MPG Maximum Performance Glass Hydraulic Element



Fits: Hydac Applications
Replaces: Hydac 2055758, 280D003BN3HC, 280D003BNHC
O.D.: 2 3/4 (69.9)
I.D.: 1 3/8 (34.9) One End
Height: 14 (355.6)
O-Ring: [1] Attached

PT23267-MPG Maximum Performance Glass Hydraulic Element



Fits: Hydac Applications
Replaces: Hydac 100RK015BN3HC
O.D.: 2 7/16 (61.9)
I.D.: 1 1/16 (27.0)
Height: 8 3/8 (212.7)
O-Ring: [2] Attached

PT23273-MPG Maximum Performance Glass Hydraulic Element



Fits: Fairey-Arlon Applications
Replaces: Fairey-Arlon 370L305A, 370L322A, 370P305, 370Z305A
O.D.: 3 11/16 (93.6)
I.D.: 1 7/8 (47.6) One End
Height: 12 5/8 (320.6)
O-Ring: [1] Attached

PT23268-MPG Maximum Performance Glass Hydraulic Element



Notes: Obsolete. Replaced by H9001
Fits: Pall Applications
Replaces: Pall HC8300FDN8Z, HC8300FKN8Z, HC8300FUN8Z
O.D.: 5 15/16 (150.8)
I.D.: 4 1/2 (114.3)
Height: 8 1/8 (206.4)
O-Ring: [2] Attached

PT23274-MPG Maximum Performance Glass Hydraulic Element



Fits: Pall Applications
Replaces: Pall HC2237FDT6H; Parker G03183, PR3183
O.D.: 3 1/2 (88.9)
I.D.: 1 15/16 (49.2) One End
Height: 8 1/2 (215.9)
O-Ring: [1] Attached

PT23269-MPG Maximum Performance Glass Hydraulic Element



Fits: Pall Applications
Replaces: Pall HC9600FDN4Z, HC9600FKN4Z, HC9600FUN4Z
O.D.: 3 1/8 (79.4)
I.D.: 1 7/8 (47.6) One End
Height: 4 11/32 (110.3)
O-Ring: [1] Attached

PT23275-MPG Maximum Performance Glass Hydraulic Element



Fits: Schroeder Applications
Replaces: Schroeder KSX7V
O.D.: 3 1/8 (79.4)
I.D.: 1 13/32 (35.7)
Height: 9 5/16 (236.5)
O-Ring: [2] Attached

PT23270-MPG Maximum Performance Glass Hydraulic Element



Fits: Pall Applications
Replaces: Pall HC9020FDT4Z, HF9020FKT4Z, HC9020FUT4Z
O.D.: 1 3/4 (44.5)
I.D.: 15/16 (23.8) One End
Height: 4 1/2 (114.3)
O-Ring: [1] Attached

PT23276-MPG Maximum Performance Glass Hydraulic Element



Fits: Pall Applications
Replaces: Pall HC2237FDT13H
O.D.: 3 9/16 (90.5)
I.D.: 1 9/16 (39.7) One End
Height: 12 15/16 (328.6)
O-Ring: [1] Attached

PT23271-MPG Maximum Performance Glass Hydraulic Element



Fits: Pall Applications
Replaces: Pall HC9600FDS16Z, HC9600FKS16Z, HC9600FUS16Z
O.D.: 3 (76.2)
I.D.: 1 11/32 (34.1) One End
Height: 16 15/32 (418.3)
O-Ring: [1] Attached

PT23277-MPG Maximum Performance Glass Hydraulic Element



Fits: Pall Applications
Replaces: Pall HC8900FDS13Z, HC8900FKS13Z, HC900FUS13Z
O.D.: 3 13/16 (96.8)
I.D.: 2 1/4 (57.2) One End
Height: 13 (330.2)
O-Ring: [1] Viton Attached
Related To: PT23223-MPG (Standard Gasket)

Measurements Are Shown In Inches And (Millimeters)

WARNING: These products can expose you to chemicals, including Diisononyl Phthalate, Carbon black extracts, Nickel, 1,3 Butadiene, Ethylene Oxide, Epichlorohydrin, which are known to the State of California to cause cancer, and Bisphenol, Ethylene Glycol, Ethylene Oxide, 1,3 Butadiene, Epichlorohydrin, which are known to the State of California to cause birth defects or other reproductive harm. For more information go to www.P65Warnings.ca.gov.

PT23278-MPG Maximum Performance Glass Hydraulic Element



Fits: Pall Applications
Replaces: Pall HC9100FKT13Z
O.D.: 2 13/16 (71.4)
I.D.: 1 15/16 (49.3) One End
Height: 13 (330.2)
O-Ring: [1] Attached

PT23284-MPG Maximum Performance Glass Hydraulic Element



Fits: Parker Applications
Replaces: Parker 925838, G01316Q
O.D.: 2 3/16 (55.6)
I.D.: 1 1/32 (26.2)
Height: 9 11/16 (246.1)
O-Ring: [1] Attached

PT23279-MPG Maximum Performance Glass Hydraulic Element



Fits: Pall Applications
Replaces: Pall HC9600FDN16Z, HC9600FKN16Z, HC9600FUN16Z
O.D.: 3 1/8 (79.4)
I.D.: 1 11/32 (34.1) One End
Height: 16 15/32 (418.3)
O-Ring: [1] Attached

PT23285-MPG Maximum Performance Glass Hydraulic Element



Fits: Pall Applications
Replaces: Pall HC9020FDT8Z, HC9020FKT8Z, HC9020FUT8Z
O.D.: 1 3/4 (44.5)
I.D.: 15/16 (23.8) One End
Height: 8 3/16 (208.0)
O-Ring: [1] Viton Attached

PT23280-MPG Maximum Performance Glass Hydraulic Element



Fits: Pall Applications
Replaces: Pall HC9800FDN4Z, HC9800FKN4Z, HC9800FUN4Z
O.D.: 1 31/32 (50.0)
I.D.: 7/8 (22.2) One End
Height: 4 1/2 (114.3)
O-Ring: [1] Attached

PT23286-MPG Maximum Performance Glass Hydraulic Element



Fits: Pall Applications
Replaces: Pall HC9800FDT4Z, HC9800FKT4Z, HC9800FUT4Z
O.D.: 2 (50.8)
I.D.: 15/16 (23.8) One End
Height: 4 1/2 (114.3)
O-Ring: [1] Attached

PT23281-MPG Maximum Performance Glass Hydraulic Element



Fits: Fairey-Arlon Applications
Replaces: Fairey-Arlon 270L205A, 270L222A, 270Z205A, 270Z222A
O.D.: 3 7/8 (98.4)
I.D.: 1 9/32 (32.5) One End
Height: 9 9/16 (242.9)
O-Ring: [1] Attached, [1] Included

PT23287-MPG Maximum Performance Glass Hydraulic Element



Fits: Hydac Applications
Replaces: Hydac 2055761, 280D020BN3HC, 280D020BNHC, 280D020BNHC2
O.D.: 2 3/4 (69.9)
I.D.: 1 3/8 (34.9) One End
Height: 14 (355.6)
O-Ring: [1] Attached

PT23282-MPG Maximum Performance Glass Hydraulic Element



Fits: Schroeder Applications
Replaces: Schroeder 27KS1, 27KZ3, KKKZ3; Donaldson P174246, P566278, P566279
O.D.: 4 (101.6)
I.D.: 1 3/4 (44.5)
Height: 27 11/16 (703.2)
O-Ring: [2] Attached

PT23289-MPG Maximum Performance Glass Hydraulic Element



Fits: Pall Applications
Replaces: P.T.I. (PTI/textron) PG050HH
O.D.: 3 5/32 (80.2)
I.D.: 1 15/32 (37.3)
Height: 5 9/16 (141.2)

PT23283-MPG Maximum Performance Glass Hydraulic Element



Fits: Pall Applications
Replaces: Pall HC8900FDS8Z, HC8900FKS8Z, HC8900FUS8Z
O.D.: 3 3/4 (95.3)
I.D.: 2 1/8 (54.0) One End
Height: 8 1/16 (204.8)
O-Ring: [1] Attached

PT23290-MPG Maximum Performance Glass Hydraulic Element



Fits: Fairey-Arlon Applications
Replaces: Fairey-Arlon 170L205A, 170Z222A, 170Z205A
O.D.: 2 1/8 (54.0)
I.D.: 3/4 (19.1) One End
Height: 4 13/16 (122.2)
O-Ring: [1] Attached, [1] Included

Measurements Are Shown In Inches And (Millimeters)

WARNING: These products can expose you to chemicals, including Diisononyl Phthalate, Carbon black extracts, Nickel, 1,3 Butadiene, Ethylene Oxide, Epichlorohydrin, which are known to the State of California to cause cancer, and Bisphenol, Ethylene Glycol, Ethylene Oxide, 1,3 Butadiene, Epichlorohydrin, which are known to the State of California to cause birth defects or other reproductive harm. For more information go to www.P65Warnings.ca.gov.

PT23291-MPG Maximum Performance Glass Hydraulic Element



Fits: Parker Applications
Replaces: Parker 929923, 929923Q
O.D.: 3 3/4 (95.3)
I.D.: 2 5/16 (58.7) One End
Height: 12 7/8 (327.0)
O-Ring: [1] Attached

PT23306

Wire Mesh Media Hydraulic Strainer
Contains: Threaded End: 2 1/8-8 NPT
Fits: Case, New Holland Loaders
Replaces: New Holland L128515
O.D.: 4 7/32 (107.2)
Height: 9 1/4 (235.0)



PT23292-MPG Maximum Performance Glass Hydraulic Element



Fits: International Applications
Replaces: Case 1328276C1
O.D.: 2 1/8 (54.0)
I.D.: 15/16 (23.8) One End
Height: 4 11/16 (119.1)
O-Ring: [1] Attached

PT23308

Hydraulic Element
Fits: Argo Applications
Replaces: Argo P3072000
O.D.: 2 3/4 (69.9)
I.D.: 1 1/32 (26.2) One End
Height: 7 27/32 (199.2)
O-Ring: [1] Attached



PT23294-MPG Maximum Performance Glass Hydraulic Element



Fits: Pall Applications
Replaces: Pall HC9020FDS4Z, HC9020FKS4Z, HC9020FUS4Z
O.D.: 1 11/16 (42.9)
I.D.: 15/16 (23.8) One End
Height: 4 3/8 (111.1)
O-Ring: [1] Attached

PT23309

Hydraulic Element
Fits: Argo Applications
Replaces: Argo P3051002
O.D.: 1 25/32 (45.2)
I.D.: 13/16 (20.6) One End
Height: 4 3/32 (104.0)
O-Ring: [1] Attached



PT23295-MPG Maximum Performance Glass Hydraulic Element



Fits: Manitou Applications
Replaces: Manitou 236094
O.D.: 2 11/16 (68.3)
I.D.: 1 1/8 (28.6) One End
Height: 9 5/8 (244.5)
O-Ring: [1] Attached

PT23310

Hydraulic Element
Contains: By-Pass Valve
Fits: Argo Applications
Replaces: Argo K3092072
O.D.: 3 9/32 (83.3)
I.D.: 1 5/8 (41.3) One End
Height: 8 (203.2)
O-Ring: [1] Attached



PT23296-MPG Maximum Performance Glass Hydraulic Element



Fits: Pall Applications
Replaces: Pall HC6300FDT8H, HC6300FKT8H, HC6300FUT8H
O.D.: 3 1/16 (77.8)
I.D.: 1 5/8 (41.3) One End
Height: 8 (203.2)
O-Ring: [1] Attached

PT23311

Hydraulic Element
Fits: Eppensteiner Applications
Replaces: Eppensteiner 290P10A000P
O.D.: 2 3/32 (53.2)
I.D.: 1/32 (0.8) & 1/16 (1.5)
Height: 5 7/8 (149.2)
O-Ring: [1] Attached



PT23297

Hydraulic Element



Fits: Schroeder Applications
Replaces: Schroeder KM150
O.D.: 3 15/16 (100.0)
I.D.: 1 11/16 (42.9)
Height: 9 5/16 (236.5)
O-Ring: [2] Attached

PT23312

Hydraulic Element



Fits: Eppensteiner Applications
Replaces: Eppensteiner 2225P25A00P
O.D.: 2 15/16 (74.6)
I.D.: 1 1/2 (38.1) One End
Height: 8 15/16 (227.0)
O-Ring: [1] Attached

Measurements Are Shown In Inches And (Millimeters)

 **WARNING:** These products can expose you to chemicals, including Diisononyl Phthalate, Carbon black extracts, Nickel, 1,3 Butadiene, Ethylene Oxide, Epichlorohydrin, which are known to the State of California to cause cancer, and Bisphenol, Ethylene Glycol, Ethylene Oxide, 1,3 Butadiene, Epichlorohydrin, which are known to the State of California to cause birth defects or other reproductive harm. For more information go to www.P65Warnings.ca.gov.

PT23313



Hydraulic Element

Fits: Fairey-Arlon Applications
Replaces: Fairey-Arlon TXX7A10
O.D.: 4 31/32 (126.2)
I.D.: 3/8 (9.5) & 3 5/8 (92.1)
Height: 9 27/32 (250.0)

PT23319



Hydraulic Element

Fits: Mahle Applications
Replaces: Mahle 852493MIC10
O.D.: 1 21/32 (42.1)
I.D.: 29/32 (23.0)
Height: 3 5/8 (92.1)
O-Ring: [2] Attached

PT23314



Hydraulic Element

Fits: Fairey-Arlon Applications
Replaces: Fairey-Arlon TXX10
O.D.: 2 27/32 (72.2)
I.D.: 11/32 (8.7)
Height: 2 5/32 (54.8)

PT23320



Hydraulic Element

Fits: Mahle Applications
Replaces: Mahle 852443MIC25
O.D.: 2 5/16 (58.7)
I.D.: 15/16 (23.8) & 1 5/16 (33.3)
Height: 4 1/16 (103.2)
O-Ring: [1] Attached

PT23315



Hydraulic Element

Fits: Mahle Applications
Replaces: Mahle 852436MIC10
O.D.: 5 1/16 (128.6)
I.D.: 2 21/32 (67.5) & 2 13/16 (71.4)
Height: 12 9/16 (319.1)
O-Ring: [1] Attached

PT23321



Hydraulic Element

Fits: Mahle Applications
Replaces: Mahle 852444MIC25
O.D.: 2 9/32 (57.9)
I.D.: 13/16 (20.6) & 1 9/32 (32.5)
Height: 7 3/32 (180.2)
O-Ring: [1] Attached

PT23316



Hydraulic Element

Fits: Mahle Applications
Replaces: Mahle 852438MIC10
O.D.: 3 29/32 (99.2)
I.D.: 1 29/32 (48.4) & 2 1/16 (52.3)
Height: 6 1/4 (158.8)
O-Ring: [1] Attached

PT23322



Hydraulic Element

Fits: Mahle Applications
Replaces: Mahle 852126MICVST10
O.D.: 1 3/4 (44.5)
I.D.: 1 (25.4) One End
Height: 4 15/32 (113.5)
O-Ring: [1] Attached

PT23317



Hydraulic Element

Fits: Mahle Applications
Replaces: Mahle 852439MIC10
O.D.: 3 15/16 (100.0)
I.D.: 2 (50.8) & 2 1/2 (63.5)
Height: 8 1/2 (216.0)
O-Ring: [1] Attached

PT23323



Hydraulic Element

Fits: Parker Applications
Replaces: Parker 908643;
Donaldson P173617, P168481
O.D.: 4 1/4 (108.0)
I.D.: 3 1/16 (77.7)
Height: 9 13/16 (249.2)
F. Gskt: [1] Included
End Seals: [2] Attached

PT23318



Hydraulic Element

Fits: Mahle Applications
Replaces: Mahle 852754MIC25
O.D.: 4 (101.6)
I.D.: 2 1/2 (63.5)
Height: 19 (482.6)
O-Ring: [2] Attached

PT23324



Hydraulic Element

Fits: Parker Applications
Replaces: Parker 924791;
Donaldson P169559
O.D.: 3 21/32 (92.8)
I.D.: 1 3/4 (44.5)
Height: 18 1/2 (469.9)
Grommets: [2] Attached

Measurements Are Shown In Inches And (Millimeters)



WARNING: These products can expose you to chemicals, including Diisononyl Phthalate, Carbon black extracts, Nickel, 1,3 Butadiene, Ethylene Oxide, Epichlorohydrin, which are known to the State of California to cause cancer, and Bisphenol, Ethylene Glycol, Ethylene Oxide, 1,3 Butadiene, Epichlorohydrin, which are known to the State of California to cause birth defects or other reproductive harm. For more information go to www.P65Warnings.ca.gov.

PT23325



Hydraulic Element

Fits: Eppensteiner Applications
Replaces: Eppensteiner 2360G252P,
2360G25C000P; Donaldson P561439
O.D.: 3 1/16 (77.8)
I.D.: 1 19/32 (40.5) One End
Height: 11 1/16 (281.0)
O-Ring: [1] Attached

PT23331



Hydraulic Element

Fits: Parker Applications
Replaces: Parker 909309
O.D.: 5 1/2 (139.7)
I.D.: 4 3/16 (106.3)
Height: 12 3/16 (309.6)
F. Gskt: [1] Included
End Seals: [1] Attached

PT23326



Hydraulic Element

Fits: Eppensteiner Applications
Replaces: Eppensteiner 20015G25A000P
O.D.: 2 7/16 (62.0)
I.D.: 1 3/8 (35.0) One End
Height: 7 (177.8)
O-Ring: [1] Attached

PT23332



Hydraulic Element

Fits: Parker Applications
Replaces: Parker 922627, G01280, G01280Q
O.D.: 2 11/32 (59.5)
I.D.: 1 13/32 (35.7)
Height: 5 5/16 (134.9)
O-Ring: [1] Attached

PT23327



Hydraulic Element

Fits: Fairey-Arlon Applications
Replaces: Fairey-Arlon ST3D60;
Donaldson CRS120.6, P171796
O.D.: 2 13/16 (71.4)
I.D.: 5/8 (7.9) & 1 3/4 (44.4)
Height: 7 7/8 (200.0)
O-Ring: [1] Attached

PT23333



Hydraulic Element

Contains: 3/4-14 Inch BSP Threaded Stud
By-Pass Valve
Fits: U.C.C. Hydraulics Applications
Replaces: U.C.C. UCSE5101
O.D.: 2 1/2 (63.5)
I.D.: 1 31/32 (50.0) One End
Height: 4 9/32 (108.7)

PT23328



Hydraulic Element

Contains: 1 1/4 Inch NPT Threaded Stud
Fits: Flow-Ezy Applications
Replaces: Flow-Ezy P10114100, P20114100
O.D.: 3 13/32 (86.5)
I.D.: 2 9/16 (65.1) One End
Height: 5 15/32 (139.0)

PT23334



Hydraulic Element

Contains: 1 1/2-11 Inch BSP Threaded Stud
By-Pass Valve
Fits: U.C.C. Hydraulics Applications
Replaces: U.C.C. UCSE5103
O.D.: 3 13/32 (86.5)
I.D.: 2 9/16 (65.1) One End
Height: 5 15/32 (139.0)

PT23329



Hydraulic Element

Contains: 1/2-14 Inch BSP Threaded Stud
Fits: MP Filtri Applications
Replaces: MP Filtri MPA025G1M90
O.D.: 2 7/8 (73.0)
I.D.: 1 11/32 (34.1) One End
Height: 4 3/32 (104.0)

PT23335



Hydraulic Element

Contains: 3-11 Inch BSP Threaded Stud
Fits: U.C.C. Hydraulics Applications
Replaces: U.C.C. UCSE5108
O.D.: 5 29/32 (150.0)
I.D.: 4 5/16 (109.5) One End
Height: 10 23/32 (272.3)

PT23330



Hydraulic Element

Contains: 1 1/4-11 Inch BSP Threaded Stud
Fits: MP Filtri Applications
Replaces: MP Filtri MPA095G1M90,
STR1001SG1M90
O.D.: 4 1/32 (102.4)
I.D.: 2 11/32 (59.5) One End
Height: 6 3/32 (154.8)

PT23336



Hydraulic Element

Fits: Vickers Applications
Replaces: Vickers 361741;
Donaldson P168446, P173584
O.D.: 4 1/32 (102.4)
I.D.: 2 29/32 (73.8)
Height: 6 1/4 (158.8)
O-Ring: [1] Attached, [1] Included

Measurements Are Shown In Inches And (Millimeters)

 **WARNING:** These products can expose you to chemicals, including Diisononyl Phthalate, Carbon black extracts, Nickel, 1,3 Butadiene, Ethylene Oxide, Epichlorohydrin, which are known to the State of California to cause cancer, and Bisphenol, Ethylene Glycol, Ethylene Oxide, 1,3 Butadiene, Epichlorohydrin, which are known to the State of California to cause birth defects or other reproductive harm. For more information go to www.P65Warnings.ca.gov.

PT23337

Hydraulic Element



Fits: Vickers Applications
Replaces: Vickers 361739
O.D.: 2 7/16 (62.0)
I.D.: 1 1/2 (38.1)
Height: 3 3/4 (95.3)
O-Ring: [1] Included

PT23343-MPG

Maximum Performance Glass Hydraulic Element



Fits: Fairey-Arlon Applications
Replaces: Fairey-Arlon TXW14CC10, TXW14GDL10; Fleetguard HF35134
O.D.: 7 31/32 (202.4)
I.D.: 9/16 (14.3) & 6 3/16 (157.1)
Height: 42 29/32 (1089.8)
O-Ring: [1] Attached

PT23338-MPG

Maximum Performance Glass Hydraulic Element



Fits: Argo Applications
Replaces: Argo V3051018
O.D.: 1 13/16 (46.0)
I.D.: 13/16 (20.6) One End
Height: 4 1/16 (103.2)
O-Ring: [1] Attached

PT23344-MPG

Maximum Performance Glass Hydraulic Element



Fits: Fairey-Arlon Applications
Replaces: Fairey-Arlon TXW3BCC10, TXW3BGDL10
O.D.: 4 3/16 (106.3)
I.D.: 13/32 (10.3) & 2 13/16 (71.4)
Height: 5 1/2 (139.7)
O-Ring: [1] Attached

PT23339-MPG

Maximum Performance Glass Hydraulic Element



Fits: Argo Applications
Replaces: Argo V3082318
O.D.: 3 1/16 (77.8)
I.D.: 1 9/16 (39.7) One End
Height: 9 5/32 (232.6)
O-Ring: [1] Attached

PT23345-MPG

Maximum Performance Glass Hydraulic Element



Fits: Fairey-Arlon Applications
Replaces: Fairey-Arlon TXW5GDL3, TXW5CC3
O.D.: 4 3/16 (106.3)
I.D.: 13/32 (10.3) & 2 13/16 (71.4)
Height: 10 1/4 (260.4)

PT23340-MPG

Maximum Performance Glass Hydraulic Element



Fits: Eppensteiner Applications
Replaces: Eppensteiner 2225H20SLC000P
O.D.: 3 1/16 (77.8)
I.D.: 1 19/32 (40.5) One End
Height: 9 3/32 (231.0)
O-Ring: [1] Attached

PT23346-MPG

Maximum Performance Glass Hydraulic Element



Fits: Fairey-Arlon Applications
Replaces: Fairey-Arlon 330X101, 370L1FFA, 370L120A, 370Z1FFA, 370Z120, 830X101
O.D.: 3 3/4 (95.2)
I.D.: 1 15/16 (31.8) & 1 29/32 (48.4)
Height: 4 1/8 (104.8)
O-Ring: [1] Attached, [1] Included

PT23341-MPG

Maximum Performance Glass Hydraulic Element



Fits: Eppensteiner Applications
Replaces: Eppensteiner 2460H20SLC000P; Donaldson P561451
O.D.: 3 1/16 (77.8)
I.D.: 1 19/32 (40.5) One End
Height: 15 (381.0)
O-Ring: [1] Attached

PT23347-MPG

Maximum Performance Glass Hydraulic Element



Fits: Fairey-Arlon Applications
Replaces: Fairey-Arlon MXW2CC25, MXW2GDL20
O.D.: 2 11/32 (59.5)
I.D.: 1 1/16 (27.0) One End
Height: 9 25/32 (248.4)

PT23342-MPG

Maximum Performance Glass Hydraulic Element



Fits: Eppensteiner Applications
Replaces: Eppensteiner 1361H10SLA000P
O.D.: 3 15/16 (100.0)
I.D.: 2 7/16 (62.0)
Height: 9 5/16 (236.5)
O-Ring: [2] Attached

PT23348-MPG

Maximum Performance Glass Hydraulic Element



Fits: Fairey-Arlon Applications
Replaces: Fairey-Arlon 330X301, 370L3FFA, 370L320A, 370Z3FFA, 830X301
O.D.: 3 11/16 (93.7)
I.D.: 1 7/32 (31.0) & 1 29/32 (48.4)
Height: 12 19/32 (319.9)
O-Ring: [1] Attached, [1] Included

Measurements Are Shown In Inches And (Millimeters)



WARNING: These products can expose you to chemicals, including Diisononyl Phthalate, Carbon black extracts, Nickel, 1,3 Butadiene, Ethylene Oxide, Epichlorohydrin, which are known to the State of California to cause cancer, and Bisphenol, Ethylene Glycol, Ethylene Oxide, 1,3 Butadiene, Epichlorohydrin, which are known to the State of California to cause birth defects or other reproductive harm. For more information go to www.P65Warnings.ca.gov.

PT23349-MPG Maximum Performance Glass Stacked Hydraulic Element



Fits: Fairey-Arlon Applications
Replaces: Fairey-Arlon TXW8DCC25, TXW8DGD20
O.D.: 5 29/32 (150.0)
I.D.: 4 5/32 (105.5)
Height: 16 13/16 (427.0)
O-Ring: [1] Attached

PT23355-MPG Maximum Performance Glass Hydraulic Element



Fits: Hycon Applications
Replaces: Hycon HC8400FUP16H; Donaldson P169438
O.D.: 5 31/32 (151.6)
I.D.: 3 1/4 (82.5)
Height: 16 13/16 (427.0)
O-Ring: [2] Attached

PT23350-MPG Maximum Performance Glass Hydraulic Element



Fits: Fairey-Arlon Applications
Replaces: Fairey-Arlon 270Z1FFA
O.D.: 2 15/16 (74.6)
I.D.: 1 1/4 (31.7) One End
Height: 4 3/16 (106.4)
O-Ring: [1] Included

PT23356-MPG Maximum Performance Glass Hydraulic Element



Fits: Hydac Applications
Replaces: Hydac 280D101BH3HC
O.D.: 2 3/4 (69.9)
I.D.: 1 5/16 (33.3) One End
Height: 14 (355.6)
O-Ring: [1] Attached

PT23351-MPG Maximum Performance Glass Hydraulic Element



Fits: Fairey-Arlon Applications
Replaces: Fairey-Arlon 370L101A
O.D.: 3 11/16 (93.6)
I.D.: 1 15/16 (49.2)
Height: 4 1/16 (103.2)
O-Ring: [1] Attached, [1] Included

PT23357-MPG Maximum Performance Glass Hydraulic Element



Fits: Hydac Applications
Replaces: Hydac 160D003BNHC
O.D.: 2 3/4 (69.9)
I.D.: 1 3/4 (34.5) One End
Height: 4 1/2 (114.3)
O-Ring: [1] Attached

PT23352-MPG Maximum Performance Glass Hydraulic Element



Fits: Fairey-Arlon Applications
Replaces: Fairey-Arlon 170L1FFA, 170Z1FFA, 170L120A
O.D.: 3 23/32 (94.4)
I.D.: 25/32 (19.8) & 1 29/32 (48.4)
Height: 17 3/32 (434.1)
O-Ring: [1] Attached, [1] Included

PT23358-MPG Maximum Performance Glass Hydraulic Element



Fits: Hydac Applications
Replaces: Hydac 1262051, 75D020BNHC, 75D020BN3HC, 75D020BNHC2
O.D.: 2 7/32 (56.3)
I.D.: 1 (25.4) One End
Height: 6 11/16 (169.8)
O-Ring: [1] Attached

PT23353-MPG Maximum Performance Glass Hydraulic Element



Fits: FBO Applications
Replaces: FBO 456.51; Donaldson P171746
O.D.: 3 1/16 (77.8)
I.D.: 1 19/32 (40.5) One End
Height: 14 3/4 (374.7)
O-Ring: [1] Attached

PT23359-MPG Maximum Performance Glass Hydraulic Element with Bail Handle



Fits: Hydac Applications
Replaces: Hydac 500R005BNHC
O.D.: 3 3/4 (95.2)
I.D.: 1 15/16 (49.2) One End
Height: 11 (279.4)
O-Ring: [1] Attached

PT23354-MPG Maximum Performance Glass Hydraulic Element



Fits: FBO Applications
Replaces: FBO 456.53; Donaldson P171748
O.D.: 3 1/16 (77.8)
I.D.: 1 19/32 (40.5) One End
Height: 14 3/4 (374.7)
O-Ring: [1] Attached

PT23360-MPG Maximum Performance Glass Hydraulic Element with Bail Handle



Contains: By-Pass Valve
Fits: Hydac Applications
Replaces: Hydac 2059110, 1300R005BNHC, 1300R005BNHC2
O.D.: 5 21/32 (143.7)
I.D.: 3 3/4 (95.3) & 3 25/32 (96.0)
Height: 19 1/32 (483.4)
O-Ring: [1] Attached

Measurements Are Shown In Inches And (Millimeters)

WARNING: These products can expose you to chemicals, including Diisononyl Phthalate, Carbon black extracts, Nickel, 1,3 Butadiene, Ethylene Oxide, Epichlorohydrin, which are known to the State of California to cause cancer, and Bisphenol, Ethylene Glycol, Ethylene Oxide, 1,3 Butadiene, Epichlorohydrin, which are known to the State of California to cause birth defects or other reproductive harm. For more information go to www.P65Warnings.ca.gov.

PT23361-MPG Maximum Performance Glass Hydraulic Element



Fits: Hydac Applications
Replaces: Hydac 1260905, 2055754, 240D003BNHC, 240D003BNHC2, 240D003BN3HC
O.D.: 2 23/32 (69.1)
I.D.: 1 11/32 (34.1) One End
Height: 6 13/16 (173.0)
O-Ring: [1] Attached

PT23362-MPG Maximum Performance Glass Hydraulic Element with Bail Handle



Contains: By-Pass Valve
Fits: Hydac Applications
Replaces: Hydac 2060548, 850R020BNHC, 850F020BNHC2, 850R020BN3HC
O.D.: 4 1/2 (114.3)
I.D.: 2 9/16 (65.0) & 2 23/32 (69.0)
Height: 15 1/2 (393.7)
O-Ring: [1] Attached

PT23363-MPG Maximum Performance Glass Hydraulic Element



Fits: Hydac Applications
Replaces: Hydac 1260907, 2055736, 330D003BNHC, 330D003BNHC2, 330D003BN3HC
O.D.: 3 9/16 (90.4)
I.D.: 1 29/32 (48.4) One End
Height: 6 3/8 (162.0)
O-Ring: [1] Attached

PT23364-MPG Maximum Performance Glass Hydraulic Element with Bail Handle



Contains: By-Pass Valve
Fits: Hydac Applications
Replaces: Hydac 1263016, 2059104, 660R005BNHC, 660R005BNHC2
O.D.: 4 1/2 (114.3)
I.D.: 2 9/16 (65.0) & 2 23/32 (69.0)
Height: 12 3/8 (314.3)
O-Ring: [1] Attached

PT23365-MPG Maximum Performance Glass Hydraulic Element



Fits: Hydac Applications
Replaces: Hydac 2055988, 240D003BHHC, 240D003BHHC2
O.D.: 2 23/32 (69.1)
I.D.: 1 11/32 (34.1) One End
Height: 6 13/16 (173.0)
O-Ring: [1] Attached

PT23366-MPG Maximum Performance Glass Hydraulic Element with Bail Handle



Contains: By-Pass Valve
Fits: Hydac Applications
Replaces: Hydac 2066035, 550R003BNHC, 500R003BNHC2
O.D.: 2 23/32 (69.1)
I.D.: 1 25/32 (45.2) & 1 29/32 (48.4)
Height: 10 9/32 (261.1)
O-Ring: [1] Attached

PT23367-MPG Maximum Performance Glass Hydraulic Element



Fits: Hydac Applications
Replaces: Hydac 2056688, 30D003BH3HC
O.D.: 1 3/8 (34.9)
I.D.: 15/32 (11.9) One End
Height: 3 21/32 (92.9)
O-Ring: [1] Attached

PT23368-MPG Maximum Performance Glass Hydraulic Element



Fits: Hydac Applications
Replaces: Hydac 2055745, 660D003BNHC, 660D003BNHC2
O.D.: 3 9/16 (90.4)
I.D.: 1 29/32 (48.4) One End
Height: 12 29/32 (327.8)
O-Ring: [1] Attached

PT23369-MPG Maximum Performance Glass Hydraulic Element



Fits: Hydac Applications
Replaces: Hydac 2055973, 110D003BHHC, 110D003BHHC2
O.D.: 1 27/32 (46.8)
I.D.: 7/8 (22.2) One End
Height: 6 1/32 (153.1)
O-Ring: [1] Attached

PT23370-MPG Maximum Performance Glass Hydraulic Element



Fits: Hydac Applications
Replaces: Hydac 2055737, 330D002BNHC, 330D005BNHC2
O.D.: 3 9/16 (90.4)
I.D.: 1 29/32 (48.4) One End
Height: 6 3/8 (162.0)
O-Ring: [1] Attached

PT23371-MPG Maximum Performance Glass Hydraulic Element



Fits: Hydac Applications
Replaces: Hydac 2055906, 110D003BNHC, 110D003BN3HC
O.D.: 1 27/32 (46.8)
I.D.: 7/8 (22.2) One End
Height: 6 1/32 (153.1)
O-Ring: [1] Attached

PT23372-MPG Maximum Performance Glass Hydraulic Element



Fits: Hydac Applications
Replaces: Hydac 2056437, 330D003BHHC, 330D003BHHC2
O.D.: 3 17/32 (89.7)
I.D.: 1 29/32 (48.4) One End
Height: 6 3/8 (162.0)
O-Ring: [1] Attached

Measurements Are Shown In Inches And (Millimeters)

WARNING: These products can expose you to chemicals, including Diisononyl Phthalate, Carbon black extracts, Nickel, 1,3 Butadiene, Ethylene Oxide, Epichlorohydrin, which are known to the State of California to cause cancer, and Bisphenol, Ethylene Glycol, Ethylene Oxide, 1,3 Butadiene, Epichlorohydrin, which are known to the State of California to cause birth defects or other reproductive harm. For more information go to www.P65Warnings.ca.gov.

PT23373-MPG Maximum Performance Glass Hydraulic Element



Fits: Hydac Applications
Replaces: Hydac 2055929, 140D005BNHC, 140D005BNHC2
O.D.: 1 27/32 (46.8)
I.D.: 7/8 (22.2) One End
Height: 7 19/32 (192.9)
O-Ring: [1] Attached

PT23379-MPG Maximum Performance Glass Hydraulic Element



Fits: Hydac Applications
Replaces: Hydac 2022902, 60D003BNHC, 60D003BNHC2
O.D.: 1 27/32 (46.8)
I.D.: 7/8 (22.2) One End
Height: 3 5/16 (84.1)
O-Ring: [1] Attached

PT23374-MPG Maximum Performance Glass Hydraulic Element



Fits: Hydac Applications
Replaces: Hydac 2055958, 60D003BHHC, 60D003BHHC2
O.D.: 1 27/32 (46.8)
I.D.: 7/8 (22.2) One End
Height: 3 5/16 (84.1)
O-Ring: [1] Attached

PT23380-MPG Maximum Performance Glass Hydraulic Element



Fits: Pall Applications
Replaces: Pall HC8900FDT8H, HC8900FKT8H, HC8900FUT8H
O.D.: 3 25/32 (96.0)
I.D.: 2 7/32 (56.4) One End
Height: 8 3/32 (205.5)
O-Ring: [1] Attached

PT23375-MPG Maximum Performance Glass Hydraulic Element with Bail Handle

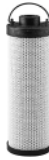

Contains: By-Pass Valve
Fits: Hydac Applications
Replaces: Hydac 2059097, 110R020BNHC, 110R020BNHC2
O.D.: 2 1/32 (51.5)
I.D.: 7/8 (22.2) & 15/16 (23.8)
Height: 6 9/32 (159.5)
O-Ring: [1] Attached

PT23381-MPG Maximum Performance Glass Hydraulic Element



Fits: Mahle Applications
Replaces: Mahle PI3245SMVST10, PI3245SMXVST10
O.D.: 3 9/32 (83.3)
I.D.: 1 27/32 (46.8) One End
Height: 14 11/16 (373.0)
O-Ring: [1] Attached

PT23376-MPG Maximum Performance Glass Hydraulic Element



Fits: Hydac Applications
Replaces: Hydac 2055984, 160D003BHHC, 160D003BHHC2
O.D.: 2 23/32 (69.1)
I.D.: 1 11/32 (34.1) One End
Height: 4 17/32 (115.0)
O-Ring: [1] Attached

PT23382-MPG Maximum Performance Glass Hydraulic Element



Fits: Mahle Applications
Replaces: Mahle PI3211SMVST10, PI3211SMXVST10
O.D.: 1 27/32 (46.8)
I.D.: 1 (25.4) One End
Height: 9 11/16 (246.1)
O-Ring: [1] Attached

PT23377-MPG Maximum Performance Glass Hydraulic Element



Fits: Hydac Applications
Replaces: Hydac 12556542, 2056542, 30D005BN3HC
O.D.: 1 3/8 (34.9)
I.D.: 1/2 (12.7) One End
Height: 3 21/32 (92.9)
O-Ring: [1] Attached

PT23383-MPG Maximum Performance Glass Hydraulic Element



Fits: Mahle Applications
Replaces: Mahle PI5230SMVST6, PI5230SMXVST6
O.D.: 3 9/32 (83.3)
I.D.: 1 27/32 (46.8) One End
Height: 10 1/32 (254.7)
O-Ring: [1] Attached

PT23378-MPG Maximum Performance Glass Hydraulic Element



Fits: Hydac Applications
Replaces: Hydac 2055928, 140D003BNHC, 140D003BNHC2
O.D.: 1 27/32 (46.8)
I.D.: 7/8 (22.2) One End
Height: 7 19/32 (192.9)
O-Ring: [1] Attached

PT23384-MPG Maximum Performance Glass Hydraulic Element



Fits: Mahle Applications
Replaces: Mahle PI3205SMXVST10
O.D.: 1 7/8 (47.6)
I.D.: 1 (25.4) One End
Height: 3 3/4 (95.3)
O-Ring: [1] Attached

Measurements Are Shown In Inches And (Millimeters)

WARNING: These products can expose you to chemicals, including Diisononyl Phthalate, Carbon black extracts, Nickel, 1,3 Butadiene, Ethylene Oxide, Epichlorohydrin, which are known to the State of California to cause cancer, and Bisphenol, Ethylene Glycol, Ethylene Oxide, 1,3 Butadiene, Epichlorohydrin, which are known to the State of California to cause birth defects or other reproductive harm. For more information go to www.P65Warnings.ca.gov.

PT23385-MPG Maximum Performance Glass Hydraulic Element



Fits: Mahle Applications
Replaces: Mahle PI2230SMVST3, PI2230SMXVST3
O.D.: 3 1/4 (82.6)
I.D.: 1 27/32 (46.8) One End
Height: 10 1/32 (254.7)
O-Ring: [1] Attached

PT23391-MPG Maximum Performance Glass Hydraulic Element



Fits: Fairey-Arlon Applications
Replaces: Fairey-Arlon TXW3DCC3
O.D.: 2 7/8 (73.0)
I.D.: 5/8 (7.9) & 1 7/8 (47.6)
Height: 7 15/16 (201.6)
O-Ring: [1] Attached

PT23386-MPG Maximum Performance Glass Hydraulic Element



Fits: Mahle Applications
Replaces: Mahle PI3230SMXVST10
O.D.: 3 5/16 (84.1)
I.D.: 1 7/8 (47.6)
Height: 10 (254.0)

PT23392-MPG Maximum Performance Glass Hydraulic Element



Fits: Fairey-Arlon Applications
Replaces: Fairey-Arlon TXW5ACC3
O.D.: 4 3/16 (106.3)
I.D.: 13/32 (10.3) & 2 13/16 (71.4)
Height: 18 5/16 (465.1)
O-Ring: [1] Attached

PT23387-MPG Maximum Performance Glass Hydraulic Element



Fits: Mahle Applications
Replaces: Mahle PI4205SMXVST25
O.D.: 1 27/32 (46.8)
I.D.: 1 (25.4) One End
Height: 3 11/16 (93.7)
O-Ring: [1] Attached

PT23393-MPG Maximum Performance Glass Hydraulic Element



Fits: Pall Applications
Replaces: Pall HC8200FKT13Z
O.D.: 3 (76.2)
I.D.: 1 1/2 (38.1) One End
Height: 13 (330.2)
O-Ring: [2] Attached

PT23388-MPG Maximum Performance Glass Hydraulic Element



Fits: Mahle Applications
Replaces: Mahle 852444SM10, 852444SMX10
O.D.: 2 9/32 (57.9)
I.D.: 1 9/32 (32.5) One End
Height: 7 3/32 (180.2)
O-Ring: [1] Attached

PT23394-MPG Maximum Performance Glass Hydraulic Element



Fits: Pall Applications
Replaces: Pall HC6500FKS16H
O.D.: 3 25/32 (96.0)
I.D.: 2 7/32 (56.4) One End
Height: 16 13/16 (427.0)
O-Ring: [1] Attached

PT23389-MPG Maximum Performance Glass Hydraulic Element



Fits: Pall Applications
Replaces: Pall HC9801FDP8H, HC9801FUP8H, HC9801FKP8H
O.D.: 2 (50.8)
I.D.: 15/16 (23.8) One End
Height: 8 3/16 (208.0)
O-Ring: [1] Attached

PT23395-MPG Maximum Performance Glass Hydraulic Element



Fits: Pall Applications
Replaces: Pall HC9600FKS8Z
O.D.: 3 1/16 (77.8)
I.D.: 1 23/32 (43.7) One End
Height: 8 1/4 (209.5)
O-Ring: [1] Attached

PT23390-MPG Maximum Performance Glass Hydraulic Element



Fits: Fairey-Arlon Applications
Replaces: Fairey-Arlon TXW8ACCZ
O.D.: 4 31/32 (126.2)
I.D.: 13/32 (10.3) & 3 5/8 (92.1)
Height: 11 7/16 (290.5)
O-Ring: [1] Attached

PT23396-MPG Maximum Performance Glass Hydraulic Element



Fits: Pall Applications
Replaces: Pall HC9601FUP8H
O.D.: 3 1/16 (77.8)
I.D.: 1 11/16 (42.9) One End
Height: 8 1/4 (209.5)
O-Ring: [1] Attached

Measurements Are Shown In Inches And (Millimeters)

 **WARNING:** These products can expose you to chemicals, including Diisononyl Phthalate, Carbon black extracts, Nickel, 1,3 Butadiene, Ethylene Oxide, Epichlorohydrin, which are known to the State of California to cause cancer, and Bisphenol, Ethylene Glycol, Ethylene Oxide, 1,3 Butadiene, Epichlorohydrin, which are known to the State of California to cause birth defects or other reproductive harm. For more information go to www.P65Warnings.ca.gov.

PT23397-MPG Maximum Performance Glass Hydraulic Element



Fits: Pall Applications
Replaces: Pall HC9601FDT8Z
O.D.: 3 (76.2)
I.D.: 1 13/16 (46.0) One End
Height: 8 5/16 (211.1)
O-Ring: [1] Attached

PT23403-MPG Maximum Performance Glass Hydraulic Element



Fits: Pall Applications
Replaces: Pall HC8300FKT8H
O.D.: 6 (152.4)
I.D.: 4 5/32 (105.5)
Height: 8 5/32 (207.2)
O-Ring: [2] Attached

PT23398-MPG Maximum Performance Glass Hydraulic Element



Fits: Pall Applications
Replaces: Pall HC9601FKP8Z
O.D.: 3 1/16 (77.8)
I.D.: 1 11/16 (42.9) One End
Height: 8 1/4 (209.5)
O-Ring: [1] Attached

PT23404-MPG Maximum Performance Glass Hydraulic Element



Fits: Pall Applications
Replaces: Pall HC8300FKS8H
O.D.: 6 (152.4)
I.D.: 4 5/32 (105.5)
Height: 8 5/32 (207.2)
O-Ring: [2] Attached

PT23399-MPG Maximum Performance Glass Hydraulic Element with Bail Handle



Fits: Pall Applications
Replaces: Pall HC8904FKT16Z
O.D.: 3 27/32 (97.6)
I.D.: 2 17/32 (64.3) One End
Height: 6 11/32 (161.1)
O-Ring: [1] Attached

PT23405-MPG Maximum Performance Glass Hydraulic Element



Fits: Pall Applications
Replaces: Pall HC8300FKS8Z
O.D.: 6 (152.4)
I.D.: 4 1/2 (114.3)
Height: 8 1/4 (209.6)
O-Ring: [2] Attached

PT23400-MPG Maximum Performance Glass Hydraulic Element



Fits: Pall Applications
Replaces: Pall HC9801FUP4H
O.D.: 2 1/32 (51.6)
I.D.: 15/16 (23.8) One End
Height: 4 1/2 (114.3)
O-Ring: [1] Attached

PT23406-MPG Maximum Performance Glass Hydraulic Element



Fits: Pall Applications
Replaces: Pall HC8904FKS13H
O.D.: 3 13/16 (96.8)
I.D.: 2 1/2 (63.5) One End
Height: 14 7/8 (377.8)
O-Ring: [1] Attached

PT23401-MPG Maximum Performance Glass Hydraulic Element



Fits: Pall Applications
Replaces: Pall HC8900FKN13Z
O.D.: 3 25/32 (96.0)
I.D.: 2 7/32 (56.4) One End
Height: 12 29/32 (327.8)
O-Ring: [1] Attached

PT23407-MPG Maximum Performance Glass Hydraulic Element



Fits: Pall Applications
Replaces: Pall HC9604FKT8H, HC9604FKT8Z
O.D.: 3 1/8 (79.4)
I.D.: 1 15/16 (49.2)
Height: 8 (203.2)
O-Ring: [1] Attached

PT23402-MPG Maximum Performance Glass Hydraulic Element



Fits: Pall Applications
Replaces: Pall HC8800FKP16Z
O.D.: 3 13/32 (86.5)
I.D.: 1 31/32 (50.0) One End
Height: 16 13/16 (427.0)
O-Ring: [1] Attached













PT23408-MPG Maximum Performance Glass Hydraulic Element



Fits: Pall Applications
Replaces: Pall HC9601FKP4Z
O.D.: 3 1/16 (77.8)
I.D.: 1 11/16 (42.9) One End
Height: 4 21/32 (118.3)
O-Ring: [1] Attached

Measurements Are Shown In Inches And (Millimeters)

WARNING: These products can expose you to chemicals, including Diisononyl Phthalate, Carbon black extracts, Nickel, 1,3 Butadiene, Ethylene Oxide, Epichlorohydrin, which are known to the State of California to cause cancer, and Bisphenol, Ethylene Glycol, Ethylene Oxide, 1,3 Butadiene, Epichlorohydrin, which are known to the State of California to cause birth defects or other reproductive harm. For more information go to www.P65Warnings.ca.gov.

<p>PT23409-MPG Maximum Performance Glass Hydraulic Element</p>  <p>Fits: Pall Applications Replaces: Pall HC8900FKT16Z O.D.: 3 25/32 (96.0) I.D.: 2 7/32 (56.4) One End Height: 16 29/32 (429.4) O-Ring: [1] Attached</p>	<p>PT23415-MPG Maximum Performance Glass Hydraulic Element</p>  <p>Fits: Pall Applications Replaces: Pall HC6400FKT16H O.D.: 3 13/32 (86.5) I.D.: 1 31/32 (50.0) One End Height: 16 13/16 (427.0) O-Ring: [1] Attached</p>
<p>PT23410-MPG Maximum Performance Glass Hydraulic Element</p>  <p>Fits: Pall Applications Replaces: Pall HC9800FKS13H O.D.: 1 31/32 (50.0) I.D.: 31/32 (24.6) One End Height: 12 31/32 (329.4) O-Ring: [1] Attached</p>	<p>PT23416-MPG Maximum Performance Glass Hydraulic Element</p>  <p>Fits: Pall Applications Replaces: Pall HC8200FKN13Z O.D.: 3 (76.2) I.D.: 1 1/2 (38.1) One End Height: 13 (330.2) O-Ring: [1] Attached</p>
<p>PT23411-MPG Maximum Performance Glass Hydraulic Element with Bail Handle</p>  <p>Fits: Pall Applications Replaces: Pall HC8314FKP39Z O.D.: 6 (152.4) I.D.: 3 25/32 (96.0) & 3 15/16 (100.0) Height: 36 1/2 (927.1) O-Ring: [2] Attached</p>	<p>PT23417-MPG Maximum Performance Glass Hydraulic Element</p>  <p>Fits: Pall Applications Replaces: Pall HC9604FKN16Z O.D.: 3 3/32 (78.6) I.D.: 2 1/32 (51.6) One End Height: 16 9/16 (420.6) O-Ring: [1] Attached</p>
<p>PT23412-MPG Maximum Performance Glass Hydraulic Element</p>  <p>Fits: Pall Applications Replaces: Pall HC8900FKT8Z O.D.: 3 25/32 (96.0) I.D.: 2 7/32 (56.4) One End Height: 8 3/32 (205.6) O-Ring: [1] Attached</p>	<p>PT23418-MPG Maximum Performance Glass Hydraulic Element</p>  <p>Fits: Pall Applications Replaces: Pall HC9801FKP4H O.D.: 2 (50.8) I.D.: 15/16 (23.8) Height: 4 1/2 (114.3) O-Ring: [1] Attached</p>
<p>PT23413-MPG Maximum Performance Glass Hydraulic Element</p>  <p>Fits: Pall Applications Replaces: Pall HC9901FKT26H O.D.: 3 3/4 (95.2) I.D.: 2 5/16 (58.7) Height: 25 7/8 (657.2) O-Ring: [1] Attached</p>	<p>PT23419-MPG Maximum Performance Glass Hydraulic Element</p>  <p>Fits: Pall Applications Replaces: Pall HC9100FKN8Z O.D.: 2 3/4 (69.9) I.D.: 1 5/16 (33.3) One End Height: 8 1/4 (209.5) O-Ring: [1] Attached</p>
<p>PT23414-MPG Maximum Performance Glass Hydraulic Element</p>  <p>Fits: Pall Applications Replaces: Pall HC9606FKS8H O.D.: 3 1/16 (77.8) I.D.: 1 23/32 (43.7) One End Height: 8 1/4 (209.5) O-Ring: [1] Attached</p>	<p>PT23420-MPG Maximum Performance Glass Hydraulic Element</p>  <p>Fits: Pall Applications Replaces: Pall HC9400FKP26H O.D.: 3 25/32 (96.0) I.D.: 2 7/32 (56.4) Height: 25 27/32 (656.4) O-Ring: [2] Attached</p>

Measurements Are Shown In Inches And (Millimeters)

 **WARNING:** These products can expose you to chemicals, including Diisononyl Phthalate, Carbon black extracts, Nickel, 1,3 Butadiene, Ethylene Oxide, Epichlorohydrin, which are known to the State of California to cause cancer, and Bisphenol, Ethylene Glycol, Ethylene Oxide, 1,3 Butadiene, Epichlorohydrin, which are known to the State of California to cause birth defects or other reproductive harm. For more information go to www.P65Warnings.ca.gov.

PT23421-MPG Maximum Performance Glass Hydraulic Element



Fits: Pall Applications
Replaces: Pall HC9400FKS39Z
O.D.: 3 25/32 (96.0)
I.D.: 2 7/32 (56.4)
Height: 38 13/16 (985.8)
O-Ring: [2] Attached

PT23427-MPG Maximum Performance Glass Hydraulic Element with Bail Handle



Fits: Pall Applications
Replaces: Pall HC8304FKN16Z
O.D.: 5 13/32 (137.3)
I.D.: 3 25/32 (96.0) & 3 15/16 (100.0)
Height: 14 21/32 (372.2)
O-Ring: [2] Attached

PT23422-MPG Maximum Performance Glass Hydraulic Element



Fits: Pall Applications
Replaces: Pall HC9901FKP26H
O.D.: 3 13/16 (96.8)
I.D.: 2 3/16 (55.6)
Height: 25 13/16 (655.6)
O-Ring: [2] Attached

PT23428-MPG Maximum Performance Glass Hydraulic Element with Bail Handle



Fits: Pall Applications
Replaces: Pall HC8304FKS39Z
O.D.: 5 13/32 (137.3)
I.D.: 3 25/32 (96.0) & 3 15/16 (100.0)
Height: 36 1/2 (927.1)
O-Ring: [2] Attached

PT23423-MPG Maximum Performance Glass Hydraulic Element



Fits: Pall Applications
Replaces: Pall HC9601FUP16H
O.D.: 3 1/16 (77.8)
I.D.: 1 13/16 (46.0) One End
Height: 17 (431.8)
O-Ring: [1] Attached

PT23429-MPG Maximum Performance Glass Hydraulic Element



Fits: Pall Applications
Replaces: Pall HC9601FKP13H
O.D.: 3 1/16 (77.8)
I.D.: 1 11/16 (42.9) One End
Height: 13 (330.2)
O-Ring: [1] Attached

PT23424-MPG Maximum Performance Glass Hydraulic Element with Bail Handle



Fits: Pall Applications
Replaces: Pall HC8304FKP9Z
O.D.: 5 13/32 (137.3)
I.D.: 3 25/32 (96.0) & 3 15/16 (100.0)
Height: 36 1/2 (927.1)
O-Ring: [2] Attached

PT23430-MPG Maximum Performance Glass Hydraulic Element



Fits: Pall Applications
Replaces: Pall HC2217FDT6H
O.D.: 2 23/32 (69.1)
I.D.: 1 11/32 (34.1) One End
Height: 6 13/16 (173.0)
O-Ring: [1] Attached

PT23425-MPG Maximum Performance Glass Hydraulic Element with Bail Handle



Fits: Pall Applications
Replaces: Pall HC8304FKN39Z
O.D.: 5 13/32 (137.3)
I.D.: 3 25/32 (96.0) & 3 15/16 (100.0)
Height: 36 1/2 (927.1)
O-Ring: [2] Attached

PT23431-MPG Maximum Performance Glass Hydraulic Element with Bail Handle



Fits: Pall Applications
Replaces: Pall HC8314FKN39H
O.D.: 6 (152.4)
I.D.: 3 25/32 (96.0) & 3 15/16 (100.0)
Height: 36 1/2 (927.1)
O-Ring: [2] Attached

PT23426-MPG Maximum Performance Glass Hydraulic Element with Bail Handle



Fits: Pall Applications
Replaces: Pall HC2792628314FKN39Z
O.D.: 6 (152.4)
I.D.: 3 25/32 (96.0) & 3 15/16 (100.0)
Height: 36 1/2 (927.1)
O-Ring: [2] Attached

PT23432-MPG Maximum Performance Glass Hydraulic Element



Fits: Pall Applications
Replaces: Pall HC9801FUT13Z
O.D.: 2 1/32 (51.5)
I.D.: 29/32 (23.0) One End
Height: 13 (330.2)
O-Ring: [1] Attached

Measurements Are Shown In Inches And (Millimeters)

WARNING: These products can expose you to chemicals, including Diisononyl Phthalate, Carbon black extracts, Nickel, 1,3 Butadiene, Ethylene Oxide, Epichlorohydrin, which are known to the State of California to cause cancer, and Bisphenol, Ethylene Glycol, Ethylene Oxide, 1,3 Butadiene, Epichlorohydrin, which are known to the State of California to cause birth defects or other reproductive harm. For more information go to www.P65Warnings.ca.gov.

PT23433-MPG Maximum Performance Glass Hydraulic Element



Fits: Pall Applications
Replaces: Pall HC8900FDN8H
O.D.: 3 25/32 (96.0)
I.D.: 2 7/32 (56.4) One End
Height: 8 3/32 (205.5)
O-Ring: [1] Attached

PT23439-MPG Maximum Performance Glass Hydraulic Element with Bail Handle



Fits: Pall Applications
Replaces: Pall HC8314FKT39H
O.D.: 6 (152.4)
I.D.: 3 25/32 (96.0) & 3 15/16 (100.0)
Height: 36 1/2 (927.1)
O-Ring: [2] Attached

PT23434-MPG Maximum Performance Glass Hydraulic Element



Fits: Pall Applications
Replaces: Pall HC8900FKN39H
O.D.: 3 25/32 (96.0)
I.D.: 2 7/32 (56.4)
Height: 38 13/16 (985.8)
O-Ring: [2] Attached

PT23440-MPG Maximum Performance Glass Hydraulic Element



Fits: Pall Applications
Replaces: Pall HC8800FKN13H
O.D.: 3 13/32 (86.5)
I.D.: 1 31/32 (50.0) One End
Height: 12 29/32 (327.8)
O-Ring: [1] Attached

PT23435-MPG Maximum Performance Glass Hydraulic Element



Fits: Pall Applications
Replaces: Pall HC6500FKS26H
O.D.: 3 13/16 (96.8)
I.D.: 2 3/8 (60.3) One End
Height: 25 11/16 (652.5)
O-Ring: [1] Attached

PT23441-MPG Maximum Performance Glass Hydraulic Element



Fits: Pall Applications
Replaces: Pall HC9604FKT13H
O.D.: 3 3/16 (81.0)
I.D.: 2 (50.8) One End
Height: 12 11/16 (322.2)
O-Ring: [1] Attached

PT23436-MPG Maximum Performance Glass Hydraulic Element



Fits: Pall Applications
Replaces: Pall HC9601FUP4Z
O.D.: 3 1/16 (77.8)
I.D.: 1 11/16 (42.9) One End
Height: 4 21/32 (118.3)
O-Ring: [1] Attached

PT23442-MPG Maximum Performance Glass Hydraulic Element



Fits: Pall Applications
Replaces: Pall HC8700FKN8H
O.D.: 1 31/32 (50.0)
I.D.: 31/32 (24.6)
Height: 8 13/32 (213.5)
O-Ring: [2] Attached

PT23437-MPG Maximum Performance Glass Hydraulic Element



Fits: Pall Applications
Replaces: Pall HC9801FKP8H
O.D.: 2 (50.8)
I.D.: 15/16 (23.8) One End
Height: 8 1/4 (209.5)
O-Ring: [1] Attached

PT23443-MPG Maximum Performance Glass Hydraulic Element



Fits: Pall Applications
Replaces: Pall HC8700FKS8H
O.D.: 1 31/32 (50.0)
I.D.: 31/32 (24.6)
Height: 8 13/32 (213.5)
O-Ring: [2] Attached

PT23438-MPG Maximum Performance Glass Hydraulic Element



Fits: Pall Applications
Replaces: Pall HC9606FKS13Z
O.D.: 3 1/16 (77.8)
I.D.: 1 23/32 (43.7) One End
Height: 12 31/32 (329.4)
O-Ring: [1] Attached

PT23444-MPG Maximum Performance Glass Hydraulic Element



Fits: Parker Applications
Replaces: Parker 932629Q
O.D.: 2 11/32 (59.5)
I.D.: 1 13/32 (35.7) One End
Height: 9 19/32 (243.7)
O-Ring: [1] Attached

Measurements Are Shown In Inches And (Millimeters)

 **WARNING:** These products can expose you to chemicals, including Diisononyl Phthalate, Carbon black extracts, Nickel, 1,3 Butadiene, Ethylene Oxide, Epichlorohydrin, which are known to the State of California to cause cancer, and Bisphenol, Ethylene Glycol, Ethylene Oxide, 1,3 Butadiene, Epichlorohydrin, which are known to the State of California to cause birth defects or other reproductive harm. For more information go to www.P65Warnings.ca.gov.

PT23445-MPG Maximum Performance Glass Hydraulic Element



Fits: Parker Applications
Replaces: Parker G02082
O.D.: 3 17/32 (89.7)
I.D.: 2 1/32 (51.5) & 2 1/2 (63.5)
Height: 8 3/32 (205.5)
O-Ring: [2] Attached

PT23451 Hydraulic Element



Fits: Donaldson Applications
Replaces: Cim-Tek R320C20P;
 Donaldson P550216
O.D.: 6 1/16 (154.0)
I.D.: 2 5/8 (66.6)
Height: 17 13/16 (452.4)
A. Gskt: [2] Attached

PT23446-MPG Maximum Performance Glass Hydraulic Element



Fits: Parker Applications
Replaces: Parker 924794
O.D.: 3 11/16 (93.7)
I.D.: 1 15/16 (49.2)
Height: 18 7/16 (468.3)
Grommets: [2] Attached

PT23452 Hydraulic Element



Fits: Donaldson Housings
Replaces: Cim-Tek 30410
O.D.: 3 29/32 (99.2)
I.D.: 1 21/32 (42.0)
Height: 27 31/32 (710.4)
O-Ring: [2] Attached

PT23447-MPG Maximum Performance Glass Hydraulic Element



Fits: Parker Applications
Replaces: Parker G02058
O.D.: 1 3/4 (44.4)
I.D.: 1 (25.4)
Height: 4 11/16 (119.1)
O-Ring: [2] Attached

PT23453 Hydraulic Element



Fits: Fairey-Arlon Applications
Replaces: Fairey-Arlon TXX1010;
 Liebherr 7000250; Fleetguard HF6272
O.D.: 7 31/32 (202.4)
I.D.: 9/16 (14.3) & 6 3/16 (157.0)
Height: 13 (330.2)
A. Gskt: [1] Attached

PT23448-MPG Maximum Performance Glass Hydraulic Element



Fits: Parker Applications
Replaces: Parker G02064
O.D.: 1 13/16 (46.0)
I.D.: 15/16 (23.8)
Height: 8 7/16 (214.3)
O-Ring: [2] Attached

PT23454 Hydraulic Element



Fits: Finn Filter Applications
Replaces: Finn Filter FFP1053015
O.D.: 7 3/32 (180.1)
I.D.: 4 5/32 (105.5)
Height: 7 7/8 (200.0)
O-Ring: [2] Attached

PT23449-MPG Maximum Performance Glass Hydraulic Element



Fits: Schroeder Applications
Replaces: Schroeder KKKS3
O.D.: 3 15/16 (100.0)
I.D.: 1 11/16 (42.9)
Height: 28 (711.2)
O-Ring: [2] Attached

PT23455 Hydraulic Element



Fits: Finn Filter Applications
Replaces: Finn Filter FFP1053015
O.D.: 5 29/32 (150.0)
I.D.: 3 1/2 (88.9)
Height: 6 7/16 (163.5)
O-Ring: [2] Attached

PT23450-MPG Maximum Performance Glass Hydraulic Element with Bail Handle



Fits: Sennebogen Applications
Replaces: Sennebogen 27417
O.D.: 3 23/32 (94.4)
I.D.: 1 25/32 (45.2) & 1 29/32 (48.4)
Height: 24 3/32 (612.0)
O-Ring: [1] Attached, [1] Included

PT23456 Hydraulic Element



Fits: MP Filtri Applications
Replaces: MP Filtri CU250P10N;
 Donaldson C2501, P171667
O.D.: 3 29/32 (99.2)
I.D.: 2 1/32 (51.5)
Height: 8 1/4 (209.5)
A. Gskt: [2] Attached

Measurements Are Shown In Inches And (Millimeters)

WARNING: These products can expose you to chemicals, including Diisononyl Phthalate, Carbon black extracts, Nickel, 1,3 Butadiene, Ethylene Oxide, Epichlorohydrin, which are known to the State of California to cause cancer, and Bisphenol, Ethylene Glycol, Ethylene Oxide, 1,3 Butadiene, Epichlorohydrin, which are known to the State of California to cause birth defects or other reproductive harm. For more information go to www.P65Warnings.ca.gov.

PT23457



Hydraulic Element

Fits: MP Filtri Applications
Replaces: MP Filtri CU630P10N;
 Donaldson C6301, P171674
O.D.: 5 1/8 (130.2)
I.D.: 3 (76.2)
Height: 9 27/32 (250.0)
A. Gskt: [2] Attached

PT23463



Hydraulic Element

Fits: Sofima Applications
Replaces: Sofima CCH152CD1, CH152CD11;
 Donaldson CM2501, P171722
O.D.: 1 25/32 (45.2)
I.D.: 1 (25.4) One End
Height: 4 15/32 (113.5)
O-Ring: [1] Attached

PT23458



Hydraulic Element

Fits: MP Filtri Applications
Replaces: MP Filtri CU630P25N;
 Donaldson C6303, P171675
O.D.: 5 1/8 (130.2)
I.D.: 3 (76.2)
Height: 9 27/32 (250.0)
A. Gskt: [2] Attached

PT23464



Hydraulic Element

Contains: [6] Bolts
Fits: U.C.C. Hydraulic Applications
Replaces: U.C.C. Hydraulic UCAB116310;
 Donaldson P171855, TCO501
O.D.: 1 1/2 (38.1)
 Cap 2 31/32 (75.4)
Height: 5 29/32 (150.0)
F. Gskt: [1] Included

PT23459



Hydraulic Element

Fits: MP Filtri Applications
Replaces: Caterpillar 3I2087; MP Filtri
 MR1004P10A; Donaldson CRS1601
O.D.: 2 13/16 (71.4)
I.D.: 5/8 (7.9) & 1 3/4 (44.4)
Height: 11 13/16 (300.0)
A. Gskt: [1] Attached

PT23465



Hydraulic Element with Bail Handle

Contains: By-Pass Valve
Fits: Venieri Applications
Replaces: Venieri 102028;
 Donaldson P173048, P180014
O.D.: 2 3/4 (69.9)
I.D.: 1 5/32 (29.3) One End
Height: 6 13/16 (173.0)
O-Ring: [1] Attached
Spring: [1] Included

PT23460



Hydraulic Element

Fits: MP Filtri Applications
Replaces: MP Filtri MF0202P25NB;
 Donaldson P171839
O.D.: 1 21/32 (42.0)
I.D.: 29/32 (23.0) & 1 1/32 (26.1)
Height: 6 11/16 (169.9)
O-Ring: [1] Attached

PT23466



Hydraulic Element

Notes: OBSOLETE. Replaced by PA4876
Fits: Donaldson Applications
Replaces: Donaldson P783648, P922473
O.D.: 4 23/32 (120.0)
I.D.: 2 13/16 (71.4)
Height: 23 5/8 (600.1)
A. Gskt: [2] Attached

PT23461



Hydraulic Element

Fits: Parker Applications
Replaces: Parker 937726
O.D.: 4 3/16 (106.3)
I.D.: 13/32 (10.3) & 2 27/32 (72.2)
Height: 10 1/4 (260.4)
A. Gskt: [1] Attached

PT23467



Hydraulic Element with Bail Handle

Contains: By-Pass Valve
Fits: Donaldson Applications
Replaces: Donaldson CR8006, P171583
O.D.: 5 1/8 (130.2)
I.D.: 2 17/32 (64.2) One End
Height: 15 29/32 (404.0)
O-Ring: [1] Attached
Spring: [1] Included

PT23462



Hydraulic Element with Bail Handle

Contains: By-Pass Valve
Fits: Sofima Applications
Replaces: Sofima CRE055CV1;
 Donaldson CR2014, P171546
O.D.: 3 29/32 (99.2)
I.D.: 1 19/32 (40.5) One End
Height: 10 1/4 (260.4)
O-Ring: [1] Attached
Spring: [1] Included

PT23468



Hydraulic Element with Bail Handle

Contains: By-Pass Valve
Fits: Donaldson Applications
Replaces: Donaldson CR1256, P171589
O.D.: 3 29/32 (99.2)
I.D.: 1 19/32 (40.5) One End
Height: 6 29/32 (175.4)
O-Ring: [1] Attached
Spring: [1] Included

Measurements Are Shown In Inches And (Millimeters)



WARNING: These products can expose you to chemicals, including Diisononyl Phthalate, Carbon black extracts, Nickel, 1,3 Butadiene, Ethylene Oxide, Epichlorohydrin, which are known to the State of California to cause cancer, and Bisphenol, Ethylene Glycol, Ethylene Oxide, 1,3 Butadiene, Epichlorohydrin, which are known to the State of California to cause birth defects or other reproductive harm. For more information go to www.P65Warnings.ca.gov.

PT23469 Hydraulic Element with Bail Handle
Contains: By-Pass Valve
Fits: Mahle Applications
Replaces: Mahle 852378DRG60; Donaldson CR2206, P171595
O.D.: 5 1/8 (130.2)
I.D.: 2 17/32 (64.2) One End
Height: 5 23/32 (145.2)
O-Ring: [1] Attached
Spring: [1] Included



PT23475 Hydraulic Element
Contains: Threaded Stud: 2-11 BSP
Fits: MP Filtri Applications
Replaces: MP Filtri STR1004SG1M90; Donaldson FIOA220, P760151
O.D.: 4 1/32 (102.4)
Height: 8 31/32 (228.0)



PT23470 Hydraulic Element
Fits: MP Filtri Applications
Replaces: MP Filtri CU100M90N; Donaldson C100, P171657
O.D.: 2 3/4 (69.9)
I.D.: 1 3/8 (35.0)
Height: 5 1/8 (130.1)
O-Ring: [2] Attached



PT23476 Hydraulic Element
Fits: Parker Applications
Replaces: Parker 924739; Donaldson P171248; Fleetguard HF7777, HF7778
O.D.: 2 3/4 (69.9)
I.D.: 1 11/16 (42.9)
Height: 8 21/32 (219.8)
A. Gskt: [2] Attached



PT23471 Hydraulic Element
Fits: MP Filtri Applications
Replaces: MP Filtri CU630M60N; Donaldson C6306, P171677
O.D.: 5 1/8 (130.2)
I.D.: 3 (76.2)
Height: 9 27/32 (250.0)
O-Ring: [2] Attached



PT23477 Hydraulic Element
Fits: Parker Applications
Replaces: Parker 925774
O.D.: 3 29/32 (99.2)
I.D.: 1 21/32 (42.0)
Height: 9 1/4 (235.0)
O-Ring: [2] Attached



PT23472 Hydraulic Element
Fits: MP Filtri Applications
Replaces: MP Filtri SF510M90
O.D.: 3 29/32 (99.2)
I.D.: 2 9/16 (65.0)
Height: 7 25/32 (197.6)



PT23478 Hydraulic Element with 2 Bail Handles
Contains: By-Pass Valve
Fits: Sofima Applications
Replaces: Sofima 52808; Donaldson CR50, CR60, P171518, P171524
O.D.: 2 3/4 (69.9)
I.D.: 1 5/32 (29.3)
Height: 3 11/32 (85.0)
O-Ring: [1] Attached
Spring: [1] Included



PT23473 Hydraulic Element
Fits: MP Filtri Applications
Replaces: MP Filtri SF503M90
O.D.: 4 23/32 (119.8)
I.D.: 3 1/32 (77.0)
Height: 7 25/32 (197.6)



PT23479 Hydraulic Element with Bail Handle
Contains: By-Pass Valve
Fits: Sofima Applications
Replaces: Sofima CRE055MN1
O.D.: 3 29/32 (99.2)
I.D.: 1 19/32 (40.5)
Height: 10 1/4 (260.4)
O-Ring: [1] Attached
Spring: [1] Included



PT23474 Hydraulic Element
Contains: Threaded End: 1-11 BSP
Fits: MP Filtri Applications
Replaces: MP Filtri STR0704SG1M90, MPA050G1M90; Donaldson FIOA90, P171877
O.D.: 2 7/8 (73.0)
Height: 5 27/32 (148.4)



PT23480 Hydraulic Element with Bail Handle
Contains: By-Pass Valve
Fits: Sofima Applications
Replaces: Sofima TE55MCV1; Donaldson CR125, P171584
O.D.: 3 29/32 (99.2)
I.D.: 1 19/32 (40.5)
Height: 6 29/32 (175.4)
O-Ring: [1] Attached
Spring: [1] Included



Measurements Are Shown In Inches And (Millimeters)

 **WARNING:** These products can expose you to chemicals, including Diisononyl Phthalate, Carbon black extracts, Nickel, 1,3 Butadiene, Ethylene Oxide, Epichlorohydrin, which are known to the State of California to cause cancer, and Bisphenol, Ethylene Glycol, Ethylene Oxide, 1,3 Butadiene, Epichlorohydrin, which are known to the State of California to cause birth defects or other reproductive harm. For more information go to www.P65Warnings.ca.gov.

PT23481



Hydraulic Element

Contains: Threaded Stud: 1 1/4-11 BSP
Fits: U.F.I. Applications
Replaces: U.F.I. Filters ESA31B10WMF; Donaldson FIOA130, P171885
O.D.: 4 1/32 (102.4)
Height: 7 11/16 (195.2)

PT23487-MPG



Maximum Performance Glass Hydraulic Element

Fits: Fairey-Arlon Applications
Replaces: Fairey-Arlon TXW5AGDL20; Donaldson CRS28003, P171821; Fleetguard HF35127
O.D.: 4 3/16 (106.3)
I.D.: 13/32 (10.3) & 2 13/16 (71.4)
Height: 18 5/16 (465.1)
O-Ring: [1] Attached

PT23482



Hydraulic Element

Contains: Threaded Stud: 1 1/2-11 BSP
Fits: U.F.I. Applications
Replaces: U.F.I. Filters ESA31B12WMF; Donaldson FIOA180, P172452
O.D.: 4 1/32 (102.4)
Height: 7 11/16 (195.2)

PT23488-MPG



Maximum Performance Glass Hydraulic Element

Fits: Fairey-Arlon Applications
Replaces: Fairey-Arlon TXW6ACC10; Donaldson CRS3002, P172461; Fleetguard HF7962
O.D.: 4 31/32 (126.2)
I.D.: 13/32 (10.3) & 3 5/8 (92.1)
Height: 8 1/4 (209.5)
O-Ring: [1] Attached

PT23483-MPG



Maximum Performance Glass Hydraulic Element

Fits: Atlas Applications
Replaces: Atlas 4653961; Fairey-Arlon TXW11CC10, TXW11GDL10
O.D.: 7 31/32 (202.4)
I.D.: 9/16 (14.3) & 6 3/16 (157.1)
Height: 17 5/16 (439.7)
O-Ring: [1] Attached

PT23489-MPG



Maximum Performance Glass Hydraulic Element

Fits: Fairey-Arlon Applications
Replaces: Caterpillar 311957; Fairey-Arlon 270L123A; Donaldson 40753, P173030; Fleetguard HF30714
O.D.: 2 29/32 (73.8)
I.D.: 1 1/4 (31.7) One End
Height: 3 29/32 (99.2)
O-Ring: [1] Attached, [1] Included

PT23484-MPG



Maximum Performance Glass Hydraulic Element

Fits: Caterpillar Applications
Replaces: Caterpillar 9J6472; Komatsu 21T6012460; Fleetguard HF30479
O.D.: 3 3/32 (78.6)
I.D.: 1 11/16 (42.9) One End
Height: 4 21/32 (118.3)
O-Ring: [1] Attached

PT23490-MPG



Maximum Performance Glass Hydraulic Element

Fits: Fairey-Arlon Applications
Replaces: Caterpillar 311955; Fairey Arlon 870P110
O.D.: 3 11/16 (93.7)
I.D.: 1 29/32 (48.4) One End
Height: 3 29/32 (99.2)
F. Gskt: [1] Included
O-Ring: [1] Attached

PT23485-MPG



Maximum Performance Glass Hydraulic Element

Fits: Dana Applications
Replaces: Dana 57727; Cim-Tek E130030167; Donaldson P170102
O.D.: 6 3/32 (154.8)
I.D.: 2 5/8 (66.7)
Height: 17 27/32 (453.2)
O-Ring: [2] Attached

PT23491-MPG



Maximum Performance Glass Hydraulic Element

Fits: Genie Applications
Replaces: Cenie 20880; Donaldson CM29002
O.D.: 1 25/32 (45.2)
I.D.: 1 (25.4) One End
Height: 8 1/4 (209.5)
O-Ring: [1] Attached

PT23486-MPG



Maximum Performance Glass Hydraulic Element

Fits: Donaldson Applications
Replaces: Donaldson P164707, P161927
O.D.: 7 7/16 (188.9)
I.D.: 4 27/32 (123.0) One End
Height: 22 1/32 (560.0)
A. Gskt: [1] Attached

PT23492-MPG



Maximum Performance Glass Hydraulic Element

Fits: Hydac Applications
Replaces: Hydac 2060902, 1074D03BN
O.D.: 1 25/32 (45.2)
I.D.: 1 (24.5) One End
Height: 4 15/32 (113.5)
O-Ring: [1] Attached

Measurements Are Shown In Inches And (Millimeters)

WARNING: These products can expose you to chemicals, including Diisononyl Phthalate, Carbon black extracts, Nickel, 1,3 Butadiene, Ethylene Oxide, Epichlorohydrin, which are known to the State of California to cause cancer, and Bisphenol, Ethylene Glycol, Ethylene Oxide, 1,3 Butadiene, Epichlorohydrin, which are known to the State of California to cause birth defects or other reproductive harm. For more information go to www.P65Warnings.ca.gov.

PT23493-MPG Maximum Performance Glass Hydraulic Element with Bail Handle



Contains: By-Pass Valve
Fits: Hydac Applications
Replaces: Hydac 330R020BN3HC;
 Donaldson HR33003, P173170
O.D.: 3 23/32 (94.5)
I.D.: 1 25/32 (45.2) & 1 29/32 (48.4)
Height: 7 3/32 (180.2)
O-Ring: [1] Attached

PT23499-MPG Maximum Performance Glass Hydraulic Element



Fits: Manitou Applications
Replaces: Manitou 236095
O.D.: 2 23/32 (69.1)
I.D.: 1 3/16 (30.1) One End
Height: 6 29/32 (175.4)
O-Ring: [1] Attached

PT23494-MPG Maximum Performance Glass Hydraulic Element



Fits: Hydac Applications
Replaces: Hydac 60D020BN3HCV;
 Donaldson DT0060D25UM, P566653
O.D.: 1 27/32 (46.8)
I.D.: 7/8 (22.2) One End
Height: 3 5/16 (84.1)
O-Ring: [1] Attached

PT23500-MPG Maximum Performance Glass Hydraulic Element with Bail Handle



Contains: By-Pass Valve
Fits: MP Filtri Applications
Replaces: MP Filtri MF1001A10HB;
 Donaldson CR5002, CR6002,
 P171519, P171525
O.D.: 2 3/4 (69.9)
I.D.: 1 5/32 (29.3)
Height: 3 11/32 (85.0)
O-Ring: [1] Attached
Spring: [1] Included

PT23495-MPG Maximum Performance Glass Hydraulic Element



Fits: J.C. Bamford Applications
Replaces: J.C. Bamford 32/925363
O.D.: 1 21/32 (42.0)
I.D.: 29/32 (23.0) & 1 1/32 (26.1)
Height: 8 (203.2)
O-Ring: [1] Attached

PT23501-MPG Maximum Performance Glass Hydraulic Element with 2 Bail Handles



Contains: By-Pass Valve
Fits: MP Filtri Applications
Replaces: MP Filtri MF1002A25HB;
 Donaldson CR5003, P171532
O.D.: 2 3/4 (69.9)
I.D.: 1 5/32 (29.3)
Height: 5 1/8 (130.2)
O-Ring: [1] Attached
Spring: [1] Included

PT23496-MPG Maximum Performance Glass Hydraulic Element with Bail Handle



Contains: By-Pass Valve
Fits: Liebherr Applications
Replaces: Liebherr 510670408;
 Donaldson CR32502, P171555
O.D.: 5 1/8 (130.2)
I.D.: 2 1/32 (51.5) One End
Height: 8 1/32 (204.0)
O-Ring: [1] Attached
Spring: [1] Included

PT23502-MPG Maximum Performance Glass Hydraulic Element



Fits: MP Filtri Applications
Replaces: MP Filtri CU630A10N;
 Donaldson C63002, P171672
O.D.: 5 1/8 (130.2)
I.D.: 3 (76.2)
Height: 9 27/32 (250.0)
O-Ring: [2] Attached

PT23497-MPG Maximum Performance Glass Hydraulic Element with Bail Handle



Fits: Liebherr Applications
Replaces: Liebherr 7621306, 7624324;
 Fleetguard HF35330
O.D.: 6 (152.4)
I.D.: 3 11/32 (84.9)
Height: 13 1/2 (342.9)
O-Ring: [2] Attached

PT23503-MPG Maximum Performance Glass Hydraulic Element



Fits: MP Filtri Applications
Replaces: MP Filtri HP1352A03NA;
 Donaldson P171737
O.D.: 2 3/32 (53.2)
I.D.: 1 3/32 (27.7) One End
Height: 9 1/16 (230.1)
O-Ring: [1] Attached

PT23498-MPG Maximum Performance Glass Hydraulic Element



Fits: Linde Applications
Replaces: Linde 9831601;
 Donaldson P763004
O.D.: 1 31/32 (50.0)
I.D.: 31/32 (24.6) One End
Height: 8 1/4 (209.5)
O-Ring: [1] Attached

PT23504-MPG Maximum Performance Glass Hydraulic Element



Fits: MP Filtri Applications
Replaces: MP Filtri MR1004A25A;
 Donaldson CRS16003
O.D.: 2 27/32 (72.2)
I.D.: 11/32 (8.7) & 1 25/32 (45.2)
Height: 11 13/16 (300.0)
O-Ring: [1] Attached

Measurements Are Shown In Inches And (Millimeters)

WARNING: These products can expose you to chemicals, including Diisononyl Phthalate, Carbon black extracts, Nickel, 1,3 Butadiene, Ethylene Oxide, Epichlorohydrin, which are known to the State of California to cause cancer, and Bisphenol, Ethylene Glycol, Ethylene Oxide, 1,3 Butadiene, Epichlorohydrin, which are known to the State of California to cause birth defects or other reproductive harm. For more information go to www.P65Warnings.ca.gov.

PT23505-MPG Maximum Performance Glass Hydraulic Element with Bail Handle

Contains: By-Pass Valve
Fits: MP Filtri Applications
Replaces: MP Filtri MF7501A10HB; Donaldson Donaldson CR80002, P171579
O.D.: 5 1/8 (130.2)
I.D.: 2 9/16 (65.0) One End
Height: 15 29/32 (404.0)
O-Ring: [1] Attached
Spring: [1] Included



PT23511-MPG Maximum Performance Glass Hydraulic Element

Fits: Parker Applications
Replaces: Parker 933800Q; Donaldson P170063
O.D.: 5 5/8 (142.8)
I.D.: 4 (101.6)
Height: 11 29/32 (302/4)
A. Gskt: [2] Attached
F. Gskt: [1] Included



PT23506-MPG Maximum Performance Glass Hydraulic Element

Fits: Pall Applications
Replaces: Pall HC8500FDS13H; Fleetguard HF30287
O.D.: 3 13/16 (96.8)
I.D.: 1 11/16 (42.9)
Height: 12 7/8 (327.0)
O-Ring: [2] Attached



PT23512-MPG Maximum Performance Glass Hydraulic Element

Fits: Parker Applications
Replaces: Parker 933135Q
O.D.: 2 3/8 (60.3)
I.D.: 1 13/32 (35.7) One End
Height: 5 5/16 (134.9)
O-Ring: [1] Attached



PT23507-MPG Maximum Performance Glass Hydraulic Element

Fits: Pall Applications
Replaces: Pall HC9600FKN13Z
O.D.: 3 1/16 (77.8)
I.D.: 1 23/32 (43.7) One End
Height: 12 31/32 (329.4)
O-Ring: [1] Attached



PT23513-MPG Maximum Performance Glass Hydraulic Element

Fits: Parker Applications
Replaces: Caterpillar 311717; Parker 932624Q, G01301, G01301Q; Donaldson P170068
O.D.: 2 3/8 (60.3)
I.D.: 1 13/32 (35.7) One End
Height: 5 5/16 (134.9)
O-Ring: [1] Attached



PT23508-MPG Maximum Performance Glass Hydraulic Element

Fits: Pall Applications
Replaces: Pall HC0101FDT18H, HC2618FKT18H; Donaldson P170103, P566708
O.D.: 6 3/32 (154.8)
I.D.: 2 5/8 (66.7)
Height: 17 27/32 (453.2)
A. Gskt: [2] Attached



PT23514-MPG Maximum Performance Glass Hydraulic Element

Fits: Parker Applications
Replaces: Parker 925789, 932670Q, 415VQ; Donaldson P174624, P566272
O.D.: 3 29/32 (99.0)
I.D.: 1 21/32 (42.0)
Height: 9 1/4 (235.0)
O-Ring: [2] Attached



PT23509-MPG Maximum Performance Glass Hydraulic Element

Fits: Parker Applications
Replaces: Parker G04167Q
O.D.: 3 3/32 (78.6)
I.D.: 1 23/32 (43.7) One End
Height: 8 1/4 (209.5)
O-Ring: [1] Attached



PT23515-MPG Maximum Performance Glass Hydraulic Element

Fits: Parker Applications
Replaces: Parker 932678Q; Donaldson DTHF4188UM, P566275
O.D.: 3 29/32 (99.0)
I.D.: 1 21/32 (42.0)
Height: 18 1/2 (469.9)
O-Ring: [2] Attached



PT23510-MPG Maximum Performance Glass Hydraulic Element

Fits: Parker Applications
Replaces: Parker 930367Q
O.D.: 1 25/32 (45.2)
I.D.: 1 (25.4) One End
Height: 4 15/32 (113.5)
O-Ring: [1] Attached



PT23516-MPG Maximum Performance Glass Hydraulic Element

Fits: Parker Applications
Replaces: Parker FTBE2810Q, G02076; Fleetguard HF7704
O.D.: 2 3/8 (60.0)
I.D.: 1 5/32 (29.3) & 1 7/16 (36.5)
Height: 9 9/16 (242.9)
O-Ring: [2] Attached



Measurements Are Shown In Inches And (Millimeters)

WARNING: These products can expose you to chemicals, including Diisononyl Phthalate, Carbon black extracts, Nickel, 1,3 Butadiene, Ethylene Oxide, Epichlorohydrin, which are known to the State of California to cause cancer, and Bisphenol, Ethylene Glycol, Ethylene Oxide, 1,3 Butadiene, Epichlorohydrin, which are known to the State of California to cause birth defects or other reproductive harm. For more information go to www.P65Warnings.ca.gov.

PT23517-MPG Maximum Performance Glass Hydraulic Element



Contains: [2] Stacked Elements
Fits: Sandvik Applications
Replaces: Sandvik 86727289;
 Fleetguard HF35130
O.D.: 4 31/32 (126.2)
I.D.: 13/32 (10.3) & 3 5/8 (92.1)
Height: 22 27/32 (580.2)
O-Ring: [1] Attached

PT23523-MPG Maximum Performance Glass Hydraulic Element with Bail Handle



Contains: By-Pass Valve
Fits: Sofima Applications
Replaces: Sofima CRE055FD1, RS55FD1
O.D.: 3 29/32 (99.2)
I.D.: 1 19/32 (40.5) One End
Height: 10 1/4 (260.4)
O-Ring: [1] Attached
Spring: [1] Included

PT23518-MPG Maximum Performance Glass Hydraulic Element



Fits: Schroeder Applications
Replaces: Schroeder CCS7, CCZ10
O.D.: 2 7/8 (73.0)
I.D.: 1 3/32 (27.7)
Height: 9 1/2 (241.3)
O-Ring: [1] Attached

PT23524-MPG Maximum Performance Glass Hydraulic Element



Fits: U.F.I. Filter Applications
Replaces: U.F.I. EPA12NFD;
 Donaldson FM18003, P171709
O.D.: 1 21/32 (42.0)
I.D.: 7/8 (22.2) One End
Height: 7 1/32 (179.0)
O-Ring: [1] Attached

PT23519-MPG Maximum Performance Glass Hydraulic Element



Fits: Schroeder Applications
Replaces: Schroeder KKS7, KKZ10;
 Cim-Tek 30142; Donaldson P174249
O.D.: 3 29/32 (99.2)
I.D.: 1 21/32 (42.0)
Height: 18 1/2 (470.0)
O-Ring: [2] Attached

BT23525-MPG Maximum Performance Glass Hydraulic Spin-on



Fits: Case, Case-IH, John Deere, Kalmar,
 New Holland Equipment
Replaces: Hydac 90MA020BN;
 Fleetguard HF30399
Thread: 1 1/2 -16
O.D.: 3 3/4 (95.3)
Height: 5 9/16 (141.3)
F. Gskt: [1] Included

PT23520-MPG Maximum Performance Glass Hydraulic Element



Fits: Schroeder Hydraulic Applications
Replaces: Schroeder BBS7, BBZ7;
 Donaldson P560400
O.D.: 4 31/32 (126.2)
I.D.: 3 5/16 (8.1)
Height: 18 5/16 (465.1)
A. Gskt: [2] Attached

PT23526 Hydraulic Element



Contains: [2] 1/4 Inch Bolt Holes
 By-Pass Valve
Fits: Fendt Tractors
Replaces: Fendt F285102050010;
 Fleetguard HF35309
O.D.: 6 7/32 (158.0)
I.D.: 2 17/32 (64.3)
Height: 3 9/16 (90.5)

PT23521-MPG Maximum Performance Glass Hydraulic Element with Bail Handle



Fits: Schwing Applications
Replaces: Schwing 10190588;
 Donaldson P564845, P566352
O.D.: 3 27/32 (97.6)
I.D.: 2 9/16 (65.0)
Height: 15 9/32 (388.1)
O-Ring: [2] Attached

PT23527 Hydraulic Strainer



Fits: Claas Tractors
Replaces: Claas 7665380
O.D.: 2 3/4 (69.9)
I.D.: 31/32 (24.6)
Height: 2 29/32 (73.8)

PT23522-MPG Maximum Performance Glass Hydraulic Element



Fits: Sennebogen Applications
Replaces: Sennebogen 3751027324;
 Donaldson P560403
O.D.: 3 3/32 (78.6)
I.D.: 1 5/8 (41.2) One End
Height: 16 13/16 (427.0)
O-Ring: [1] Attached

PT23528-MPG Maximum Performance Glass Power Steering Element



Fits: Ponsse Forestry Machines
Replaces: Ponsse 36673
O.D.: 2 1/8 (54.0)
I.D.: 7/8 (22.2) One End
Height: 2 5/8 (66.7)
O-Ring: [1] Attached, [2] Included

PT23530 Hydraulic Strainer Element



Contains: Threaded End: 1 1/2 BSP/G
Fits: Sennebogen 825M, 870 Material Handlers
 with Cummins QSB6.7 Engine
Replaces: Sennebogen 27376;
 Donaldson P550825
O.D.: 3 3/8 (85.7)
Height: 12 3/16 (309.6)

Measurements Are Shown In Inches And (Millimeters)

WARNING: These products can expose you to chemicals, including Diisononyl Phthalate, Carbon black extracts, Nickel, 1,3 Butadiene, Ethylene Oxide, Epichlorohydrin, which are known to the State of California to cause cancer, and Bisphenol, Ethylene Glycol, Ethylene Oxide, 1,3 Butadiene, Epichlorohydrin, which are known to the State of California to cause birth defects or other reproductive harm. For more information go to www.P65Warnings.ca.gov.

PT23531-MPG Maximum Performance Glass Hydraulic Element



Fits: John Deere Dump Trucks, Loaders
Replaces: John Deere AT335977;
Donaldson P574195
O.D.: 3 11/16 (93.7)
I.D.: 1 7/8 (47.6) One End
Height: 21 23/32 (551.7)
O-Ring: [2] Attached

PT23532-MPG Maximum Performance Glass Hydraulic Element



Fits: John Deere Engines, Forestry and Logging Equipment
Replaces: John Deere F058908;
Timberjack T058908
O.D.: 2 11/16 (68.3)
I.D.: 1 5/16 (33.3)
Height: 7 1/2 (190.5)
O-Ring: [1] Attached

PT23533 Hydraulic Element



Contains: Threaded End
Fits: Komatsu PC800, PF850, PC1100, PC1250, PC2000 Series Excavators
Replaces: Komatsu 21N6231221
O.D.: 2 3/8 (60.3)
I.D.: 1 1/2 (38.1) One End
Height: 7 7/8 (200.0)

PT23534 Hydraulic Element



Fits: J.C. Bamford Excavators
Replaces: J.C Bamford 32/925140
O.D.: 7 15/32 (189.7)
to 7 13/16 (198.4)
I.D.: 1 1/16 (27.0) One End
Height: 4 11/32 (110.3)

PT23535 Hydraulic Strainer Spin-on



Contains: Threaded Stud: 1 Inch NPT
Fits: Caterpillar, Mitsubishi Lift Trucks
Replaces: Caterpillar 8137523600
O.D.: 3 31/32 (100.8)
Height: 3 19/32 (91.3)

PT23536 Wire Mesh Transmission Strainer



Contains: By-Pass Valve
Fits: Case Dozers, Loaders, Cable Layers
Replaces: Case D37035
O.D.: 2 5/8 (66.7)
I.D.: 1 7/32 (31) One End
Height: 4 3/4 (120.7)
O-Ring: [1] Attached

BT23537 Hydraulic Spin-on



Fits: Agco Tractors with Cummins Engines
Replaces: Massey Ferguson 3616579M2,
3907580M2, 4303303M1, 6907580M1
Thread: M42 x 2-6G
O.D.: 5 7/16 (138.1)
Length: 3 15/16 (100)
I.Gskt: [1] Included

BT23539 Hydraulic Spin-on



Contains: Water Absorbing Media
Fits: Tigercat Grapple Skidders; Feller Bunchers w/Cummins Engines
Replaces: Tigercat AY052; Donaldson P561183; Fleetguard HF35477
Thread: 1 1/2 -16
O.D.: 5 1/32 (127.8)
Height: 10 11/16 (271.5)
F. Gskt: [2] Included
O-Ring: [1] Included

BT23540 Hydraulic Spin-on



Fits: John Deere Tractors
Replaces: John Deere RE161181;
Donaldson P564042; Fleetguard HF35484
Thread: 1 1/4 -12
O.D.: 3 27/32 (97.6)
Height: 9 23/32 (246.9)
A. Gskt: [1] Included
O-Ring: [1] Attached

BT23542-MPG Maximum Performance Glass Hydraulic Spin-on



Fits: Case-International Tractors, Harvesters; New Holland Tractors
Replaces: Case 84487937, 87413809;
New Holland 84487937, 87413809
Thread: 1 3/4 -12
O.D.: 4 25/32 (121.4)
Height: 14 1/4 (362.0)
I.Gskt: [1] Attached

BT23543-MPG Maximum Performance Glass Hydraulic Spin-on



Fits: John Deere Motor Graders, Loaders
Replaces: John Deere AT335492;
Donaldson P576064; Fleetguard HF29038
Thread: M90 x 2.0-7H
O.D.: 4 23/32 (119.9)
Height: 11 9/16 (293.7)
A. Gskt: [1] Included
I.Gskt: [1] Attached

PT23544-MPG Maximum Performance Glass Hydraulic Element



Fits: Hamm HD120, HD130, HD275, 3412, 3307 Rollers
Replaces: Wirtgen 1285491; Hamm 1285491, 3001285491; Fleetguard HF29065
O.D.: 3 3/32 (78.6)
I.D.: 1 9/32 (32.5) One End
Height: 9 1/2 (241.3)

PT23556-MPG Maximum Performance Glass Hydraulic Element



Fits: Schroeder Hydraulic Applications
Replaces: Schroeder 9V5Z10;
Donaldson P572998
O.D.: 2 7/8 (73.0)
I.D.: 1 1/2 (38.1) One End
Height: 9 9/16 (242.9)
O-Ring: [1] Attached

Measurements Are Shown In Inches And (Millimeters)

 **WARNING:** These products can expose you to chemicals, including Diisononyl Phthalate, Carbon black extracts, Nickel, 1,3 Butadiene, Ethylene Oxide, Epichlorohydrin, which are known to the State of California to cause cancer, and Bisphenol, Ethylene Glycol, Ethylene Oxide, 1,3 Butadiene, Epichlorohydrin, which are known to the State of California to cause birth defects or other reproductive harm. For more information go to www.P65Warnings.ca.gov.

PT23560

Hydraulic Element



Fits: Hitachi Excavators
Replaces: Hitachi 4688140
O.D.: 3 5/16 (84.1)
I.D.: 1 1/2 (38.1)
Height: 6 13/32 (162.7)
A. Gskt: [1] Included

PT23570-MPG

Maximum Performance Glass Hydraulic Element



Replaces: Internormen 300093;
Filtrec RLR70E20B5; Wix R64D20EV5
O.D.: 1 25/32 (43.7)
I.D.: 29/32 (23) One End
Height: 6 9/16 (166.7)
O-Ring: [1] Included

PT23565-MPG

Maximum Performance Glass Hydraulic Element with Handle



Fits: Terex Loaders
Replaces: Argo V3093408;
Filtrec WG966; Wix R01E15GA
O.D.: 3 17/32 (89.7)
Lid 4 5/32 (105.6)
I.D.: 2 1/16 (52.4) One End
Height: 15 (381)
O-Ring: [1] Attached

PT23571-MPG

Maximum Performance Glass Hydraulic Element



Contains: Slotted Pan Screw M4x12 [fully threaded] UNI EN ISO mounted and secured by means of loctite
Fits: JLG Industries Inc. M400AJP, M400AJPN Aerial Lifts
Replaces: JLG Industries Inc. 7021616; Filtrec WG908
O.D.: 1 3/32 (27.8)
I.D.: 11/32 (8.7) One End
Height: 3 5/32 (80.2)
O-Ring: [1] Attached

PT23566-MPG

Maximum Performance Glass Hydraulic Element with Handle



Replaces: Argo V3094108;
Filtrec WG967; Wix R21G15GA
O.D.: 3 17/32 (89.7)
Lid 4 3/16 (106.4)
I.D.: 2 1/16 (52.4) One End
Height: 17 17/32 (445.3)
O-Ring: [1] Attached

PT23572-MPG

Maximum Performance Glass Hydraulic Element



Contains: [1] Backup O-Ring
Fits: Kalmar Applications
Replaces: Kalmar 9239440052
O.D.: 2 3/32 (53.2)
I.D.: 1 1/4 (31.8)
Height: 8 21/32 (219.9)
O-Ring: [2] Included

PT23567-MPG

Maximum Performance Glass Hydraulic Element



Replaces: Clark 251223;
Filtrec WG846; Wix W01AG846
O.D.: 2 13/16 (71.4)
I.D.: 1 5/8 (41.3)
Height: 7 15/16 (201.6)
O-Ring: [2] Attached

PT23573-MPG

Maximum Performance Glass Hydraulic Element



Fits: Kalmar Applications
Replaces: Kalmar 9238551184
O.D.: 1 21/32 (42.1)
I.D.: 5/8 (15.9) One End
Height: 3 1/2 (88.9)
O-Ring: [1] Included
Grommets: [1] Attached

PT23568-MPG

Maximum Performance Glass Hydraulic Element



Replaces: Hamm 02038889, 2038889;
Filtrec WG726
O.D.: 1 3/4 (44.5)
I.D.: 13/16 (20.6) One End
Height: 6 21/32 (169.1)
O-Ring: [1] Attached

PT23574-MPG

Maximum Performance Glass Hydraulic Element



Fits: Komatsu Dozers, Excavators
Replaces: Komatsu 20Y6021410
O.D.: 2 3/4 (69.9)
I.D.: 1 25/32 (45.2) & 1 25/32 (45.2)
Height: 1 1/4 (31.8)
A. Gskt: [2] Included

PT23569-MPG

Maximum Performance Glass Hydraulic Element



Fits: Internormen Applications
Replaces: Internormen 300209
O.D.: 2 3/4 (69.9)
I.D.: 1 5/8 (41.3) One End
Height: 11 31/32 (304)
O-Ring: [1] Included

PT23575-MPG





Maximum Performance Glass Hydraulic Element



Replaces: Linde 0009831645, 9831645;
Filtrec DHD55G05V; Wix D44B05GV
O.D.: 2 7/32 (56.4)
I.D.: 1 (25.4) One End
Height: 4 21/32 (118.3)
O-Ring: [1] Viton Attached

Measurements Are Shown In Inches And (Millimeters)

WARNING: These products can expose you to chemicals, including Diisononyl Phthalate, Carbon black extracts, Nickel, 1,3 Butadiene, Ethylene Oxide, Epichlorohydrin, which are known to the State of California to cause cancer, and Bisphenol, Ethylene Glycol, Ethylene Oxide, 1,3 Butadiene, Epichlorohydrin, which are known to the State of California to cause birth defects or other reproductive harm. For more information go to www.P65Warnings.ca.gov.

<p>PT23576-MPG Maximum Performance Glass Hydraulic Element</p>  <p>Fits: Linde Applications Replaces: Linde 0009831644, 9831644; Hydac 0095D005BN4HCV, 95D005BN4HCV O.D.: 2 7/32 (56.4) I.D.: 1 1/32 (26.2) One End Height: 8 9/32 (210.3) O-Ring: [1] Attached</p>	<p>PT23582-MPG Maximum Performance Glass Hydraulic Element</p>  <p>Fits: Vogele Applications Replaces: Vogele 9624531001 O.D.: 4 1/32 (102.4) I.D.: 2 7/16 (61.9) Height: 13 1/16 (331.8) I.Gskt: [2] Included</p>
<p>PT23577-MPG Maximum Performance Glass Hydraulic Element</p>  <p>Contains: 3 PSID By-Pass Valve Fits: Linde Applications Replaces: Linde 0009831643, 9831643 O.D.: 3 23/32 (94.5) I.D.: 1 29/32 (48.4) One End Height: 15 27/32 (402.4) I.Gskt: [1] Included</p>	<p>PT23583-MPG Maximum Performance Glass Hydraulic Element</p>  <p>Fits: Wirtgen Equipment Replaces: Wirtgen 90200; Argo V3094006; Wix W01AG572 O.D.: 3 17/32 (89.7) I.D.: 1 19/32 (40.5) One End Height: 15 11/16 (398.5) O-Ring: [1] Attached</p>
<p>PT23578-MPG Maximum Performance Glass Hydraulic Element</p>  <p>Fits: Putzmeister Applications Replaces: Putzmeister 273827007 O.D.: 1 27/32 (46.8) I.D.: 1 (25.4) One End Height: 15 3/4 (400.1)</p>	<p>PT23585 Hydraulic Element</p>  <p>Fits: Hyster Applications Replaces: Hyster 2037740 O.D.: 3 15/16 (100) I.D.: 1 1/4 (31.8) & 1 9/16 (39.7) Height: 11 1/32 (280.2) Grommets: [1] Attached</p>
<p>PT23579-MPG Maximum Performance Glass Hydraulic Element</p>  <p>Replaces: Sandvik 73833256; Filtrec R734G10; Parker PR4411; Wix R20D10GP O.D.: 4 31/32 (126.2) I.D.: 13/32 (10.3) & 3 5/8 (92.1) Height: 9 27/32 (250)</p>	<p>PT23586 Hydraulic Element</p>  <p>Contains: 14.5 PSID By-Pass Valve 1 3/8-12 UNF-2B Thread Fits: TMC Applications Replaces: TMC 214A752081 O.D.: 3 17/32 (89.7) Height: 6 9/16 (166.7)</p>
<p>PT23580-MPG Maximum Performance Glass Hydraulic Element</p>  <p>Fits: COE, Inc. Orchard Equipment Replaces: Schroeder 9VZ10, 9VS7; Filtrec WG486; Wix W01AG486 O.D.: 2 7/8 (73) I.D.: 1 17/32 (38.9) One End Height: 9 1/2 (241.3) O-Ring: [1] Attached</p>	<p>PT23587 Hydraulic Element</p>  <p>Replaces: Komatsu 76233773, 79671973; Filtrec WX470 O.D.: 5 9/32 (134.1) I.D.: 3 19/32 (91.3) Height: 2 27/32 (72.2) A. Gskt: [2] Attached</p>
<p>PT23581-MPG Maximum Performance Glass Hydraulic Element with Bail Handle</p>  <p>Contains: 43.5 PSID By-Pass Valve Replaces: Terex 8520065; Filtrec WG820 O.D.: 4 1/2 (114.3) Flange 4 5/8 (117.5) I.D.: 2 19/32 (65.9) One End Height: 16 7/32 (412) O-Ring: [1] Attached</p>	<p>PT23588 Hydraulic Element</p>  <p>Contains: M6 Thread Fits: Putzmeister Applications Replaces: Putzmeister 294073005 O.D.: 3 31/32 (100.8) I.D.: 2 13/32 (61.1) Height: 19 (482.6) O-Ring: [2] Attached</p>

Measurements Are Shown In Inches And (Millimeters)

 **WARNING:** These products can expose you to chemicals, including Diisononyl Phthalate, Carbon black extracts, Nickel, 1,3 Butadiene, Ethylene Oxide, Epichlorohydrin, which are known to the State of California to cause cancer, and Bisphenol, Ethylene Glycol, Ethylene Oxide, 1,3 Butadiene, Epichlorohydrin, which are known to the State of California to cause birth defects or other reproductive harm. For more information go to www.P65Warnings.ca.gov.

PT23589 Hydraulic Element
Contains: M8 Thread
Fits: Putzmeister Applications
Replaces: Putzmeister 416341
O.D.: 6 (152.4)
I.D.: 3 15/16 (100)
Height: 20 5/16 (515.9)
O-Ring: [2] Attached



PT23590 Hydraulic Element
Fits: Terex Applications
Replaces: Terex 1409828
O.D.: 3 1/16 (77.8)
I.D.: 1 19/32 (40.5) One End
Height: 11 1/16 (281)
O-Ring: [1] Attached



PT23591-MPG Maximum Performance Glass Hydraulic Element
Fits: Liebherr Dozers, Loaders
Replaces: Liebherr 10324849;
 Filtrec WG1021; Uniflux XH1099
O.D.: 5 31/32 (151.6)
I.D.: 3 15/16 (100) One End
Height: 14 7/32 (361.2)
O-Ring: [1] Attached



PT23592 Hydraulic Element
Fits: Case, Link-Belt Excavators
Replaces: Case KRJ10590;
 New Holland KRJ10590
O.D.: 5 29/32 (150.0)
I.D.: 3 7/16 (87.3) One End
Height: 7 23/32 (196.1)
I.Gskt: [1] Included



PT23595-MPG Maximum Performance Glass Hydraulic Element
Fits: Various Industrial Hydraulic Applications
Replaces: Galbreath A4968, GBA4968;
 Killer Filter KF1059169;
 Main Filter MF0066085
O.D.: 3 29/32 (99.2)
I.D.: 2 1/4 (57.2)
Height: 18 1/2 (470)
I.Gskt: [2] Included



PT23600 Hydraulic Element
Contains: Guides
Fits: Hyundai Excavators
Replaces: Hyundai E1310212,
 E1310212A, E13102124
O.D.: 5 15/16 (150.8)
I.D.: 3 5/16 (84.1)
Height: 17 15/16 (455.6)



BT23603-MPG Maximum Performance Glass Hydraulic Spin-on
Fits: John Deere Tractors
Replaces: John Deere LVA13038
Thread: 1 1/2 -16 UN-2B
O.D.: 4 21/32 (118.3)
Height: 6 9/32 (159.5)
A. Gskt: [1] Included



BT23607-MPG Maximum Performance Glass Hydraulic Spin-on
Contains: Threaded Hex-nut for easy removal
Fits: Case Excavators, Motor Graders;
 Link-Belt Excavators all with Isuzu Engines
Replaces: Case KHJ17730, 47635916
Thread: M45 x 2.0-6H
O.D.: 3 7/16 (87.3)
Height: 6 17/32 (165.9)
O-Ring: [1] Attached



BT23609-MPG Maximum Performance Glass Hydraulic Spin-on
Replaces: Donaldson P170546;
 Racor 944049Q; Fleetguard HF35438
Thread: 1 3/4 -12 UN
O.D.: 4 3/4 (120.7)
Height: 14 1/4 (362)
I.Gskt: [1] Included



BT23611 Lube Spin-on
Contains: Anti-Drainback Valve
 50 PSID By-Pass Valve
Fits: Hyster Applications
Replaces: Hyster 4020588, 2075558
Thread: 1 -12
O.D.: 3 11/16 (93.7)
Height: 5 15/32 (141.5)
A. Gskt: G401



PT23616-MPG Maximum Performance Glass Hydraulic Element
Fits: McNeilus Hydraulic Equipment
Replaces: McNeilus 1233304;
 Oshkosh 1233304
O.D.: 3 7/8 (98.4)
I.D.: 2 1/4 (57.2)
Height: 18 1/2 (469.9)
I. Gskt.: [2] Included



PA30000 Panel Air Element
Fits: 1/2014-on Ford Transit 2.2 TDCI,
 2012-on Transit Custom 2.2 Duratorq
 all with T22DDOP Engine
Replaces: Ford 1812679
Length: 10 15/16 (277.8)
Width: 9 1/8 (231.8)
Height: 31/32 (24.6)
A. Gskt: [2] Attached



PA30001 Cab Air Element
Fits: Caterpillar Excavators
Replaces: Caterpillar 3639402
Length: 7 7/8 (200.0)
Width: 7 1/8 (181.0)
Height: 21/32 (16.7)
A. Gskt: [1] Attached

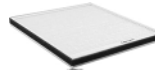

PA30002 Cab Air Element with Pull Strap
Fits: Caterpillar Equipment
Replaces: Caterpillar 2902287
Length: 14 3/32 (358.0)
Width: 11 7/32 (285.0)
Height: 2 3/16 (55.6)
A. Gskt: [2] Attached

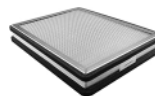

Measurements Are Shown In Inches And (Millimeters)

WARNING: These products can expose you to chemicals, including Diisononyl Phthalate, Carbon black extracts, Nickel, 1,3 Butadiene, Ethylene Oxide, Epichlorohydrin, which are known to the State of California to cause cancer, and Bisphenol, Ethylene Glycol, Ethylene Oxide, 1,3 Butadiene, Epichlorohydrin, which are known to the State of California to cause birth defects or other reproductive harm. For more information go to www.P65Warnings.ca.gov.

PA30003 Cab Air Element
Fits: Fiat-Allis/Fiat-Hitachi Loaders
Replaces: New Holland 79109003
Length: 19 9/32 (812.8)
Width: 8 31/32 (227.8)
Height: 2 23/32 (69.1)
A. Gskt: [5] Attached



PA30004 Cab Air Element with Pull Strap
Contains: Charcoal Impregnated Media for Odor Control
Fits: Caterpillar Dozers, Loaders
Replaces: Caterpillar 1752834
Length: 12 3/16 (309.6)
Width: 9 17/32 (242.1)
Height: 2 3/16 (55.6)
A. Gskt: [1] Attached

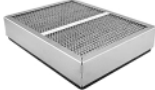

PA30005 Cab Air Element
Contains: Charcoal impregnated media for odor control.
Fits: John Deere Sprayers, Tractors
Replaces: John Deere RE199682
Length: 12 19/32 (319.9)
Width: 6 21/32 (169.1)
Height: 1 15/16 (49.2)

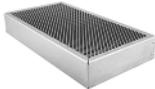

PA30006 Cab Air Element
Fits: John Deere Combines, Forage Harvesters
Replaces: John Deere H220870; Fleetguard AF27961
Length: 12 19/32 (319.9)
Width: 5 1/8 (130.2)
Height: 1 7/8 (47.6)



PA30007 Panel Air Element
Fits: Yamaha Golf Carts
Replaces: Yamaha JN6E445001, JN6E445000, JN6E44500100, JN0E445000
Length: 12 29/32 (327.8)
Width: 10 3/32 (256.4)
Height: 1 17/32 (38.9)

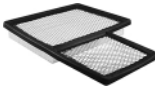

RS30008 Radial Seal Outer Air Element
Fits: John Deere Combines
Use With: RS30009
Replaces: John Deere HXE11090
O.D.: 14 7/32 (361.2)
I.D.: 8 (203.2)
Height: 23 17/32 (597.7)

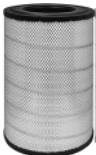

RS30009 Radial Seal Inner Air Element
Fits Inside: RS30008
Fits: John Deere Combines
Replaces: John Deere HXE11091
O.D.: 8 1/8 (206.4)
I.D.: 6 7/8 (174.6)
Height: 20 31/32 (532.6)



PA30010 Air Element
Replaces: Donaldson B120439
O.D.: 12 19/32 (319.9)
I.D.: 7 27/32 (199.2) One End
Height: 17 7/16 (442.9)



PA30011 Air Element
Fits: Generac Generators
Replaces: Generac C8127
O.D.: 6 21/32 (169.1)
I.D.: 5 3/32 (129.4)
Height: 3 3/16 (81.0)



PA30012 Air Element
Fits: Kohler Engines
Replaces: Kohler 32063035
O.D.: 5 11/16 (144.5)
I.D.: 3 (76.2) & 3 7/8 (98.4) to
Height: 1 23/32 (43.7)



PA30013 Air Element
Fits: Joy Compressors
Replaces: Joy 360628319
O.D.: 9 3/8 (238.1)
I.D.: 7 9/16 (192.1)
Height: 4 5/8 (117.5)



PA30014 Oval Air Element
Fits: Kawasaki, Mule Utility Vehicles with FC540V Engine
Replaces: Kawasaki 110132143
O.D.: 3 1/4 (82.6) to 7 7/16 (188.9)
I.D.: (7/8 to 1 13/16) (22.2 to 46.0) & 5 15/16 (150.8)
Height: 3 1/8 (79.4)
A. Gskt: [2] Attached



PA30015 Air Element
Fits: Atlas Copco Compressors
Replaces: Atlas Copco 1613872000
O.D.: 4 5/8 (117.5)
I.D.: 2 5/8 (66.7)
Height: 5 5/16 (134.9)



PA30016 Oval Air Element
Contains: Two holes in metal end
Fits: Tecumseh Engines
Replaces: Briggs & Stratton 35403
O.D.: 2 (50.8) to 8 (203.2)
I.D.: 13/16 (20.6) & 6 3/4 (171.5)
Height: 2 5/16 (58.7)



Measurements Are Shown In Inches And (Millimeters)

 **WARNING:** These products can expose you to chemicals, including Diisononyl Phthalate, Carbon black extracts, Nickel, 1,3 Butadiene, Ethylene Oxide, Epichlorohydrin, which are known to the State of California to cause cancer, and Bisphenol, Ethylene Glycol, Ethylene Oxide, 1,3 Butadiene, Epichlorohydrin, which are known to the State of California to cause birth defects or other reproductive harm. For more information go to www.P65Warnings.ca.gov.

PA30017 Oval Air Element with Foam Wrap
Fits: John Deere LX178, LX188 Lawn Tractors
Replaces: John Deere M115978
O.D.: 4 (101.6) to 8 9/16 (217.5)
I.D.: 1 13/16 (46.0) & 4 5/8 (117.5)
Height: 2 7/16 (61.9)



PA30018 Oval Air Element
Contains: Two holes in metal end
Fits: Tecumseh Engines
Replaces: Tecumseh 36356
O.D.: 4 9/32 (108.7) to 7 5/32 (181.8)
I.D.: 1 (25.4) & 6 (152.4)
Height: 3 1/8 (79.4)



PA30019 Air Element
Fits: Homelite Concrete Saws
Replaces: Homelite 46073
O.D.: 4 9/32 (108.7)
I.D.: 2 (50.8)
Height: 2 17/32 (64.3)



PA30020 Air Element
Fits: Kohler Applications
Replaces: Kohler 2808304
O.D.: 4 1/2 (114.3)
I.D.: 3 1/16 (77.8)
Height: 4 5/16 (109.5)



PA30021 Air Element
Contains: Flame Retardant Media
Fits: Daihatsu S-80 Trucks
Replaces: Daihatsu 1780187508
O.D.: 4 3/32 (104.0)
I.D.: 2 1/4 (57.2)
Height: 6 9/32 (57.9)
A. Gskt: [2] Attached



PA30022 Oval Air Element
Contains: One hole in metal end
Fits: Briggs & Stratton 196700 Engine; Cub Cadet 933E, 933R, 1027 Mowers
Replaces: Briggs & Stratton 493910
O.D.: 2 (50.8) to 7 1/4 (184.2)
I.D.: 1 (25.4) & 6 (152.4)
Height: 2 3/16 (55.6)



PA30023 Air Element
Fits: Vortex Housings
Replaces: Vortex VF-100D
O.D.: 7 3/8 (187.3)
I.D.: 3 1/2 (88.9)
Height: 10 (254)
A. Gskt: [1] Included



PA30024 Air Element
Fits: Target Concrete Saws
Replaces: Target 168323
O.D.: 3 27/32 (97.6)
I.D.: 2 3/8 (60.3)
Height: 3 7/32 (81.8)



PA30025 Air Element
Fits: Joy Compressors
Replaces: Joy 1663206
O.D.: 7 3/8 (187.3)
I.D.: 5 3/16 (131.8)
Height: 3 5/16 (84.1)



PA30026 Inner Air Element
Fits Inside: PA1980-FN
Fits: Ford Buses, Trucks
Replaces: Donaldson P524815
O.D.: 7 9/32 (184.9)
 Flange 8 15/32 (215.1)
I.D.: 2 1/32 (16.7) & 6 3/16 (157.2)
Height: 9 21/32 (245.3)
A. Gskt: [1] Attached
F. Gskt: [1] Included



PA30027 Air Element
Fits: Case Construction Equipment, Tractors
Replaces: Air Refiner ARM5233
O.D.: 8 1/16 (204.8)
I.D.: 1/4 (6.4) & 5 25/32 (146.8)
Height: 4 3/4 (120.7)
A. Gskt: [2] Attached
Grommets: [1] Attached



PA30028 Air Element
Fits: Nelson Housings
Replaces: Nelson 89102A
O.D.: 7 7/8 (200.0)
I.D.: 4 5/8 (117.5)
Height: 4 3/16 (106.4)



PA30029 Oval Air Element
Fits: Briggs & Stratton Engines; Cub Cadet 804 Lawn Tractor
Replaces: Briggs & Stratton 393406
O.D.: 3 5/16 (84.1) to 5 1/16 (128.6)
I.D.: 2 1/4 (57.2) & 4 1/16 (103.2)
Height: 2 1/8 (54.0)



Measurements Are Shown In Inches And (Millimeters)

WARNING: These products can expose you to chemicals, including Diisononyl Phthalate, Carbon black extracts, Nickel, 1,3 Butadiene, Ethylene Oxide, Epichlorohydrin, which are known to the State of California to cause cancer, and Bisphenol, Ethylene Glycol, Ethylene Oxide, 1,3 Butadiene, Epichlorohydrin, which are known to the State of California to cause birth defects or other reproductive harm. For more information go to www.P65Warnings.ca.gov.

PA30030 Air Element
Fits: Kohler Engines
Replaces: Kohler 3208306
O.D.: 4 3/16 (106.4) to 5 11/16 (144.5)
I.D.: 2 9/16 (65.1) & 3 7/8 (98.4)
Height: 3 1/16 (77.8)



PA30031 Oval Air Element
Fits: Cub Cadet, Toro Lawn & Garden Equipment; Kohler Engines
Replaces: Kohler 1208305
O.D.: 3 13/16 (96.8) to 4 1/2 (114.3)
I.D.: 2 1/2 (63.5) & 3 1/8 (79.4)
Height: 2 7/8 (73.0)
A. Gskt: [1] Attached



PA30032 Outer Air Element with Pull Tab
Fits: Massey Ferguson Tractors, Loaders
Use With: PA30033
Replaces: Massey Ferguson 3824035M1
O.D.: 5 1/4 (133.4)
I.D.: 1/2 (12.7) & 3 1/4 (82.6)
Height: 11 7/8 (301.6)
I.Gskt: [2] Included
F. Gskt: [1] Washer Included



PA30033 Inner Air Element
Fits Inside: PA30032
Fits: Massey Ferguson Tractors, Loaders
Replaces: Massey Ferguson 3824036M1
O.D.: 2 15/16 (74.6)
I.D.: 15/32 (11.8) & 2 15/32 (62.7)
Height: 11 1/4 (285.8)
F. Gskt: [1] Washer Included



PA30034 Air Breather Element
Contains: Flame Retardant Media
Fits: Chevrolet, Dodge, Jeep Automotive, Light-Duty Trucks
Replaces: General Motors 6421660
O.D.: 3 1/4 (82.6)
I.D.: 1 31/32 (50.0) One End
Height: 3 21/32 (92.9)
F. Gskt: [1] Included



PA30035 Air Breather Element
Contains: Flame Retardant Media
Fits: Clark Lift Trucks
Replaces: Clark 1618319
O.D.: 3 1/4 (82.6)
I.D.: 1 15/16 (49.2) One End
Height: 2 1/16 (52.4)
F. Gskt: [1] Included



PA30036 Air Element in Disposable Housing
Fits: John Deere Lawn Tractors
Replaces: John Deere AM101283
O.D.: 4 1/2 (114.3)
I.D.: 1 1/2 (38.1) One End
Height: 7 3/8 (187.3)



PA30037 Air Element in Disposable Housing
Fits: Railroad Applications; Fire Equipment
Replaces: Farr 71338008
O.D.: 9 3/4 (247.7)
I.D.: 5 31/32 (151.6) One End
Height: 19 3/4 (501.7)



PA30038 Air Element in Disposable Housing
Fits: Pierce Fire Trucks
Replaces: Farr 400470002
O.D.: 11 1/2 (292.1)
Inlet: 7
Height: 16 29/32 (429.4)



PA30039 Air Element in Disposable Housing
Fits: Pierce Arrow Fire Trucks
Replaces: Farr 99842004
O.D.: 13 1/2 (342.9)
Inlet: 6 25/32
Outlet: 6 25/32
Height: 25 19/32 (650.1)



PA30040 Air Element in Disposable Housing
Fits: Pierce Arrow Fire Trucks
Replaces: Farr 71338010
O.D.: 10 29/32 (277.0)
I.D.: 7 (177.8) One End
Height: 19 11/16 (500.1)



PA30041 Air Element in Disposable Housing
Fits: Farr ECO-SM Medium Duty On-Road Vehicles High Inlet Configuration
Replaces: Farr 99842010
O.D.: 13 1/2 (342.9)
Inlet: 7
Outlet: 7
Height: 16 19/32 (421.5)



PA30042 Air Element In Disposable Housing
Fits: Alaska Marine Engines
Replaces: Air Refiner ARM2842
O.D.: 8 (203.2)
I.D.: 4 (101.6) One End
Height: 10 9/16 (268.3)



Measurements Are Shown In Inches And (Millimeters)

 **WARNING:** These products can expose you to chemicals, including Diisononyl Phthalate, Carbon black extracts, Nickel, 1,3 Butadiene, Ethylene Oxide, Epichlorohydrin, which are known to the State of California to cause cancer, and Bisphenol, Ethylene Glycol, Ethylene Oxide, 1,3 Butadiene, Epichlorohydrin, which are known to the State of California to cause birth defects or other reproductive harm. For more information go to www.P65Warnings.ca.gov.

PA30043 Air Element in Disposable Housing



Fits: Spartan Fire Trucks
Replaces: Farr 62891004
O.D.: 13 1/2 (342.9)
Inlet: 6 15/16
Outlet: 6 15/16
Height: 19 13/16 (503.2)

PA30044 Cab Air Element



Fits: Caterpillar Integrated Tool Carriers, Wheel Loaders
Replaces: Caterpillar 1118738
Length: 15 3/8 (390.5)
Width: 3 5/8 (92.1)
Height: 1/2 (12.7)

PA30045 Panel Air Element



Fits: New Holland Harvesters Various Models
Replaces: Case 86545652; Donaldson P783687; Wix 49129
Length: 23 5/8 (600.1)
Width: 4 9/32 (108.7)
Height: 2 7/32 (56.4)

PA30048 Cab Air Element

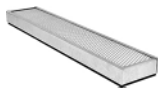

Fits: Massey Ferguson Equipment
Replaces: Massey Ferguson 3038997-M1
Length: 30 (762.0)
Width: 5 31/32 (151.6)
Height: 2 1/8 (54.0)
A. Gskt: [1] Attached

PA30049 Cab Air Element



Fits: Massey Ferguson Tractors
Replaces: Massey Ferguson 536836M1, 536836M2
Length: 44 15/16 (1414.1)
Width: 4 (101.6)
Height: 2 3/16 (55.6)
A. Gskt: [1] Attached

PA30050 Panel Air Element



Fits: Briggs & Stratton Engines
Replaces: Briggs & Stratton 272218
Length: 7 (177.8)
Width: 3 1/2 (88.9)
Height: 1 1/2 (38.1)

PA30051 Panel Air Element



Fits: Briggs & Stratton Engines
Replaces: Briggs & Stratton 710265
Length: 6 11/32 (161.1)
Width: 3 1/2 (88.9)
Height: 15/16 (23.8)

PA30052 Panel Air Element

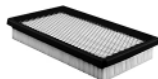

Fits: 1991-96 E-Z-GO Marathon Golf Carts
Replaces: E-Z-GO 26855G01
Length: 8 9/16 (217.5)
Width: 5 3/32 (129.4)
Height: 1 11/32 (34.1)

PA30053 Panel Air Element

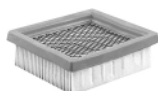

Fits: Cub Cadet Chippers
Replaces: Tecumseh 36046
Length: 3 27/32 (97.6)
Width: 3 7/16 (87.3)
Height: 1 1/4 (31.8)

PA30054 Panel Air Element

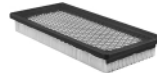

Fits: Briggs & Stratton Engines
Replaces: Briggs & Stratton 710266
Length: 8 11/32 (211.9)
Width: 3 31/32 (100.8)
Height: 1 3/32 (27.8)

PA30055 Panel Air Element



Fits: Honda Engines, Lawn Mowers
Replaces: Honda 17211Z8B901
Length: 5 1/8 (130.2)
Width: 4 7/16 (112.7)
Height: 7/8 (22.2)

PA30056 Panel Air Element



Fits: Tecumseh Engines
Replaces: Tecumseh 35500
Length: 7 1/8 (181.0)
Width: 2 3/16 (55.6)
Height: 3/4 (19.1)

RS30057 Radial Seal Outer Air Element



Fits: Donaldson FRG Housings
Use With: RS30058
Replaces: Donaldson P549523
O.D.: 12 3/32 (307.2)
I.D.: 6 25/32 (172.2) One End
Height: 18 1/2 (469.9)

RS30058 Radial Seal Inner Air Element



Fits Inside: RS30057
Fits: Donaldson FRG Housings
Replaces: Donaldson P549530
O.D.: 6 7/8 (174.6)
I.D.: 5 1/4 (133.4) One End
Height: 17 27/32 (453.2)

RS30059-FN Radial Seal Outer Air Element with Fins



Use With: RS3885
Replaces: Donaldson P601790
O.D.: 8 3/16 (208.0)
Fins: 9 11/32 (237.3)
I.D.: 4 5/32 (105.6) One End
Height: 16 1/2 (419.1)

RS30060-FN Radial Seal Outer Air Element with Fins



Fits: Donaldson FRG06 Air Cleaners
Use With: RS30061
Replaces: Donaldson P549271
O.D.: 5 9/32 (134.1)
I.D.: 3 13/32 (86.5) One End
Height: 15 (381.0)

Measurements Are Shown In Inches And (Millimeters)

WARNING: These products can expose you to chemicals, including Diisononyl Phthalate, Carbon black extracts, Nickel, 1,3 Butadiene, Ethylene Oxide, Epichlorohydrin, which are known to the State of California to cause cancer, and Bisphenol, Ethylene Glycol, Ethylene Oxide, 1,3 Butadiene, Epichlorohydrin, which are known to the State of California to cause birth defects or other reproductive harm. For more information go to www.P65Warnings.ca.gov.

RS30061



Radial Seal Inner Air Element
Fits Inside: RS30060-FN
Fits: Donaldson FRG06 Air Cleaners
Replaces: Donaldson P549277
O.D.: 3 9/16 (90.5)
I.D.: 2 13/16 (71.4) One End
Height: 14 21/32 (372.3)

RS30062



Radial Seal Air Element
Fits: Volvo Genset Engines
Replaces: Volvo 21377913
O.D.: 9 1/8 (231.8)
I.D.: 5 29/32 (150) One End
Height: 18 5/16 (465.1)

PA30063



Air Element
Fits: Ford, New Holland Lawn & Garden Equipment
Replaces: New Holland SBA408620002
O.D.: 3 9/32 (83.3)
 Flange 5 (127.0)
I.D.: 1/4 (6.4) & 1 3/4 (44.5)
Height: 7 11/32 (186.5)
A. Gskt: [2] Attached

PA30064

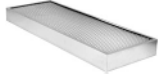

Cab Air Element
Fits: Challenger, Gleaner, Massey Ferguson Combines
Replaces: Massey Ferguson 71393893
Length: 23 11/16 (601.7)
Width: 9 (228.6)
Height: 2 3/16 (55.6)

RS30065



Radial Seal Air Element
Notes: Must use RS30065 KIT (with Lid) on first installation only.
 Use RS30065 (Element only) on subsequent applications.
Fits: Applications previously using RS5362. Mercedes-Benz Trucks
Replaces: Mercedes-Benz A0040942404; Baldwin RS5362
O.D.: 15 7/8 (403.2)
I.D.: 8 23/32 (221.5) One End
Height: 12 11/16 (322.3)

RS30065 KIT



Radial Seal Air Element with Lid
Notes: Must use RS30065 KIT (with Lid) on first installation only.
 Use RS30065 (Element only) on subsequent applications.
Fits: Applications previously using RS5362. Mercedes-Benz Trucks
Replaces: Mercedes-Benz A0040942404; Baldwin RS5362; Donaldson P785542; Fleetguard AF26165
Element and Lid
O.D.: 15 7/8 (403.2)
 Lid 20 15/32 (519.9)
I.D.: 8 23/32 (221.5) One End
Height: 13 5/16 (338.1)
F. Gskt: [1] Included
Element Only
O.D. 15 7/8 (403.2)
I.D. 8 23/32 (221.5)
Height 12 11/16 (322.3)

PA30066



Oval Air Element
Fits: Caterpillar CT660 Truck
Replaces: Caterpillar 3903433
O.D.: 16 3/8 (415.9) to 21 3/4 (552.5)
I.D.: 7 5/32 (181.8) & 12 7/16 (315.9)
Height: 7 23/32 (196.1)

PA30067



Air Element with Foam Wrap
Fits: Quincy Compressors
Replaces: Quincy 127357E004
O.D.: 8 1/4 (209.6)
I.D.: 4 9/16 (115.9)
Height: 9 5/8 (244.5)

PA30068



Air Element
Fits: Cub Cadet Lawn Tractor
O.D.: 4 1/16 (103.9)
 Flange 5 9/32 (134.1)
I.D.: 1/4 (6.4) & 1 15/32 (37.3)
Height: 6 1/32 (153.2)
A. Gskt: [1] Included
F. Gskt: [1] Wing Nut

PA30069



Conical-Shaped Air Element
Fits: Caterpillar Marine Engines
Replaces: Caterpillar 2076870
O.D.: 7 1/4 (184.2) to 12 1/4 (311.2)
I.D.: 10 1/8 (257.2) One End
Height: 15 (381.0)

Measurements Are Shown In Inches And (Millimeters)



WARNING: These products can expose you to chemicals, including Diisononyl Phthalate, Carbon black extracts, Nickel, 1,3 Butadiene, Ethylene Oxide, Epichlorohydrin, which are known to the State of California to cause cancer, and Bisphenol, Ethylene Glycol, Ethylene Oxide, 1,3 Butadiene, Epichlorohydrin, which are known to the State of California to cause birth defects or other reproductive harm. For more information go to www.P65Warnings.ca.gov.

PA30070



Wire Mesh Supported Air Element
Fits: Caterpillar Marine Engines
Replaces: Caterpillar 1777375
O.D.: 8 25/32 (223.0)
I.D.: 7 7/16 (188.9) One End
Height: 10 11/32 (262.7)

RS30077



Radial Seal Outer Air Element
Fits: Dynapac CC122, CC122C Rollers
Use With: RS30078
Replaces: Dynapac 380295;
 Donaldson P782299
O.D.: 5 1/32 (127.8)
I.D.: 3 5/32 (80.2) One End
Height: 9 23/32 (246.9)

CA30071



Channel Flow Primary Air Element
Fits: Caterpillar, Claas Equipment
Use With: PA30072
Replaces: Caterpillar 2525001;
 Claas 1094005
O.D.: 9 1/16 (230.2) to 11 11/16 (296.9)
Height: 7 3/4 (196.9)
A. Gskt: [1] Attached

RS30078



Radial Seal Inner Air Element
Fits Inside: RS30077
Fits: Dynapac CC122, CC122C Rollers
Replaces: Dynapac 380294;
 Donaldson P782300
O.D.: 3 5/16 (84.1)
I.D.: 2 3/8 (60.3) One End
Height: 9 3/32 (231.0)

PA30072



Secondary Air Element
Fits: Caterpillar, Claas Equipment
Use With: CA30071
Replaces: Caterpillar 2525002
O.D.: 8 1/4 (209.6) to 10 7/8 (276.2)
Height: 1 11/16 (42.9)

CA30079



Channel Flow Air Element
Fits: McCormick Tractors; New Holland
 Loaders; Skyjack Telehandlers
Replaces: Donaldson P608675
O.D.: 5 1/8 (130.2) to 12 7/8 (227.0)
Height: 11 5/16 (287.3)

PA30073



Air Element in Disposable Housing
Notes: Inside-Out flow direction.
Contains: Bleed Valve
Fits: Various Buses, Equipment and Trucks
 with Farr ECO-Style Air Filters
Replaces: Farr 94973007
O.D.: 11 (279.4)
Inlet: 6 7/8
Height: 19 3/4 (501.7)

PA30080



Cab Air Element with Pull Ring
Fits: Caterpillar Equipment
Replaces: Caterpillar 1858154;
 Donaldson P616850
Length: 9 21/32 (245.3)
Width: 5 5/16 (134.9)
Height: 25/32 (18.3)

PA30074

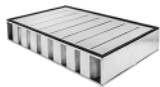

Dynacell Panel Air Element
Fits: Railroad and Marine Applications
Length: 29 1/2 (749.3)
Width: 19 (482.6)
Height: 5 (127)

PA30081

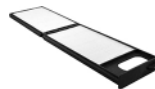

Cab Air Element
Notes: Two filters hinged together.
Fits: Kobelco, New Holland Excavators
Replaces: New Holland YN50V01014P1P,
 YN50V01014P1
Length: 18 29/32 (480.2)
Width: 4 7/8 (123.8)
Height: 19/32 (15.1)
A. Gskt: [1] Attached to Each Element

PA30075



Wire Mesh Supported Air Element
Fits: Caterpillar Marine Engines
Replaces: Caterpillar 2436350
O.D.: 8 7/16 (214.3)
I.D.: 6 1/2 (165.1) One End
Height: 7 (177.8)

PA30086

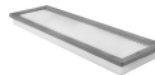

Panel Air Element
Notes: For air conditioning.
Fits: John Deere Equipment
Replaces: John Deere RE198488
Length: 15 1/4 (387.4)
Width: 4 29/32 (124.6)
Height: 1 7/32 (31.0)

PA30076



Conical-Shaped Air Element
Fits: Cat 3412, 3412B, 3412E Marine Engines
Replaces: Caterpillar 6I0384
O.D.: 7 (177.8) to 8 3/4 (222.3)
I.D.: 5 3/4 (146.1) & 7 1/2 (190.5)
Height: 12 (304.8)

RS30087



Radial Seal Outer Air Element
Fits: Hammel Red Giant Shredder with
 Caterpillar C18 Engine
Use With: RS30088
Replaces: Donaldson P785394, X770688
O.D.: 14 (355.6)
I.D.: 9 (228.6) One End
Height: 25 (635.0)

Measurements Are Shown In Inches And (Millimeters)

WARNING: These products can expose you to chemicals, including Diisononyl Phthalate, Carbon black extracts, Nickel, 1,3 Butadiene, Ethylene Oxide, Epichlorohydrin, which are known to the State of California to cause cancer, and Bisphenol, Ethylene Glycol, Ethylene Oxide, 1,3 Butadiene, Epichlorohydrin, which are known to the State of California to cause birth defects or other reproductive harm. For more information go to www.P65Warnings.ca.gov.

RS30088



Radial Seal Inner Air Element
Fits Inside: RS30087
Fits: Hammel Red Giant Shredder with Caterpillar C18 Engine
Replaces: Donaldson P785395, X770688
O.D.: 8 23/32 (221.5)
I.D.: 7 1/32 (178.6) One End
Height: 22 31/32 (583.4)

PA30095



Oval Air Element
Fits: Challenger, Massey Ferguson Tractors
Replaces: Massey Ferguson 4375638M1
O.D.: 7 15/16 (201.6) to 11 1/4 (285.8)
I.D.: 1 9/16 (39.7) & 4 3/8 (111.1)
Height: 8 1/16 (204.8)

RS30090-FN



Radial Seal Outer Air Element with Fins
Fits: International 4900 Series Trucks with HT570 Engine, 7400 WorkStar with DT466, MaxxForce DT, MaxxForce 9 Engines, 7500 WorkStar with HT530, MaxxForce 10 Engines
Replaces: International 3532801C1
O.D.: 10 1/4 (260.4)
 Fins 12 (304.8)
I.D.: 6 1/2 (165.1)
Height: 15 7/8 (403.2)
Related To: RS4636 (without Fins)

PA30096

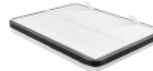

Cab Air Element with Pull Tabs
Fits: Case, Link-Belt Excavators
Replaces: Case KHR13330
Length: 9 1/2 (241.3)
Width: 7 (177.8)
Height: 1 3/32 (27.8)
A. Gskt: [1] Attached

RS30091



Radial Seal Outer Air Element
Fits: Fendt Tractors
Use With: RS30092
Replaces: Fendt H916201091050; Donaldson P783400; Fleetguard AF26205
O.D.: 10 31/32 (278.6)
I.D.: 5 13/16 (147.6) One End
Height: 18 3/16 (462.0)

PA30098



Cab Air Element
Fits: Caterpillar Pipelayers
Replaces: Caterpillar 2894225
Length: 16 17/32 (419.9)
Width: 5 (127.0)
Height: 1 3/16 (30.2)
A. Gskt: [1] Attached

RS30099



Radial Seal Oval Air Element
Fits: Kohler Engines
Replaces: Kohler 6208304S
O.D.: 5 9/16 (141.3)
I.D.: 3 1/4 (82.6) One End
Height: 8 5/8 (219.1)

RS30092



Radial Seal Inner Air Element
Fits Inside: RS30091
Fits: Fendt Tractors
Replaces: Fendt H916201091060; Donaldson P783401; Fleetguard AF26206
O.D.: 5 29/32 (150.0)
I.D.: 4 7/16 (112.7) One End
Height: 17 1/8 (435.0)

PA30100



Inner Air Element
Fits Inside: PA30101
Fits: Gehl Excavators; Wacker/Wacker Neuson Excavators, Wheel Dumpers
Replaces: J.C. Bamford 16546LC50A; Kubota K3271-82240; Nissan 16546LC50A
O.D.: 2 1/8 (54.0)
I.D.: 1 11/16 (42.9) One End
Height: 7 3/16 (182.6)

PA30093



Cab Air Element
Fits: Kenworth T680, Peterbilt 579 Truck
Replaces: Peterbilt X1987001
Length: 8 15/16 (227.0)
Width: 7 7/8 (200.0)
Height: 1 3/16 (30.2)

PA30101



Outer Air Element
Fits: Gehl Excavators; Wacker/Wacker Neuson Excavators, Wheel Dumpers
Replaces: J.C. Bamford 32/925742; Kubota K3271-82240; Nissan 16546LC50A
O.D.: 3 5/8 (92.1)
I.D.: 2 5/16 (58.7) One End
Height: 7 1/16 (179.4)

PA30094

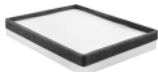

Cab Air Element
Fits: Case, Link-Belt Excavators
Replaces: Case KHR13340, MMR80030
Length: 8 7/8 (225.4)
Width: 6 27/32 (173.8)
Height: 1 5/16 (33.3)
A. Gskt: [1] Attached

CA30102



Channel Flow EXO Air Element
Fits: Kenworth Trucks
Replaces: Paccar P611698
O.D.: 11 3/8 (288.9) to 18 23/32 (475.5)
Height: 6 1/2 (165.1)
A. Gskt: [1] Attached

Measurements Are Shown In Inches And (Millimeters)

! **WARNING:** These products can expose you to chemicals, including Diisononyl Phthalate, Carbon black extracts, Nickel, 1,3 Butadiene, Ethylene Oxide, Epichlorohydrin, which are known to the State of California to cause cancer, and Bisphenol, Ethylene Glycol, Ethylene Oxide, 1,3 Butadiene, Epichlorohydrin, which are known to the State of California to cause birth defects or other reproductive harm. For more information go to www.P65Warnings.ca.gov.

CA30103

Channel Flow EXO Air Element



Fits: Mercedes-Benz Actros II, Antos, Arocs European Trucks
Replaces: Mercedes-Benz 40946904, A0040946904; Donaldson DBA3745
O.D.: 7 3/8 (187.3) to 18 7/16 (468.3)
Height: 8 27/32 (224.6)
A. Gskt: [1] Attached
Flange 8 7/32 to 19 3/8
Related To: CA30104 (Tall Version) CA30105 (Short Version)

CA30104

Channel Flow EXO Air Element



Fits: Mercedes-Benz Actros II, Antos, Arocs European Trucks
Replaces: Mercedes-Benz 40946804, A0040946804; Donaldson DBA3746
O.D.: 7 3/8 (187.3) to 18 7/16 (468.3)
Height: 10 1/4 (260.4)
A. Gskt: [1] Attached
Flange 8 7/32 to 19 3/8
Related To: CA30103 CA30105 (Short Versions)

CA30105

Channel Flow EXO Air Element



Fits: Mercedes-Benz Actros II, Antos, Arocs European Trucks
Replaces: Mercedes-Benz A0040947204, 40947204; Mann & Hummel CP49001
O.D.: 7 3/8 (187.3) to 18 7/16 (468.3)
Height: 7 5/8 (193.7)
A. Gskt: [1] Included
Flange 8 7/32 to 19 3/8
Related To: CA30104 (Tall Version) CA30103 (Short Version)

RS30106

Radial Seal Cab Air Element



Fits: Fendt Tractors
Replaces: Fendt H931812140600
O.D.: 6 3/8 (161.9)
I.D.: 3 23/32 (94.5) One End
Height: 11 3/4 (298.5)

PA30107

Foam Cab Air Element



Fits: Peterbilt 579 Trucks with Cummins ISX, Paccar MX Series Engines
Replaces: Peterbilt W2084001
Length: 10 7/16 (265.1)
Width: 6 1/2 (165.1)
Height: 3/8 (9.5)

PA30108

Inner Air Element



Fits Inside: PA30109
Fits: Daewoo, Terex Excavators; Doosan Loaders
Replaces: Daewoo 24749057; Donaldson P902312
O.D.: 6 3/8 (161.9)
I.D.: 21/32 (16.7) & 5 9/32 (134.1)
Height: 17 25/32 (451.6)
A. Gskt: [1] Attached

PA30109

Outer Air Element



Fits: Daewoo, Terex Excavators; Doosan Loaders
Use With: PA30108
Replaces: Daewoo 24749051; Donaldson P902311
O.D.: 10 27/32 (275.4)
I.D.: 21/32 (16.7) & 6 17/32 (165.9)
Height: 19 7/16 (493.7)
A. Gskt: [1] Attached

PA30110

Cab Air Element

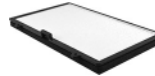

Fits: Case, Hyundai Loaders
Replaces: Hyundai 71LB00290
Length: 11 9/16 (293.7)
Width: 6 31/32 (177.0)
Height: 31/32 (24.6)
A. Gskt: [1] Attached

RS30112

Radial Seal Air Element



Fits: Hino Trucks
Replaces: Hino 17801E0130
O.D.: 12 9/32 (311.9)
I.D.: 6 31/32 (177.0) One End
Height: 16 1/2 (419.1)

PA30113

Pre-Filter Cab Air Element



Fits: R.V.I., Volvo Trucks, Vans with Volvo D11K, D13C, D13K, D16G, D16K Engines
Replaces: Renault 7482379897; Volvo 82354791
Length: 10 23/32 (272.3)
Width: 7 23/32 (196.1)
Height: 25/32 (19.8)

PA30114

Cab Air Element



Fits: Volvo European Trucks, Vans
Replaces: Renault 7482348995; Volvo 82348995
Length: 11 7/8 (301.6)
Width: 7 29/32 (200.8)
Height: 1 1/4 (31.8)
O-Ring: [1] Included

PA30115

Cab Air Element



Fits: Case Excavators
Replaces: Case KHR27540
Length: 7 29/32 (200.8)
Width: 7 3/16 (182.6)
Height: 21/32 (16.7)

RS30116

Radial Seal Outer Air Element



Fits: R.V.I. Trucks
Replaces: Renault 5001865725; Donaldson P785530
O.D.: 12 3/16 (309.6)
I.D.: 6 31/32 (177.0) One End
Length: 21 7/8 (555.6)

Measurements Are Shown In Inches And (Millimeters)

WARNING: These products can expose you to chemicals, including Diisononyl Phthalate, Carbon black extracts, Nickel, 1,3 Butadiene, Ethylene Oxide, Epichlorohydrin, which are known to the State of California to cause cancer, and Bisphenol, Ethylene Glycol, Ethylene Oxide, 1,3 Butadiene, Epichlorohydrin, which are known to the State of California to cause birth defects or other reproductive harm. For more information go to www.P65Warnings.ca.gov.

PA30117 Set of 2 Cab Air Elements
Notes: Requires 2 filters per application.
Fits: John Deere Harvesters, Tractors
Replaces: John Deere L155288
Each Filter:
Length: 8 7/32 (208.8)
Width: 5 23/32 (145.3)
Height: 7/8 (22.2)
A. Gskt: [1] Attached to Each Filter



PA30118 Primary Air Element
Fits: Wirtgen SP15, SP15i Slipform Pavers
Use With: PA30119
Replaces: Atlas-Weyhausen 8049126;
 Bomag 5821494; Sullair 274256;
 Wirtgen 2142670
O.D.: 5 7/16 (138.1) to 10 1/4 (260.4)
I.D.: 1 1/16 (27) & 4 13/16 (122.2) to
Height: 6 11/16 (169.9)



PA30119 Secondary Air Element
Fits: Wirtgen SP15, SP15i Slipform Pavers
Use With: PA30118
Replaces: Atlas-Weyhausen 8049127;
 Bomag 5821495; Sullair 274381;
 Wirtgen 2142671
O.D.: 5 5/8 (142.9) to 9 (228.6)
Height: 1 9/16 (39.7)



RS30120 Radial Seal Inner Air Element
Fits Inside: RS30121
Fits: Case, Case-International, New Holland
 Tractors
Replaces: Case 87517153;
 J.C. Bamford 32/926032
O.D.: 5 3/4 (146.1)
I.D.: 4 7/8 (123.8) One End
Height: 10 (254.0)



RS30121 Radial Seal Outer Air Element
Fits: Case, Case-International, New Holland
 Tractors
Use With: RS30120
Replaces: Case 87517154;
 J.C. Bamford 32/926031
O.D.: 10 7/8 (276.2)
I.D.: 5 3/4 (146.1) One End
Length: 12 1/4 (311.2)



PA30122 Panel Air Element
Fits: Mercedes-Benz Trucks
Replaces: Mercedes-Benz A9608300018
Length: 12 5/16 (312.7)
Width: 8 27/32 (224.6)
Height: 1 7/16 (36.5)



PA30123 Panel Air Element
Fits: Mercedes-Benz Trucks
Replaces: Mercedes-Benz A9608300118
Length: 12 5/16 (312.7)
Width: 8 27/32 (224.6)
Height: 1 7/16 (36.5)

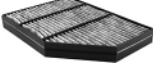

PA30124 Panel Air Element
Fits: Mercedes-Benz Trucks
Replaces: Mercedes-Benz 9608300218,
 A9608300218
Length: 12 5/16 (312.7)
Width: 8 27/32 (224.6)
Height: 1 7/16 (36.5)



PA30125 Air Element
Fits: Scania Stationary and Marine Engines
Replaces: Scania 1332341; Donaldson
 B125011; Fleetguard AH8513
O.D.: 12 19/32 (319.9)
I.D.: 5 (127.0) One End
Height: 10 5/16 (261.9)



PA30126 Cab Air Element
Fits: Case-International, New Holland
 Harvesters, Windrowers
Replaces: Case 84058793
Length: 20 5/32 (512.0)
Width: 6 7/8 (174.6)
Height: 1 15/32 (37.3)



PA30127 Cab Air Element with Pull Tab
Fits: Bobcat Utility Vehicles
Replaces: Bobcat 6693221
Length: 11 7/32 (285.0)
Width: 7 (177.8)
Height: 29/32 (23.0)
A. Gskt: [2] Attached

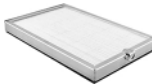

RS30128 Radial Seal Outer Air Element
Fits: Donaldson Housings
Use With: RS30129
Replaces: Donaldson P786197, X770683;
 Atlas Copco 3222188161
O.D.: 14 (355.6)
I.D.: 9 (228.6) One End
Height: 19 7/16 (498.7)



RS30129 Radial Seal Inner Air Element
Fits Inside: RS30128
Fits: Donaldson Housings
Replaces: Donaldson P786198, X770683
O.D.: 9 1/32 (229.4)
I.D.: 7 1/32 (178.6) One End
Height: 17 7/16 (442.9)



RS30130 Radial Seal Outer Air Element
Fits: Mercedes-Benz Latin American Buses,
 South American Buses, Trucks, Vans
Use With: RS5676
Replaces: Agco 6211381M1; Mercedes-Benz
 3760948204, A3760948204
O.D.: 10 7/16 (265.1)
I.D.: 5 5/8 (142.9) One End
Height: 17 1/4 (438.2)



Measurements Are Shown In Inches And (Millimeters)

 **WARNING:** These products can expose you to chemicals, including Diisononyl Phthalate, Carbon black extracts, Nickel, 1,3 Butadiene, Ethylene Oxide, Epichlorohydrin, which are known to the State of California to cause cancer, and Bisphenol, Ethylene Glycol, Ethylene Oxide, 1,3 Butadiene, Epichlorohydrin, which are known to the State of California to cause birth defects or other reproductive harm. For more information go to www.P65Warnings.ca.gov.

CA30131



Channel Flow Air Element
Contains: Three Bolts Included
Fits: Freightliner Trucks with Cummins Engines
Replaces: Donaldson P621097; Freightliner P621097
O.D.: 12 1/16 (306.4)
Flange: 14 27/32 (377)
Height: 8 3/32 (205.6)
A. Gskt: [1] Included

CA30132



Channel Flow Air Element
Contains: Four Bolts Included
Fits: Freightliner 114SD; Western Star 4700 Trucks with Cummins and Detroit Diesel Engines
Replaces: Freightliner P619498; Western Star Truck P619498; Donaldson P634517
O.D.: 12 1/16 (306.4)
Flange: 14 27/32 (377)
Height: 10 (254)
A. Gskt: [1] Included

RS30133



Radial Seal Outer Air Element
Fits: Blue Bird All American School Buses with Cummins ISB, ISC Engines
Use With: RS30134
Replaces: Blue Bird 10013632; Racor 500375001, 500375001BB
O.D.: 12 3/8 (314.3)
I.D.: 7 11/16 (195.3) One End
Height: 20 5/8 (523.9)

RS30134



Radial Seal Inner Air Element
Fits Inside: RS30133
Fits: Blue Bird All American School Buses with Cummins ISB, ISC Engines
Replaces: Blue Bird 10013633; Farr 500443001
O.D.: 7 3/16 (182.6)
I.D.: 4 13/16 (122.2) One End
Height: 20 1/2 (520.7)

RS30135



Radial Seal Outer Air Element
Fits: Atlas Copco Drilling Equipment
Use With: RS30136
Replaces: Atlas Copco 3222188151; Donaldson P785590
O.D.: 12 1/8 (308.0)
I.D.: 7 (1778) One End
Height: 20 5/8 (523.9)

RS30136



Radial Seal Inner Air Element
Fits Inside: RS30135
Fits: Atlas Copco Drilling Equipment
Replaces: Atlas Copco 3222188154
O.D.: 7 1/16 (179.4)
I.D.: 5 3/4 (146.1) One End
Height: 18 13/32 (467.5)

PA30137



Cab Air Element
Fits: Caterpillar Excavators, Material Handlers
Replaces: Caterpillar 2931184
Length: 23 3/16 (589)
Width: 4 1/2 (114.3)
Height: 7/8 (22.2)

PA30138



Panel Air Element
Fits: Industrial Applications
Replaces: Airguard DP40-217; Farr 49880008
Length: 19 1/2 (495.3)
Width: 9 1/2 (241.3)
Height: 1 3/4 (44.5)

PA30139



Panel Air Element
Fits: Industrial Applications
Replaces: CLC Air DP40-220; Farr 049880007, 49880007
Length: 19 1/2 (495.3)
Width: 11 1/2 (292.1)
Height: 1 3/4 (44.5)

PA30140



Cab Air Element with Pull Tab
Fits: Peterbilt 388 with Cummins ISX (11.9L), (15.0L), Paccar MX Engines
Replaces: Peterbilt 5S014010; Donaldson P629015
Length: 10 1/32 (254.8)
Width: 7 15/16 (210.6)
Height: 1 7/32 (31)

PA30141



Cab Air Element with Pull Tab
Fits: Case Excavators
Replaces: Case KHR27260; New Holland KRH27260
Length: 9 1/4 (235)
Width: 7 7/32 (183.4)
Height: 1 13/32 (35.7)

RS30142



Radial Seal Air Element
Notes: Must use RS30142 KIT on first installation.
Fits: Scania Trucks
Replaces: Scania 1869993, 1869995
O.D.: 11 15/16 (303.2)
I.D.: 6 19/32 (167.5) One End
Height: 18 1/8 (460.4)
Related To: RS30142 KIT (with Lid)

RS30142 KIT



Radial Seal Air Element with Lid
Notes: Element only is RS30142
Fits: Scania Trucks
Replaces: Scania 1868883, 1869995; Baldwin RS5542
O.D.: 11 15/16 (303.2)
Lid: 14 3/8 (365.1)
I.D.: 6 19/32 (167.5) One End
Height: 18 1/8 (460.4)

RS30143



Radial Seal Air Element
Notes: Must use RS30143 KIT (with Lid) on first installation.
Contains: Flame Retardant Media
Fits: Scania Trucks
Replaces: Scania 1728817, 1869992, 1869994; Baldwin RS5671; Donaldson P785519
O.D.: 11 29/32 (302.4)
I.D.: 6 5/8 (168.3) One End
Height: 21 9/32 (539.8)

Measurements Are Shown In Inches And (Millimeters)

WARNING: These products can expose you to chemicals, including Diisononyl Phthalate, Carbon black extracts, Nickel, 1,3 Butadiene, Ethylene Oxide, Epichlorohydrin, which are known to the State of California to cause cancer, and Bisphenol, Ethylene Glycol, Ethylene Oxide, 1,3 Butadiene, Epichlorohydrin, which are known to the State of California to cause birth defects or other reproductive harm. For more information go to www.P65Warnings.ca.gov.

RS30143 KIT



Radial Seal Air Element with Lid
Notes: Element only is RS30143.
Contains: Flame Retardant Media
Fits: Scania Trucks
Replaces: Scania 1728817, 1869992, 1869994;
 Baldwin RS5671; Donaldson P785519
O.D.: 11 29/32 (302.4)
 Lid (384.2)
I.D.: 6 5/8 (168.3) One End
Height: 21 9/32 (539.8)

PA30144



Panel Air Element
Fits: Wacker Vibratory Rammers
Replaces: Wacker 157193
Length: 6 5/8 (168.3)
Width: 3 3/4 (95.3)
Height: 2 1/8 (54.0)

PA30145



Outer Air Element
Fits: Hyundai R360LC-7A, R450LC-7
 Excavators, HL770, HL770-7 Loaders,
 all with Cummins Engines
Use With: PA30146
Replaces: Hyundai 11NB20120, 11NB20120A,
 14L101560; Fleetguard AF26664
O.D.: 12 3/32 (307.2)
I.D.: 15/16 (23.8) & 7 11/16 (195.3)
Height: 21 25/32 (553.2)
A. Gskt: [1] Attached

PA30146



Inner Air Element
Fits Inside: PA30145
Fits: Hyundai R360LC-7A, R450LC-7
 Excavators, HL770, HL770-7 Loaders,
 all with Cummins Engines
Replaces: Hyundai 11NB20130, 14L101570;
 Fleetguard AF27843
O.D.: 7 5/8 (193.7)
I.D.: 5/8 (15.9) & 6 1/16 (154.0)
Height: 21 (533.4)
A. Gskt: [1] Attached

RS30147



Radial Seal Air Element
Fits: JLG 450AJ, 460SJ, 3394RT, 4394RT
 Aerial Lifts with Deutz D2.9L4 Engine
Replaces: JLG 70003937
O.D.: 4 1/8 (104.8)
I.D.: 2 5/16 (58.7) One End
Height: 11 21/32 (296.1)
I.Gskt: [1] Attached

PA30148



Cab Air Element with Pull Tab
Fits: Komatsu Graders
Replaces: Komatsu 23B8099310
Length: 8 3/16 (208.0)
Width: 4 9/16 (115.9)
Height: 19/32 (15.2)
A. Gskt: [1] Attached

PA30149

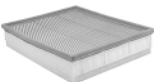

Panel Air Element with Foam Pad
Fits: 10/2001-7/2004 Renault Mascott 110 DCI,
 130 DCI, 150 DCI with DCI 2.8 Engine
Replaces: Renault 5001847123, 5010317300,
 7702295409
Length: 12 15/32 (316.7)
Width: 10 9/32 (261.1)
Height: 2 17/32 (64.3)

PA30150



Cab Air Element
Fits: Komatsu Excavators
Replaces: Komatsu 2A59791551
Length: 8 11/32 (211.9)
Width: 7 5/8 (193.7)
Height: 1 3/32 (27.8)
A. Gskt: [1] Attached

PA30151



Cab Air Element with Pull Tab
Fits: Kobelco, New Holland Excavators
Replaces: New Holland LQ50V01008P1
Length: 9 7/16 (239.7)
Width: 7 11/16 (195.3)
Height: 1 17/32 (38.9)

PA30152



Cab Air Element
Fits: Komatsu Excavators
Replaces: Komatsu 2089797740; Hifi/Jura
 Filtration SC80012; Sakura CA56080
Length: 7 25/32 (196.1)
Width: 4 1/32 (102.4)
Height: 3/4 (19.1)

PA30153



Breather Filter
Fits: Volvo Excavators, Loaders
Replaces: Volvo 4361204
O.D.: 3 5/32 (80.1)
Height: 2 29/32 (73.8)

PA30154



Foam Cab Air Element
Fits: Caterpillar Backhoe/Loaders
Replaces: Caterpillar 2067514;
 Fleetguard AF55756
Length: 8 15/16 (227.0)
Width: 2 1/2 (63.5)
Height: 3/4 (19.1)

PA30155



Foam Cab Air Element
Fits: Mercedes/Evobus Citaro
Replaces: Mercedes-Benz 18353447;
 Mann & Hummel CU481110
Length: 18 11/32 (465.9)
Width: 8 31/32 (227.8)
Height: 25/32 (19.8)

PA30156

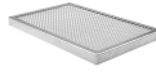

Cab Air Element
Fits: Dressta, Komatsu Dozers
Replaces: Komatsu 4270722130
Length: 11 13/16 (300.0)
Width: 7 17/32 (191.3)
Height: 25/32 (19.8)

PA30157



Hydraulic Tank Breather
Fits: Komatsu Excavators, Loaders
Replaces: Komatsu 4236035460
O.D.: 1 31/32 (50)
I.D.: 1 13/32 (35.7)
Height: 19/32 (15.1)

Measurements Are Shown In Inches And (Millimeters)

WARNING: These products can expose you to chemicals, including Diisononyl Phthalate, Carbon black extracts, Nickel, 1,3 Butadiene, Ethylene Oxide, Epichlorohydrin, which are known to the State of California to cause cancer, and Bisphenol, Ethylene Glycol, Ethylene Oxide, 1,3 Butadiene, Epichlorohydrin, which are known to the State of California to cause birth defects or other reproductive harm. For more information go to www.P65Warnings.ca.gov.

PA30158

Air Element



Fits: Donaldson Housings
Replaces: Donaldson B105002
O.D.: 10 1/2 (266.7)
I.D.: 5 (127.0) One End
Height: 15 (381.0)

PA30164

Panel Air Element with Pull Tabs



Fits: Komatsu Dozers
Replaces: Komatsu 12Y9791181
Length: 26 1/16 (662)
Width: 2 1/2 (63.5)
Height: 19/32 (15.1)
A. Gskt: [1] Included

RS30159

Radial Seal Outer Air Element



Fits: Hitachi, John Deere Equipment
Use With: RS30160
Replaces: Hitachi 4700940; John Deere AXE42066; Donaldson P608116
O.D.: 9 9/16 (242.9)
Flange 12 3/16 (309.6)
I.D.: 7 1/4 (184.2) One End
Height: 20 3/8 (517.5)

PA30165

Foam Cab Air Element



Fits: Freightliner Cascadia Evolution
Replaces: Freightliner VCCT1000906J; Donaldson P628394
Length: 9 1/32 (229.4)
Width: 5 1/32 (127.8)
Height: 1/4 (6.4)

RS30160

Radial Seal Inner Air Element



Fits Inside: RS30159
Fits: Hitachi, John Deere Equipment
Replaces: Donaldson P608391
O.D.: 5 15/16 (150.8)
I.D.: 4 9/32 (108.7) One End
Height: 19 21/32 (499.3)

PA30166

Foam Cab Air Element



Fits: Freightliner Cascadia Evolution
Replaces: Freightliner VCCT1000917R; Donaldson P628395
Length: 9 17/32 (242.1)
Width: 6 23/32 (170.8)
Height: 1/4 (6.4)

RS30168

Radial Seal Outer Air Element



Fits: Liebherr-Mobilkrane LTM 1130-5.1 Mobile Cranes
Use With: RS30169
Replaces: Hitachi 59004010; Liebherr 10278553; Mann & Hummel C23632/1; Tada 99707015285
O.D.: 8 7/8 (225.4)
I.D.: 4 15/16 (125.4) One End
Height: 14 (355.6)

RS30161

Radial Seal Outer Air Element



Fits: John Deere Equipment
Use With: RS30162
Replaces: John Deere AN221846; Donaldson P611539
O.D.: 8 1/4 (209.6)
Flange 9 31/32 (253.2)
I.D.: 5 23/32 (145.3) One End
Height: 18 7/8 (479.4)

RS30169

Radial Seal Inner Air Element



Fits Inside: RS30168
Fits: Liebherr-Mobilkrane LTM 1130-5.1 Mobile Cranes
Replaces: Mann & Hummel CF1250
O.D.: 4 1/4 (108.0)
I.D.: 3 9/16 (83.3) One End
Height: 13 1/4 (336.6)

RS30162

Radial Seal Inner Air Element



Fits Inside: RS30161
Replaces: John Deere Equipment
O.D.: 5 5/16 (134.9)
I.D.: 3 11/16 (93.7) One End
Height: 17 7/16 (442.9)

PA30170

Air Element



Contains: Threaded Stud
Fits: M.T.U. Diesel Engines
Replaces: M.T.U. 180945802; Donaldson B120472; Fleetguard AH24332
O.D.: 12 19/32 (319.9)
I.D.: 7 27/32 (199.2) One End
Height: 17 15/16 (455.6)

PA30163

Conical-Shaped Inner Air Element



Fits Inside: PA5584
Fits: Hyster, Yale Equipment
Replaces: Donaldson P603729
O.D.: 1 5/16 (33.3)
Flange 2 5/8 (66.7)
I.D.: 1 3/4 (44.5) One End
Height: 10 1/4 (260.4)

PA30171

Air Element



Contains: Threaded Stud
Fits: M.T.U. Applications
Replaces: M.T.U. 170941202; Donaldson B105036; Hifi/Jura Filtration SAB105036; Mann & Hummel C27040
O.D.: 10 9/16 (268.3)
I.D.: 5 1/16 (128.6) One End
Height: 16 15/16 (430.2)

PA30172

Foam Cab Air Element



Fits: Liebherr Dozers, Loaders
Replaces: Liebherr 7622972
Length: 14 31/32 (380.2)
Width: 9 21/32 (245.2)
Height: 1 3/16 (30.2)

Measurements Are Shown In Inches And (Millimeters)

WARNING: These products can expose you to chemicals, including Diisononyl Phthalate, Carbon black extracts, Nickel, 1,3 Butadiene, Ethylene Oxide, Epichlorohydrin, which are known to the State of California to cause cancer, and Bisphenol, Ethylene Glycol, Ethylene Oxide, 1,3 Butadiene, Epichlorohydrin, which are known to the State of California to cause birth defects or other reproductive harm. For more information go to www.P65Warnings.ca.gov.

PA30173

Cab Air Element



Fits: Liebherr Dozers, Loaders
Replaces: Liebherr 7622130
Length: 9 27/32 (250.0)
Width: 7 13/16 (198.4)
Height: 25/32 (19.8)

PA30174

Cab Air Element



Fits: John Deere Excavators
Replaces: John Deere FYA00001490
Length: 9 19/32 (243.7)
Width: 9 1/8 (231.8)
Height: 1 5/16 (33.3)

RS30175

Radial Seal Air Element



Fits: MAN Buses
Replaces: M.A.N. 81.08405-0030; Sullair 88291008-318; Donaldson P788716; Fleetguard AF27974
O.D.: 11 3/32 (281.8)
I.D.: 7 7/16 (188.9) One End
Height: 22 5/32 (562.8)

PA30177

Cab Air Element



Fits: Case, New Holland Dozers, Motor Graders
Replaces: Case 75326979; New Holland 75326979
Length: 10 5/32 (258.0)
Width: 6 17/32 (165.9)
Height: 27/32 (21.4)

PA30179

Foam Cab Air Element



Fits: Caterpillar Loaders, Off-Highway Trucks
Replaces: Caterpillar 1868228; Donaldson P505965
Length: 15 5/32 (385.0)
Width: 5 23/32 (145.3)
Height: 13/32 (10.3)

RS30180

Radial Seal Air Element



Fits: M.A.N. Lions City C, L LE, GL LE Buses
Replaces: M.A.N. 81083040093; Donaldson P782998
O.D.: 9 11/16 (246.1)
I.D.: 4 19/32 (116.7) One End
Height: 19 5/32 (486.6)

RS30181

Radial Seal Inner Air Element



Fits Inside: RS30182
Fits: Fendt Combines; Massey Ferguson, New Holland Harvesters
Replaces: New Holland 84072430; Massey Ferguson D46485600; Donaldson P781203; Fleetguard AF26215
O.D.: 5 29/32 (150.0)
I.D.: 4 13/32 (111.9) One End
Height: 22 3/32 (561.2)

RS30182

Radial Seal Outer Air Element



Fits: New Holland Harvesters
Use With: RS30181
Replaces: New Holland 84072431; Donaldson P789638; Fleetguard AF26214
O.D.: 11 1/32 (280.2)
I.D.: 5 13/16 (147.6) One End
Height: 22 29/32 (581.8)

PA30183

Cab Air Element

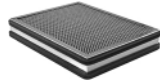

Contains: Charcoal Impregnated Media for Odor Control
Fits: Caterpillar Loaders
Replaces: Caterpillar 3483432
Length: 13 15/32 (342.1)
Width: 10 19/32 (269.1)
Height: 2 3/16 (55.6)
A. Gskt: 2 Attached

PA30185

Cab Air Element



Fits: Caterpillar Loaders
Replaces: Caterpillar 3535058
Length: 15 3/4 (400.1)
Width: 6 3/8 (161.9)
Height: 2 1/8 (54)

RS30187XP

Extreme Performance Nano Radial Seal Outer Air Element



Contains: Inlet Adapter
Fits: Peterbilt 389 Trucks
Replaces: Paccar X011623
O.D.: 13 3/32 (332.6)
I.D.: 4 5/8 (117.5) & 7 5/8 (193.7)
Height: 24 13/16 (630.2)
F. Gskt: [1] Included
Related To: RS5287XP (Standard Housing Gasket)

PA30188

Cab Air Element



Fits: R.V.I., Volvo European Trucks
Replaces: Renault 5001867491, 7421396525, 7485134455; Volvo 20559447, 21396525, 85134455
Length: 8 (203.2)
Width: 3 19/32 (91.3)
Height: 3/4 (19.1)

PA30189

Air Element with Foam Wrap



Contains: Bolt Hole
Fits: Robin Engines
Replaces: Subaru 26332610A1
O.D.: 6 29/32 (175.4)
I.D.: 1/4 (6.4) & 5 9/16 (141.3)
Height: 2 15/32 (62.7)
Grommets: [1] Attached

PA30190

Cab Air Element



Fits: Caterpillar Excavators, Forestry Equipment, Hydraulic Power Units, Material Handlers
Replaces: Caterpillar 2931183
Length: 23 5/8 (600)
Width: 4 7/8 (123.8)
Height: 1 1/32 (26.2)

Measurements Are Shown In Inches And (Millimeters)



WARNING: These products can expose you to chemicals, including Diisononyl Phthalate, Carbon black extracts, Nickel, 1,3 Butadiene, Ethylene Oxide, Epichlorohydrin, which are known to the State of California to cause cancer, and Bisphenol, Ethylene Glycol, Ethylene Oxide, 1,3 Butadiene, Epichlorohydrin, which are known to the State of California to cause birth defects or other reproductive harm. For more information go to www.P65Warnings.ca.gov.

RS30191



Radial Seal Inner Air Element

Fits Inside: RS30192
Replaces: Reytor IT3098S; Baldwin RS5295;
 Donaldson P623172; Fleetguard AA2986
O.D.: 6 23/32 (170.7)
I.D.: 6 1/16 (154.0)
Height: 15 11/16 (398.5)

RS30209



Radial Seal Outer Air Element

Fits: Agco, Challenger, Massey Ferguson Tractors
Replaces: Agco 3607884M91, 3607884M92;
 Hifi/Jura Filtration SA16370; RicoEurope SL60103; Wix WA10404
O.D.: 4 3/16 (106.4)
I.D.: 2 (50.8)
Height: 10 1/8 (257.2)

RS30192



Radial Seal Outer Air Element

Use With: RS30191
Replaces: Reytor IT3098; Baldwin RS5296;
 Donaldson P623166; Fleetguard AA2986
O.D.: 11 (279.0)
I.D.: 7 11/16 (195.3)
Height: 16 15/16 (430.2)

PA30211



Air Element

Fits: Caterpillar, Mitsubishi Lift Trucks
Replaces: Caterpillar 9206107410
O.D.: 5 1/4 (133.4)
I.D.: 2 1/32 (16.7) & 4 1/8 (104.8)
Height: 11 31/32 (304)
A. Gskt: [1] Included
F. Gskt: [1] Included

PA30204



Crankcase Breather

Fits: Volvo Marine Engines
Replaces: Volvo 843736, 876069,
 876069-6, 876069-9
O.D.: 3 5/16 (84.1)
I.D.: 1 5/8 (41.3) One End
Height: 6 7/16 (163.5)
F. Gskt: [1] Included

RS30216



Radial Seal Outer Air Element

Fits: Dynapac Compactors, Rollers
Use With: RS30217
Replaces: Atlas Copco 4700394690,
 3222188144; Dynapac 394690, 4700394690;
 Donaldson X770691, P785390
O.D.: 11 (279.4)
I.D.: 5 25/32 (146.8) One End
Height: 20 11/16 (525.5)

PA30206



Conical-Shaped Air Element

Contains: Flame Retardant Media
Fits: Hyster Lift Trucks
Replaces: Donaldson P616742;
 Hyster 1620142; Yale 580069337
O.D.: 5 18 (130.2)
 Flange 6 3/16 (157.2)
I.D.: 3 5/32 (80.2) One End
Height: 13 3/16 (335)
A. Gskt: [1] Included

RS30217



Radial Seal Inner Air Element

Fits Inside: RS30216
Fits: Dynapac Compactors, Rollers
Replaces: Atlas Copco 4700394691,
 32222188144; Dynapac 394691,
 4700394691; Donaldson X770691
O.D.: 5 29/32 (150)
I.D.: 4 7/16 (112.7) One End
Height: 18 5/16 (465.1)

PA30207



Conical-Shaped Outer Air Element

Fits: John Deere Loaders, Tractors
Use With: PA30208
Replaces: Donaldson P609221;
 JohnDeere RE282286
O.D.: 5 1/8 (130.2)
 Flange 6 3/16 (157.2)
I.D.: 3 5/32 (80.2) One End
Height: 13 3/16 (335.0)
A. Gskt: [1] Included

RS30223



Radial Seal Outer Air Element

Fits: Case, New Holland Motor Graders
Use With: RS30224
Replaces: Case 84286397;
 New Holland 84286397
O.D.: 9 21/32 (245.3)
I.D.: 5 17/32 (140.5) One End
Height: 19 13/32 (492.9)

PA30208



Inner Air Element

Fits Inside: PA30207
Fits: John Deere Loaders, Tractors
Replaces: Donaldson P608599;
 John Deere RE282287
O.D.: 2 9/32 (58)
 Flange 3 7/8 (98.4)
I.D.: 2 3/8 (60.3) One End
Height: 12 25/32 (324.6)

RS30224



Radial Seal Inner Air Element

Fits Inside: RS30223
Fits: Case, New Holland Motor Graders
Replaces: Case 84286397
O.D.: 5 11/16 (144.5)
I.D.: 5 5/32 (131) One End
Height: 19 (482.6)

Measurements Are Shown In Inches And (Millimeters)

WARNING: These products can expose you to chemicals, including Diisononyl Phthalate, Carbon black extracts, Nickel, 1,3 Butadiene, Ethylene Oxide, Epichlorohydrin, which are known to the State of California to cause cancer, and Bisphenol, Ethylene Glycol, Ethylene Oxide, 1,3 Butadiene, Epichlorohydrin, which are known to the State of California to cause birth defects or other reproductive harm. For more information go to www.P65Warnings.ca.gov.

RS30225



Radial Seal Outer Air Element
Fits: International, New Holland Tractors
Use With: RS30226
Replaces: New Holland 87741560;
 Fleetguard AF26345
O.D.: 12 1/16 (306.4)
I.D.: 7 3/4 (196.9)
Height: 13 11/16 (347.7)

RS30234



Radial Seal Air Element
Fits Inside: PA5583
Fits: Bobcat 5600 Turbo, 5610 Utility Vehicles
Replaces: Bobcat 6983022;
 Donaldson P602427
O.D.: 3 1/16 (77.8)
I.D.: 2 1/16 (52.4)
Height: 12 21/32 (321.5)

RS30226



Radial Seal Inner Air Element
Fits Inside: RS30225
Fits: International, New Holland Tractors
Replaces: New Holland 87741569;
 Fleetguard AF26346
O.D.: 7 3/16 (182.6)
I.D.: 5 27/32 (148.4)
Height: 12 3/4 (323.9)

PA30235



Outer Air Element
Contains: Flame Retardant Media
Fits: Claas, Liebherr, V.M.E., Volvo Equipment;
 Iveco, M.A.N., Mercedes-Benz Trucks
Use With: PA3494, PA3857
Replaces: Iveco 2996154, 41272534;
 Mercedes-Benz A0040945004;
 Donaldson P786829
O.D.: 11 15/16 (303.2)
I.D.: 7/16 (11.1) & 7 17/32 (191.3)
Height: 18 21/32 (473.9)
A. Gskt: [1] Included
F. Gskt: [1] Metal Included
Related To: PA2776 (Standard Media Version)

PA30228



Panel Air Element
Fits: Hyundai Excavators
Replaces: Hyundai 11Q690510; Hifi/Jura
 Filtration SC80048; SF-Filter SKL46644
Length: 8 1/4 (209.6)
Width: 4 5/8 (117.5)
Height: 25/32 (19.8)

RS30236



Radial Seal Air Element
Contains: Flame Retardant Media
Fits: R.V.I., Mack Truck
Replaces: Renault 5001865724;
 Volvo 20732730; Donaldson P786892
O.D.: 9 11/16 (246.1)
I.D.: 4 7/8 (123.8) One End
Height: 14 5/8 (371.5)
Related To: RS5301 (Standard Media Version)

PA30229



Panel Air Element
Fits: Hyundai Excavators
Replaces: Hyundai AM880002002, XJAU0153,
 11N690760; Donaldson P753339;
 Fleetguard AF26474
Length: 9 (228.6)
Width: 4 5/32 (105.6)
Height: 25/32 (19.8)

RS30232



Radial Seal Outer Air Element with Blank Band
Fits: Fendt Combines; Massey Ferguson
 Harvesters; Van Hool Astromega
 TD927, AG300 Buses
Replaces: Massey Ferguson D46485500;
 DAF 1146384, 1525439; Van Hool 20276705;
 Volvo 1155727, 41155727;
 Donaldson P781199
O.D.: 10 31/32 (278.6)
I.D.: 5 13/16 (147.6) One End
Height: 22 29/32 (581.8)

RS30237



Radial Seal Inner Air Element
Fits Inside: RS5756
Fits: Blue Bird All-American Buses
 w/Cummins ISB (5.9L) Eng.
Replaces: Blue Bird 10004114;
 Parker 500455001
O.D.: 7 1/2 (190.5)
I.D.: 4 1/8 (104.8) One End
Height: 19 13/32 (492.9)

PA30233-FN



Air Element with Fins
Fits: Manitou Lift Trucks
Replaces: Manitou 710467; Fiat 920007502;
 GPC FC280K; Donaldson P771511
O.D.: 7 15/16 (201.6)
 Fins 9 13/16 (249.2)
I.D.: 21/32 (16.7) & 3 9/16 (90.5)
Height: 13 5/8 (346.1)
A. Gskt: [1] Included
F. Gskt: [1] Included

RS30242



Radial Seal Inner Air Element
Replaces: Ingersoll-Rand 35393651
O.D.: 3 15/32 (88.1)
I.D.: 2 1/2 (63.5) One End
Height: 12 9/16 (319.1)

PA30243



Outer Air Element
Fits: Hitachi Excavators; John Deere
 Excavators
Use With: PA30244
Replaces: Hitachi 4642122;
 Donaldson P789077;
 Hifi/Jura Filtration SA18087
O.D.: 9 7/32 (234.2)
I.D.: 5 3/16 (131.8) One End
Height: 14 1/4 (362)
A. Gskt: [1] Included

Measurements Are Shown In Inches And (Millimeters)

WARNING: These products can expose you to chemicals, including Diisononyl Phthalate, Carbon black extracts, Nickel, 1,3 Butadiene, Ethylene Oxide, Epichlorohydrin, which are known to the State of California to cause cancer, and Bisphenol, Ethylene Glycol, Ethylene Oxide, 1,3 Butadiene, Epichlorohydrin, which are known to the State of California to cause birth defects or other reproductive harm. For more information go to www.P65Warnings.ca.gov.

PA30244



Inner Air Element

Fits Inside: PA30243
Fits: Hitachi Excavators;
 John Deere Excavators
Replaces: Hitachi 4642117;
 Donaldson P788912
O.D.: 5 5/32 (131)
I.D.: 2 1/32 (16.7) & 3 15/16 (100.0)
Height: 11 1/16 (281)
A. Gskt: [1] Included
F. Gskt: [1] Included

PA30251



Cab Air Element

Contains: Charcoal impregnated media for odor control.
Fits: John Deere Tractors
Replaces: John Deere L156225, L209778
Length: 7 23/32 (196.1)
Width: 5 1/8 (130.2)
Height: 1 9/16 (39.7)

PA30252



Cabin Air Filter

Fits: Kubota Tractors
Replaces: Kubota T185571600
Length: 12 3/16 (309.6)
Width: 4 1/32 (102.4)
Height: 1 11/16 (42.9)
A. Gskt: [1] Included

PA31000



Primary EnduraPanel Air Element

Fits: Cummins QSB6.7 (Final Tier 4, Interim Tier 4), QSC, QSC9, QSL9 (Final Tier 4, Interim Tier 4) Engines
Use With: PA31001 Secondary EnduraPanel
Replaces: Cummins 5261250;
 Fleetguard AF55015
Length: 11 23/32 (297.7)
Width: 10 31/32 (278.6)
Height: 14 1/16 (357.2)
A. Gskt: [1] Included

PA31001



Secondary EnduraPanel Air Element

Contains: Pull Tabs
Fits: Cummins QSB6.7 (Final Tier 4, Interim Tier 4), QSC, QSC9, QSL9 (Final Tier 4, Interim Tier 4) Engines
Use With: PA31000 Primary EnduraPanel
Replaces: Fleetguard AF55309
Length: 11 5/16 (287.3)
Width: 10 1/2 (266.7)
Height: 1 1/2 (38.1)
A. Gskt: [1] Included

PA31002



Primary EnduraPanel Air

Notes: Can be used with PA31003
Fits: Cummins QSB6.7 (Tier 4 Interim & Final), QSL9 (Tier 4 Interim & Final), QSX11.9, QSX 15 (Interim Tier 4) Engines
Replaces: Cummins 5261249; Fleetguard AF55014; Vogeles 2216429; Wirtgen 2220358; Donaldson DBA5292
Length: 15 31/32 (405.6)
Width: 5 7/8 (149.2)
Height: 14 (355.6)
A. Gskt: [1] Included

PA31003



Secondary EnduraPanel Air

Contains: Pleated Media
Fits: Cummins QSB6.7 (Tier 4 Interim & Final), QSL9 (Tier 4 Interim & Final), QSX11.9, QSX15 (Interim Tier 4) Engines
Use With: PA31002
Replaces: Cummins 5261251; Doosan 40050400030; Fleetguard AF55308; JCB 333E3686; Wirtgen 2220366; Vogeles 2216432; Donaldson P633483, X011872
Length: 15 1/4 (387.4)
Width: 5 1/4 (133.4)
Height: 1 15/32 (37.3)
A. Gskt: [1] Included

PA31004



Primary EnduraPanel Air

Notes: Can be used with PA31007 & PA31005
Fits: Cummins QSF 3.8 (Final Tier 4), QSB4.5 (Final Tier 4), QSF2.8 Naturally Aspirated (Tier 4), QSF2.8 Turbo (Tier 3), QSF 2.8 (Final Tier 4) Engines
Replaces: Fleetguard AF55020; JLG Industries Inc. 70024177; Doosan 46595499
Length: 9 1/8 (231.8)
Width: 7 19/32 (192.9)
Height: 9 7/8 (250.8)
A. Gskt: [1] Included

PA31005



Secondary EnduraPanel Air

Contains: Foam Media
Fits: Cummins QSF 3.8 (Final Tier 4), QSB4.5 (Final Tier 4), QSF2.8 Naturally Aspirated (Tier 4), QSF2.8 Turbo (Tier 3), QSF 2.8 (Final Tier 4) Engines
Use With: PA31004 and PA31006 w/ MAF Sensor.
Replaces: Agco 700738184; Fleetguard AF55312; JLG Industries Inc. 70024176
Length: 8 7/8 (225.4)
Width: 6 31/32 (177)
Height: 1 7/16 (36.5)
A. Gskt: [1] Included

PA31006



Primary EnduraPanel Air

Notes: Can be used with PA31007 & PA31005
Fits: Cummins QSF 3.8 (Final Tier 4), QSB4.5 (Final Tier 4), QSF2.8 Naturally Aspirated (Tier 4), QSF2.8 Turbo (Tier 3), QSF 2.8 (Final Tier 4) Engines
Replaces: Fleetguard AF55021; Cummins 5288553; JLG Industries Inc. 70024175
Length: 9 3/32 (231)
Width: 7 19/32 (192.9)
Height: 13 3/4 (349.3)
A. Gskt: [1] Included

PA31007



Secondary EnduraPanel Air

Contains: Pleated Media
Fits: Cummins QSF 3.8 (Final Tier 4), QSB4.5 (Final Tier 4), QSF2.8 Naturally Aspirated (Tier 4), QSF2.8 Turbo (Tier 3), QSF 2.8 (Final Tier 4) Engines
Use With: PA31004 & PA31006 w/o MAF Sensor
Replaces: Fleetguard AF55320; Cummins 5310325
Length: 8 7/7 (225.4)
Width: 6 31/32 (177)
Height: 1 7/16 (36.5)
A. Gskt: [1] Included

Measurements Are Shown In Inches And (Millimeters)

WARNING: These products can expose you to chemicals, including Diisononyl Phthalate, Carbon black extracts, Nickel, 1,3 Butadiene, Ethylene Oxide, Epichlorohydrin, which are known to the State of California to cause cancer, and Bisphenol, Ethylene Glycol, Ethylene Oxide, 1,3 Butadiene, Epichlorohydrin, which are known to the State of California to cause birth defects or other reproductive harm. For more information go to www.P65Warnings.ca.gov.

PA31010



Primary EnduraPanel Air
Fits: Bobcat Loaders Various Models, Telescopic Handlers with Doosan Engines
Use With: PA31011
Replaces: Bobcat 7286652, 7010030
Length: 11 3/8 (288.9)
Width: 10 7/16 (265.1)
Height: 6 19/32 (167.5)
A. Gskt: [1] Included

PA31011



Secondary EnduraPanel Air
Fits: Bobcat Loaders Various Models, Telescopic Handlers with Doosan Engines
Use With: PA31010
Replaces: Bobcat 7010031
Length: 10 7/16 (265.1)
Width: 5 15/32 (138.9)
Height: 1 1/2 (38.1)
A. Gskt: [1] Included

PA31012



Primary EnduraPanel Air Element
Notes: Can be used with PA31003 Secondary
Fits: Cummins QSB6.7 (Final Tier 4, Interim Tier 4, Tier 4), QSL9 Engines
Replaces: Cummins 5261248
Length: 16 1/8 (409.6)
Width: 5 27/32 (148.4)
Height: 10 1/32 (254.8)
A. Gskt: [1] Included

PA32001



Primary EnduraCube Air Element
Notes: Can be used with PA32004 Secondary EnduraCube
Fits: International 4300, 4300LP, 4400, 4400 DuraStar, TerraStar Trucks with Cummins ISB (6.7L), ISL (8.9L), L9; MaxxForce 7 (6.4L), 9 (9.3L), DT (7.6L) Engines
Replaces: IHC 2517298C1, 2602212C1
Length: 10 13/16 (274.6)
Width: 10 (254)
Height: 8 3/32 (205.6)
A. Gskt: [1] Included

PA32004

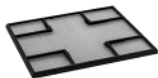

Secondary EnduraCube Air Element
Fits: International 4300, 4300LP, 4400, 4400 DuraStar, TerraStar Trucks with Cummins ISB (6.7L), ISL (8.9L), L9; MaxxForce 7 (6.4L), 9 (9.3L), DT (7.6L) Engines
Use With: PA32001 Primary EnduraCube
Replaces: IHC 2602211C1
Length: 8 21/32 (219.9)
Width: 7 23/32 (196.1)
Height: 11/32 (8.7)

B40000



Lube Spin-on
Fits: 2013-on Chevrolet Spark L4 with 1.2L Engine
Replaces: General Motors 96985730
Thread: M18 x 1.5
O.D.: 2 25/32 (70.6)
Height: 2 13/16 (71.4)
I.Gskt: [1] Included

P40001



Lube Element
Fits: 2014-15 Freightliner Sprinter, Mercedes-Benz E250, GLK250 Sprinter, all with 4-2143cc (2.1L) FI Turbo Diesel Engine
Replaces: Mercedes-Benz 6511800109
O.D.: 2 9/16 (65.1)
I.D.: 1 7/32 (31.0)
Height: 4 17/32 (115.1)
A. Gskt: [2] Attached
O-Ring: [3] Included

P40002



Lube Element
Contains: By-Pass Valve
Fits: Yamaha YZ250F, YZ450F, WR250R Motorcycles
Replaces: Yamaha 5TA1344000
O.D.: 1 1/2 (38.1)
I.D.: 17/32 (13.5) One End
Height: 1 27/32 (46.8)
End Seals: [2] Attached

P40003



Lube Element
Fits: Mercedes-Benz European Light-Duty Trucks
Replaces: Mercedes-Benz 9361800009, 9361840225, A9361800009, A9361840225
O.D.: 3 1/2 (88.9)
I.D.: 1/2 (12.7) & 1 5/8 (41.3)
Height: 8 3/16 (208.0)
O-Ring: [1] Included

C40004



By-Pass Lube Sock
Fits: Massey Ferguson Applications
Replaces: Massey Ferguson 1013890M1
O.D.: 3 1/8 (79.4)
I.D.: 27/32 (21.4) & 15/16 (23.8)
Height: 9 5/8 (244.5)
A. Gskt: [1] Included
F. Gskt: [1] Included
Related To: Related to BF825 (Can-Type Version)

C40005



By-Pass Lube Sock
Fits: Massey Ferguson Applications
Replaces: Massey Ferguson 1501049M91
O.D.: 3 5/32 (80.2)
I.D.: 5/8 (15.9) & 27/32 (21.4)
Height: 6 7/8 (174.6)
A. Gskt: [1] Included
O-Ring: [1] Included

B40006



Lube Spin-on
Fits: Blaw Knox Paving Equipment
Replaces: Blaw Knox 11241400
Thread: 3/4 -16
O.D.: 3 1/16 (77.8)
Height: 3 1/2 (88.9)
I.Gskt: [1] Included

BC40007



Centrifugal By-Pass Lube Element
Fits: 10/07-on Ford Transit 3.2 TDCI European Light-Duty Vehicles
Replaces: Ford 1372808
O.D.: 3 1/4 (82.6)
I.D.: 1/4 (6.4) & 5/16 (7.9)
Height: 2 11/16 (68.3)
A. Gskt: [2] Metal Washers
O-Ring: [1] Included

Measurements Are Shown In Inches And (Millimeters)

! WARNING: These products can expose you to chemicals, including Diisononyl Phthalate, Carbon black extracts, Nickel, 1,3 Butadiene, Ethylene Oxide, Epichlorohydrin, which are known to the State of California to cause cancer, and Bisphenol, Ethylene Glycol, Ethylene Oxide, 1,3 Butadiene, Epichlorohydrin, which are known to the State of California to cause birth defects or other reproductive harm. For more information go to www.P65Warnings.ca.gov.

P40008

Lube Element



Contains: Offset By-Pass Pin
Fits: 2013-on DAF Trucks with Paccar MX 11 Euro 6 Engine
Replaces: DAF 1928868
O.D.: 4 1/4 (108.0)
I.D.: 5/8 (15.9) & 1 11/16 (42.9)
Height: 10 1/4 (260.4)
O-Ring: [2] Included

P40014

Lube Element



Fits: Volkswagen Fox, Polo MK4, MK5 Automotive, Light-Duty Trucks
Replaces: Volkswagen 3D198819A
O.D.: 2 1/2 (63.5)
I.D.: 1 3/8 (34.9)
Height: 2 9/16 (65.1)
O-Ring: [1] Included

BC40009

Centrifugal Lube Element



Fits: 2013-on DAF Trucks with Paccar MX11 Euro 6 Engine
Replaces: DAF 1928869
O.D.: 3 7/8 (98.4)
I.D.: 3/8 (9.5) & 1 1/4 (31.8)
Height: 5 3/8 (136.5)
O-Ring: [2] Included

BT40015

Air Breather Spin-on



Fits: Caterpillar Excavators, Loaders, Off-Highway Trucks
Replaces: Caterpillar 9C4937
Thread: 3/8 -18 NPT
O.D.: 3 (76.2)
Height: 2 25/32 (70.6)

P40010

Lube Element



Fits: 2012-13 Audi A5, 2013 A4, 2015 A3, S3; 2014-15 Volkswagen Beetle, Jetta, Passat, 2015 Golf, GTI
Replaces: Volkswagen 6K115562, 6L115562
O.D.: 2 1/16 (52.4)
I.D.: 15/16 (23.8)
Height: 4 13/32 (111.9)
O-Ring: [1] Included

P40017

Lube Element



Fits: Mercedes-Benz European Trucks, Vans
Replaces: Mercedes-Benz A9341800009, A9341840225, 9341800009
O.D.: 3 1/2 (89)
I.D.: 1/2 (12.7) & 1 5/8 (41.3)
Height: 6 1/32 (153.2)
A. Gskt: [1] Attached
O-Ring: [1] Included

P40011

Lube Element



Fits: Gehl, Schramm Compressors
Replaces: Schramm COUB2295
O.D.: 3 9/32 (83.3)
I.D.: 1 1/16 (27.0)
Height: 4 1/16 (103.2)
F. Gskt: [1] Included
End Seals: [2] Attached

P40019

Lube Element



Fits: DAF, Kenworth, Peterbilt Trucks
Replaces: DAF 1629393, 1643070; Coopers LEF5207; Donaldson P550812; Fleetguard LF16233
O.D.: 4 7/16 (112.7)
I.D.: 2 (50.8)
Height: 8 11/16 (220.7)
A. Gskt: [2] Attached
F. Gskt: [1] Included

P40012

By-Pass Lube Element with Lift Tab



Fits: Massey-Harris Tractors with Continental Engines
Replaces: Massey Ferguson 760999M1
O.D.: 3 15/16 (100.0)
I.D.: 7/8 (22.2)
Height: 6 3/32 (154.8)
A. Gskt: [2] Attached
F. Gskt: [1] Included

P40020

Lube Element



Fits: Fendt Tractors
Replaces: Deutz 4505597; Fendt F836200510010
O.D.: 3 9/32 (83.3)
I.D.: 3/8 (9.5) & 1 3/8 (34.9)
Height: 5 11/32 (135.7)
O-Ring: [1] Included

B40013

Lube Spin-on



Replaces: Alliance ABPN-10G-P550367
Thread: M36 x 1.5
O.D.: 5 11/32 (135.7)
Height: 12 7/32 (310.4)
I.Gskt: [1] Included

P40021

Lube Element



Fits: Isuzu Engines, Trucks
Replaces: Isuzu 8980188580
O.D.: 2 19/32 (65.9)
I.D.: 7/16 (11.0)
Height: 6 3/16 (157.2)
F. Gskt: [1] Included
O-Ring: [2] Included

B40022-MPG

Maximum Performance Glass Lube Spin-on



Contains: 20 PSID By-Pass Valve
Fits: John Deere Forestry Equipment, Loaders, Industrial Engines
Replaces: John Deere RE67764
Thread: 1 1/2 -16
O.D.: 3 3/4 (95.3)
Height: 8 1/4 (209.6)
F. Gskt: [1] Included

Measurements Are Shown In Inches And (Millimeters)

WARNING: These products can expose you to chemicals, including Diisononyl Phthalate, Carbon black extracts, Nickel, 1,3 Butadiene, Ethylene Oxide, Epichlorohydrin, which are known to the State of California to cause cancer, and Bisphenol, Ethylene Glycol, Ethylene Oxide, 1,3 Butadiene, Epichlorohydrin, which are known to the State of California to cause birth defects or other reproductive harm. For more information go to www.P65Warnings.ca.gov.

P40023

Lube Element



Fits: Mercedes-Benz Automotive
Replaces: Mercedes-Benz 2761800009
O.D.: 2 9/16 (65.1)
I.D.: 7/8 (22.2) & 31/32 (24.6)
Height: 6 9/16 (166.7)
O-Ring: [1] Attached, [1] Included

P40031-MPG

Maximum Performance Glass Lube Element



Fits: Case Harvesters, Loaders, Sprayers, Tractors; Iveco Trucks with Cursor 9, 11, 13 Engines.
Replaces: Case 2996570, 504179764, 84565867; Claas 11429540; Iveco 504179764; New Holland 2996570, 504179764, 84565867
O.D.: 4 13/32 (111.9)
I.D.: 1 1/8 (28.6) One End
Height: 8 13/16 (223.8)
O-Ring: [2] Attached, [1] Included

P40024

Lube Element

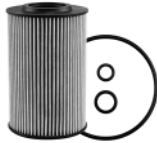

Fits: Volkswagen Passat with 4-1968cc (2.0L) FI Turbo Diesel Engine
Replaces: Volkswagen 3L115562
O.D.: 2 9/16 (65.1)
I.D.: 1 3/32 (27.8)
Height: 3 31/32 (100.8)
O-Ring: [2] Attached, [3] Included

BT40032

Lube Spin-on



Contains: 40 PSID By-Pass Valve
Fits: Yanmar Engines
Replaces: Yanmar 12769535150
Thread: 1 -12
O.D.: 3 11/16 (93.7)
Height: 7 1/8 (181)
I.Gskt: G381-A

P40025

Lube Element



Fits: Jaguar; Land Rover LR4, Range Rover
Replaces: Land Rover LR011279
O.D.: 2 15/16 (74.6)
I.D.: 3/4 (19.1) & 1 (25.4)
Height: 5 13/16 (147.6)
A. Gskt: [1] Included
F. Gskt: [1] Included

P40033

Lube Element



Fits: Ford, Lincoln Automotive, Light-Duty Trucks
Replaces: Motorcraft FL2062
O.D.: 1 15/16 (49.2)
I.D.: 27/32 (21.4)
Height: 5 13/32 (137.3)
A. Gskt: [2] Included
O-Ring: [3] Included

BD40027

Lube Spin-on



Fits: John Deere Dozers, Harvesters, Loaders, Tractors
Replaces: John Deere RE530107, RE557343, RE561823, RE572785; Hifi/Jura Filtration SO10014, SO10094; Mann & Hummel W11011
Thread: M52 x 1.5-6H
O.D.: 4 11/16 (119.1)
Height: 11 25/32 (299.2)
I.Gskt: [1] Included
A. Gskt: [1] Included

BT40034

Lube Spin-on



Contains: Anti-Drainback Valve
 14 PSID By-Pass Valve
Fits: NACCO Material Handling Equipment
Replaces: NACCO Materials Handling 8815414
Thread: M20 x 1.5
O.D.: 2 21/32 (67.5)
Height: 5 1/2 (139.7)
I.Gskt: [1] Included

BT40028

Lube Spin-on



Contains: 14 PSID By-Pass Valve
Fits: Ingersoll-Rand Air Source Plus 185 Compressor w/41RX3T Engine
Replaces: Ingersoll-Rand 22496905
Thread: 3/4 -16
O.D.: 3 11/16 (93.7)
Height: 3 1/4 (82.6)
I.Gskt: G381-A

P40035

Lube Element



Fits: Porsche, Volkswagen Automotive
Replaces: Volkswagen 3H115562; Porsche 95810722210
O.D.: 3 3/16 (81.0)
I.D.: 5/8 (15.9)
Height: 4 11/16 (119.1)
O-Ring: [1] Attached, [1] Included

P40030

Lube Element



Fits: M.T.U. Equipment
Replaces: M.T.U. X57518300024; Fleetguard LF17485
O.D.: 2 13/16 (71.4)
I.D.: 1 1/8 (28.6)
Height: 7 7/8 (200)
O-Ring: [1] Attached, [1] Included

B40036

Lube Spin-on



Fits: Mazda 5, 6, Tribute
Replaces: Mazda LF0514302B
Thread: 3/4 -16
O.D.: 2 29/32 (73.8)
Height: 3 1/2 (88.9)
I.Gskt: [1] Included

Measurements Are Shown In Inches And (Millimeters)

WARNING: These products can expose you to chemicals, including Diisononyl Phthalate, Carbon black extracts, Nickel, 1,3 Butadiene, Ethylene Oxide, Epichlorohydrin, which are known to the State of California to cause cancer, and Bisphenol, Ethylene Glycol, Ethylene Oxide, 1,3 Butadiene, Epichlorohydrin, which are known to the State of California to cause birth defects or other reproductive harm. For more information go to www.P65Warnings.ca.gov.

BT40038 Lube Spin-on
Contains: Anti-DrainBack Valve
 11-17 PSID Bypass Valve
Fits: Case Loaders, Compaction Equipment;
 New Holland Skid Steer Loaders
Replaces: Case 84475542; New Holland
 84475542; Donaldson P551132
Thread: 3/4 -16 UN
O.D.: 3 (76.2)
Height: 3 9/32 (83.3)
I.Gskt: [1] Included



B40050 Lube Spin-on
Fits: Cummins ISF3.8, QSF2.8 Naturally
 Aspirated (Tier 3), QSF2.8 Turbo (Tier 3),
 QSF 2.8 (Tier 4 Final) Engines
Replaces: Cummins 5262313;
 Fleetguard LF16352
Thread: M27 x 2.0
O.D.: 4 (101.6)
Height: 6 7/8 (174.6)
A. Gskt: [1] Included



P40052 Fuel Element
Fits: Isuzu Trucks with 4HK1 (5.2L) Engine
Replaces: General Motors Corp. 98165375;
 Isuzu 8981653750; Fleetguard FS20128
O.D.: 2 9/16 (65.1)
I.D.: 5/8 (15.9) One End
Height: 4 1/16 (103.2)
O-Ring: [1] Attached, [3] Included



B40053 Lube Spin-on
Fits: International MaxxForce 9 and 10
 Engines, DuraStar, TranStar, WorkStar Trucks
Replaces: Navistar 1885920C2, 1885920C1
Thread: 1 5/8 -12 UN
O.D.: 4 5/8 (117.5)
Height: 10 13/32 (264.3)
I.Gskt: [1] Included



B40054 Lube Spin-on
Contains: Anti-Drain Back Valve
 14 PSID By-Pass Valve
Fits: Caterpillar, Mitsubishi Lift Trucks;
 Hyundai Excavators
Replaces: Caterpillar 32B4020100;
 Donaldson P502476; Fleetguard LF17507
Thread: 1 -12 UNS-2B
O.D.: 4 1/4 (108.0)
Height: 5 13/16 (147.6)
A. Gskt: [1] Included



B40056 Lube Spin-on
Contains: 25 PSID By-Pass Valve
Fits: Doosan Compressors
Replaces: Ingersoll-Rand 23279078;
 Fleetguard LF17495
Thread: M27 x 2.0
O.D.: 3 23/32 (94.5)
Height: 5 3/8 (136.5)
A. Gskt: [1] Included



P40058 Lube Element
Fits: Fiat Doblo I 1.3 Multijet 16V JTD (119/223)
 w/75 HP, 85 HP Engines (11/05-on) European
 Light Duty Vehicles
Replaces: Fiat 55197218
O.D.: 2 5/8 (66.7)
I.D.: 1/2 (12.7) One End
Height: 3 15/16 (100)
O-Ring: [2] Attached, [1] Included



P40061 Lube Element
Fits: Volkswagen Beetle, Jetta, Passat, Golf
Replaces: Volkswagen 3N115562
O.D.: 2 9/16 (65.1)
I.D.: 1 1/16 (27) One End
Height: 4 3/32 (104)
O-Ring: [2] Included

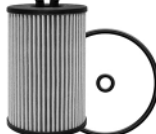

P40062 Lube Element
Fits: New Holland Combines, Forage
 Harvesters, Tractors
Replaces: Case 5801592277; New Holland
 5801592277; Iveco 50054654, 5801592277;
 Donaldson P954658; Fleetguard LF17546
O.D.: 4 13/32 (111.9)
I.D.: 1 9/16 (39.7) One End
Height: 12 5/8 (320.7)
O-Ring: [1] Attached, [1] Included
Related To: P7495



S40071 Foam Lube Element
Fits: Master Portable Heaters;
 Heating-Fuel Storage Tanks
Replaces: General 1A30;
 Kralinator F900; Fram C125RO
O.D.: 2 1/2 (63.5)
Height: 3 25/32 (96.0)
F. Gskt.: [3] Included



BF45000 In-Line Fuel Strainer
Fits: Walker MD Series Mower
Replaces: Walker 7020
O.D.: 2 3/32 (53.2)
Inlet: 1/4
Outlet: 1/4
Length: 3 7/16 (87.3)



BF46000 In-Line Fuel Filter
Contains: [1] Drain Screw
Fits: Freightliner, Mercedes-Benz Sprinter
 Vans
Replaces: Mercedes-Benz A6420920301
O.D.: 3 5/8 (92.1)
Inlet: 1/4
Outlet: 1/4
Length: 4 17/32 (115.1)
O-Ring: [4] Included



BF46001 In-Line Fuel Filter
Notes: This filter used with detachable fuel
 heater.
 Remove heater attachment from old filter
 and install on new filter.
Fits: Mercedes-Benz Automotive
Replaces: Mercedes-Benz 6420920201;
 Mann WK820/2x
O.D.: 3 9/16 (90.5)
Inlet: 5/16 (7.9)
Outlet: 3/8 (9.5)
Length: 4 11/16 (119.1)
O-Ring: [1] Included



Measurements Are Shown In Inches And (Millimeters)

WARNING: These products can expose you to chemicals, including Diisononyl Phthalate, Carbon black extracts, Nickel, 1,3 Butadiene, Ethylene Oxide, Epichlorohydrin, which are known to the State of California to cause cancer, and Bisphenol, Ethylene Glycol, Ethylene Oxide, 1,3 Butadiene, Epichlorohydrin, which are known to the State of California to cause birth defects or other reproductive harm. For more information go to www.P65Warnings.ca.gov.

BF46002

High Efficiency Fuel Spin-on



Fits: Cummins Engines, Marine Engines; Euclid, Hitachi, John Deere, Kawasaki, Komatsu, Terex Equipment, all with Cummins Engines
Replaces: Cummins 2441458
Thread: 2 1/4 -12
O.D.: 4 5/8 (142.9)
Height: 10 (254.0)
I.Gskt: [1] Included
Related To: BF7932 (Standard Version)

PF46003

Fuel Element



Fits: Case, Case-International, New Holland Equipment
Replaces: Case 5801439820
O.D.: 4 1/4 (108.0)
I.D.: 31/32 (24.6)
Height: 6 11/32 (161.1)
O-Ring: [1] Included

PF46004

Fuel Element



Fits: Ford Transit Vehicles
Replaces: Ford 1837319, CC1Z-9354-A, CC119176BB; Motorcraft FD4621
O.D.: 3 11/16 (93.7)
 Flange 4 29/32 (124.6)
I.D.: 5/8 (7.9) & 1 9/16 (39.7)
Height: 5 9/32 (134.1)
O-Ring: [2] Attached, [1] Included

BF46005

In-Line Fuel Filter



Contains: Mounting Bracket
Fits: Caterpillar, Mitsubishi Lift Trucks
Replaces: Caterpillar 9126406100
O.D.: 1 13/16 (46.0)
Inlet: M14 x 1.5
Outlet: M14 x 1.5
Length: 3 7/16 (87.3)

BF46006

In-Line Diesel Fuel Filter



Fits: Freightliner Trucks
Replaces: Ford 4C4Z-9155-AA
O.D.: 1 7/8 (47.6)
Length: 4 31/32 (126.2)

BF46007

In-Line Fuel Strainer



Fits: 1992-2004 AM General, Chevrolet, GMC Trucks with V8-6.5L Engine
Replaces: General Motors 12339208
O.D.: 1 (25.4)
Inlet: 1/4
Outlet: 1/4
Length: 3 (76.2)

BF46008

In-Line Fuel Filter



Fits: Kohler Generators
Replaces: Kohler 267987
O.D.: 1 7/32 (31.0)
Inlet: 1/4-18 NPT
Outlet: 1/8-27 NPT
Length: 2 15/32 (62.7)

PF46009

Fuel Element



Fits: Kool-Gen Auxiliary Power Units
Replaces: Racor R11T
O.D.: 2 3/8 (60.3)
I.D.: 5/8 (15.9) & 11/16 (17.5)
Height: 2 5/8 (66.7)
F. Gskt: [1] Included
O-Ring: [1] Included

PF46010 KIT

Set of 2 Fuel Elements



Notes: NOTES: Larger filter is a coalescer smaller filter is a Fuel/Water Separator
Fits: Marine Engines
Replaces: Racor RK22610; Donaldson P551061, Carquest 96075; Fleetguard FS1107, Wix WF10075, HiFiJura YRK22610
Coalescer
O.D.: 4 (101.6)
I.D.: 13/16 (20.6) & 1 3/16 (30.2)
Height: 11 5/8 (295.3)
F. Gskt: [1] Included
O-Ring: [1] Included
Grommets: [2] Attached to Each Filter
Fuel/Water Separator
O.D.: 4
I.D.: 5/8 & 13/16
Height: 9 11/16

BF46012

Fuel/Water Separator Spin-on



Fits: Davco 210 Fuel Processor
Replaces: Donaldson P550783; Wix 33998
Thread: M16 x 1.5
O.D.: 3 3/16 (81.0)
Height: 6 15/16 (176.2)
I.Gskt: [1] Included
F. Gskt: [1] Included

BF46013

Fuel Spin-on



Notes: Fuel Dispensing Filter for Fuel Pumps (specifically for ethanol blended fuels up to E85)
Replaces: CIM-TEK 70052, 70120
Thread: 1 1/2 -16
O.D.: 3 3/4 (95.3)
Height: 4 13/32 (137.7)
I.Gskt: [1] Included

BF46014

Primary Fuel Spin-on



Notes: CAUTION: Furnished O-Ring must be installed on post for seal.
Fits: Davco 210 Fuel Processor
Replaces: Donaldson P550782
Thread: M16 x 1.5
O.D.: 3 3/16 (81.0)
Height: 6 15/16 (176.2)
I.Gskt: [1] Included
F. Gskt: [1] Included

BF46015

Fuel/Water Separator Spin-on with Drain



Fits: Eagle Tow Tractors with Yanmar 4TNV98 Engine
Replaces: Fleetguard FS20000
Thread: 1 1/8 -16
O.D.: 3 11/16 (93.7)
Height: 9 13/16 (249.2)
I.Gskt: [1] Included
F. Gskt: [1] Included

Measurements Are Shown In Inches And (Millimeters)

WARNING: These products can expose you to chemicals, including Diisononyl Phthalate, Carbon black extracts, Nickel, 1,3 Butadiene, Ethylene Oxide, Epichlorohydrin, which are known to the State of California to cause cancer, and Bisphenol, Ethylene Glycol, Ethylene Oxide, 1,3 Butadiene, Epichlorohydrin, which are known to the State of California to cause birth defects or other reproductive harm. For more information go to www.P65Warnings.ca.gov.

BF46016-O Fuel/Water Separator Spin-on with Open Port for Bowl



Contains: Port Thread: 3 3/4-10 Buttress Integral Post Seal
Fits: Freightliner Trucks; Racor Fuel Systems
Replaces: Freightliner ABPN122R50551
Thread: 1 -14
O.D.: 4 11/32 (110.3)
Height: 6 1/8 (155.6)
F. Gskt: [2] Included

BF46022-O Fuel/Water Separator Spin-on with Open Port for Bowl



Contains: Port Thread: 3 1/8-10 UN 1B
Fits: Racor 230R Assembly
Replaces: Racor R20T
Thread: 1 -14
O.D.: 3 11/16 (93.7)
Height: 4 1/32 (102.4)
F. Gskt: [1] Included
O-Ring: [1] Included
Related To: BF9922-O, BF46021-O (Micron Difference)

BF46017-O Fuel/Water Separator Spin-on with Open Port for Bowl



Contains: Port Thread: 3 1/8-10 UN 1B
Fits: Bobcat Compressors; Doosan G20 Portable Generators; Ingersoll-Rand Compressors
Replaces: Ingersoll-Rand 54525530
Thread: 1 -12
O.D.: 3 25/32 (96.0)
Height: 3 1/4 (82.6)
F. Gskt: [1] Included
O-Ring: [1] Included

BF46023-O Fuel/Water Separator Spin-on with Open Port for Bowl



Contains: Port Thread: 1 1/4-10
Fits: Racor 220R Assemblies (Old Version)
Replaces: Racor R24P
Thread: 1 -14
O.D.: 3 3/4 (95.3)
Height: 3 9/16 (90.5)
F. Gskt: [1] Included
O-Ring: [1] Included

BF46018-O Fuel/Water Separator Spin-on with Open Port for Bowl



Contains: Port Thread: 3 3/4-10UNS-2B Integral Post Seal
Fits: International, Navistar Trucks with Maxxforce Engine
Replaces: International 2602549C1
Thread: 1 -14
O.D.: 4 1/4 (108.8)
Height: 8 17/32 (216.7)
F. Gskt: [2] Included
Related To: BF1281 (Drain Version)

BF46024-O Fuel/Water Separator Spin-on with Open Port for Bowl



Contains: Port Thread: 1 1/4-10
Fits: Used in Model 220RMAM Filter Assembly
Replaces: Racor R24T
Thread: 1 -14
O.D.: 3 3/4 (95.3)
Height: 3 9/16 (90.5)
F. Gskt: [1] Included
O-Ring: [1] Included

BF46019-O Fuel/Water Separator Spin-on with Open Port for Bowl



Contains: Port Thread: 3 1/8-10 UN 1B
Fits: Racor 215R Fuel Assembly
Replaces: Racor R15S
Thread: 1 -14
O.D.: 3 13/16 (96.8)
Height: 3 9/32 (83.3)
F. Gskt: [1] Included
O-Ring: [1] Included

BF46025-O Fuel/Water Separator Spin-on with Open Port for Bowl



Contains: Port Thread: 3 1/8-10UN-1B
Fits: Racor R245R Fuel Assembly
Replaces: Racor R25T
Thread: 1 -14
O.D.: 3 3/4 (95.3)
Height: 5 17/32 (140.5)
F. Gskt: [1] Included
O-Ring: [1] Included

BF46020-O Fuel/Water Separator Spin-on with Open Port for Bowl



Contains: Port Thread: 3 1/8-10 UN-1B
Fits: Racor 215R Assemblies
Replaces: Racor R15T
Thread: 1 -14
O.D.: 3 13/16 (96.8)
Height: 3 9/32 (83.3)
I.Gskt: [1] Included
O-Ring: [1] Included

BF46026-O Fuel/Water Separator Spin-on with Open Port for Bowl



Contains: Port Thread: 1 1/4-10
Fits: Racor 225 Series
Replaces: Racor R26T; Donaldson P550088; Fleetguard FS1234
Thread: 1 -14
O.D.: 3 3/4 (95.3)
Height: 4 21/32 (118.3)
F. Gskt: [1] Included
O-Ring: [1] Included

BF46021-O Fuel/Water Separator Spin-on with Open Port for Bowl



Contains: Port Thread: 3 1/8-10 UN 1B
Fits: Racor 230R Fuel Assembly Series
Replaces: Racor R20S
Thread: 1 -14
O.D.: 3 11/16 (93.7)
Height: 4 1/16 (103.2)
F. Gskt: [1] Included
O-Ring: [1] Included
Related To: BF9922-O, BF46022-O (Micron Difference)

BF46027-O Fuel/Water Separator Spin-on with Open Port for Bowl



Contains: Port Thread: 3 3/4-10 ANS Buttress Integral Post Seal
Fits: Used in Racor 400, 600 Series Filter Assemblies
Replaces: Racor R45S
Thread: 1 -14
O.D.: 4 3/8 (111.1)
Height: 3 1/2 (88.9)
F. Gskt: [2] Included

Measurements Are Shown In Inches And (Millimeters)

WARNING: These products can expose you to chemicals, including Diisononyl Phthalate, Carbon black extracts, Nickel, 1,3 Butadiene, Ethylene Oxide, Epichlorohydrin, which are known to the State of California to cause cancer, and Bisphenol, Ethylene Glycol, Ethylene Oxide, 1,3 Butadiene, Epichlorohydrin, which are known to the State of California to cause birth defects or other reproductive harm. For more information go to www.P65Warnings.ca.gov.

BF46028-O Fuel/Water Separator Spin-on with Open Port for Bowl



Contains: Port Thread: 3 1/8-10UN-1B
Fits: Racor 320R-RAC-02 Mounting Base; Marine Engines
Replaces: Racor S3227
Thread: 1 -14
O.D.: 4 (108.0)
Height: 4 1/16 (103.2)
F. Gskt: [1] Included
O-Ring: [1] Included

BF46034 Fuel Spin-on



Fits: Volvo Dump Trucks, Excavators, Loaders
Replaces: Volvo 15126069; 21879886
Thread: M32 x 1.5
O.D.: 4 1/4 (108.8)
Height: 10 15/32 (265.9)
I.Gskt: [1] Included

BF46029-O Fuel/Water Separator Spin-on with Open Port for Bowl



Contains: Port Thread: 3 1/4-10 Integral Post Seal
Fits: Racor Marine Applications
Replaces: Racor S3228UL
Thread: 1 -14
O.D.: 3 25/32 (96.0)
Height: 4 1/32 (102.4)
F. Gskt: [1] Included
O-Ring: [1] Included

BF46037 In-Line Fuel Filter with Plastic Connector



Fits: Mercedes-Benz Vito
Replaces: Mercedes-Benz A6510903152
O.D.: 3 17/32 (89.7)
Inlet: 3/8
Outlet: 5/16
Length: 4 27/32 (123.0)

BF46030-O Fuel/Water Separator Spin-on with Open Port for Bowl



Contains: Port Thread: 3 3/4-10 UN-1B
Fits: Used in Racor 660R-RAC, 3120R-RAC Series Assemblies
Replaces: Racor S3232
Thread: 1 -14
O.D.: 3 25/32 (96.0)
Height: 5 1/2 (139.7)
F. Gskt: [2] Included
O-Ring: [1] Included
Related To: BF1350-SP (Sensor Port Version)

BF46038-D Primary Fuel/Water Separator Element with Drain



Fits: Linde Lift Trucks
Replaces: CEMS 42123; Linde 9839030
O.D.: 3 9/32 (83.3)
Height: 7 5/32 (181.8)
Grommets: [1] Attached

BF46031 Fuel/Water Separator Spin-on with Open Port



Contains: Port Thread: M36 x 1.5
Fits: 2013 RAM Pickups with 6-408 (6.7L) FI Turbo Diesel Engine
Replaces: Chrysler 68197867AA
Thread: 1 -14
O.D.: 4 1/4 (108.0)
Height: 5 1/2 (139.7)
F. Gskt: [1] Included
O-Ring: [1] Included

BF46039-D Primary Fuel/Water Separator Element with Drain



Fits: Caterpillar Loaders
Replaces: Caterpillar 3619554
O.D.: 3 15/32 (88.1)
I.D.: 3/4 (19.1) One End
Height: 7 3/4 (196.9)
Grommets: [1] Attached

BF46032 Fuel Spin-on



Replaces: Mann & Hummel WK962/7
Thread: M18 x 1.5
O.D.: 3 11/16 (93.7)
Height: 8 9/32 (210.3)
I.Gskt: [1] Included

BF46040-D Secondary Fuel/Water Separator Element with Drain



Fits: Ingersoll-Rand Air Source Plus 185 Compressor with IRX3T Engine
Replaces: Ingersoll-Rand 22532378; Stanadyne 40232
O.D.: 3 1/8 (79.4)
I.D.: 3/4 (19.1)
Height: 5 13/32 (137.3)
Grommets: [1] Attached

PF46033 Fuel Element



Fits: Davco Fuel Systems
Replaces: Davco 230029
O.D.: 3 15/32 (88.1)
I.D.: 21/32 (16.7) One End
Height: 4 5/16 (109.5)
O-Ring: [2] Included
Grommets: [1] Attached

BF46041-D Primary Fuel/Water Separator Element with Drain



Fits: Allmand Brothers Generators, Equipment
Replaces: CEMS 45658; Allmand Brothers 45658P
O.D.: 3 15/32 (88.1)
I.D.: 7/8 (22.2) One End
Height: 7 13/16 (198.4)
Grommets: [1] Attached

Measurements Are Shown In Inches And (Millimeters)

WARNING: These products can expose you to chemicals, including Diisononyl Phthalate, Carbon black extracts, Nickel, 1,3 Butadiene, Ethylene Oxide, Epichlorohydrin, which are known to the State of California to cause cancer, and Bisphenol, Ethylene Glycol, Ethylene Oxide, 1,3 Butadiene, Epichlorohydrin, which are known to the State of California to cause birth defects or other reproductive harm. For more information go to www.P65Warnings.ca.gov.

BF46042-D

Primary Fuel/Water Separator Element with Drain



Fits: Deutz-Fahr TTV7.260 Tractor with Deutz TCD (6.1L) Engine (Interim Tier 4)
Replaces: Deutz 90005119, 243193000; Donaldson P564430; Doosan 46492252
O.D.: 4 7/32 (107.2)
I.D.: 1 1/4 (31.8) One End
Height: 10 1/4 (260.4)
Grommets: [1] Attached

BF46043-D

Primary Fuel/Water Separator Element with Drain



Fits: Volvo Industrial Engines
Replaces: Volvo 22116209; Stanadyne 43592
O.D.: 4 7/32 (107.2)
I.D.: 1 1/4 (31.8) One End
Height: 10 1/4 (260.4)
Grommets: [1] Attached

BF46044-D

Primary Fuel/Water Separator Element with Drain



Fits: Deutz, Fahr, Same Tractors
Replaces: SDF 90020434
O.D.: 3 1/8 (79.4)
I.D.: 15/16 (23.8) One End
Height: 7 25/32 (197.6)
Grommets: [1] Attached

BF46045-D

Primary Fuel/Water Separator Element with Drain



Fits: John Deere Tractors
Replaces: John Deere RE536195, RE546336, RE548534
O.D.: 3 1/8 (79.4)
I.D.: 7/8 (22.2) One End
Height: 6 1/8 (155.3)
Grommets: [1] Attached

PF46046

Fuel Element



Fits: Deutz Engines
Replaces: Deutz 2931748, 4291525; Fleetguard FF5769; Filtration SN70296
O.D.: 3 3/4 (95.3)
I.D.: 1 25/32 (43.7)
Height: 6 7/16 (163.5)
O-Ring: [1] Attached, [1] Included

BF46048

Fuel/Water Separator Spin-on with Drain, Sensor Port and Reusable Sensor



Fits: Hyster H50FT Lift Trucks with Cummins QSB 3.3L, Ammann AV85-2 Rollers with Cummins 4BT 3.3-C85 Diesel Engines
Replaces: Cummins 4992119; Fleetguard FS19902
Thread: M24 x 1.5
O.D.: 3 11/16 (93.7)
Height: 6 7/8 (174.6)

PF46049

Fuel/Water Separator Element



Fits: Caterpillar Excavators, Generators, Loaders
Replaces: Caterpillar 3635819
O.D.: 2 27/32 (72.2)
I.D.: 1 1/32 (26.2) One End
Height: 5 1/2 (140)
F. Gskt: [1] Included
O-Ring: [1] Attached; [1] Included

BF46050

Fuel Pre-Filter Spin-on with Sensor Port



Fits: Genie S-Boom, Scissors and Telehandlers
Replaces: Genie 236260; Bomag 8820065; Caterpillar 4664177; Claas 19951210; Deutz 4130241, 4130650; JLG Industries 70025153
Thread: M16 x 1.5
O.D.: 3 23/32 (94.5)
Height: 7 9/32 (183.4)
I.Gskt: G381-A

BF46051

In-Line Fuel Filter



Contains: [2] Plastic Caps
Plastic Drain
Fits: Fiat Doblo II, Fiorino, Qubo, Strada Light-Duty Vehicles
Replaces: Fiat 77363657; Hengst H340WK; Mahle KL567; Mann & Hummel WK853/21
O.D.: 3 1/2 (88.9)
Length: 8 1/16 (204.8)
F. Gskt: [1] Included

BF46052

In-Line Fuel Filter



Contains: [2] Plastic Caps
Plastic Drain
Fits: Fiat, Ford Light-Duty Vehicles
Replaces: Fiat 77363804; Ford 1578143, 1542785, 9S518N169BA; Hengst H303WK; Mahle KL566; Mann & Hummel WK853/20
O.D.: 3 1/2 (88.9)
Length: 8 1/16 (204.8)
F. Gskt: [1] Included

PF46056

Fuel Element



Fits: Multiquip generators and other equipment with Isuzu 4LE2T, 4LE2X Engines
Replaces: Isuzu 8982402790; Wacker 5200017728
O.D.: 3 (76.2)
I.D.: 13/16 (20.6) One End
Height: 5 19/32 (142.1)
O-Ring: [2] Included
Grommets: [1] Attached

PF46057

Fuel Element



Fits: Multiquip generators and other equipment with Isuzu 4LE2T, 4LE2X Engines
Replaces: Isuzu 8982402800; Wacker 5200017727
O.D.: 3 (76.2)
I.D.: 13/16 (20.6) One End
Height: 4 5/16 (109.5)
O-Ring: [2] Included
Grommets: [1] Attached

Measurements Are Shown In Inches And (Millimeters)

WARNING: These products can expose you to chemicals, including Diisononyl Phthalate, Carbon black extracts, Nickel, 1,3 Butadiene, Ethylene Oxide, Epichlorohydrin, which are known to the State of California to cause cancer, and Bisphenol, Ethylene Glycol, Ethylene Oxide, 1,3 Butadiene, Epichlorohydrin, which are known to the State of California to cause birth defects or other reproductive harm. For more information go to www.P65Warnings.ca.gov.

BF46062



Fuel/Water Separator Spin-on with Open Port
Fits: 2012-16 Chevrolet Express Vans, GMC Savana Vans; 2001-16 Silverado Pickups, GMC Sierra Pickups; 2001-03 Chevrolet Suburban w/V8 6.6L Turbo Diesel Eng.
Replaces: ACDelco TP3018
Thread: 3 3/8 -8
O.D.: 4 1/32 (102.4)
Length: 6 3/8 (161.9)
O-Ring: [2] Included
Grommets: [1] Attached
Related To: BF9882 (Standard Version)

BF46065-SPS



Fuel/Water Separator Spin-on with Drain, Sensor Port and Reusable Sensor
Notes: CAUTION:Furnished Gasket must be installed on post for seal.
Contains: Sensor Port Thread M14 x 2 Integral Post Seal
Fits: Volvo Compactors, Paving Equipment; Ingersoll-Rand PF6110 Paver
Replaces: Volvo 43919935, 43802263; Fleetguard FS19732; Hifi/Jura Filtration SN909030; Napa Gold 3732; Wix 33732
Thread: 1 -14 UNS-B
O.D.: 3 21/32 (92.9)
Height: 8 3/8 (212.7)
I.Gskt: [1] Included
F. Gskt: [1] Included

BF46071



Fuel/Water Separator with Bowl and Drain
Fits: Mercedes-Benz Trucks
Replaces: Mann & Hummel WK1060; Donaldson P551086, P551360; Fleetguard FS20041
Thread: 1 -12
O.D.: 4 1/32 (102.4)
Height: 11 (279.4)
I.Gskt: [1] Included

BF46072



Fuel/Water Separator with Bowl and Drain
Fits: Volvo Construction Equipment
Replaces: Mann & Hummel WK1060/1; Donaldson P502457, P551067, P551361
Thread: 1 -14
O.D.: 4 1/32 (102.4)
Height: 11 (279.4)
I.Gskt: [1] Included
Related To: BF46083-O (Open Port Version) BF1339-SP (SP Thd. 1/2-20) BF1329-SP (SP Thd. 9/16-18) BF1329 (Drain Version)

PF46077



Fuel Element
Fits: Kubota Excavators, Tractors
Replaces: Kubota 1583143380; Fleetguard FF5468
O.D.: 1 3/8 (34.9)
I.D.: 7/16 (11.1) One End
Height: 2 25/32 (70.6)
O-Ring: [1] Attached

BF46078-D



Primary Fuel Element with Drain and Tab Keys
Fits: Ingersoll-Rand Compressors
Replaces: Ingersoll-Rand 22926737
O.D.: 3 1/8 (79.4)
Height: 5 9/32 (134.1)
Grommets: [1] Attached

BF46083-O



Fuel/Water Separator with Open Port
Contains: Port Thread: 3 3/4-10 Buttress Integral Post Seal
Fits: Scania Trucks; Doosan Dump Trucks; JCB (J.C. Bamford) Generators
Replaces: Scania 1393640
Thread: 1 -14
O.D.: 4 1/2 (108)
Height: 6 3/16 (157.2)
F. Gskt: [2] Included
Related To: BF46072 (Bowl Version) BF1329 (Drain Version) BF1339-SP (SP Thd. 1/2-20) BF1329-SP (SP Thd. 9/16-18)

BF46084



In-Line Fuel Filter
Fits: Caterpillar Equipment
Replaces: Caterpillar 3848512; Perkins T412017
O.D.: 2 5/32 (54.8)
Inlet: 11/16
Outlet: 9/32
Length: 5 5/8 (142.9)

BF46085



Fuel Spin-on
Fits: John Deere Dozers; Liebherr Equipment
Replaces: John Deere LW10429946; Liebherr 10044303; Yanmar 12065155020; Fleetguard FF5856
Thread: 1 -14
O.D.: 4 1/4 (108)
Height: 5 25/32 (197.6)
I.Gskt: [1] Included

BF46087



Box-Style Fuel Element with Handle
Fits: M.T.U. Engines
Replaces: M.T.U. 0000925105, 925105; Separ 4030; Fleetguard FS19803
Length: 7 7/32 (183.4)
Width: 7 1/4 (184.2)
Height: 2 5/32 (54.8)

PF46088



Fuel Element
Fits: Toyota, Isuzu Applications
Replaces: Toyota 1860400021, 2330087317, 233900L010, 233900L020, 233900L030, 233900L041; Isuzu 8981596930
O.D.: 3 5/16 (84.1)
I.D.: 11/32 (8.7)
Height: 3 1/32 (77)
A. Gskt: [1] Included
O-Ring: [1] Attached, [1] Included

PF46092



Fuel/Water Separator Element
Fits: International LoneStar Trucks
Replaces: Davco 382134; Fleetguard FS19905G
O.D.: 4 7/32 (107.2)
I.D.: 21/32 (16.7) One End
Height: 7 1/32 (178.6)
O-Ring: [2] Included

Measurements Are Shown In Inches And (Millimeters)

! **WARNING:** These products can expose you to chemicals, including Diisononyl Phthalate, Carbon black extracts, Nickel, 1,3 Butadiene, Ethylene Oxide, Epichlorohydrin, which are known to the State of California to cause cancer, and Bisphenol, Ethylene Glycol, Ethylene Oxide, 1,3 Butadiene, Epichlorohydrin, which are known to the State of California to cause birth defects or other reproductive harm. For more information go to www.P65Warnings.ca.gov.

BF46098-O Fuel/Water Separator Spin-on with Open Port
Contains: Port Thread: 3 3/4-10 UNS B Integral Post Seal
Fits: Freightliner Century Class, Cargo FC80, Cascadia Trucks
Replaces: Alliance ABP/N122-R50419; ACDelco TP1348; Donaldson P551034, P551857; Fleetguard FS19798
Thread: 1 -14
O.D.: 4 1/4 (108.0)
Height: 6 9/32 (159.5)
F. Gskt: [2] Included
Grommets: [1] Attached
Related To: BF1373-SP (Sensor Port Version)



BF46099-O Fuel/Water Separator Spin-on with Open Port
Contains: Port Thread: 3 3/4-10 UNS 2B Integral Post Seal
Fits: John Deere Equipment
Replaces: John Deere AT365869; Racor R51401; Donaldson P551858; Fleetguard FS19754; Wix 33986
Thread: 1 -14
O.D.: 4 1/4 (108)
Height: 8 19/32 (218.3)
F. Gskt: [2] Included
Grommets: [1] Attached



BF46100-O Fuel/Water Separator with Open Port for Bowl
Contains: Port Thread: 3 3/4-10 UNS B Integral Post Seal
Fits: John Deere Equipment
Replaces: John Deere AT365870; Racor R51402; Donaldson P551034; Fleetguard FS19538;
Thread: 1 -14
O.D.: 4 1/4 (108.0)
Height: 6 7/32 (158)
F. Gskt: [2] Included



BF46101-O Fuel/Water Separator with Open Port for Bowl
Fits: Volvo-Penta Marine Diesel Engines
Replaces: Volvo 3817517; Racor R120S-HD; Fleetguard FS19896
Thread: 1 -12
O.D.: 8 1/2 (216.0)
Height: 8 1/2 (216.0)
F. Gskt: [2] Included



PF46103 Fuel Strainer
Fits: John Deere Harvesters, Tractors
Replaces: John Deere CQ29104; Hifi/Jura Filtration MO7013
O.D.: 2 3/16 (55.6)
I.D.: 1 25/32 (45.2) One End
Height: 7 13/16 (198.4)



BF46105-O Fuel/Water Separator with Open Port for Bowl
Fits: Mercedes-Benz European, South American Trucks
Replaces: Mercedes-Benz A0004771702, 4771702; Racor R160P, R90DMER03; Fleetguard FS19737
Thread: 1 -14 UNS
O.D.: 4 11/32 (110.3)
Height: 8 1/2 (216.0)
F. Gskt: [2] Included



BF46111 Fuel Spin-on
Fits: Bobcat, Doosan Compressors; Case Loaders; Hino Buses; Yanmar Marine Engines
Replaces: Ingersoll-Rand 22226369; Donaldson P550127; Fleetguard FF253, FF5147
Thread: M20 x 1.5
O.D.: 3 11/16 (93.7)
Height: 3 1/4 (82.6)
A. Gskt: [1] Included



PF46112 Fuel Element
Fits: Nissan, Opel, Renault European Light Duty Vehicles
Replaces: Opel 4412830; Nissan 1640500QAC; Renault 7701475229
O.D.: 2 3/4 (69.9)
I.D.: 13/16 (20.6)
Height: 3 3/8 (85.7)
F. Gskt: [2] Included



BF46113-D Fuel/Water Separator Element with Drain
Fits: Gehl Loaders
Replaces: Bobcat 103761801CC; Atlas Copco1310072275; Case CLC103761801; Club Car 103761801; Gehl 245005; Wix SF10147, WF10147
O.D.: 3 15/32 (88.1)
I.D.: 23/32 (18.3)
Height: 4 15/32 (113.5)



BF46117 Fuel Spin-on
Fits: Mack, Volvo Trucks
Replaces: Volvo 22474709, 22094967; Racor RS250RCR01
Thread: M32 x 1.5
O.D.: 4 11/32 (110.3)
Height: 8 7/8 (225.4)
A. Gskt: [1] Included
F. Gskt: [1] Included



PF46119 Fuel Strainer
Fits: John Deere Harvesters, Tractors
Replaces: John Deere AH165504
O.D.: 7/8 (22.2)
I.D.: 9/16 (14.3) One End
Height: 5 19/32 (142.1)



BF46122 Fuel/Water Separator with Drain
Fits: Various Excavators, Sprayers, Telehandlers & Tractors with Deutz Engines
Replaces: Deutz 4504438; Racor R60THB1; Fleetguard FS1095
Thread: 1 -14
O.D.: 4 13/32 (111.9)
Height: 7 1/4 (184.2)
A. Gskt: [1] Included



BF46125 Box-Style Fuel Element with Handle
Fits: Fendt Tractors
Replaces: Fendt F916200060010; Fleetguard FS19733
Length: 3 (76.2)
Width: 3 (76.2)
Height: 1 (25.4)



Measurements Are Shown In Inches And (Millimeters)

WARNING: These products can expose you to chemicals, including Diisononyl Phthalate, Carbon black extracts, Nickel, 1,3 Butadiene, Ethylene Oxide, Epichlorohydrin, which are known to the State of California to cause cancer, and Bisphenol, Ethylene Glycol, Ethylene Oxide, 1,3 Butadiene, Epichlorohydrin, which are known to the State of California to cause birth defects or other reproductive harm. For more information go to www.P65Warnings.ca.gov.

BF46127

Fuel Spin-on



Fits: Bomag Paving Equipment; Kramer Loaders, Telehandlers; JLG Industries Equipment with Deutz Engines
Replaces: Bomag 08820969, 8820969; Caterpillar 4406212; Deutz 214228, 4131531, 4131532, 4132775, 4132776; Genie 214228; JLG Industries 70025161; Wirtgen 2319002
Thread: M18 x 1.5
O.D.: 3 25/32 (96.0)
Height: 5 13/16 (147.6)
A. Gskt: [1] Included

BF46129

Fuel Spin-on



Notes: Fill Plug pre-installed in filter. Remove after pre-filling filter with fuel prior to installation on application.
Fits: Freightliner; Kenworth; Peterbilt; Volvo Trucks with Cummins ISX11.9, ISX15.0, QSX11.9, X15 Engines
Replaces: Cummins 5365988; Fleetguard FF5825NN; Donaldson DBF6776
Thread: M90 x 2.0
O.D.: 4 23/32 (119.9)
Height: 8 27/32 (224.6)
A. Gskt: [1] Included
O-Ring: [1] Attached
Related To: BF9885 (Standard Version)

PF46130

Fuel Element



Fits: RAM 1500 Pickups with V6-182 (3.0L) FI Turbo Diesel Engines
Replaces: Chrysler 68235275AA
O.D.: 2 21/32 (67.5)
 2 29/32 (73.8)
I.D.: 21/32 (16.7)
Height: 5 11/32 (135.7)
O-Ring: [1] Included

BF46147-O

Fuel/Water Separator with Open Port for Bowl



Contains: Port Thread 3 3/4-10 ANS Buttress
Fits: Freightliner FS-65 Buses; Ingersoll-Rand Equipment
Replaces: Case 84211170; Racor R60P; Volvo 13224043, 13224043V; Ingersoll-Rand 13224043, 13224043IR
Thread: 1 -14 UNS-2B
O.D.: 4 1/4 (108)
Height: 5 3/32 (129.4)
F. Gskt: [2] Included
Related To: BF1329 (Drain Version)
 BF1329-SP (SP Thd. 9/16-18)
 BF1339-SP (SP Thd. 1/2-20)

BD50000

High Efficiency Dual-Flow Lube Spin-on



Fits: Belaz Construction Equipment with Cummins QST30 Engine; Cummins ISX15 Engines
Replaces: Cummins 4367100; Donaldson P559000; Fleetguard LF14000NN
Thread: M95 x 2.5-6H
O.D.: 4 11/16 (119.1)
Height: 11 25/32 (299.2)
I.Gskt: [1] Included
Related To: BD7154 (Standard Version)

OAS98000

Oil/Air Separator Spin-on



Fits: DAF Trucks
Replaces: Cummins 4931691; DAF 1686587
Thread: M16 x 1.5
O.D.: 3 (76.2)
Height: 4 29/32 (124.6)
I.Gskt: [1] Included

OAS98001

Oil/Air Separator Element



Fits: Ingersoll-Rand Compressors
Replaces: Ingersoll-Rand 36845303
O.D.: 5 3/4 (146.1)
 Flange 7 3/16 (182.6)
I.D.: 3 5/16 (84.1) One End
Height: 11 11/16 (296.9)

OAS98002

Oil/Air Separator Element



Notes: CAUTION: Do not remove staples from gaskets. These staples provide electrical grounding continuity between defogger and tank.
Fits: Sullair LS10-25L,H,HH,XH, LS10-30L,H,HH,XH, LS10B-25ACAC Compressors
Replaces: Sullair 250034112, 250034143
O.D.: 6 23/32 (170.7)
 Flange 7 7/8 (200.2)
I.D.: 3 3/8 (85.7) One End
Height: 6 13/16 (173.0)
A. Gskt: [2] Attached

OAS98003

Oil/Air Separator Element



Notes: CAUTION: Do not remove staples from gaskets. These staples provide electrical grounding continuity between defogger and tank.
Fits: Sullair 260, DPQ260 w/Cat C3.4 Engine
Replaces: Sullair 2250078031, 410333, 250034155, 2250078029, 250034153
O.D.: 6 23/32 (170.7)
 Flange 7 7/8 (200.2)
I.D.: 3 13/16 (96.8) One End
Height: 8 11/32 (211.9)
A. Gskt: [1] Attached

OAS98004

Oil/Air Separator Element



Fits: Ingersoll-Rand SSR EP30U, SSR EP40U Compressors
Replaces: Ingersoll-Rand 42361204, 39858691, 39627666
O.D.: 6 23/32 (170.7)
I.D.: 4 (101.6) One End
Height: 11 5/16 (287.3)
A. Gskt: [1] Attached
F. Gskt: [2] Included

Measurements Are Shown In Inches And (Millimeters)

WARNING: These products can expose you to chemicals, including Diisononyl Phthalate, Carbon black extracts, Nickel, 1,3 Butadiene, Ethylene Oxide, Epichlorohydrin, which are known to the State of California to cause cancer, and Bisphenol, Ethylene Glycol, Ethylene Oxide, 1,3 Butadiene, Epichlorohydrin, which are known to the State of California to cause birth defects or other reproductive harm. For more information go to www.P65Warnings.ca.gov.

OAS98005

Oil/Air Separator Element



Fits: LeRoi Compressors
Replaces: LeRoi 431103, 438891, 431022
O.D.: 5 3/4 (146.1)
 Flange 7 15/32 (189.7)
I.D.: 3 5/16 (84.1) One End
Height: 8 1/8 (206.4)
A. Gskt: [2] Attached

OAS98010

Oil/Air Separator Element



Fits: Sullair LS12-60, LS16E100, LS16-24KT-60, LS16-24KT-75, LS16-60, LS16-75, ACAC, LS16-75L, H, HH, XH, LS16B8-75WCAC, LS16SRF-60, LS16SRF-75, LS20-24KT-100, LS20S Compressors
Replaces: Sullair 250034116, 408167005; Fleetguard AS2356
O.D.: 8 3/8 (212.7)
 Flange 10 3/4 (273.1)
I.D.: 5 1/4 (133.4) One End
Height: 16 3/32 (408.8)
A. Gskt: [1] Attached

OAS98006

Oil/Air Separator Spin-on



Fits: Gardner Denver Compressors
Replaces: Gardner Denver 2116717, 55B57, 2118414
Thread: 1 1/4 -11 BSP
O.D.: 5 17/32 (140.5)
Height: 10 7/8 (276.2)
I.Gskt: [1] Included

OAS98011

Oil/Air Separator Element



Fits: Atlas Copco GA11 III, GA11 IV, GA15 III, GA15 IV, GA18 III, GA18 IV, GA22 III, GA22 IV, GA30C III, GA30C IV Compressors
Replaces: Atlas Copco 2901077900; Fleetguard AS2502
O.D.: 5 3/16 (131.8)
 Flange 7 15/16 (201.6)
I.D.: 2 27/32 (72.2) One End
Height: 5 9/16 (141.3)
A. Gskt: [1] Attached
F. Gskt: [2] Included

OAS98007

Oil/Air Separator Element



Fits: Atlas Copco GA30 III, GA30 IV, GA37 III, GA37 IV, GA45 III Compressors, Chicago Pneumatic S-15/40H, HH, L, M, S-15/50H, HH, L, M, S15/60H, HH, L, M Compressors
Replaces: Atlas Copco 2901056602, 16138397, 29010566
O.D.: 6 5/8 (168.3)
 Flange 11 3/4 (298.5)
I.D.: 4 7/32 (107.2) One End
Height: 7 (177.8)
O-Ring: [2] Included

OAS98012

Oil/Air Separator Element



Fits: Tamrock Applications
Replaces: Tamrock 3582228; Donaldson P782915
O.D.: 3 15/16 (100.0)
 Flange 4 1/32 (102.4)
I.D.: 1 15/16 (49.2) One End
Height: 6 1/8 (155.6)
F. Gskt: [1] Included

OAS98008

Oil/Air Separator Element



Notes: CAUTION: Do not remove staples from gaskets. These staples provide electrical grounding continuity between defogger and tank.
Fits: Ingersoll-Rand SSR EP15SU, SSR HP15U Compressors
Replaces: Ingersoll-Rand 39858683, 39760962, 42361196
O.D.: 4 27/32 (123.0)
I.D.: 2 15/32 (62.7) One End
Height: 9 1/16 (230.2)
A. Gskt: [2] Attached

OAS98013

Oil/Air Separator Element



Notes: CAUTION: Do not remove staples from gaskets. These staples provide electrical grounding continuity between defogger and tank.
Fits: Ingersoll-Rand SSR EP250, SSR HP250, SSR XF250, SSR XP250, SSR EP300, SSR HP300, SSR XF300, SSR XF450 Compressors
Replaces: Ingersoll-Rand 39760590, 39742861; Donaldson P530810
O.D.: 14 7/8 (377.8)
 Flange 17 1/4 (438.2)
I.D.: 11 13/32 (289.7) One End
Height: 17 5/16 (439.7)
A. Gskt: [2] Attached

OAS98009

Oil/Air Separator Element



Fits: Ingersoll-Rand SSR EP75, SSR EP100, SSR HP100, SSR XF100 Compressors
Replaces: Ingersoll-Rand 39863857, 39831904
O.D.: 8 5/16 (211.1)
 Flange 13 5/16 (338.1)
I.D.: 5 3/32 (129.4) One End
Height: 14 (355.6)
A. Gskt: [2] Attached

OAS98014

Oil/Air Separator Element



Notes: CAUTION: Do not remove staples from gaskets. These staples provide electrical grounding continuity between defogger and tank.
Fits: Ingersoll-Rand Compressors
Replaces: Ingersoll-Rand 39831888
O.D.: 6 23/32 (170.7)
 Flange 7 7/8 (200.0)
I.D.: 3 13/16 (96.8) One End
Height: 9 1/16 (230.2)
A. Gskt: [2] Attached

Measurements Are Shown In Inches And (Millimeters)

WARNING: These products can expose you to chemicals, including Diisononyl Phthalate, Carbon black extracts, Nickel, 1,3 Butadiene, Ethylene Oxide, Epichlorohydrin, which are known to the State of California to cause cancer, and Bisphenol, Ethylene Glycol, Ethylene Oxide, 1,3 Butadiene, Epichlorohydrin, which are known to the State of California to cause birth defects or other reproductive harm. For more information go to www.P65Warnings.ca.gov.

OAS98015

Oil/Air Separator Element



Notes: CAUTION: Do not remove staples from gaskets. These staples provide electrical grounding continuity between defogger and tank.
Fits: Ingersoll-Rand R90IU, R110IU, SSR EP125BR, SSR HP125BR, SSR XF125BR, SSR EP150BR, SSR HP150BR, SSR XF150BR, R160IU, SSR EP200BR, SSR HP200BR, SSR XF200BR Compressors
Replaces: Ingersoll-Rand 54509427
O.D.: 10 27/32 (275.4)
 Flange 14 3/4 (374.7)
I.D.: 8 7/32 (208.8) One End
Height: 9 1/16 (230.2)
A. Gskt: [2] Attached

OAS98016

Oil/Air Separator Element



Fits: Ingersoll-Rand SSR EP30SE, SSR XF30S, SSR EP40SE, SSR EP40SE-B, SSR HP40SE-B, SSR HXP40SE-B, SSR EP50, SSR EP50SE, SSR EP50SE-B, SSR HP50SE, SSR HXP50SE, SSR, XF50SE, SSR XF50SF Compressors
Replaces: Ingersoll-Rand 54595442
O.D.: 6 21/32 (169.1)
 Flange 7 7/8 (200.0)
I.D.: 3 29/32 (99.2) One End
Height: 9 1/16 (230.2)
A. Gskt: [1] Attached

OAS98017

Oil/Air Separator Element



Notes: CAUTION: Do not remove staples from gaskets. These staples provide electrical grounding continuity between defogger and tank.
Fits: Sullair Compressors
Replaces: Sullair 250034086
O.D.: 10 7/8 (276.2)
 Flange 13 29/32 (353.2)
I.D.: 7 15/32 (189.7) One End
Height: 19 11/16 (500.1)
A. Gskt: [2] Attached

OAS98018

Oil/Air Separator Element



Notes: Each gasket has 16 holes.
Fits: Kaeser BS-44, BS-50, BS-51, BS-60, BS-61 Compressors
Replaces: Kaeser 619600, 6.2012.0
O.D.: 6 9/16 (165.7)
 Flange 7 7/8 (200.0)
I.D.: 4 11/32 (110.3) One End
Height: 17 1/2 (444.5)
F. Gskt: [2] Included

OAS98019

Oil/Air Separator Element



Fits: Gardner Denver Compressors
Replaces: Gardner Denver 202ECH6013, 200ECH035
O.D.: 5 1/2 (139.7)
I.D.: 2 5/8 (66.7) One End
Height: 12 (304.8)

OAS98020

Oil/Air Separator Element with Lift Bars



Fits: Gardner Denver Compressors
Replaces: Gardner Denver 208EAP6013, 200ECM035
O.D.: 5 1/2 (139.7)
I.D.: 2 13/32 (61.1) One End
Height: 22 5/8 (574.7)
O-Ring: [2] Attached

OAS98021

Oil/Air Separator Element

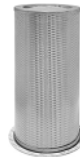

Fits: Sullair TS20-100, TS20-125, TS20-150, LS20SE-175, LS20SE-200, TS20-200, TS20-250, TS32-200, TS32-250, TS32-200, LS25/16 TANDEM 100 HP, LS25/16 TANDEM 125 HP, LS25/16 TANDEM 150 HP Compressors
Replaces: Sullair 250034122, 250034121
O.D.: 11 23/32 (297.7)
 Flange 13 29/32 (353.2)
I.D.: 8 11/32 (211.9) One End
Height: 26 1/16 (662.0)
A. Gskt: [2] Attached

OAS98022

Oil/Air Separator Element



Notes: CAUTION: Do not remove staples from gaskets. These staples provide electrical grounding continuity between defogger and tank.
Contains: Threaded Stud
Fits: Atlas Copco GA11 I GEN 110.001-110.999, GA15 I GEN 150.001-150.999, GA18 I GEN 180.001-180.999, GA22 I GEN 220.001-220.999 Compressors; Chicago Pneumatic S-8, S-8/15, S-8/20, S-8/30H,HH,L,M, 180-Q Com
Replaces: Atlas Copco 16123869, 1310250233; M.A.N. 4900152106; Donaldson P525529; Fleetguard AS2392
O.D.: 5 9/32 (134.1)
 Flange 8 11/16 (220.7)
I.D.: 3 7/16 (87.3) One End
Height: 10 7/8 (276.2)
F. Gskt: [2] Included
O-Ring: [2] Included

OAS98023

Oil/Air Separator Element



Contains: Bolt Hole in Flange
Fits: Sullair Compressors
Replaces: Sullair 250042862, 408167011; Fleetguard AS2388
O.D.: 3 13/16 (96.8)
 Flange 10 3/4 (273.1)
I.D.: 1 1/2 (38.1) One End
Height: 14 1/16 (357.2)
A. Gskt: [2] Attached

OAS98024

Oil/Air Separator Element

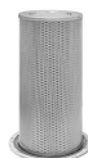

Fits: Sullair LS20-125L,H,HH,XH,VSD, LS20E-125, LS20S-125, LS20-150L,H,HH,XH,VSD, LS20E-150, USA, LS20S-150, LS20-175L,H,HH,XH Compressors
Replaces: Sullair 250034085
O.D.: 10 5/8 (269.9)
 Flange 13 25/32 (350.0)
I.D.: 7 7/16 (188.9) One End
Height: 24 1/2 (622.3)
A. Gskt: [2] Attached

Measurements Are Shown In Inches And (Millimeters)

WARNING: These products can expose you to chemicals, including Diisononyl Phthalate, Carbon black extracts, Nickel, 1,3 Butadiene, Ethylene Oxide, Epichlorohydrin, which are known to the State of California to cause cancer, and Bisphenol, Ethylene Glycol, Ethylene Oxide, 1,3 Butadiene, Epichlorohydrin, which are known to the State of California to cause birth defects or other reproductive harm. For more information go to www.P65Warnings.ca.gov.

OAS98025

Oil/Air Separator Element



Notes: CAUTION: Do not remove staples from gaskets. These staples provide electrical grounding continuity between defogger and tank.
Fits: Ingersoll-Rand Compressors
Replaces: Ingersoll-Rand 39737473; Donaldson P782921; Fleetguard AS2418
O.D.: 8 21/32 (219.9)
Flange: 11 3/8 (288.9)
I.D.: 5 25/32 (146.8) One End
Height: 24 1/2 (622.3)
A. Gskt: [2] Attached

OAS98030

Oil/Air Separator Element



Fits: Sullair Compressors
Replaces: Sullair 40260, 11173; Fleetguard AS2349
O.D.: 20 31/32 (532.6)
Flange: 26 1/2 (673.1)
I.D.: 18 7/32 (462.8) One End
Height: 32 9/16 (827.1)
A. Gskt: [2] Attached

OAS98026

Oil/Air Separator Element



Notes: CAUTION: Do not remove staples from gaskets. These staples provide electrical grounding continuity between defogger and tank.
Fits: Ingersoll-Rand MHP825 Compressor
Replaces: Ingersoll-Rand 89285761
O.D.: 10 7/8 (276.6)
Flange: 14 1/8 (358.8)
I.D.: 8 9/32 (210.3) One End
Height: 19 11/16 (500.1)
A. Gskt: [2] Attached

OAS98031

Oil/Air Separator Element



Contains: Bolt Hole plus [8] Holes in Flange
Fits: Sullair LS12, LS12-60 Leak Free, LS16-24KT, LS16-24KT LEAK FREE-60, LS16-75, LS16SRF LEAK FREE-100, LS16SRF-60 LEAK FREE, LS16SRF-75 LEAK FREE, LS20T Compressors
Replaces: Sullair 2250100756, 2250100754
O.D.: 5 3/4 (146.1)
Flange: 14 (355.6)
I.D.: 3 1/4 (82.6) One End
Height: 9 11/16 (246.1)
A. Gskt: [2] Attached

OAS98027

Oil/Air Separator Element



Notes: CAUTION: Do not remove staples from gaskets. These staples provide electrical grounding continuity between defogger and tank.
Contains: Bolt Hole in Flange
Fits: Sullair TS20-100, TS20-125, TS20-150, LS20SE-175, LS20SE-200, TS20-200, TS20-250 LS25/16 TANDEM 100 HP, LS25/16 TANDEM 150 HP Compressors
Replaces: Sullair 250034134
O.D.: 6 25/32 (172.2)
Flange: 13 29/32 (353.2)
I.D.: 3 13/16 (96.8) One End
Height: 18 7/16 (468.3)
A. Gskt: [2] Attached

OAS98032

Oil/Air Separator Element



Notes: CAUTION: Do not remove staples from gaskets. These staples provide electrical grounding continuity between defogger and tank.
Fits: Sullair LS10-40L,H,HH,XH Compressors
Replaces: Sullair 2250137895
O.D.: 6 23/32 (170.7)
Flange: 7 7/8 (200.2)
I.D.: 3 13/16 (96.8) One End
Height: 9 27/32 (250.0)
A. Gskt: [2] Attached

OAS98028

Oil/Air Separator Element



Fits: To 12/2009 Shultz SRP2100, SRP2150, SRP3100, SRP3100SS GD, GDSRP3150E GD, SRP3200 GD, SRP3200FLEX Compressors
Replaces: Tamrock 3340028; Fleetguard AS2458
O.D.: 3 15/16 (100.0)
I.D.: 2 5/32 (54.8) One End
Height: 16 11/32 (415.1)

OAS98033

Oil/Air Separator Element



Notes: CAUTION: Do not remove staples from gaskets. These staples provide electrical grounding continuity between defogger and tank.
Contains: [8] Holes in Flange
Fits: Sullair LS12, LS12-60 Leak Free, LS16-24KT, LS16-24KT LEAK FREE-60, LS16-75, LS16SRF LEAK FREE-100, LS16SRF-60 LEAK FREE, LS16SRF-75 LEAK FREE, LS20T Compressors
Replaces: Sullair 2250100755
O.D.: 10 7/8 (276.2)
Flange: 14 (355.6)
I.D.: 7 7/16 (188.9) One End
Height: 10 29/32 (277.0)
A. Gskt: [2] Attached

OAS98029

Oil/Air Separator Element with Bail Handle



Fits: Tamrock Applications
Replaces: Tamrock 3498328; Gardner Denver 301EFC6013
O.D.: 3 29/32 (99.2)
I.D.: 2 7/32 (56.4) One End
Height: 7 5/8 (193.7)

Measurements Are Shown In Inches And (Millimeters)

WARNING: These products can expose you to chemicals, including Diisononyl Phthalate, Carbon black extracts, Nickel, 1,3 Butadiene, Ethylene Oxide, Epichlorohydrin, which are known to the State of California to cause cancer, and Bisphenol, Ethylene Glycol, Ethylene Oxide, 1,3 Butadiene, Epichlorohydrin, which are known to the State of California to cause birth defects or other reproductive harm. For more information go to www.P65Warnings.ca.gov.

OAS98034

Oil/Air Separator Element with Lift Bars



Notes: CAUTION: Do not remove staples from gaskets. These staples provide electrical grounding continuity between defogger and tank.

Fits: Kaeser DSD-125AIR COOLED+SIGMA, DS-141, DSD-150AIR COOLED+SIGMA, DS-171, DSD-172, DSD-172T, DSD-172S, DSD-200AIR COOLED+SIGMA, DS201, DS-241, M260, M270 Compressors

Replaces: Kaeser 621320

O.D.: 15 5/8 (396.9)

Flange 17 1/16 (433.4)

I.D.: 12 13/32 (315.1) One End

Height: 15 11/16 (398.5)

F. Gskt: [2] Included

O-Ring: [2] Included

OAS98039

Oil/Air Separator Element



Notes: CAUTION: Do not remove staples from gaskets. These staples provide electrical grounding continuity between defogger and tank.

Contains: Bolt Hole in Flange

Fits: Sullair LS16-75L,H,HH,XHRA, LS16-100L,H,HH RA,HH USA, LS20-100L,H,HH,XHRA, LS20-125L,H,HH,XH, LS20-150L,H,HH,XH, LS20-175L,H,HH,XH, LS20-220L,H,HH,XH Compressors

Replaces: Sullair 250034128

O.D.: 8 3/8 (212.7)

Flange 13 29/32 (353.2)

I.D.: 5 25/32 (146.8) One End

Height: 22 17/32 (572.3)

A. Gskt: [2] Attached

OAS98035

Oil/Air Separator Element



Contains: [6] Bolts

[1] Mounting Plate

Fits: Quincy Compressors

Replaces: Quincy 127138002

O.D.: 5 3/8 (136.5)

I.D.: 2 1/4 (57.2) One End

Height: 6 3/8 (161.9)

A. Gskt: [1] Attached

F. Gskt: [1] Included

Spring: [1] Included

OAS98040

Oil/Air Separator Element



Fits: Ingersoll-Rand Compressors

Replaces: Ingersoll-Rand 39739578; Donaldson P525712; Fleetguard AS2263

O.D.: 11 7/8 (301.6)

Flange 15 1/2 (393.7)

I.D.: 8 7/16 (214.3) One End

Height: 17 29/32 (454.8)

A. Gskt: [2] Attached

OAS98036

Oil/Air Separator Element



Fits: Atlas Copco Compressors

Replaces: Atlas Copco 2901000401; Fleetguard AS2471

O.D.: 2 9/32 (57.9)

Flange 8 21/32 (169.1)

I.D.: 3 (76.2) One End

Height: 6 3/4 (171.5)

O-Ring: [2] Included

OAS98041

Oil/Air Separator Element



Notes: CAUTION: Do not remove staples from gaskets. These staples provide electrical grounding continuity between defogger and tank.

Fits: Ingersoll-Rand R90IU, R110IU, SSR EP125, SSR EP125BR, SSR HP125BR, SSR XF125BR, SSR EP150BR, SSR HP150BR, SSR XF150BR, R160IU, SSR EP200BR, SSR HP200BR, SSR XF200BR Compressors

Replaces: Ingersoll-Rand 39863865

O.D.: 10 27/32 (275.4)

Flange 14 3/4 (374.7)

I.D.: 8 7/32 (208.8) One End

Height: 17 (431.8)

A. Gskt: [2] Attached

OAS98037

Oil/Air Separator Element



Notes: CAUTION: Do not remove staples from gaskets. These staples provide electrical grounding continuity between defogger and tank.

Fits: Sullair 32/25-200, 32/25-300, TS32-200, TS32-250, TS32-300, TS32-350 Compressors

Replaces: Sullair 250034124

O.D.: 18 13/16 (477.8)

Flange 23 25/32 (604.0)

I.D.: 14 7/8 (377.8) One End

Height: 22 1/4 (565.2)

A. Gskt: [2] Attached

OAS98042

Oil/Air Separator Element with Lift Bars and Lift Tabs



Contains: Threaded Stud

[2] Springs

[1] Threaded Nut

[12] Holes in Each Gasket

Fits: Sullair Elgi TS750, DS900/100, DS900/200, DS900/300, DS-900/350, DT900/350, DS1100-300 Compressors

Replaces: Sullair 2250044197

O.D.: 11 1/2 (292.1)

I.D.: 9 1/4 (235.0) One End

Height: 29 27/32 (758.0)

F. Gskt: [2] Included

OAS98038

Oil/Air Separator Element



Notes: CAUTION: Do not remove staples from gaskets. These staples provide electrical grounding continuity between defogger and tank.

Fits: Sullair Compressors

Replaces: Sullair 250005547; Curtis RN27518; Donaldson P530783; Fleetguard AS2368

O.D.: 8 3/8 (212.7)

Flange 10 3/4 (273.1)

I.D.: 5 1/4 (133.4) One End

Height: 11 (279.4)

A. Gskt: [2] Attached

OAS98043

Oil/Air Separator Element



Fits: Sullair ES11 Compressor

Replaces: Sullair 225016706

O.D.: 5 7/16 (138.1)

I.D.: 2 11/16 (68.3) One End

Height: 13 11/16 (347.7)

O-Ring: [1] Attached, [1] Included

Measurements Are Shown In Inches And (Millimeters)



WARNING: These products can expose you to chemicals, including Diisononyl Phthalate, Carbon black extracts, Nickel, 1,3 Butadiene, Ethylene Oxide, Epichlorohydrin, which are known to the State of California to cause cancer, and Bisphenol, Ethylene Glycol, Ethylene Oxide, 1,3 Butadiene, Epichlorohydrin, which are known to the State of California to cause birth defects or other reproductive harm. For more information go to www.P65Warnings.ca.gov.

OAS98044

Oil/Air Separator Element with Lift Tabs



Fits: Quincy Compressors
Replaces: Quincy 129893
O.D.: 5 3/4 (146.1)
I.D.: 2 5/16 (58.7) One End
Height: 11 7/16 (290.5)

OAS98050

Oil/Air Separator Element



Notes: CAUTION: Do not remove staples from gaskets. These staples provide electrical grounding continuity between defogger and tank.
Fits: Ingersoll-Rand SSR EP250BR, SSR HP250BR, SSR XF250BR, SSR XP250BR, SSR EP300BR, SSR EPE300, SSR HP300BR, SSR HP300I, SSR HPE300, SSR XFE300 Compressors
Replaces: Ingersoll-Rand 54509500
O.D.: 13 25/32 (350.0)
Flange 17 (431.8)
I.D.: 10 7/16 (265.1) One End
Height: 16 15/32 (418.3)
A. Gskt: [2] Attached

OAS98045

Oil/Air Separator Element



Fits: Sullair ES8 Compressor
Replaces: Sullair 2250106791
O.D.: 3 7/32 (81.8)
I.D.: 1 5/16 (33.3) One End
Height: 11 25/32 (299.2)
A. Gskt: [1] Attached
F. Gskt: [1] Included
O-Ring: [1] Included

OAS98052

Oil/Air Separator Element



Contains: Bolt Holes in Flange
Fits: Compair 6180N084 Compressor
Replaces: LeROI 431111
O.D.: 11 7/8 (301.6)
Flange 13 25/32 (350.0)
I.D.: 8 21/32 (220.0) One End
Height: 19 13/16 (503.2)
A. Gskt: [2] Attached

OAS98046

Oil/Air Separator Element with Lift Bars



Notes: CAUTION: Do not remove staples from gaskets. These staples provide electrical grounding continuity between defogger and tank.
Fits: Gardner Denver Compressors
Replaces: Gardner Denver 202EDP6013
O.D.: 8 (203.2)
I.D.: 5 21/32 (143.7) One End
Height: 24 21/32 (626.3)
F. Gskt: [1] Included

OAS98053

Oil/Air Separator Element



Fits: Atlas Copco GA110 ELEKTRONIKON MK I, GA110 ELEKTRONIKON MK III To 314.999, GA110 ELETROPNEUMATICO, GA160 ELEKTRONIKON MK I, GA160 ELEKTRONIKON MK III 314.999, GA160 ELETROPNEUMATICO Compressors
Replaces: Atlas Copco 16146423
O.D.: 13 25/32 (350.0)
Flange 19 11/16 (500.1)
I.D.: 10 3/8 (263.5) One End
Height: 17 9/16 (446.1)
O-Ring: [2] Included

OAS98047

Oil/Air Separator Element



Fits: Ingersoll-Rand Compressors
Replaces: Ingersoll-Rand 39863899, 39831920
O.D.: 14 7/8 (377.8)
Flange 17 (431.8)
I.D.: 11 13/32 (289.7) One End
Height: 16 15/32 (418.3)
A. Gskt: [2] Attached

OAS98054

Oil/Air Separator Element



Notes: CAUTION: Do not remove staples from gaskets. These staples provide electrical grounding continuity between defogger and tank.
Fits: Chicago Pneumatic 900-QH w/Cummins NTA855C Engine, 950-DPH w/Mercedes-Benz Engine, 950-DUH w/Scania DS11 Engine, 950-Q Compressors
Replaces: Atlas Copco 16156038, 1615603801
O.D.: 10 11/32 (262.7)
Flange 15 3/4 (400.0)
I.D.: 6 1/4 (158.8) One End
Height: 22 1/16 (560.4)
F. Gskt: [2] Included

OAS98048

Oil/Air Separator Element



Notes: CAUTION: Do not remove staples from gaskets. These staples provide electrical grounding continuity between defogger and tank.
Fits: Quincy Compressors
Replaces: Quincy 227057
O.D.: 20 31/32 (532.6)
Flange 23 5/8 (600.1)
I.D.: 18 7/32 (462.8) One End
Height: 36 11/32 (923.1)
A. Gskt: [2] Attached

OAS98056

Oil/Air Separator Element



Contains: [6] Holes in Flange
Fits: Atlas Copco GA15 II GEN 151.001-151.999, GA18 II GEN 181.001-181.999, GA22 II GEN 221.001-221.999, GA30 BRP S/N 62855-up, GA30 VSD BRP S/N62855-up Compressors; Chicago Pneumatic S-8/15H,HH,L,M, S-8/20
Replaces: Atlas Copco 16137502, 1613750200
O.D.: 5 9/32 (134.1)
Flange 9 5/8 (244.5)
I.D.: 3 (76.2) One End
Height: 6 7/8 (174.6)
F. Gskt: [2] Included

OAS98049

Oil/Air Separator Element



Contains: Bolt Hole in Flange
Fits: Sullair LS20 Compressor
Replaces: Sullair 225145897
O.D.: 5 3/4 (146.1)
Flange 13 3/4 (349.3)
I.D.: 3 9/32 (83.3) One End
Height: 18 3/16 (462.0)
A. Gskt: [2] Attached

Measurements Are Shown In Inches And (Millimeters)

WARNING: These products can expose you to chemicals, including Diisononyl Phthalate, Carbon black extracts, Nickel, 1,3 Butadiene, Ethylene Oxide, Epichlorohydrin, which are known to the State of California to cause cancer, and Bisphenol, Ethylene Glycol, Ethylene Oxide, 1,3 Butadiene, Epichlorohydrin, which are known to the State of California to cause birth defects or other reproductive harm. For more information go to www.P65Warnings.ca.gov.

OAS98057



Oil/Air Separator Element

Notes: CAUTION: Do not remove staples from gaskets. These staples provide electrical grounding continuity between defogger and tank.

Fits: Sullair S-16 BR Compressor
Replaces: Sullair 250034118; Curtis RN27526; Fleetguard AS2357

O.D.: 8 3/8 (212.7)
Flange 10 3/4 (273.1)
I.D.: 5 1/4 (133.4) One End
Height: 24 3/32 (612.0)
A. Gskt: [2] Attached

OAS99003

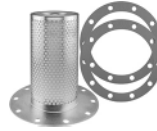

Oil/Air Separator Element

Replaces: Atlas Copco 2911-0028-00; Fleetguard AS2445; Woodgate WGOS1522
O.D.: 5 9/32 (134.1)
Flange 9 27/32 (250.0)
I.D.: 2 15/16 (74.6) One End
Height: 11 17/32 (292.9)
F. Gskt: [2] Included

OAS98058



Oil/Air Separator Element

Notes: CAUTION: Do not remove staples from gaskets. These staples provide electrical grounding continuity between defogger and tank.

Contains: [8] Holes in Flange
Replaces: Palatek 8000019

O.D.: 5 3/4 (146.1)
Flange 8 1/2 (215.9)
I.D.: 5 19/32 (142.1) One End
Height: 10 3/32 (256.4)
A. Gskt: [2] Attached

OAS99004



Oil/Air Separator Element

Replaces: Ingersoll-Rand 92699198; Woodgate WGOS198
O.D.: 10 13/16 (274.6)
Flange 12 (304.8)
I.D.: 8 9/32 (210.3) One End
Height: 9 21/32 (245.3)
F. Gskt: [2] Furnished

OAS99005



Oil/Air Separator Element

Replaces: Demag 10012674; Woodgate WGOS2101
O.D.: 3 11/16 (93.7)
Flange 5 9/32 (134.1)
I.D.: 2 31/32 (75.4) One End
Height: 6 5/16 (160.3)
F. Gskt: [2] Included

OAS98060



Oil/Air Separator Spin-on

Fits: Various Air Compressors
Replaces: Ingersoll-Rand 22388045, 24121212, 89259337; Doosan 89259337; Wix P26A734
Thread: M23 x 1.5
O.D.: 3 7/8 (98.4)
Length: 8 1/4 (209.6)
I.Gskt: [1] Included

OAS99006



Oil/Air Separator Element

Replaces: Atlas Copco 2989-0051-00; Fleetguard AS2201; Woodgate WGOS2836
O.D.: 6 5/8 (168.3)
Flange 11 13/16 (300.0)
I.D.: 4 13/16 (122.2) One End
Height: 19 9/16 (496.9)
F. Gskt: [2] Included

OAS98061



Oil/Air Separator Spin-on

Fits: Ingersoll-Rand Compressors
Replaces: Ingersoll-Rand 54749247; Hifi/Jura Filtration OV6077; Main Filter MF0534266; SF-Filter SPA50022/1; Wix P37A266
Thread: 1 1/2 -16
O.D.: 5 17/32 (140.5)
Height: 11 7/8 (301.6)
O-Ring: [1] Attached

OAS99008

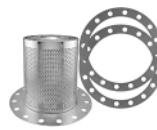

Oil/Air Separator Element

Replaces: Atlas Copco 4933-5210; Woodgate WGOS4656
O.D.: 10 5/16 (261.9)
Flange 15 3/4 (400.1)
I.D.: 6 1/2 (165.1) One End
Height: 13 31/32 (354.8)
F. Gskt: [2] Included

OAS99001



Oil/Air Separator Element with Foam Wrap

Replaces: Atlas Copco 2911-0068-00; Woodgate WGOS1142
O.D.: 4 15/16 (125.4)
4 31/32 (126.2)
I.D.: 1 3/32 (27.8)
Height: 7 25/32 (197.6)
O-Ring: [1] Included
Grommets: [2] Attached

OAS99010



Oil/Air Separator Element with Foam Wrap

Replaces: Ingersoll-Rand 92866508; Woodgate WGOS508
O.D.: 5 9/32 (134.1)
Flange 6 31/32 (177.0)
I.D.: 3 15/32 (88.1) One End
Height: 11 7/8 (301.6)
A. Gskt: [1] Attached
F. Gskt: [1] Included

OAS99002



Oil/Air Separator Element with Foam Wrap

Replaces: Ingersoll-Rand 92522135; Fleetguard AS2435; Woodgate WGOS135
O.D.: 4 5/16 (109.5)
Flange 6 15/32 (164.3)
I.D.: 2 3/8 (60.3) One End
Height: 9 27/32 (250.0)
A. Gskt: [1] Attached
F. Gskt: [1] Included

OAS99011

















Oil/Air Separator Element

Contains: Deflector Shield on Closed End
Replaces: CompAir 982628044; Fleetguard AS2405; Woodgate WGOS5085
O.D.: 6 19/32 (167.5)
Flange 8 21/32 (219.9)
I.D.: 4 13/16 (122.2) One End
Height: 7 1/2 (190.5)
F. Gskt: [2] Included

Measurements Are Shown In Inches And (Millimeters)



WARNING: These products can expose you to chemicals, including Diisononyl Phthalate, Carbon black extracts, Nickel, 1,3 Butadiene, Ethylene Oxide, Epichlorohydrin, which are known to the State of California to cause cancer, and Bisphenol, Ethylene Glycol, Ethylene Oxide, 1,3 Butadiene, Epichlorohydrin, which are known to the State of California to cause birth defects or other reproductive harm. For more information go to www.P65Warnings.ca.gov.

<p>OAS99014 Oil/Air Separator Element Replaces: Quincy 227052; Fleetguard AS2424; Woodgate WGOS5321 O.D.: 10 3/4 (273.1) Flange 12 3/4 (323.9) I.D.: 8 5/8 (219.1) One End Height: 18 1/16 (458.8) F. Gskt: [2] Included</p> 	<p>OAS99021 Oil/Air Separator Element Replaces: Atlas Copco 2901-0213-00; Fleetguard AS2446; Woodgate WGOS6880 O.D.: 6 19/32 (167.5) Flange 11 13/16 (300.0) I.D.: 4 1/4 (108.0) Height: 9 1/16 (230.2) O-Ring: [4] Included</p> 
<p>OAS99015 Oil/Air Separator Element Replaces: Atlas Copco 1619-5498-00; Fleetguard AS2203; Woodgate WGOS5498 O.D.: 6 5/8 (168.3) Flange 8 21/32 (219.9) I.D.: 4 13/16 (122.2) One End Height: 9 17/32 (242.1) F. Gskt: [2] Included</p> 	<p>OAS99023 Oil/Air Separator Element Replaces: CompAir 982628045; Woodgate WGOS8045 O.D.: 6 19/32 (167.5) Flange 8 19/32 (218.3) I.D.: 4 11/32 (110.3) One End Height: 6 5/16 (160.3) F. Gskt: [2] Included</p> 
<p>OAS99016 Oil/Air Separator Element Replaces: CompAir 982628020; Fleetguard AS2407; Woodgate WGOS5851 O.D.: 8 11/32 (211.9) Flange 11 13/16 (300.0) I.D.: 6 15/32 (164.3) One End Height: 7 9/16 (192.1) A. Gskt: [1] Attached O-Ring: [1] Included</p> 	<p>OAS99024 Oil/Air Separator Element with Foam Wrap Replaces: Ingersoll-Rand 92808286; Woodgate WGOS8286 O.D.: 5 29/32 (150.0) Flange 8 1/2 (215.9) I.D.: 3 15/16 (100.0) One End Height: 7 7/8 (200.0) A. Gskt: [1] Attached F. Gskt: [1] Included</p> 
<p>OAS99017 Oil/Air Separator Element Fits: Ingersoll-Rand Compressors Replaces: Ingersoll-Rand 92077601; Fleetguard AS2437; Woodgate WGOS601 O.D.: 5 5/16 (134.9) Flange 6 31/32 (177.0) I.D.: 3 15/32 (88.1) One End Height: 11 7/8 (301.6) F. Gskt: [2] Included</p> 	<p>OAS99025 Oil/Air Separator Element Replaces: Atlas Copco 1202-8722; Fleetguard AS2391; Woodgate WGOS8722 O.D.: 5 9/32 (134.1) Flange 8 21/32 (219.9) I.D.: 3 (76.2) One End Height: 6 23/32 (170.7) F. Gskt: [2] Included</p> 
<p>OAS99018 Oil/Air Separator Element Replaces: Atlas Copco 2252-6313; Fleetguard AS2202; Woodgate WGOS6313 O.D.: 10 27/32 (275.4) Flange 15 3/4 (400.1) I.D.: 8 1/2 (215.9) One End Height: 32 9/32 (819.9) F. Gskt: [2] Included</p> 	<p>OAS99028 Oil/Air Separator Spin-on Contains: Integral Post Seal Replaces: Mann & Hummel LB11102/2; Fleetguard AS2453; Woodgate WGOS1112 Thread: M32 x 1.5 O.D.: 4 11/32 (110.3) Height: 10 3/8 (263.5) I.Gskt: [1] Included</p> 
<p>OAS99019 Oil/Air Separator Element Replaces: Atlas Copco 2911-0040-00; Woodgate WGOS6366 O.D.: 3 29/32 (99.2) Flange 6 7/8 (174.6) I.D.: 1 5/8 (41.3) One End Height: 4 3/4 (120.7)</p> 	<p>OAS99029 Oil/Air Separator Spin-on Contains: Integral Post Seal Replaces: Ingersoll-Rand 93525657; Fleetguard AS2452; Woodgate WGOS1374 Thread: M39 x 1.5 O.D.: 5 1/2 (139.7) Height: 7 3/32 (180.2) I.Gskt: [1] Included</p> 
<p>OAS99020 Oil/Air Separator Element Replaces: Ingersoll-Rand 92754688; Fleetguard AS2273; Woodgate WGOS688 O.D.: 6 17/32 (165.9) Flange 7 11/16 (195.3) I.D.: 4 9/32 (108.7) One End Height: 9 1/32 (229.4) F. Gskt: [2] Included</p> 	<p>OAS99031 Oil/Air Separator Spin-on Replaces: Ingersoll-Rand 93613107; Fleetguard AS2454; Woodgate WGOS13145 Thread: M39 x 1.5 O.D.: 5 13/32 (137.3) Height: 11 31/32 (304.0) I.Gskt: [1] Included</p> 

Measurements Are Shown In Inches And (Millimeters)

WARNING: These products can expose you to chemicals, including Diisononyl Phthalate, Carbon black extracts, Nickel, 1,3 Butadiene, Ethylene Oxide, Epichlorohydrin, which are known to the State of California to cause cancer, and Bisphenol, Ethylene Glycol, Ethylene Oxide, 1,3 Butadiene, Epichlorohydrin, which are known to the State of California to cause birth defects or other reproductive harm. For more information go to www.P65Warnings.ca.gov.

OAS99032



Oil/Air Separator Spin-on
Contains: Integral Post Seal
Replaces: CompAir 98262215;
 Fleetguard AS2451; Woodgate WGOS962
Thread: M24 x 1.5
O.D.: 3 27/32 (97.6)
Height: 8 7/32 (208.8)
I.Gskt: [1] Included

OAS99043



Oil/Air Separator Element
Replaces: Ingersoll-Rand 92735547;
 Fleetguard AS2417; Woodgate WGOS883
O.D.: 5 9/32 (134.1)
 Flange 6 1/2 (165.1)
I.D.: 3 15/32 (88.1) One End
Height: 9 3/4 (247.7)
F. Gskt: [2] Included

OAS99034



Oil/Air Separator Element
Replaces: Atlas Copco 2911-0015-00;
 Fleetguard AS2393; Woodgate WGOS4373
O.D.: 8 21/32 (219.9)
 Flange 11 13/16 (300.0)
I.D.: 6 9/16 (166.7) One End
Height: 9 17/32 (242.1)
F. Gskt: [2] Included

OAS99046



Oil/Air Separator Element
Replaces: Atlas Copco 1613-8007-00;
 Woodgate WGOS5225
O.D.: 9 13/32 (238.9)
 Flange 15 3/4 (400.0)
I.D.: 6 31/32 (177.0)
Height: 12 (304.8)
F. Gskt: [2] Included

OAS99035



Oil/Air Separator Element
Replaces: Tamrock 3267728;
 Fleetguard AS2462; Woodgate WGOS7728
O.D.: 3 1/16 (77.8)
I.D.: 1 19/32 (40.5) One End
Height: 9 31/32 (253.2)
O-Ring: [1] Attached

OAS99047



Oil/Air Separator Spin-on
Replaces: Rotorcomp R12101;
 Donaldson P782909; Fleetguard AS2454
Thread: M39 -1.5
O.D.: 5 1/2 (139.7)
Height: 12 1/32 (305.6)
I.Gskt: [1] Included

OAS99037



Oil/Air Separator Element with Foam Wrap
Replaces: Atlas Copco 2911-0054-00;
 Woodgate WGOS1122
O.D.: 4 5/16 (109.5)
I.D.: 1 5/32 (29.4)
Height: 6 9/16 (166.7)
O-Ring: [1] Included
Grommets: [2] Attached

OAS99048



Oil/Air Separator Spin-on
Replaces: Rotorcomp R12476;
 Donaldson P783499; Fleetguard AS2451
Thread: M24 x 1.5
O.D.: 3 27/32 (97.6)
Height: 8 5/16 (211.1)
I.Gskt: [1] Included

OAS99038

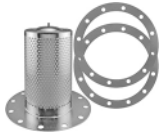

Oil/Air Separator Element
Replaces: Atlas Copco 2989-0045-00;
 Fleetguard AS2200; Woodgate WGOS2433
O.D.: 6 5/8 (168.3)
 Flange 11 13/16 (300.0)
I.D.: 4 25/32 (121.4) One End
Height: 12 15/16 (328.6)
F. Gskt: [2] Included

OAS99040



Oil/Air Separator Element
Replaces: CompAir 982625133;
 Woodgate WGOS5133
O.D.: 3 29/32 (99.2)
 Flange 7 (177.8)
I.D.: 1 5/8 (41.3) One End
Height: 5 29/32 (150.0)
F. Gskt: [2] Included

OAS99042



Oil/Air Separator Element
Replaces: Sullair 408167010;
 Woodgate WGOS5201
O.D.: 6 5/8 (168.3)
 Flange 7 7/8 (200.0)
I.D.: 4 13/16 (122.2) One End
Height: 9 17/32 (242.1)
F. Gskt: [2] Included

Measurements Are Shown In Inches And (Millimeters)

WARNING: These products can expose you to chemicals, including Diisononyl Phthalate, Carbon black extracts, Nickel, 1,3 Butadiene, Ethylene Oxide, Epichlorohydrin, which are known to the State of California to cause cancer, and Bisphenol, Ethylene Glycol, Ethylene Oxide, 1,3 Butadiene, Epichlorohydrin, which are known to the State of California to cause birth defects or other reproductive harm. For more information go to www.P65Warnings.ca.gov.

STANADYNE FUEL ADDITIVES

Part Number	Label Language**	Name	Package Size		Quantity Treated		Case Qty. Bottles
			US Gallons	Liters	US Gallons	Liters	
38557	C, P, S	Gasoline Additive	8 oz.	237 ml	up to 18	68	24
38559	C, P	Lubricity Formula™	8 oz.	237 ml	up to 15	60	24
38560	C, P	Lubricity Formula™	16 oz. (Pint)	473 ml	125	470	12
38561	C, P	Lubricity Formula™	64 oz. (1/2 Gallon)	1.9 L	500	1,900	6
38562	C, P	Lubricity Formula™	5 Gallons	19 L	5,000	19,200	1
38563*	C, P	Lubricity Formula™	55 Gallons	208 L	55,000	208,000	1
38564	C, P, S	Performance Formula® All Season	8 oz.	237 ml	up to 30	120	24
38565	C, P, S	Performance Formula® All Season	16 oz. (Pint)	473 ml	60	227	12
38566	C, P, S	Performance Formula® All Season	64 oz. (1/2 Gallon)	1.9 L	240	909	6
38567	C, P, S	Performance Formula® All Season	5 Gallons	19 L	2,500	9,600	1
38568*	C, P, S	Performance Formula® All Season	55 Gallons	208 L	27,500	104,099	1
43562	C, P, S	Performance Formula® Injector Cleaner	8 oz.	237 ml	up to 25	95	24
43564	C, P, S	Performance Formula® Injector Cleaner	16 oz. (Pint)	473 ml	50	189	12
43566	C, P, S	Performance Formula® Injector Cleaner	32 oz. (Quart)	946 ml	100	379	12
43568	C, P, S	Performance Formula® Warm Weather Blend	8 oz.	237 ml	up to 30	114	24
43570	C, P, S	Performance Formula® Warm Weather Blend	16 oz. (Pint)	473 ml	60	227	12
43572	C, P, S	Performance Formula® Warm Weather Blend	64 oz. (1/2 Gallon)	1.9 L	240	909	6
43573*	C, P, S	Performance Formula® Warm Weather Blend	55 Gallons	208 L	27,000	104,099	1
43574	C, P, S	Performance Formula® Warm Weather Blend	5 Gallons	19 L	2,500	9,464	1
38574	C, P	Winter 1000®	16 oz. (Pint)	473 ml	125	470	12
38575	C, P	Winter 1000®	5 Gallons	19 L	5,000	19,200	1
38576*	C, P	Winter 1000®	55 Gallons	208 L	55,000	208,000	1

* 55-Gallon Drums will be special ordered and may be subject to special freight charges. Please call Baldwin Filters Customer Service Department for details.

**Label Language. Label printed in English (P), French (C) and Spanish (S).

Injector Cleaner, Lubricity Formula, Warm Weather Formula

 **WARNING:** This product can expose you to chemicals including Naphthalene and Ethylene Oxide, which are known to the State of California to cause cancer, and Ethylene Oxide, which is known to the State of California to cause birth defects or other reproductive harm. For more information go to www.P65Warnings.ca.gov.

Performance Formula, Winter 1000, Gasoline Additive+

 **WARNING:** This product can expose you to chemicals including Naphthalene, which is known to the State of California to cause cancer, and Toluene which is known to the State of California to cause birth defects or other reproductive harm. For more information go to www.P65Warnings.ca.gov.

<p>Gaskets</p> <p>Numbers with -AF Suffix (Normally on Air Filters)</p>	<p>G37-AF Sponge O-Ring</p> <p>O.D.: 12 (304.8) I.D.: 11 3/8 (288.9) Thick: 5/16 (7.9) Optional On: PA1625</p>	<p>G107 Neoprene Groove Gasket</p> <p>O.D.: 3 5/8 (98.8) I.D.: 3 23/32 (94.5) Thick: 1/8 (3.2) Furnished With: PT62 Optional On: PT70, PT71</p>	<p>G140-A Neoprene Groove Gasket</p> <p>O.D.: 5 15/16 (150.8) I.D.: 5 23/32 (145.3) Thick: 1/8 (3.2) Furnished With: V24-A2, V1645-C, Optional On: PT12</p>
<p>G15-AF Buna N Post Seal</p> <p>O.D.: 1 3/16 (30.2) I.D.: 27/64 (10.7) Thick: 1/8 (3.2) Furnished With: PA2607, PA2773</p>	<p>G39-AF Buna N Post Seal</p> <p>O.D.: 1 1/8 (28.6) I.D.: 3/8 (9.5) Thick: 1/8 (3.2) Furnished With: Various Air Filters</p>	<p>G115-A Buna N Gasket</p> <p>O.D.: 5 1/8 (130.2) I.D.: 4 3/8 (111.1) Thick: 3/32 (2.4) Furnished With: Various Filters Optional On: P40 (Massey Ferguson Applications), PT207 Series, PT951</p>	<p>G141-AF Sponge Boot Gasket</p> <p>O.D.: 18 1/4 (463.6) I.D.: 17 1/4 (438.2) Thick: 2 1/8 (54.0) Furnished With: PA2363, PA2453, PA2507</p>
<p>G21-AF Sponge Gasket with 8 Bolt Holes</p> <p>O.D.: 12 3/4 (323.9) I.D.: 10 1/2 (266.7) Thick: 1/4 (6.4) Furnished With: Various Air Filters</p>	<p>G102-A Buna N Gasket</p> <p>O.D.: 6 9/16 (166.7) I.D.: 6 1/16 (154.0) Thick: 5/64 (2.0) Furnished With: P116, PF116, PF949 Optional On: PT117, PT117-25</p>	<p>G115-MSB Buna N Groove Gasket</p> <p>O.D.: 5 1/64 (127.4) I.D.: 4 25/32 (121.4) Thick: 1/8 (3.2) Furnished With: Various Filters Optional On: PT61-HD, PT72, PT154, PT203-HD, PT203-HD10, PF225, PT670, PT670-E Replaces: Cat 5B5973; IHC 260839-R1</p>	<p>G143 Fiber Gasket</p> <p>O.D.: 5 1/8 (130.2) I.D.: 4 5/8 (117.5) Thick: 1/16 (1.6) Furnished With: PT137, PF846, OB1303 Optional On: P20-HD</p>
<p>ES24-B Buna N Post Seal</p> <p>O.D.: 1 3/16 (30.2) I.D.: 15/16 (23.8) Thick: 7/32 (5.6) Furnished With: BF582, BF591, BF597, BF862 Optional On: BF1102</p>	<p>G103 Buna N Groove Gasket</p> <p>O.D.: 2 59/64 (74.2) I.D.: 2 19/32 (65.9) Thick: 3/32 (2.4) Furnished With: PF847 Optional On: P42</p>	<p>G120-A Buna N Gasket</p> <p>O.D.: 4 3/16 (106.4) I.D.: 3 11/16 (93.7) Thick: 1/16 (1.6) Optional On: PA1963 Attached On: PT568</p>	<p>G144 Fiber Gasket</p> <p>O.D.: 6 3/64 (153.6) I.D.: 5 49/64 (146.5) Thick: 1/16 (1.6) Furnished With: V1656-O, V1656-T</p>
<p>ES24-D Buna N D-Ring Seal</p> <p>O.D.: 1 21/64 (33.7) I.D.: 61/64 (24.2) Thick: 11/64 (4.4) Furnished With: Various Spin-ons Optional On: BF5813</p>	<p>G103-N Steel and Rubber End Seal</p> <p>O.D.: 1 1/4 (31.8) I.D.: 9/16 (14.3) Thick: 1/8 (3.2) Furnished With: Various Air Filters</p>	<p>G123 Buna N Gasket</p> <p>O.D.: 4 5/32 (105.6) I.D.: 3 55/64 (98.0) Thick: 1/16 (1.6) Furnished With: P54, PT151</p>	<p>G145-AF Sponge Gasket with 12 Bolt Holes</p> <p>O.D.: 15 3/4 (400.1) I.D.: 13 3/4 (349.3) Thick: 7/32 (5.6) Furnished With: Various Air Filters</p>
<p>G25-AF Sponge Gasket with 12 Bolt Holes</p> <p>O.D.: 15 (381.0) I.D.: 12 3/4 (323.9) Thick: 1/4 (6.4) Furnished With: Various Air Filters Optional On: LL2438, PA2438, LL2439, PA2439</p>	<p>G104 Buna N Fiber Gasket</p> <p>O.D.: 4 47/64 (120.3) I.D.: 4 11/32 (110.3) Thick: 1/16 (1.6) Furnished With: P41, P42, PT46, PF809, PF821-S Optional On: F225-F, PF225</p>	<p>G127 Buna N Gasket</p> <p>O.D.: 4 17/32 (115.1) I.D.: 4 1/64 (102.0) Thick: 1/16 (1.6) Furnished With: JC405, V738-O, VT842-O Optional On: CU406</p>	<p>G147-A Buna N Groove Gasket</p> <p>O.D.: 3 5/32 (80.2) I.D.: 2 29/32 (73.8) Thick: 1/8 (3.2) Furnished With: Various Filters Optional On: P177</p>
<p>G31-AF Sponge O-Ring</p> <p>O.D.: 11 3/8 (288.9) I.D.: 10 3/4 (273.1) Thick: 5/16 (7.9) Furnished With: PA2658 Optional On: PA639</p>	<p>G105 Fiber Gasket</p> <p>O.D.: 4 3/16 (106.4) I.D.: 3 25/32 (96.0) Thick: 1/16 (1.6) Furnished With: P40, C59-C, S489, F813-F</p>	<p>G132 Buna N Gasket</p> <p>O.D.: 4 15/16 (125.4) I.D.: 4 13/32 (111.9) Thick: 1/16 (1.6) Furnished With: P80, P80-HD, P184</p>	<p>G148 Neoprene Fiber Gasket</p> <p>O.D.: 6 1/32 (153.2) I.D.: 5 17/32 (140.5) Thick: 3/32 (2.4) Furnished With: DF408</p>
<p>G34-AF Sponge O-Ring</p> <p>O.D.: 13 (330.2) I.D.: 12 3/8 (314.3) Thick: 5/16 (7.9) Optional On: PA645 Replaces: Cat 2M6449</p>	<p>G106 Buna N Fiber Gasket</p> <p>O.D.: 4 11/16 (119.1) I.D.: 4 (101.6) Thick: 1/16 (1.6) Furnished With: Various Filters</p>	<p>G133 Buna N Gasket</p> <p>O.D.: 4 1/16 (103.2) I.D.: 3 1/2 (88.9) Thick: 3/32 (2.4) Furnished With: Various Filters Optional On: PT265</p>	<p>G153 Buna N Groove Gasket</p> <p>O.D.: 4 (101.6) I.D.: 3 49/64 (95.6) Thick: 1/8 (3.2) Furnished With: Various Filters</p>
			<p>G154 Buna N Gasket</p> <p>O.D.: 4 3/4 (120.7) I.D.: 4 1/4 (108.0) Thick: 3/32 (2.4) Optional On: P82, PT82-HD PT82-HD10</p>



WARNING: These products can expose you to chemicals, including Diisononyl Phthalate, Carbon black extracts, Nickel, 1,3 Butadiene, Ethylene Oxide, Epichlorohydrin, which are known to the State of California to cause cancer, and Bisphenol-A, Ethylene Glycol, Ethylene Oxide, 1,3 Butadiene, Epichlorohydrin, which are known to the State of California to cause birth defects or other reproductive harm. For more information go to www.P65Warnings.ca.gov.

G155
Fiber Cover Gasket with 12 Bolt Holes



O.D.: 9 3/4 (247.7)
 I.D.: 8 5/16 (211.1)
 Thick: 1/32 (0.8)
Optional On: C704-L, C750-E, C750-L, C750-L SINGLE, F7040, P7040, F7500, P7500, P7500 SINGLE
Fits: Luber-finer 500-B, 750-B Housings

G157
Buna N O-Ring (Uniform Dash Number 446)

O.D.: 9 (228.6)
 I.D.: 8 15/32 (215.1)
 Thick: 9/32 (7.1)
Optional On: C704-L, P706-M, PV706-M, C750-E, C750-L, C750-L SINGLE, P7040, F7500, P7500, P7500 SINGLE
Fits: B7040, B7500 Series Housings; Mack, WGB Dual-Flow Housing
Replaces: Cummins 256981; WGB GA38

G161
Buna N Groove Gasket

O.D.: 3 7/64 (79.0)
 I.D.: 2 61/64 (75.0)
 Thick: 3/32 (2.4)
Furnished With: PT29, P171, P177, PF816, PF820-S
Optional On: P174

G162
Buna N O-Ring (Uniform Dash Number 240)

O.D.: 4 (101.6)
 I.D.: 3 3/4 (95.3)
 Thick: 9/64 (3.6)
Furnished With: P60, PT8359
Optional On: PT90, PT93, PT93-MPG
Replaces: Cat 1H8128

G164-A
Buna N Cover Gasket

O.D.: 5 63/64 (152.0)
 I.D.: 5 25/64 (136.9)
 Thick: 1/16 (1.6)
Furnished With: P47, PT431
Optional On: PT146, P996, P999, P999-HD, B1000-CD
Fits: Nugent Remote Mount Housings
Replaces: Cummins 69751

G165
Buna N Groove Gasket

O.D.: 3 5/64 (78.2)
 I.D.: 2 59/64 (74.2)
 Thick: 11/64 (4.4)
Furnished With: P172, P174

G168-B
Buna N Groove Gasket

O.D.: 4 11/32 (110.3)
 I.D.: 4 3/32 (104.0)
 Thick: 1/8 (3.2)
Furnished With: PT12, P15, P104, P190, P219

G169
Buna N Cover Gasket

O.D.: 5 3/4 (146.1)
 I.D.: 5 1/4 (133.4)
 Thick: 1/16 (1.6)
Optional On: PF155
Fits: Luber-finer F155 Housings Made Before 9/53 with Flat Head Gasket
Replaces: Luber-finer 1867

G171
Buna N Groove Gasket

O.D.: 4 1/2 (114.3)
 I.D.: 4 19/64 (109.1)
 Thick: 1/8 (3.2)
Furnished With: PT670, PT670-E
Optional On: PT61-HD, PT66-HD, P80, P80-HD
Replaces: Cat 5B5937

G172-A
Buna N Groove Gasket

O.D.: 3 1/8 (79.4)
 I.D.: 2 57/64 (73.4)
 Thick: 1/8 (3.2)
Furnished With: P172, P240, P271
Optional On: P176

G173-C
Buna N O-Ring (Uniform Dash Number 229)

O.D.: 2 41/64 (67.1)
 I.D.: 2 23/64 (59.9)
 Thick: 9/64 (3.6)
Optional On: PT435

G183
Cork Gasket

O.D.: 3 3/4 (95.3)
 I.D.: 3 1/4 (82.6)
 Thick: 3/32 (2.4)
Furnished With: S16-1
Optional On: P171

G184-A
Buna N Groove Gasket

O.D.: 5 9/64 (130.6)
 I.D.: 4 51/64 (121.8)
 Thick: 3/32 (2.4)
Furnished With: PT154, P203, P204
Optional On: P203-HD, P203-HD10, P204-HD, P204-HD10
Replaces: IHC 381627-R1

G193
Buna N Groove Gasket

O.D.: 7 53/64 (198.8)
 I.D.: 7 29/64 (189.3)
 Thick: 9/32 (7.1)
Furnished With: PT394-5, PT394-15
Optional On: P194, P194-HD, P194-HD10, PF194
Replaces: Koehring 9006388

G196-B
Buna N Groove Gasket

O.D.: 5 11/16 (144.5)
 I.D.: 5 15/32 (138.9)
 Thick: 1/8 (3.2)
Furnished With: PT88-HD
Optional On: PT90-10
Replaces: Cat 6F9163

G202
Buna N Groove Gasket

O.D.: 4 11/64 (106.0)
 I.D.: 3 15/16 (100.0)
 Thick: 3/32 (2.4)
Furnished With: PT213, P235
Optional On: P198

G203
Buna N O-Ring (Uniform Dash Number 255)

O.D.: 5 7/8 (149.2)
 I.D.: 5 39/64 (142.5)
 Thick: 9/64 (3.6)
Optional On: PT85, PT90-10
Replaces: Cat 2D8009; Hyster 15895

G204-A
Buna N Groove Gasket

O.D.: 2 23/32 (69.1)
 I.D.: 2 15/32 (62.7)
 Thick: 5/32 (4.0)
Furnished With: PF827
Optional On: PF224

G206
Buna N O-Ring (Uniform Dash Number 444)

O.D.: 8 9/32 (210.3)
 I.D.: 7 23/32 (196.1)
 Thick: 9/32 (7.1)
Furnished With: PT729
Optional On: V1874-T
Fits: Winslow 2075-CE Housings
Replaces: Winslow 296G

G207-AF
Sponge Gasket with 8 Bolt Holes

O.D.: 11 (279.4)
 I.D.: 9 (228.6)
 Thick: 1/4 (6.4)
Optional On: LL2503, PA2503

G208-A
Neoprene Gasket

O.D.: 4 13/16 (122.2)
 I.D.: 4 3/8 (111.1)
 Thick: 1/16 (1.6)
Furnished With: P80, P80-HD
Optional On: P52

G210
Buna N Gasket

O.D.: 7 1/8 (181.0)
 I.D.: 6 7/16 (163.5)
 Thick: 5/64 (2.0)
Furnished With: PF949
Optional On: PT119, PT119-5, PT119-HD, PT119-HD5, PT119-HD5DL

G211
Buna N O-Ring (Uniform Dash Number 429)

O.D.: 5 17/32 (140.5)
 I.D.: 4 31/32 (126.2)
 Thick: 9/32 (7.1)
Furnished With: PT385, PT8338
Optional On: P204, P204-HD, P204-HD10, PT275, PT275-10, PT376, PT385-E
Replaces: GMC 5577310; IHC 343912-R91

G214
Buna N Groove Gasket

O.D.: 4 49/64 (121.1)
 I.D.: 4 39/64 (117.1)
 Thick: 1/8 (3.2)
Furnished With: PT670
Optional On: PT670-E
Replaces: Cat 5M5999

G219
Buna N O-Ring (Uniform Dash Number 345)

O.D.: 4 25/64 (111.5)
 I.D.: 3 31/32 (100.8)
 Thick: 13/64 (5.2)
Furnished With: PF823(6)
Optional On: P82, PT82-HD, PT82-HD10
Replaces: Cat 4F7387

G220
Buna N Groove Gasket

O.D.: 4 9/32 (108.7)
 I.D.: 3 31/32 (100.8)
 Thick: 1/8 (3.2)
Optional On: PT63-1
Replaces: John Deere A519R

G222-B
Buna N Groove Gasket

O.D.: 4 19/32 (116.7)
 I.D.: 4 3/16 (106.4)
 Thick: 5/32 (4.0)
Optional On: P82, PT82-HD, PT82-HD10

WARNING: These products can expose you to chemicals, including Diisononyl Phthalate, Carbon black extracts, Nickel, 1,3 Butadiene, Ethylene Oxide, Epichlorohydrin, which are known to the State of California to cause cancer, and Bisphenol-A, Ethylene Glycol, Ethylene Oxide, 1,3 Butadiene, Epichlorohydrin, which are known to the State of California to cause birth defects or other reproductive harm. For more information go to www.P65Warnings.ca.gov.

G225-AF
Sponge Gasket
 O.D.: 12 5/8 (320.7)
 I.D.: 11 5/8 (295.3)
 Thick: 2 1/8 (54.0)
 Optional On: LL1886, PA1886

G229
Buna N O-Ring
(Uniform Dash Number 239)
 O.D.: 3 57/64 (98.8)
 I.D.: 3 39/64 (91.7)
 Thick: 9/64 (3.6)
 Furnished With: S16-1
 Optional On: PF121, PT189, PT189-MPG
 Replaces: Cat 8H7521

G232
Buna N O-Ring
(Uniform Dash Number 338)
 O.D.: 3 33/64 (89.3)
 I.D.: 3 7/64 (79.0)
 Thick: 13/64 (5.2)
 Optional On: P106, P106-HD, P107

G233-A
Buna N Small
Head Groove Gasket
 O.D.: 3 11/32 (84.9)
 I.D.: 3 1/16 (77.8)
 Thick: 1/8 (3.2)
 Furnished With: P497, BF812, BF825, BF874, BF884

G233-B
Buna N Groove Gasket
Identified with 2 Stripes
 O.D.: 3 15/32 (88.1)
 I.D.: 3 3/16 (81.0)
 Thick: 1/8 (3.2)
 Furnished With: BF812, BF825, BF874, BF884
 Optional On: PF834

G236-A
Buna N O-Ring
(Uniform Dash Number 348)
 O.D.: 4 49/64 (121.0)
 I.D.: 4 23/64 (110.7)
 Thick: 13/64 (5.2)
 Furnished With: PT373
 Optional On: PT207, PT207-10, PT207-HD, PT207-HD10, PT433, PT554
 Replaces: Massey Ferguson 515115-M1

G238
Buna N O-Ring
(Uniform Dash Number 445)
 O.D.: 8 17/32 (216.7)
 I.D.: 7 31/32 (202.4)
 Thick: 9/32 (7.1)
 Optional On: C704-L, C750-E, C750-L, C750-L SINGLE, P7040, F7500, P7500, P7500 SINGLE
 Fits: Early Model Cummins 500, 750 Housings
 Replaces: Cummins 145641, 150004

G239
Buna N Groove Gasket
 O.D.: 3 9/64 (79.8)
 I.D.: 2 31/32 (75.4)
 Thick: 5/32 (4.0)
 Furnished With: P176
 Optional On: P174

G240
Buna N Groove Gasket
 O.D.: 5 (127.0)
 I.D.: 4 23/32 (119.9)
 Thick: 1/8 (3.2)
 Furnished With: PF7890 Series
 Optional On: PF225

G241
Buna N Groove Gasket
 O.D.: 3 7/8 (98.4)
 I.D.: 3 11/16 (93.7)
 Thick: 1/8 (3.2)
 Optional On: PF226

G243-A
Buna N Fiber Cover Gasket
 O.D.: 4 5/16 (109.5)
 I.D.: 3 15/16 (100.0)
 Thick: 1/16 (1.6)
 Furnished With: VT842-O

G247
Buna N O-Ring
(Uniform Dash Number 236)
 O.D.: 3 33/64 (89.3)
 I.D.: 3 15/64 (82.2)
 Thick: 9/64 (3.6)
 Furnished With: Various Filters
 Optional On: PT83, PT83-MPG, PT382, PF883

G251
Buna N Groove Gasket
 O.D.: 4 23/32 (119.9)
 I.D.: 4 7/16 (112.7)
 Thick: 1/8 (3.2)
 Optional On: PT63-1
 Replaces: John Deere B3586R

G252
Buna N Square Cut
Cover Gasket
 O.D.: 8 1/2 (215.9)
 I.D.: 7 31/32 (202.4)
 Thick: 17/64 (6.8)
 Furnished With: BK6310
 Optional On: PT475, P528, C704-L, C750-E, C750-L, C750-L SINGLE, P7040, F7500, P7500, P7500 SINGLE
 Fits: Late Model Cummins 500, 750 Housings; Some Fram 750 Housings
 Replaces: Cummins 164159; Fram 230820

G253-A
Fiber Gasket
 O.D.: 5 1/4 (133.4)
 I.D.: 3 1/2 (88.9)
 Thick: 1/16 (1.6)
 Furnished With: PT193 KIT
 Optional On: PT191, PT191-5, PT191-10

G255
Buna N Groove Gasket
 O.D.: 3 1/2 (88.9)
 I.D.: 3 7/32 (81.8)
 Thick: 3/32 (2.4)
 Furnished With: PT849, PT849-10

G257
Neoprene Fiber
Cover Gasket
 O.D.: 5 11/32 (135.7)
 I.D.: 4 51/64 (121.8)
 Thick: 1/16 (1.6)
 Furnished With: PF899

G260
Buna N Groove Gasket
 O.D.: 5 13/32 (137.3)
 I.D.: 5 7/32 (132.6)
 Thick: 3/32 (2.4)
 Furnished With: PT550-10
 Optional On: PT268
 Replaces: IHC 382247-R1



O.D.: 11 1/4 (285.8)
 I.D.: 9 9/16 (242.9)
 Thick: 1/32 (0.8)
 Optional On: PT268
 Replaces: IHC 382257-R1

G263
Buna N O-Ring
(Uniform Dash Number 433)
 O.D.: 6 1/32 (153.2)
 I.D.: 5 15/32 (138.9)
 Thick: 9/64 (3.6)
 Optional On: PT83, PT83-MPG, PT90, PT90-10, PT383, P996, P999, P999-HD, B1000-CD
 Fits: Early Base-Mount Nugent & Cummins Full-Flow Lube Housings
 Replaces: Cat 5H6733; Cummins 116024

G264-A
Buna N Groove Gasket
 O.D.: 3 41/64 (92.5)
 I.D.: 3 3/8 (85.7)
 Thick: 5/32 (4.0)
 Furnished With: B10-AL, B10-AL BSP, PF10, PF10-CS, PF967

G265
Buna N O-Ring
(Uniform Dash Number 257)
 O.D.: 6 9/64 (156.0)
 I.D.: 5 55/64 (148.8)
 Thick: 1/8 (3.2)
 Optional On: PT89, PT90-10, PT90-MPG, PT94
 Replaces: Cat 2K8257; Murphy MD8274

G268
Buna N Fiber Gasket
 O.D.: 3 49/64 (95.6)
 I.D.: 3 13/32 (86.5)
 Thick: 1/16 (1.6)
 Furnished With: P184

G269
Fiber Cover Gasket
with 6 Bolt Holes

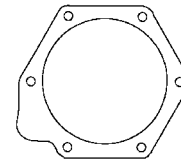

O.D.: 6 5/8 (168.3)
 I.D.: 5 1/2 (139.7)
 Thick: 1/32 (0.8)
 Optional On: P996, P999, P999-HD, B1000-CD
 Fits: Some Nugent & Cummins Upright Mount Full-Flow Lube Housings
 Replaces: Cummins 154443

G270
Buna N O-Ring
(Uniform Dash Number 233)
 O.D.: 3 9/64 (79.8)
 I.D.: 2 55/64 (72.6)
 Thick: 9/64 (3.6)
 Furnished With: PT265, PT273
 Optional On: PT66-HD
 Replaces: Cat 6H3977

G273
Buna N Groove Gasket
 O.D.: 4 33/64 (114.7)
 I.D.: 4 17/64 (108.4)
 Thick: 3/32 (2.4)
 Furnished With: PT185



WARNING: These products can expose you to chemicals, including Diisononyl Phthalate, Carbon black extracts, Nickel, 1,3 Butadiene, Ethylene Oxide, Epichlorohydrin, which are known to the State of California to cause cancer, and Bisphenol-A, Ethylene Glycol, Ethylene Oxide, 1,3 Butadiene, Epichlorohydrin, which are known to the State of California to cause birth defects or other reproductive harm. For more information go to www.P65Warnings.ca.gov.

G274
Cork Neoprene Cover Gasket
 O.D.: 3 1/2 (88.9)
 I.D.: 3 1/8 (79.4)
 Thick: 1/16 (1.6)
 Furnished With: PT210

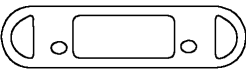
G275
Fiber Spool Gasket

 Size: 7 3/4 x 1 7/8 x 1/16
 (196.9 x 47.6 x 1.6)
 Fits: Later Model Nugent Spools using 2 Gaskets (Use G216 for Earlier Models)
 Replaces: Cummins 158019

G278
Buna N Cover Gasket
 O.D.: 5 5/8 (142.9)
 I.D.: 5 7/32 (132.6)
 Thick: 13/64 (5.2)
 Optional On: P999, P999-HD
 Fits: OB1368, Late Cummins Base-Mounted Full-Flow Lube Element-Type Housings
 Replaces: Cummins 153528, 254240

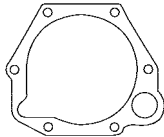
G280
Fiber Gasket
 O.D.: 5 1/64 (127.4)
 I.D.: 4 51/64 (121.8)
 Thick: 3/32 (2.4)
 Optional On: Various Filters

G281
Fiber Cover Gasket with 6 Bolt Holes

 O.D.: 6 5/8 (168.3)
 I.D.: 5 1/2 (139.7)
 Thick: 1/32 (0.8)
 Optional On: P996
 Fits: Some Nugent & Cummins Upright Mount Full-Flow Lube Housings
 Replaces: Cummins 169797

G283
Buna N O-Ring (Uniform Dash Number 232)
 O.D.: 3 1/64 (76.6)
 I.D.: 2 47/64 (69.5)
 Thick: 9/64 (3.6)
 Furnished With: PT542, PT8352
 Optional On: PT166-HD
 Replaces: Cat 5H8848

G285-AF
Sponge Boot
 O.D.: 14 3/8 (365.1)
 I.D.: 13 3/8 (339.7)
 Thick: 2 3/16 (55.6)
 Furnished With: PA2749
 Optional On: PA1975, PA2573, PA2574

G286-C
Buna N Molded Gasket
 O.D.: 5 1/32 (127.8)
 I.D.: 4 1/2 (114.3)
 Thick: 13/32 (10.3)
 Furnished With: Various Filters
 Optional On: Various Filters

G288
Cork Neoprene Cover Gasket with 6 Bolt Holes
 O.D.: 7 (177.8)
 I.D.: 5 1/8 (130.2)
 Thick: 1/16 (1.6)
 Furnished With: PT193 KIT
 Optional On: PT193, PT193-3

G289
Cork Neoprene Cover Gasket with 6 Bolt Holes
 O.D.: 9 5/8 (244.5)
 I.D.: 7 3/4 (196.9)
 Thick: 1/16 (1.6)
 Furnished With: PT193 KIT
 Optional On: PT193, PT193-3

G291
Buna N Molded Gasket
 O.D.: 5 1/64 (127.4)
 I.D.: 4 35/64 (115.5)
 Thick: 3/32 (2.4)
 Furnished With: PT386, PT436, PT571

G293-B
Buna N Molded Gasket
 O.D.: 4 41/64 (117.9)
 I.D.: 3 61/64 (100.4)
 Thick: 19/32 (15.1)
 Integral On: BD103, BD103-SS, BD324, B333, BD7309, BD7310

G296
Buna N Gasket
 O.D.: 5 13/32 (137.3)
 I.D.: 4 3/4 (120.7)
 Thick: 1/16 (1.6)
 Furnished With: P446
 Optional On: P450

G298-AF
Sponge Gasket
 O.D.: 11 49/64 (298.8)
 I.D.: 11 (279.4)
 Thick: 1/2 (12.7)
 Furnished With: PA2703

G299
Buna N Gasket
 O.D.: 4 (101.6)
 I.D.: 3 5/16 (84.1)
 Thick: 3/32 (2.4)
 Furnished With: PF967

G302
Buna N Groove Gasket
 O.D.: 4 41/64 (117.9)
 I.D.: 4 13/32 (111.9)
 Thick: 1/8 (3.2)
 Optional On: PF225
 Replaces: IHC 279781-R1

G303
Cork Buna N Cover Gasket with 2 Bolt Holes

 O.D.: 3 3/8 x 2 7/8 (85.7 x 73.0)
 I.D.: 1 13/16 (46.0)
 Thick: 1/16 (1.6)
 Optional On: PT88-HD
 Replaces: Hyster 119934

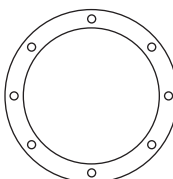
G304
Cork Buna N Cover Gasket with 8 Bolt Holes

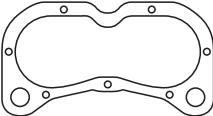
 O.D.: 7 1/4 (184.2)
 I.D.: 5 11/16 (144.5)
 Thick: 61/64 (24.2)
 Optional On: Hyster Applications using PT88-HD
 Replaces: Hyster 75670

G305
Buna N Fiber Gasket

 O.D.: 14 13/16 x 7 1/2 (376.2 x 190.5)
 I.D.: 12 15/16 (328.6)
 Thick: 1/32 (0.8)
 Optional On: PT380 KIT
 Notes: Used on Housings with Two Elements Side by Side

G306
Cork Neoprene Cover Gasket with 12 Bolt Holes

 O.D.: 8 x 16 (203.2 x 406.4)
 I.D.: 6 1/2 (165.1)
 Thick: 3/32 (2.4)
 Optional On: PT88-HD
 Replaces: Hyster 88106

G307
Buna N Groove Gasket
 O.D.: 5 33/64 (140.1)
 I.D.: 5 7/32 (132.6)
 Thick: 1/8 (3.2)
 Optional On: PT87-S, PT268, PT288-HD, PT288-HD10, PT498, PT498-10
 Replaces: Allis Chalmers 666244-9; John Deere R39596

G309-B
Buna N Molded Cover Gasket
 O.D.: 8 31/32 (227.8)
 I.D.: 8 15/32 (215.1)
 Thick: 15/64 (6.0)
 Furnished With: BK6221
 Optional On: P415 Series, C704-L, C750-E, C750-L, C750-L SINGLE, F7040, P7040, F7500, P7500, P7500 SINGLE
 Fits: Luber-finer 500C, 750C, 750-2C, 750-3C, 970C, 1000 Housings
 Replaces: Cummins 101853; Luber-finer 2788

G310
Buna N O-Ring (Uniform Dash Number 245)
 O.D.: 4 41/64 (117.9)
 I.D.: 4 23/64 (110.7)
 Thick: 9/32 (7.1)
 Furnished With: PT437
 Optional On: PT189, PT189-MPG, PT569-10
 Replaces: Cat 4H9105

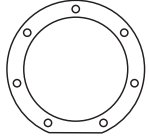
G314
Cork Neoprene Cover Gasket with 7 Bolt Holes

 O.D.: 8 5/8 (219.1)
 I.D.: 6 5/8 (168.3)
 Thick: 1/16 (1.6)
 Optional On: PT191, PT191-5, PT191-10, PT208
 Replaces: Clark 746525

PRODUCT GUIDE

 **WARNING:** These products can expose you to chemicals, including Diisononyl Phthalate, Carbon black extracts, Nickel, 1,3 Butadiene, Ethylene Oxide, Epichlorohydrin, which are known to the State of California to cause cancer, and Bisphenol-A, Ethylene Glycol, Ethylene Oxide, 1,3 Butadiene, Epichlorohydrin, which are known to the State of California to cause birth defects or other reproductive harm. For more information go to www.P65Warnings.ca.gov.

G315
Buna N O-Ring
(Uniform Dash Number 249)
 O.D.: 5 9/64 (130.6)
 I.D.: 4 55/64 (123.4)
 Thick: 9/64 (3.6)
Optional On: PT189, PT189-MPG, PT293

G323
Buna N Groove Gasket
 O.D.: 3 1/4 (82.6)
 I.D.: 3 3/32 (78.6)
 Thick: 1/8 (3.2)
Optional On: PT93, PT93-MPG, PF935
Fits: Cat 8H4681
Replaces: Cat 8H2778

G332
Buna N Gasket
 O.D.: 3 63/64 (101.2)
 I.D.: 3 43/64 (93.3)
 Thick: 1/8 (3.2)
Furnished With: PF950

G333
Buna N O-Ring
(Uniform Dash Number 244)
 O.D.: 4 33/64 (114.7)
 I.D.: 4 15/64 (107.6)
 Thick: 9/64 (3.6)
Optional On: PT61-HD, PT189, PT189-MPG
Replaces: Cat 2H3928

G336
Buna N Groove Gasket
 O.D.: 6 15/64 (158.4)
 I.D.: 5 53/64 (148.0)
 Thick: 13/64 (5.2)
Optional On: P20-HD, P999, P999-HD
Fits: OB1369; Base Mounted Full-Flow Lube Element-Type Housing Using Square-Cut Gasket
Replaces: Cummins 173368

G340
Copper Washer
 O.D.: 63/64 (25.0)
 I.D.: 51/64 (20.2)
 Thick: 3/64 (1.2)
Optional On: P20-HD

G342
Viton O-Ring
(Uniform Dash Number 248)
 O.D.: 5 1/64 (127.4)
 I.D.: 4 47/64 (120.3)
 Thick: 9/64 (3.6)
Optional On: PT189, PT189-MPG, PT207 Series, PT385, PT385-E, PT670, PT670-E
Replaces: Cat 5F3144

G343-A
Cork Neoprene Cover Gasket with 6 Bolt Holes

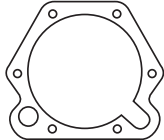

O.D.: 7 7/16 x 6 1/2 (188.9 x 165.1)
 I.D.: 5 1/2 (139.7)
 Thick: 1/16 (1.6)
Optional On: P999, P999-HD
Fits: Cummins Late Model Upright Mounted Full-Flow Lube Element-Type Housings
Replaces: Cummins 175133, 194982, 216003

G344
Buna N Groove Gasket
 O.D.: 3 9/16 (90.5)
 I.D.: 3 5/16 (84.1)
 Thick: 1/8 (3.2)
Furnished With: PF936, PF942, PF943
Optional On: PF810, PF906
Fits: Fram FCS1133PL, FSC1136M Housings
Replaces: Fram 101489

G347
Buna N O-Ring
(Uniform Dash Number 252)
 O.D.: 5 33/64 (140.1)
 I.D.: 5 15/64 (133.0)
 Thick: 9/64 (3.6)
Optional On: PT90-10, PT90-MPG
Replaces: Cat 2H9247

G348-AF
Gasket
 O.D.: 11 1/16 (281.0)
 I.D.: 10 3/16 (258.8)
 Thick: 7/16 (11.1)
Furnished With: PA2732

G354
Buna N O-Ring
(Uniform Dash Number 253)
 O.D.: 5 41/64 (143.3)
 I.D.: 5 23/64 (136.1)
 Thick: 9/64 (3.6)
Optional On: PT88-HD, PT90-10, P998
Replaces: Cat 2H3935; Cummins 193302

G356
Buna N Gasket
 O.D.: 7 3/64 (179.0)
 I.D.: 6 27/64 (163.1)
 Thick: 5/64 (2.0)
Optional On: PF116, P528
Fits: Fleetguard Housings with Stamped Cover and Mounting Brackets

G359
Buna N O-Ring
(Uniform Dash Number 260)
 O.D.: 6 49/64 (171.8)
 I.D.: 6 31/64 (164.7)
 Thick: 9/64 (3.6)
Optional On: PT191, PT191-5, PT191-10

G360
Buna N O-Ring
(Uniform Dash Number 259)
 O.D.: 6 31/64 (164.7)
 I.D.: 6 15/64 (158.4)
 Thick: 9/64 (3.6)
Optional On: PT89, PT90-10, PT90-MPG, PT94, PT268
Replaces: Cat 2K4472; IHC 343943-R1

G362
Buna N O-Ring
(Uniform Dash Number 251)
 O.D.: 5 25/64 (136.9)
 I.D.: 5 7/64 (129.8)
 Thick: 9/64 (3.6)
Optional On: P204, P204-HD, P204-HD10, PT268
Replaces: IHC 138466-R1, 390610-R1

G363
Buna N Gasket
 O.D.: 5 7/8 (149.2)
 I.D.: 5 3/8 (136.5)
 Thick: 1/16 (1.6)
Optional On: V24-A2, PF155
Fits: Luber-finer F170, F170-2 Housings
Replaces: Luber-finer 4041

G366
Buna N O-Ring
(Uniform Dash Number 238)
 O.D.: 3 3/4 (95.3)
 I.D.: 3 1/2 (88.9)
 Thick: 1/8 (3.2)
Furnished With: PT543 KIT
Optional On: PT480, PT480-10, PT480-MPG
Integral On: PT520, PT520-10, PT572-10

G368
Buna N O-Ring
(Uniform Dash Number 254)
 O.D.: 5 3/4 (146.1)
 I.D.: 5 15/32 (138.9)
 Thick: 9/64 (3.6)
Furnished With: PT379 KIT, PT487 KIT
Optional On: PT268
Replaces: IHC 285253-R1

G369-B
Buna N Groove Gasket
(with Blue Stripe)
 O.D.: 5 3/32 (129.4)
 I.D.: 4 45/64 (119.5)
 Thick: 3/16 (4.8)
Furnished With: BT389-10, BT9356
Optional On: Various Filters
Integral On: BT287-3

G369-V
Viton Gasket
 O.D.: 5 3/32 (129.4)
 I.D.: 4 45/64 (119.5)
 Thick: 3/16 (4.8)
Optional On: Various Filters

G372
Buna N Groove Gasket
(with Yellow Stripe)
 O.D.: 5 5/32 (131.0)
 I.D.: 4 47/64 (120.3)
 Thick: 13/64 (5.2)
Furnished With: BT287, BT389
Optional On: Various Filters
Fits: Use ONLY on Case Applications

G376
Buna N O-Ring
(Uniform Dash Number 242)
 O.D.: 4 17/64 (108.3)
 I.D.: 3 63/64 (101.2)
 Thick: 9/64 (3.6)
Furnished With: PT138-10, PT138-25
Optional On: PT66-HD, PT189, PT189-MPG
Replaces: Cat 1H6227

G379
Fiber Gasket
 O.D.: 3 13/32 (86.5)
 I.D.: 2 51/64 (71.0)
 Thick: 1/16 (1.6)
Optional On: PT135

G380
Buna N Groove Gasket
 O.D.: 5 41/64 (143.3)
 I.D.: 5 5/64 (129.0)
 Thick: 3/16 (4.8)
Optional On: PT152

G381-A
Buna N Groove Gasket
 O.D.: 2 13/16 (71.4)
 I.D.: 2 15/32 (62.7)
 Thick: 13/64 (5.2)
Integral On: Various Filters

G382
Buna N O-Ring
(Uniform Dash Number 263)
 O.D.: 7 33/64 (191.0)
 I.D.: 7 15/64 (183.8)
 Thick: 9/64 (3.6)
Optional On: PT491, PT491-10



WARNING: These products can expose you to chemicals, including Diisononyl Phthalate, Carbon black extracts, Nickel, 1,3 Butadiene, Ethylene Oxide, Epichlorohydrin, which are known to the State of California to cause cancer, and Bisphenol-A, Ethylene Glycol, Ethylene Oxide, 1,3 Butadiene, Epichlorohydrin, which are known to the State of California to cause birth defects or other reproductive harm. For more information go to www.P65Warnings.ca.gov.

<p>G382-V Viton O-Ring (Uniform Dash Number 263) O.D.: 7 33/64 (190.9) I.D.: 7 15/64 (183.8) Thick: 9/64 (3.6) Replaces: Cat 6V3907</p>	<p>G401 Buna N Groove Gasket O.D.: 2 13/16 (71.4) I.D.: 2 15/32 (62.7) Thick: 1/4 (6.4) Optional On: B378, B378-10 Integral On: Various Filters</p>	<p>G412 Buna N O-Ring (Uniform Dash Number 266) O.D.: 8 17/64 (209.9) I.D.: 7 63/64 (202.8) Thick: 9/64 (3.6) Optional On: PT98-10, PT98-MPG Replaces: Cat 1J2176</p>	<p>G434 Buna N Gasket O.D.: 4 1/16 (103.2) I.D.: 3 37/64 (90.9) Thick: 3/32 (2.4) Optional On: PT93, PT93-MPG Replaces: Cat 3J1991</p>
<p>G385 Buna N Groove Gasket O.D.: 4 49/64 (121.1) I.D.: 4 11/32 (110.3) Thick: 1/4 (6.4) Furnished With: PT467-MPG Optional On: PT207, PT207-10, PT207-HD, PT207-HD10, PT433 Fits: Gresen Line-Type Housings</p>	<p>G402 Buna N O-Ring (Uniform Dash Number 243) O.D.: 4 3/8 (111.1) I.D.: 4 1/8 (104.8) Thick: 1/8 (3.2) Furnished With: PT549 Optional On: P40, P176 Replaces: Cat 4M189</p>	<p>G416 Buna N O-Ring (Uniform Dash Number 438) O.D.: 6 25/64 (162.3) I.D.: 6 7/32 (158.0) Thick: 9/32 (7.1) Optional On: PT83, PT83-MPG, PT90-10, PT94 Replaces: Cat 5L5032</p>	<p>G435 Buna N Gasket O.D.: 4 1/8 (104.8) I.D.: 3 59/64 (99.6) Thick: 1/8 (3.2) Optional On: PT66-HD, PT670, PT670-E Replaces: Cat 5B5940</p>
<p>G386 Buna N Groove Gasket O.D.: 4 55/64 (123.4) I.D.: 4 29/64 (113.1) Thick: 13/64 (5.2) Optional On: PT207, PT207-10, PT207-HD, PT207-HD10, PT433 Fits: Gresen Line-Type Housings</p>	<p>G403 Buna N O-Ring (Uniform Dash Number 231) O.D.: 2 57/64 (73.4) I.D.: 2 39/64 (66.3) Thick: 9/64 (3.6) Furnished With: PT449 Optional On: PT189, PT189-MPG Replaces: Cat 8F8882</p>	<p>G417 Buna N O-Ring (Uniform Dash Number 427) O.D.: 5 9/32 (134.1) I.D.: 4 23/32 (119.9) Thick: 9/32 (7.1) Furnished With: PT573 Optional On: PT707-HD, PT707-HD3, PT707-HD10</p>	<p>G436 Buna N O-Ring O.D.: 3 11/16 (93.7) I.D.: 3 5/16 (84.1) Thick: 3/16 (4.8) Optional On: PT66-HD Replaces: Cat 6F8509</p>
<p>G392 Buna N Groove Gasket O.D.: 5 23/64 (136.1) I.D.: 4 61/64 (125.8) Thick: 13/64 (5.2) Furnished With: PT373 Optional On: PT207, PT207-10, PT207-HD, PT207-HD10, PT401-MPG, PT433 Fits: Massey Ferguson Hydraulic Filter Housings on 1100 Series Models Replaces: Massey Ferguson 366731X1; Dresser 932994-C2</p>	<p>G406 Buna N O-Ring (Uniform Dash Number 340) O.D.: 3 49/64 (95.6) I.D.: 3 11/32 (84.9) Thick: 13/64 (5.2) Optional On: PF814 Replaces: John Deere R41721</p>	<p>G422-AF Sponge Cover Gasket O.D.: 15 (381.0) I.D.: 13 (330.2) Thick: 1/4 (6.4) Optional On: LL2438, PA2438, LL2439, PA2439</p>	<p>G438 Buna N O-Ring (Uniform Dash Number 371) O.D.: 8 57/64 (225.8) I.D.: 8 15/32 (215.1) Thick: 13/64 (5.2) Optional On: PT98-10, PT98-MPG</p>
<p>G394 Buna N Groove Gasket O.D.: 5 27/32 (148.4) I.D.: 5 7/16 (138.1) Thick: 13/64 (5.2) Optional On: PT88-HD Replaces: Cat 8M4779</p>	<p>G409 Buna N Gasket O.D.: 6 11/32 (161.1) I.D.: 5 7/8 (149.2) Thick: 1/8 (3.2) Optional On: PT90-10, PT94 Replaces: Cat 4K1557</p>	<p>G431 Buna N Molded Gasket O.D.: 2 19/32 (65.9) I.D.: 2 5/16 (58.7) Thick: 19/64 (7.5) Optional On: P540, P540-S</p>	<p>G439 Buna N O-Ring (Uniform Dash Number 350) O.D.: 5 1/64 (127.4) I.D.: 4 19/32 (116.7) Thick: 13/64 (5.2) Optional On: P507, PT760-10, PT760-25</p>
<p>G397 Buna N Groove Gasket O.D.: 5 31/64 (139.3) I.D.: 5 15/64 (133.0) Thick: 1/8 (3.2) Furnished With: PT426 Optional On: PT87-S, PT288-HD, PT288-HD10, PT390-MPG, PT391-MPG, PT498, PT498-10</p>	<p>G410 Buna N O-Ring (Uniform Dash Number 241) O.D.: 4 9/64 (105.2) I.D.: 3 55/64 (98.0) Thick: 9/64 (3.6) Optional On: PT12, PT66-HD Replaces: Cat 2H3934</p>	<p>G432 Buna N O-Ring (Uniform Dash Number 237) O.D.: 3 5/8 (92.1) I.D.: 3 11/32 (84.9) Thick: 1/8 (3.2) Optional On: PT66-HD, PT93, PT93-MPG</p>	<p>G441 Buna N O-Ring (Uniform Dash Number 227) O.D.: 2 25/64 (60.3) I.D.: 2 7/64 (53.6) Thick: 9/64 (3.6) Optional On: PT88-HD Replaces: Cat 7F8268</p>
<p>G400 Buna N Groove Gasket O.D.: 6 31/32 (177.0) I.D.: 6 15/32 (164.3) Thick: 17/64 (6.7) Optional On: PT561 Replaces: John Deere T26990</p>	<p>G411 Buna N Gasket O.D.: 6 17/32 (165.9) I.D.: 6 3/64 (153.6) Thick: 1/8 (3.2) Optional On: PT90-10, PT94 Replaces: Cat 5J3172</p>	<p>G433 Buna N O-Ring (Uniform Dash Number 358) O.D.: 6 1/64 (152.8) I.D.: 5 19/32 (142.1) Thick: 13/64 (5.2) Optional On: PT83, PT83-MPG, PT90-10, PT189, PT189-MPG Replaces: Cat 6D9157</p>	<p>G442 Buna N O-Ring (Uniform Dash Number 235) O.D.: 3 25/64 (86.1) I.D.: 3 7/64 (79.0) Thick: 9/64 (3.6) Optional On: PT66-HD Replaces: Cat 2H6184</p>
			<p>G443 Buna N O-Ring (Uniform Dash Number 250) O.D.: 5 17/64 (133.7) I.D.: 4 63/64 (126.6) Thick: 9/64 (3.6) Optional On: PT90-10, PT189, PT268 Replaces: Cat 5F3106</p>



WARNING: These products can expose you to chemicals, including Diisononyl Phthalate, Carbon black extracts, Nickel, 1,3 Butadiene, Ethylene Oxide, Epichlorohydrin, which are known to the State of California to cause cancer, and Bisphenol-A, Ethylene Glycol, Ethylene Oxide, 1,3 Butadiene, Epichlorohydrin, which are known to the State of California to cause birth defects or other reproductive harm. For more information go to www.P65Warnings.ca.gov.

G444
Buna N O-Ring
(Uniform Dash Number 258)
O.D.: 6 17/64 (159.1)
I.D.: 5 63/64 (152.0)
Thick: 9/64 (3.6)
Optional On: PT88-HD, PT90-10
Replaces: Cat 8F8733

G445
Buna N O-Ring
(Uniform Dash Number 352)
O.D.: 5 17/64 (133.7)
I.D.: 4 27/32 (123.0)
Thick: 13/64 (5.2)
Furnished With: PF7680, PF7744
Optional On: PT189, PT189-MPG
Replaces: Cat 2S8439

G446
Buna N O-Ring
(Uniform Dash Number 432)
O.D.: 5 29/32 (150.0)
I.D.: 5 11/32 (135.7)
Thick: 9/32 (7.1)
Optional On: PT88-HD
Replaces: Cat 4F7507

G447
Buna N O-Ring
(Uniform Dash Number 246)
O.D.: 4 49/64 (121.0)
I.D.: 4 31/64 (113.9)
Thick: 9/64 (3.6)
Optional On: Various Filters
Replaces: Cat 5H6734

G449-B
Buna N Groove Gasket
O.D.: 2 51/64 (71.0)
I.D.: 2 15/32 (62.7)
Thick: 1/4 (6.4)
Integral On: Various Filters

G458
Buna N Groove Gasket
O.D.: 3 55/64 (98.0)
I.D.: 3 19/32 (91.3)
Thick: 9/64 (3.6)
Furnished With: PT377,
PT377-10, PF598, PF598-10,
PF598-30

G467
Buna N O-Ring
(Uniform Dash Number 140)
O.D.: 2 7/16 (61.9)
I.D.: 2 13/64 (56.0)
Thick: 7/64 (2.8)
Optional On: PF599, PF599-10,
PF599-30

G468
Buna N O-Ring
(Uniform Dash Number 156)
O.D.: 4 7/16 (112.7)
I.D.: 4 15/64 (107.6)
Thick: 7/64 (2.8)
Optional On: PF599, PF599-10,
PF599-30

G472-AF
Sponge Gasket
with 6 Bolt Holes
O.D.: 11 (279.4)
I.D.: 9 1/8 (231.8)
Thick: 1/4 (6.4)
Furnished With: PA2503
Optional On: LL2482, PA2482,
PA2531, PA2532
Fits: United Air Housing

G480
Buna N Groove Gasket
O.D.: 4 25/64 (111.5)
I.D.: 4 1/64 (102.0)
Thick: 3/16 (4.8)
Furnished With: PF312

G483
Buna N Groove Gasket
O.D.: 4 63/64 (126.6)
I.D.: 4 21/32 (118.3)
Thick: 3/16 (4.8)
Furnished With: BT345 KIT
Optional On: Various Filters

G494
Nitrile O-Ring
(Uniform Dash Number 351)
O.D.: 4 15/16 (125.4)
I.D.: 4 47/64 (120.3)
Thick: 7/32 (5.6)
Furnished With: PT777

G498-A
Buna N Groove Gasket
O.D.: 4 21/64 (109.9)
I.D.: 3 27/32 (97.6)
Thick: 3/8 (9.5)
Integral On: Various Spin-ons

G499-AF
Sponge Gasket
with 7 Bolt Holes
O.D.: 12 7/8 (327.0)
I.D.: 10 5/8 (269.9)
Thick: 3/8 (9.5)
Optional On: LL2312, PA2312,
PA2425, PA2430

G501-AF
Sponge Gasket
O.D.: 13 41/64 (346.5)
I.D.: 12 7/8 (327.0)
Thick: 1/2 (12.7)
Furnished With: PA2631, PA2632,
PA2729, RS3539

G523-AF
Closed Cell Sponge
Boot Gasket
O.D.: 13 11/32 (338.9)
I.D.: 13 3/16 (335.0)
Thick: 5/64 (2.0)
Attached To: LL2456, PA2456,
PA4566

G704
Buna N Gasket
O.D.: 4 63/64 (126.6)
I.D.: 4 3/8 (111.1)
Thick: 3/16 (4.8)
Optional On: Various Filters

G710
Buna N Gasket
O.D.: 5 3/64 (128.2)
I.D.: 4 45/64 (119.5)
Thick: 3/16 (4.8)
Optional On: Various Filters

G717
Buna N Gasket
O.D.: 5 9/16 (141.3)
I.D.: 5 7/32 (132.6)
Thick: 9/32 (7.1)
Optional On: PF7680 for use on
Webb Housings

G725
Buna N Gasket
O.D.: 4 15/16 (125.4)
I.D.: 4 19/32 (116.7)
Thick: 13/64 (5.2)
Optional On: BT389-10 When
Replacing Parker 927736

ES1001
Fiber Washer
O.D.: 7/8 (22.2)
I.D.: 9/16 (14.3)
Thick: 1/16 (1.6)
Furnished With: B4, F844-A,
BF938, BF939

ES1023
Buna N O-Ring
(Uniform Dash Number 037)
O.D.: 2 5/8 (66.7)
I.D.: 2 31/64 (63.5)
Thick: 1/16 (1.6)

ES1026
Steel Buna Dyna-Seal



O.D.: 1 5/16 (33.3)
I.D.: 3/4 (19.1)
Thick: 3/32 (2.4)
Furnished With: PT386, PT436,
PT571, PT777
Optional On: P999, P999-HD
Fits: Outer Center Bolt on Cummins
Full-Flow Lube Housings
Replaces: Cummins 208371

ES1030
Steel Buna N Dyna-Seal
O.D.: 4 1/16 (30.2)
I.D.: 5/8 (15.9)
Thick: 5/64 (2.0)
Furnished With: PT265, PT273,
PF7592
Optional On: PF935
Replaces: Cat 2A1162

ES1031
Buna N Grommet
O.D.: 1 7/8 (47.6)
I.D.: 1 3/64 (26.6)
Thick: 27/64 (10.7)

ES1032
Fiber Washer
O.D.: 1 1/16 (27.0)
I.D.: 3/4 (19.1)
Thick: 3/64 (1.2)
Furnished With: P20-HD
Optional On: PF902, PF902-S,
PF916

ES1034
Fiber Washer
O.D.: 3/4 (19.1)
I.D.: 1/2 (12.7)
Thick: 3/64 (1.2)
Furnished With: F845-A, PF845,
F916-C, PF916
Optional On: PF846

ES1036
Buna N O-Ring
(Uniform Dash Number 112)
O.D.: 11/16 (17.5)
I.D.: 31/64 (12.3)
Thick: 7/64 (2.8)
Furnished With: PF311, PF316,
PT437, PF861
Optional On: P116, PF116
Replaces: Cat 8F9206

ES1039
Nitrile Grommet
O.D.: 2 1/2 (63.5)
I.D.: 1 39/64 (40.9)
Thick: 7/16 (11.1)
Attached To: PT8517-MPG

ES1049
Buna N O-Ring Post Seal
(Uniform Dash Number 113)
O.D.: 3/4 (19.1)
I.D.: 35/64 (16.4)
Thick: 7/64 (2.8)
Furnished With: Various Filters
Optional On: PT90-10, PT189,
PT189-MPG, PF589-30
Replaces: Cat 6F4855



WARNING: These products can expose you to chemicals, including Diisononyl Phthalate, Carbon black extracts, Nickel, 1,3 Butadiene, Ethylene Oxide, Epichlorohydrin, which are known to the State of California to cause cancer, and Bisphenol-A, Ethylene Glycol, Ethylene Oxide, 1,3 Butadiene, Epichlorohydrin, which are known to the State of California to cause birth defects or other reproductive harm. For more information go to www.P65Warnings.ca.gov.

			NOTES
<p>ES1066 Fiber Washer O.D.: 57/64 (22.6) I.D.: 41/64 (16.3) Thick: 3/32 (2.4) Furnished With: F908-A Optional On: PF155 Fits: Head Screw Seal on Luber-finer F155C Housings Replaces: Luber-finer 2183</p>	<p>ES1092 Buna N Post Seal O.D.: 2 3/32 (53.2) I.D.: 1 23/32 (43.7) Thick: 1/4 (6.4) Furnished With: Various Filters</p>	<p>G1973 Fiber Transmission Pan Gasket Size: 12 5/8 x 8 5/8 (320.7 x 219.1) Optional On: 19739 Transmission Filters</p>	
<p>ES1067 Buna N O-Ring (Uniform Dash Number 212) O.D.: 1 9/64 (29.0) I.D.: 55/64 (21.8) Thick: 9/64 (3.6) Optional On: PT88-HD, P7040, F7500, P7500, P7500 SINGLE Fits: Caterpillar Housing Center Bolt; Cummins 500, 750 Model Housings T-Handle Replaces: Cat 3H107, 3H0107; Cummins 116029</p>	<p>ES1303-A Buna N Inner Adapter Seal O.D.: 3 5/32 (80.2) I.D.: 2 25/64 (60.7) Thick: 1/8 (3.2) Furnished With: OB1303</p>	<p>ES3012 Buna N O-Ring (Uniform Dash Number 222) O.D.: 1 49/64 (44.8) I.D.: 1 31/64 (37.7) Thick: 9/64 (3.6) Furnished With: BC110, PF7680, PF7687, PF7744, DAHL 150 Series</p>	
<p>ES1068 Buna N Post Seal O.D.: 1 1/32 (26.2) I.D.: 39/64 (15.5) Thick: 3/16 (4.8) Furnished With: F7500, P7500, Optional On: C704-L, C750 Series, F7040, P7040, P7500 SINGLE Fits: Baldwin & Luber-finer 500, 750 Model Housings T-Handle Replaces: Luber-finer 2145</p>	<p>ES1303-B Inner Adapter Seal O.D.: 3 5/32 (80.2) I.D.: 2 25/64 (60.7) Thick: 1/16 (1.6) Furnished With: OB1303</p>	<p>ES3028 Buna N O-Ring (Uniform Dash Number 214) O.D.: 1 17/64 (32.1) I.D.: 63/64 (25.0) Thick: 9/64 (3.6) Optional On: BT367, BT367-S</p>	
<p>ES1071 Copper Washer O.D.: 1 1/16 (27.0) I.D.: 49/64 (19.4) Thick: 3/64 (1.2) Furnished With: PT385 Optional On: P52</p>	<p>ES1369-A Inner Seal O.D.: 2 7/32 (56.4) I.D.: 1 11/16 (42.9) Thick: 13/64 (5.2) Furnished With: OB1369</p>	<p>ES3029 Fiber Housing Flat Seal O.D.: 3 3/4 (95.3) I.D.: 1 13/16 (46.0) Thick: 1/16 (1.6) Optional On: PT207, PT207-10, PT207-HD, PT207-HD10, PT373 Replaces: Gresen 1575</p>	
<p>ES1074 Buna N O-Ring (Uniform Dash Number 110) O.D.: 9/16 (14.3) I.D.: 23/64 (9.1) Thick: 7/64 (2.8) Optional On: PF155, PT189, PT189-MPG, P7053 Fits: Head Screw on Luber-finer F170 Housings Replaces: Cat 6F5559; Luber-finer 4190</p>	<p>ES1375 Bleed Plug Washer O.D.: 11/16 (17.5) I.D.: 17/32 (13.5) Thick: 1/16 (1.6) Furnished With: B7040A, B7500A Series Housings Optional On: C704-L, C750-E, C750-L, C750-L SINGLE, P7040, F7500, P7500, P7500 SINGLE</p>	<p>ES3063 Fiber Washer O.D.: 9/16 (14.3) I.D.: 21/64 (8.3) Thick: 3/64 (1.2) Furnished With: PF861 Optional On: BF825</p>	
<p>G1086-AF Buna N Seal O.D.: 5 1/8 (130.2) I.D.: 3 9/16 (90.5) Thick: 1/32 (0.8) Optional On: PA669 Replaces: Purolator 56979</p>	<p>ES1376 Bleed Plug Washer O.D.: 7/8 (22.2) I.D.: 5/8 (15.9) Thick: 1/16 (1.6) Optional On: C704-L, C750-E, C750-L, C750-L SINGLE, P7040, F7500, P7500, P7500 SINGLE</p>	<p>ES3231 Buna N O-Ring O.D.: 7 29/32 (202.2) I.D.: 7 29/64 (189.3) Thick: 7/32 (5.6) Optional On: PT8366</p>	
<p>ES1074 Buna N O-Ring (Uniform Dash Number 110) O.D.: 9/16 (14.3) I.D.: 23/64 (9.1) Thick: 7/64 (2.8) Optional On: PF155, PT189, PT189-MPG, P7053 Fits: Head Screw on Luber-finer F170 Housings Replaces: Cat 6F5559; Luber-finer 4190</p>	<p>ES1377 Bleed Plug Washer O.D.: 1 (25.4) I.D.: 11/16 (17.5) Thick: 1/16 (1.6) Optional On: C704-L, C750-E, C750-L, C750-L SINGLE, P7040, F7500, P7500, P7500 SINGLE</p>	<p>ES4007 Buna N Fiber End Seal O.D.: 3 15/16 (100.0) I.D.: 2 9/32 (57.9) Thick: 1/32 (0.8) Optional On: PT189, PT189-MPG Notes: Use with Stacked Elements</p>	
<p>G1972 Fiber Transmission Pan Gasket with 21 Bolt Holes Size: 19 x 13 (482.6 x 330.2) Furnished With: 18236, 19739, 19992</p>	<p>G1972 Fiber Transmission Pan Gasket with 21 Bolt Holes Size: 19 x 13 (482.6 x 330.2) Furnished With: 18236, 19739, 19992</p>	<p>ES4008 Buna N Fiber End Seal O.D.: 4 15/16 (125.4) I.D.: 3 15/16 (100.0) Thick: 1/32 (0.8) Optional On: PT83, PT83-MPG, PT88-HD, PT90-10, PT90-MPG, PT98-10, PT98-MPG Notes: Use with Stacked Elements</p>	

PRODUCT GUIDE

 **WARNING:** These products can expose you to chemicals, including Diisononyl Phthalate, Carbon black extracts, Nickel, 1,3 Butadiene, Ethylene Oxide, Epichlorohydrin, which are known to the State of California to cause cancer, and Bisphenol-A, Ethylene Glycol, Ethylene Oxide, 1,3 Butadiene, Epichlorohydrin, which are known to the State of California to cause birth defects or other reproductive harm. For more information go to www.P65Warnings.ca.gov.

Caterpillar Gaskets
Irregular Shaped Gaskets
for Cat Equipment

We use the Cat numbering system only for irregular-shaped gaskets which are used exclusively on Cat equipment.

1S-9133

Buna N Fiber Cover Gasket with 8 Bolt Holes

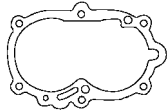

O.D.: 9 29/64 x 5 3/16
(240.1 x 131.8)
I.D.: 8 x 4 1/4 (203.2 x 108.0)
Thick: 1/32 (0.8)
Width: 29/64 (11.5)
Optional On: PF824

4L-8212-R

Buna N Fiber Cover Gasket with 4 Bolt Holes (Cat Number has No -R Suffix)

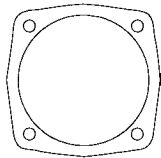

O.D.: 5 1/4 (133.4)
I.D.: 4 1/2 (114.3)
Thick: 1/16 (1.6)
Furnished With: PF823(6)

5H-5601

Buna N Fiber Cover Gasket with 6 Bolt Holes

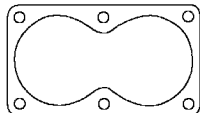

O.D.: 8 1/8 x 4 9/16
(206.4 x 115.9)
I.D.: 7 3/8 x 3 3/4
(187.3 x 95.3)
Thick: 1/32 (0.8)
Width: 13/32 (10.3)
Furnished With: PF823(2)

5M-954

Buna N Fiber Cover Gasket with 4 Bolt Holes

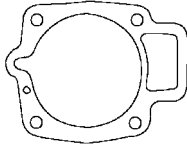

O.D.: 6 3/16 (157.2)
I.D.: 3 3/4 (95.3)
Thick: 1/16 (1.6)
Furnished With: PF824

6L-1540

Buna N Fiber Cover Gasket with 6 Bolt Holes

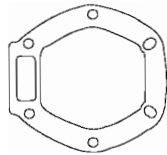

O.D.: 9 1/8 (231.8)
I.D.: 6 1/16 (154.0)
Thick: 1/32 (0.8)

7B-7635

Buna N Fiber Cover Gasket with 5 Bolt Holes

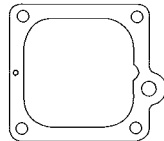

O.D.: 6 1/32 (153.2)
I.D.: 4 9/32 (108.7)
Thick: 1/32 (0.8)

8M-7830

Buna N Fiber Cover Gasket with 7 Bolt Holes

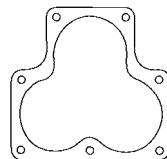

O.D.: 8 1/8 (206.4)
Thick: 1/32 (0.8)
Furnished With: PF823(3)

NOTES

NOTES



WARNING: These products can expose you to chemicals, including Diisononyl Phthalate, Carbon black extracts, Nickel, 1,3 Butadiene, Ethylene Oxide, Epichlorohydrin, which are known to the State of California to cause cancer, and Bisphenol-A, Ethylene Glycol, Ethylene Oxide, 1,3 Butadiene, Epichlorohydrin, which are known to the State of California to cause birth defects or other reproductive harm. For more information go to www.P65Warnings.ca.gov.

DAHL DIESEL FUEL FILTER/WATER SEPARATORS REMOVE DIESEL FUEL SYSTEM PROBLEMS ALONG WITH WATER

Water and solid contaminants displace the diesel fuel's lubricative coating on high precision injection components. The loss of this protection results in wear, erosion, surface pitting and eventual pressure loss.

Many existing fuel filters aren't designed to remove significant amounts of water. They are designed to do their job in a single step. This means they must be porous enough to allow sufficient flow volume which, in turn, limits filtering ability to between 10 and 30 microns. Any tighter media would plug too quickly and result in frequent element changes.

The DAHL system takes care of those shortcomings. DAHL's functional dual-chamber 3-stage diesel fuel filter/water separators provide efficient suction side water separation and contaminant filtration. The key is the unique DAHL patented depressurizer cone which spreads the flow of the fuel. With more area to flow over, greater separation of water and dirt from the fuel is achieved.

DAHL diesel fuel filter/water separators have less mechanical flow resistance than other separators, because the fuel changes direction only twice. The DAHL unit removes virtually 100% of the water and most of the contaminants from the diesel fuel.

Why DAHL Is Right For Your Diesel Equipment

1. The DAHL system eliminates water from fuel before reaching the fuel pump and injectors. This prevents the major cause of diesel fuel injection system failure.
 - a. It prolongs system life by eliminating pump and injector overhauls caused by water contaminated fuel. The cost of shop labor alone, just to repair the injection system on a 6-cylinder rig, exceeds the cost of the DAHL diesel fuel filter/water separator.
 - b. It reduces the need to repair the fuel pump and/or injectors that could easily tie up equipment for one or two days. The loss of income in just a few hours of equipment downtime again would pay for a DAHL diesel fuel filter/water separator.
2. The DAHL system separates solid contaminants from the fuel before reaching the fuel pump and injectors.
3. The DAHL system is easily installed.
 - a. Install it at any location before the fuel pump. (Complete installation instructions are included with each DAHL unit.)
 - b. This system can replace all other primary filters and water separators. It both filters and separates.
 - c. It takes minimal space to install. Clearance space for element removal is between 1 1/2 to 3 1/2 inches. Some models are installed with as few as two easily accessed bolts.
4. The DAHL system is easily serviced.
 - a. Models 150, 200 and 300 are serviced by loosening the T-Bolt handle. They also feature a self-ejecting element.
 - b. The transparent bowl (up to 24 ounce water capacity) makes constant draining unnecessary. The draincock is easy to use. An aluminum bowl is also available.
5. Most of the solid contaminants are separated by the patented depressurizer cone in the bowl BEFORE reaching the filter element. Another factor resulting in less frequent changes is the extra paper in the filter element. Under normal conditions, the element can last up to 40,000 miles.
6. The DAHL system includes a reverse flow valve. This holds the prime in the fuel system by not allowing flow back to the tank during shut-down. (Removable primer plug at top assists where complete priming is required.)
7. The DAHL system helps eliminate air entrapment because the inlet and outlet ports are at the top of the unit. The fuel changes directions only twice (see flow diagram), and so offers less mechanical resistance. Less resistance means longer pump and element life.

PROVEN PERFORMANCE in the laboratory and in millions of miles/hours of commercial and industrial operation. You can be sure that each DAHL unit is designed right, built right and does its job right.

CLEAN FUEL provided by a DAHL diesel fuel filter/water separator eliminates nearly all of the engine problems caused by water and solid contaminants in diesel fuel. In addition, you can expect:

- Longer Injection System Component Life
- Full Power Performance
- Lower Element Replacement Cost



WARNING: These products can expose you to chemicals, including Diisononyl Phthalate, Carbon black extracts, Nickel, 1,3 Butadiene, Ethylene Oxide, Epichlorohydrin, which are known to the State of California to cause cancer, and Bisphenol-A, Ethylene Glycol, Ethylene Oxide, 1,3 Butadiene, Epichlorohydrin, which are known to the State of California to cause birth defects or other reproductive harm. For more information go to www.P65Warnings.ca.gov.

Here's How The DAHL System Works

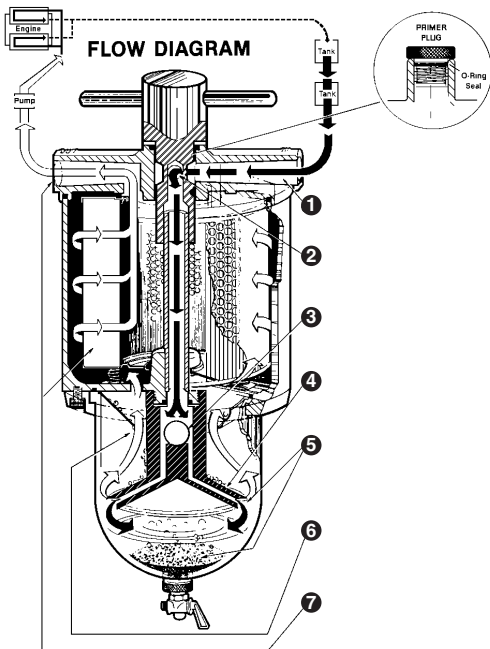

1. The contaminated fuel enters the inlet port.
2. The T-Bolt redirects the fuel downward through the centerpipe.
3. Fuel flows through the reverse flow valve.
4. Fuel flow is spread by the depressurizer cone.
5. As fuel is discharged from the depressurizer cone, 80% of contaminant separation takes place. Most of the solid particles and water settle into the quiet zone of the bowl.
6. As the fuel rises upward, any remaining minute water droplets coalesce on the cone, baffle and bowl surfaces. Droplet size and weight gradually increase, causing downward flow into the sump.
7. Fuel is filtered completely by the element, which contains HydroShield™ media. The clean fuel then continues upward through the outlet port and on to the pump and injection system.

How To Select The Right DAHL Filter

Choose the size which can accommodate the flow rate recommended in the chart. (Maximum flow rate listed is for convenience in comparing with other systems only.) For most efficient separation and filtration, select from the recommended column.

Flow Rates in Gallons Per Hour

The chart is for Fuel/Water Separators. Recyclers are limited by the pump. For example, a single 300 recycler unit has a flow rate limited to 180 GPH (U.S.), and a double 300 recycler unit has a flow rate limited to 360 GPH (U.S.).

Flow Rates

GPH (U.S.)

Model Series	Recommended	Maximum	Sump Capacity
65 & 75	20	30	4 oz.
100	40	65	8 oz.
100 Double	80	130	16 oz.
150	80	100	8 oz.
150 Double	160	200	16 oz.
200	120	200	24 oz.
200 Double	240	400	48 oz.
300	180	325	24 oz.
300 Double	360	650	48 oz.
300 Triple	540	975	72 oz.
500	1800	1920	11 Gallons
500 Double	3600	3840	22 Gallons
All Multiple Units	Multiply Flow Rate and Sump Capacity by Number of Units		

Superior Engineering

- Die cast aluminum
- Impact-resistant large transparent bowl
- Element service life is several times longer than conventional
- Easy to install, service and clean
- Positive air elimination
- Advanced spring design assures positive element seal
- Less mechanical resistance because of streamlined flow path
- Baffle system is designed to stop emulsification and disperse trapped air
- Ball check valve to stop reverse flow
- Six series specifically designed to fit diesel engines of various capacities



WARNING: These products can expose you to chemicals, including Diisononyl Phthalate, Carbon black extracts, Nickel, 1,3 Butadiene, Ethylene Oxide, Epichlorohydrin, which are known to the State of California to cause cancer, and Bisphenol-A, Ethylene Glycol, Ethylene Oxide, 1,3 Butadiene, Epichlorohydrin, which are known to the State of California to cause birth defects or other reproductive harm. For more information go to www.P65Warnings.ca.gov.

65 & 75 Series Compact Fuel Filter/Water Separators



MODEL 65
Diesel Fuel
Filter/Water Separator



MODEL 75
Gasoline or Diesel Fuel
Filter/Water Separator with Aluminum Bowl

Specifications

- **Flow Resistance:**.....0.75 In. Mercury
- **Maximum Working Pressure:**.....25 PSI (172 kPa)
- **Temperature Range:**-50° to +225°F (-45° to +107°C)
- **Port Thread:**9/16-18 w/O-Ring Boss
- **Height / 65:**.....6 3/8 In. (161.9 mm)
- **Height / 75:**.....6 1/8 In. (155.6 mm)
- **Width:**.....4 3/16 In. (106.4 mm)
- **Depth:**.....4 3/4 In. (120.6 mm)
- **Element Removal Clearance:**.....3 1/2 In. (88.9 mm)
- **Sump Capacity:**.....4 oz. (118 ml)

Flow Rates

- **Model 65 & 75 Series:**
Recommended:.....20 GPH (U.S.) (75.7 LPH)
Maximum:.....30 GPH (U.S.) (113.5 LPH)

Service Parts

- **Elements:**
 - 61(For Use on Model 60)
 - 61-W(For Use on Model 60)
 - 66*(For Use on Models 65 & 75)
 - 66-W(For Use on Models 65 & 75)
 - 66-30(For Use on Models 65, 65-W30 & 75, 75-W30)
- **Gaskets:**
 - 60-GK.....Complete Gasket Kit for 60, 65 & 75
(See Accessories Page)
- **Form 4060:**
Installation, Operation, Parts & Service Information

65 & 75 Series Single Units

- 65** Diesel Fuel Filter/Water Separator
- 65-W30** Diesel Fuel Filter/Water Separator — 9 Micron Nominal (40 Absolute) Element
- 75** Gasoline or Diesel Fuel Filter/Water Separator with Aluminum Bowl
- 75-W30** Gasoline or Diesel Fuel Filter/Water Separator with Aluminum Bowl — 9 Micron Nominal (40 Absolute) Element

Accessories

All Inlet & Outlet Fittings Require O-Ring Seals
Fittings.....See DAHL Fittings Chart

Used On

- 65 & 75 — Small Diesel Engines Where Space is Limited
- 75 — Small Gasoline Engines & Marine Applications
- Cars & Light-Duty Trucks

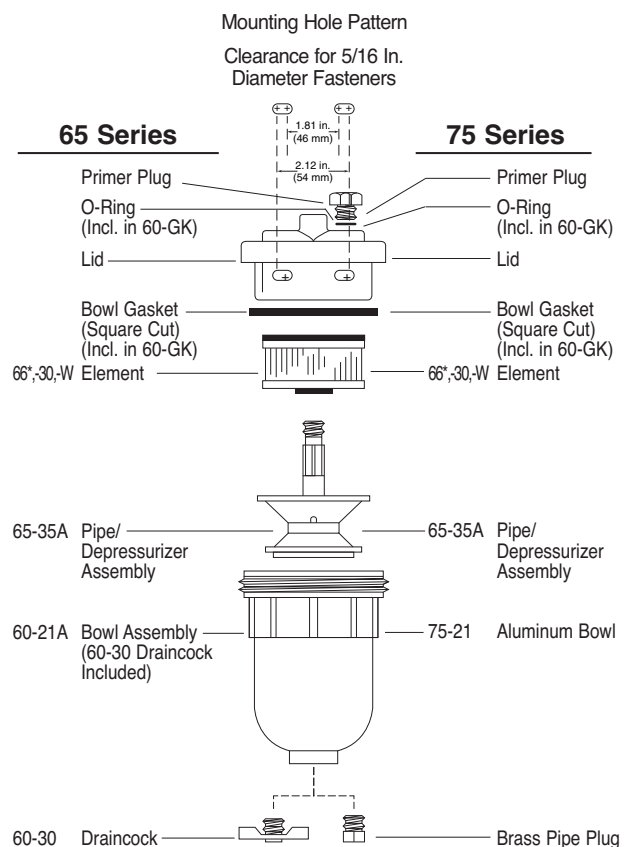

* Standard with Unit Unless Stated.



WARNING: These products can expose you to chemicals, including Diisononyl Phthalate, Carbon black extracts, Nickel, 1,3 Butadiene, Ethylene Oxide, Epichlorohydrin, which are known to the State of California to cause cancer, and Bisphenol-A, Ethylene Glycol, Ethylene Oxide, 1,3 Butadiene, Epichlorohydrin, which are known to the State of California to cause birth defects or other reproductive harm. For more information go to www.P65Warnings.ca.gov.

100 Series Diesel Fuel Filter/Water Separators



MODEL 100
Diesel Fuel Filter/Water Separator



MODEL 100-M
Marine Diesel Fuel Filter/Water Separator



MODEL 100-MFV
Double Manifold Diesel Fuel Filter/Water Separator
with Shut-Off Valves for Continuous Operation



MODEL 100-MMV
Double Marine Manifold Diesel Fuel Filter/Water Separator
with Shut-Off Valves for Continuous Operation

Specifications

- **Flow Resistance:**0.75 In. Mercury
- **Maximum Working Pressure:**.....25 PSI (172 kPa)
- **Temperature Range:**-50° to +225°F (-45° to +107°C)
- **Port Thread:**
Single Units:9/16-18 w/O-Ring Boss
Double Units:.....1/4-18 NPT
- **Height:**.....12 1/2 In. (317.5 mm)
- **Width:**.....5 1/2 In. (139.7 mm)
- **Depth:**.....6 1/2 In. (165.1 mm)
- **Element Removal Clearance:**.....1 1/2 In. (38.1 mm)
- **Sump Capacity:**8 oz. (236 ml)

Flow Rates

- **Single Model 100 Series:**
Recommended:.....40 GPH (U.S.) (151 LPH)
Maximum:65 GPH (U.S.) (246 LPH)
- **Double Model 100 Series:**
Recommended:.....80 GPH (U.S.) (302 LPH)
Maximum:130 GPH (U.S.) (492 LPH)

Service Parts

- **Elements:**
101*4 Micron Nominal (20 Absolute) Element
101-W.....5 Micron Nominal (25 Absolute) Element
101-30.....9 Micron Nominal (40 Absolute) Element
- **Gaskets:**
100-GK.....Complete Gasket Kit (See Accessories Page)
- **Kits:**
100-DEPR KITDepressurizer Kit (See Accessories Page)
100-MNTG KITMounting Bracket Kit
(See Accessories Page)
- **Form 4100:**
Installation, Operation, Parts & Service Information
- **Form 4123:**
Marine Installation, Operation, Parts & Service Information

Used On

- Small Diesel Engines Up to Approx. 200 HP (Except Cummins & Detroit Diesel Engines)
- Cars, Light-Duty Trucks & RV's
- Small Pleasure Crafts & Sailboats
- Caterpillar Engines Thru 3300 Series
- Small Generators & Farm Tractors
- Refrigeration Units
- 5.7L & 6.2L GMC Engines

* Standard with Unit Unless Stated.



WARNING: These products can expose you to chemicals, including Diisononyl Phthalate, Carbon black extracts, Nickel, 1,3 Butadiene, Ethylene Oxide, Epichlorohydrin, which are known to the State of California to cause cancer, and Bisphenol-A, Ethylene Glycol, Ethylene Oxide, 1,3 Butadiene, Epichlorohydrin, which are known to the State of California to cause birth defects or other reproductive harm. For more information go to www.P65Warnings.ca.gov.

100 Series Diesel Fuel Filter/Water Separators (Cont'd.)

Accessories

All Inlet & Outlet Fittings Require O-Ring Seals

Aluminum Bowl	100-21AL
Clear Bowl w/Water Sensor Probes	100-21BP
Clear Bowl w/Heater Probes	100-21H
Clear Bowl w/Marine Collar for Marine Units	100-21M
Fittings.....	See DAHL Fittings Chart
Heat Deflector Shield for Marine Units.....	185-DS
Heater Kit...See Accessories Page (Heater Kits & Heater Parts)	
Shock Pad Mounting Kit	186-SK
Water Sensor Warning Light Kit (Use with 100-21BP)	
24 Volt DC	24-WLK

100 Series Single Units

100	Diesel Fuel Filter/Water Separator
100-BP	Diesel Fuel Filter/Water Separator with Water Sensor Bowl Probes — Order Warning Light Kit separately.
100-H	Diesel Fuel Filter/Water Separator with In-Filter Heater — Dash-Mounted Toggle Switch included. Operates on either 12 or 24 Volt systems. — 5 Micron Nominal (25 Absolute) Element
100-M	Marine Diesel Fuel Filter/Water Separator
100-W	Diesel Fuel Filter/Water Separator — 5 Micron Nominal (25 Absolute) Element
100-W30	Diesel Fuel Filter/Water Separator — 9 Micron Nominal (40 Absolute) Element

100 Series Double Manifold Units

100-MFV Two Diesel Fuel Filter/Water Separators Manifolded with Shut-Off Valves — Allows continuous operation while servicing.

100-MMV Two Marine Diesel Fuel Filter/Water Separators Manifolded with Shut-Off Valves — Allows continuous operation while servicing.

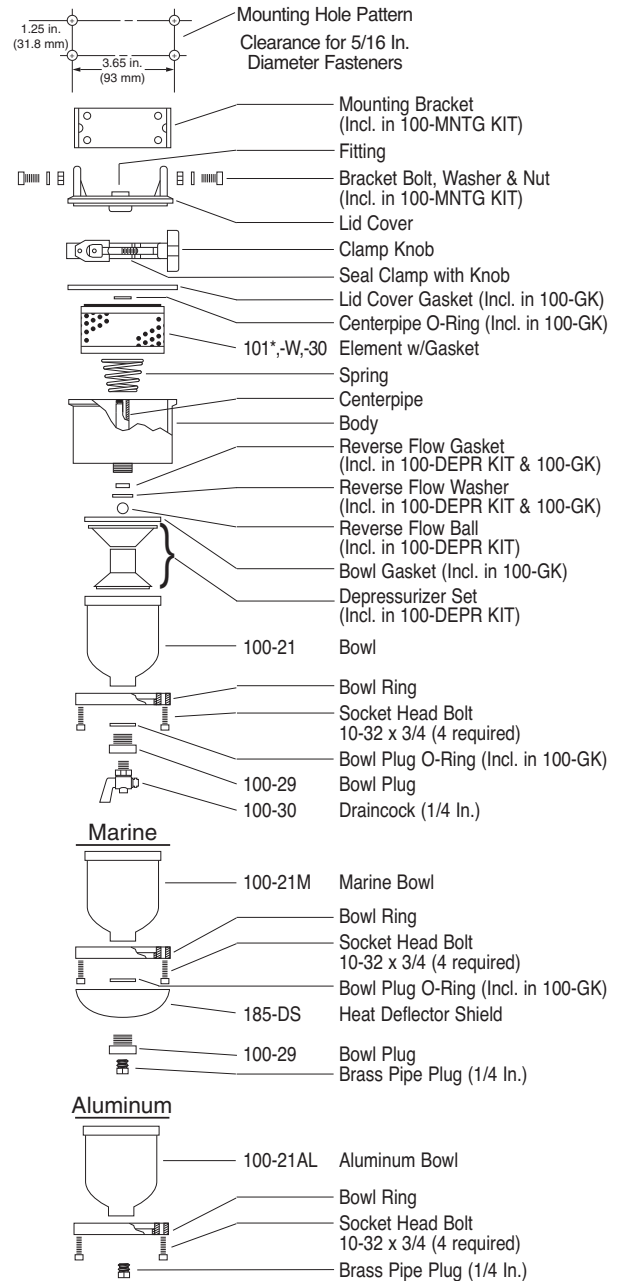

* Standard with Unit Unless Stated.



WARNING: These products can expose you to chemicals, including Diisononyl Phthalate, Carbon black extracts, Nickel, 1,3 Butadiene, Ethylene Oxide, Epichlorohydrin, which are known to the State of California to cause cancer, and Bisphenol-A, Ethylene Glycol, Ethylene Oxide, 1,3 Butadiene, Epichlorohydrin, which are known to the State of California to cause birth defects or other reproductive harm. For more information go to www.P65Warnings.ca.gov.

150 Series Diesel Fuel Filter/Water Separators



MODEL 150
Diesel Fuel Filter/Water Separator



MODEL 150-M
Marine Diesel Fuel Filter/Water Separator

Specifications

- **Flow Resistance:**0.75 In. Mercury
- **Maximum Working Pressure:**.....25 PSI (172 kPa)
- **Temperature Range:**-50° to +225°F (-45° to +107°C)
- **Port Thread:**
Single Units:7/8-14 w/O-Ring Boss
Double Units:.....3/4-14 NPT
- **Height:**.....14 1/4 In. (368.3 mm)
- **Width:**6 In. (152.4 mm)
- **Depth:**6 11/32 In. (161.1 mm)
- **Element Removal Clearance:**.....2 In. (50.8 mm)
- **Sump Capacity:**8 oz. (236 ml)

Flow Rates

- **Single Model 150 Series:**
Recommended:.....80 GPH (U.S.) (302 LPH)
Maximum:100 GPH (U.S.) (378 LPH)
- **Double Model 150 Series:**
Recommended:.....160 GPH (U.S.) (604 LPH)
Maximum:200 GPH (U.S.) (757 LPH)

Service Parts

- **Elements:**
151*4 Micron Nominal (20 Absolute) Element
151-W.....5 Micron Nominal (25 Absolute) Element
151-30.....9 Micron Nominal (40 Absolute) Element
- **Gaskets:**
150-GK.....Complete Gasket Kit (See Accessories Page)
- **Kits:**
100-DEPR KIT.....Depressurizer Kit (See Accessories Page)
- **Form 4025:**..... Installation, Operation,
Parts & Service Information
- **Form 4123:**.....Marine Installation, Operation,
Parts & Service Information

* Standard with Unit Unless Stated.



WARNING: These products can expose you to chemicals, including Diisononyl Phthalate, Carbon black extracts, Nickel, 1,3 Butadiene, Ethylene Oxide, Epichlorohydrin, which are known to the State of California to cause cancer, and Bisphenol-A, Ethylene Glycol, Ethylene Oxide, 1,3 Butadiene, Epichlorohydrin, which are known to the State of California to cause birth defects or other reproductive harm. For more information go to www.P65Warnings.ca.gov.

150 Series Diesel Fuel Filter/Water Separators (Cont'd.)

Accessories

All Inlet & Outlet Fittings Require O-Ring Seals

Aluminum Bowl	100-21AL
Clear Bowl w/Water Sensor Probes	100-21BP
Clear Bowl w/Heater Probes	100-21H
Clear Bowl w/Marine Collar for Marine Units	100-21M
Fittings.....	See DAHL Fittings Chart
Heat Deflector Shield for Marine Units.....	185-DS
Heater Kit...See Accessories Page (Heater Kits & Heater Parts)	
Shock Pad Mounting Kit	286-SK
Water Sensor Warning Light Kit (Use with 100-21BP)	
24 Volt DC	24-WLK

150 Series Units

150	Diesel Fuel Filter/Water Separator
150-H	Diesel Fuel Filter/Water Separator with In-Filter Heater—Dash-Mounted Toggle Switch included. Operates on either 12 or 14 Volt systems. — 5 Micron Nominal (25 Absolute) Element
150-M	Marine Diesel Fuel Filter/Water Separator
150-W30	Diesel Fuel Filter/Water Separator — 9 Micron Nominal (40 Absolute) Element

Used On

- Small & Medium Size Heavy-Duty Diesel Engines (Up to Approx. 450 HP)
- Large Farm Tractors
- Detroit Diesel (53 & Small 71 Series)
- Some Cummins Six Cylinder Engines

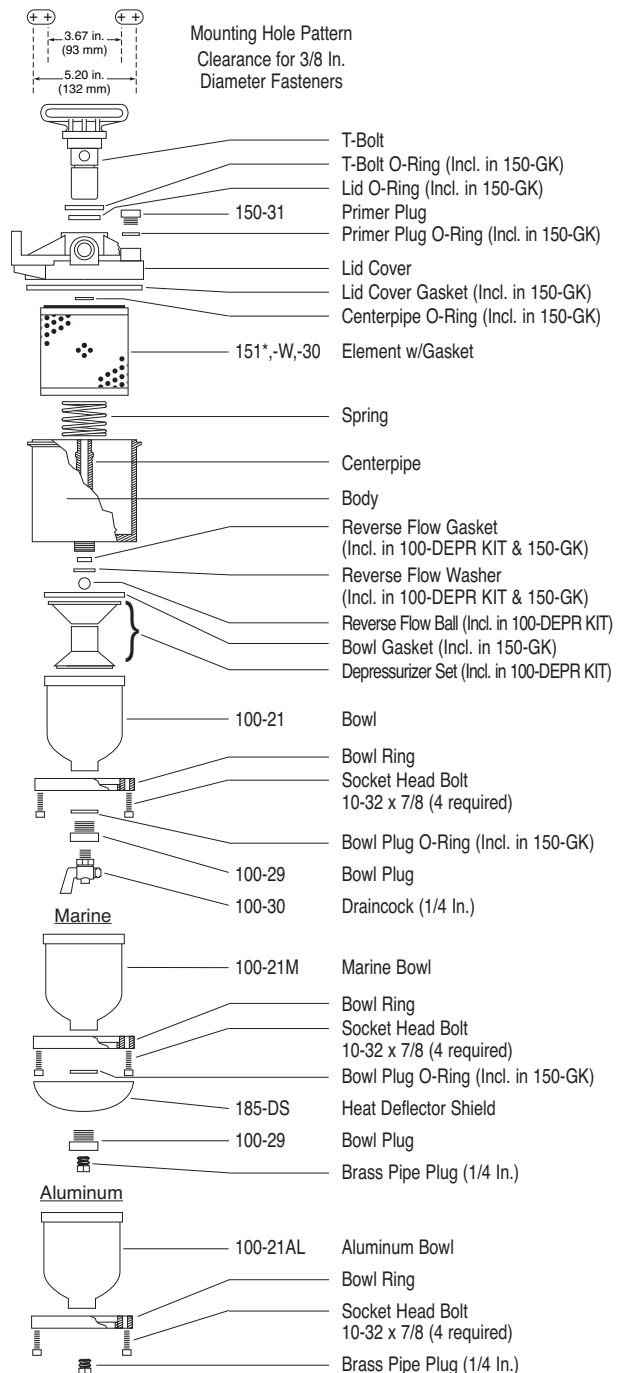

* Standard with Unit Unless Stated.



WARNING: These products can expose you to chemicals, including Diisononyl Phthalate, Carbon black extracts, Nickel, 1,3 Butadiene, Ethylene Oxide, Epichlorohydrin, which are known to the State of California to cause cancer, and Bisphenol-A, Ethylene Glycol, Ethylene Oxide, 1,3 Butadiene, Epichlorohydrin, which are known to the State of California to cause birth defects or other reproductive harm. For more information go to www.P65Warnings.ca.gov.

200 Series Diesel Fuel Filter/Water Separators



MODEL 200
Diesel Fuel Filter/Water Separator



MODEL 200-M
Marine Diesel Fuel Filter/Water Separator



MODEL 200-MFV
Double Manifold Diesel Fuel Filter/Water Separator
with Shut-Off Valves for Continuous Operation



MODEL 200-MMV
Double Marine Manifold Diesel Fuel Filter/Water Separator
with Shut-Off Valves for Continuous Operation

Specifications

- **Flow Resistance:**1.0 In. Mercury
- **Maximum Working Pressure:**.....25 PSI (172 kPa)
- **Temperature Range:**-50° to +225°F (-45° to +107°C)
- **Port Thread:**
Single Units:7/8-14 w/O-Ring Boss
Double Units:.....3/4-14 NPT
- **Height:**16 3/4 In. (425.5 mm)
- **Width:**7 1/2 In. (190.5 mm)
- **Depth:**7 3/4 In. (196.9 mm)
- **Element Removal Clearance:**.....2 1/2 In. (63.5 mm)
- **Sump Capacity:**24 oz. (708 ml)
- **Top to Inlet Clearance:**2 5/8 In. (66.7 mm)
- **Top to Outlet Clearance:**2 5/8 In. (66.7 mm)

Flow Rates

- **Single Model 200 Series:**
Recommended:.....120 GPH (U.S.) (454 LPH)
Maximum:200 GPH (U.S.) (757 LPH)
- **Double Model 200 Series:**
Recommended:.....240 GPH (U.S.) (908 LPH)
Maximum:400 GPH (U.S.) (1,514 LPH)

Service Parts

- **Elements:**
201*4 Micron Nominal (20 Absolute) Element
201-W.....5 Micron Nominal (25 Absolute) Element
201-309 Micron Nominal (40 Absolute) Element
- **Gaskets:**
200-GK.....Complete Gasket Kit (See Accessories Page)
- **Kits:**
200-DEPR KITDepressurizer Kit (See Accessories Page)
- **Form 4230:**
Installation, Operation, Parts & Service Information
- **Form 4123:**
Marine Installation, Operation, Parts & Service Information

* Standard with Unit Unless Stated.



WARNING: These products can expose you to chemicals, including Diisononyl Phthalate, Carbon black extracts, Nickel, 1,3 Butadiene, Ethylene Oxide, Epichlorohydrin, which are known to the State of California to cause cancer, and Bisphenol-A, Ethylene Glycol, Ethylene Oxide, 1,3 Butadiene, Epichlorohydrin, which are known to the State of California to cause birth defects or other reproductive harm. For more information go to www.P65Warnings.ca.gov.

200 Series Diesel Fuel Filter/Water Separators (Cont'd.)

Accessories

All Inlet & Outlet Fittings Require O-Ring Seals

Aluminum Bowl	200-21AL
Clear Bowl w/Water Sensor Probes	200-21BP
Clear Bowl w/Heater Probes	200-21H
Clear Bowl w/Water Sensor & Heater Probes	200-21HBP
Clear Bowl w/Marine Collar for Marine Units	200-21M
Fittings.....	See DAHL Fittings Chart
Heat Deflector Shield for Marine Units.....	285-DS
Heater Kit...See Accessories Page (Heater Kits & Heater Parts)	
Shock Pad Mounting Kit	286-SK
Water Sensor Warning Light Kit (Use with 200-21BP)	
24 Volt DC	24-WLK

200 Series Single Units

200	Diesel Fuel Filter/Water Separator
200-H	Diesel Fuel Filter/Water Separator with In-Filter Heater — Operates on either 12 or 24 Volt systems — 5 Micron Nominal (25 Absolute) Element
200-M	Marine Diesel Fuel Filter/Water Separator
200-W30	Diesel Fuel Filter/Water Separator — 9 Micron Nominal (40 Absolute) Element

200 Series Double Manifold Units

200-MFV	Two Diesel Fuel Filter/Water Separators Manifolded with Shut-Off Valves — Allows continuous operation while servicing.
200-MMV	Two Marine Diesel Fuel Filter/Water Separators Manifolded with Shut-Off Valves — Allows continuous operation while servicing.

Used On

- 8 Cylinder Cummins & Detroit Diesel Engines
- Caterpillar Engines up to Approximately 1,000 HP (Including 399)
- Most Other Medium Size Diesel Engines up to Approximately 1,000 HP
- Trucks & Buses
- Construction & Farm Equipment
- Medium Size Generators
- Smaller Commercial Boats

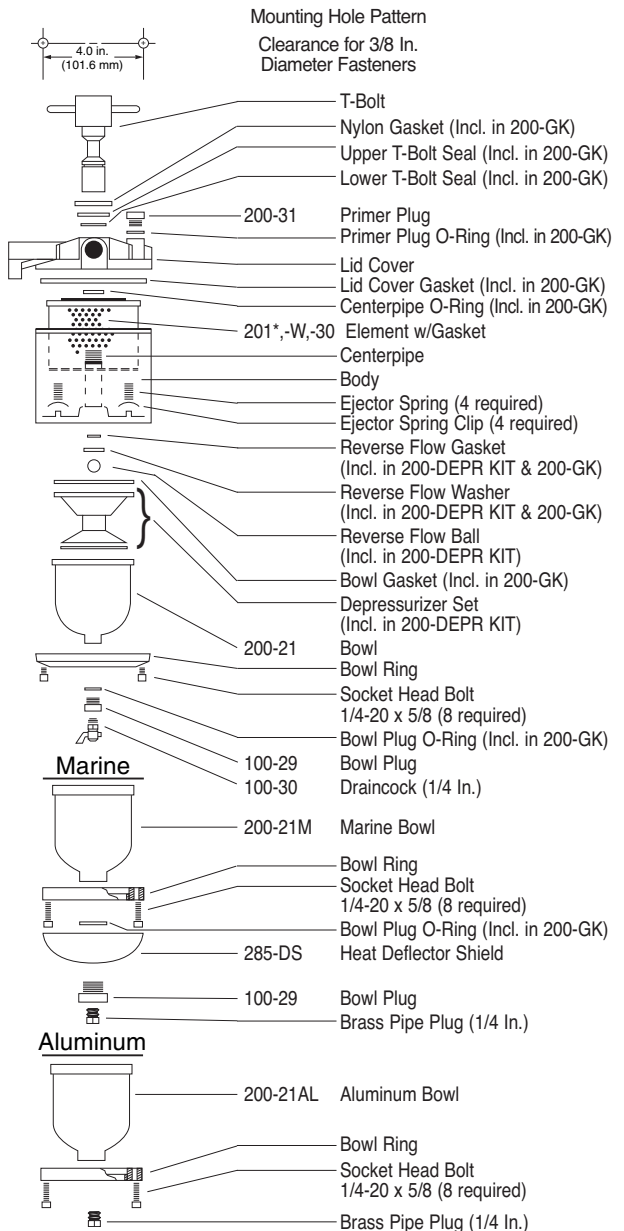

* Standard with Unit Unless Stated.



WARNING: These products can expose you to chemicals, including Diisononyl Phthalate, Carbon black extracts, Nickel, 1,3 Butadiene, Ethylene Oxide, Epichlorohydrin, which are known to the State of California to cause cancer, and Bisphenol-A, Ethylene Glycol, Ethylene Oxide, 1,3 Butadiene, Epichlorohydrin, which are known to the State of California to cause birth defects or other reproductive harm. For more information go to www.P65Warnings.ca.gov.

300 Series Diesel Fuel Filter/Water Separators



MODEL 300
Diesel Fuel
Filter/Water Separator



MODEL 300-M
Marine Diesel Fuel
Filter/Water Separator



MODEL 300-MMV3
Triple Marine Manifold Diesel Fuel Filter/Water Separator
with Shut-Off Valves for Continuous Operation



MODEL 300-MFV
Double Manifold Diesel Fuel Filter/Water Separator
with Shut-Off Valves for Continuous Operation

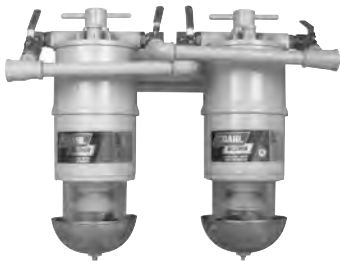

MODEL 300-MMV
Double Marine Manifold Diesel Fuel Filter/Water Separator
with Shut-Off Valves for Continuous Operation

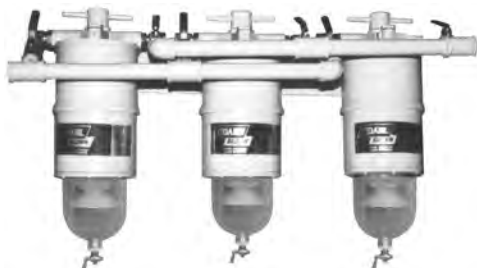

MODEL 300-MFV3
Triple Manifold Diesel Fuel Filter/Water Separator
with Shut-Off Valves for Continuous Operation

Specifications

- **Flow Resistance:**1.5 In. Mercury
- **Maximum Working Pressure:**.....25 PSI (172 kPa)
- **Temperature Range:**-50° to +225°F (-45° to +107°C)
- **Port Thread:**
Single Units:1 1/16-12 w/O-Ring Boss
Double Units:1-11 1/2 NPT
Triple Units:.....1-11 1/2 NPT
- **Height:**.....22 1/4 In. (565.2 mm)
- **Width:**7 1/2 In. (190.5 mm)
- **Depth:**.....7 3/4 In. (196.9 mm)
- **Element Removal Clearance:**.....2 1/2 In. (63.5 mm)
- **Sump Capacity:**24 oz. (708 ml)
- **Top to Inlet Clearance:**2 5/8 In. (66.7 mm)
- **Top to Outlet Clearance:**2 5/8 In. (66.7 mm)

Flow Rates

- **Single Model 300 Series:**
Recommended:.....180 GPH (U.S.) (681 LPH)
Maximum:325 GPH (U.S.) (1,230 LPH)
- **Double Model 300 Series:**
Recommended:.....360 GPH (U.S.) (1,363 LPH)
Maximum:650 GPH (U.S.) (2,460 LPH)
- **Triple Model 300 Series:**
Recommended:.....540 GPH (U.S.) (2,043 LPH)
Maximum:975 GPH (U.S.) (3,690 LPH)

Service Parts

- **Elements:**
301*5 Micron Absolute Element
301-W.....3 Micron Nominal (9 Absolute) Element
301-309 Micron Nominal (40 Absolute) Element
301-CS.....Element with Water Absorbing Media
(for use with Hydraulic Recycler)
301-MPG.....4 Micron Nominal (20 Absolute) Element
(for use with Hydraulic Recycler)
- **Gaskets:**
200-GK.....Complete Gasket Kit (See Accessories Page)
- **Kits:**
200-DEPR KIT.....Depressurizer Kit (See Accessories Page)
- **Form 4230:**
Installation, Operation, Parts & Service Information
- **Form 4123:**
Marine Installation, Operation, Parts & Service Information

* Standard with Unit Unless Stated.



WARNING: These products can expose you to chemicals, including Diisononyl Phthalate, Carbon black extracts, Nickel, 1,3 Butadiene, Ethylene Oxide, Epichlorohydrin, which are known to the State of California to cause cancer, and Bisphenol-A, Ethylene Glycol, Ethylene Oxide, 1,3 Butadiene, Epichlorohydrin, which are known to the State of California to cause birth defects or other reproductive harm. For more information go to www.P65Warnings.ca.gov.

300 Series Diesel Fuel Filter/Water Separators (Cont'd.)

Accessories

All Inlet & Outlet Fittings Require O-Ring Seals

Aluminum Bowl	200-21AL
Clear Bowl w/Water Sensor Probes	200-21BP
Clear Bowl w/Heater Probes	200-21H
Clear Bowl w/Water Sensor & Heater Probes	200-21HBP
Clear Bowl w/Marine Collar for Marine Units	200-21M
Fittings.....	See DAHL Fittings Chart
Heat Deflector Shield for Marine Units.....	285-DS
Heater Kit...See Accessories Page (Heater Kits & Heater Parts)	
Shock Pad Mounting Kit	286-SK
Water Sensor Warning Light Kit (Use with 200-21BP)	
24 Volt DC	24-WLK

300 Series Single Units

300	Diesel Fuel Filter/Water Separator
300-H	Diesel Fuel Filter/Water Separator with In-Filter Heater — Operates on either 12 or 24 Volt systems — 5 Micron Absolute Element
300-M	Marine Diesel Fuel Filter/Water Separator
300-W30	Diesel Fuel Filter/Water Separator — 9 Micron Nominal (40 Absolute) Element

300 Series Double Manifold Units

300-MFV	Two Diesel Fuel Filter/Water Separators Manifolded with Shut-Off Valves — Allows continuous operation while servicing.
300-MMV	Two Marine Diesel Fuel Filter/Water Separators Manifolded with Shut-Off Valves — Allows continuous operation while servicing.

300 Series Triple Manifold Units

300-MFV3	Three Diesel Fuel Filter/Water Separators Manifolded with Shut-Off Valves — Allows continuous operation while servicing.
300-MMV3	Three Marine Diesel Fuel Filter/Water Separators Manifolded with Shut-Off Valves — Allows continuous operation while servicing.

Used On

- 12 & 16 Cylinder Cummins & Detroit Diesel Engines
- Caterpillar Engines (800 HP & Up)
- EMD & Alco Engines up to 2,000 HP
- Locomotives
- Large Stationary Engines
- Large Boats & Generators
- Applications Requiring a # 12 Fuel Hose

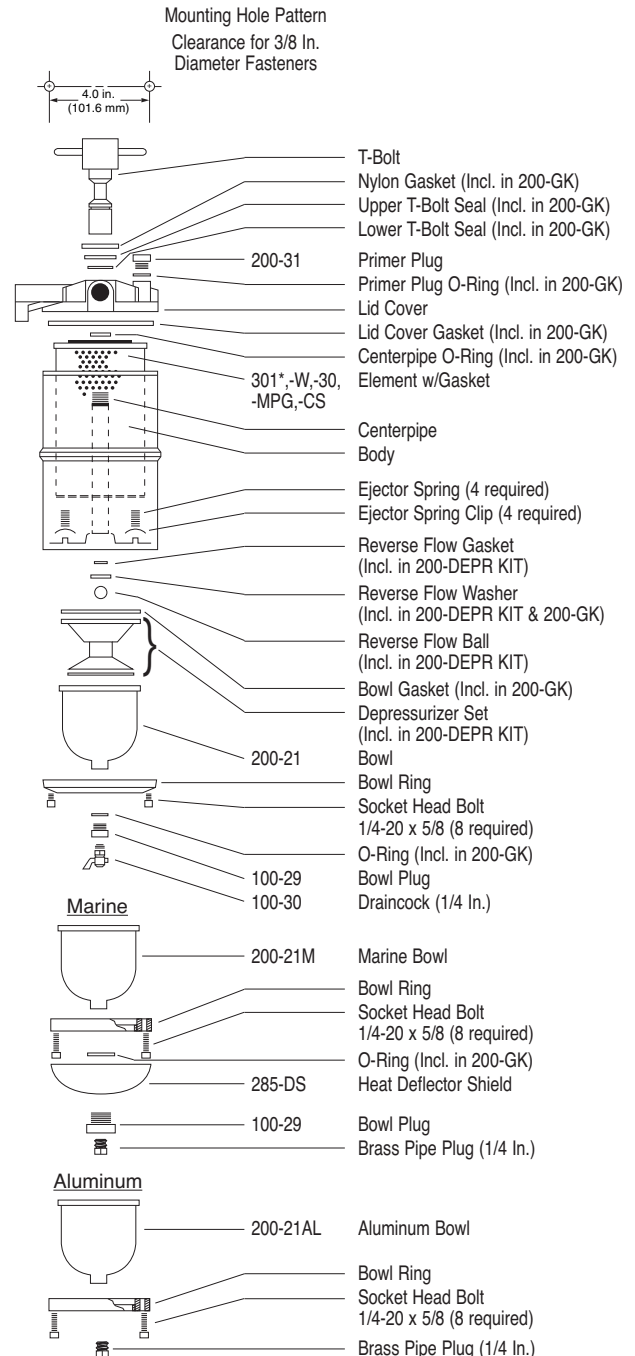

* Standard with Unit Unless Stated.



WARNING: These products can expose you to chemicals, including Diisononyl Phthalate, Carbon black extracts, Nickel, 1,3 Butadiene, Ethylene Oxide, Epichlorohydrin, which are known to the State of California to cause cancer, and Bisphenol-A, Ethylene Glycol, Ethylene Oxide, 1,3 Butadiene, Epichlorohydrin, which are known to the State of California to cause birth defects or other reproductive harm. For more information go to www.P65Warnings.ca.gov.

500 Series Tank Diesel Fuel Filter/Water Separator



MODEL 500-BP
Diesel Fuel Filter/Water Separator

Designed primarily for large marine engines, storage facilities, island fuel pumps and other permanent installations.

Nearly 17,000 square inches (11 square meters) of filtering surface is provided by seven giant DAHL 501-W (10 Micron) elements. Because of the effective separation of water and dirt, the elements will give long service.

Specifications

- **Flow Resistance:**1.0 In. Mercury
- **Maximum Working Pressure:**.....15 PSI (103 kPa)
- **Temperature Range:**-60° to +250°F (-50° to +121°C)
- **Port Thread:**2 In. NPT
- **Height:**.....47 In. (1,194 mm)
- **Width:**28 1/2 In. (724 mm)
- **Depth:**.....22 In. (559 mm)
- **Element Removal Clearance:**.....10 In. (254 mm)
- **Sump Capacity:**11 U.S. Gallons (41.6 Liters)

Flow Rates

- **Single Model 500 Series:**
Recommended:.....1,800 GPH (U.S.) (6,813 LPH)
Maximum:1,920 GPH (U.S.) (7,268 LPH)
- **Double Model 500 Series:**
Recommended:.....3,600 GPH (U.S.) (13,626 LPH)
Maximum:3,840 GPH (U.S.) (14,536 LPH)
- **Multiple Units:**
Multiply Flow Rate and Sump Capacity by Number of Units

Service Parts

- **Elements:**
5014 Micron Nominal (20 Absolute) Element
501-W*5 Micron Nominal (25 Absolute) Element
501-309 Micron Nominal (40 Absolute) Element
- **Gaskets:**See Illustration
- **Form 4500:**
Installation, Operation, Parts & Service Information

500 Series Single Units

- 500** Diesel Fuel Filter/Water Separator
- 500-BP** Diesel Fuel Filter/Water Separator with Water Sensor Warning Light Kit — Equipped with a 110 Volt Electrical Connector.
- 500-BP22** Diesel Fuel Filter/Water Separator with Water Sensor Warning Light Kit — Equipped with a 220 Volt Electrical Connector. (For Overseas Operation)

500 Series Double Manifold Units

- 500-MFVBP22** Double Manifold Diesel Fuel Filter/Water Separator with Shut-Off Valves — Allows for continuous operation and Water Sensor Warning Light Kit. — Equipped with a 220 Volt Electrical Connector. (For Overseas Operation)

Used On

- Large Marine Diesel Engines
- Large Stationary Engines
- Storage Facilities
- Large Capacity Requirements
- Fuel Storage Tank Pumps

Features of 500-BP Unit

- Easy draining with convenient bleed and drain valves.
- Easy to service - simply remove the 20 inch seal clamp to remove the top lid assembly for element replacement.
- Easy priming because primer plug is at the top.
- Easy to clean - handy four inch clean-out hole.
- Ruggedly built of high quality heavy-gauge steel.
- Hand welded and pressure tested.
- Minimum mechanical flow resistance because of the streamlined fuel flow through the seven large centertubes.
- Troubleshooting vacuum/pressure gauges monitor inlet and outlet ports.
- The water sensor kit on the 500-BP alerts the operator by a light when the unit should be drained.

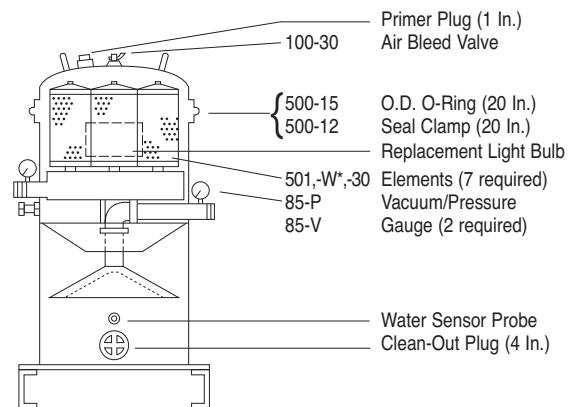

* Standard with Unit Unless Stated.



WARNING: These products can expose you to chemicals, including Diisononyl Phthalate, Carbon black extracts, Nickel, 1,3 Butadiene, Ethylene Oxide, Epichlorohydrin, which are known to the State of California to cause cancer, and Bisphenol-A, Ethylene Glycol, Ethylene Oxide, 1,3 Butadiene, Epichlorohydrin, which are known to the State of California to cause birth defects or other reproductive harm. For more information go to www.P65Warnings.ca.gov.

DAHL Hydraulic Recyclers

The DAHL Hydraulic Recyclers are specifically designed to remove emulsified water from hydraulic oils. Since water emulsified in hydraulic oil is not removed by the normal DAHL coalescing action, Hastings has designed a special filter element that absorbs water that has been emulsified in oil. The water remains in the filter element until the element is disposed. As the element absorbs water, the filtering media expands, increasing the restriction in the filter. By monitoring the pressure differential of the element, it is possible to determine when the element is saturated.

Two unique DAHL elements have been developed in conjunction with the hydraulic units. The first element is the 301-CS. The 301-CS contains a special polymer enhanced media that absorbs water regardless of emulsification. The element has the capacity to absorb over 1 1/2 quarts of water. (This is dependent upon oil viscosity, temperature and

other factors.) When the element becomes saturated, the water is disposed along with the element.

The second element is the 301-MPG. This has a synthetic grade media that is designed as a fine clean-up element. It has a Beta ratio of 2 at 3 micron and 100 at 12 micron, making this element an excellent choice for most hydraulic clean-up applications.

Hastings has designed two portable clean-up carts based on these hydraulic elements. The 300-DHRAP5 is designed for applications requiring larger quantities of water removal with less concern about contaminant removal. The 300-DHRAS5 is a two stage unit with one absorbing element and one clean-up element. To allow effective removal of emulsified water, these units are best used in multiple-pass applications.



300-DHRAP5 Hydraulic Recycler
Portable Unit

DAHL 300-DHRAP5: Two DAHL 300 units mounted on a convenient dolly. The units are in a parallel arrangement using two of the special water absorbing elements (301-CS). A 5 GPM pump is furnished with the unit. The flow rate for this unit is dependent on the viscosity of the oil, but has been tested at about 200 gallons per hour initially with 20W SAE oil at room temperature. The flow rate will drop off as the element absorbs water. Included with the unit is a vacuum gauge that aids in monitoring the saturation of the filter. An automatic vacuum switch shuts the pump off at a predetermined vacuum setting to prevent pump and motor damage. Element water capacity is about 3 quarts.

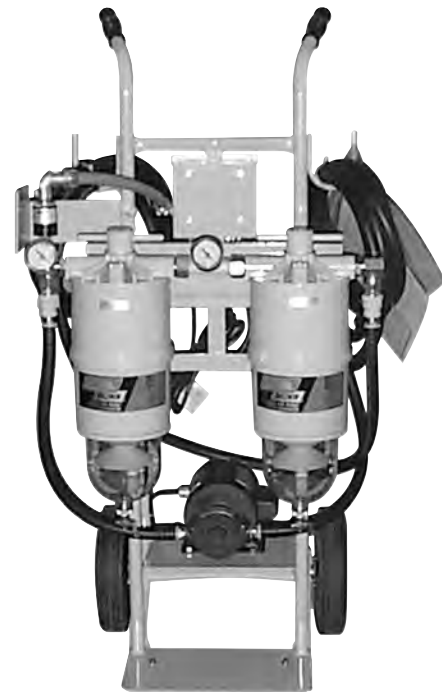

300-DHRAS5 Hydraulic Recycler
Portable Unit

DAHL 300-DHRAS5: Two DAHL 300 units mounted on a convenient dolly. The units are connected in a series flow arrangement. The hydraulic oil flows through the first unit where Hastings' special water absorbing element (301-CS) absorbs the emulsified water. The hydraulic oil next flows to a second DAHL unit where the 301-MPG synthetic media element filters contaminants out of the oil. This unit is furnished with a 3 GPM pump. Two vacuum gauges monitor the pressure drop across both filters. An automatic vacuum switch shuts the pump off at a predetermined vacuum setting. Element water capacity is about 1 1/2 quarts.



WARNING: These products can expose you to chemicals, including Diisononyl Phthalate, Carbon black extracts, Nickel, 1,3 Butadiene, Ethylene Oxide, Epichlorohydrin, which are known to the State of California to cause cancer, and Bisphenol-A, Ethylene Glycol, Ethylene Oxide, 1,3 Butadiene, Epichlorohydrin, which are known to the State of California to cause birth defects or other reproductive harm. For more information go to www.P65Warnings.ca.gov.

Accessories

Heater Kits & Heater Parts

In-Filter Heater Kits

Diesel fuel can become a problem in cold weather. Wax forms, plugging fuel lines and filters. DAHL has models 100-H and 150-H diesel fuel filter/water separators with the 55-EK Heater Kit included and models 200-H and 300-H with the 85-EK Heater Kit included. Or you can retrofit DAHL 100 and 150 series diesel fuel filter/water separators with the 55-EK Heater Kit. DAHL 200 and 300 series diesel fuel filter/water separators can be retrofitted with the 85-EK Heater Kit.

Both sizes feature an electric heating element between the body and the filter element. This simultaneously heats the filter element and the fuel around it.

An illuminated toggle switch conveniently located in the operator's area makes it easy to turn on and off. The unit is simple to install and operate. No seasonal adjustment or other maintenance is needed.

- Operates on 12 or 24 Volt Systems (Negative or Positive Ground)
- Low Amperage Requirements (Only 10 Amps at -40°F)
- Heats Fuel & Element



Use 55-EK for DAHL 100 or 150 Series and 85-EK (shown) for DAHL 200 or 300 Series

55-EK Numbers	Description & (Quantity)	85-EK Numbers
	Heater Element (1)	
100-21H	Heater Probes in Clear Bowl (1)	200-21H
	Bowl Gasket (1)	
	Toggle Switch & Connectors	
	Instructions	

55-EK has Replaced the 45-EK

Sensors

24-WLK Dash-Mounted Water Sensor
24 Volt Warning Light Kit

DAHL Literature

All printed materials are listed here as individual items.

Form 4005 DAHL Catalog
Form 4005-S DAHL Catalog (Spanish)
Form 4011 DAHL 55-EK and 85-EK In-Filter Heater Kit Installation Instructions
Form 4012 Recycler, Recycler/Blender & Fuel Transfer Models - Installation, Operation, Parts & Service Information
Form 4013 DAHL 140-50 Hand Primer Kit
Form 4025 Model 150 - Installation, Operation, Parts & Service Information

Form 4060 Model 65 & 75 - Installation, Operation, Parts & Service Information
Form 4100 Model 100 - Installation, Operation, Parts & Service Information
Form 4123 Marine - Installation, Operation, Parts & Service Information
Form 4230 Model 200 & 300 - Installation, Operation, Parts & Service Information
Form 4500 Model 500 - Installation, Operation, Parts & Service Information



WARNING: These products can expose you to chemicals, including Diisononyl Phthalate, Carbon black extracts, Nickel, 1,3 Butadiene, Ethylene Oxide, Epichlorohydrin, which are known to the State of California to cause cancer, and Bisphenol-A, Ethylene Glycol, Ethylene Oxide, 1,3 Butadiene, Epichlorohydrin, which are known to the State of California to cause birth defects or other reproductive harm. For more information go to www.P65Warnings.ca.gov.

Accessories (Cont'd.)

Vacuum Gauges

Vacuum gauges indicate the remaining life in filter elements. Replacement of the filter should be made when the gauge reading is 2-6 inches greater than the new element reading. (The exact reading depends on the characteristics of the fuel system, such as the engine, normal flow rate, component height, fuel line size, etc.)

To accurately determine when to replace the element, a reading of the gauge should be taken at the first noticeable power loss of the engine. Reduce this gauge reading by 1 inch of mercury for reference of future filter servicing.

The gauge is designed to be connected to the outlet side of the DAHL filter unit and can be mounted directly on the unit or dash-mounted.

- 85-V** Vacuum Gauge
- 85-P** Pressure Gauge

Draincocks

- 60-30** 1/4 In. Draincock (See Model 65)
- 100-30** 1/4 In. Draincock
- 200-30U** 1/4 In. U.L. Approved Draincock

Depressurizer Kits

- 100-DEPR KIT** Includes Depressurizer Set, Reverse Flow Gasket, Reverse Flow Washer and Reverse Flow Ball for 100 Series and 150 Series
- 200-DEPR KIT** Includes Depressurizer Set, Reverse Flow Gasket, Reverse Flow Washer and Reverse Flow Ball for 200 Series and 300 Series

Mounting Bracket Kit

- 100-MNTG KIT** Includes Mounting Bracket, [2] Bracket Bolts, [2] Washers and [2] Nuts for 100 Series

Gasket Kits

- 60-GK** Gaskets for 60, 65 & 75 Models includes Bowl Gasket, Bowl O-Ring, Hub Assembly Gasket and Primer Plug O-Ring
- 100-GK** Gaskets for 100 Series includes Bowl Gasket, [2] Bowl Plug Gaskets (older models), Centerpipe O-Ring, Lid Cover Gasket, Primer Plug O-Ring, Reverse Flow Gasket and Reverse Flow Washer
- 150-GK** Gaskets for 150 Series includes Bowl Gasket, [2] Bowl Plug Gaskets (older models), [2] Bowl Plug O-Rings, Centerpipe O-Ring, Lid Cover Gasket, Lid O-Ring, Primer Plug O-Ring, Reverse Flow Gasket, Reverse Flow Washer and T-Bolt O-Ring
- 200-GK** Gaskets for 200 & 300 Series includes Bowl Gasket, [2] Bowl Plug Gaskets (older models), Bowl Plug O-Ring, Centerpipe O-Ring, Lid Cover Gasket, Lower T-Bolt Seal, Nylon Gasket, [2] Primer Plug O-Rings, Reverse Flow Gasket, Reverse Flow Washer and T-Bolt O-Ring

Hand Primers For DAHL Models 65, 75 & 100

- 140-50 KIT** 3/8 In. Fuel Hose

The DAHL primer is designed to make draining and/or element changing easy. Kits include primer bulb and 2 hose clamps.



Marine Shield & Shock Pad Kits

- 185-DS** Aluminum Heat Deflector Shield for 100 & 150 Series
- 285-DS** Aluminum Heat Deflector Shield for 200 & 300 Series
- 186-SK** Mounting Bracket Shock Pad Kit for 100 Series
- 286-SK** Mounting Bracket Shock Pad Kit for 150, 200 & 300 Series

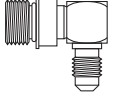
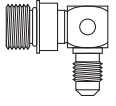
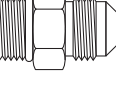

WARNING: These products can expose you to chemicals, including Diisononyl Phthalate, Carbon black extracts, Nickel, 1,3 Butadiene, Ethylene Oxide, Epichlorohydrin, which are known to the State of California to cause cancer, and Bisphenol-A, Ethylene Glycol, Ethylene Oxide, 1,3 Butadiene, Epichlorohydrin, which are known to the State of California to cause birth defects or other reproductive harm. For more information go to www.P65Warnings.ca.gov.

DAHL Fittings Chart

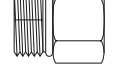
FITTING	FOR DAHL UNIT	THREAD 1	THREAD 2
90° Elbow Straight Thread with O-Ring/37° Male JIC 	65, 75 & 100 Series 65, 75 & 100 Series 150 & 200 Series 150 & 200 Series 300 Series 300 Series	9/16-18 UNF 9/16-18 UNF 7/8-14 UNF 7/8-14 UNF 1 1/16-12 UNF 1 1/16-12 UNF	7/16-20 9/16-18 3/4-16 7/8-14 7/8-14 1 1/16-12
90° Elbow Straight Thread with O-Ring/37° Male JIC Drilled & Tapped for #4 Vacuum Gauge Hose 	65, 75 & 100 Series 65, 75 & 100 Series 65, 75 & 100 Series 150 & 200 Series 150 & 200 Series 150 & 200 Series 150 & 200 Series 150 & 200 Series 300 Series 300 Series	9/16-18 UNF 9/16-18 UNF 9/16-18 UNF 7/8-14 UNF 7/8-14 UNF 7/8-14 UNF 7/8-14 UNF 7/8-14 UNF 1 1/16-12 UNF 1 1/16-12 UNF	7/16-20 9/16-18 9/16-18 3/4-16 3/4-16 3/4-16 3/4-16 7/8-14 7/8-14 7/8-14
37° Male JIC Straight Thread with O-Ring 	65, 75 & 100 Series 65, 75 & 100 Series 150 & 200 Series 150 & 200 Series 300 Series 300 Series	9/16-18 UNF 9/16-18 UNF 7/8-14 UNF 7/8-14 UNF 1 1/16-12 UNF 1 1/16-12 UNF	7/16-20 9/16-18 3/4-16 7/8-14 7/8-14 1 1/16-12
37° Female JIC Swivel-Push-On Hose Fitting 	65, 75 & 100 Series 150 & 200 Series 150, 200 & 300 Series 300 Series	7/16-20 3/4-16 7/8-14 1 1/16-12	1/4 Hose 1/2 Hose 5/8 Hose 3/4 Hose
Female Pipe Straight Thread with O-Ring 	65, 75 & 100 Series 65, 75 & 100 Series 150 & 200 Series 150 & 200 Series 150 & 200 Series 300 Series 300 Series	9/16-18 UNF 9/16-18 UNF 7/8-14 UNF 7/8-14 UNF 7/8-14 UNF 1 1/16-12 UNF 1 1/16-12 UNF	1/4-18 NPT 3/8-18 NPT 3/8-18 NPT 1/2-14 NPT 3/4-14 NPT 1/2-14 NPT 3/4-14 NPT
90° Swivel Elbow Straight Thread with O-Ring/37° Female JIC	300 Series	1 1/16-12 UNF	3/4-14
90° Swivel Elbow Straight Thread with O-Ring/37° Female JIC Drilled & Tapped for #4 Vacuum Gauge Hose	150 & 200 Series	7/8-14 UNF	1/2-14



WARNING: These products can expose you to chemicals, including Diisononyl Phthalate, Carbon black extracts, Nickel, 1,3 Butadiene, Ethylene Oxide, Epichlorohydrin, which are known to the State of California to cause cancer, and Bisphenol-A, Ethylene Glycol, Ethylene Oxide, 1,3 Butadiene, Epichlorohydrin, which are known to the State of California to cause birth defects or other reproductive harm. For more information go to www.P65Warnings.ca.gov.

Replacement Parts

Filter Bowls



- 60-21A** Amber Bowl for 60 & 65 Series — Draincock included
- 75-21** Aluminum Bowl for 75 Series
- 100-21** Clear Replacement Bowl for 100 & 150 Series
- 100-21AL** Aluminum Replacement Bowl for 100 & 150 Series
- 100-21BP** Clear Bowl w/Water Sensor Probes for 100 & 150 Series
- 100-21H** Clear Bowl w/Heater Probes for 100 & 150 Series (Part of 55-EK Heater Kit)
- 100-21M** Clear Bowl w/Marine Collar for 100 & 150 Series Marine Units
- 200-21** Clear Replacement Bowl for 200 & 300 Series
- 200-21AL** Aluminum Replacement Bowl for 200 & 300 Series
- 200-21BP** Clear Bowl w/Water Sensor Probes for 200 & 300 Series
- 200-21H** Clear Bowl w/Heater Probes for 200 & 300 Series (Part of 85-EK Heater Kit)
- 200-21HBP** Clear Bowl w/Water Sensor and Heater Probes for 200 & 300 Series (Upper Holes for Heater, Lower Holes for Bowl Probes)
- 200-21M** Clear Bowl w/Marine Collar for 200 & 300 Series Marine Units

Filter Elements



As with all filter elements made by Hastings, you can be sure that DAHL filter elements are made just right. Not only do we make sure the paper conforms to our exacting requirements, but we also use more paper in a given size filter if this is needed to do the job. (The -W elements are designed for winter or severe conditions.)

- 61** 2 Micron Nominal (20 Absolute) Element for 60
- 61-W** 5 Micron Nominal (25 Absolute) Element for 60
- 66** 4 Micron Nominal (20 Absolute) Element for 65 & 75
- 66-W** 5 Micron Nominal (25 Absolute) Element for 65 & 75
- 66-30** 5 Micron Nominal (25 Absolute) Element for 65 & 75
- 101** 4 Micron Nominal (20 Absolute) Element for 100 Series
- 101-W** 5 Micron Nominal (25 Absolute) Element for 100 Series
- 101-30** 9 Micron Nominal (40 Absolute) Element for 100 Series
- 151** 4 Micron Nominal (20 Absolute) Element for 150 Series
- 151-W** 5 Micron Nominal (25 Absolute) Element for 150 Series
- 151-30** 9 Micron Nominal (40 Absolute) Element for 150 Series
- 201** 4 Micron Nominal (20 Absolute) Element for 200 Series
- 201-W** 5 Micron Nominal (25 Absolute) Element for 200 Series
- 201-30** 9 Micron Nominal (40 Absolute) Element for 200 Series
- 301** 5 Micron Absolute Element for 300 Series
- 301-W** 3 Micron Nominal (9 Absolute) Element for 300 Series
- 301-30** 9 Micron Nominal (40 Absolute) Element for 300 Series
- 301-CS** Water Absorbing Element for 300 Series
- 301-MPG** Maximum Performance Glass Element for 300 Series
- 501** 4 Micron Nominal (20 Absolute) Element for 500 Series
- 501-W** 5 Micron Nominal (25 Absolute) Element for 500 Series
- 501-30** 9 Micron Nominal (40 Absolute) Element for 500 Series

(See Product Guide for filter element specifications)

DAHL Equivalents For Racor® Assemblies

Racor Assembly	Racor Flow (Max.)	DAHL Flow (Max.)	DAHL Assembly
200FG	15	30	65
200FGM	15	30	75
500FG	60	65	100
500MA	60	65	100-M
900FG	90	100	150
900MA	90	100	150-M
1000FG	180	200	200
1000MA	180	200	200-M
73/1000FG	360	400	200-MFV*
73/1000MA	360	400	200-MMV*
75/1000FG	360	400	200-MFV*
75/1000M	360	400	200-MMV*
79/1000FG	540	650	300-MFV3*
79/1000MA	540	650	300-MMV*

* Unit includes shut-off valves.

Replacements For Racor® Elements

Racor Element	Racor Housing	Hastings Element
200 Series		
2000SM-OR		PF599
2000TM-OR		PF599-10
2000PM-OR		PF599-30
500FG Series		
2010SM-OR		PF598
2010TM-OR		PF598-10
2010PM-OR		PF598-30
900FG Series		
2040SM-OR		PF7889
2040TM-OR		PF7889-10
2040PM-OR		PF7889-30
1000FG Series		
2020SM-OR		PF7890
2020TM-OR		PF7890-10
2020PM-OR		PF7890-30



WARNING: These products can expose you to chemicals, including Diisononyl Phthalate, Carbon black extracts, Nickel, 1,3 Butadiene, Ethylene Oxide, Epichlorohydrin, which are known to the State of California to cause cancer, and Bisphenol-A, Ethylene Glycol, Ethylene Oxide, 1,3 Butadiene, Epichlorohydrin, which are known to the State of California to cause birth defects or other reproductive harm. For more information go to www.P65Warnings.ca.gov.



INDUSTRIAL AIR CARTRIDGE CROSS-REFERENCES

■ AIR REFINER			■ DOLLINGER		
Air Refiner		Baldwin	Dollinger		Baldwin
ARM1416R		PA3602	CY2212		PA2698
ARM17057		PA3604	CY2611P		PA2857
ARM18583		PA3579	CY2612		PA2855
ARM18803		PA3460	SG2212		PA2989
ARM19215		PA2855			
ARM19215-0		PA3458			
ARM21028		PA3404			
ARM21347		PA2857			
ARM21586		PA2856			
ARM22269		PA2799			
ARM72518		PA2988			
ARM84378		PA2989			
ARM10-2090		PA1649			
ARM10-6775		PA1893			
ARM10-9086		PA1886			
ARM10-9200		LL1895			
ARM12-3990		PA2527			
ARM12-5744		PA3579			
ARM12-8495		PA3452			
ARM12-8781		PA2580			
ARM13-0747		PA2484			
ARM14-6555		PA2593			
■ AIRFLOW SYSTEMS			■ DONALDSON		
Airflow		Baldwin	Donaldson		Baldwin
7FRO 2903		PA3598	P102090		PA1649
7FRO 2912		PA3598	P106775		PA1893
			P109086		PA1886
			P109200		LL1895
			P117370		PA2509
			P123990		PA2527
			P125306		PA2593
			P125744		PA2698
			P128781		PA2580
			P129196		PA3460
			P129337		PA3579
			P130747		PA2484
			P131912		PA2855
			P133253		PA3579
			P134507		PA2855
			P138524		PA2484
			P140724		PA3404
			P140854		PA2855
			P143515		PA3404
			P145891		PA2857
			P146555		PA2593
			P147320		PA2698
			P148646		PA2856
			P149554		PA2855
			P150232		PA3637
			P150349		PA2527
			P150464		PA2484
			P151244		PA2799
			P151504		PA2855
			P152923		PA1886
			P155248		PA2855
			P156334		PA2857
			P520620		PA3452
			P524836		PA2855
			P525858		PA2698
			P823295		PA3562
■ COMPLETE FILTER			■ DURAQUIP		
Complete		Baldwin	Duraquip		Baldwin
CF10-9086		PA1886	90603		PA3691
CF12-3780		PA2989			
CF12-5744		PA2698			
CF13-0747		PA2484			
CF13-9086		PA3598			
CF14-1228		PA3458			
CF72-5180		PA2988			
CF81-8583		PA3579			
CF81-8803		PA2856			
CF81-9215		PA2855			
CF82-1028		PA3404			
CF82-2269		PA2799			



WARNING: These products can expose you to chemicals, including Diisononyl Phthalate, Carbon black extracts, Nickel, 1,3 Butadiene, Ethylene Oxide, Epichlorohydrin, which are known to the State of California to cause cancer, and Bisphenol-A, Ethylene Glycol, Ethylene Oxide, 1,3 Butadiene, Epichlorohydrin, which are known to the State of California to cause birth defects or other reproductive harm. For more information go to www.P65Warnings.ca.gov.

INDUSTRIAL AIR CARTRIDGE CROSS-REFERENCES



<p>■ ENDUSTRA</p> <table border="1"> <thead> <tr> <th>Endustra</th> <th>Baldwin</th> </tr> </thead> <tbody> <tr><td>51013</td><td>PA2989</td></tr> <tr><td>51014</td><td>PA2988</td></tr> <tr><td>51015</td><td>PA2580</td></tr> <tr><td>51047</td><td>PA1893</td></tr> <tr><td>51048</td><td>PA3579</td></tr> <tr><td>51049</td><td>PA3460</td></tr> <tr><td>51050</td><td>PA2857</td></tr> <tr><td>51053</td><td>PA2799</td></tr> <tr><td>51053A</td><td>PA3458</td></tr> <tr><td>51054</td><td>PA2855</td></tr> <tr><td>51055</td><td>PA2855</td></tr> <tr><td>51056</td><td>PA2856</td></tr> <tr><td>51089</td><td>PA2855</td></tr> </tbody> </table>	Endustra	Baldwin	51013	PA2989	51014	PA2988	51015	PA2580	51047	PA1893	51048	PA3579	51049	PA3460	51050	PA2857	51053	PA2799	51053A	PA3458	51054	PA2855	51055	PA2855	51056	PA2856	51089	PA2855	<p>■ FLEETLIFE</p> <table border="1"> <thead> <tr> <th>Fleetlife</th> <th>Baldwin</th> </tr> </thead> <tbody> <tr><td>FA 3990</td><td>PA2527</td></tr> <tr><td>FA 5744</td><td>PA2698</td></tr> <tr><td>FA 5858</td><td>PA2698</td></tr> <tr><td>FA 6318</td><td>PA2509</td></tr> <tr><td>FA 6334</td><td>PA2855</td></tr> <tr><td>FA 6775</td><td>PA1893</td></tr> <tr><td>FA 8495</td><td>PA3452</td></tr> <tr><td>FA 8781</td><td>PA2580</td></tr> <tr><td>FA 18583</td><td>PA3579</td></tr> <tr><td>FA 18803</td><td>PA3460</td></tr> <tr><td>FA 19215</td><td>PA2855</td></tr> <tr><td>FA 19215-0</td><td>PA3458</td></tr> <tr><td>FA 21028</td><td>PA3404</td></tr> <tr><td>FA 21347</td><td>PA2857</td></tr> <tr><td>FA 21586</td><td>PA2856</td></tr> <tr><td>FA 21967</td><td>PA3581</td></tr> <tr><td>FA 22269</td><td>PA2799</td></tr> <tr><td>FA 22343</td><td>PA2973</td></tr> <tr><td>FA 22839</td><td>PA1886</td></tr> <tr><td>FA 37536</td><td>PA2796</td></tr> <tr><td>FA 72518</td><td>PA2988</td></tr> <tr><td>FA 84378</td><td>PA2989</td></tr> <tr><td>FA 661394</td><td>PA3560</td></tr> </tbody> </table>	Fleetlife	Baldwin	FA 3990	PA2527	FA 5744	PA2698	FA 5858	PA2698	FA 6318	PA2509	FA 6334	PA2855	FA 6775	PA1893	FA 8495	PA3452	FA 8781	PA2580	FA 18583	PA3579	FA 18803	PA3460	FA 19215	PA2855	FA 19215-0	PA3458	FA 21028	PA3404	FA 21347	PA2857	FA 21586	PA2856	FA 21967	PA3581	FA 22269	PA2799	FA 22343	PA2973	FA 22839	PA1886	FA 37536	PA2796	FA 72518	PA2988	FA 84378	PA2989	FA 661394	PA3560
Endustra	Baldwin																																																																												
51013	PA2989																																																																												
51014	PA2988																																																																												
51015	PA2580																																																																												
51047	PA1893																																																																												
51048	PA3579																																																																												
51049	PA3460																																																																												
51050	PA2857																																																																												
51053	PA2799																																																																												
51053A	PA3458																																																																												
51054	PA2855																																																																												
51055	PA2855																																																																												
51056	PA2856																																																																												
51089	PA2855																																																																												
Fleetlife	Baldwin																																																																												
FA 3990	PA2527																																																																												
FA 5744	PA2698																																																																												
FA 5858	PA2698																																																																												
FA 6318	PA2509																																																																												
FA 6334	PA2855																																																																												
FA 6775	PA1893																																																																												
FA 8495	PA3452																																																																												
FA 8781	PA2580																																																																												
FA 18583	PA3579																																																																												
FA 18803	PA3460																																																																												
FA 19215	PA2855																																																																												
FA 19215-0	PA3458																																																																												
FA 21028	PA3404																																																																												
FA 21347	PA2857																																																																												
FA 21586	PA2856																																																																												
FA 21967	PA3581																																																																												
FA 22269	PA2799																																																																												
FA 22343	PA2973																																																																												
FA 22839	PA1886																																																																												
FA 37536	PA2796																																																																												
FA 72518	PA2988																																																																												
FA 84378	PA2989																																																																												
FA 661394	PA3560																																																																												
<p>■ FARR</p> <table border="1"> <thead> <tr> <th>Farr</th> <th>Baldwin</th> </tr> </thead> <tbody> <tr><td>49880-001</td><td>PA4664</td></tr> <tr><td>49880-002</td><td>PA4661</td></tr> <tr><td>49880-004</td><td>PA4662</td></tr> <tr><td>49880-006</td><td>PA4663</td></tr> <tr><td>59413-008</td><td>PA4668</td></tr> <tr><td>72518-001</td><td>PA2988</td></tr> <tr><td>72518-004</td><td>PA3580</td></tr> <tr><td>78968-000</td><td>PA3404</td></tr> <tr><td>79203-000</td><td>PA2799</td></tr> <tr><td>84378-001</td><td>PA2989</td></tr> <tr><td>101400-1</td><td>PA3611</td></tr> <tr><td>119303-004</td><td>PA4669</td></tr> </tbody> </table>	Farr	Baldwin	49880-001	PA4664	49880-002	PA4661	49880-004	PA4662	49880-006	PA4663	59413-008	PA4668	72518-001	PA2988	72518-004	PA3580	78968-000	PA3404	79203-000	PA2799	84378-001	PA2989	101400-1	PA3611	119303-004	PA4669	<p>■ HEAVY DUTY AIR</p> <table border="1"> <thead> <tr> <th>Heavy Duty Air</th> <th>Baldwin</th> </tr> </thead> <tbody> <tr><td>A07200</td><td>PA3457</td></tr> <tr><td>A09268</td><td>PA3569</td></tr> </tbody> </table>	Heavy Duty Air	Baldwin	A07200	PA3457	A09268	PA3569																																												
Farr	Baldwin																																																																												
49880-001	PA4664																																																																												
49880-002	PA4661																																																																												
49880-004	PA4662																																																																												
49880-006	PA4663																																																																												
59413-008	PA4668																																																																												
72518-001	PA2988																																																																												
72518-004	PA3580																																																																												
78968-000	PA3404																																																																												
79203-000	PA2799																																																																												
84378-001	PA2989																																																																												
101400-1	PA3611																																																																												
119303-004	PA4669																																																																												
Heavy Duty Air	Baldwin																																																																												
A07200	PA3457																																																																												
A09268	PA3569																																																																												
<p>■ FLEETGUARD</p> <table border="1"> <thead> <tr> <th>Fleetguard</th> <th>Baldwin</th> </tr> </thead> <tbody> <tr><td>AF361</td><td>PA1649</td></tr> <tr><td>AF421</td><td>PA1886</td></tr> <tr><td>AF427M</td><td>LL1895</td></tr> <tr><td>AF820M</td><td>PA1893</td></tr> <tr><td>AF1753</td><td>PA2484</td></tr> <tr><td>AF1872</td><td>PA2527</td></tr> <tr><td>AF1901M</td><td>PA2580</td></tr> <tr><td>AF1907M</td><td>PA3452</td></tr> <tr><td>AF4778</td><td>PA2698</td></tr> <tr><td>AF4780</td><td>PA2593</td></tr> <tr><td>AF4783</td><td>PA2799</td></tr> <tr><td>AF4791</td><td>PA3460</td></tr> <tr><td>AF4793</td><td>PA2855</td></tr> <tr><td>AF4799</td><td>PA2857</td></tr> <tr><td>AF4897</td><td>PA2509</td></tr> </tbody> </table>	Fleetguard	Baldwin	AF361	PA1649	AF421	PA1886	AF427M	LL1895	AF820M	PA1893	AF1753	PA2484	AF1872	PA2527	AF1901M	PA2580	AF1907M	PA3452	AF4778	PA2698	AF4780	PA2593	AF4783	PA2799	AF4791	PA3460	AF4793	PA2855	AF4799	PA2857	AF4897	PA2509	<p>■ INGERSOLL-RAND</p> <table border="1"> <thead> <tr> <th>Ingersoll-Rand</th> <th>Baldwin</th> </tr> </thead> <tbody> <tr><td>36858405</td><td>PA3587</td></tr> </tbody> </table>	Ingersoll-Rand	Baldwin	36858405	PA3587																																								
Fleetguard	Baldwin																																																																												
AF361	PA1649																																																																												
AF421	PA1886																																																																												
AF427M	LL1895																																																																												
AF820M	PA1893																																																																												
AF1753	PA2484																																																																												
AF1872	PA2527																																																																												
AF1901M	PA2580																																																																												
AF1907M	PA3452																																																																												
AF4778	PA2698																																																																												
AF4780	PA2593																																																																												
AF4783	PA2799																																																																												
AF4791	PA3460																																																																												
AF4793	PA2855																																																																												
AF4799	PA2857																																																																												
AF4897	PA2509																																																																												
Ingersoll-Rand	Baldwin																																																																												
36858405	PA3587																																																																												
	<p>■ METROPLEX PRODUCTS</p> <table border="1"> <thead> <tr> <th>Metroplex</th> <th>Baldwin</th> </tr> </thead> <tbody> <tr><td>M00-709-102</td><td>PA3559</td></tr> </tbody> </table>	Metroplex	Baldwin	M00-709-102	PA3559																																																																								
Metroplex	Baldwin																																																																												
M00-709-102	PA3559																																																																												
	<p>■ PNEUMAFIL</p> <table border="1"> <thead> <tr> <th>Pneumafil</th> <th>Baldwin</th> </tr> </thead> <tbody> <tr><td>A37536B-2</td><td>PA2796</td></tr> <tr><td>A38738C-2</td><td>PA3595</td></tr> </tbody> </table>	Pneumafil	Baldwin	A37536B-2	PA2796	A38738C-2	PA3595																																																																						
Pneumafil	Baldwin																																																																												
A37536B-2	PA2796																																																																												
A38738C-2	PA3595																																																																												



WARNING: These products can expose you to chemicals, including Diisononyl Phthalate, Carbon black extracts, Nickel, 1,3 Butadiene, Ethylene Oxide, Epichlorohydrin, which are known to the State of California to cause cancer, and Bisphenol-A, Ethylene Glycol, Ethylene Oxide, 1,3 Butadiene, Epichlorohydrin, which are known to the State of California to cause birth defects or other reproductive harm. For more information go to www.P65Warnings.ca.gov.



INDUSTRIAL AIR CARTRIDGE CROSS-REFERENCES

■ TDC			■ TORIT		
TDC	Baldwin		Torit	Baldwin	
200	PA3460		8PP-18583-00	PA3579	
20U	PA2856		8PP-18583-01	PA2698	
300	PA2855		8PP-18803-00	PA3460	
30C	PA3404		8PP-19215-01	PA2855	
30U	PA2857		8PP-19524-01	PA3579	
30U03	PA2799		8PP-20112-00	PA3460	
4WF	PA3560		8PP-20247-00	PA2855	
500	PA2989		8PP-20306-00	PA2855	
10000001	PA2855		8PP-21028-00	PA3404	
10000003	PA3458		8PP-21347-00	PA2857	
10000006	PA2857		8PP-21586-00	PA2856	
10000009	PA3560		8PP-21967-00	PA3581	
10000013	PA3404		8PP-22269-00	PA2799	
10000016	PA2799		8PP-22343-00	PA2973	
10000030	PA3460		8PP-22839-00	PA1886	
10000031	PA2856		8PP-23099-00	PA3458	
10000035	PA3579		8PP-25116-01	PA2857	
10000045	PA3560		8PP-25370-00	PA3588	
10000066	PA3581		8PP-28888-00	PA2799	
10000071	PA2973		8PP-32537-00	PA3461	
10000155	PA2988		8PP-32582-00	PA2988	
10000156	PA2989		8PP-40766-00	PA3563	
10000980	PA3611		8PP-41546-00	PA2857	
			8PP-42057-00	PA3463	
			8PP-42058-00	PA3614	
			8PP-46933-00	PA2857	
			9832047	PA1893	
■ TIPTON FILTER CLONE			■ WHEELABRATOR		
Tipton	Baldwin		Wheelabrator	Baldwin	
12-8495	PA3452		493206	PA3460	
FC15-1001	PA3584		661394	PA3560	
FC3R-1001	PA3452		213600881	PA3638	
			713200881	PA3640	
			803600882	PA3576	
			833600882	PA3568	



WARNING: These products can expose you to chemicals, including Diisononyl Phthalate, Carbon black extracts, Nickel, 1,3 Butadiene, Ethylene Oxide, Epichlorohydrin, which are known to the State of California to cause cancer, and Bisphenol-A, Ethylene Glycol, Ethylene Oxide, 1,3 Butadiene, Epichlorohydrin, which are known to the State of California to cause birth defects or other reproductive harm. For more information go to www.P65Warnings.ca.gov.

INDUSTRIAL AIR CARTRIDGE DIMENSIONAL DETAILS



■ BALDWIN						
Number	Style	O.D.	I.D.	HT.	Media Area Sq. Ft.	Description
PA1649	OCH	13.81 x 9.50		16.00	114	Donaldson P102090
PA1886	OCH	12.13 x 7.69		16.50	88	Donaldson P109086
PA1893	OCH	6.40 x 5.24		16.00 w/7.50 O.D. Flange	13	Donaldson P106775
LL1895	OCH	10.22 x 6.06		14.50	76	Donaldson P109200
PA2484	OCH	7.94 x 3.56		16.50	61	Donaldson P130747
PA2509	OCH	10.38 x 6.03		18.38	82	Donaldson P117370
PA2527	OCH	6.88 x 3.50		13.44	30	Donaldson P123990
PA2580	OC	12.75 x 8.34		23.50	162	Donaldson P128781
PA2593	P	19.50 x 19.50		5.56	118	Donaldson P146555
PA2698	OCH	12.75 x 8.34		22.50	189	Donaldson P147320
PA2796	OCH	12.75 x 8.34		29.75	181	Pneumafil A37536B-2
PA2799	OO	12.75 x 8.34		26.50	219	Torit 8PP-22269-00
PA2855	OCH	12.75 x 8.34		26.50	219	Torit 8PP-19215-01
PA2856	OCH	7.94 x 3.56		16.50	58	Torit 8PP-21586-00
PA2857	OCH	12.75 x 8.34		26.50	219	Torit 8PP-21347-00
PA2973	OO	12.75 x 8.34		26.50	197	Torit 8PP-22343-00
PA2988	FM	12.75 x 8.31		26.63 w/15.97 x 14.25 Flange	233	Farr 72518-001
PA2989	FM	12.75 x 8.31		22.63 w/15.97 x 14.25 Flange	195	Farr 84378-001
PA3404	OCH	12.75 x 8.38		26.50	219	Torit 8PP-21028-00
PA3452	OCH	10.38 x 6.03		26.50	124	Donaldson P520620
PA3457	OO	5.69 x 3.56		4.84	5	Heavy Duty Air A07200
PA3458	OO	12.75 x 8.34		26.50	219	Torit 8PP-23099-00
PA3460	OCH	7.94 x 3.56		16.50	57	Torit 8PP-18803-00
PA3461	OO	13.81 x 9.50		26.50	246	Torit 8PP-32537-00
PA3463	OO	13.81 x 9.50		26.50	246	Torit 8PP-42057-00
PA3559	OO	12.00 x 7.69		21.00	134	Metroplex M00-709-102
PA3560	FM	12.75 x 8.44		26.63 w/13.88 O.D. Flange	154	Wheelabrator 661394
PA3562	OCH	7.94 x 3.56		20.25	68	Donaldson P823295
PA3563	OO	12.75 x 8.34		26.50	219	Torit 8PP-40766-00
PA3568	FM	12.75 x 8.38 x 36.62		w/16.50 x 15.00 Flange	213	Wheelabrator 833600882
PA3569	OO	13.81 x 9.50		28.50	267	Heavy Duty Air A09268
PA3576	FM	12.75 x 8.38 x 36.63		w/13.91 O.D. Flange	213	Wheelabrator 803600882
PA3579	OCH	12.75 x 8.34		22.50	186	Torit 8PP-18583-00
PA3580	FM	12.75 x 8.34 x 26.63		w/15.97 x 14.34 Flange	233	Farr 72518-004
PA3581	OCH	7.94 x 3.56		22.50	79	Torit 8PP-21967-00
PA3584	OO	16.63 x 12.00		25.00	239	Tipton FC15-1001
PA3587	OO	13.81 x 9.50		27.50	262	Ingersoll-Rand 36858405
PA3588	OO	13.81 x 9.50		22.50	205	Torit 8PP-25370-00
PA3595	OC	12.75 x 8.38 x 34.63		w/3 Lug Twist Lock	280	Pneumafil A38738C-2
PA3598	OC	12.09 x 7.69		12.00	81	Airflow 7FRO 2912
PA3602	OO	13.81 x 9.50		15.75	124	Air Refiner ARM1416R
PA3604	OCH	13.84 x 11.13		14.00	81	Air Refiner ARM17057
PA3611	FM	12.75 x 8.31 x 34.63		w/15.97 x 14.25 Flange	305	Farr 101400-1
PA3614	OO	13.81 x 9.50		26.50	246	Torit 8PP-42058-00
PA3637	OO	17.63 x 11.03		23.53	353	Donaldson P150232
PA3638	OCH	12.75 x 8.34		36.50	232	Wheelabrator 213600881
PA3640	OCH	7.94 x 3.56		32.50	116	Wheelabrator 713200881
PA3645	OCH	9.22 x 4.84		11.50	44	Stork Laser Engineering
PA3691	OCH	9.25 x 6.75		24.50	76	Duraquip 90603
PA4661	P	19.50 x 19.50		1.75	12	Farr 49880-002
PA4662	P	15.25 x 24.50		1.75	12	Farr 49880-004
PA4663	P	11.38 x 23.38		1.75	9	Farr 49880-006
PA4664	P	15.50 x 19.50		1.75	10	Farr 49880-001
PA4668	P	10.38 x 23.38		3.75	22	Farr 59413-008
PA4669	P	15.50 x 24.50		0.75	5	Farr 119303-004

FM
Round/Rectangular
Flange Mount

OC
Open, Closed

OCH
Open, Closed
w/Center Hole

OO
Open Both Ends

P
Panel



WARNING: These products can expose you to chemicals, including Diisononyl Phthalate, Carbon black extracts, Nickel, 1,3 Butadiene, Ethylene Oxide, Epichlorohydrin, which are known to the State of California to cause cancer, and Bisphenol-A, Ethylene Glycol, Ethylene Oxide, 1,3 Butadiene, Epichlorohydrin, which are known to the State of California to cause birth defects or other reproductive harm. For more information go to www.P65Warnings.ca.gov.

O-RING UNIFORM DASH NUMBERS

Uniform Dash Numbers represent specific sized O-Rings. The material used in the construction (or compound number) is added to the Dash Number to give a complete number, describing both size and material.

A filter will not filter if it does not seal, and it cannot seal without the right gasket. Order the gaskets you will need when you order your Baldwin filters.

O-RING UNIFORM DASH NUMBERS TO BALDWIN NUMBERS

DASH NUMBER	BALDWIN NUMBER	DASH NUMBER	BALDWIN NUMBER	DASH NUMBER	BALDWIN NUMBER	DASH NUMBER	BALDWIN NUMBER	DASH NUMBER	BALDWIN NUMBER
014	100-17	162	G437	239	G229	254	G368	352	G445
017	150-17	212	ES1067	240	G162	255	G203	358	G433
018	200-17	213	ES3007	241	G410	257	G265	365	ES3020
037	ES1023	214	ES3028	242	G376	258	G444	371	G438
042	ES3009	222	ES3012	243	G402	259	G360	425	G290
110	ES1074	227	G441	244	G333	260	G359	427	G417
111	150-32	229	G173-C	245	G310	263	G382	429	G211
112	ES1036	231	G403	246	G447	263	G382-V	432	G446
113	ES1049	232	G283	248	G342	266	G412	433	G263
115	200-32	233	G270	249	G315	338	G232	438	G416
133	G328	235	G442	250	G443	340	G406	444	G206
140	G467	236	G247	251	G362	345	G219	445	G238
153	G387	237	G432	252	G347	348	G236-A	446	G157
156	G468	238	G366	253	G354	350	G439	906	ES3079

BALDWIN NUMBERS TO O-RING UNIFORM DASH NUMBERS

BALDWIN NUMBER	DASH NUMBER	BALDWIN NUMBER	DASH NUMBER	BALDWIN NUMBER	DASH NUMBER	BALDWIN NUMBER	DASH NUMBER	BALDWIN NUMBER	DASH NUMBER
G157	446	G270	233	G368	254	G437	162	ES1049	113
G162	240	G283	232	G376	242	G438	371	ES1067	212
G173-C	229	G290	425	G382	263	G439	350	ES1074	110
G203	255	G310	245	G382-V	263	G441	227	ES3007	213
G206	444	G315	249	G387	153	G442	235	ES3009	042
G211	429	G328	133	G402	243	G443	250	ES3012	222
G219	345	G333	244	G403	231	G444	258	ES3020	365
G229	239	G342	248	G406	340	G445	352	ES3028	214
G232	338	G347	252	G410	241	G446	432	ES3079	906
G236-A	348	G354	253	G412	266	G447	246	100-17	014
G238	445	G359	260	G416	438	G467	140	150-17	017
G247	236	G360	259	G417	427	G468	156	150-32	111
G263	433	G362	251	G432	237	ES1023	037	200-17	018
G265	257	G366	238	G433	358	ES1036	112	200-32	115



WARNING: These products can expose you to chemicals, including Diisononyl Phthalate, Carbon black extracts, Nickel, 1,3 Butadiene, Ethylene Oxide, Epichlorohydrin, which are known to the State of California to cause cancer, and Bisphenol-A, Ethylene Glycol, Ethylene Oxide, 1,3 Butadiene, Epichlorohydrin, which are known to the State of California to cause birth defects or other reproductive harm. For more information go to www.P65Warnings.ca.gov.

ROUND GASKETS ARRANGED BY O.D.

O.D. Inches	O.D. (mm)	I.D. Inches	I.D. (mm)	THICK Inches	THICK (mm)	CARQUEST NUMBER	O.D. Inches	O.D. (mm)	I.D. Inches	I.D. (mm)	THICK Inches	THICK (mm)	CARQUEST NUMBER
5 9/64	130.6	4 51/64	121.8	3/32	2.4	G184-A	7 3/64	179.0	6 27/64	163.1	5/64	2.0	G356
5 9/64	130.6	4 55/64	123.4	9/64	3.6	G315	7 1/8	181.0	6 7/16	163.5	5/64	2.0	G210
5 5/32	131.0	4 47/64	120.3	13/64	5.2	G372	7 1/4	184.2	5 11/16	144.5	61/64	24.2	G304
5 1/4	133.4	3 1/2	88.9	1/16	1.6	G253-A	7 7/16	188.9	5 1/2	139.7	1/16	1.6	G343-A
5 17/64	133.7	4 27/32	123.0	13/64	5.2	G445	7 33/64	190.9	7 15/64	183.8	9/64	3.6	G382
5 17/64	133.7	4 63/64	126.6	9/64	3.6	G443	7 33/64	190.9	7 15/64	183.8	9/64	3.6	G382-V
5 9/32	134.1	4 23/32	119.9	9/32	7.1	G417	7 53/64	198.8	7 29/64	189.3	9/32	7.1	G193
5 11/32	135.7	4 51/64	121.8	1/16	1.6	G257	7 29/32	202.2	7 29/64	189.3	7/32	5.6	ES3231
5 23/64	136.1	4 61/64	125.8	13/64	5.2	G392	8 17/64	209.9	7 63/64	202.8	9/64	3.6	G412
5 25/64	136.9	5 7/64	129.8	9/64	3.6	G362	8 9/32	210.3	7 23/32	196.1	9/32	7.1	G206
5 13/32	137.3	4 3/4	120.7	1/16	1.6	G296	8 1/2	215.9	7 31/32	202.4	17/64	6.7	G252
5 13/32	137.3	5 7/32	132.6	3/32	2.4	G260	8 17/32	216.7	7 31/32	202.4	9/32	7.1	G238
5 31/64	139.3	5 15/64	133.0	1/8	3.2	G397	8 5/8	219.1	6 5/8	168.3	1/16	1.6	G314
5 33/64	140.1	5 7/32	132.6	1/8	3.2	G307	8 57/64	225.8	8 15/32	215.1	13/64	5.2	G438
5 33/64	140.1	5 15/64	133.0	9/64	3.6	G347	8 31/32	227.8	8 15/32	215.1	15/64	6.0	G309-B
5 17/32	140.5	4 31/32	126.2	9/32	7.1	G211	9	228.6	8 15/32	215.1	9/32	7.1	G157
5 9/16	141.3	5 7/32	132.6	9/32	7.1	G717	9 5/8	244.5	7 3/4	196.9	1/16	1.6	G289
5 5/8	142.9	5 7/32	132.6	13/64	5.2	G278	9 3/4	247.7	8 5/16	211.1	1/32	0.8	G155
5 41/64	143.3	5 5/64	129.0	3/16	4.8	G380	11	279.4	9	228.6	1/4	6.4	G207-AF
5 41/64	143.3	5 23/64	136.1	9/64	3.6	G354	11	279.4	9 1/8	231.8	1/4	6.4	G472-AF
5 11/16	144.5	5 15/32	138.9	1/8	3.2	G196-B	11 1/16	281.0	10 3/16	258.8	7/16	11.1	G348-AF
5 3/4	146.1	5 1/4	133.4	1/16	1.6	G169	11 1/4	285.8	9 9/16	242.9	1/32	0.8	G261
5 3/4	146.1	5 15/32	138.9	9/64	3.6	G368	11 3/8	288.9	10 3/4	273.1	5/16	7.9	G31-AF
5 27/32	148.4	5 7/16	138.1	13/64	5.2	G394	11 49/64	298.8	11	279.4	1/2	12.7	G298-AF
5 7/8	149.2	5 3/8	136.5	1/16	1.6	G363	12	304.8	11 3/8	288.9	5/16	7.9	G37-AF
5 7/8	149.2	5 39/64	142.5	9/64	3.6	G203	12 5/8	320.7	11 5/8	295.3	2 1/8	54.0	G225-AF
5 29/32	150.0	5 11/32	135.7	9/32	7.1	G446	12 3/4	323.9	10 1/2	266.7	1/4	6.4	G21-AF
5 15/16	150.8	5 23/32	145.3	1/8	3.2	G140-A	12 7/8	327.0	10 5/8	269.9	3/8	9.5	G499-AF
5 63/64	152.0	5 25/64	136.9	1/16	1.6	G164-A	13	330.2	12 3/8	314.3	5/16	7.9	G34-AF
6 1/64	152.8	5 19/32	142.1	13/64	5.2	G433	13 11/32	338.9	13 3/16	335.0	5/64	2.0	G523-AF
6 1/32	153.2	5 15/32	138.9	9/64	3.6	G263	13 41/64	346.5	12 7/8	327.0	1/2	12.7	G501-AF
6 1/32	153.2	5 17/32	140.5	3/32	2.4	G148	14 3/8	365.1	13 3/8	339.7	2 3/16	55.6	G285-AF
6 3/64	153.6	5 49/64	146.5	1/16	1.6	G144	14 11/16	373.1	13	330.2	5/16	7.9	G534-AF
6 9/64	156.0	5 55/64	148.8	1/8	3.2	G265	14 13/16 x 7 1/2	376.2	12 15/16	328.6	1/32	0.8	G305
6 15/64	158.4	5 53/64	148.0	13/64	5.2	G336	15	381.0	12 3/4	323.9	1/4	6.4	G25-AF
6 17/64	159.1	5 63/64	152.0	9/64	3.6	G444	15	381.0	13	330.2	1/4	6.4	G422-AF
6 11/32	161.1	5 7/8	149.2	1/8	3.2	G409	15 3/4	400.1	13 3/4	349.3	7/32	5.6	G145-AF
6 25/64	162.3	6 7/32	158.0	9/32	7.1	G416	16	406.4	6 1/2	165.1	3/32	2.4	G306
6 31/64	164.7	6 15/64	158.4	9/64	3.6	G360	18 1/4	463.6	17 1/4	438.2	2 1/8	54.0	G141-AF
6 17/32	165.9	6 3/64	153.6	1/8	3.2	G411							
6 9/16	166.7	6 1/16	154.0	5/64	2.0	G102-A							
6 5/8	168.3	5 1/2	139.7	1/32	0.8	G269							
6 5/8	168.3	5 1/2	139.7	1/32	0.8	G281							
6 49/64	171.8	6 31/64	164.7	9/64	3.6	G359							
6 31/32	177.0	6 15/32	164.3	17/64	6.7	G400							
7	177.8	5 1/8	130.2	1/16	1.6	G288							



WARNING: These products can expose you to chemicals, including Diisononyl Phthalate, Carbon black extracts, Nickel, 1,3 Butadiene, Ethylene Oxide, Epichlorohydrin, which are known to the State of California to cause cancer, and Bisphenol-A, Ethylene Glycol, Ethylene Oxide, 1,3 Butadiene, Epichlorohydrin, which are known to the State of California to cause birth defects or other reproductive harm. For more information go to www.P65Warnings.ca.gov.

SPIN-ON FILTERS BY TAP SIZE (U.S. THREAD)

THREAD I.D.	PER Inch	O.D. Inches	O.D. (mm)	LENGTH Inches	LENGTH (mm)	GASKET	FEATURES	BALDWIN NUMBER
3/8	18 NPT3		76.2	2 25/32	70.6			BT40015
3/8	24	3 7/16	87.3	4 13/16	122.2	[1] Included		BF939
7/16	20	3 7/16	87.3	4 13/16	122.2	[1] Included		B4
7/16	20	3 7/16	87.3	4 13/16	122.2	[1] Included		BF938
5/8	11	3 11/16	93.7	5 3/8	136.5	G381-A		BF968
5/8	18	3 11/16	93.7	3 7/8	98.4	G381-A	MO	B296
5/8	18	3 11/16	93.7	4 3/8	111.1	G381-A	MO	BT341
5/8	18	3 11/16	93.7	5 3/8	136.5	G381-A	MO	B50
5/8	18	3 11/16	93.7	5 3/8	136.5	G381-A	BP, MO	BT541
5/8	18	3 11/16	93.7	5 13/32	137.3	G381-A	AD, BP	BT248
5/8	18	3 11/16	93.7	6 5/8	168.3	G381-A	MO	B164
5/8	18	4 1/4	108.0	3 3/16	81.0	[1] Included		B222
5/8	18	4 1/4	108.0	3 3/16	81.0	[1] Included	MO	B494
5/8	18	4 1/4	108.0	5 7/8	149.2	G401		B7124
11/16	16	3 11/16	93.7	3 7/32	81.8	G381-A	BTE	BW5182
11/16	16	3 11/16	93.7	3 7/8	98.4	G381-A		BF791
11/16	16	3 11/16	93.7	4 3/8	111.1	G381-A	BTA PLUS	BW5070
11/16	16	3 11/16	93.7	4 3/8	111.1	G381-A	BTA PLUS	BW5071
11/16	16	3 11/16	93.7	4 3/8	111.1	G381-A	BTA PLUS	BW5072
11/16	16	3 11/16	93.7	4 3/8	111.1	G381-A		B5088
11/16	16	3 11/16	93.7	4 3/8	111.1	G381-A		B5089
11/16	16	3 11/16	93.7	4 3/8	111.1	G381-A	BTE	BW5136
11/16	16	3 11/16	93.7	4 13/32	111.9	G381-A	BTE	BW5137
11/16	16	3 11/16	93.7	5 11/32	135.7	G381-A	BTE	BW5139
11/16	16	3 11/16	93.7	5 3/8	136.5	G381-A	BTA PLUS	BW5073
11/16	16	3 11/16	93.7	5 3/8	136.5	G381-A	BTA PLUS	BW5074
11/16	16	3 11/16	93.7	5 3/8	136.5	G381-A	BTA PLUS	BW5075
11/16	16	3 11/16	93.7	5 3/8	136.5	G381-A	BTA PLUS	BW5082
11/16	16	3 11/16	93.7	5 3/8	136.5	G381-A		B5090
11/16	16	3 11/16	93.7	5 3/8	136.5	G381-A	BTE	BW5138
11/16	16	3 11/16	93.7	5 3/8	136.5	G381-A	BTE	BW5143
11/16	16	3 11/16	93.7	5 13/32	137.3	G381-A		B5134
11/16	16	3 11/16	93.7	5 13/32	137.3	G381-A	BTE, MO	BW5200
11/16	16	3 11/16	93.7	5 13/32	137.3	G381-A	BTA PLUS, MO	BW5250
11/16	16	3 11/16	93.7	7 5/32	181.8	G381-A	BTA PLUS	BW5076
11/16	16	3 11/16	93.7	7 5/32	181.8	G381-A	BTE	BW5140
11/16	16	3 25/32	96.0	4 1/32	102.4			BF791-O
3/4	16	2 3/32	53.2	4 25/32	121.4	[1] Included		BF7839
3/4	16	2 9/16	65.1	2 5/8	66.7	[1] Included	AD, BP	B7356
3/4	16	2 9/16	65.1	3 1/2	88.9	[1] Included	AD, MBP	B37
3/4	16	2 9/16	65.1	4 3/4	120.7	[1] Included	AD, MBP	B7238
3/4	16	2 21/32	67.5	3 1/2	88.9	[1] Included	HBP	BT9388
3/4	16	2 11/16	68.3	3	76.2	[1] Included	AD, MBP	B33
3/4	16	2 11/16	68.3	3	76.2	[1] Included	AD, BPI	B7286
3/4	16	2 11/16	68.3	3 1/2	88.9	[1] Included	AD	B1406
3/4	16	2 25/32	70.6	2 5/8	66.7	[1] Included	AD, BPI	B7333
3/4	16	2 29/32	73.8	3 1/2	88.9	G449-B	AD, BP	BT223
3/4	16	2 29/32	73.8	3 1/2	88.9	[1] Included		B40036
3/4	16	2 29/32	73.8	4 27/32	123.0	[1] Included	AD, FECV, MBP	B1416
3/4	16	2 15/16	74.6	4 27/32	123.0	G449-B	AD, SHBP	B178
3/4	16	3	76.2	2 9/32	57.9	[1] Included	AD, SHBP	B7294
3/4	16	3	76.2	2 27/32	72.2	[1] Included	AD	B7049
3/4	16	3	76.2	2 7/8	73.0	G449-B	AD, BP	B1410
3/4	16	3	76.2	3 1/8	79.4	[1] Included		B7295
3/4	16	3	76.2	3 1/2	88.9	G449-B	AD, SHBP	B228
3/4	16	3	76.2	3 1/2	88.9	G449-B	BP	B1413
3/4	16	3	76.2	3 17/32	89.7	G449-B	AD, MBP	B7361
3/4	16	3	76.2	3 17/32	89.7	[1] Included		B7491
3/4	16	3	76.2	3 17/32	89.7	[1] Included	AD, MBP	BT8409
3/4	16	3	76.2	3 27/32	97.6	[1] Included	AD, BPI	B7275
3/4	16	3	76.2	3 7/8	98.4	[1] Included	AD, MBP	B7290
3/4	16	3	76.2	4 1/16	103.2	[1] Included	AD, BP	B159
3/4	16	3	76.2	4 1/16	103.2	[1] Included	AD, HBP	B1430
3/4	16	3	76.2	4 3/32	104.0	[1] Included	AD, MBP	B7020
3/4	16	3	76.2	4 27/32	123.0	G449-B	AD, BP	B243

CAUTION!!! Read These Instructions Before Using Size Charts

The filter size charts on this and following pages are for filter experts. Careless use could lead to errors. When you have exhausted all other ways to determine a filter number, locate a suspect here, then check the Product Guide for confirmation.

Size alone does not assure you of the right filtering media, gasket or other features. What is being filtered, filter efficiency, flow rate and direction of flow all have to be considered.

Spin-on filters are listed by tap size rather than length. All other filters are listed on an overall basis. Check your Product Guide for other dimensions. Progression is from the smallest to the largest in each category.

Do NOT Interchange Filters with Different Features
Be Sure to Check Product Guide, Cross-References and Applications

We Cannot be Responsible for Misapplications



WARNING: These products can expose you to chemicals, including Diisononyl Phthalate, Carbon black extracts, Nickel, 1,3 Butadiene, Ethylene Oxide, Epichlorohydrin, which are known to the State of California to cause cancer, and Bisphenol-A, Ethylene Glycol, Ethylene Oxide, 1,3 Butadiene, Epichlorohydrin, which are known to the State of California to cause birth defects or other reproductive harm. For more information go to www.P65Warnings.ca.gov.

SPIN-ON FILTERS BY TAP SIZE (U.S. THREAD)

		THREAD	PER	O.D.	O.D.	LENGTH	LENGTH	GASKET	FEATURES	BALDWIN
		I.D.	Inch	Inches	(mm)	Inches	(mm)			NUMBER
SPIN-ON FILTER FEATURES ARE CODED AS FOLLOWS		3/4	16	3	76.2	5 3/32	129.4	[1] Included	AD	B143
		3/4	16	3	76.2	5 1/8	130.2	G449-B	AD, ADP, BP	BT215
		3/4	16	3 1/32	77.0	2 5/16	58.7	G449-B	AD, BP	B7165
		3/4	16	3 1/32	77.0	2 5/16	58.7	G449-B	SHBP	B7410
		3/4	16	3 1/32	77.0	3 3/16	81.0	[1] Included		B7287
		3/4	16	3 1/32	77.0	3 7/16	87.3	[1] Included	AD, BP	B131
		3/4	16	3 1/32	77.0	3 1/2	88.9	G449-B	AD, HBP	B1405
		3/4	16	3 1/32	77.0	3 1/2	88.9	G449-B	AD	B1407
		3/4	16	3 1/32	77.0	3 1/2	88.9	[1] Included		BF7648
		3/4	16	3 1/32	77.0	3 1/2	88.9	[1] Included	HBP	BT8323
AD	Anti-Drainback Valve	3/4	16	3 1/32	77.0	4 1/16	103.2	[1] Included	AD	B113
		3/4	16	3 1/32	77.0	4 3/32	104.0	[1] Included	AD, SHBP	B7139
ADP	Anti-Drainback Pipe	3/4	16	3 1/32	77.0	4 3/32	104.0	[1] Included	AD, HBP	BF172
		3/4	16	3 1/32	77.0	4 3/32	104.0	G449-B		BF7892
BP	8-10 PSID	3/4	16	3 1/32	77.0	4 3/32	104.0	[1] Included		BT8908
	By-Pass Valve	3/4	16	3 1/32	77.0	4 13/16	122.2	[1] Included		BF13
BPI	By-Pass Included	3/4	16	3 1/32	77.0	4 13/16	122.2	[1] Included	HBP	BF7458
		3/4	16	3 1/32	77.0	5 1/2	139.7	[1] Included	XHBP	BT8384
BPS	By-Pass Screen	3/4	16	3 1/32	77.0	5 11/16	144.5	G449-B	D, PS	BF1275
		3/4	16	3 1/32	77.0	5 13/16	147.6	[1] Included		BF941
BTA PLUS	Balanced Treatment	3/4	16	3 1/32	77.0	5 13/16	147.6	[1] Included	AD, HBP	B7091
	Additive Plus	3/4	16	3 1/32	77.0	5 27/32	148.4	[1] Included	AD	B295
BTE	Balanced Treatment	3/4	16	3 1/32	77.0	5 27/32	148.4	[1] Included	AD, HBP	BT353
	for Ethylene Glycol	3/4	16	3 1/32	77.0	5 7/8	149.2	G449-B		BF330
D	Drain	3/4	16	3 1/16	77.8	2 11/32	59.5	G449-B	AD, HBP	B7222
		3/4	16	3 1/16	77.8	3 7/16	87.3	[1] Included		BF954
FECV	Front-End	3/4	16	3 1/16	77.8	3 1/2	88.9	[1] Included		B40006
	Check Valve	3/4	16	3 3/32	78.6	3 31/32	100.8	[1] Included		BF7967
FP	Fill Port	3/4	16	3 1/8	79.4	3	76.2	[1] Included		BF7840
		3/4	16	3 1/8	79.4	3 21/32	92.9	[1] Included	MBP	B7434
HBP	18-25 PSID	3/4	16	3 1/8	79.4	3 7/8	98.4	[1] Included		BF7841
	High Pressure	3/4	16	3 1/8	79.4	4 1/32	102.4	[1] Included	AD, MBP	B7433
ISO	Inside-Out	3/4	16	3 1/4	82.6	3 5/32	80.2	[1] Included	AD, MBP	B7119
	Flow Direction	3/4	16	3 5/16	84.1	3 5/32	80.2	[1] Included		BF7601
LBP	2-7 PSID	3/4	16	3 11/32	84.9	4 5/8	117.5	[1] Included	SP	BF7598
	Low Pressure	3/4	16	3 9/16	90.5	5 7/16	138.1	G381-A	D, ISO, SP	BF7532
MBP	By-Pass Valve	3/4	16	3 9/16	90.5	5 7/16	138.1	G381-A	D, ISO, SP	BF7535
		3/4	16	3 19/32	91.3	5 1/8	130.2	[1] Included	AD, HBP	BF7369
PSR	11-17 PSID	3/4	16	3 19/32	91.3	5 1/8	130.2	[1] Included	MBP	B7470
	Medium Pressure	3/4	16	3 19/32	91.3	5 1/8	130.2	[1] Included		BF9843
SHBP	By-Pass Valve	3/4	16	3 19/32	91.3	5 3/8	136.5	[1] Included	MBP	B7473
		3/4	16	3 19/32	91.3	6 3/4	171.5	[1] Included	D	BF9849
MO	Metering Orifice	3/4	16	3 11/16	93.7	2 9/16	65.1	G381-A	AD, BP	B7221
		3/4	16	3 11/16	93.7	2 29/32	73.8	G401	AD, MBP	BT8493
PS	Integral Post Seal	3/4	16	3 11/16	93.7	3 1/4	82.6	G381-A	AD, BP	B132
	Gasket	3/4	16	3 11/16	93.7	3 1/4	82.6	G381-A	AD, HBP	B1434
RC	Reinforced Centertube	3/4	16	3 11/16	93.7	3 1/4	82.6	G381-A	AD, HBP	B7152
		3/4	16	3 11/16	93.7	3 1/4	82.6	G401	AD, MBP	B7240
SHBP	30-45 PSID	3/4	16	3 11/16	93.7	3 1/4	82.6	[1] Included	AD, MBP	B7511
	Super High Pressure	3/4	16	3 11/16	93.7	3 1/4	82.6	G324-A		BF7541
SP	Sensor Port	3/4	16	3 11/16	93.7	3 1/4	82.6	G324-A		BF7666
		3/4	16	3 11/16	93.7	3 1/4	82.6	G381-A		BT40028
XHBP	50+ PSID	3/4	16	3 11/16	93.7	3 7/8	98.4	G381-A	AD, BP	B34
	Extra High Pressure	3/4	16	3 11/16	93.7	3 7/8	98.4	G381-A	AD	B120
Do NOT Interchange Filters with Different Features	By-Pass Valve	3/4	16	3 11/16	93.7	3 7/8	98.4	G381-A	AD, BP	B163
		3/4	16	3 11/16	93.7	4 1/16	103.2	[1] Included		BT8916
		3/4	16	3 11/16	93.7	4 11/32	110.3	G381-A		BF9877
		3/4	16	3 11/16	93.7	4 3/8	111.1	G381-A	AD, HBP	B229
		3/4	16	3 11/16	93.7	4 3/8	111.1	G381-A	AD, BP	B233
		3/4	16	3 11/16	93.7	4 3/8	111.1	G324-A		BF719
		3/4	16	3 11/16	93.7	4 3/8	111.1	G381-A	AD, HBP	B7403
		3/4	16	3 11/16	93.7	4 3/8	111.1	G381-A		BF7559
		3/4	16	3 11/16	93.7	4 3/8	111.1	G324-A		BF7602
		3/4	16	3 11/16	93.7	4 7/16	112.7	G401	AD, SHBP	B1429
		3/4	16	3 11/16	93.7	4 7/16	112.7	G401	SHBP	B7099
		3/4	16	3 11/16	93.7	4 7/16	112.7	G401	AD, XHBP	B7128
		3/4	16	3 11/16	93.7	4 15/32	113.5	G401	AD, BP	BT420
		3/4	16	3 11/16	93.7	4 1/2	114.3	[1] Included	AD, ADP, BP	B7271
		3/4	16	3 11/16	93.7	5 3/8	136.5	G381-A	HBP	BT111



WARNING: These products can expose you to chemicals, including Diisononyl Phthalate, Carbon black extracts, Nickel, 1,3 Butadiene, Ethylene Oxide, Epichlorohydrin, which are known to the State of California to cause cancer, and Bisphenol-A, Ethylene Glycol, Ethylene Oxide, 1,3 Butadiene, Epichlorohydrin, which are known to the State of California to cause birth defects or other reproductive harm. For more information go to www.P65Warnings.ca.gov.

SPIN-ON FILTERS BY TAP SIZE (U.S. THREAD)

THREAD I.D.	PER Inch	O.D. Inches	O.D. (mm)	LENGTH Inches	LENGTH (mm)	GASKET	FEATURES	BALDWIN NUMBER
3/4	16	3 11/16	93.7	5 3/8	136.5	G381-A	AD	B118
3/4	16	3 11/16	93.7	5 3/8	136.5	G381-A	AD, ADP, BP	BT216
3/4	16	3 11/16	93.7	5 3/8	136.5	G324-A	AD, HBP	B244
3/4	16	3 11/16	93.7	5 3/8	136.5	G381-A	AD, ADP, MBP	B336
3/4	16	3 11/16	93.7	5 3/8	136.5	G381-A		BF797
3/4	16	3 11/16	93.7	5 3/8	136.5	G381-A	AD, SHBP	B7156
3/4	16	3 11/16	93.7	5 3/8	136.5	G381-A	AD, BP	B7467
3/4	16	3 11/16	93.7	5 3/8	136.5	[1] Included	ISO	BF7614
3/4	16	3 11/16	93.7	5 13/32	137.3	G381-A	AD, BP	B2
3/4	16	3 11/16	93.7	5 13/32	137.3	G381	AD, BP	B2-HPG
3/4	16	3 11/16	93.7	5 15/32	138.9	G401	AD, HBP	B252
3/4	16	3 11/16	93.7	5 15/32	138.9	G401	AD, ADP, HBP	B253
3/4	16	3 11/16	93.7	5 15/32	138.9	G401	AD, BP	BT8328
3/4	16	3 11/16	93.7	6 5/8	168.3	G381-A	XHBP	B481
3/4	16	3 11/16	93.7	7 1/8	181.0	G381-A	AD, ADP, BP	BT217
3/4	16	3 11/16	93.7	7 1/8	181.0	G381-A	AD, ADP, BP	BT237
3/4	16	3 11/16	93.7	7 1/8	181.0	G381-A	AD, BP	BT251
3/4	16	3 11/16	93.7	7 1/8	181.0	G381-A		B7231
3/4	16	3 11/16	93.7	7 1/8	181.0	G381-A	AD, BP	B7311-MPG
3/4	16	3 23/32	94.5	3 7/8	98.4	G324-A		BT8905
3/4	16	3 23/32	94.5	3 31/32	100.8	[1] Included	AD, BPI	B7298
3/4	16	3 23/32	94.5	4 15/32	113.5	G401	AD	B7047
3/4	16	3 3/4	95.3	3 13/16	96.8	[1] Included	AD, MBP	B7431
3/4	16	3 3/4	95.3	3 31/32	100.8	G381-A	AD, HBP	B74
3/4	16	3 3/4	95.3	3 31/32	100.8	G381-A		BT8301
3/4	16	3 3/4	95.3	3 31/32	100.8	G381-A		BT8486
3/4	16	3 3/4	95.3	5 9/32	134.1	G381-A	AD, SHBP	B114
3/4	16	3 3/4	95.3	5 9/32	134.1	G381-A	AD	B246
3/4	16	3 3/4	95.3	5 25/32	146.8	[1] Included	SHBP	BT8922
3/4	16	3 3/4	95.3	6 9/32	159.5	[1] Included	D	BF9904
3/4	16	3 25/32	96.0	5 9/32	134.1	G381-A	AD	B7022
3/4	16	3 25/32	96.0	5 23/32	145.3	[1] Included	AD, SHBP	BD7120
3/4	16	3 13/16	96.8	5 29/32	150.0	[1] Included	SHBP	B7486
3/4	16	4 1/4	108.0	3 15/16	100.0	G381-A	AD, BP	BT5
3/4	16	4 1/4	108.0	3 15/16	100.0	G381-A	PS	BF7593
3/4	16	4 1/4	108.0	4 3/8	111.1	G381-A	AD, FECV, SHBP	B7219
3/4	16	4 1/4	108.0	5 11/16	144.5	[1] Included	ADP, SHBP	BD232
3/4	16	4 1/4	108.0	5 13/16	147.6	G381-A	AD, HBP	BT267
3/4	16	4 1/4	108.0	5 13/16	147.6	G381-A	AD, ADP, SHBP	BT348
3/4	16	4 1/4	108.0	5 13/16	147.6	G381-A	AD, ADP, SHBP	BT7316
3/4	16	4 1/4	108.0	5 7/8	149.2	G401		B7018
3/4	16	4 1/4	108.0	7 11/32	186.5	G381-A	AD, HBP	BT238
3/4	16	4 1/4	108.0	7 11/32	186.5	G381-A	AD, ADP, SHBP	BT347
3/4	16	4 1/4	108.0	7 11/32	186.5	G381-A		BF783
3/4	20	2 7/8	73.0	3	76.2	[1] Included	BP	BT8460
3/4	20	3 1/32	77.0	3 1/2	88.9	[1] Included		BT8413
3/4	20	3 11/16	93.7	4 3/8	111.1	G381-A		B369
3/4	20	3 11/16	93.7	5 3/8	136.5	G381-A		B5176
3/4	20	3 11/16	93.7	5 3/8	136.5	G381-A	BTE	BW5178
3/4	20	3 11/16	93.7	5 3/8	136.5	G381-A	BTE, MO	BW5201
3/4	20	3 11/16	93.7	5 3/8	136.5	G381-A		B7025
3/4	20	4 1/4	108.0	7 3/8	187.3	G401		B128
13/16	12	3 11/16	93.7	6 5/8	168.3	[1] Included	PS	BF7640
13/16	12	3 11/16	93.7	7 3/32	180.2	[1] Included	PS	BF5810
13/16	12	3 11/16	93.7	7 3/32	180.2	[1] Included	PS	BF5815
13/16	12	3 11/16	93.7	7 3/32	180.2	[1] Included	PS	BF5816
13/16	12	3 23/32	94.5	4 13/32	111.9	[1] Included	PS	BF593
13/16	12	4 1/4	108.0	7 5/8	193.7	G381-A	PS	BF7612
13/16	12	4 1/4	108.0	10 7/16	265.1	G381-A	PS	BF7613
13/16	16	3	76.2	3 1/2	88.9	G449-B	AD	B31
13/16	16	3	76.2	4 3/32	104.0	G449-B	AD	B1432
13/16	16	3	76.2	4 3/32	104.0	[1] Included		B7010
13/16	16	3	76.2	5 1/8	130.2	G449-B		B30
13/16	16	3 1/32	77.0	4 1/8	104.8	G449-B	MBP	B1447
13/16	16	3 1/32	77.0	4 13/16	122.2	G449-B	SHBP	BT8417
13/16	16	3 1/32	77.0	5 1/2	139.7	[1] Included	XHBP	BT9402
13/16	16	3 5/8	92.1	3 7/8	98.4	[1] Included	AD, MBP	B7291
13/16	16	3 11/16	93.7	2 29/32	73.8	G401		BT779

CAUTION!!! Read These Instructions Before Using Size Charts

The filter size charts on this and following pages are for filter experts. Careless use could lead to errors. When you have exhausted all other ways to determine a filter number, locate a suspect here, then check the Product Guide for confirmation.

Size alone does not assure you of the right filtering media, gasket or other features. What is being filtered, filter efficiency, flow rate and direction of flow all have to be considered.

Spin-on filters are listed by tap size rather than length. All other filters are listed on an overall basis. Check your Product Guide for other dimensions. Progression is from the smallest to the largest in each category.

Do NOT Interchange Filters with Different Features

Be Sure to Check Product Guide, Cross-References and Applications

We Cannot be Responsible for Misapplications



WARNING: These products can expose you to chemicals, including Diisononyl Phthalate, Carbon black extracts, Nickel, 1,3 Butadiene, Ethylene Oxide, Epichlorohydrin, which are known to the State of California to cause cancer, and Bisphenol-A, Ethylene Glycol, Ethylene Oxide, 1,3 Butadiene, Epichlorohydrin, which are known to the State of California to cause birth defects or other reproductive harm. For more information go to www.P65Warnings.ca.gov.

SPIN-ON FILTERS BY TAP SIZE (U.S. THREAD)

A TYPICAL SPIN-ON

Spin-ons vary in size, media, fittings and other features. Let's look at the usual components.

Spin-on Can



No housing to clean; faster to change.

Baseplate and Seaming Cover Assembly



Size of mounting hole and gasket location determine if filter will seal. The baseplate is attached to the seaming cover and the seaming cover is attached to the can. (The gasket fits in the seaming cover.)

Compression Spring



Holds element in place to maintain seal.

Element End Caps

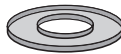

Closed End

Open End

End caps are bonded to the media.

Filtering Media



Microlite® pleated paper comes in more than 60 types for exact filtering requirements.

Centertube



Media is wrapped around the spiral perforated/louvered steel tube.

THREAD I.D.	PER Inch	O.D. Inches	O.D. (mm)	LENGTH Inches	LENGTH (mm)	GASKET	FEATURES	BALDWIN NUMBER
13/16	16	3 11/16	93.7	3 3/16	81.0	[1] Included	AD	B1438
13/16	16	3 11/16	93.7	4 3/8	111.1	G381-A	AD	B39
13/16	16	3 11/16	93.7	4 3/8	111.1	G381-A	LBP	B358
13/16	16	3 11/16	93.7	5 5/16	134.9	[1] Included	AD, MBP	B1441
13/16	16	3 11/16	93.7	5 11/32	135.7	[1] Included		B6
13/16	16	3 11/16	93.7	5 11/32	135.7	[1] Included		B6-HPG
13/16	16	3 11/16	93.7	5 11/32	135.7	[1] Included	AD, HBP	B279
13/16	16	3 11/16	93.7	5 11/32	135.7	[1] Included	AD	B1428
13/16	16	3 11/16	93.7	5 3/8	136.5	[1] Included	AD	B9
13/16	16	3 11/16	93.7	5 3/8	136.5	G381-A	BP	BT112
13/16	16	3 11/16	93.7	5 13/32	137.3	G401	HBP	BT259
13/16	16	3 11/16	93.7	7 7/16	188.9	G381-A	D	BF974-D
13/16	16	3 11/16	93.7	8 11/16	220.7	[1] Included		B7
13/16	16	3 11/16	93.7	8 23/32	221.5	G381-A	AD	BT525
13/16	16	3 23/32	94.5	4 15/32	113.5	G401	HBP	BT344-S
13/16	16	3 23/32	94.5	5 15/32	138.9	G401		BT438
13/16	16	3 23/32	94.5	5 15/32	138.9	G401	HBP	BT359
13/16	16	3 3/4	95.3	6 1/32	153.2	[1] Included		BT8439-MPG
13/16	16	3 13/16	96.8	4 3/8	111.1	[1] Included		B27
13/16	16	3 13/16	96.8	4 3/8	111.1	[1] Included	AD, BP	BT241
13/16	16	3 13/16	96.8	4 3/8	111.1	[1] Included	AD	B360
13/16	16	4 1/4	108.0	7 11/32	186.5	G381-A		BT350
13/16	18	3	76.2	3 15/32	88.1	G449-B	PS	BF7969
13/16	18	3 11/16	93.7	4 11/16	119.1	G401		BF863
13/16	18	3 11/16	93.7	5 5/16	134.9	G401	SP	BF7985
13/16	18	3 11/16	93.7	5 13/32	137.3	G401		BF7879
13/16	18	3 11/16	93.7	5 21/32	143.7	G401	D	BF896
13/16	18	3 11/16	93.7	6 1/8	155.6	G401	PSR, SP	BF7981
13/16	18	3 11/16	93.7	6 1/4	158.8	G401	D, PSR	BF1280
13/16	18	4 1/4	108.0	7 11/32	186.5	G381-A	PS	BF877
13/16	18	4 1/4	108.0	8 1/8	206.4	G381-A	D, PS	BF1219
7/8	14	3	76.2	5 7/8	149.2	G449-B	PS	BF7531
7/8	14	3	76.2	7 1/8	181.0	[1] Included		BF7634
7/8	14	3 11/16	93.7	4 3/8	111.1	G381-A	AD, BP	BT264
7/8	14	3 11/16	93.7	5 3/8	136.5	G381-A	BP	BT361
7/8	14	3 11/16	93.7	5 3/8	136.5	G381-A	HBP	BT395
7/8	14	3 11/16	93.7	5 3/8	136.5	[1] Included	PS	BF992
7/8	14	3 11/16	93.7	7 1/8	181.0	G381-A	AD, BP	BT126
7/8	14	3 11/16	93.7	7 1/8	181.0	G381-A	PS	BF7632
7/8	14	3 11/16	93.7	7 1/8	181.0	G381-A	PS, PSR	BF7917
7/8	14	3 11/16	93.7	8 11/16	220.7	G381-A	PS	BF888
7/8	14	3 11/16	93.7	10 1/2	266.7	G381-A	PS	BF7631
7/8	14	3 23/32	94.5	7 5/32	181.8	G381-A		BF7815
7/8	14	3 23/32	94.5	7 5/32	181.8	G381-A	PS, PSR	BF7924
7/8	14	3 3/4	95.3	6 1/32	153.2	[1] Included	BPS, XHBP	BT8843-MPG
7/8	14	4 1/4	108.0	4 11/16	119.1	G381-A	PS	BF786
7/8	14	4 1/4	108.0	6 11/16	169.9	[1] Included	D, PS	BF7853
7/8	14	4 1/4	108.0	7	177.8	G401	PS	BF7629
7/8	14	4 1/4	108.0	7 11/32	186.5	G381-A	PS	BF588
7/8	14	4 1/4	108.0	8 17/32	216.7	G401	D, PS	BF7584
7/8	14	4 3/8	111.1	8 11/16	220.7	[1] Included		BF9866-O
7/8	14	4 13/32	111.9	5 29/32	150.0	[1] Included		BF7717
7/8	16	4 1/4	108.0	7 11/32	186.5	G381-A	AD, HBP	BT124
7/8	16	4 1/4	108.0	7 11/32	186.5	G381-A	AD	BT521
7/8	16	4 1/4	108.0	7 11/32	186.5	G381-A	PS	BF876
7/8	16	4 1/4	108.0	7 11/32	186.5	G381-A	PS	BF7911
7/8	16	4 1/4	108.0	7 3/8	187.3	G401	AD	B326
15/16	16	3 11/16	93.7	4 23/32	119.9	G401	PSR	BF862
15/16	16	3 11/16	93.7	5 3/8	136.5	G381-A	PS	BF583
15/16	16	3 11/16	93.7	5 3/8	136.5	G381-A	PSR	BF962
15/16	16	3 11/16	93.7	5 13/32	137.3	G401	PSR	BF582
15/16	16	3 11/16	93.7	7 3/16	182.6	G401	PS, PSR	BF591
15/16	16	3 11/16	93.7	7 17/32	191.3	G401	D, PSR	BF597
15/16	16	4 1/4	108.0	8 17/32	216.7	G401	D, ISO	BF1211
15/16	16	4 1/4	108.0	11 11/32	288.1	G401	D, ISO	BF1210
31/32	20	3 21/32	92.9	5 3/8	136.5			B7395



WARNING: These products can expose you to chemicals, including Diisononyl Phthalate, Carbon black extracts, Nickel, 1,3 Butadiene, Ethylene Oxide, Epichlorohydrin, which are known to the State of California to cause cancer, and Bisphenol-A, Ethylene Glycol, Ethylene Oxide, 1,3 Butadiene, Epichlorohydrin, which are known to the State of California to cause birth defects or other reproductive harm. For more information go to www.P65Warnings.ca.gov.

SPIN-ON FILTERS BY TAP SIZE (U.S. THREAD)

THREAD I.D.	PER Inch	O.D. Inches	O.D. (mm)	LENGTH Inches	LENGTH (mm)	GASKET	FEATURES	BALDWIN NUMBER
31/32	20	3 21/32	92.9	5 5/8	142.9	G381-A		BT606-MPG
31/32	20	3 21/32	92.9	5 5/8	142.9	[1] Included	HBP	BT8440-MPG
1	12	3	76.2	4 27/32	123.0	G449-B	AD, HBP	B1435
1	12	3 19/32	91.3	5 1/8	130.2	[1] Included	AD, SHBP	B7370
1	12	3 19/32	91.3	5 1/8	130.2	[1] Included		B7464
1	12	3 19/32	91.3	5 7/16	138.1	[1] Included	HBP	B7465
1	12	3 19/32	91.3	5 5/8	142.9	[1] Included	AD, HBP	B7457
1	12	3 19/32	91.3	6 5/8	142.9	[1] Included	SHBP	B7461
1	12	3 19/32	91.3	5 5/8	142.9	[1] Included	SHBP	B7462
1	12	3 19/32	91.3	6 5/8	168.3	[1] Included	AD, HBP	B7387
1	12	3 19/32	91.3	7 9/16	192.1	[1] Included	HBP	B7474
1	12	3 19/32	91.3	8 1/8	206.4	[1] Included	AD, SHBP	B7367
1	12	3 19/32	91.3	8 1/8	206.4	[1] Included	AD, SHBP	B7392
1	12	3 19/32	91.3	8 1/8	206.4	[1] Included	HBP	B7475
1	12	3 21/32	92.9	4 1/4	108.0	[1] Included		BT8918
1	12	3 21/32	92.9	6 25/32	172.2	[1] Included	XHBP	BT8926
1	12	3 11/16	93.7	3 1/4	82.6	G381-A	BP	BT346
1	12	3 11/16	93.7	3 1/4	82.6	G381-A	LBP	BT357
1	12	3 11/16	93.7	3 1/4	82.6	G381-A	AD, SHBP	B7220
1	12	3 11/16	93.7	4 1/8	104.8	[1] Included	PS	BF1278-O
1	12	3 11/16	93.7	4 11/32	110.3	[1] Included		BF592
1	12	3 11/16	93.7	4 3/8	111.1	G381-A	SHBP	BT536
1	12	3 11/16	93.7	4 3/8	111.1	[1] Included	ADP, BPI	B7274
1	12	3 11/16	93.7	4 3/8	111.1	G381-A		BF7968
1	12	3 11/16	93.7	4 7/16	112.7	G401	AD, HBP	B7424
1	12	3 11/16	93.7	5 11/32	135.7	[1] Included		BF7774
1	12	3 11/16	93.7	5 3/8	136.5	G381-A	BP	BT274
1	12	3 11/16	93.7	5 3/8	136.5	G381-A	AD, SHBP	BT292
1	12	3 11/16	93.7	5 3/8	136.5	G381-A	HBP	BT364
1	12	3 11/16	93.7	5 3/8	136.5	G381-A		BF955
1	12	3 11/16	93.7	5 3/8	136.5	G381-A		BF956
1	12	3 11/16	93.7	5 3/8	136.5	G381-A	AD, SHBP	B7320
1	12	3 11/16	93.7	5 3/8	136.5	G381-A		BT8445
1	12	3 11/16	93.7	5 13/32	137.3	G401	HBP	BT452
1	12	3 11/16	93.7	5 13/32	137.3	G401		BT839
1	12	3 11/16	93.7	5 13/32	137.3	G401		BT839-10
1	12	3 11/16	93.7	5 13/32	137.3	G401		BT8420
1	12	3 11/16	93.7	5 13/32	137.3	G401		BT8501-MPG
1	12	3 11/16	93.7	5 13/32	137.3	G401		BT8502
1	12	3 11/16	93.7	5 15/32	138.9	G401		B255
1	12	3 11/16	93.7	5 15/32	138.9	G401		BT8428-MPG
1	12	3 11/16	93.7	5 15/32	138.9	[1] Included		BT9465
1	12	3 11/16	93.7	5 15/32	141.5	G401		BT23611
1	12	3 11/16	93.7	5 5/8	142.9	G381-A		BF7750
1	12	3 11/16	93.7	6 1/16	154.0	G401	SHBP	BT8415
1	12	3 11/16	93.7	6 1/8	155.6	[1] Included	D	BF781
1	12	3 11/16	93.7	6 5/32	156.4	[1] Included	D, PSR	BF1266
1	12	3 11/16	93.7	6 7/32	158.0	[1] Included	D	BF1278
1	12	3 11/16	93.7	6 5/8	168.3	G381-A	HBP	BT342
1	12	3 11/16	93.7	6 5/8	168.3	G381-A	AD, SHBP	B7031
1	12	3 11/16	93.7	6 5/8	168.3	G381-A	SHBP	B7089
1	12	3 11/16	93.7	6 5/8	168.3	G381-A	HBP	B7215
1	12	3 11/16	93.7	7 1/8	181.0	G381-A	AD, BP	B167
1	12	3 11/16	93.7	7 1/8	181.0	G381-A	AD, ADP	BT261
1	12	3 11/16	93.7	7 1/8	181.0	G381-A		BF971
1	12	3 11/16	93.7	7 1/8	181.0	G381-A	AD, BP	B975
1	12	3 11/16	93.7	7 1/8	181.0	G381-A		BT40032
1	12	3 11/16	93.7	7 5/32	181.8	G401	AD, ADP	B299
1	12	3 11/16	93.7	7 3/16	182.6	G401		BT365
1	12	3 11/16	93.7	7 3/16	182.6	G401		BT365-10
1	12	3 11/16	93.7	7 3/16	182.6	G401		BF7606
1	12	3 11/16	93.7	7 3/16	182.6	G401		BT8900
1	12	3 11/16	93.7	7 13/32	188.1	[1] Included	D	BF1213
1	12	3 11/16	93.7	7 13/32	188.1	[1] Included	D	BF7759
1	12	3 11/16	93.7	7 7/16	188.9	G381-A	D	BF915
1	12	3 11/16	93.7	8	203.2	[1] Included		BF5800
1	12	3 11/16	93.7	8 1/8	206.4	G381-A	AD, SHBP	B236
1	12	3 11/16	93.7	8 1/8	206.4	G381-A	AD, XHBP	B403

SPIN-ON FEATURES

Some spin-ons have no additional features while others have several. Here are some of the more important spin-on features:

Anti-Drainback Valve



As the name implies, this valve keeps the oil from draining from a filter when the engine is shut off. (Some filters include an anti-drainback standpipe for the same function). The mounting direction determines the need for this feature.

By-Pass Valve



Full-flow oil systems require a by-pass (relief) valve either in the system or in the filter. This valve opens at a predetermined setting to assure oil flow to the bearings at all times.

Integral Post Seal



Seals threaded stud to prevent tiny particles from spiraling in via the threads.

We Cannot be Responsible for Misapplications



WARNING: These products can expose you to chemicals, including Diisononyl Phthalate, Carbon black extracts, Nickel, 1,3 Butadiene, Ethylene Oxide, Epichlorohydrin, which are known to the State of California to cause cancer, and Bisphenol-A, Ethylene Glycol, Ethylene Oxide, 1,3 Butadiene, Epichlorohydrin, which are known to the State of California to cause birth defects or other reproductive harm. For more information go to www.P65Warnings.ca.gov.

SPIN-ON FILTERS BY TAP SIZE (U.S. THREAD)

	THREAD I.D.	PER Inch	O.D. Inches	O.D. (mm)	LENGTH Inches	LENGTH (mm)	GASKET	FEATURES	BALDWIN NUMBER
SPIN-ON FILTER FEATURES ARE CODED AS FOLLOWS	1	12	3 11/16	93.7	8 1/8	206.4	G381-A	XHBP	B7143
	1	12	3 11/16	93.7	8 1/8	206.4	G381-A	AD, FECV, XHBP	B7170
	1	12	3 11/16	93.7	8 23/32	221.5	G381-A	SHBP	B262
	1	12	3 11/16	93.7	8 23/32	221.5	G381-A	FECV, SHBP	BT778
	1	12	3 11/16	93.7	8 23/32	221.5	[1] Included		BF9913
	1	12	3 11/16	93.7	8 25/32	223.0	G401		BT8903
	1	12	3 11/16	93.7	8 13/16	223.8	[1] Included	D	BF5813
	1	12	3 23/32	94.4	3 5/16	84.1	G401	AD, SHBP	BT9456
	1	12	3 23/32	94.5	5 21/32	143.7	G401	PS	BF7987
	1	12	3 23/32	94.5	5 21/32	143.7	G401	PS	BF7988
AD Anti-Drainback Valve	1	12	3 23/32	94.5	6 23/32	170.7	G401	AD	B7044
ADP Anti-Drainback Pipe	1	12	3 23/32	94.5	6 23/32	170.7	G401	SHBP	BT8512
BP 8-10 PSID By-Pass Valve	1	12	3 23/32	94.5	7 7/32	183.4	G401		BT8347
BPI By-Pass Included	1	12	3 23/32	94.5	8 1/8	206.4	[1] Included		BT8497-MPG
BPS By-Pass Screen	1	12	3 23/32	94.5	8 3/16	208.0	G401		BT8443
BTA PLUS	1	12	3 23/32	94.5	8 3/16	208.0	[1] Included		BT8444
Balanced Treatment Additive Plus	1	12	3 23/32	94.5	8 7/32	208.8	G401	SHBP	BT7735
BTE Balanced Treatment for Ethylene Glycol Antifreeze	1	12	3 23/32	94.5	8 9/32	210.3	[1] Included		B9601
	1	12	3 23/32	94.5	8 7/8	225.4	G401	SHBP	BT7739
	1	12	3 3/4	95.3	7 13/32	188.1			BF5813-O
			UNF-2B						
	1	12	3 25/32	96.0	3 1/4	82.6			BF46017-O
	1	12	3 25/32	96.0	4 1/32	102.4			BF7968-O
D Drain	1	12	3 25/32	96.0	4 27/32	123.0	[1] Included	AD, SHBP	BT9553
FECV Front-End Check Valve	1	12	3 13/16	96.8	3 13/16	96.8	[1] Included	AD, HBP	BT9561
	1	12	4 1/32	102.4	11	279.4	[1] Included		BF46071
FP Fill Port	1	12	4 7/32	107.2	5 1/8	130.2	[1] Included	AD, ADP, PS	BD142
HBP 18-25 PSID High Pressure By-Pass Valve	1	12	4 1/4	108.0	4 1/32	102.4	[1] Included	AD, SHBP	B7131
	1	12	4 1/4	108.0	4 13/32	111.9	[1] Included	HBP	B7385
	1	12	4 1/4	108.0	4 13/32	111.9	[1] Included	HBP	B7386
	1	12	4 1/4	108.0	4 11/16	119.1	G381-A	AD, HBP	B447
	1	12	4 1/4	108.0	4 3/4	120.7	[1] Included	AD, SHBP	B7373
ISO Inside-Out Flow Direction	1	12	4 1/4	108.0	5 13/16	147.6	[1] Included	MBP	B7130
			UNS-2B						B40054
	1	12	4 1/4	108.0	5 27/32	148.4	[1] Included	AD, MBP	B7144
LBP 2-7 PSID Low Pressure By-Pass Valve	1	12	4 1/4	108.0	5 7/8	149.2	G401	HBP	BT355
	1	12	4 1/4	108.0	5 7/8	149.2	G401	BP	B7009
	1	12	4 1/4	108.0	5 7/8	149.2	[1] Included	AD, HBP	B7389
MBP 11-17 PSID Medium Pressure By-Pass Valve	1	12	4 1/4	108.0	7 3/8	187.3	G401		B129
	1	12	4 1/4	108.0	7 3/8	187.3	G401	HBP	B157
	1	12	4 1/4	108.0	7 3/8	187.3	G401		B309
	1	12	4 1/4	108.0	9 1/8	231.8	G401		B263
	1	12	4 1/4	108.0	9 1/8	231.8	G401	AD, HBP	BT349
MO Metering Orifice	1	12	4 1/4	108.0	9 1/8	231.8	G401	SHBP	B7151
PS Integral Post Seal Gasket	1	12	4 1/4	108.0	9 3/16	233.4	G401	AD, SHBP	BT8302
	1	12	4 1/4	108.0	11 11/16	296.9	[1] Included	D, PS, SP	BF1353-SPS
PSR Post Seal Required; Must install loose O-Ring or D-Ring on Post for Seal	1	12	4 9/32	108.7	11 7/32	285.0	[1] Included	D, PS, SP	BF1285-SP
	1	14	2 5/8	66.7	4 5/32	105.6			BF7609
	1	14	3 1/32	77.0	7 1/8	181.0	G449-B		BF7637
	1	14	3 1/4	82.6	6 21/32	169.1	[1] Included		BF9876
	1	14	3 19/32	91.3	6 23/32	170.7	[1] Included		BF9854
	1	14	3 19/32	91.3	7 7/8	200.0	[1] Included	D, PS	BF9831
RC Reinforced Centertube	1	14	3 21/32	92.9	4 1/8	104.8	[1] Included		BF9922-O
SHBP 30-45 PSID Super High Pressure By-Pass Valve	1	14	3 21/32	92.9	4 19/32	116.7	[1] Included		BF1282-O
	1	14	3 21/32	92.9	5 5/8	142.9	[1] Included	PS	BF1366-O
	1	14	3 21/32	92.9	5 5/8	142.9	[1] Included	ISO, PS	BF1398-O
	1	14	3 21/32	92.9	6 5/8	168.3	G381-A	PS	BF1249-O
SP Sensor Port	1	14	3 21/32	92.9	8 3/8	212.7	[1] Included		BF46065-SPS
			UNS-2B						
XHBP 50+ PSID Extra High Pressure By-Pass Valve	1	14	3 11/16	93.7	3 13/16	96.8	G381-A		BT8499
	1	14	3 11/16	93.7	4 1/32	102.4			BF46022-O
	1	14	3 11/16	93.7	4 1/16	103.2			BF46021-O
	1	14	3 11/16	93.7	4 1/8	104.8	[1] Included		BF9926-O
	1	14	3 11/16	93.7	4 3/8	111.1	G381-A	PSR	BF948
	1	14	3 11/16	93.7	4 11/16	119.1	G381-A	D, PSR	BF948-JD
	1	14	3 11/16	93.7	5 7/32	132.6	[1] Included	D, ISO	BF1253
	1	14	3 11/16	93.7	5 5/16	134.9	G381-A	PS	BF984
	1	14	3 11/16	93.7	5 11/32	135.7	[1] Included		BF585

Do NOT Interchange Filters with Different Features



WARNING: These products can expose you to chemicals, including Diisononyl Phthalate, Carbon black extracts, Nickel, 1,3 Butadiene, Ethylene Oxide, Epichlorohydrin, which are known to the State of California to cause cancer, and Bisphenol-A, Ethylene Glycol, Ethylene Oxide, 1,3 Butadiene, Epichlorohydrin, which are known to the State of California to cause birth defects or other reproductive harm. For more information go to www.P65Warnings.ca.gov.

SPIN-ON FILTERS BY TAP SIZE (U.S. THREAD)

THREAD I.D.	PER Inch	O.D. Inches	O.D. (mm)	LENGTH Inches	LENGTH (mm)	GASKET	FEATURES	BALDWIN NUMBER
1	14	3 11/16	93.7	5 7/16	138.1	G381-A	PSR	BF957
1	14	3 11/16	93.7	5 7/16	138.1	G381-A	D, PSR	BF957-D
1	14	3 11/16	93.7	5 5/8	142.9	G381-A	D, PS, PSR	BF1248
1	14	3 11/16	93.7	5 11/16	144.5	G381-A	D, PS	BF891
1	14	3 11/16	93.7	5 11/16	144.5	G401		BF7760
1	14	3 11/16	93.7	6 1/16	154.0	[1] Included	D, ISO, PS	BF1204
1	14	3 11/16	93.7	6 1/16	154.0	[1] Included	D, ISO, PS, SP	BF1204-SP
1	14	3 11/16	93.7	6 1/16	154.0	[1] Included	D, ISO, PS	BF1205
1	14	3 11/16	93.7	6 1/16	154.0	[1] Included	D, ISO, PS, SP	BF1205-SP
1	14	3 11/16	93.7	6 1/16	154.0	[1] Included	D, PSR, SP	BF1270-SP
1	14	3 11/16	93.7	6 5/32	156.4	G381-A	D, PSR	BF1282
1	14	3 11/16	93.7	6 3/16	157.2	G381-A	D, PS, PSR	BF1220
1	14	3 11/16	93.7	6 7/32	158.0	[1] Included	D, FEVCV	BF7806
1	14	3 11/16	93.7	6 11/16	169.9	G401	PS	BF7529
1	14	3 11/16	93.7	6 11/16	169.9	G401	PS	BF7923
1	14	3 11/16	93.7	6 31/32	177.0	G401	D, PS, PSR	BF7546
1	14	3 11/16	93.7	7 1/8	181.0	G381-A	PS	BF970
1	14	3 11/16	93.7	7 1/8	181.0	G381-A	PS	BF991
1	14	3 11/16	93.7	7 1/8	181.0	G381-A	PSR	BF7557
1	14	3 11/16	93.7	7 1/8	181.0	G381-A	PS	BF7633
1	14	3 11/16	93.7	7 3/8	187.3	G381-A	D, PS	BF1225
1	14	3 11/16	93.7	7 3/8	187.3	G381-A	D, PS	BF1268
1	14	3 11/16	93.7	7 3/8	187.3	G381-A	D, SP	BF1385-SPS
1	14	3 11/16	93.7	7 13/32	188.1	G381-A	D, PS	BF1214
1	14	3 11/16	93.7	7 13/32	188.1	G381-A	D, PSR	BF1252
1	14	3 11/16	93.7	7 13/32	188.1	G381-A	D	BF1376
1	14	3 11/16	93.7	7 7/16	188.9	G381-A	D, PSR	BF1212
1	14	3 11/16	93.7	7 7/16	188.9	G381-A	D, PSR	BF1258
1	14	3 11/16	93.7	7 13/16	198.4	[1] Included	D, PSR, SP	BF1350-SP
1	14	3 11/16	93.7	7 13/16	198.4	[1] Included	D, PSR, SP	BF1384-SP
1	14	3 11/16	93.7	8 1/32	204.0	G381-A	PSR	BF5801
1	14	3 11/16	93.7	8 23/32	221.5	G381-A	PS	BF978
1	14	3 11/16	93.7	8 23/32	221.5	G381-A	PS	BF979
1	14	3 11/16	93.7	8 23/32	221.5	G381-A	PSR	BF7558
1	14	3 11/16	93.7	8 25/32	223.0	G401	PS	BF577
1	14	3 11/16	93.7	8 13/16	223.8	G381-A	D, PS, PSR, SP	BF1393-SP
1	14	3 11/16	93.7	8 27/32	224.6	G381-A	D, PSR	BF5812
1	14	3 11/16	93.7	8 7/8	225.4	G401	D, SP	BF1394-SP
1	14	3 11/16	93.7	8 29/32	226.2	G381-A	D, PSR, SP	BF1249
1	14	3 11/16	93.7	8 29/32	226.2	G381-A	D, PSR	BF1249-SP
1	14	3 11/16	93.7	9 1/32	229.4	G381-A	D, PS	BF892
1	14	3 11/16	93.7	9 15/32	240.5	G381-A	D, PSR, SP	BF1272-SPS
1	14	3 11/16	93.7	9 17/32	242.1	G381-A	D, PSR	BF1259
1	14	3 11/16	93.7	9 17/32	242.1	G401	PSR, SP	BF7798-SP
1	14	3 11/16	93.7	10 1/32	254.8	G381-A	ADP, D, SP, SPR	BF1293-SPS
1	14	3 11/16	93.7	10 1/2	266.7	G381-A	PS	BF614
1	14	3 11/16	93.7	10 1/2	266.7	G381-A		BF7587
1	14	3 11/16	93.7	10 1/2	266.7	[1] Included		BF7753
1	14	3 23/32	94.5	7 15/16	201.6	G381-A	D	BF1279
1	14	3 23/32	94.5	8 1/8	206.4	G401	SHBP	BF7357
1	14	3 23/32	94.5	8 7/32	208.8	G401		BF9927
1	14	3 23/32	94.5	10 1/32	254.8	G381-A	D, PSR, SP	BF1378-SPS
1	14	3 3/4	95.3	3 9/16	90.5			BF46023-O
1	14	3 3/4	95.3	3 9/16	90.5			BF46024-O
1	14	3 3/4	95.3	4 21/32	118.3			BF46026-O
1	14	3 3/4	95.3	4 11/16	119.1			BF1204-O
1	14	3 25/32	96.0	4 1/32	102.4			BF46029-O
1	14	3 25/32	96.0	5 1/2	139.7			BF46030-O
1	14	3 13/16	96.8	3 9/32	83.3			BF46019-O
1	14	3 13/16	96.8	3 9/32	83.3			BF46020-O
1	14	4 1/32	102.4	11	279.4	[1] Included		BF46072
1	14	4 5/32	105.6	6 5/16	160.3	[1] Included	PS	BF1292-O
1	14	4 1/4	108.0	3 15/32	88.1	[1] Included		BF9912-O
1	14	4 1/4	108.0	3 17/32	89.7	[1] Included	PS	BF1389-O
1	14	4	108.0	4 1/16	103.2			BF46028-O
1	14	4 1/4	108.0	4 1/8	104.8	[1] Included	PS	BF1222-O
1	14	4 1/4	108.0	5 1/32	127.8	[1] Included		BF1295-O
1	14	4 1/4	108.0	5 1/8	130.2	[1] Included	PS	BF1388-O
1	14	4 1/4	108.0	5 3/16	131.8	[1] Included	D, PS	BF1348-O

CAUTION!!! Read These Instructions Before Using Size Charts

The filter size charts on this and following pages are for filter experts. Careless use could lead to errors. When you have exhausted all other ways to determine a filter number, locate a suspect here, then check the Product Guide for confirmation.

Size alone does not assure you of the right filtering media, gasket or other features. What is being filtered, filter efficiency, flow rate and direction of flow all have to be considered.

Spin-on filters are listed by tap size rather than length. All other filters are listed on an overall basis. Check your Product Guide for other dimensions. Progression is from the smallest to the largest in each category.

Do NOT Interchange Filters with Different Features

Be Sure to Check Product Guide, Cross-References and Applications

We Cannot be Responsible for Misapplications



WARNING: These products can expose you to chemicals, including Diisononyl Phthalate, Carbon black extracts, Nickel, 1,3 Butadiene, Ethylene Oxide, Epichlorohydrin, which are known to the State of California to cause cancer, and Bisphenol-A, Ethylene Glycol, Ethylene Oxide, 1,3 Butadiene, Epichlorohydrin, which are known to the State of California to cause birth defects or other reproductive harm. For more information go to www.P65Warnings.ca.gov.

SPIN-ON FILTERS BY TAP SIZE (U.S. THREAD)

A TYPICAL SPIN-ON

Spin-ons vary in size, media, fittings and other features. Let's look at the usual components.

Spin-on Can



No housing to clean; faster to change.

Baseplate and Seaming Cover Assembly



Size of mounting hole and gasket location determine if filter will seal. The baseplate is attached to the seaming cover and the seaming cover is attached to the can. (The gasket fits in the seaming cover.)

Compression Spring



Holds element in place to maintain seal.

Element End Caps



Closed End

Open End

End caps are bonded to the media.

Filtering Media



MicroLite® pleated paper comes in more than 60 types for exact filtering requirements.

Centertube



Media is wrapped around the spiral perforated/louvered steel tube.

THREAD I.D.	PER Inch	O.D. Inches	O.D. (mm)	LENGTH Inches	LENGTH (mm)	GASKET	FEATURES	BALDWIN NUMBER
1	14	4 1/4	108.0	5 3/16	131.8	[1] Included	PS	BF1386-O
1	14	4 1/4	108.0	5 7/32	132.6	[1] Included	PS	BF1223-O
1	14	4 1/4	108.0	5 9/32	134.1	[1] Included		BF1345-O
1	14	4 1/4	108.0	5 1/2	139.7			BF46031
1	14	4 1/4	108.0	5 11/16	144.5	[1] Included	PS	BF9816
1	14	4 1/4	108.0	5 29/32	150.0	[1] Included	PS	BF1224
1	14	4 1/4	108.0	6 5/32	156.4	[1] Included		BF1298-O
1	14	4 1/2	108.0	6 3/16	157.2			BF46083-O
1	14	4 1/4	108.0	6 9/32	159.5			BF46098-O
1	14	4 1/4	108.0	6 5/16	160.3	[1] Included	PS	BF1329-O
1	14	4 1/4	108.0	6 5/16	160.3	[1] Included		BF1346-O
1	14	4 1/4	108.0	6 5/16	160.3	[1] Included	PS	BF1387-O
1	14	4 1/4	108.0	6 5/16	160.3	[1] Included		BF9898-O
1	14	4 1/4	108.0	6 5/16	160.3			BF9925-O
1	14	4 1/4	108.0	6 13/32	162.7	[1] Included		BF1296-O
1	14	4 1/4	108.0	6 9/16	166.7	[1] Included	D, PS, SP	BF1345
1	14	4 1/4	108.0	6 9/16	166.7	[1] Included	D, PS, SP	BF1345-SP
1	14	4 1/4	108.0	6 19/32	167.5	G401	D, PS, PSR, SP	BF1273-SP
1	14	4 1/4	108.0	6 25/32	172.2	[1] Included	D, PS	BF1223
1	14	4 1/4	108.0	6 25/32	172.2	[1] Included	D, PS, SP	BF1223-SP
1	14	4 1/4	108.0	6 25/32	172.2	G401	D, PS	BF1240
1	14	4 1/4	108.0	6 13/16	173.0	[1] Included	D	BF1362
1	14	4 1/4	108.0	7 5/32	181.8	[1] Included	PS	BF1294-O
1	14	4 1/4	108.0	7 15/32	189.7	[1] Included	ADP, D, PSR, SP	BF9811-SP
1	14	4 1/4	108.0	7 5/8	193.7	[1] Included	ADP, PSR, SP	BF1399-SP
1	14	4 1/4	108.0	5 25/32	197.6	[1] Included		BF46085
1	14	4 1/4	108.0	7 13/16	198.4	[1] Included		BF1299-O
1	14	4 1/4	108.0	7 29/32	200.8	[1] Included	FP, PS	BF880-FP
1	14	4 1/4	108.0	8 9/32	210.3	[1] Included	D, PS	BF1346
1	14	4 1/4	108.0	8 9/32	210.3	[1] Included	D, PSR, SP	BF1346-SP
1	14	4 1/4	108.0	8 9/32	210.3	[1] Included	D, PS	BF1347
1	14	4 1/4	108.0	8 19/32	218.3			BF46099-O
1	14	4 1/4	108.0	8 21/32	219.9	[1] Included		BF1391-O
1	14	4 1/4	108.0	8 21/32	219.9	[1] Included		BF9921-O
1	14	4 1/4	108.0	9 7/32	234.2	[1] Included	D, SP	BF1374-SP
1	14	4 1/4	108.0	9 7/32	234.2	[1] Included	ADP, D, SP	BF9903-SP
1	14	4 1/4	108.0	9 11/32	237.3	[1] Included	ADP, PSR, SP	BF1397-SP
1	14	4 1/4	108.0	9 3/8	238.1	[1] Included	D, PSR, SP	BF1382-SP
1	14	4 1/4	108.0	9 31/32	253.2	[1] Included	D	BF1377
1	14	4 1/4	108.0	10 7/16	265.1	G381-A	PS	BF584
1	14	4 1/4	108.0	10 7/16	265.1	G381-A	PS	BF584-B
1	14	4 1/4	108.0	11 1/8	282.6	[1] Included	D, PS, SP	BF1359-SP
1	14	4 1/4	108.0	11 7/32	285.0	[1] Included	D	BF1363
1	14	4 1/4	108.0	11 5/16	287.3	G401	D, PS	BF1218
1	14	4 1/4	108.0	11 11/16	296.9	[1] Included	D, PS, SP	BF1354-SPS
1	14	4 9/32	108.7	5 1/4	133.4	[1] Included	D, PS	BF1222
1	14	4 9/32	108.7	5 1/4	133.4	[1] Included	D, PS, SP	BF1222-SP
1	14	4 9/32	108.7	5 21/32	143.7			BF1360-O
1	14	4 9/32	108.7	7 3/32	180.2	[1] Included	PS	BF9832
1	14	4 9/32	108.7	7 1/8	181.0	[1] Included	D	BF9869
1	14	4 9/32	108.7	8 1/32	204.0	[1] Included		BF9844
1	14	4 9/32	108.7	8 1/8	206.4	[1] Included	D, PS, SP	BF1329
1	14	4 9/32	108.7	8 1/8	206.4	[1] Included	D, PS, SP	BF1329-SP
1	14	4 9/32	108.7	8 1/8	206.4	[1] Included	D, PS, PSR, SP	BF1330-SP
1	14	4 9/32	108.7	8 1/8	206.4	[1] Included	D, PS, PSR, SP	BF1339-SP
1	14	4 9/32	108.7	8 1/8	206.4	[1] Included	D, PS, PSR, SP	BF1360-SP
1	14	4 9/32	108.7	8 1/8	206.4	[1] Included	D, PS, SP	BF1373-SP
1	14	4 9/32	108.7	8 7/32	208.8	[1] Included	D, PS	BF1349
1	14	4 9/32	108.7	8 7/32	208.8	[1] Included	D, PS	BF1360
1	14	4 9/32	108.7	9 3/32	231.0	[1] Included		BF1297-O
1	14	4 9/32	108.7	9 3/32	231.0	[1] Included		BF1383-O
1	14	4 9/32	108.7	9 31/32	253.2	[1] Included	D, PS	BF1375
1	14	4 9/32	108.7	10 25/32	273.8	[1] Included	D	BF9818
1	14	4 9/32	108.7	11	279.4	[1] Included	D, PS, SP	BF1358-SP
1	14	4 9/32	108.7	11 7/32	285.0	[1] Included	D, PS	BF1283
1	14	4 9/32	108.7	11 7/32	285.0	G579	D, PS, PSR, SP	BF1395-SP
1	14	4 9/32	108.7	11 5/16	287.3	[1] Included	D, PS	BF1265
1	14	4 9/32	108.7	11 5/16	287.3		D, PS	BF1281
1	14	4 9/32	108.7	11 5/16	287.3	[1] Included	D, PS, PSR, SP	BF1283-SP



WARNING: These products can expose you to chemicals, including Diisononyl Phthalate, Carbon black extracts, Nickel, 1,3 Butadiene, Ethylene Oxide, Epichlorohydrin, which are known to the State of California to cause cancer, and Bisphenol-A, Ethylene Glycol, Ethylene Oxide, 1,3 Butadiene, Epichlorohydrin, which are known to the State of California to cause birth defects or other reproductive harm. For more information go to www.P65Warnings.ca.gov.

SPIN-ON FILTERS BY TAP SIZE (U.S. THREAD)

THREAD I.D.	PER Inch	O.D. Inches	O.D. (mm)	LENGTH Inches	LENGTH (mm)	GASKET	FEATURES	BALDWIN NUMBER
1	14	4 1/4	108.8	8 17/32	216.7			BF46018-O
1	14	4 5/16	109.5	5 29/32	150.0	[1] Included	PS	BF7628
1	14	4 5/16	109.5	6 5/16	160.3	[1] Included		BF9871-O
1	14	4 5/16	109.5	6 25/32	172.2	[1] Included	D, PS	BF1231
1	14	4 5/16	109.5	6 25/32	172.2	[1] Included	D, PS	BF1348
1	14	4 5/16	109.5	6 25/32	172.2	[1] Included	D, PS, SP	BF1348-SP
1	14	4 5/16	109.5	6 25/32	172.2	[1] Included	D, PS	BF1370
1	14	4 11/32	110.3	6 1/8	155.6			BF46016-O
1	14	4 11/32	110.3	6 3/16	157.2	[1] Included		BF1390-O
1	14	4 11/32	110.3	6 13/32	162.7	[1] Included		BF1290-O
1	14	4 11/32	110.3	9 1/4	235.0	[1] Included	PS	BF9917
1	14	4 11/32	110.3	9 11/16	246.1	[1] Included		BF9880
1	14	4 3/8	111.1	3 1/2	88.9			BF46027-O
1	14	UNS-2B	4 3/8	111.1	6 7/32	158.0		PS
BF1347-O								
1	14	4 13/32	111.9	8 19/32	218.3	[2] Included		BF1281-O
1	14	4 13/32	111.9	8 19/32	218.3	[2] Included		BF1283-O
1	14	4 13/32	111.9	8 19/32	218.3	[1] Included	PS	BF1358-O
1	14	4 13/32	111.9	8 19/32	218.3	[2] Included		BF1395-O
1	14	4 13/32	111.9	8 21/32	219.9	[1] Included		BF9867-O
1	14	3 3/4	140.5	5 17/32	140.5			BF46025-O
1	16	3 11/16	93.7	5 3/8	136.5	[1] Included		BT427
1	16	3 11/16	93.7	5 3/8	136.5	G381-A	AD, MBP	B7014
1	16	3 11/16	93.7	5 3/8	136.5	G381-A		B7117
1	16	3 11/16	93.7	5 3/8	136.5	G381-A		B7351-MPG
1	16	3 11/16	93.7	5 3/8	136.5	G381-A	AD	B7420
1	16	3 11/16	93.7	5 3/8	136.5	G381-A	AD	B7440
1	16	3 11/16	93.7	6 7/16	163.5	G381-A	AD, HBP	B7379
1	16	3 11/16	93.7	6 19/32	167.5	G381-A	SHBP	B7362
1	16	3 11/16	93.7	7 1/8	181.0	G381-A		BT339
1	16	3 11/16	93.7	7 1/8	181.0	G381-A	AD	B7181
1	16	3 11/16	93.7	7 1/8	181.0	[1] Included	Venturi-Type Cone	BD7317
1	16	3 11/16	93.7	7 1/8	181.0	G381-A		BT7349
1	16	3 11/16	93.7	7 5/32	181.8	G381-A	AD	B7372
1	16	4 1/4	108.0	5 13/16	147.6	G381-A		BT564
1	16	4 1/4	108.0	5 13/16	147.6	[1] Included		B5177
1	16	4 1/4	108.0	5 13/16	147.6	[1] Included	BTE	BW5179
1	16	4 1/4	108.0	7 11/32	186.5	G381-A		BT440
1	16	4 9/32	108.7	8 3/4	22.3	[1] Included	HBP	B7506
1 1/16	16	4 1/4	108.0	10 7/16	265.1	[1] Included	PS	BF976
1 1/16	16	4 21/32	118.3	9 1/2	241.0	[1] Included	PS	BF785
1 1/16	16	4 21/32	118.3	9 1/2	241.0	[1] Included	PS	BF7697
1 1/8	12	3 11/16	93.7	7 1/8	181.0	[1] Included		B7375
1 1/8	16	3 5/8	92.1	7 1/8	181.0	[1] Included		B7497
1 1/8	16	3 11/16	93.7	3 7/32	81.8			BT367-S
1 1/8	16	3 11/16	93.7	4 5/16	109.5		PS	B7024
1 1/8	16	3 11/16	93.7	4 11/32	110.3			BT367
1 1/8	16	3 11/16	93.7	5 3/8	136.5	G381-A		BT230
1 1/8	16	3 11/16	93.7	5 3/8	136.5	G381-A		BT260
1 1/8	16	3 11/16	93.7	5 3/8	136.5	G381-A		BT260-10
1 1/8	16	3 11/16	93.7	5 3/8	136.5	G381-A		BT334
1 1/8	16	3 11/16	93.7	5 3/8	136.5	G381-A	BP	BT354
1 1/8	16	3 11/16	93.7	5 3/8	136.5	G381-A		BT9442-MPG
1 1/8	16	3 11/16	93.7	5 5/8	142.9	G381-A		BT8314
1 1/8	16	3 11/16	93.7	5 21/32	143.7	G401		BT8391
1 1/8	16	3 11/16	93.7	5 21/32	143.7	G401		BT8505
1 1/8	16	3 11/16	93.7	5 21/32	143.7	G401		BT8898
1 1/8	16	3 11/16	93.7	5 7/8	149.2	G381-A		BT9382
1 1/8	16	3 11/16	93.7	6 5/8	168.3	G381-A	HBP	BT8357
1 1/8	16	3 11/16	93.7	6 5/8	168.3	G381-A	BP	BT8504
1 1/8	16	3 11/16	93.7	7 1/8	181.0	G381-A		BT305
1 1/8	16	3 11/16	93.7	7 3/16	182.6	G401		BT595
1 1/8	16	3 11/16	93.7	7 3/16	182.6	G401		B7177
1 1/8	16	3 11/16	93.7	8 3/16	208.0	G401	MBP	BT8393
1 1/8	16	3 11/16	93.7	9 13/16	249.2	[1] Included	D	BF46015
1 1/8	16	3 23/32	94.5	6 13/16	173.0	[1] Included		BT9321
1 1/8	16	3 23/32	94.5	7 1/32	178.6	[1] Included		BT8488

SPIN-ON FEATURES

Some spin-ons have no additional features while others have several. Here are some of the more important spin-on features:

Anti-Drainback Valve



As the name implies, this valve keeps the oil from draining from a filter when the engine is shut off. (Some filters include an anti-drainback standpipe for the same function). The mounting direction determines the need for this feature.

By-Pass Valve



Full-flow oil systems require a by-pass (relief) valve either in the system or in the filter. This valve opens at a predetermined setting to assure oil flow to the bearings at all times.

Integral Post Seal



Seals threaded stud to prevent tiny particles from spiraling in via the threads.

We Cannot be Responsible for Misapplications



WARNING: These products can expose you to chemicals, including Diisononyl Phthalate, Carbon black extracts, Nickel, 1,3 Butadiene, Ethylene Oxide, Epichlorohydrin, which are known to the State of California to cause cancer, and Bisphenol-A, Ethylene Glycol, Ethylene Oxide, 1,3 Butadiene, Epichlorohydrin, which are known to the State of California to cause birth defects or other reproductive harm. For more information go to www.P65Warnings.ca.gov.

SPIN-ON FILTERS BY TAP SIZE (U.S. THREAD)

	THREAD I.D.	PER Inch	O.D. Inches	O.D. (mm)	LENGTH Inches	LENGTH (mm)	GASKET	FEATURES	BALDWIN NUMBER
SPIN-ON FILTER FEATURES ARE CODED AS FOLLOWS	1 1/8	16	3 25/32	96.0	6 15/32	164.3	[1] Included	RC	BT9358
	1 1/8	16	4 1/4	108.0	5 27/32	148.4	[1] Included		B75
	1 1/8	16	4 1/4	108.0	5 27/32	148.4	[1] Included		B605
	1 1/8	16	4 1/4	108.0	5 27/32	148.4	[1] Included	AD, ADP, SHBP	B7051
	1 1/8	16	4 1/4	108.0	5 27/32	148.4	[1] Included	SHBP	B7223
	1 1/8	16	UN-2B	4 1/2	108.0	7 5/16	185.7	[1] Included	
AD	Anti-Drainback Valve								
ADP	Anti-Drainback Pipe								
BP	8-10 PSID								
	By-Pass Valve								
BPI	By-Pass Included								
BPS	By-Pass Screen								
BTA PLUS	Balanced Treatment Additive Plus								
BTE	Balanced Treatment for Ethylene Glycol Antifreeze								
D	Drain								
FECV	Front-End Check Valve								
FP	Fill Port								
HBP	18-25 PSID High Pressure By-Pass Valve								
ISO	Inside-Out Flow Direction								
LBP	2-7 PSID Low Pressure By-Pass Valve								
MBP	11-17 PSID Medium Pressure By-Pass Valve								
MO	Metering Orifice								
PS	Integral Post Seal Gasket								
PSR	Post Seal Required; Must install loose O-Ring or D-Ring on Post for Seal								
RC	Reinforced Centertube								
SHBP	30-45 PSID Super High Pressure By-Pass Valve								
SP	Sensor Port								
XHBP	50+ PSID Extra High Pressure By-Pass Valve								
Do NOT Interchange Filters with Different Features									



WARNING: These products can expose you to chemicals, including Diisononyl Phthalate, Carbon black extracts, Nickel, 1,3 Butadiene, Ethylene Oxide, Epichlorohydrin, which are known to the State of California to cause cancer, and Bisphenol-A, Ethylene Glycol, Ethylene Oxide, 1,3 Butadiene, Epichlorohydrin, which are known to the State of California to cause birth defects or other reproductive harm. For more information go to www.P65Warnings.ca.gov.

SPIN-ON FILTERS BY TAP SIZE (U.S. THREAD)

THREAD I.D.	PER Inch	O.D. Inches	O.D. (mm)	LENGTH Inches	LENGTH (mm)	GASKET	FEATURES	BALDWIN NUMBER
1 3/8	12	3 3/4	95.3	6 3/32	154.8	[1] Included		BT8841-MPG
1 3/8	12	3 3/4	95.3	6 3/32	154.8	[1] Included		BT8849-MPG
1 3/8	12	3 3/4	95.3	6 1/8	155.6	[1] Included		BT732
1 3/8	12	3 3/4	95.3	6 1/8	155.6	[1] Included		BT8463-MPG
1 3/8	12	3 3/4	95.3	6 1/8	155.6	[1] Included		BT8464
1 3/8	12	3 3/4	95.3	6 1/8	155.6	[1] Included		BT8840-MPG
1 3/8	12	3 3/4	95.3	6 1/8	155.6	[1] Included		BT8842-MPG
1 3/8	12	3 3/4	95.3	6 1/8	155.6	[1] Included		BT8844
1 3/8	12	3 3/4	95.3	6 1/8	155.6	[1] Included		BT8845
1 3/8	12	3 3/4	95.3	6 1/8	155.6	[1] Included		BT8846
1 3/8	12	3 3/4	95.3	6 1/8	155.6	[1] Included		BT8847
1 3/8	12	3 3/4	95.3	6 1/8	155.6	[1] Included		BT9364
1 3/8	12	3 3/4	95.3	6 1/8	155.6	[1] Included		BT9436-MPG
1 3/8	12	3 3/4	95.3	6 11/32	161.1	[1] Included		BT8904-MPG
1 3/8	12	3 3/4	95.3	8 1/32	204.0	[1] Included		BT8848-MPG
1 3/8	12	3 3/4	95.3	9 17/32	242.1	[1] Included		BT8850-MPG
1 3/8	12	3 3/4	95.3	9 17/32	242.1	[1] Included		BT8853-MPG
1 3/8	12	3 3/4	95.3	9 17/32	242.1	[1] Included		BT9433
1 3/8	12	3 3/4	95.3	9 17/32	242.9	[1] Included		BT9466-MPG
1 3/8	12	3 3/4	95.3	9 19/32	243.7	[1] Included		BT8312
1 3/8	12	3 3/4	95.3	9 19/32	243.7	[1] Included		BT8465
1 3/8	12	3 3/4	95.3	9 19/32	243.7	[1] Included		BT8851-MPG
1 3/8	12	3 3/4	95.3	9 19/32	243.7	[1] Included		BT8852-MPG
1 3/8	12	3 3/4	95.3	9 19/32	243.7	[1] Included		BT8855-MPG
1 3/8	12	3 3/4	95.3	9 19/32	243.7	[1] Included		BT8856-MPG
1 3/8	12	3 3/4	95.3	9 19/32	243.7	[1] Included		BT8861
1 3/8	12	3 3/4	95.3	9 19/32	243.7	[1] Included		BT8862
1 3/8	12	3 3/4	95.3	9 19/32	243.7	[1] Included		BT8863
1 3/8	12	3 3/4	95.3	9 19/32	243.7	[1] Included		BT9363-MPG
1 3/8	12	3 3/4	95.3	9 27/32	250.0	[1] Included		BT9370-MPG
1 3/8	12	3 15/16	100.0	9 7/16	239.7	[1] Included		BT8466-MPG
1 3/8	12	3 13/16	96.8	9 7/16	239.7	[1] Included		BT8834-MPG
1 3/8	12	4 23/32	119.9	11 17/32	292.9	[1] Included		BT8320
1 3/8	12	4 23/32	119.9	11 17/32	292.9	[1] Included		BT8432-MPG
1 3/8	12	4 23/32	119.9	11 17/32	292.9	[1] Included		BT9362-MPG
1 3/8	12	4 23/32	119.9	11 17/32	292.9	[1] Included		BT9391-MPG
1 3/8	12	4 23/32	119.9	11 17/32	292.9	[1] Included		BT9421-MPG
1 3/8	16	4 1/4	108.0	10 1/16	255.6	[1] Included		B7409
1 3/8	16	4 1/4	108.0	10 1/16	255.6	[1] Included		B7685
1 3/8	16	4 11/32	110.3	7 5/16	185.7	[1] Included		B9607
UN-2B								
1 3/8	16	4 21/32	118.3	9 7/8	250.8	G498-A		B220
1 3/8	16	4 21/32	118.3	9 29/32	251.6	[1] Included	PS	B7019
1 3/8	16	4 11/16	119.1	9 15/16	252.4	G498-D		B7577
1 3/8	16	4 29/32	124.6	10 1/16	255.6	[1] Included		B7246
1 3/8	16	5 3/8	136.5	10 9/16	268.3	[1] Included	D, PS	BF7635
1 3/8	16	5 3/8	136.5	12 3/32	307.2	[1] Included	PS	BF799
1 3/8	16	5 3/8	136.5	12 3/32	307.2	[1] Included	PS	BF7639
1 3/8	16	5 3/8	136.5	12 7/16	315.9	[1] Included	D, PS	BF7639-D
1 1/2	12	4 21/32	118.3	4 15/16	125.4	[1] Included	SHBP	BD7159
1 1/2	12	4 21/32	118.3	4 15/16	125.4	[1] Included	HBP	BD7169
1 1/2	12	4 21/32	118.3	6 1/4	158.8	G498-A		B404
1 1/2	12	4 21/32	118.3	6 9/32	159.5	[1] Included		B105
1 1/2	12	4 21/32	118.3	8 1/16	204.8	[1] Included	MBP	BD7166
1 1/2	12	4 21/32	118.3	8 3/32	205.6	[1] Included	PS	B205
1 1/2	12	4 21/32	118.3	8 3/32	205.6	[1] Included		B7004
1 1/2	12	4 21/32	118.3	8 3/32	205.6	[1] Included		B7005
1 1/2	12	4 21/32	118.3	8 3/32	205.6	[1] Included		BD7141
1 1/2	12	4 21/32	118.3	8 3/32	205.6	[1] Included	HBP	B7217
1 1/2	12	4 21/32	118.3	8 3/32	205.6	[1] Included	AD, PS	B7239
1 1/2	12	4 21/32	118.3	8 3/32	205.6	[1] Included	MBP	B7324
1 1/2	12	4 21/32	118.3	8 3/32	205.6	G498-D	MBP	B7416
1 1/2	12	4 21/32	118.3	9 15/16	252.4	[1] Included	PS	B95
1 1/2	12	4 21/32	118.3	9 15/16	252.4	[1] Included	PS	B95-MPG
1 1/2	12	4 21/32	118.3	9 15/16	252.4	[1] Included	PS	B95-SS
1 1/2	12	4 21/32	118.3	9 15/16	252.4	[1] Included	PS	B196
1 1/2	12	4 21/32	118.3	9 15/16	252.4	[1] Included	AD	B7241
1 1/2	12	4 21/32	118.3	9 15/16	252.4	[1] Included		BF9888

CAUTION!!!
Read These Instructions Before Using Size Charts

The filter size charts on this and following pages are for filter experts. Careless use could lead to errors. When you have exhausted all other ways to determine a filter number, locate a suspect here, then check the Product Guide for confirmation.

Size alone does not assure you of the right filtering media, gasket or other features. What is being filtered, filter efficiency, flow rate and direction of flow all have to be considered.

Spin-on filters are listed by tap size rather than length. All other filters are listed on an overall basis. Check your Product Guide for other dimensions. Progression is from the smallest to the largest in each category.

Do NOT Interchange Filters with Different Features

Be Sure to Check Product Guide, Cross-References and Applications

We Cannot be Responsible for Misapplications



WARNING: These products can expose you to chemicals, including Diisononyl Phthalate, Carbon black extracts, Nickel, 1,3 Butadiene, Ethylene Oxide, Epichlorohydrin, which are known to the State of California to cause cancer, and Bisphenol-A, Ethylene Glycol, Ethylene Oxide, 1,3 Butadiene, Epichlorohydrin, which are known to the State of California to cause birth defects or other reproductive harm. For more information go to www.P65Warnings.ca.gov.

SPIN-ON FILTERS BY TAP SIZE (U.S. THREAD)

A TYPICAL SPIN-ON

Spin-ons vary in size, media, fittings and other features. Let's look at the usual components.

Spin-on Can



No housing to clean; faster to change.

Baseplate and Seaming Cover Assembly



Size of mounting hole and gasket location determine if filter will seal. The baseplate is attached to the seaming cover and the seaming cover is attached to the can. (The gasket fits in the seaming cover.)

Compression Spring



Holds element in place to maintain seal.

Element End Caps



Closed End

Open End

End caps are bonded to the media.

Filtering Media



Microlite® pleated paper comes in more than 60 types for exact filtering requirements.

Centertube

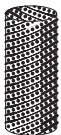

Media is wrapped around the spiral perforated/louvered steel tube.

THREAD I.D.	PER Inch	O.D. Inches	O.D. (mm)	LENGTH Inches	LENGTH (mm)	GASKET	FEATURES	BALDWIN NUMBER
1 1/2	12	4 21/32	118.3	11 5/16	287.3	[1] Included	PS	BF9864
1 1/2	12	4 11/16	119.1	11 9/32	286.5	[1] Included	PS	B96
1 1/2	12	4 11/16	119.1	11 9/32	286.5	[1] Included	PS	B96-MPG
1 1/2	12	4 11/16	119.1	11 9/32	286.5	[1] Included	PS	B96-SS
1 1/2	12	4 11/16	119.1	11 9/32	286.5	[1] Included	PS	B7396
1 1/2	12	5 1/16	128.6	6 31/32	177.0			BT486
1 1/2	16	3 11/16	93.7	5 9/16	141.3			BT8316-MPG
1 1/2	16	3 11/16	93.7	5 9/16	141.3	[1] Included		BF7586
1 1/2	16	3 11/16	93.7	5 9/16	141.3	[1] Included		BT8398-MPG
1 1/2	16	3 11/16	93.7	5 9/16	141.3	[1] Included	MBP	BT9346-MPG
1 1/2	16	3 11/16	93.7	5 3/4	146.1	[1] Included	HBP	B7125
1 1/2	16	3 11/16	93.7	7 3/16	182.6	[1] Included	D	BF7695
1 1/2	16	3 11/16	93.7	8 1/16	204.8	[1] Included		BT372-10
1 1/2	16	3 11/16	93.7	8 1/16	204.8	[1] Included		BT372-MPG
1 1/2	16	3 11/16	93.7	8 1/16	204.8	[1] Included		BT8509-MPG
1 1/2	16	3 3/4	95.3	5 9/16	141.3	[1] Included		BF7645
1 1/2	16	3 3/4	95.3	5 9/16	141.3	[1] Included		BF7995
1 1/2	16	3 3/4	95.3	5 9/16	141.3			BT23525-MPG
1 1/2	16	3 3/4	95.3	8 1/4	209.6			B40022-MPG
1 1/2	16	3 25/32	96.0	5 23/32	145.3	[1] Included		BT371-5
1 1/2	16	3 13/16	96.8	5 13/32	137.3	[1] Included		BT371-10
1 1/2	16	3 13/16	96.8	5 13/32	137.3	[1] Included		BT371-MPG
1 1/2	16	3 15/16	100.0	9 1/2	241.3	[1] Included		BT8397-MPG
1 1/2	16	4 1/4	108.0	5 7/8	149.2	[1] Included		B134
1 1/2	16	4 1/4	108.0	7 3/8	187.3	[1] Included		B7039
1 1/2	16	4 7/16	112.7	8 11/32	211.9	[1] Included	ADP, D	BD7105
1 1/2	16	4 21/32	118.3	6 9/32	159.5	[1] Included		BT8890-MPG
1 1/2	16	4 21/32	118.3	6 9/32	159.5	[1] Included		BT23603-MPG
		UN-2B						
1 1/2	16	4 21/32	118.3	8 3/32	205.6	[1] Included		B7513
1 1/2	16	4 21/32	118.3	8 1/8	206.4	[1] Included		B7155
1 1/2	16	4 21/32	118.3	8 1/8	206.4	[1] Included		BD7325
1 1/2	16	4 21/32	118.3	9 29/32	251.6		G498-A	B97
1 1/2	16	4 21/32	118.3	11 1/4	286.0		G498-A	B49
1 1/2	16	4 13/16	122.2	7 15/32	189.7	[1] Included		BT8801-MPG
1 1/2	16	4 13/16	122.2	7 15/32	189.7	[1] Included		BT8802-MPG
1 1/2	16	4 13/16	122.2	7 15/32	189.7	[1] Included		BT8812-MPG
1 1/2	16	4 13/16	122.2	7 15/32	189.7	[1] Included		BT9343-MPG
1 1/2	16	4 13/16	122.2	11 15/32	291.3	[1] Included		BT8805-MPG
1 1/2	16	4 13/16	122.2	11 9/16	293.7	[1] Included		BT8800-MPG
1 1/2	16	4 13/16	122.2	11 9/16	293.7	[1] Included		BT8803-MPG
1 1/2	16	4 13/16	122.2	11 9/16	293.7	[1] Included		BT8813-MPG
1 1/2	16	4 13/16	122.2	11 29/32	302.4	[1] Included		BT8457-MPG
1 1/2	16	5	127.0	11 3/4	298.5	[1] Included		BT8381
1 1/2	16	5 1/32	127.8	6 31/32	177.0		BP, BPS	BT424
1 1/2	16	5 1/32	127.8	6 31/32	177.0			BT8901-MPG
1 1/2	16	5 1/32	127.8	7	177.8			BT287
1 1/2	16	5 1/32	127.8	7	177.8			BT287-10
1 1/2	16	5 1/32	127.8	7	177.8			BT387
1 1/2	16	5 1/32	127.8	7	177.8			BT387-10
1 1/2	16	5 1/32	127.8	10 11/16	271.5			BT23539
1 1/2	16	5 1/32	127.8	10 3/4	273.1			BT388
1 1/2	16	5 1/32	127.8	10 3/4	273.1			BT388-10
1 1/2	16	5 1/16	128.6	6 31/32	177.0			BT8307-MPG
1 1/2	16	5 1/16	128.6	6 31/32	177.0			BT8309-MPG
1 1/2	16	5 1/16	128.6	6 31/32	177.0			BT8421-MPG
1 1/2	16	5 1/16	128.6	6 31/32	177.0			BT8423
1 1/2	16	5 1/16	128.6	6 31/32	177.0			BT8424-MPG
1 1/2	16	5 1/16	128.6	6 31/32	177.0			BT9356
1 1/2	16	5 1/16	128.6	6 31/32	177.0			BT9371-MPG
1 1/2	16	5 1/16	128.6	7	177.8			BT287-3
1 1/2	16	5 1/16	128.6	8 15/16	227.0	[1] Included	BP, BPS	BT425
1 1/2	16	5 1/16	128.6	10 3/4	273.1			BT389
1 1/2	16	5 1/16	128.6	10 3/4	273.1			BT389-10
1 1/2	16	5 1/16	128.6	10 3/4	273.1			BF1239
1 1/2	16	5 1/16	128.6	10 3/4	273.1			B7011
1 1/2	16	5 1/16	128.6	10 3/4	273.1			BF7571
1 1/2	16	5 1/16	128.6	10 3/4	273.1			BF7623
1 1/2	16	5 1/16	128.6	10 3/4	273.1			BT8308-MPG



WARNING: These products can expose you to chemicals, including Diisononyl Phthalate, Carbon black extracts, Nickel, 1,3 Butadiene, Ethylene Oxide, Epichlorohydrin, which are known to the State of California to cause cancer, and Bisphenol-A, Ethylene Glycol, Ethylene Oxide, 1,3 Butadiene, Epichlorohydrin, which are known to the State of California to cause birth defects or other reproductive harm. For more information go to www.P65Warnings.ca.gov.

SPIN-ON FILTERS BY TAP SIZE (U.S. THREAD)

THREAD I.D.	PER Inch	O.D. Inches	O.D. (mm)	LENGTH Inches	LENGTH (mm)	GASKET	FEATURES	BALDWIN NUMBER
1 1/2	16	5 1/16	128.6	10 3/4	273.1			BT8308-MPG KIT
1 1/2	16	5 1/16	128.6	10 3/4	273.1			BT8310-MPG
1 1/2	16	5 1/16	128.6	10 3/4	273.1			BT8368
1 1/2	16	5 1/16	128.6	10 3/4	273.1			BT8422-MPG
1 1/2	16	5 1/16	128.6	10 3/4	273.1			BT8471-MPG
1 1/2	16	5 1/16	128.6	10 3/4	273.1			BT8510-MPG
1 1/2	16	5 1/16	128.6	10 3/4	273.1	G369-B		BT9345
1 1/2	16	5 1/16	128.6	10 25/32	273.8		HBP	BT345 KIT
1 1/2	16	5 3/32	129.4	6 21/32	169.1			BT23140-MPG
1 1/2	16	5 11/32	135.7	7 1/32	178.6	[1] Included	LBP	BT8921
1 1/2	16	5 3/8	136.5	7	177.8	[1] Included	BPS,XHBP	B7363
1 1/2	16	5 3/8	136.5	8 19/32	218.3	[1] Included		B7402
1 1/2	16	5 3/8	136.5	8 7/8	225.4	[1] Included	SHBP	B7182
1 1/2	16	5 3/8	136.5	12 3/32	307.2	[1] Included		B99
1 1/2	16	5 3/8	136.5	12 3/32	307.2	[1] Included		B99-B
1 1/2	16	5 3/8	136.5	12 3/32	307.2	[1] Included		B99-MPG
1 1/2	16	5 3/8	136.5	12 3/32	307.2	[1] Included		B99-SS
1 1/2	16	5 3/8	136.5	12 3/32	307.2	[1] Included	SHBP	B239
1 1/2	16	5 3/8	136.5	12 3/32	307.2	[1] Included	AD, SHBP	B7157
1 1/2	16	5 3/8	136.5	12 3/32	307.2	[1] Included	SHBP	B7180
1 1/2	16	5 3/8	136.5	12 3/32	307.2	[1] Included		B7245
1 1/2	16	5 3/8	136.5	12 3/32	307.2	[1] Included		B7249-MPG
1 1/2	16	5 3/8	136.5	12 3/32	307.2	[1] Included		B7299
1 1/2	16	5 3/8	136.5	12 3/32	307.2	[1] Included		B7507
1 1/2	16	5 3/8	136.5	12 3/8	314.3	[1] Included	SHBP	B7187
1 1/2	16	5 1/2	139.7	7	177.8	[1] Included	HBP	BT8437
1 1/2	16	5 17/32	140.5	11 7/8	301.6			OAS98061
1 5/8	12	4 21/32	118.3	9 15/16	252.4	[1] Included		B495
1 5/8	12	4 21/32	118.3	9 15/16	252.4	[1] Included		B495-MPG
1 5/8	12	4 21/32	118.3	9 15/16	252.4	[1] Included		B495-SS
1 5/8	12	4 11/16	119.1	11 9/32	286.5	[1] Included	PS	BF7948
1 5/8	12	5 1/16	128.6	6 31/32	177.0			B7335-MPG
1 3/4	12	4 9/16	115.9	11 13/32	289.7	[1] Included		B7503
1 3/4	12	4 23/32	119.9	7 3/4	196.9	[1] Included		BT8875-MPG
1 3/4	12	4 23/32	119.9	7 3/4	196.9	[1] Included		BT8880-MPG
1 3/4	12	4 23/32	119.9	11 1/2	292.1	[1] Included		BT9365-MPG
1 3/4	12	4 23/32	119.9	11 17/32	292.9	[1] Included		BT8401-MPG
1 3/4	12	4 23/32	119.9	11 17/32	292.9	[1] Included		BT8874-MPG
1 3/4	12	4 23/32	119.9	11 17/32	292.9	[1] Included		BT8877-MPG
1 3/4	12	4 23/32	119.9	11 17/32	292.9	[1] Included		BT8878-MPG
1 3/4	12	4 23/32	119.9	11 17/32	292.9	[1] Included		BT8879-MPG
1 3/4	12	4 23/32	119.9	11 17/32	292.9	[1] Included		BT8892-MPG
1 3/4	12	4 23/32	119.9	11 17/32	292.9	[1] Included		BT8910-MPG
1 3/4	12	4 23/32	119.9	11 17/32	292.9	[1] Included		BT8911-MPG
1 3/4	12	4 23/32	119.9	11 17/32	292.9	[1] Included		BT9353-MPG
1 3/4	12	4 23/32	119.9	14 3/32	358.0	[1] Included		BT9560-MPG
1 3/4	12	4 23/32	119.9	14 1/8	358.8	[1] Included		BT8870-MPG
1 3/4	12	4 3/4	120.7	11 17/32	292.9	[1] Included		BT8873
1 3/4	12	4 3/4	120.7	11 19/32	294.5	[1] Included		BT8876-MPG
1 3/4	12 UN	4 3/4	120.7	14 1/4	362.0	[1] Included		BT23609-MPG
1 3/4	12	4 25/32	121.4	14 1/4	362.0	[1] Included		BT23542-MPG
1 3/4	16	4 21/32	118.3	9 15/16	252.4	[1] Included	MBP	BT9439
1 3/4	16	5 3/8	136.5	7	177.8	[1] Included	BPS, MBP	BT8899
1 3/4	16	5 3/8	136.5	9 5/8	244.5	[1] Included	MBP	BT8382
1 7/8	12	5 7/32	132.6	6 7/8	174.6	[1] Included		BT8927
2	12	3 1/8	79.4	5 17/32	140.5		PS	BT8333
2	12	3 1/8	79.4	5 17/32	140.5			BT9349-MPG
2	12	3 1/8	79.4	5 17/32	140.5	[1] Included		BT9393-MPG
2	12	3 1/8	79.4	9 17/32	242.1	[1] Included		BT8418
2	12	3 1/8	79.4	9 17/32	242.1			BT8886-MPG
2	12	3 1/8	79.4	9 17/32	242.1	[2] Included		BT9392-MPG
2	16	3 11/16	93.7	5 21/32	143.7	G401	HBP	BT8830
2	16	3 11/16	93.7	7 7/32	183.4	G401		BT8831
2	16	3 11/16	93.7	7 7/32	183.4	G401	HBP	BT8832
2	16	3 11/16	93.7	7 7/32	183.4	G401	SHBP	BT8833

SPIN-ON FEATURES

Some spin-ons have no additional features while others have several. Here are some of the more important spin-on features:

Anti-Drainback Valve



As the name implies, this valve keeps the oil from draining from a filter when the engine is shut off. (Some filters include an anti-drainback standpipe for the same function). The mounting direction determines the need for this feature.

By-Pass Valve

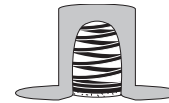

Full-flow oil systems require a by-pass (relief) valve either in the system or in the filter. This valve opens at a predetermined setting to assure oil flow to the bearings at all times.

Integral Post Seal



Seals threaded stud to prevent tiny particles from spiraling in via the threads.

We Cannot be Responsible for Misapplications



WARNING: These products can expose you to chemicals, including Diisononyl Phthalate, Carbon black extracts, Nickel, 1,3 Butadiene, Ethylene Oxide, Epichlorohydrin, which are known to the State of California to cause cancer, and Bisphenol-A, Ethylene Glycol, Ethylene Oxide, 1,3 Butadiene, Epichlorohydrin, which are known to the State of California to cause birth defects or other reproductive harm. For more information go to www.P65Warnings.ca.gov.

SPIN-ON FILTERS BY TAP SIZE (U.S. THREAD)

	THREAD I.D.	PER Inch	O.D. Inches	O.D. (mm)	LENGTH Inches	LENGTH (mm)	GASKET	FEATURES	BALDWIN NUMBER
SPIN-ON FILTER FEATURES ARE CODED AS FOLLOWS	2	16	3 3/4	95.3	6 3/32	154.8	[1] Included	XHBP	BT8426-MPG
	2	16	3 3/4	95.3	7 7/32	183.4		BPS, XHBP	BT9400-MPG
AD Anti-Drainback Valve	2 1/4	12	4 21/32	118.3	9 5/8	244.5	G293-B		BD324
	2 1/4	12	4 21/32	118.3	10 5/16	261.9	[1] Included		BF7932
ADP Anti-Drainback Pipe	2 1/4	12	4 21/32	118.3	11 13/32	289.7	G293-B		BD103
	2 1/4	12	4 21/32	118.3	11 13/32	289.7	G293-B		BD103-MPG
BP 8-10 PSID By-Pass Valve	2 1/4	12	4 21/32	118.3	11 13/32	289.7	G293-B		BD103-SS
	2 1/4	12	4 21/32	118.3	11 13/32	289.7	G293-B		B333
BPI By-Pass Included	2 1/4	12	4 21/32	118.3	11 13/32	289.7	[1] Included		BD7309
	2 1/4	12	4 21/32	118.3	11 13/32	289.7	[1] Included		BD7504
BPS By-Pass Screen	2 1/4	12	4 5/8	142.9	10	254.0	[1] Included		BF46002
	2 1/2	12	5 7/32	132.6	6 5/8	168.3	[1] Included		BA5371
BTA PLUS Balanced Treatment Additive Plus	2 3/4	4	3 17/32	89.7	4 27/32	123.0			T300-M
	2 3/4	4	3 7/8	98.4	6 3/8	161.9			PT302
BTE Balanced Treatment for Ethylene Glycol Antifreeze	2 3/4	4	3 7/8	98.4	6 13/32	162.7			T303-M
	2 3/4	4	3 7/8	98.4	7 5/8	193.7			PT304
D Drain	2 3/4	5 1/2	3 17/32	89.7	4 27/32	123.0			T308-M
	3	8	5	127.0	8 13/16	223.8			BT775
FECV Front-End Check Valve	3	8	5	127.0	12 1/4	311.2			BT774
	3 3/8	8	4 1/32	102.4	6 3/8	161.9			BF46062
FP Fill Port	3 3/8	8 UN	Buttress	4 1/32	102.4	6 1/2	165.1		
									BF9882----
HBP 18-25 PSID High Pressure By-Pass Valve									
ISO Inside-Out Flow Direction									
LBP 2-7 PSID Low Pressure By-Pass Valve									
MBP 11-17 PSID Medium Pressure By-Pass Valve									
MO Metering Orifice									
PS Integral Post Seal Gasket									
PSR Post Seal Required; Must install loose O-Ring or D-Ring on Post for Seal									
RC Reinforced Centertube									
SHBP 30-45 PSID Super High Pressure By-Pass Valve									
SP Sensor Port									
XHBP 50+ PSID Extra High Pressure By-Pass Valve									
Do NOT Interchange Filters with Different Features									



WARNING: These products can expose you to chemicals, including Diisononyl Phthalate, Carbon black extracts, Nickel, 1,3 Butadiene, Ethylene Oxide, Epichlorohydrin, which are known to the State of California to cause cancer, and Bisphenol-A, Ethylene Glycol, Ethylene Oxide, 1,3 Butadiene, Epichlorohydrin, which are known to the State of California to cause birth defects or other reproductive harm. For more information go to www.P65Warnings.ca.gov.

SPIN-ON FILTERS BY TAP SIZE (BRITISH STANDARD PIPE THREAD)

THREAD I.D.	PER Inch	O.D. Inches	O.D. (mm)	LENGTH Inches	LENGTH (mm)	GASKET	FEATURES	BALDWIN NUMBER
3/4	14	BSP-PL	3 11/1693.7	3 7/32.....81.8				BT368
3/4	14	BSP-PL	3 11/1693.7	5 3/8.....136.5		G381-A.....		BT8472
3/4	14	BSP-PL	3 11/1693.7	5 13/32.....137.3		G401.....		BT366-10
3/4	14	BSP-PL	3 11/1693.7	8 5/32.....207.2		G381-A.....		BT8473
3/4	14	BSP-PL	3 11/1693.7	8 5/32.....207.2		G381-A.....		BT8474
3/4	14	BSP-PL	3 3/495.3	2 5/16.....58.7		[1] Included.....		BT9326
3/4	14	BSP-PL	3 3/495.3	5 23/32.....145.3				BT8913-MPG
3/4	14	BSP-PL	3 3/495.3	5 3/4.....146.1				BT8928
3/4	14	BSP-PL	3 3/495.3	5 3/4.....146.1		[1] Included.....	HBP.....	BT8935
3/4	14	BSP-PL	3 25/32.....96.0	5 23/32.....145.3		[1] Included.....		BT366-MPG
3/4	14	BSP-PL	3 25/32.....96.0	7 19/32.....192.9		[1] Included.....		BT9316-MPG
3/4	14	BSP-PL	3 13/1696.8	8 9/32.....210.3				BT9211
1	11	BSP-PL	3 13/1696.8	5 3/16.....132.0				BT841
1	11	BSP-PL	3 13/1696.8	5 1/4.....133.4				BF553
1 1/4	11	BSP-PL	4 5/8117.5	6 9/32.....159.5		G498-A.....	PS.....	BT611-MPG
1 1/4	11	BSP-PL	4 5/8117.5	11 9/32.....286.5		G498-A.....	PS.....	BT610-MPG
1 1/4	11	BSP-PL	4 21/32118.3	8 3/32.....205.6		G498-A.....	PS.....	BT9558-MPG
1 1/4	11	BSP-PL	5127.0	7177.8		[1] Included.....		BT351-MPG
1 1/4	11	BSP-PL	5127.0	7 3/32.....180.2		[1] Included.....		BT351
1 1/4	11	BSP-PL	5127.0	7 3/32.....180.2		[1] Included.....	"AD, MBP".....	BT8450
1 1/4	11	BSP-PL	5127.0	7 3/32.....180.2		[1] Included.....		BT8475
1 1/4	11	BSP-PL	5 1/32127.8	7 7/32.....183.4		[1] Included.....		BT9324
1 1/4	11	BSP-PL	5 1/32127.8	8 15/16.....227.0				BT8477-MPG
1 1/4	11	BSP-PL	5 1/16128.6	7 1/16.....179.4				BT8475-MPG
1 1/4	11	BSP-PL	5 1/16128.6	7 3/32.....180.2		[1] Included.....		BT8930
1 1/4	11	BSP-PL	5 1/16128.6	9.....228.6				BT8931
1 1/4	11	BSP-PL	5 1/8130.2	8 11/16.....220.7		[1] Included.....		BT8476
1 1/4	11	BSP-PL	5 1/8130.2	8 11/16.....220.7		[1] Included.....		BT8476-MPG
1 1/4	11	BSP-PL	5 1/8130.2	8 11/16.....220.7		[1] Included.....		BT8477
1 1/4	11	BSP-PL	5 1/8130.2	8 29/32.....226.2		[1] Included.....	Water Absorbent Media.....	BT8915
1 1/4	11	BSP-PL	5 11/32135.7	7177.8		[1] Included.....		BA5378
1 1/4	11	BSP-PL	5 1/2139.7	6 31/32.....177.0		[1] Included.....		BA5375
1 1/2	11	BSP-PL	4 15/16125.4	7 17/32.....191.3			MBP.....	BT9320
1 1/2	11	BSP-PL	5 1/32127.8	7 19/32.....192.9				BT8937

CAUTION!!! Read These Instructions Before Using Size Charts

The filter size charts on this and following pages are for filter experts. Careless use could lead to errors. When you have exhausted all other ways to determine a filter number, locate a suspect here, then check the Product Guide for confirmation.

Size alone does not assure you of the right filtering media, gasket or other features. What is being filtered, filter efficiency, flow rate and direction of flow all have to be considered.

Spin-on filters are listed by tap size rather than length. All other filters are listed on an overall basis. Check your Product Guide for other dimensions. Progression is from the smallest to the largest in each category.

Do NOT Interchange Filters with Different Features

Be Sure to Check Product Guide, Cross-References and Applications

We Cannot be Responsible for Misapplications



WARNING: These products can expose you to chemicals, including Diisononyl Phthalate, Carbon black extracts, Nickel, 1,3 Butadiene, Ethylene Oxide, Epichlorohydrin, which are known to the State of California to cause cancer, and Bisphenol-A, Ethylene Glycol, Ethylene Oxide, 1,3 Butadiene, Epichlorohydrin, which are known to the State of California to cause birth defects or other reproductive harm. For more information go to www.P65Warnings.ca.gov.

SPIN-ON FILTERS BY TAP SIZE (METRIC THREAD)

		THREAD I.D.	O.D. Inches	O.D. (mm)	LENGTH Inches	LENGTH (mm)	GASKET	FEATURES	BALDWIN NUMBER
SPIN-ON FILTER FEATURES ARE CODED AS FOLLOWS		M12 x 1.5	3 1/16.....	77.8	5 1/2.....	139.7	[1] Included.....	PS.....	BF7990
		M12 x 1.5	3 3/8.....	85.7	3 13/16.....	96.8	[2] Included.....	PS.....	BF7619
		M14 x 1.5	3 1/32.....	77.0	3 15/32.....	88.1	G449-B.....		BF1056
AD Anti-Drainback Valve		M14 x 1.5	3 11/16.....	93.7	4 11/16.....	119.1	G381-A.....		BF1361
		M14 x 1.5	3 11/16.....	93.7	7 11/32.....	186.5	[1] Included.....		BF1217
ADP Anti-Drainback Pipe		M16 x 1.5	2 31/32.....	75.4	2 31/32.....	75.4	[1] Included.....		BF7880
		M16 x 1.5	3.....	76.2	2 31/32.....	75.4	[1] Included.....	MBP.....	B7292
BP 8-10 PSID By-Pass Valve		M16 x 1.5	3.....	76.2	3 17/32.....	89.7	G449-B.....	BP.....	B474
		M16 x 1.5	3.....	76.2	4 7/32.....	107.2	G449-B.....	PS.....	BF1257
BPI By-Pass Included		M16 x 1.5	3.....	76.2	4 7/32.....	107.2	G449-B.....		BF1261
		M16 x 1.5	3.....	76.2	4 27/32.....	123.0	G449-B.....	PS.....	BF782
BPS By-Pass Screen		M16 x 1.5	3 1/32.....	77.0	2 5/16.....	58.7	G449-B.....		BT9408
		M16 x 1.5	3 1/32.....	77.0	2 27/32.....	72.2	G449-B.....		BF7909
BTA PLUS Balanced Treatment Additive Plus		M16 x 1.5	3 1/32.....	77.0	2 27/32.....	72.2	G449-B.....		BF7915
		M16 x 1.5	3 1/32.....	77.0	3 1/8.....	79.4	[1] Included.....		BF1267
		M16 x 1.5	3 1/32.....	77.0	3 15/32.....	88.1	G449-B.....		BF790
BTE Balanced Treatment for Ethylene Glycol Antifreeze		M16 x 1.5	3 1/32.....	77.0	4 3/32.....	104.0	[1] Included.....		BF7608
		M16 x 1.5	3 1/32.....	77.0	4 11/32.....	110.3	[1] Included.....		BF9819
D Drain		M16 x 1.5	3 1/32.....	77.0	4 11/16.....	119.1	G449-B.....	PS, SP.....	BF1232
		M16 x 1.5	3 1/32.....	77.0	4 13/16.....	122.2	[1] Included.....		BF9841
FECV Front-End Check Valve		M16 x 1.5	3 1/32.....	77.0	4 27/32.....	123.0	G449-B.....	ADP.....	BF788
		M16 x 1.5	3 1/32.....	77.0	4 27/32.....	123.0	G449-B.....		BF988
FP Fill Port		M16 x 1.5	3 1/32.....	77.0	4 27/32.....	123.0	[1] Included.....		BF7931
		M16 x 1.5	3 1/32.....	77.0	5 7/32.....	132.6	G449-B.....		BF1269
HBP 18-25 PSID High Pressure By-Pass Valve		M16 x 1.5	3 1/32.....	77.0	5 11/32.....	135.7	[1] Included.....		BF9853
		M16 x 1.5	3 1/32.....	77.0	5 11/16.....	144.5	G449-B.....	ADP.....	BF1226
ISO Inside-Out Flow Direction		M16 x 1.5	3 1/32.....	77.0	5 11/16.....	144.5	G449-B.....		BF7921
		M16 x 1.5	3 1/32.....	77.0	5 27/32.....	148.4	G449-B.....		BF586
LBP 2-7 PSID Low Pressure By-Pass Valve		M16 x 1.5	3 1/32.....	77.0	5 27/32.....	148.4	G449-B.....		BF586-D
		M16 x 1.5	3 1/32.....	77.0	5 27/32.....	148.4	G449-B.....		BF7663
MBP 11-17 PSID Medium Pressure By-Pass Valve		M16 x 1.5	3 1/32.....	77.0	5 29/32.....	150.0	[1] Included.....	PS.....	BF1372
		M16 x 1.5	3 1/32.....	77.0	5 29/32.....	150.0	[1] Included.....		BF1396
MO Metering Orifice		M16 x 1.5	3 1/32.....	77.0	6 1/8.....	155.6	G449-B.....		BF587
		M16 x 1.5	3 1/32.....	77.0	6 1/8.....	155.6	G449-B.....		BF587-D
PS Integral Post Seal Gasket		M16 x 1.5	3 1/32.....	77.0	6 1/8.....	155.6	G449-B.....		BF7591-D
		M16 x 1.5	3 1/32.....	77.0	6 1/2.....	165.1	G449-B.....	PS, SP.....	BF7998
PSR Post Seal Required; Must install loose O-Ring or D-Ring on Post for Seal		M16 x 1.5	3 1/32.....	77.0	6 21/32.....	169.1	G449-B.....	ADP.....	BF1221
		M16 x 1.5	3 1/32.....	77.0	6 21/32.....	169.1	G449-B.....		BF1276
RC Reinforced Centertube		M16 x 1.5	3 1/32.....	77.0	6 21/32.....	169.1	G449-B.....		BF1367
		M16 x 1.5	3 1/32.....	77.0	6 21/32.....	169.1	G449-B.....		BF7772
SHBP 30-45 PSID Super High Pressure By-Pass Valve		M16 x 1.5	3 1/16.....	77.8	5 25/32.....	146.8	[1] Included.....		BF9842
		M16 x 1.5	3 1/16.....	77.8	6 1/16.....	154.0	[1] Included.....		BF9840
SP Sensor Port		M16 x 1.5	3 3/32.....	78.6	2 1/2.....	63.5	[1] Included.....	AD, BP.....	B7293
		M16 x 1.5	3 5/32.....	80.2	7 5/16.....	185.7	[1] Included.....	PS.....	BF9812
XHBP 50+ PSID Extra High Pressure By-Pass Valve		M16 x 1.5	3 3/16.....	81.0	6 15/16.....	176.2	[1] Included.....		BF46012
		M16 x 1.5	3 3/16.....	81.0	6 15/16.....	176.2	[1] Included.....		BF46014
Do NOT Interchange Filters with Different Features		M16 x 1.5	3 9/32.....	83.3	6 3/16.....	157.2	[1] Included.....		BF7976
		M16 x 1.5	3 9/32.....	83.3	7 15/32.....	189.7		PS.....	BF9813
		M16 x 1.5	3 9/32.....	83.3	7 15/32.....	189.7	[1] Included.....	PS.....	BF9883
		M16 x 1.5	3 3/8.....	85.7	6 23/32.....	170.7	[1] Included.....		BF7970
		M16 x 1.5	3 7/16.....	87.3	6 13/32.....	162.7	[1] Included.....		BF5587-D
		M16 x 1.5	3 11/16.....	93.7	4 3/8.....	111.1	G381-A.....		BF7883
		M16 x 1.5	3 11/16.....	93.7	4 7/16.....	112.7	G401.....		B5145
		M16 x 1.5	3 11/16.....	93.7	4 7/16.....	112.7	G401.....	BTE.....	BW5183
		M16 x 1.5	3 11/16.....	93.7	5 1/4.....	133.4	G381-A.....		BF7919
		M16 x 1.5	3 11/16.....	93.7	5 3/8.....	136.5	G381-A.....		BF900
		M16 x 1.5	3 11/16.....	93.7	5 3/8.....	136.5	G381-A.....		BF7664
		M16 x 1.5	3 11/16.....	93.7	5 13/32.....	137.3	G401.....		B5091
		M16 x 1.5	3 11/16.....	93.7	5 13/32.....	137.3	G401.....	BTE.....	BW5141
		M16 x 1.5	3 11/16.....	93.7	5 13/32.....	137.3	G401.....	BTE.....	BW5142
		M16 x 1.5	3 11/16.....	93.7	5 13/32.....	137.3	G401.....		BF7888
		M16 x 1.5	3 11/16.....	93.7	5 7/16.....	138.1	G401.....		B5144
		M16 x 1.5	3 11/16.....	93.7	5 7/16.....	138.1	[1] Included.....		BW21000
		M16 x 1.5	3 11/16.....	93.7	7 13/32.....	188.1	G381-A.....		BF1365
		M16 x 1.5	3 11/16.....	93.7	7 31/32.....	202.4	G401.....	SP.....	BF1371
		M16 x 1.5	3 11/16.....	93.7	8 1/8.....	206.4	G381-A.....		BF980
		M16 x 1.5	3 11/16.....	93.7	8 1/8.....	206.4	G381-A.....		BF7696



WARNING: These products can expose you to chemicals, including Diisononyl Phthalate, Carbon black extracts, Nickel, 1,3 Butadiene, Ethylene Oxide, Epichlorohydrin, which are known to the State of California to cause cancer, and Bisphenol-A, Ethylene Glycol, Ethylene Oxide, 1,3 Butadiene, Epichlorohydrin, which are known to the State of California to cause birth defects or other reproductive harm. For more information go to www.P65Warnings.ca.gov.

SPIN-ON FILTERS BY TAP SIZE (METRIC THREAD)

THREAD I.D.	O.D. Inches	O.D. (mm)	LENGTH Inches	LENGTH (mm)	GASKET	FEATURES	BALDWIN NUMBER
M16 x 1.5	3 23/32.....	94.5	5 3/8.....	136.5	G381-A.....		BF7955
M16 x 1.5	3 23/32.....	94.5	7 9/32.....	183.4	G 381-A.....		BF46050
M16 x 1.5	4 1/4.....	108.0	7.....	177.8	G401.....		BF7927
M18 x 1.5	2 25/32.....	70.6	2 13/16.....	71.4	[1] Included.....	AD, BP.....	B40000
M18 x 1.5	2 29/32.....	73.8	3 1/2.....	88.9	G449-B.....	AD.....	B43-S
M18 x 1.5	2 29/32.....	73.8	3 1/2.....	88.9	G449-B.....		B7446
M18 x 1.5	3.....	76.2	4 27/32.....	123.0	G449-B.....	AD.....	B35-S
M18 x 1.5	3 1/32.....	77.0	4 19/32.....	116.7	[1] Included.....	PS, SP.....	BF1379
M18 x 1.5	3 1/32.....	77.0	4 19/32.....	116.7	[1] Included.....	PS, SP.....	BF1380
M18 x 1.5	3 1/32.....	77.0	4 19/32.....	116.7	[1] Included.....	PS, SP.....	BF1381
M18 x 1.5	3 3/32.....	78.6	2 15/32.....	62.7			BF1381-O
M18 x 1.5	3 1/8.....	79.4	3 1/2.....	88.9	[1] Included.....	AD.....	B195
M18 x 1.5	3 11/16.....	93.7	3 7/8.....	98.4	G324-A.....	PS.....	BT338
M18 x 1.5	3 11/16.....	93.7	5 5/8.....	142.9	[1] Included.....		BF7886
M18 x 1.5	3 11/16.....	93.7	5 25/32.....	146.8	[1] Included.....		BF9820
M18 x 1.5	3 11/16.....	93.7	8 1/8.....	206.4	G381-A.....	PS.....	BF7644
M18 x 1.5	3 11/16.....	93.7	8 1/8.....	206.4	G381-A.....	PS.....	BF7653
M18 x 1.5	3 11/16.....	93.7	8 9/32.....	210.3	[1] Included.....		BF46032
M18 x 1.5	3 23/32.....	94.5	8 5/32.....	207.2	[1] Included.....		BF7997
M18 x 1.5	3 25/32.....	96.0	5 13/16.....	147.6			BF46127
M20 x 1.0	2 21/32.....	67.5	2 5/8.....	66.7	[1] Included.....	AD, HBP.....	B7419
M20 x 1.5	2 9/16.....	65.1	2 5/8.....	66.7	[1] Included.....	AD, HBP.....	B7285
M20 x 1.5	2 9/16.....	65.1	3 1/2.....	88.9	[1] Included.....	AD, MBP.....	B1402
M20 x 1.5	2 9/16.....	65.1	3 1/2.....	88.9	[1] Included.....	AD, HBP.....	B7318
M20 x 1.5	2 21/32.....	67.5	2 5/8.....	66.7	[1] Included.....	AD, MBP.....	B1400
M20 x 1.5	2 21/32.....	67.5	4.....	101.6	[1] Included.....	AD, MBP.....	B1431
M20 x 1.5	2 21/32.....	67.5	5 1/2.....	139.7	[1] Included.....	AD, MBP.....	BT40034
M20 x 1.5	2 23/32.....	69.1	3 13/32.....	86.5	[1] Included.....	AD, MBP.....	B7441
M20 x 1.5	3.....	76.2	2 5/16.....	58.7	[1] Included.....	AD, MBP.....	B7276
M20 x 1.5	3.....	76.2	2 27/32.....	72.2	[1] Included.....	AD, BP.....	B179
M20 x 1.5	3.....	76.2	2 27/32.....	72.2	[1] Included.....	AD, HBP.....	B227
M20 x 1.5	3.....	76.2	2 27/32.....	72.2	[1] Included.....	BP.....	B301
M20 x 1.5	3.....	76.2	2 27/32.....	72.2	[1] Included.....	AD, MBP.....	B421
M20 x 1.5	3.....	76.2	2 27/32.....	72.2	[1] Included.....		BF940
M20 x 1.5	3.....	76.2	2 27/32.....	72.2	[1] Included.....	BP.....	B1444
M20 x 1.5	3.....	76.2	2 27/32.....	72.2	[1] Included.....	AD, SHBP.....	B7216
M20 x 1.5	3.....	76.2	2 7/8.....	73.0	G449-B.....	AD, BP.....	B307
M20 x 1.5	3.....	76.2	3 11/32.....	84.9	[1] Included.....	AD, BP.....	B7289
M20 x 1.5	3.....	76.2	3 1/2.....	88.9	G449-B.....		BF7683
M20 x 1.5	3.....	76.2	3 17/32.....	89.7	G449-B.....	AD, LBP.....	BT310
M20 x 1.5	3.....	76.2	4 13/16.....	122.2	[1] Included.....	AD, BP.....	B247
M20 x 1.5	3.....	76.2	4 13/16.....	122.2	[1] Included.....		BT8902
M20 x 1.5	3.....	76.2	5 3/32.....	129.4	[1] Included.....	AD, BP.....	B168
M20 x 1.5	3.....	76.2	5 1/8.....	130.2	G449-B.....	AD, BP.....	B199
M20 x 1.5	3 1/32.....	77.0	2 25/32.....	70.6	[1] Included.....	AD, HBP.....	B7407
M20 x 1.5	3 1/32.....	77.0	3 7/16.....	87.3	[1] Included.....	AD, MBP.....	B1421
M20 x 1.5	3 1/32.....	77.0	3 7/16.....	87.3	[1] Included.....	AD, HBP.....	B1425
M20 x 1.5	3 1/32.....	77.0	3 7/16.....	87.3	[1] Included.....	AD, HBP.....	B7243
M20 x 1.5	3 1/32.....	77.0	3 7/16.....	87.3	[1] Included.....	AD, MBP.....	B7334
M20 x 1.5	3 1/32.....	77.0	3 7/16.....	87.3	[1] Included.....	AD, HBP.....	B7487
M20 x 1.5	3 1/32.....	77.0	3 1/2.....	88.9	G449-B.....	AD, HBP.....	B7167
M20 x 1.5	3 1/32.....	77.0	4 1/16.....	103.2	[1] Included.....	AD, HBP.....	B161-S
M20 x 1.5	3 1/32.....	77.0	4 3/32.....	104.0	[1] Included.....	PS.....	BF1110
M20 x 1.5	3 1/32.....	77.0	4 3/32.....	104.0	[1] Included.....		BF7544
M20 x 1.5	3 1/32.....	77.0	6 1/16.....	154.0	[1] Included.....		BF9821
M20 x 1.5	3 3/32.....	78.6	2 21/32.....	75.4	[1] Included.....		BF7837
M20 x 1.5	3 3/32.....	78.6	3 27/32.....	97.6	[1] Included.....	BP.....	B7277
M20 x 1.5	3 3/32.....	78.6	4 27/32.....	123.0	[1] Included.....	AD, HBP.....	B7390
M20 x 1.5	3 1/8.....	79.4	2 7/8.....	73.0	[1] Included.....	AD, MBP.....	B7429
M20 x 1.5	3 1/8.....	79.4	3.....	76.2	[1] Included.....		BT8917
M20 x 1.5	3 1/8.....	79.4	3 17/32.....	89.7	[1] Included.....	AD, MBP.....	B7352
M20 x 1.5	3 1/8.....	79.4	3 17/32.....	89.7	[1] Included.....	AD, HBP.....	B7428
M20 x 1.5	3 1/8.....	79.4	3 5/8.....	92.1	[1] Included.....	AD, MBP.....	B7445
M20 x 1.5	3 1/8.....	79.4	4 1/32.....	102.4	[1] Included.....	AD, MBP.....	B7430
M20 x 1.5	3 7/32.....	81.8	3 7/8.....	98.4	[1] Included.....	AD, MBP.....	B7281
M20 x 1.5	3 7/32.....	81.8	4 25/32.....	121.4	[1] Included.....		BF7838
M20 x 1.5	3 1/2.....	88.9	2 11/32.....	59.5	[1] Included.....	AD, BP.....	B7283

CAUTION!!! Read These Instructions Before Using Size Charts

The filter size charts on this and following pages are for filter experts. Careless use could lead to errors. When you have exhausted all other ways to determine a filter number, locate a suspect here, then check the Product Guide for confirmation.

Size alone does not assure you of the right filtering media, gasket or other features. What is being filtered, filter efficiency, flow rate and direction of flow all have to be considered.

Spin-on filters are listed by tap size rather than length. All other filters are listed on an overall basis. Check your Product Guide for other dimensions. Progression is from the smallest to the largest in each category.

Do NOT Interchange Filters with Different Features
Be Sure to Check Product Guide, Cross-References and Applications

We Cannot be Responsible for Misapplications



WARNING: These products can expose you to chemicals, including Diisononyl Phthalate, Carbon black extracts, Nickel, 1,3 Butadiene, Ethylene Oxide, Epichlorohydrin, which are known to the State of California to cause cancer, and Bisphenol-A, Ethylene Glycol, Ethylene Oxide, 1,3 Butadiene, Epichlorohydrin, which are known to the State of California to cause birth defects or other reproductive harm. For more information go to www.P65Warnings.ca.gov.

SPIN-ON FILTERS BY TAP SIZE (METRIC THREAD)

A TYPICAL SPIN-ON

Spin-ons vary in size, media, fittings and other features. Let's look at the usual components.

Spin-on Can



No housing to clean; faster to change.

Baseplate and Seaming Cover Assembly



Size of mounting hole and gasket location determine if filter will seal. The baseplate is attached to the seaming cover and the seaming cover is attached to the can. (The gasket fits in the seaming cover.)

Compression Spring



Holds element in place to maintain seal.

Element End Caps



Closed End

Open End

End caps are bonded to the media.

Filtering Media



Microlite® pleated paper comes in more than 60 types for exact filtering requirements.

Centertube

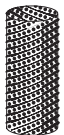

Media is wrapped around the spiral perforated/louvered steel tube.

THREAD I.D.	O.D. Inches	O.D. (mm)	LENGTH Inches	LENGTH (mm)	GASKET	FEATURES	BALDWIN NUMBER
M20 x 1.5	3 9/16	90.5	3 15/32	88.1	[1] Included	AD, HBP	B7432
M20 x 1.5	3 9/16	90.5	5 7/16	138.1	G381-A		BF7534
M20 x 1.5	3 9/16	90.5	7	177.8	[1] Included		BF9850
M20 x 1.5	3 19/32	91.3	4 13/16	122.2	[1] Included	HBP	B7384
M20 x 1.5	3 19/32	91.3	5 1/8	130.2	[1] Included	AD, HBP	B7469
M20 x 1.5	3 19/32	91.3	7 1/8	181.0	[1] Included		BF9815
M20 x 1.5	3 19/32	91.3	7 7/8	200.0	[1] Included		BF9852
M20 x 1.5	3 5/8	92.1	5 1/16	128.6	[1] Included	AD, BP	B7273
M20 x 1.5	3 5/8	92.1	6 11/16	169.9	[1] Included		BF9878
M20 x 1.5	3 11/16	93.7	2 27/32	72.2	G324-A	PS	BF7552
M20 x 1.5	3 11/16	93.7	3 1/4	82.6	G381-A	AD, HBP	B173-S
M20 x 1.5	3 11/16	93.7	3 1/4	82.6	G324-A	AD, HBP	B488
M20 x 1.5	3 11/16	93.7	3 1/4	82.6	[1] Included	PS	BF9887
M20 x 1.5	3 11/16	93.7	3 1/4	82.6			BF46111
M20 x 1.5	3 11/16	93.7	3 3/8	85.7	[1] Included	HBP, PS	B7453
M20 x 1.5	3 11/16	93.7	3 27/32	97.6	[1] Included	AD, MBP	B7197
M20 x 1.5	3 11/16	93.7	3 7/8	98.4	G381-A	AD, HBP	B141
M20 x 1.5	3 11/16	93.7	3 7/8	98.4	G381-A		BF789
M20 x 1.5	3 11/16	93.7	4 3/8	111.1	G324-A	PS	BF720
M20 x 1.5	3 11/16	93.7	4 3/8	111.1	G401	SP	BF1233
M20 x 1.5	3 11/16	93.7	4 3/8	111.1	G324-A	PS	BF7538
M20 x 1.5	3 11/16	93.7	4 11/16	119.1	G324-A		BF7528
M20 x 1.5	3 11/16	93.7	5 3/32	129.4	[1] Included	AD, BP	B7082
M20 x 1.5	3 11/16	93.7	5 3/8	136.5	G381-A	AD, HBP	B202
M20 x 1.5	3 11/16	93.7	5 3/8	136.5	G401	PS, SP	BF1271
M20 x 1.5	3 11/16	93.7	5 3/8	136.5	G381-A	AD, MBP	B7042
M20 x 1.5	3 11/16	93.7	5 5/8	142.9	G324-A	PS	BF7907
M20 x 1.5	3 11/16	93.7	6 23/32	170.7	G401	PS	BF7957
M20 x 1.5	3 11/16	93.7	7 1/8	181.0	G381-A		BF7813
M20 x 1.5	3 11/16	93.7	7 7/32	183.4	G401		BF7922
M20 x 1.5	3 11/16	93.7	7 7/32	183.4	G401	PS	BF7940
M20 x 1.5	3 11/16	93.7	7 7/32	183.4	G381-A		BF7966
M20 x 1.5	3 11/16	93.7	7 3/8	187.3	[1] Included	SP	BF1352-SPS
M20 x 1.5	3 11/16	93.7	7 13/32	188.1	G381-A		BF1356
M20 x 1.5	3 23/32	94.5	3 27/32	97.6	[1] Included	HBP	B1446
M20 x 1.5	3 23/32	94.5	3 7/8	98.4	G324-A	PS	BF792
M20 x 1.5	3 23/32	94.5	7 9/32	184.9	G381-A	PS, SP	BF7941
M20 x 1.5	3 23/32	94.5	7 5/16	185.7	G381-A	PS, SP	BF7942
M20 x 1.5	3 23/32	94.5	7 31/32	202.4	G401		BF7979
M20 x 1.5	3 23/32	94.5	8 3/32	205.6	[1] Included	SHBP	B7163
M20 x 1.5	3 3/4	95.3	5 5/16	134.9	[1] Included	AD, HBP	B109
M20 x 1.5	3 25/32	96.0	3 1/4	82.6	[1] Included	AD, HBP	B166
M20 x 1.5	3 25/32	96.0	4 11/32	110.3	[1] Included		B7034
M20 x 1.5	3 27/32	97.6	5 19/32	142.1	[1] Included		BF7842
M20 x 1.5	4 1/4	108.0	3 3/16	81.0	[1] Included		B201-S
M20 x 1.5	4 1/4	108.0	4 3/4	120.7	[1] Included	AD, HBP	B7189
M20 x 1.5	4 1/4	108.0	5 27/32	148.4	[1] Included	HBP	B211
M20 x 1.5	4 1/4	108.0	5 27/32	148.4	[1] Included		B337
M20 x 1.5	4 1/4	108.0	5 27/32	148.4	[1] Included	AD, MBP	BF585
M20 x 1.5	4 1/4	108.0	7 5/8	193.7	[1] Included		B7164
M20 x 1.5	4 9/32	108.7	4	101.3	[1] Included		B7280
M22 x 1.5	3	76.2	3 1/2	88.9	G449-B	AD, HBP	B160
M22 x 1.5	3	76.2	3 1/2	88.9	G449-B	AD, HBP	B7422
M22 x 1.5	3	76.2	3 1/2	88.9	G449-B	AD, BP	B7443
M22 x 1.5	3	76.2	4 3/32	104.0	G449-B	AD, HBP	B7449
M22 x 1.5	3	76.2	4 27/32	123.0	G449-B	HBP	B56
M22 x 1.5	3	76.2	4 27/32	123.0	G449-B	AD, BP	BF7444
M22 x 1.5	3 1/32	77.0	2 25/32	70.6	[1] Included	AD, MBP	B7401
M22 x 1.5	3 1/32	77.0	3 1/2	88.9	G449-B	AD, HBP	B1422
M22 x 1.5	3 1/32	77.0	4 1/16	103.2	[1] Included	AD, MBP	B7033
M22 x 1.5	3 3/32	78.6	5 1/2	139.7	[1] Included	PS	BF9910
M22 x 1.5	3 11/16	93.7	2 13/16	71.4	G381-A	AD, SHBP	B7496
M22 x 1.5	3 11/16	93.7	3 1/4	82.6	G324-A	AD, HBP	B156
M22 x 1.5	3 11/16	93.7	5 3/8	85.7	G381-A	AD, SHBP	B7377
M22 x 1.5	3 11/16	93.7	3 3/4	95.3	[1] Included	AD, MBP	B7001
M22 x 1.5	3 11/16	93.7	3 7/8	98.4	G381-A	AD, HBP	B329
M22 x 1.5	3 11/16	93.7	4 3/8	111.3	G381-A		BF9894
M22 x 1.5	3 11/16	93.7	5 3/8	136.5	G381-A	AD, HBP	B281



WARNING: These products can expose you to chemicals, including Diisononyl Phthalate, Carbon black extracts, Nickel, 1,3 Butadiene, Ethylene Oxide, Epichlorohydrin, which are known to the State of California to cause cancer, and Bisphenol-A, Ethylene Glycol, Ethylene Oxide, 1,3 Butadiene, Epichlorohydrin, which are known to the State of California to cause birth defects or other reproductive harm. For more information go to www.P65Warnings.ca.gov.

SPIN-ON FILTERS BY TAP SIZE (METRIC THREAD)

THREAD I.D.	O.D. Inches	O.D. (mm)	LENGTH Inches	LENGTH (mm)	GASKET	FEATURES	BALDWIN NUMBER
M22 x 1.5	3 11/16	93.7	5 3/8	136.5	G381-A	AD, ADP, SHBP	B7388
M22 x 1.5	3 11/16	93.7	5 5/8	142.9	G381-A		BF7747
M22 x 1.5	3 11/16	93.7	6 5/32	156.4	G381-A		BF9893
M22 x 1.5	3 11/16	93.7	6 5/8	168.3	G381-A	AD, ADP, SHBP	B7376
M22 x 1.5	3 11/16	93.7	7 15/16	201.6		SP	BF1289-SP
M22 x 1.5	3 25/32	96.0	6 11/16	169.9	[1] Included	AD, FECV, SHBP	B7350
M22 x 1.5	3 7/8	98.4	5 7/32	132.6	[1] Included		BT8919
M22 x 1.5	4 1/4	108.0	7 19/32	192.9	[1] Included	PS	BF7656
M22 x 1.5	4 1/4	108.0	9 15/16	252.4	[1] Included	PS	BF1256
M23 x 1.5	3 13/16	96.8	4 5/16	109.5	G381-A	AD, SHBP	BT9318
M23 x 1.5	3 7/8	98.4	8 1/4	209.6	[1] Included		OAS98060
M24 x 1.5	3 11/16	93.7	5 13/32	137.3	G401	SHBP	B7306
M24 x 1.5	3 11/16	93.7	5 9/16	141.3	G401		BF7624
M24 x 1.5	3 11/16	93.7	5 21/32	143.7	[1] Included		BF7908
M24 x 1.5	3 11/16	93.7	5 11/16	144.5	G401	AD, SHBP	B7360
M24 x 1.5	3 11/16	93.7	6 19/32	167.5	[1] Included	PS	BF798
M24 x 1.5	3 11/16	93.7	6 19/32	167.5	[1] Included	PS	BF7993
M24 x 1.5	3 11/16	93.7	6 7/8	174.6	G401		BF46048
M24 x 1.5	3 11/16	93.7	7 3/16	182.6	G401	AD, ADP	BF1102
M24 x 1.5	3 11/16	93.7	8 1/8	206.4	G381-A	AD, HBP	B7378
M24 x 1.5	3 23/32	94.5	4 3/16	81.0	[1] Included	SHBP	BT9471
M24 x 1.5	3 3/4	95.3	5 1/4	133.4	[1] Included		BF9923-O
M24 x 1.5	3 31/32	100.8	4 27/32	123.0	[1] Included	AD, LBP	BD7029
M24 x 1.5	4 1/4	108.0	5 27/32	148.4	G401	AD, HBP	B7179
M24 x 2.0	3 19/32	91.3	5 13/16	147.6	[1] Included	AD, HBP	B7472
M24 x 2.0	3 19/32	91.3	6 5/8	168.3	[1] Included	MBP	B7476
M24 x 2.0	3 21/32	92.9	5 1/8	130.2	[1] Included	HBP, PS	B7451
M24 x 2.0	3 21/32	92.9	5 5/8	142.9	G381-A		B7026-MPG
M24 x 2.0	3 11/16	93.7	6 5/32	156.4	G381-A		BF7925
M24 x 2.0	4 1/4	108.0	5 9/32	134.1	[1] Included	MBP	B7477
M26 x 1.5	3 17/32	89.7	4 15/16	125.4	[1] Included	MBP	BD7160
M26 x 1.5	3 11/16	93.7	5 3/8	136.5	G381-A	AD, HBP	BD28
M26 x 1.5	3 11/16	93.7	7 1/8	181.0	G381-A	AD	BD7095
M26 x 1.5	4 1/4	108.0	5 27/32	148.4	G401	HBP	BD7028
M26 x 1.5	4 1/4	108.0	5 27/32	148.4	G401	MBP	B7045
M26 x 1.5	4 1/4	108.0	7 11/32	186.5	[1] Included	MBP	B7121
M27 x 2.0	3 11/16	93.7	3 7/8	98.4	G381-A	AD, ADP, SHBP	B7499
M27 x 2.0	3 11/16	93.7	6 5/8	168.3	[1] Included		BT7237
M27 x 2.0	3 11/16	93.7	6 5/8	168.3	G381-A	AD	B7327
M27 x 2.0	3 23/32	94.5	3 7/8	98.4	G381-A		B7328
M27 x 2.0-6H	3 23/32	94.5	5 3/8	136.5		HBP	B40056
M27 x 2.0	4	101.8	6 7/8	174.6			B40050
M30 x 1.5	4 1/4	108.0	5 5/8	142.9	[1] Included	SHBP	BT221
M30 x 1.5	4 1/4	108.0	7 9/16	192.1	[1] Included	HBP	B7142
M30 x 1.5	4 1/4	108.0	7 19/32	192.9	[1] Included	PS	BF7773
M30 x 1.5	4 1/4	108.0	8 11/32	211.9	[1] Included	PS	BF1286
M30 x 1.5	4 1/4	108.0	10 7/16	265.1	[1] Included	PS	BF7657
M30 x 1.5	4 9/32	108.7	6 1/4	158.8	[1] Included	AD, HBP	B7393
M30 x 2.0	4 1/4	108.0	7 13/32	188.1	[1] Included	SHBP	B7116
M30 x 2.0	4 1/4	108.0	7 11/16	195.3	[1] Included	SHBP	B7383
M30 x 2.0	4 1/4	108.0	8 7/16	214.3	[1] Included	SHBP	BD325
M30 x 2.0	4 1/4	108.0	9 1/8	231.8	[1] Included	AD, HBP	BT472
M30 x 2.0	4 1/4	108.0	9 1/8	231.8	[1] Included	AD, FECV, SHBP	B7171
M30 x 2.0	4 1/4	108.0	9 1/8	231.8	[1] Included		B7174-MPG
M30 x 2.0	4 5/16	109.5	10 3/8	263.5	[1] Included	AD, HBP	BD7168
M32 x 1.5	4 1/4	108.0	8 25/32	223.0	[1] Included	PS, SHBP	BD7158
M32 x 1.5	4 1/4	108.0	10 15/32	265.9	[1] Included		BF7814
M32 x 1.5	4 1/4	108.0	10 15/32	265.9	[1] Included		BF7943
M32 x 1.5	4 1/4	108.0	10 15/32	265.9	[1] Included	PS	BF9800
M32 x 1.5	4 1/4	108.0	10 15/32	265.9	[1] Included		BF9802
M32 x 1.5	4 9/32	108.7	10 11/32	262.7	[1] Included		BF9817
M32 x 1.5	4 1/4	108.8	10 15/32	265.9	[1] Included		BF46034
M32 x 1.5	4 11/32	110.3	8 7/8	225.4			BF46117

SPIN-ON FEATURES

Some spin-ons have no additional features while others have several. Here are some of the more important spin-on features:

Anti-Drainback Valve



As the name implies, this valve keeps the oil from draining from a filter when the engine is shut off. (Some filters include an anti-drainback standpipe for the same function). The mounting direction determines the need for this feature.

By-Pass Valve



Full-flow oil systems require a by-pass (relief) valve either in the system or in the filter. This valve opens at a predetermined setting to assure oil flow to the bearings at all times.

Integral Post Seal



Seals threaded stud to prevent tiny particles from spiraling in via the threads.

We Cannot be Responsible for Misapplications



WARNING: These products can expose you to chemicals, including Diisononyl Phthalate, Carbon black extracts, Nickel, 1,3 Butadiene, Ethylene Oxide, Epichlorohydrin, which are known to the State of California to cause cancer, and Bisphenol-A, Ethylene Glycol, Ethylene Oxide, 1,3 Butadiene, Epichlorohydrin, which are known to the State of California to cause birth defects or other reproductive harm. For more information go to www.P65Warnings.ca.gov.

SPIN-ON FILTERS BY TAP SIZE (METRIC THREAD)

	THREAD I.D.	O.D. Inches	O.D. (mm)	LENGTH Inches	LENGTH (mm)	GASKET	FEATURES	BALDWIN NUMBER
SPIN-ON FILTER FEATURES ARE CODED AS FOLLOWS								
AD	Anti-Drainback Valve	M36 x 1.5	5 1/8.....	130.2	8 21/32.....	219.9	[1] Included PS	BD1403
		M36 x 1.5	5 11/32.....	135.7	12 7/32.....	310.4	[1] Included SHBP	B40013
		M36 x 1.5	5 3/8.....	136.5	12 3/32.....	307.2	[1] Included SHBP	B7030
		M36 x 1.5	5 3/8.....	136.5	12 3/32.....	307.2	[1] Included BPS, SHBP	B7229
		M36 x 2.0	3 3/4.....	95.3	5 13/32.....	138.9	[1] Included BTA PLUS	BW5086
		M36 x 2.0	3 3/4.....	95.3	5 15/32.....	138.9	B5087
ADP	Anti-Drainback Pipe	M38 x 2.0	3 11/16.....	93.7	5 9/16.....	141.3	[1] Included	BT8304
BP	8-10 PSID By-Pass Valve	M39 x 1.5	5 3/8.....	136.5	6 19/32.....	167.5	[1] Included	BA5379
		M39 x 1.5 LH	5 3/8.....	136.5	6 19/32.....	167.5	[1] Included	BA5566
BPI	By-Pass Included	M39 x 1.5	5 3/8.....	136.5	12 1/8.....	308.0	[1] Included PS	BF7996
BPS	By-Pass Screen	M39 x 1.5	5 1/2.....	139.7	6 19/32.....	167.5	[1] Included	BA5374
		M39 x 1.5	5 1/2.....	139.7	6 19/32.....	167.5	[1] Included	BA5592
BTA PLUS	Balanced Treatment Additive Plus	M40 x 2.0	4 3/16.....	106.4	7 1/16.....	179.4	[1] Included	BT8920
BTE	Balanced Treatment for Ethylene Glycol Antifreeze	M41 x 1.5	5 7/16.....	138.1	6 19/32.....	167.5	[1] Included	BA5284
		M41 x 1.5	5 1/2.....	139.7	5 15/32.....	138.9	[1] Included	BA5376
D	Drain	M42 x 2.0	5 3/8.....	136.5	8 5/8.....	219.1	[1] Included BP, BPS	BT9387
		M42 x 2.0	5 3/8.....	136.5	8 7/8.....	225.4	[1] Included SHBP	B7161
FECV	Front-End Check Valve	M42 x 2.0	5 3/8.....	136.5	12 3/8.....	314.3	[1] Included SHBP	B7162
		M42 x 2.0	5 3/8.....	136.5	12 3/8.....	314.3	[1] Included SHBP	B7224
		M42 x 2.0	5 13/32.....	137.3	7 1/8.....	181.0	[1] Included	BT9164
		M42 x 2.0-6G	5 7/16.....	138.1	3 15/16.....	100.0	[1] Included	BT23537
FP	Fill Port	M45 x 1.5	5 3/8.....	136.5	9 5/8.....	244.5	[1] Included SHBP	B7314
HBP	18-25 PSID High Pressure By-Pass Valve	M45 x 1.5	5 3/8.....	136.5	12 3/32.....	307.2	[1] Included	B7135
		M45 x 1.5	5 3/8.....	136.5	12 3/32.....	307.2	[1] Included	B7175
		M45 x 2.0	3 7/16.....	87.3	6 1/16.....	154.0	[1] Included	BT9464
		M45 x 2.0-6H	3 7/16.....	87.3	6 17/32.....	165.9	[1] Included	BT23607-MPG
ISO	Inside-Out Flow Direction	M45 x 2.0	5 7/16.....	138.1	6 15/16.....	176.2	[1] Included	BT9533
LBP	2-7 PSID Low Pressure By-Pass Valve	M48 x 2.0	5 9/32.....	134.1	6 27/32.....	173.8	[1] Included	BT8906
		M48 x 2.0	5 9/32.....	134.1	11 15/32.....	291.3	[1] Included	BT9377
MBP	11-17 PSID Medium Pressure By-Pass Valve	M52 x 1.5	4 21/32.....	118.3	11 13/32.....	289.7	G293-B Venturi-Type Cone	BD7310
		M52 x 1.5	4 21/32.....	118.3	11 7/32.....	361.2	[1] Included	BD7353
		M52 x 1.5-6H	4 11/16.....	119.1	11 25/32.....	299.2	[1] Included	BD40027
		M60 x 1.5	3 31/32.....	100.8	7 1/4.....	184.2	BT8914
		M60 x 2.0	4 5/32.....	105.6	10 3/8.....	263.5	[1] Included	BT9454
MO	Metering Orifice	M60 x 3.0	5 15/32.....	138.9	6 3/4.....	171.5	[1] Included MBP	B7097
PS	Integral Post Seal Gasket	M68 x 2.0	3 7/16.....	87.3	6 13/32.....	162.7	BT9440
PSR	Post Seal Required; Must install loose O-Ring or D-Ring on Post for Seal	M72 x 2.0	3 23/32.....	94.5	9 5/32.....	232.6	[1] Included	BF7766
		M72 x 2.0	3 7/8.....	98.4	9 3/16.....	233.4	[1] Included	BT9368-MPG
		M82 x 1.5	4 1/4.....	108.0	8 7/8.....	225.4	[1] Included BP	BT9437
RC	Reinforced Centertube	M85 x 2.0	4 21/32.....	118.3	11 5/8.....	295.3	[1] Included SP	BF1274-SP
		M85 x 2.0	4 21/32.....	118.3	11 5/8.....	295.3	[1] Included SP	BF1274-SPS
SHBP	30-45 PSID Super High Pressure By-Pass Valve	M85 x 2.0	4 21/32.....	118.3	11 5/8.....	295.3	[1] Included SP	BF1277-SP
		M85 x 2.0	4 21/32.....	118.3	11 5/8.....	295.3	[1] Included SP	BF1277-SPS
		M85 x 2.0	4 11/16.....	119.1	11 1/8.....	282.6	[1] Included	BF9920
SP	Sensor Port	M90 x 2.0	4 23/32.....	119.9	7 11/16.....	195.3	[1] Included	BT8503-MPG
XHBP	50+ PSID Extra High Pressure By-Pass Valve	M90 x 2.0	4 23/32.....	119.9	8 29/32.....	226.2	[1] Included	BT9369-MPG
		M90 x 2.0	4 23/32.....	119.9	11 9/16.....	293.7	[1] Included	BF9860
		M90 x 2.0-7H	4 23/32.....	119.9	11 9/16.....	293.7	[1] Included	BT23543-MPG
		M90 x 2.0	4 23/32.....	119.9	11 5/8.....	295.3	[1] Included Venturi-Type Cone	BD7176
		M90 x 2.0	4 23/32.....	119.9	11 23/32.....	297.7	[1] Included	BT9347-MPG
		M90 x 2.0	4 23/32.....	119.9	11 29/32.....	302.4	[1] Included	BT9367-MPG
		M90 x 2.0	4 23/32.....	120.0	8 27/32.....	224.6	[1] Included	BF9885
		M92 x 2.0	4 21/32.....	118.3	10 11/32.....	262.7	[1] Included Venturi-Type Cone	BD7252



WARNING: These products can expose you to chemicals, including Diisononyl Phthalate, Carbon black extracts, Nickel, 1,3 Butadiene, Ethylene Oxide, Epichlorohydrin, which are known to the State of California to cause cancer, and Bisphenol-A, Ethylene Glycol, Ethylene Oxide, 1,3 Butadiene, Epichlorohydrin, which are known to the State of California to cause birth defects or other reproductive harm. For more information go to www.P65Warnings.ca.gov.

SPIN-ON FILTERS BY TAP SIZE (METRIC THREAD)

THREAD I.D.	O.D. Inches	O.D. (mm)	LENGTH Inches	LENGTH (mm)	GASKET	FEATURES	BALDWIN NUMBER
M92 x 2.5	3 29/32.....	99.2	5 15/16.....	150.8	[1] Included.....		B7322
M95 x 2.0	4 21/32.....	118.3	14 7/32.....	361.2	[1] Included.....	Venturi-Type Cone.....	BD7250
M95 x 2.5	4 1/4.....	108.0	6 7/32.....	158.0			BF46100-O
M95 x 2.5	4 21/32.....	118.3	11 25/32.....	299.2	[1] Included.....	Venturi-Type Cone.....	BD7154
M95 x 2.5	4 21/32.....	118.3	14 7/32.....	361.2	[1] Included.....	Venturi-Type Cone.....	BD7153
M95 x 2.5	4 11/16.....	119.1	11 25/32.....	299.2	[1] Included.....		BD7355
M95 x 2.5	4 11/16.....	119.1	11 25/32.....	299.2	[1] Included.....	Venturi-Type Cone.....	BD7509
M95 x 2.5-6H	4 11/16.....	119.1	11 25/32.....	299.2	[1] Included.....		BD50000
M120 x 2.0	5 3/32.....	129.4	11.....	279.4			BT9360

CAUTION!!!

Read These Instructions Before Using Size Charts

The filter size charts on this and following pages are for filter experts. Careless use could lead to errors. When you have exhausted all other ways to determine a filter number, locate a suspect here, then check the Product Guide for confirmation.

Size alone does not assure you of the right filtering media, gasket or other features. What is being filtered, filter efficiency, flow rate and direction of flow all have to be considered.

Spin-on filters are listed by tap size rather than length. All other filters are listed on an overall basis. Check your Product Guide for other dimensions. Progression is from the smallest to the largest in each category.

Do NOT Interchange Filters with Different Features

Be Sure to Check Product Guide, Cross-References and Applications

We Cannot be Responsible for Misapplications



WARNING: These products can expose you to chemicals, including Diisononyl Phthalate, Carbon black extracts, Nickel, 1,3 Butadiene, Ethylene Oxide, Epichlorohydrin, which are known to the State of California to cause cancer, and Bisphenol-A, Ethylene Glycol, Ethylene Oxide, 1,3 Butadiene, Epichlorohydrin, which are known to the State of California to cause birth defects or other reproductive harm. For more information go to www.P65Warnings.ca.gov.

LIQUID ELEMENTS BY LENGTH

All Measurements in Inches and (Millimeters)

NOTE: All liquid element filters have been sorted by length and then outside diameter. The larger outside and inside diameters have been listed.

LENGTH Inches	LENGTH (mm)	O.D. Inches	O.D. (mm)	I.D. Inches	I.D. (mm)	BALDWIN NUMBER	LENGTH Inches	LENGTH (mm)	O.D. Inches	O.D. (mm)	I.D. Inches	I.D. (mm)	BALDWIN NUMBER
25/32	19.9	5/8	15.9	7/32	5.6	SF898	2 5/16	58.7	4 7/32	107.2	1 11/16	42.9	101-30
15/16	23.8	1 5/8	41.3	1 1/16	27.0	PF7882	2 5/16	58.7	4 7/32	107.2	1 11/16	42.9	101-W
1 1/32	26.2	11/16	17.5	9/32	7.1	PF893	2 11/32	59.5	29/32	22.9	13/32	10.3	P7262
1 1/32	26.2	11/16	17.5	9/32	7.1	PF893-RV	2 11/32	59.5	1 13/32	35.7	5/16	7.9	P7261
1 1/16	27.0	1 3/4	44.5	15/32	11.9	PF857	2 11/32	59.5	3 5/32	80.2	3/4	19.1	PF7817
11 1/16	27.0	3 1/16	77.7	1 19/32	40.4	PT23325	2 7/16	61.9	3 9/16	90.5	1 11/32	34.1	P7255
1 1/4	31.8	2	50.8	1 5/8	41.3	S423	2 15/32	62.7	1 7/8	47.6	23/32	18.3	PF224
1 1/4	31.8	2 3/4	69.9	1 25/32	45.2	PT23574-MPG	2 15/32	62.7	2 5/32	54.8	15/16	23.8	PF7836
15/16	33.3	1 13/16	46.0	15/32	11.9	PF864	2 1/2	63.5	3 17/32	89.7	1 1/8	28.6	P186
15/16	33.3	1 13/16	46.0	5/8	15.9	PT23069-MPG	2 17/32	64.3	1 7/32	31.0	15/32	11.9	P7260
13/8	34.9	1 1/2	38.1	1 1/8	28.6	S455	2 17/32	64.3	1 17/32	38.9	15/32	11.9	P7303
1 3/8	34.9	2 15/16	74.6	1 3/16	30.2	PT9481-MPG	2 17/32	64.3	2 15/32	62.7	13/32	10.3	PF7550
1 3/8	34.9	3 15/16	100.0	1 1/16	27.0	PT548	2 17/32	64.3	7 1/4	184.2	2 7/8	73.0	PT558
1 13/32	35.7	1 19/32	40.5	31/32	24.6	PF7824	2 9/16	65.1	2 1/2	63.5	1 3/8	34.9	P40014
1 7/16	36.5	1 9/16	39.7	15/32	11.9	P9603	2 9/16	65.1	2 3/4	69.9	9/16	14.3	PF506
1 7/16	36.5	1 31/32	50.0	15/32	11.9	P7132	2 9/16	65.1	2 7/8	73.0	21/32	16.7	PF945
1 15/32	37.3	2 1/4	57.2	27/32	21.4	PF847	2 9/16	65.1	3 3/16	81.0	1 1/16	27.0	P144
1 1/2	38.1	2 3/4	69.9	9/16	14.3	PF314	2 9/16	65.1	5	127.0	2 29/32	73.8	PT534
1 17/32	38.9	2 7/8	73.0	1 1/16	27.0	PT214(2)	2 19/32	65.9	2 9/16	65.1	13/16	20.6	PF9862
1 9/16	39.7	1 7/16	36.5	1/2	12.7	PT23145	2 5/8	66.7	2 1/8	54.0	7/8	22.2	PT23528-MPG
1 9/16	39.7	2 15/32	62.7	1 1/16	27.0	P450	2 5/8	66.7	2 3/8	60.3	11/16	17.5	PF46009
1 9/16	39.7	3 3/16	81.0	1 1/16	27.0	P183	2 5/8	66.7	2 9/16	65.1	1/2	12.7	PF986
1 5/8	41.3	1 31/32	50.0	1 19/32	40.5	PF7939	2 5/8	66.7	2 1/8	66.7	25/32	19.8	PT23031-MPG
1 5/8	41.3	1 31/32	50.0	1 19/32	40.5	PF7974	2 5/8	66.7	2 3/4	69.9	1 3/32	27.8	PF398
1 23/32	43.7	2 29/32	73.8	23/32	18.3	61	2 21/32	67.5	2 1/32	51.6	1/2	12.7	PF7833
1 23/32	43.7	2 29/32	73.8	23/32	18.3	61-W	2 11/16	68.3	3 1/4	82.6	5/16	7.9	BC40007
1 3/4	44.5	1 3/8	34.9	15/32	11.9	PF7822	2 23/32	69.1	1 3/8	34.9	1/2	12.7	PF937
1 3/4	44.5	1 3/8	34.9	1/2	12.7	PF7873	2 23/32	69.1	2 5/32	54.8	11/16	17.5	PT8998-MPG
1 3/4	44.5	5	127.0	3 9/32	83.3	PF7627	2 23/32	69.1	2 3/16	55.6	1 1/8	28.6	PT8975-MPG
1 25/32	45.2	1 11/16	42.9	15/32	11.9	PF7549	2 23/32	69.1	2 9/16	65.1	1 3/32	27.8	P7450
1 13/16	46.0	7/8	22.2	3/8	9.5	PF7819	2 23/32	69.1	2 1/8	66.7	1 1/8	28.6	PT23032-MPG
1 13/16	46.0	2 1/4	57.2	1 7/8	47.6	S451	2 23/32	69.1	3 3/8	85.7	1 1/8	28.6	PT9354-MPG
1 13/16	46.0	2 15/16	74.6	1/2	12.7	66	2 23/32	69.1	3 3/8	85.7	2	50.8	PT9449
1 13/16	46.0	2 15/16	74.6	1/2	12.7	66-W	2 3/4	69.9	1 3/8	34.9	15/32	11.9	PF7830
1 13/16	46.0	2 15/16	74.6	1/2	12.7	66-W	2 3/4	69.9	2 1/8	54.0	15/16	23.8	PT23088-MPG
1 27/32	46.8	1 1/2	12.7	17/32	13.5	P40002	2 3/4	69.9	2 29/32	73.8	11/16	17.5	P140
1 27/32	46.8	2 11/16	68.3	13/16	20.6	P9602	2 3/4	69.9	3 7/32	81.8	5/8	15.9	PF598
1 7/8	47.6	1 3/8	34.9	9/16	14.3	PF859	2 3/4	69.9	3 7/32	81.8	5/8	15.9	PF598-10
1 15/16	49.2	1 3/8	34.9	7/16	11.1	PF7975	2 3/4	69.9	3 7/32	81.8	5/8	15.9	PF598-30
1 15/16	49.2	1 7/16	36.5	15/32	11.9	PF9873	2 3/4	69.9	3 5/16	84.1	13/16	20.6	PF838
2 1/32	51.6	11/16	17.5	9/32	7.1	PF894	2 25/32	70.6	1 3/8	34.9	7/16	11.1	PF46077
2 1/32	51.6	11/16	17.5	9/32	7.1	PF894-RV	2 25/32	70.6	2 1/32	51.6	29/32	23.0	P7256
2 1/32	51.6	1 3/8	34.9	15/32	11.9	PF7869	2 25/32	70.6	3 5/32	80.2	21/32	16.7	PF9838
2 1/32	51.6	2 1/32	51.6	1 15/32	37.3	PT9426	2 25/32	70.6	3 15/32	88.1	1 15/32	37.3	PT903
2 1/16	52.4	1 5/8	41.3	9/16	14.3	PF7874	2 25/32	70.6	3 15/32	88.1	1 15/32	37.3	PT951
2 1/16	52.4	1 21/32	42.1	27/32	21.4	PT9424	2 13/16	71.4	2 1/4	57.2	15/16	23.8	PT23087-MPG
2 1/16	52.4	1 31/32	50.0	9/16	14.3	PF7875	2 13/16	71.4	2 3/8	60.3	15/16	23.8	PT23193-MPG
2 1/16	52.4	2 3/32	53.2	23/32	18.3	PT459	2 27/32	72.2	1 11/16	42.9	1 13/32	35.7	PF7994
2 3/32	53.2	2 9/16	65.1	9/16	14.3	PF7596	2 27/32	72.2	1 3/4	44.5	15/32	11.9	PF599
2 1/8	54.0	1 13/16	46.0	1/32	0.8	PF9911	2 27/32	72.2	1 3/4	44.5	15/32	11.9	PF599-10
2 1/8	54.0	1 31/32	50.0	29/32	23.0	P540	2 27/32	72.2	1 3/4	44.5	15/32	11.9	PF599-30
2 1/8	54.0	2 7/8	73.0	17/32	13.5	PF860	2 27/32	72.2	5 9/32	134.1	3 19/32	91.3	PT23587
2 5/32	54.8	2 27/32	72.2	11/32	8.7	PT23314	2 7/8	73.0	29/32	23.0	13/32	10.3	P7263
2 3/16	55.6	1 23/32	43.7	17/32	13.5	P7490	2 7/8	73.0	2 1/16	52.4	31/32	24.6	PT9142
2 3/16	55.6	2 27/32	72.2	1 25/32	45.2	PT9228	2 7/8	73.0	2 9/16	65.1	31/32	24.6	P7313
2 7/32	56.4	1 1/8	28.6	5/16	7.9	PF7818	2 7/8	73.0	3 3/4	95.3	1 5/16	33.3	P190
2 7/32	56.4	2 15/16	74.6	5/8	15.9	PF861	2 29/32	73.8	2 3/4	69.9	31/32	24.6	PT23527
2 7/32	56.4	3 1/32	77.0	1 19/32	40.5	BT8386	2 31/32	75.4	2 1/16	52.4	29/32	23.0	PT9240
2 1/4	57.2	2 3/8	60.3	1 3/32	27.8	P7454	2 31/32	75.4	2 9/16	65.1	11/16	17.5	PF866
2 1/4	57.2	3 1/32	77.0	7/8	22.2	P148	3	76.2	1 1/8	28.6	3/16	4.8	PF7820
2 9/32	57.9	1 1/8	28.6	17/32	13.5	PF7545	3	76.2	1 31/32	50.0	15/16	23.8	PT9179
2 5/16	58.7	4 7/32	107.2	1 11/16	42.9	101	3	76.2	1 31/32	50.0	1 1/32	26.2	PT9236-MPG



WARNING: These products can expose you to chemicals, including Diisononyl Phthalate, Carbon black extracts, Nickel, 1,3 Butadiene, Ethylene Oxide, Epichlorohydrin, which are known to the State of California to cause cancer, and Bisphenol-A, Ethylene Glycol, Ethylene Oxide, 1,3 Butadiene, Epichlorohydrin, which are known to the State of California to cause birth defects or other reproductive harm. For more information go to www.P65Warnings.ca.gov.

LIQUID ELEMENTS BY LENGTH

LENGTH Inches	LENGTH (mm)	O.D. Inches	O.D. (mm)	I.D. Inches	I.D. (mm)	BALDWIN NUMBER	LENGTH Inches	LENGTH (mm)	O.D. Inches	O.D. (mm)	I.D. Inches	I.D. (mm)	BALDWIN NUMBER
3	76.2	2	50.8	15/16	23.8	PT23097-MPG	3 9/16	90.5	6 7/32	158.0	2 17/32	64.3	PT23526
3	76.2	2 1/4	57.2	13/32	10.3	PF935	3 19/32	91.3	1 5/8	41.3	29/32	23.0	PT9209
3	76.2	2 17/32	64.3	1/2	12.7	PF9823	3 19/32	91.3	2 5/32	54.8	29/32	23.0	PF997
3	76.2	2 23/32	69.1	31/32	24.6	PE5270	3 19/32	91.3	2 3/4	69.9	1 3/32	27.8	PT9239
3	76.2	2 3/4	69.9	7/16	11.1	P7178	3 5/8	92.1	1 1/4	31.8	3/8	9.5	PT23086-MPG
3	76.2	2 7/8	73.0	1 1/16	27.0	P187	3 5/8	92.1	1 21/32	42.0	29/32	23.0	PT23319
3	76.2	5	127.0	2 13/16	71.4	PT565	3 5/8	92.1	2 7/16	61.9	1 3/8	34.9	P7442
3	76.2	5	127.0	2 15/16	74.6	PT379 KIT	3 5/8	92.1	2 3/4	69.9	1 3/32	27.8	PT9180
3	76.2	5 3/32	129.2	2 9/16	65.1	PT8907-MPG	3 5/8	92.1	2 7/8	73.0	1 1/8	28.6	PT728-MPG
3 1/32	77.0	1 1/16	27.0	3/8	9.5	P7302	3 5/8	92.1	3	76.2	1 1/16	27.0	PF906
3 1/32	77.0	3 5/16	84.1	11/32	8.7	PF46088	3 11/16	93.7	1 3/8	34.9	7/16	11.1	PT9271
3 1/16	77.8	2 7/8	73.0	15/16	23.8	PF816-S	3 21/32	92.8	1 3/8	34.9	15/32	12.0	PT23367-MPG
3 3/32	78.2	2 7/16	61.9	1 7/32	31.0	P1440	3 21/32	92.9	1 3/8	34.9	1/2	12.7	PT8960-MPG
3 3/32	78.6	1 31/32	50.0	27/32	21.4	PT8341	3 11/16	93.7	1 3/8	34.9	1/2	12.7	PT9337-MPG
3 1/8	79.4	23/32	18.3	5/8	15.9	PF9907	3 21/32	92.8	1 3/8	34.9	1/2	12.7	PT23377-MPG
3 1/8	79.4	1 5/8	41.3	5/8	15.9	PT23055-MPG	3 11/16	93.7	1 27/32	46.8	1	25.4	PT8952-MPG
3 1/8	79.4	1 13/16	46.0	15/16	23.8	PT23096-MPG	3 11/16	93.7	1 27/32	46.8	1	25.4	PT23387-MPG
3 1/8	79.4	1 31/32	50.0	25/32	19.8	PF7832	3 11/16	93.7	1 27/32	46.8	1 1/32	26.2	PT9255
3 1/8	79.4	2 7/8	73.0	1 5/8	41.3	P7438	3 11/16	93.7	3 19/32	91.3	1 15/32	37.3	PT7455
3 1/8	79.4	2 15/16	74.6	1 1/4	31.8	PF816	3 11/16	93.7	3 23/32	94.5	1 1/32	26.2	PF9803
3 1/8	79.4	3 3/4	95.3	1 1/32	26.2	PF7834	3 23/32	94.5	1 27/32	46.8	1	25.4	PT23058-MPG
3 5/32	80.2	1 1/16	27.0	5/8	15.9	PT283	3 3/4	95.3	1 7/8	47.6	1	25.4	PT23384-MPG
3 5/32	80.2	1 3/32	27.8	11/32	8.7	PT23571-MPG	3 3/4	95.3	2 7/16	62.0	1 1/2	38.1	PT23337
3 5/32	80.2	2 3/4	69.9	1 5/32	29.4	PT23017	3 3/4	95.3	2 23/32	69.1	1 5/32	29.4	PF7829
3 5/32	80.2	2 7/8	73.0	27/32	21.4	P240	3 3/4	95.3	2 3/4	69.9	-	-	PT9193
3 5/32	80.2	2 7/8	73.0	1 1/32	26.2	P7338	3 3/4	95.3	2 13/16	71.4	1 7/32	31.0	PT7413
3 3/16	81.0	2 13/16	71.4	1 3/32	27.8	P7408	3 3/4	95.3	3	76.2	-	-	BF7626
3 7/32	81.8	2 3/4	69.9	1 3/32	27.8	P7418	3 3/4	95.3	4 17/32	115.1	2 1/4	57.2	P206
3 9/32	83.3	1 27/32	46.8	13/16	20.6	PT9302-MPG	3 25/32	96.0	1 31/32	50.0	13/32	10.3	PF7823
3 9/32	83.3	2 9/16	65.1	31/32	24.6	P9605	3 13/16	96.8	1 3/4	44.5	3/4	19.1	PT23107-MPG
3 9/32	83.3	3	76.2	-	-	BT40038	3 13/16	96.8	2 1/8	54.0	23/32	18.3	P1433
3 5/16	84.1	1 27/32	46.8	7/8	22.2	PT8894-MPG	3 13/16	96.8	3 3/32	78.6	9/16	14.3	PF936
3 5/16	84.1	1 27/32	46.8	7/8	22.2	PT8962-MPG	3 13/16	96.8	3 3/4	95.3	1 5/16	33.3	PT915
3 5/16	84.1	1 27/32	46.8	7/8	22.2	PT23037-MPG	3 27/32	97.6	3 17/32	89.7	-	-	PT9213
3 5/16	84.1	1 27/32	46.8	7/8	22.2	PT23374-MPG	3 7/8	98.4	2 7/8	73.0	1 7/16	36.5	PF7916
3 5/16	84.1	1 27/32	46.8	7/8	22.2	PT23379-MPG	3 7/8	98.4	3 21/32	92.9	1 23/32	43.7	PF1587
3 5/16	84.1	1 27/32	46.8	7/8	22.2	PT23494-MPG	3 7/8	98.4	3 3/4	95.3	1 1/16	27.0	PF9890
3 5/16	84.1	2 7/8	73.0	9/16	14.3	PF313	3 7/8	98.4	3 3/4	95.3	1 3/32	27.8	PF9897
3 5/16	84.1	2 7/8	73.0	1 5/16	33.3	PF820-S	3 29/32	99.2	2 27/32	72.2	1 11/32	34.1	P1566
3 11/32	84.9	1 25/32	45.2	1 1/32	26.2	PT8995-MPG	3 29/32	99.2	2 29/32	73.8	1 1/4	31.7	PT23489-MPG
3 11/32	84.9	2 3/32	53.2	1 3/32	26.2	PT9478-MPG	3 29/32	99.2	3 21/32	92.9	1 23/32	43.7	P1575
3 11/32	85.0	2 3/4	70.0	1 5/32	29.3	PT23478	3 29/32	99.2	3 11/16	93.7	1 29/32	48.4	PT679
3 11/32	85.0	2 3/4	70.0	1 5/32	29.3	PT23500-MPG	3 29/32	99.2	3 11/16	93.7	1 29/32	48.4	PT23197-MPG
3 3/8	85.7	1 25/32	45.2	15/16	23.8	PT9206	3 29/32	99.2	3 11/16	93.7	1 29/32	48.4	PT23490-MPG
3 3/8	85.7	1 13/16	46.0	3/8	9.5	P7247	3 29/32	99.2	4 5/16	109.5	13/16	20.6	PF7889
3 3/8	85.7	2 3/4	69.9	13/16	20.6	PF46112	3 29/32	99.2	4 5/16	109.5	13/16	20.6	PF7889-10
3 13/32	86.5	1 3/16	30.2	5/16	7.9	PF7877	3 29/32	99.2	4 5/16	109.5	13/16	20.6	PF7889-30
3 13/32	86.5	1 25/32	45.2	15/16	23.8	PT9310-MPG	3 15/16	100.0	1 1/8	28.6	21/32	16.7	PT23073-MPG
3 7/16	87.3	1 1/8	28.6	1/2	12.7	PF872	3 15/16	100.0	1 3/4	43.8	1	25.4	PT9477
3 7/16	87.3	1 21/32	42.1	27/32	21.4	PT8392	3 15/16	100.0	2 19/32	65.9	7/16	11.1	PE5271
3 7/16	87.3	1 21/32	42.1	27/32	21.4	PT9537-MPG	3 15/16	100.0	2 5/8	66.7	1/2	12.7	P40058
3 15/32	88.1	1 21/32	42.1	29/32	23.0	PT8372	3 15/16	100.0	3 11/32	84.9	1 9/16	39.7	PF9845
3 15/32	88.1	2 1/16	52.4	7/16	11.1	PF827	3 31/32	100.8	2 1/4	57.2	1 1/16	27.0	PF818
3 15/32	88.1	2 7/8	73.0	1 5/16	33.3	P176	3 31/32	100.8	2 5/16	58.7	11/16	17.5	P106
3 1/2	88.9	1 3/8	34.9	1/2	12.7	PF981	3 31/32	100.8	2 5/16	58.7	11/16	17.5	P106-HD
3 1/2	88.9	1 3/8	34.9	1 1/4	31.8	PT23036-MPG	3 31/32	100.8	2 9/16	65.1	1 3/32	27.8	P40024
3 1/2	88.9	1 1/2	38.1	1 1/8	28.6	S485	3 31/32	100.8	2 5/8	66.7	7/16	11.1	PF9909
3 1/2	88.9	1 21/32	42.1	5/8	15.9	PT23573-MPG	3 31/32	100.8	2 3/4	69.9	1 5/8	41.3	PT9178
3 1/2	88.9	1 21/32	42.1	27/32	21.4	PT9462	3 31/32	100.8	2 7/8	73.0	13/16	20.6	PT48
3 1/2	88.9	1 21/32	42.1	7/8	22.2	PT257	3 31/32	100.8	4 3/8	111.1	2 7/16	61.9	PT9420-MPG
3 1/2	88.9	1 31/32	50.0	25/32	19.8	PF717							
3 1/2	88.9	2 1/2	63.5	1 11/16	42.9	PT9516	4	101.6	1 15/16	49.2	13/16	20.6	PT23105-MPG
3 1/2	88.9	2 25/32	70.6	1 3/32	27.8	PT9289-MPG	4	101.6	2 1/16	52.4	23/32	18.3	P7411
3 17/32	89.7	1 5/8	41.3	27/32	21.4	PT9208	4	101.6	2 7/8	73.0	1/2	12.7	PF947
3 9/16	90.5	2 15/32	62.7	1 1/16	27.0	P454	4	101.6	3 1/32	77.0	23/32	18.3	PF807
3 9/16	90.5	2 15/32	62.7	1 3/32	27.8	P446	4 1/32	102.4	1 3/8	34.9	7/8	22.2	PT284
3 9/16	90.5	2 15/32	62.7	1 3/32	27.8	P7134	4 1/32	102.4	2 5/16	58.7	5/8	15.9	PT9423
3 9/16	90.5	2 7/8	73.0	15/32	11.9	P7103	4 1/32	102.4	2 17/32	64.3	31/32	24.6	P7426
3 9/16	90.5	4 7/8	123.8	9/16	14.3	PF7698	4 1/32	102.4	3 9/32	83.3	1 11/16	42.9	PT7488



WARNING: These products can expose you to chemicals, including Diisononyl Phthalate, Carbon black extracts, Nickel, 1,3 Butadiene, Ethylene Oxide, Epichlorohydrin, which are known to the State of California to cause cancer, and Bisphenol-A, Ethylene Glycol, Ethylene Oxide, 1,3 Butadiene, Epichlorohydrin, which are known to the State of California to cause birth defects or other reproductive harm. For more information go to www.P65Warnings.ca.gov.

LIQUID ELEMENTS BY LENGTH

LENGTH Inches	LENGTH (mm)	O.D. Inches	O.D. (mm)	I.D. Inches	I.D. (mm)	BALDWIN NUMBER	LENGTH Inches	LENGTH (mm)	O.D. Inches	O.D. (mm)	I.D. Inches	I.D. (mm)	BALDWIN NUMBER
4 1/16	103.2	1 25/32	45.2	3/4	19.1	PT9134	4 11/32	110.3	2 7/8	73.0	9/16	14.3	PF7588
4 1/16	103.2	1 13/16	46.0	13/16	20.6	PT23338-MPG	4 11/32	110.3	3 1/8	79.3	1 7/8	47.6	PT23269-MPG
4 1/16	103.2	2 5/16	58.7	1 5/16	33.3	PT23320	4 11/32	110.3	3 1/4	82.6	1 9/16	39.7	PT7136
4 1/16	103.2	2 23/32	69.1	1 3/8	34.9	PT8385	4 11/32	110.3	3 5/8	92.1	19/32	15.1	PF7758
4 1/16	103.2	2 13/16	71.4	1 1/2	38.1	PT23190	4 11/32	110.3	7 13/16	198.4	1 1/16	27.0	PT23534
4 1/16	103.2	2 7/8	73.0	13/16	20.6	PF946	4 3/8	111.1	1 11/16	42.8	15/16	23.8	PT23294-MPG
4 1/16	103.2	3 1/32	77.0	7/8	22.2	P7365	4 3/8	111.1	1 3/4	44.4	15/16	23.8	PT23260-MPG
4 1/16	103.2	3 9/32	83.3	1 1/16	27.0	P40011	4 3/8	111.1	2 7/8	73.0	21/32	16.7	P496
4 1/16	103.2	3 5/16	84.1	15/16	23.8	P81	4 3/8	111.1	2 7/8	73.0	1 3/16	30.2	PT849
4 1/16	103.2	3 5/16	84.1	15/16	23.8	P84-2	4 3/8	111.1	2 7/8	73.0	1 3/16	30.2	PT849-10
4 1/16	103.2	3 5/8	92.1	1 3/32	27.8	PF7735	4 3/8	111.1	2 7/8	73.0	1 5/16	33.3	PT382
4 1/16	103.2	3 11/16	93.6	1 15/16	49.2	PT23351-MPG	4 13/32	111.9	2 1/16	52.4	15/16	23.8	P40010
4 1/16	103.2	5	127.0	1 7/16	36.5	PT9386-MPG	4 13/32	111.9	2 5/16	58.7	1/2	12.7	PF7910
4 3/32	104.0	1 25/32	45.2	13/16	20.6	PT8972-MPG	4 13/32	111.9	3 23/32	94.5	9/16	14.3	PT151
4 3/32	104.0	1 25/32	45.2	13/16	20.6	PT9195	4 7/16	112.7	1 25/32	45.2	1	25.4	PT9510
4 3/32	104.0	1 25/32	45.2	13/16	20.6	PT23309	4 7/16	112.7	2 29/32	73.8	1 5/16	33.3	P172
4 3/32	104.0	2 9/16	65.1	1 1/16	27.0	P40061	4 7/16	112.7	3 23/32	94.5	1/2	12.7	P40
4 3/32	104.0	2 7/8	73.0	1 1/4	31.8	P7427	4 15/32	113.5	1 3/4	44.5	1	25.4	PT23322
4 3/32	104.0	2 7/8	73.0	1 11/32	34.1	PT23329	4 15/32	113.5	1 3/4	44.5	1 1/32	26.2	H9042
4 3/32	104.0	3 3/8	85.7	13/16	20.6	PF7777	4 15/32	113.5	1 3/4	44.5	1 1/32	26.2	H9043
4 3/32	104.0	3 3/8	85.7	13/16	20.6	PF7977	4 15/32	113.5	1 3/4	44.5	1 1/32	26.2	H9044
4 1/8	104.8	1 11/16	42.9	3/4	19.1	PT23100-MPG	4 15/32	113.5	1 25/32	45.2	15/16	23.8	PT9137
4 1/8	104.8	1 3/4	44.5	3/4	19.1	PT9126	4 15/32	113.5	1 25/32	45.2	1	25.4	PT23018
4 1/8	104.8	1 7/8	47.6	3/4	19.0	PT23171	4 15/32	113.5	1 25/32	45.2	1	25.4	PT23463
4 1/8	104.8	2 7/32	56.4	15/16	23.8	PT9308-MPG	4 15/32	113.5	1 25/32	45.2	1	25.4	PT23492-MPG
4 1/8	104.8	2 3/8	60.3	15/16	23.8	PT9482-MPG	4 15/32	113.5	1 25/32	45.2	1	25.4	PT23510-MPG
4 1/8	104.8	2 7/8	73.0	1 3/16	30.2	PT681	4 15/32	113.5	1 13/16	46.0	15/16	23.8	PT9295-MPG
4 1/8	104.8	2 29/32	73.8	1 1/4	31.8	PT8984-MPG	4 15/32	113.5	2 3/32	53.2	29/32	23.0	PT9435-MPG
4 1/8	104.8	3 1/4	82.6	1 9/16	39.7	P7138	4 15/32	113.5	3 9/32	83.3	21/32	16.7	BF7675-D
4 1/8	104.8	3 5/16	84.1	1 1/8	28.6	PT62	4 15/32	113.5	3 9/32	83.3	21/32	16.7	BF7745-D
4 1/8	104.8	3 3/8	85.7	13/16	20.6	PT9394-MPG	4 15/32	113.5	3 15/32	88.1	23/32	18.3	BF46113-D
4 1/8	104.8	3 3/4	95.2	1 15/16	49.2	PT23346-MPG	4 1/2	114.3	1 5/8	41.2	15/16	23.8	PT23218-MPG
4 5/32	105.6	1 13/16	43.0	-	-	PT9222	4 1/2	114.3	1 3/4	44.4	15/16	23.8	PT23258-MPG
4 5/32	105.6	2 27/32	72.2	1 25/32	44.5	PT9185	4 1/2	114.3	1 3/4	44.4	15/16	23.8	PT23270-MPG
4 5/32	105.6	4 1/32	102.4	2 7/16	61.9	PT8407	4 1/2	114.3	1 3/4	44.5	1	25.4	H9049
4 5/32	105.6	5	127.0	7/8	22.2	P8448	4 1/2	114.3	1 3/4	44.5	1	25.4	H9050
4 3/16	106.4	1 11/16	42.9	1 1/32	26.2	PT461	4 1/2	114.3	1 3/4	44.5	1	25.4	H9054
4 3/16	106.4	1 13/16	46.0	13/16	20.6	PT23164	4 1/2	114.3	1 3/4	44.5	1 1/8	28.6	PT23074-MPG
4 3/16	106.4	2 1/4	57.2	13/16	20.6	P7489	4 1/2	114.3	1 25/32	45.2	1	25.4	PT258
4 3/16	106.4	2 27/32	72.2	2	50.8	PT8987-MPG	4 1/2	114.3	1 25/32	45.2	1	25.4	PT23126-MPG
4 3/16	106.4	2 7/8	73.0	27/32	21.4	P271	4 1/2	114.3	1 25/32	45.2	1 1/32	26.2	H9041
4 3/16	106.4	2 15/16	74.6	1 1/4	31.7	PT23350-MPG	4 1/2	114.3	1 25/32	45.2	1 1/32	26.2	H9043-V
4 3/16	106.4	2 29/32	78.3	5/8	15.9	PF9825	4 1/2	114.3	1 31/32	50.0	7/8	22.2	PT23280-MPG
4 3/16	106.4	3 7/32	81.8	1 17/32	38.9	PT9416-MPG KIT	4 1/2	114.3	2	50.8	7/8	22.2	PT23263-MPG
4 3/16	106.4	3 7/32	81.8	1 17/32	38.9	PT23127-MPG	4 1/2	114.3	2	50.8	15/16	23.8	H9107
4 3/16	106.4	3 7/16	87.3	23/32	18.3	PF814	4 1/2	114.3	2	50.8	15/16	23.8	H9108
4 3/16	106.4	3 7/16	87.3	23/32	18.3	PT9374	4 1/2	114.3	2	50.8	15/16	23.8	H9110
4 3/16	106.4	3 7/16	87.3	1 9/16	39.7	P17	4 1/2	114.3	2	50.8	15/16	23.8	PT9484-MPG
4 3/16	106.4	3 15/32	88.1	13/16	20.6	P73	4 1/2	114.3	2	50.8	15/16	23.8	PT23205-MPG
4 3/16	106.4	4 3/4	120.7	1 9/16	39.7	P528	4 1/2	114.3	2	50.8	15/15	23.8	PT23286-MPG
4 3/16	106.4	6	152.4	3 1/2	88.9	PT208	4 1/2	114.3	2	50.8	15/16	23.8	PT23418-MPG
4 7/32	107.2	2 9/16	65.1	1 1/16	27.0	P7364	4 1/2	114.3	2 1/32	51.5	15/16	23.8	PT23400-MPG
4 7/32	107.2	2 7/8	73.0	19/32	15.1	PF7551	4 1/2	114.3	2 11/16	68.3	29/32	23.0	F834-F
4 7/32	107.2	2 7/8	73.0	1	25.4	PF802	4 1/2	114.3	2 3/4	69.8	1 3/4	34.4	PT23357-MPG
4 7/32	107.2	3 5/32	80.1	1 1/8	28.5	PT23219-MPG	4 1/2	114.3	2 29/32	73.8	27/32	21.4	PT108
4 7/32	107.2	3 15/16	100.0	21/32	16.7	PF7572	4 1/2	114.3	2 29/32	73.8	27/32	21.4	PT108-HD
4 1/4	108.0	2 7/8	73.0	9/16	14.3	P960	4 1/2	114.3	3 3/16	81.0	1 1/16	27.0	PF828
4 1/4	108.0	2 7/8	73.0	27/32	21.4	PF913	4 1/2	114.3	3 27/32	97.6	1/2	12.7	BC7173
4 1/4	108.0	2 7/8	73.0	1 5/16	33.3	P171	4 1/2	114.3	3 27/32	97.6	9/16	14.3	BC7194
4 9/32	108.7	2 1/2	63.5	1 31/32	50.0	PT23333	4 1/2	114.3	3 27/32	97.6	5/8	15.9	BC110
4 9/32	108.7	2 9/16	65.1	1/2	12.7	PF834	4 1/2	114.3	3 15/16	100.0	1 5/8	41.3	PF987
4 9/32	108.7	4 7/32	107.2	1 11/16	42.9	151	4 17/32	115.0	2 23/32	69.0	1 11/32	34.1	PT23376-MPG
4 9/32	108.7	4 7/32	107.2	1 11/16	42.9	151-30	4 17/32	115.1	2 9/16	65.1	1 7/32	31.0	P7493
4 9/32	108.7	4 7/32	107.2	1 11/16	42.9	151-W	4 17/32	115.1	2 9/16	65.1	1 7/32	31.0	P40001
4 5/16	109.5	2 17/32	64.2	-	-	PT9223	4 17/32	115.1	2 23/32	69.1	1 11/32	34.1	PT8955-MPG
4 5/16	109.5	3	76.2	13/16	20.6	PF46057	4 17/32	115.1	2 3/4	69.9	7/16	11.1	F953-F
4 5/16	109.5	3 15/32	88.1	21/32	16.7	PF46033	4 17/32	115.1	3 7/32	81.8	1/2	12.7	BF9836-D
4 5/16	109.5	4 1/8	104.8	1 1/8	28.6	PF7751	4 17/32	115.1	4 7/8	123.8	9/16	14.3	PF7678
4 11/32	110.3	2 7/8	73.0	9/16	14.3	PF311	4 9/16	115.8	2 11/16	68.2	1 1/4	31.7	PT23206-MPG



WARNING: These products can expose you to chemicals, including Diisononyl Phthalate, Carbon black extracts, Nickel, 1,3 Butadiene, Ethylene Oxide, Epichlorohydrin, which are known to the State of California to cause cancer, and Bisphenol-A, Ethylene Glycol, Ethylene Oxide, 1,3 Butadiene, Epichlorohydrin, which are known to the State of California to cause birth defects or other reproductive harm. For more information go to www.P65Warnings.ca.gov.

LIQUID ELEMENTS BY LENGTH

LENGTH Inches	LENGTH (mm)	O.D. Inches	O.D. (mm)	I.D. Inches	I.D. (mm)	BALDWIN NUMBER	LENGTH Inches	LENGTH (mm)	O.D. Inches	O.D. (mm)	I.D. Inches	I.D. (mm)	BALDWIN NUMBER
4 9/16	115.9	2 3/32	53.2	7/8	22.2	PT8895-MPG	4 7/8	123.8	3	76.2	-	-	PF10-CS
4 9/16	115.9	2 17/32	64.3	1 1/4	31.8	P1443	4 7/8	123.8	3	76.2	1	25.4	PT727-HD
4 9/16	115.9	2 23/32	69.1	1 9/32	32.5	PT9149	4 7/8	123.8	3	76.2	1	25.4	PT727-HD10
4 9/16	115.9	2 23/32	69.1	1 5/16	33.3	PT8957-MPG	4 7/8	123.8	4 7/32	107.2	1/2	12.7	P41
4 9/16	115.9	3 9/32	83.3	17/32	13.5	PT691	4 7/8	123.8	4 7/32	107.2	1/2	12.7	PF809
4 9/16	115.9	3 9/32	83.3	3/4	19.1	PF9861	4 29/32	124.6	2 5/32	54.8	23/32	18.3	PT8991-MPG
4 9/16	115.9	3 25/32	96.0	15/32	11.9	PF9919	4 29/32	124.6	2 3/4	69.9	1 5/8	41.3	PT9396
4 19/32	116.7	2 5/16	58.7	1/2	12.7	PT9131	4 15/16	125.4	2 1/2	63.5	1 7/32	31.0	PT7399
4 19/32	116.7	3 1/16	77.8	1 9/16	39.6	PT9312-MPG	4 15/16	125.4	2 1/2	63.5	1 7/32	31.0	PT7417
4 19/32	116.7	3 3/32	78.6	1 11/16	42.9	H9072-V	4 15/16	125.4	2 7/8	73.0	1 1/16	27.0	PT273
4 5/8	117.4	2 1/8	54.0	1	25.4	PT23208-MPG	4 15/16	125.4	2 15/16	74.6	1	25.4	PT23142
4 5/8	117.4	2 3/4	69.8	1 7/16	36.5	PT23207-MPG	4 15/16	125.4	4 1/2	114.3	13/16	20.6	P47
4 5/8	117.5	2 1/8	54.0	15/16	23.8	PT23090-MPG	4 15/16	125.4	4 31/32	126.2	1 9/16	39.7	PT371
4 5/8	117.5	2 9/32	57.9	1/4	6.4	PF7816	4 31/32	126.2	3 15/32	88.1	5/8	15.9	PT23136
4 5/8	117.5	2 9/16	65.1	17/32	13.5	PT135	5	127.0	2	50.8	1 5/8	41.3	S456
4 5/8	117.5	2 11/16	68.3	1 1/8	28.6	P7406	5	127.0	2 5/8	66.7	1 7/32	31.0	PT492
4 5/8	117.5	3 1/8	79.4	1 11/16	42.9	H9069	5	127.0	2 3/4	69.9	1 5/16	33.3	PT9414-MPG
4 5/8	117.5	3 1/8	79.4	1 11/16	42.9	H9070	5	127.0	2 3/4	69.9	1 3/8	35.0	PT23212-MPG
4 5/8	117.5	3 1/8	79.4	1 11/16	42.9	H9071	5	127.0	3 1/2	88.9	1 5/32	29.4	BF7956-D
4 5/8	117.5	3 1/8	79.4	1 11/16	42.9	H9072	5	127.0	3 19/32	91.3	-	-	BF7756
4 5/8	117.5	3 1/8	79.4	1 11/16	42.9	PT9404-MPG	5	127.0	3 3/4	95.3	1 1/8	28.6	PT468-MPG
4 5/8	117.5	3 5/16	84.1	15/16	23.8	PT269	5	127.0	4 7/32	107.2	1/2	12.7	P53
4 5/8	117.5	6 1/16	154.0	3 9/32	83.3	201	5	127.0	4 3/8	111.1	2 13/32	61.1	PT764
4 5/8	117.5	6 1/16	154.0	3 9/32	83.3	201-30	5	127.0	4 3/8	111.1	2 13/32	61.1	PT765
4 5/8	117.5	6 1/16	154.0	3 9/32	83.3	201-W	5	127.0	4 3/8	111.1	2 7/16	61.9	PT8462-MPG
4 21/32	118.3	2 7/32	56.4	1	25.4	PT23575-MPG	5 1/32	127.8	2 15/32	62.7	1 3/32	27.8	PT9419-MPG
4 21/32	118.3	2 7/8	73.0	1 1/16	27.0	PT9508	5 1/32	127.8	3 31/32	100.8	1 5/8	41.3	P127
4 21/32	118.3	3 1/16	77.7	1 11/16	42.8	PT9485-MPG	5 1/16	128.6	2 7/8	73.0	2 1/32	16.7	P497
4 21/32	118.3	3 1/16	77.7	1 11/16	42.8	PT23408-MPG	5 1/16	128.6	3 15/16	100.0	2 1/4	57.2	PT437
4 21/32	118.3	3 1/16	77.7	1 11/16	42.8	PT23436-MPG	5 1/16	128.6	4 17/32	115.1	2 9/32	57.9	P203
4 21/32	118.3	3 3/32	78.5	1 11/16	42.8	PT23484-MPG	5 1/16	128.6	4 17/32	115.1	2 9/32	57.9	P203-HD
4 21/32	118.3	3 5/16	84.1	17/32	13.4	BF7866	5 1/16	128.6	4 17/32	115.1	2 9/32	57.9	PT203-HD10
4 11/16	119.1	1 5/32	29.4	5/8	15.9	PT256	5 3/32	129.4	2 7/8	73.0	1 3/8	34.9	P7400
4 11/16	119.1	1 3/4	44.4	1	25.4	PT23447-MPG	5 3/32	129.4	3 3/16	81.0	1 3/32	27.8	PT7114
4 11/16	119.1	2 3/32	53.2	1	25.4	PT9311-MPG	5 3/32	129.4	6 1/2	165.1	-	-	PT102
4 11/16	119.1	2 3/32	53.2	1 3/32	27.8	PT8996-MPG	5 1/8	130.2	1 9/16	39.7	11/32	8.7	PF7826
4 11/16	119.1	2 1/8	54.0	15/16	23.8	PT23292-MPG	5 1/8	130.2	2 3/4	69.9	1 1/8	28.6	PT9242
4 11/16	119.1	3	76.2	1 1/16	27.0	PT8468	5 1/8	130.2	2 3/4	70.0	1 5/32	29.3	PT23501-MPG
4 11/16	119.1	3 3/16	81.0	5/8	15.9	P40035	5 1/8	130.2	2 3/4	70.0	1 3/8	35.0	PT23470
4 11/16	119.1	3 1/4	82.6	3/4	19.1	S489	5 1/8	130.2	3 9/32	83.3	1 1/4	31.8	PF121
4 11/16	119.1	3 3/4	95.3	1 5/16	33.3	PT12	5 1/8	130.2	3 15/16	100.0	1 1/8	28.6	P545
4 11/16	119.1	4 7/32	107.2	17/32	13.5	P26	5 1/8	130.2	4 5/16	109.5	-	-	PT9531
4 23/32	119.9	2 25/32	70.6	25/32	19.8	PF9801	5 1/8	130.2	4 5/8	117.5	1 5/16	33.3	PT85
4 23/32	119.9	3 5/16	84.1	9/16	14.3	PT9214	5 5/32	131.0	2 25/32	70.6	1 5/16	33.3	PT9273
4 23/32	119.9	3 7/16	87.3	21/32	16.7	PF7687	5 5/32	131.0	2 27/32	72.2	27/32	21.4	PF7787
4 23/32	119.9	3 15/32	88.1	1 11/32	34.1	PT374	5 5/32	131.0	3 29/32	99.2	-	-	PT9139
4 23/32	119.9	3 19/32	91.3	-	-	BF7778	5 3/16	131.8	2 27/32	72.2	13/16	20.6	PF7788
4 3/4	120.7	2 5/8	66.7	1 7/32	31.0	PT23536	5 3/16	131.8	3 1/16	77.8	2 1/8	54.0	PF9902
4 3/4	120.7	2 3/4	69.8	1	25.4	PT23203-MPG	5 3/16	131.8	3 7/32	81.8	7/8	22.2	PT269
4 3/4	120.7	3 1/4	82.6	1 13/32	35.7	P125	5 7/32	132.6	2 7/32	56.3	1 3/32	27.7	PT23233-MPG
4 3/4	120.7	3 23/32	94.5	13/32	10.3	PF7594	5 7/32	132.6	2 3/4	69.9	1 3/32	27.8	PT8989-MPG
4 25/32	121.4	1 25/32	45.2	3/4	19.1	PT9147	5 7/32	132.6	2 3/4	69.9	1 1/8	28.6	PT9237
4 25/32	121.4	2 19/32	65.9	1 3/32	27.8	P7515	5 7/32	132.6	2 25/32	70.6	1 7/32	31.0	PT9256-MPG
4 25/32	121.4	2 7/8	73.0	1 11/32	34.1	PT8352	5 7/32	132.6	3 9/32	83.3	21/32	16.7	BF7673-D
4 13/16	122.2	2 5/16	33.3	1 1/16	27.0	PT23195-MPG	5 7/32	132.6	3 9/32	83.3	21/32	16.7	BF7681-D
4 13/16	122.2	2 1/8	54.0	3/4	19.0	PT23290-MPG	5 7/32	132.6	3 9/32	83.3	21/32	16.7	BF7699-D
4 13/16	122.2	2 11/32	59.5	1 1/2	38.1	PT9140	5 7/32	132.6	3 9/32	83.3	21/32	16.7	BF7783-D
4 13/16	122.2	2 5/8	66.7	1 7/32	31.0	PT434	5 7/32	132.6	4	101.6	1 15/32	37.3	PT8487
4 13/16	122.2	2 5/8	66.7	1 7/32	31.0	PT434-10	5 7/32	132.6	4	101.6	1 15/32	37.3	PT9344
4 13/16	122.2	2 5/8	66.7	1 7/32	31.0	PT477	5 1/4	133.4	3 23/32	94.5	21/32	16.7	P67
4 13/16	122.2	2 7/8	73.0	1 1/16	27.0	PF943	5 1/4	133.4	4	101.6	1 5/16	33.3	JC405
4 13/16	122.2	3 15/16	100.0	23/32	18.3	P80	5 1/4	133.4	5 23/32	145.3	3 13/16	96.8	PT9476-MPG
4 13/16	122.2	3 15/16	100.0	23/32	18.3	P80-HD	5 9/32	134.1	1 25/32	45.2	23/32	18.3	PT8485
4 13/16	122.2	3 15/16	100.0	23/32	18.3	PF821-S	5 9/32	134.1	2 3/8	60.3	1 7/16	36.5	PT9293-MPG
4 13/16	122.2	5	127.0	2 13/16	71.4	PT578	5 9/32	134.1	2 3/4	69.9	1 31/32	50.0	PT9135
4 27/32	123.0	3 5/16	84.1	15/16	23.8	P184	5 9/32	134.1	3 1/8	79.4	-	-	BF46078-D
4 7/8	123.8	2 1/16	52.4	13/32	10.3	PF7595	5 9/32	134.1	3 3/16	81.0	5/8	15.9	BF9835-D
4 7/8	123.8	2 19/32	65.9	3/4	19.1	P7517	5 9/32	134.1	3 7/32	81.8	1/2	12.7	BF9822-D
4 7/8	123.8	3	76.2	-	-	PF10							



WARNING: These products can expose you to chemicals, including Diisononyl Phthalate, Carbon black extracts, Nickel, 1,3 Butadiene, Ethylene Oxide, Epichlorohydrin, which are known to the State of California to cause cancer, and Bisphenol-A, Ethylene Glycol, Ethylene Oxide, 1,3 Butadiene, Epichlorohydrin, which are known to the State of California to cause birth defects or other reproductive harm. For more information go to www.P65Warnings.ca.gov.

LIQUID ELEMENTS BY LENGTH

LENGTH Inches	LENGTH (mm)	O.D. Inches	O.D. (mm)	I.D. Inches	I.D. (mm)	BALDWIN NUMBER	LENGTH Inches	LENGTH (mm)	O.D. Inches	O.D. (mm)	I.D. Inches	I.D. (mm)	BALDWIN NUMBER
5 9/32	134.1	3 7/32	81.8	1/2	12.7	BF9828-D	5 9/16	141.3	2 25/32	70.6	5/8	16.0	P7415
5 9/32	134.1	3 7/32	81.8	7/8	22.2	BF9830-D	5 9/16	141.3	2 7/8	73.0	7/16	11.1	PF950
5 9/32	134.1	3 9/16	90.5	1 15/32	37.3	BF7821	5 9/16	141.3	2 7/8	73.0	1 5/16	33.3	P174
5 9/32	134.1	3 21/32	92.9	1 5/8	41.3	P5092	5 9/16	141.3	3 5/32	80.1	1 15/32	37.3	PT23289-MPG
5 9/32	134.1	4 29/32	124.6	1 9/16	39.7	PF46004	5 9/16	141.3	3 1/4	82.5	1 7/8	47.6	PT23002
5 5/16	134.9	1 13/16	46.0	13/16	20.6	PT23143	5 9/16	141.3	3 5/16	84.1	2	50.8	PT23204-MPG
5 5/16	134.9	2 11/32	59.5	1 5/32	29.4	PT9127	5 9/16	141.3	3 19/32	91.3	9/16	14.3	PF7583
5 5/16	134.9	2 11/32	59.5	1 13/32	35.7	PT23332	5 9/16	141.3	3 15/16	100.0	1 19/32	40.5	PT185
5 5/16	134.9	2 3/8	60.3	1	25.4	PT8887	5 9/16	141.3	4 1/8	104.8	3 11/32	84.9	PT9257
5 5/16	134.9	2 3/8	60.3	1	25.4	PT9203	5 19/32	142.1	7/8	22.2	9/16	14.3	PF46119
5 5/16	134.9	2 3/8	60.3	1 1/32	26.2	PT9309-MPG	5 19/32	142.1	2 7/8	73.0	1 3/16	30.2	PT546
5 5/16	134.9	2 3/8	60.3	1 13/32	35.7	PT23512-MPG	4 19/32	142.1	3	76.2	13/16	20.6	PF46056
5 5/16	134.9	2 3/8	60.3	1 13/32	35.7	PT23513-MPG	5 19/32	142.1	3 1/4	82.6	1 1/2	38.1	PF9872
5 5/16	134.9	3 5/32	80.2	15/16	23.8	BF9874-DM	5 19/32	142.1	3 19/32	91.3	9/16	14.3	PF7554
5 5/16	134.9	3 5/32	80.2	15/16	23.8	BF9875-DM	5 5/8	142.9	2 9/16	65.1	1 3/32	27.8	PT396
5 5/16	134.9	5 29/32	150.0	3 13/32	86.5	PT9352	5 5/8	142.9	2 7/8	73.0	1 1/16	27.0	PT8350
5 11/32	135.7	1 17/32	38.9	9/16	14.3	PF7872	5 5/8	142.9	3	76.2	1 1/16	27.0	PF916
5 11/32	135.7	2 3/8	60.3	1 13/32	35.7	PT8974-MPG	5 5/8	142.9	3	76.2	1 1/16	27.0	PF967
5 11/32	135.7	2 3/4	69.9	1 3/32	27.8	PT9167	5 5/8	142.9	3 3/16	81.0	1/2	12.7	F950-F WO
5 11/32	135.7	2 3/4	69.9	1 3/32	27.8	PT9174	5 5/8	142.9	3 3/16	81.0	1 7/8	47.6	PT23040-MPG
5 11/32	135.7	3 9/32	83.3	1 3/8	34.9	P40020	5 5/8	142.9	3 1/4	82.6	17/32	13.5	F950-F
5 11/32	135.7	3 15/32	88.1	31/32	24.6	PT71	5 5/8	142.9	3 1/4	82.6	1 7/8	47.6	PT23160
5 11/32	135.7	3 11/16	93.7	19/32	15.1	PF9900	5 5/8	142.9	3 7/16	87.3	19/32	15.1	PF963
5 11/32	135.7	5 1/2	139.7	2 1/16	52.4	PT23147	5 5/8	142.9	5 23/32	145.3	2 7/16	61.9	P7380
5 3/8	136.5	1 3/4	44.5	3/4	19.1	PT23202-MPG	5 21/32	143.7	2 7/8	73.0	1 13/32	35.7	PT8956-MPG
5 3/8	136.5	2 1/4	57.2	1 1/16	27.0	PT9136	5 21/32	143.7	3	76.2	1 1/16	27.0	PT480
5 3/8	136.5	2 13/16	71.4	1 5/16	33.3	PT23102-MPG	5 21/32	143.7	3	76.2	1 1/16	27.0	PT480-10
5 3/8	136.5	3 9/32	83.3	13/16	20.6	P7011	5 21/32	143.7	3	76.2	1 1/16	27.0	PT480-MPG
5 3/8	136.5	3 17/32	89.7	3/4	19.1	PF9899	5 21/32	143.7	3 17/32	89.7	1 5/16	33.3	P18
5 3/8	136.5	3 19/32	91.3	9/16	14.3	PF7592	5 21/32	143.7	3 17/32	89.7	1 5/16	33.3	P18-HD
5 3/8	136.5	3 7/8	98.4	1 1/4	31.8	BC40009	5 11/16	144.5	3 9/32	83.3	1 5/8	41.3	P266
5 13/32	137.3	1 15/16	49.2	27/32	21.4	P40033	5 11/16	144.5	3 7/16	87.3	1 3/16	30.2	PT549
5 13/32	137.3	2	50.8	1 15/32	37.3	PF7825	5 11/16	144.5	3 3/4	95.3	13/16	20.6	PF7779
5 13/32	137.3	2 1/16	52.4	7/8	22.2	P7492	5 23/32	145.3	3 7/16	87.3	1/2	12.7	PF804
5 13/32	137.3	2 13/16	71.4	1 5/16	33.3	P170	5 23/32	145.3	3 15/16	100.0	1 15/32	37.3	P104
5 13/32	137.3	3 1/8	79.4	3/4	19.1	BF46040-D	5 23/32	145.3	5 1/8	130.1	2 17/32	64.2	PT23469
5 13/32	137.3	3 11/16	93.7	1 31/32	50.0	P7265	5 3/4	146.1	2 7/8	73.0	1	25.4	F916-C
5 13/32	137.3	5 29/32	150.0	3 15/32	88.1	PT9130	5 3/4	146.1	3 1/2	88.9	1 5/32	29.4	BF7954-D
5 7/16	138.1	2 17/32	64.3	-	-	PT9225	5 3/4	146.1	4 7/16	112.7	1 17/32	38.9	PT11
5 7/16	138.1	3 3/32	78.6	1 5/8	41.3	P7083	5 3/4	146.1	4 7/16	112.7	1 17/32	38.9	PT11-HD
5 7/16	138.1	3 9/32	83.3	1/2	12.7	PF7978	5 25/32	146.8	3 9/32	83.3	1 5/8	41.3	P7050
5 7/16	138.1	3 17/32	89.7	17/32	13.5	PF9824	5 25/32	146.8	4 3/4	120.7	2 1/16	52.4	P7233
5 15/32	138.9	2 9/16	65.1	3/4	19.0	BF1201	5 13/16	147.6	2 1/2	63.5	1 3/8	35.0	PT23175
5 15/32	138.9	2 7/8	73.0	1 5/16	33.3	P280	5 13/16	147.6	2 17/32	64.3	1 1/16	27.0	PT9165
5 15/32	138.9	2 7/8	73.0	1 11/32	34.1	PT8355	5 13/16	147.6	2 15/16	74.6	1	25.4	P40025
5 15/32	138.9	3 3/8	85.7	-	-	PT9278	5 13/16	147.6	3 11/16	93.7	1/4	6.4	BC7326
5 15/32	138.9	3 13/32	86.5	2 9/16	65.0	PT23328	5 13/16	147.6	3 11/16	93.7	1/4	6.4	BC7485
5 15/32	138.9	3 13/32	86.5	2 9/16	65.0	PT23334	5 27/32	148.4	2 7/8	73.0	-	-	PT23474
5 15/32	138.9	3 5/8	92.1	23/32	18.3	P7081	5 27/32	148.4	2 7/8	73.0	9/16	14.3	PF231
5 15/32	138.9	3 23/32	94.5	1 1/32	26.2	PF7982	5 27/32	148.4	3 3/16	81.0	1/2	12.7	PF9865
5 15/32	138.9	4 9/16	115.9	2 7/32	56.4	PT508-MPG	5 27/32	148.4	4 3/4	120.7	2 7/32	56.4	P7190
5 15/32	138.9	4 9/16	115.9	2 7/32	56.4	PT8318-MPG	5 7/8	149.2	13/16	20.6	1 13/16	46.0	PT23038-MPG
5 15/32	138.9	7 7/8	200.0	4 15/32	113.5	PT9401	5 7/8	149.2	2 3/32	53.1	1/16	1.5	PT23311
5 1/2	139.7	2 3/4	69.9	1	25.4	PT9329	5 7/8	149.2	2 17/32	64.3	1 7/32	31.0	PT9417
5 1/2	139.7	2 27/32	72.2	1 1/32	26.2	PF46049	5 7/8	149.2	2 13/16	71.4	1 13/16	46.0	PT23196-MPG
5 1/2	139.7	2 7/8	73.0	1 5/16	33.3	PF831	5 7/8	149.2	2 27/32	72.2	1 3/4	44.5	PT9186
5 1/2	139.7	3 1/16	77.8	1 19/32	40.5	PT9486-MPG	5 7/8	149.2	3	76.2	1	25.4	PT23071-MPG
5 1/2	139.7	3 1/4	82.6	1 5/8	41.3	PT23016	5 7/8	149.2	3 23/32	94.5	25/32	19.8	P68
5 1/2	139.7	3 19/32	91.3	9/16	14.3	PF332	5 7/8	149.2	4 11/32	110.3	2 1/4	57.2	P7232
5 1/2	139.7	4 1/8	104.8	1 13/16	46.0	CU406	5 7/8	149.2	5 1/16	128.6	2 11/32	59.5	P7092
5 1/2	139.7	4 3/16	106.3	2 13/16	71.4	PT23344-MPG	5 29/32	150.0	1 31/32	50.0	27/32	21.4	PT8319
5 1/2	139.7	4 3/16	106.3	2 7/8	73.0	PT23148	5 29/32	150.0	2 27/32	72.2	1 25/32	45.2	PT8986-MPG
5 1/2	139.7	4 3/8	111.1	1	25.4	PF7553	5 29/32	150.0	2 27/32	72.2	1 25/32	45.2	PT9145
5 1/2	139.7	4 9/16	115.9	2 1/4	57.2	PT87-S	5 29/32	150.0	2 27/32	72.2	1 25/32	45.2	PT9514
5 17/32	140.5	2 19/32	65.9	1 5/16	33.3	PT9163	5 29/32	150.0	2 27/32	72.2	2 1/32	51.6	PT8963-MPG
5 17/32	140.5	2 13/16	71.4	1 5/16	33.3	PT29	5 29/32	150.0	2 31/32	75.4	-	-	PT23464
5 17/32	140.5	3	76.2	1 13/16	46.0	PT9260	5 29/32	150.0	3 1/2	88.9	1 15/32	37.3	PT61-HD
5 17/32	140.5	4 7/32	107.2	1 9/16	39.7	PF9870	5 29/32	150.0	3 27/32	89.7	1 3/16	30.2	PF1392
5 9/16	141.3	1 31/32	50.0	29/32	23.0	PT416	5 29/32	150.0	3 15/16	100.0	19/32	15.1	P7013



WARNING: These products can expose you to chemicals, including Diisononyl Phthalate, Carbon black extracts, Nickel, 1,3 Butadiene, Ethylene Oxide, Epichlorohydrin, which are known to the State of California to cause cancer, and Bisphenol-A, Ethylene Glycol, Ethylene Oxide, 1,3 Butadiene, Epichlorohydrin, which are known to the State of California to cause birth defects or other reproductive harm. For more information go to www.P65Warnings.ca.gov.

LIQUID ELEMENTS BY LENGTH

LENGTH Inches	LENGTH (mm)	O.D. Inches	O.D. (mm)	I.D. Inches	I.D. (mm)	BALDWIN NUMBER	LENGTH Inches	LENGTH (mm)	O.D. Inches	O.D. (mm)	I.D. Inches	I.D. (mm)	BALDWIN NUMBER
5 1/16	150.8	3 7/32	81.8	1 17/32	38.9	PT9415-MPG KIT	6 1/4	158.8	3 29/32	99.2	2 1/16	52.3	PT23316
5 1/16	150.8	3 9/32	83.3	1 9/16	39.7	P7199	6 1/4	158.8	3 15/16	100.0	1 1/16	27.0	P25
5 1/16	150.8	3 11/32	84.9	1 9/16	39.7	P7423	6 1/4	158.8	3 15/16	100.0	1 1/16	27.0	PF826
5 1/16	150.8	3 15/16	100.0	1 1/16	27.0	P82	6 1/4	158.8	3 15/16	100.0	2		PT23118-MPG
5 1/16	150.8	3 15/16	100.0	1 1/16	27.0	PT82-HD	6 1/4	158.8	4 1/32	102.3	2 29/32	73.8	PT23336
5 1/16	150.8	3 15/16	100.0	1 1/16	27.0	PT82-HD10	6 1/4	158.8	4 17/32	115.1	7/8	22.2	PT152
5 1/16	150.8	5 29/32	150.0	-	-	PT9277	6 9/32	159.5	2 1/32	51.5	15/16	23.8	PT23375-MPG
5 31/32	151.6	3 7/32	81.8	1 1/16	27.0	P7607	6 9/32	159.5	2 7/16	61.9	27/32	21.4	P1419
5 31/32	151.6	3 9/32	83.3	21/32	16.7	BF7672-D	6 9/32	159.5	2 7/8	73.0	1 11/32	34.1	PT8354
5 31/32	151.6	3 9/32	83.3	21/32	16.7	BF7674-D	6 5/16	160.3	2	50.8	15/16	23.8	H9327
5 31/32	151.6	3 9/32	83.3	21/32	16.7	BF7679-D	6 5/16	160.3	2 9/32	57.9	1 9/32	32.5	PT23008
5 31/32	151.6	3 9/32	83.3	21/32	16.7	BF7784-D	6 5/16	160.3	3 1/2	88.9	1 15/16	49.2	PT23045-MPG
5 31/32	151.6	3 9/32	83.3	21/32	16.7	BF7905-D	6 5/16	160.3	3 17/32	89.7	-	-	PT9448
5 31/32	151.6	3 9/32	83.3	21/32	16.7	BF7906-D	6 11/32	161.1	3 1/2	88.9	5/8	15.9	BF7522
5 31/32	151.6	3 15/16	100.0	1 1/16	26.9	PF822	6 11/32	161.1	3 27/32	97.6	2 17/32	64.2	PT23399-MPG
6	152.4	1 13/16	46.0	13/16	20.6	PT23043-MPG	6 11/32	161.1	4 1/4	108.0	31/32	24.6	PF46003
6	152.4	1 31/32	50.0	29/32	23.0	PT8451-MPG	6 3/8	161.9	2	50.8	13/16	20.6	PT23039-MPG
6	152.4	2 5/16	58.7	1 11/32	34.1	PT435	6 3/8	161.9	3 1/4	82.6	1 9/16	39.7	P7137
6	152.4	2 7/8	73.0	1 5/16	33.3	P177	6 3/8	161.9	3 17/32	89.6	1 29/32	48.4	PT23372-MPG
6	152.4	3 1/32	77.0	23/32	18.3	PF883	6 3/8	161.9	3 9/16	90.4	1 29/32	48.4	PT9492-MPG
6	152.4	3 1/2	88.9	1 5/32	29.4	BF7952-D	6 3/8	161.9	3 9/16	90.4	1 29/32	48.4	PT23363-MPG
6	152.4	3 21/32	92.9	1 11/32	34.1	P356	6 3/8	161.9	3 9/16	90.4	1 29/32	48.4	PT23370-MPG
6	152.4	5 1/8	130.2	2	50.8	PT23003	6 3/8	161.9	3 23/32	94.5	1 7/8	47.6	PF7938
6	152.4	5 1/8	130.2	3 3/8	85.7	PT89	6 3/8	161.9	3 15/16	100.0	1 5/8	41.3	PT153
6	152.4	5 3/16	131.7	2	50.8	PT23188	6 13/32	162.7	3 5/16	84.1	1 1/2	38.1	PT23560
6	152.4	6 1/2	165.1	3 1/2	88.9	PT462	6 13/32	162.7	3 23/32	94.5	1 1/32	26.2	PF7983
6 1/32	153.2	1 27/32	46.8	13/16	20.6	PT8954-MPG	6 13/32	162.7	3 23/32	94.5	1 1/32	26.2	PF9868
6 1/32	153.2	1 27/32	46.8	7/8	22.2	PT9512	6 13/32	162.7	4 21/32	118.3	2 11/32	59.5	PT8947-MPG
6 1/32	153.1	1 27/32	46.8	7/8	22.2	PT23128-MPG	6 7/16	163.5	3 3/4	95.3	1 25/32	43.7	PF46046
6 1/32	153.2	1 27/32	46.8	7/8	22.2	PT23132-MPG	6 7/16	163.5	4 11/32	110.3	21/32	16.7	PF7733
6 1/32	153.1	1 27/32	46.8	7/8	22.2	PT23369-MPG	6 7/16	163.5	5 29/32	150.0	3 1/2	88.9	PT23455
6 1/32	153.1	1 27/32	46.8	7/8	22.2	PT23371-MPG	6 15/32	164.3	3 1/32	77.0	1 1/4	31.8	PT377
6 1/32	153.2	1 7/8	47.6	13/16	20.6	PT9330-MPG	6 15/32	164.3	3 1/32	77.0	1 1/4	31.8	PT377-10
6 1/32	153.2	2 17/32	64.3	21/32	16.7	P7308	6 15/32	164.3	4 23/32	119.9	21/32	16.7	PF7749
6 1/32	153.2	2 25/32	70.6	27/32	21.4	P1418	6 15/32	164.3	5 1/32	127.8	2 15/32	62.7	P7059
6 1/32	153.2	3 3/8	85.7	11/16	17.5	BF7904-D	6 1/2	165.1	2	50.8	1 5/8	41.3	S479
6 1/32	153.2	3 1/2	89.0	1 5/8	41.3	P40017	6 1/2	165.1	3 9/32	83.3	1 19/32	40.5	PT63-1
6 1/16	154.0	3 3/16	81.0	1/2	12.7	BF9808-D	6 1/2	165.1	3 5/16	84.1	1 1/16	27.0	PF823
6 1/16	154.0	3 3/16	81.0	1/2	12.7	BF9847-D	6 1/2	165.1	3 5/16	84.1	1 1/16	27.0	PF823-E
6 1/16	154.0	3 3/16	81.0	9/16	14.3	BF9892-D	6 1/2	165.1	3 5/16	84.1	1 1/16	27.0	PF824
6 1/16	154.0	3 7/32	81.8	7/8	22.2	BF9833-D	6 1/2	165.1	3 5/16	84.1	1 1/16	27.0	PF829(2)
6 1/16	154.0	3 25/32	96.0	1 23/32	43.7	P7104	6 1/2	165.1	3 15/16	100.0	2 1/4	57.2	P723
6 1/16	154.0	3 15/16	100.0	1 1/16	27.0	PT138-10	6 1/2	165.1	4 11/32	110.3	21/32	16.7	PF7718
6 1/16	154.0	3 15/16	100.0	1 1/16	27.0	PT138-25	6 1/2	165.1	4 11/32	110.3	21/32	16.7	PF7734
6 1/16	154.0	5 7/8	149.2	2 15/16	74.6	PT9245	6 17/32	165.9	3 9/16	90.5	-	-	PT8419
6 3/32	154.8	2 3/32	53.2	1 3/32	27.8	PT9378-MPG	6 9/16	166.7	1 25/32	43.7	29/32	23.0	PT23570-MPG
6 3/32	154.8	2 9/16	65.1	1 1/4	31.8	P7414	6 9/16	166.7	2 9/16	65.1	31/32	24.6	P40023
6 3/32	154.8	3 15/16	100.0	7/8	22.2	P40012	6 9/16	166.7	3 3/16	81.0	-	-	PT23123
6 3/32	154.8	4 1/32	102.3	2 11/32	59.5	PT23330	6 9/16	166.7	3 17/32	89.7	-	-	PT9196
6 1/8	155.6	3 1/8	79.4	7/8	22.2	BF46045-D	6 9/16	166.7	3 17/32	89.7	-	-	PT23586
6 1/8	155.6	3 3/4	95.3	1 5/16	33.3	PT8345	6 19/32	167.5	4 21/32	118.3	2 11/32	59.5	PT8939-MPG
6 1/8	155.6	5	127.0	2 13/16	71.4	PT268	6 19/32	167.5	4 21/32	118.3	2 3/8	60.3	PT9246
6 1/8	155.6	5	127.0	2 13/16	71.4	PT392	6 5/8	168.3	2 7/8	73.0	9/16	14.3	P150
6 1/8	155.6	5	127.0	2 13/16	71.4	PT514	6 5/8	168.3	3 19/32	91.3	9/16	14.3	PF7556
6 5/32	156.4	1 9/16	39.7	5/16	7.9	PF7876	6 5/8	168.3	3 19/32	91.3	21/32	16.7	PT8356
6 5/32	156.4	1 31/32	50.0	7/8	22.2	P9600	6 5/8	168.3	3 15/16	100.0	23/32	18.3	PF594
6 5/32	156.4	2 13/16	71.4	1 5/16	33.3	P1565	6 5/8	168.3	4 1/2	114.3	1 1/16	27.0	P276
6 3/16	157.2	2 19/32	65.9	7/16	11.0	P40021	6 21/32	169.1	1 3/4	44.5	13/16	20.6	PT23568-MPG
6 3/16	157.2	3 1/16	77.8	1 19/32	40.5	PT23110-MPG	6 21/32	169.1	2 7/32	56.4	15/16	23.8	PT9304-MPG
6 3/16	157.2	5	127.0	2 13/16	71.4	PT383	6 21/32	169.1	4 5/8	117.5	2 5/16	58.7	PT7616
6 7/32	158.0	2 7/8	73.0	1 13/32	35.7	PT9215	6 11/16	169.9	1 21/32	42.0	1 1/32	26.1	PT23460
6 7/32	158.0	3 15/16	100.0	7/8	22.2	PF819	6 11/16	169.9	2 7/32	56.3	1	25.4	PT9493-MPG
6 7/32	158.0	3 15/16	100.0	7/8	22.2	PF819-HD	6 11/16	169.9	2 7/32	56.3	1	25.4	PT23358-MPG
6 7/32	158.0	3 15/16	100.0	7/8	22.2	PF899	6 11/16	169.9	3 1/16	77.8	1 9/16	39.7	PT9307-MPG
6 7/32	158.0	5 1/2	139.7	1 3/16	30.2	P7642	6 11/16	169.9	3 9/32	83.3	1 9/16	39.7	P7235
6 1/4	158.8	2 1/8	54.0	1 1/8	28.6	PT23115-MPG	6 11/16	169.9	3 9/16	90.5	31/32	24.6	PF615
6 1/4	158.8	3 1/2	88.9	1 1/4	31.8	P19	6 23/32	170.7	1 23/32	47.7	27/32	21.4	PT9143
6 1/4	158.8	3 1/2	88.9	1 15/16	49.2	PT23046-MPG	6 23/32	170.7	3 3/16	81.0	3/4	19.1	BF9839-D
							6 23/32	170.7	3 23/32	94.5	1/2	12.7	P54



WARNING: These products can expose you to chemicals, including Diisononyl Phthalate, Carbon black extracts, Nickel, 1,3 Butadiene, Ethylene Oxide, Epichlorohydrin, which are known to the State of California to cause cancer, and Bisphenol-A, Ethylene Glycol, Ethylene Oxide, 1,3 Butadiene, Epichlorohydrin, which are known to the State of California to cause birth defects or other reproductive harm. For more information go to www.P65Warnings.ca.gov.

LIQUID ELEMENTS BY LENGTH

LENGTH Inches	LENGTH (mm)	O.D. Inches	O.D. (mm)	I.D. Inches	I.D. (mm)	BALDWIN NUMBER	LENGTH Inches	LENGTH (mm)	O.D. Inches	O.D. (mm)	I.D. Inches	I.D. (mm)	BALDWIN NUMBER
6 23/32.....	170.7	3 25/32.....	96.0	2 11/16.....	68.3	PT8883	7 1/16.....	179.4	4 1/4.....	108.0	1 15/16.....	49.2	P7084
6 23/32.....	170.7	4 5/32.....	105.6	3/4.....	19.1	F594-F	7 1/16.....	179.4	4 17/32.....	115.1	1 25/32.....	45.2	PT154
6 23/32.....	170.7	5 1/16.....	128.6	19/32.....	15.1	P7093	7 1/16.....	179.4	4 17/32.....	115.1	2 9/32.....	57.9	P204
6 3/4.....	171.5	1 3/4.....	44.5	13/16.....	20.6	PT23095-MPG	7 1/16.....	179.4	4 17/32.....	115.1	2 9/32.....	57.9	P204-HD
6 3/4.....	171.5	1 27/32.....	46.8	1.....	25.4	PT9296-MPG	7 1/16.....	179.4	4 17/32.....	115.1	2 9/32.....	57.9	P204-HD10
6 3/4.....	171.5	1 27/32.....	46.8	1.....	25.4	PT9267	7 1/16.....	179.4	4 17/32.....	115.1	2 9/32.....	57.9	PT560 KIT
6 3/4.....	171.5	3 5/16.....	84.1	1 1/4.....	31.8	P60	7 3/32.....	180.1	2 9/32.....	57.9	1 9/32.....	32.5	PT23321
6 3/4.....	171.5	3 15/32.....	88.1	1.....	25.4	PF226	7 3/32.....	180.2	2 9/32.....	57.9	1 9/32.....	32.5	PT23388-MPG
6 3/4.....	171.5	4 5/32.....	105.6	1 7/8.....	47.6	P7106	7 3/32.....	180.2	2 15/16.....	74.6	1 1/4.....	31.8	PT9535-MPG
6 3/4.....	171.5	4 7/32.....	107.2	1.....	25.4	PF225	7 3/32.....	180.2	3 23/32.....	94.5	1 29/32.....	48.4	PT23493-MPG
6 25/32.....	172.2	1 27/32.....	46.8	1.....	25.4	PT9266	7 3/32.....	180.2	7 5/8.....	193.7	4 21/32.....	118.3	P7007
6 25/32.....	172.2	1 27/32.....	46.8	1.....	25.4	PT23021	7 1/8.....	181.0	2 9/32.....	57.9	1 7/32.....	31.0	PT9200
6 25/32.....	172.2	3 9/32.....	83.3	21/32.....	16.7	BF7964-D	7 1/8.....	181.0	4 3/8.....	111.1	31/32.....	24.6	PF9826
6 25/32.....	172.2	3 9/32.....	83.3	21/32.....	16.7	BF7989-D	7 1/8.....	181.0	4 1/2.....	114.3	1 25/32.....	45.2	PT433
6 25/32.....	172.2	3 9/32.....	83.3	21/32.....	16.7	BF9837-D	7 1/8.....	181.0	4 1/2.....	114.3	2 9/32.....	57.9	PT380 KIT
6 13/16.....	173.0	2 11/16.....	68.2	1 5/16.....	33.3	PT23028-MPG	7 5/32.....	181.8	3 9/32.....	83.3	-.....	-.....	BF46038-D
6 13/16.....	173.0	2 23/32.....	69.1	1 11/32.....	31.4	PT9490-MPG	7 5/32.....	181.8	4 1/2.....	114.3	2 1/4.....	57.2	PT509-MPG KIT
6 13/16.....	173.0	2 23/32.....	69.0	1 11/32.....	34.1	PT23361-MPG	7 3/16.....	182.6	3 5/8.....	92.1	1 1/16.....	27.0	V738-O
6 13/16.....	173.0	2 23/32.....	69.0	1 11/32.....	34.1	PT23430-MPG	7 3/16.....	182.6	3 7/8.....	98.4	1 1/2.....	38.1	PT23141
6 13/16.....	173.0	2 3/4.....	69.8	1.....	25.4	PT23129-MPG	7 3/16.....	182.6	3 15/16.....	100.0	1 3/4.....	44.5	P7484
6 13/16.....	173.0	2 3/4.....	69.8	1 5/32.....	29.3	PT23465	7 3/16.....	182.6	4 1/2.....	114.3	2 9/32.....	57.9	PT8339
6 13/16.....	173.0	2 7/8.....	73.0	27/32.....	21.4	PF882	7 7/32.....	183.4	3 11/32.....	84.9	1 3/8.....	34.9	PF7896
6 13/16.....	173.0	2 29/32.....	73.8	2 23/32.....	69.1	PT9491-MPG	7 7/32.....	183.4	3 13/32.....	86.5	1 1/2.....	38.1	PF7936
6 13/16.....	173.0	3 7/32.....	81.8	7/8.....	22.2	BF9827-D	7 7/32.....	183.4	4 3/16.....	106.4	-.....	-.....	PT23124
6 13/16.....	173.0	3 23/32.....	94.4	1 11/32.....	8.7	PT23365-MPG	7 1/4.....	184.2	3 15/16.....	100.0	27/32.....	21.4	PT72
6 27/32.....	173.8	2 3/16.....	55.6	1 1/16.....	27.0	PT9282-MPG	7 1/4.....	184.2	4 1/2.....	114.3	2 1/4.....	57.2	PT426
6 27/32.....	173.8	2 23/32.....	69.1	1 9/32.....	32.5	PT8959-MPG	7 1/4.....	184.2	4 1/2.....	114.3	2 1/4.....	57.2	PT498
6 27/32.....	173.8	3 23/32.....	94.5	1 3/4.....	44.5	PF7986	7 1/4.....	184.2	4 1/2.....	114.3	2 1/4.....	57.2	PT498-10
6 27/32.....	173.8	3 3/4.....	95.3	1 13/16.....	46.0	PF7935	7 9/32.....	184.9	3 1/16.....	77.8	1 11/16.....	42.9	C740-S
6 7/8.....	174.6	3 5/32.....	80.2	27/32.....	21.4	CA0005	7 9/32.....	184.9	3 15/16.....	100.0	1 15/16.....	49.2	PT7053
6 7/8.....	174.6	5 29/32.....	150.0	2 13/16.....	71.4	P1563	7 5/16.....	185.7	2 5/8.....	66.7	1 1/4.....	31.8	PT289
6 29/32.....	175.4	2 23/32.....	69.1	1 5/32.....	29.4	PT8940-MPG	7 5/16.....	185.7	2 5/8.....	66.7	1 1/4.....	31.8	PT289-10
6 29/32.....	175.4	2 23/32.....	69.1	1 3/16.....	30.1	PT23499-MPG	7 5/16.....	185.7	2 5/8.....	66.7	1 1/4.....	31.8	PT290
6 29/32.....	175.4	3 3/4.....	95.3	21/32.....	16.7	PF7744	7 11/32.....	186.5	3 5/16.....	84.1	1 5/32.....	29.4	BF7949-DIM
6 29/32.....	175.4	3 29/32.....	99.2	1 19/32.....	40.5	PT23468	7 11/32.....	186.5	3 5/16.....	84.1	1 5/32.....	29.4	BF7971-DIM
6 29/32.....	175.4	3 29/32.....	99.2	1 19/32.....	40.5	PT23480	7 11/32.....	186.5	3 1/2.....	88.9	15/16.....	23.8	PT70
6 15/16.....	176.2	3 1/2.....	88.9	2.....	50.8	P198	7 3/8.....	187.3	1 13/16.....	46.0	13/16.....	20.6	PT23066-MPG
6 15/16.....	176.2	4.....	101.6	2 15/16.....	74.6	PT23183	7 3/8.....	187.3	1 13/16.....	46.0	1 1/8.....	28.6	PT23067-MPG
6 15/16.....	176.2	4.....	101.6	2 15/16.....	74.6	PT23184	7 3/8.....	187.3	2 11/32.....	59.5	1 3/16.....	30.2	PT9434
6 15/16.....	176.2	4 3/16.....	106.4	21/32.....	16.7	PF7930	7 3/8.....	187.3	3 1/2.....	88.9	1 5/32.....	29.4	BF7951-D
6 31/32.....	177.0	3 1/4.....	82.6	1 7/16.....	36.5	PT7196	7 3/8.....	187.3	4 3/16.....	106.4	2.....	50.8	PT7510
6 31/32.....	177.0	4 1/2.....	114.3	1 7/8.....	47.6	PT207	7 3/8.....	187.3	4 1/2.....	114.3	2 1/4.....	57.2	PT298-10
6 31/32.....	177.0	4 1/2.....	114.3	1 7/8.....	47.6	PT207-10	7 13/32.....	188.1	4 25/32.....	121.4	2 5/32.....	54.8	P242
6 31/32.....	177.0	4 1/2.....	114.3	1 7/8.....	47.6	PT207-HD	7 7/16.....	188.9	2 29/32.....	73.8	1.....	25.4	PT513
6 31/32.....	177.0	4 1/2.....	114.3	1 7/8.....	47.6	PT207-HD10	7 7/16.....	188.9	3 3/8.....	85.7	1 7/8.....	47.6	PT562-10
6 31/32.....	177.0	4 1/2.....	114.3	1 7/8.....	47.6	PT467-MPG	7 7/16.....	188.9	4 5/32.....	105.6	2 27/32.....	72.9	PT8982-MPG
6 31/32.....	177.0	5 1/8.....	130.2	3 3/8.....	85.7	PT9380-MPG	7 7/16.....	188.9	4 1/2.....	114.3	2 7/32.....	56.4	PT288-HD
7.....	177.8	1 3/8.....	34.9	13/16.....	20.6	PT23064-MPG	7 7/16.....	188.9	4 1/2.....	114.3	2 7/32.....	56.4	PT288-HD10
7.....	177.8	1 5/8.....	41.3	13/16.....	20.6	PT23077-MPG	7 15/32.....	189.7	4 5/32.....	105.6	2 13/16.....	71.4	PT9410-MPG
7.....	177.8	2 7/16.....	62.0	1 3/8.....	35.0	PT23326	7 1/2.....	190.5	2 11/16.....	68.3	1 5/16.....	33.3	PT23532-MPG
7.....	177.8	3 27/32.....	97.6	1/2.....	12.7	BC7242	7 1/2.....	190.5	2 7/8.....	73.0	1 1/8.....	28.6	PT445-MPG
7.....	177.8	3 27/32.....	97.6	1/2.....	12.7	BC7394	7 1/2.....	190.5	3 5/16.....	84.1	1 11/16.....	42.8	PT23149
7.....	177.8	3 27/32.....	97.6	5/8.....	15.9	BC7228	7 1/2.....	190.5	3 15/16.....	100.0	2.....	50.8	PT277
7.....	177.8	4 7/16.....	112.7	1 1/2.....	38.1	PT137	7 1/2.....	190.5	4 1/8.....	104.8	-.....	-.....	PF9928
7.....	177.8	4 1/2.....	114.3	1 29/32.....	48.4	PT373	7 1/2.....	190.5	4 1/8.....	104.8	-.....	-.....	PF9929
7.....	177.8	5 1/8.....	130.2	3 3/8.....	85.7	PT91	7 1/2.....	190.5	4 3/4.....	120.7	1 9/16.....	39.7	P998
7.....	177.8	5 1/8.....	130.2	3 3/8.....	85.7	PT9430-MPG	7 1/2.....	190.5	6 1/2.....	165.1	3 15/32.....	88.1	PT520
7 1/32.....	178.6	1 21/32.....	42.0	7/8.....	22.2	PT23524-MPG	7 17/32.....	191.3	3 3/32.....	78.6	-.....	-.....	PT9447
7 1/32.....	178.6	3 3/4.....	95.3	21/32.....	16.7	PF7680	7 17/32.....	191.3	3 23/32.....	94.5	1 1/32.....	26.2	PF312
7 1/32.....	178.6	3 3/4.....	95.3	21/32.....	16.7	PF7748	7 17/32.....	191.3	4 1/8.....	104.8	1 1/2.....	38.1	P7437
7 1/32.....	178.6	3 3/4.....	95.3	21/32.....	16.7	PF7755	7 9/16.....	192.1	3 15/16.....	100.0	1 23/32.....	43.7	PT7107
7 1/32.....	178.6	3 13/16.....	96.8	21/32.....	16.7	PF7894	7 9/16.....	192.1	4 5/32.....	105.6	2 27/32.....	72.2	PT9188
7 1/32.....	178.6	3 13/16.....	96.8	21/32.....	16.7	PF7895	7 9/16.....	192.1	4 5/16.....	109.5	3.....	76.2	PT23215-MPG
7 1/32.....	178.6	3 27/32.....	97.6	21/32.....	16.7	PF7782	7 19/32.....	192.9	1 27/32.....	46.8	7/8.....	22.2	PT23373-MPG
7 1/32.....	178.6	4 3/16.....	106.4	21/32.....	16.7	PF7928	7 19/32.....	192.9	1 27/32.....	46.8	7/8.....	22.2	PT23378-MPG
7 1/32.....	178.6	4 3/16.....	106.4	21/32.....	16.7	PF9814	7 19/32.....	192.9	2 7/8.....	73.0	1 1/16.....	27.0	PF942
7 1/32.....	178.6	4 7/32.....	107.2	21/32.....	16.7	PF46092	7 19/32.....	192.9	3 9/32.....	83.3	15/16.....	23.6	P7305
7 1/16.....	179.4	2 1/32.....	51.6	1 7/32.....	31.0	PT463	7 19/32.....	192.9	5 27/32.....	148.4	1 1/32.....	26.2	PF9804
							7 5/8.....	193.7	3 9/32.....	83.3	21/32.....	16.7	BF7677-D



WARNING: These products can expose you to chemicals, including Diisononyl Phthalate, Carbon black extracts, Nickel, 1,3 Butadiene, Ethylene Oxide, Epichlorohydrin, which are known to the State of California to cause cancer, and Bisphenol-A, Ethylene Glycol, Ethylene Oxide, 1,3 Butadiene, Epichlorohydrin, which are known to the State of California to cause birth defects or other reproductive harm. For more information go to www.P65Warnings.ca.gov.

LIQUID ELEMENTS BY LENGTH

LENGTH Inches	LENGTH (mm)	O.D. Inches	O.D. (mm)	I.D. Inches	I.D. (mm)	BALDWIN NUMBER	LENGTH Inches	LENGTH (mm)	O.D. Inches	O.D. (mm)	I.D. Inches	I.D. (mm)	BALDWIN NUMBER
7 5/8.....	193.7	3 9/32.....	83.3	21/32.....	16.7	BF7682-D	7 27/32.....	199.2	3 11/16.....	93.7	1 7/8.....	47.6	PT676
7 5/8.....	193.7	3 9/32.....	83.3	21/32.....	16.7	BF7746-D	7 27/32.....	199.2	3 11/16.....	93.7	1 29/32.....	48.4	PT8992-MPG
7 5/8.....	193.7	3 9/32.....	83.3	21/32.....	16.7	BF7785-D	7 27/32.....	199.2	3 15/16.....	100.0	1 1/8.....	28.6	P7021
7 5/8.....	193.7	3 9/32.....	83.3	21/32.....	16.7	BF7786-D	7 27/32.....	199.2	4 3/8.....	111.1	2 13/32.....	61.1	PT9413-MPG
7 5/8.....	193.7	3 9/32.....	83.3	21/32.....	16.7	BF7898-D	7 7/8.....	200.0	3 9/16.....	39.7	1 7/8.....	47.6	PT23079-MPG
7 5/8.....	193.7	3 5/16.....	84.1	1 5/32.....	29.4	BF7971-D	7 7/8.....	200.0	1 3/4.....	44.5	7/16.....	11.1	F919-C
7 5/8.....	193.7	3 15/32.....	88.1	31/32.....	24.6	P102	7 7/8.....	200.0	1 25/32.....	45.2	13/16.....	20.6	PT9198
7 5/8.....	193.7	3 23/32.....	94.5	1 13/16.....	46.0	PT9390-MPG	7 7/8.....	200.0	1 13/16.....	46.0	13/16.....	20.6	PT23006
7 5/8.....	193.7	3 23/32.....	94.5	1 27/32.....	46.8	PT9268	7 7/8.....	200.0	1 13/16.....	46.0	13/16.....	20.6	PT23007
7 5/8.....	193.7	3 3/4.....	95.3	1 1/16.....	27.0	PF9889	7 7/8.....	200.0	2 5/16.....	58.7	1 1/32.....	26.2	PT9197
7 5/8.....	193.7	4 11/32.....	110.3	3/4.....	19.1	P249	7 7/8.....	200.0	2 5/16.....	58.7	1 1/32.....	26.2	PT9285-MPG
7 5/8.....	193.7	4 23/32.....	119.9	2 3/32.....	52.9	P7494	7 7/8.....	200.0	2 5/16.....	58.7	1 1/32.....	26.2	PT9286-MPG
7 5/8.....	193.7	6 1/32.....	153.2	1 23/32.....	43.7	P194	7 7/8.....	200.0	2 3/8.....	60.3	1 1/2.....	38.1	PT23533
7 5/8.....	193.7	6 1/32.....	153.2	1 23/32.....	43.7	P194-HD	7 7/8.....	200.0	2 13/16.....	71.4	1 3/4.....	44.4	PT23327
7 5/8.....	193.7	6 1/32.....	153.2	1 23/32.....	43.7	P194-HD10	7 7/8.....	200.0	2 27/32.....	72.2	2 1/16.....	52.4	PT9187
7 5/8.....	193.7	6 1/32.....	153.2	1 23/32.....	43.7	PF194	7 7/8.....	200.0	2 7/8.....	73.0	1 15/16.....	49.2	PT23201-MPG
7 5/8.....	193.7	6 1/32.....	153.2	1 23/32.....	43.7	PT394-15	7 7/8.....	200.0	3.....	76.2	1 1/8.....	28.6	P40030
7 5/8.....	193.7	6 1/32.....	153.2	1 23/32.....	43.7	PT394-5	7 7/8.....	200.0	3 5/16.....	84.1	-.....	-.....	PT9224
7 21/32.....	194.5	3 1/2.....	88.9	1 5/32.....	29.4	BF7949-D	7 7/8.....	200.0	3 3/8.....	85.7	-.....	-.....	PT9279
7 21/32.....	194.5	3 1/2.....	88.9	1 5/32.....	29.4	BF7950-D	7 7/8.....	200.0	3 3/8.....	85.7	1 7/8.....	47.6	PT23061-MPG
7 11/16.....	195.3	2 3/4.....	69.9	1 5/8.....	41.3	PT23060-MPG	7 7/8.....	200.0	3 1/2.....	89.0	2 1/4.....	57.2	PT23230-MPG
7 11/16.....	195.3	3 3/16.....	81.0	9/16.....	14.3	BF9891-D	7 7/8.....	200.0	3 9/16.....	90.5	-.....	-.....	PT9238
7 11/16.....	195.3	3 5/16.....	84.1	2 7/16.....	62.0	PT23189	7 7/8.....	200.0	3 21/32.....	92.9	1 23/32.....	43.7	PT8344
7 11/16.....	195.3	4 1/32.....	102.3	-.....	-.....	PT23481	7 7/8.....	200.0	4 7/16.....	112.7	1 17/32.....	38.9	PT115
7 11/16.....	195.3	4 1/32.....	102.3	-.....	-.....	PT23482	7 7/8.....	200.0	4 3/4.....	120.7	2 1/16.....	52.4	P7329
7 11/16.....	195.3	4 1/8.....	104.8	1 1/2.....	38.1	P7436	7 7/8.....	200.0	4 13/16.....	122.2	-.....	-.....	PT716
7 11/16.....	195.3	4 1/2.....	114.3	2 1/4.....	57.2	P721	7 7/8.....	200.0	5 1/8.....	130.2	2 1/16.....	52.4	PT9507
7 23/32.....	196.1	3.....	76.2	1 1/16.....	27.0	PT265	7 7/8.....	200.0	5 1/8.....	130.2	2 9/16.....	65.1	PT9217
7 23/32.....	196.1	3.....	76.2	1 1/16.....	27.0	PF907	7 7/8.....	200.0	5 1/8.....	130.2	2 9/16.....	65.1	PT9272
7 23/32.....	196.1	5 29/32.....	150.0	3 7/16.....	87.3	PT23592	7 7/8.....	200.0	5 1/8.....	130.2	2 9/16.....	65.1	PT23048-MPG
7 3/4.....	196.9	1 3/4.....	44.5	3/4.....	19.1	PT23083-MPG	7 7/8.....	200.0	5 11/32.....	135.7	2 9/16.....	65.1	PT9183
7 3/4.....	196.9	3 1/8.....	79.4	1 1/16.....	27.0	VT842-O	7 7/8.....	200.0	5 1/2.....	139.7	2 5/8.....	66.7	PT457-MPG
7 3/4.....	196.9	3 1/8.....	85.7	2 1/8.....	54.0	PT23034-MPG	7 7/8.....	200.0	5 15/16.....	150.8	3 19/32.....	91.3	PT9351-MPG
7 3/4.....	196.9	3 15/32.....	88.1	3/4.....	19.1	BF46039-D	7 7/8.....	200.0	5 15/16.....	150.8	3 19/32.....	91.3	PT9411-MPG
7 3/4.....	196.9	3 19/32.....	91.3	1 29/32.....	48.4	PT9450-MPG	7 7/8.....	200.0	7.....	177.8	4 5/16.....	109.5	PT9518-MPG
7 3/4.....	196.9	3 15/16.....	100.0	1 19/32.....	40.5	P7035	7 7/8.....	200.0	7 3/32.....	180.1	4 5/32.....	105.5	PT23454
7 3/4.....	196.9	4 7/32.....	107.2	1/2.....	12.7	P42	7 29/32.....	200.8	2 3/4.....	69.9	1.....	25.4	PT9395-MPG
7 3/4.....	196.9	6 1/2.....	165.1	-.....	-.....	PT8334	7 29/32.....	200.8	2 27/32.....	72.2	1 25/32.....	45.2	PT8999-MPG
7 25/32.....	197.6	2 15/32.....	62.7	1 1/16.....	27.0	PT210	7 15/16.....	201.6	2 3/4.....	69.9	1 21/32.....	42.1	PT9248
7 25/32.....	197.6	3 1/8.....	79.4	15/16.....	23.8	BF46044-D	7 15/16.....	201.6	2 13/16.....	71.4	1 5/8.....	41.3	PT23567-MPG
7 25/32.....	197.6	3 3/16.....	81.0	13/16.....	20.6	BF9809-D	7 15/16.....	201.6	2 7/8.....	73.0	1 11/32.....	34.1	PT8351
7 25/32.....	197.6	3 3/16.....	81.0	13/16.....	20.6	BF9810-D	7 15/16.....	201.6	2 7/8.....	73.0	1 7/8.....	47.6	PT23391-MPG
7 25/32.....	197.6	3 1/4.....	82.6	1 19/32.....	40.5	PT9284-MPG	7 15/16.....	201.6	3 11/16.....	93.7	1 13/16.....	46.0	PT23080-MPG
7 25/32.....	197.6	3 9/32.....	83.3	1 9/16.....	39.7	PT9152	7 15/16.....	201.6	3 23/32.....	94.5	1 1/32.....	26.2	PF7984
7 25/32.....	197.6	3 29/32.....	99.2	2 9/16.....	65.0	PT23472	7 31/32.....	202.4	4 9/16.....	115.9	2 7/32.....	56.4	PT390-MPG
7 25/32.....	197.6	4 23/32.....	119.8	3 1/32.....	77.0	PT23473	7 31/32.....	202.4	4 9/16.....	115.9	2 7/32.....	56.4	PT391-MPG
7 25/32.....	197.6	6 1/2.....	165.1	1 19/32.....	40.5	P529	8.....	203.2	1 5/32.....	29.3	2.....	50.8	PT23217-MPG
7 13/16.....	198.4	1 9/16.....	39.7	5/16.....	7.9	PF7828	8.....	203.2	1 21/32.....	42.0	1 1/32.....	26.1	PT23495-MPG
7 13/16.....	198.4	1 3/4.....	44.5	3/4.....	19.1	PT23082-MPG	8.....	203.2	2 29/32.....	73.8	1 13/32.....	35.7	PT9300-MPG
7 13/16.....	198.4	1 25/32.....	45.2	25/32.....	19.8	PT9287-MPG	8.....	203.2	3 1/16.....	77.7	1 5/8.....	41.2	PT23296-MPG
7 13/16.....	198.4	2 3/16.....	55.6	1 25/32.....	45.2	PF46103	8.....	203.2	3 1/8.....	79.4	1 15/16.....	49.2	PT23407-MPG
7 13/16.....	198.4	3.....	76.2	1 1/16.....	27.0	PF810	8.....	203.2	3 9/32.....	83.3	1 5/8.....	41.2	PT23310
7 13/16.....	198.4	3.....	76.2	1 1/16.....	27.0	PF902-S	8.....	203.2	3 23/32.....	94.5	1 25/32.....	45.2	PF7761
7 13/16.....	198.4	3.....	76.2	1 1/16.....	27.0	PF910	8.....	203.2	3 7/32.....	94.5	1 25/32.....	45.2	PT9505-MPG
7 13/16.....	198.4	3 1/4.....	82.5	1 1/2.....	38.1	PT23146	8.....	203.2	3 3/4.....	95.3	2 9/16.....	65.1	PT522
7 13/16.....	198.4	3 15/32.....	88.1	7/8.....	22.2	BF46041-D	8.....	203.2	3 31/32.....	100.8	1 3/4.....	44.5	PF7767
7 13/16.....	198.4	3 17/32.....	89.7	1 5/16.....	33.3	P235	8.....	203.2	4 1/8.....	104.8	1 1/16.....	27.0	V852-O
7 13/16.....	198.4	3 3/4.....	95.3	1 31/32.....	50.0	PT567	8.....	203.2	4 7/32.....	107.2	1/2.....	12.7	P52
7 13/16.....	198.4	3 3/4.....	95.3	1 31/32.....	50.0	PT567-10	8.....	203.2	4 3/8.....	111.1	23/32.....	18.3	PT777
7 27/32.....	199.2	1 25/32.....	45.2	3/4.....	19.1	PT9210	8.....	203.2	4 3/8.....	111.1	2 1/32.....	51.6	PT8375-MPG
7 27/32.....	199.2	1 13/16.....	46.0	3/4.....	19.1	PT8946-MPG	8.....	203.2	4 3/8.....	111.1	2 7/16.....	61.9	PT760-10
7 27/32.....	199.2	2 5/16.....	58.7	1 1/16.....	27.0	PT9153	8.....	203.2	4 3/8.....	111.1	2 7/16.....	61.9	PT760-25
7 27/32.....	199.2	2 3/4.....	69.9	1 1/32.....	26.2	PT23308	8.....	203.2	6.....	152.4	3 17/32.....	89.7	PT191
7 27/32.....	199.2	2 3/4.....	69.9	1 1/4.....	31.8	PT9157	8.....	203.2	6.....	152.4	3 17/32.....	89.7	PT191-5
7 27/32.....	199.2	3 9/32.....	83.3	13/16.....	20.6	P7016	8.....	203.2	6.....	152.4	3 17/32.....	89.7	PT191-10
7 27/32.....	199.2	3 5/16.....	84.1	29/32.....	23.0	P7015	8 1/32.....	204.0	5 1/8.....	130.1	2 1/32.....	51.5	PT23496-MPG
7 27/32.....	199.2	3 19/32.....	91.3	1 29/32.....	48.4	PT8884-MPG	8 1/16.....	204.8	2 3/4.....	69.9	1 5/8.....	41.3	PT8948-MPG
7 27/32.....	199.2	3 11/16.....	93.5	1 29/32.....	48.4	PT23216-MPG	8 1/16.....	204.8	3 5/16.....	84.1	-.....	-.....	PT23178



WARNING: These products can expose you to chemicals, including Diisononyl Phthalate, Carbon black extracts, Nickel, 1,3 Butadiene, Ethylene Oxide, Epichlorohydrin, which are known to the State of California to cause cancer, and Bisphenol-A, Ethylene Glycol, Ethylene Oxide, 1,3 Butadiene, Epichlorohydrin, which are known to the State of California to cause birth defects or other reproductive harm. For more information go to www.P65Warnings.ca.gov.

LIQUID ELEMENTS BY LENGTH

LENGTH Inches	LENGTH (mm)	O.D. Inches	O.D. (mm)	I.D. Inches	I.D. (mm)	BALDWIN NUMBER	LENGTH Inches	LENGTH (mm)	O.D. Inches	O.D. (mm)	I.D. Inches	I.D. (mm)	BALDWIN NUMBER
8 1/16	204.8	3 3/8	85.7	1 15/16	49.2	PT23225-MPG	8 1/4	209.6	3 1/8	79.4	1 11/16	42.9	H9075
8 1/16	204.8	3 1/2	89.0	2 3/16	55.5	PT23161	8 1/4	209.6	3 1/8	79.4	1 11/16	42.9	H9075-V
8 1/16	204.8	3 1/2	89.0	2 3/16	55.5	PT23166	8 1/4	209.6	3 1/8	79.4	1 11/16	42.9	H9076
8 1/16	204.8	3 3/4	95.2	2 1/8	54.0	PT23283-MPG	8 1/4	209.6	3 5/32	80.2	1 11/16	42.9	H9092
8 1/16	204.8	3 29/32	99.2	1 5/8	41.3	PT23013	8 1/4	209.6	3 11/16	93.7	1 19/32	40.5	PT9342-MPG
8 1/16	204.8	3 29/32	99.2	1 5/8	41.3	PT23015	8 1/4	209.6	3 29/32	99.2	2 1/32	51.5	PT23456
8 1/16	204.8	4 3/8	111.1	2 7/16	61.9	PT761	8 1/4	209.6	4 17/32	115.1	1 1/16	17.5	PF846
8 1/16	204.8	4 3/8	111.1	2 7/16	61.9	PT776-MPG	8 1/4	209.6	4 31/32	126.2	3 5/8	92.0	PT23488-MPG
8 1/16	204.8	4 1/2	114.3	2 1/4	57.2	PT561	8 1/4	209.6	6	152.4	4 1/2	114.3	PT23405-MPG
8 3/32	205.5	3 17/32	89.7	2 1/2	63.5	PT23445-MPG	8 9/32	210.3	2 7/32	56.4	1 1/32	26.2	PT23576-MPG
8 3/32	205.5	3 25/32	96.0	2 7/32	56.3	PT23380-MPG	8 9/32	210.3	3 1/16	77.8	1 11/16	42.9	PT9207
8 3/32	205.5	3 25/32	96.0	2 7/32	56.3	PT23412-MPG	8 9/32	210.3	3 1/16	77.8	1 11/16	42.9	PT23131-MPG
8 3/32	205.5	3 25/32	96.0	2 7/32	56.3	PT23433-MPG	8 9/32	210.3	3 15/16	100.0	1 29/32	48.4	PT9501-MPG
8 3/32	205.5	4 17/32	115.1	2 1/4	57.2	PT442-MPG	8 9/32	210.3	4 11/32	110.3	2 1/32	51.6	PF7618
8 3/32	205.5	4 3/4	120.7	2	50.8	PT7508	8 9/32	210.3	4 31/32	126.2	3 5/8	92.0	PT682
8 1/8	206.4	2 1/16	52.3	1	25.4	PT23266-MPG	8 9/32	210.3	5 5/32	131.0	2 15/32	62.7	PT9176
8 1/8	206.4	2 1/8	54.0	15/16	23.8	PT23091-MPG	8 5/16	211.1	2 7/8	73.0	1 3/16	30.2	PF845
8 1/8	206.4	2 1/8	54.0	15/16	23.8	PT23092-MPG	8 5/16	211.1	3	76.2	1 13/16	46.0	PT23397-MPG
8 1/8	206.4	2 5/8	66.7	1 3/8	34.9	PT23035-MPG	8 5/16	211.1	3 29/32	99.2	2 1/16	52.4	PT9291-MPG
8 1/8	206.4	3 3/32	78.6	1 5/8	41.3	PT9144	8 5/16	211.1	3 15/16	100.0	2 11/32	59.5	PT516
8 1/8	206.4	3 7/32	81.8	1 7/16	36.5	PT8330-MPG	8 5/16	211.1	3 15/16	100.0	2 11/32	59.5	PT8507-MPG
8 1/8	206.4	4 3/8	111.1	2 7/16	61.9	PT9405	8 5/16	211.1	5 1/16	128.6	2 1/2	63.5	PT23099-MPG
8 1/8	206.4	5 15/16	150.8	4 1/2	114.3	PT23268-MPG	8 5/16	211.1	5 5/16	135.0	2 1/2	63.5	PT23299-MPG
8 5/32	207.2	1 25/32	45.2	1 1/32	26.2	H9056	8 5/16	211.1	5 29/32	150.0	-	-	PT9509
8 5/32	207.2	2 1/32	51.6	29/32	23.0	PT9412-MPG	8 11/32	211.9	4 11/32	110.3	1 27/32	46.8	P7058
8 5/32	207.2	3 25/32	96.0	2 1/8	54.0	PT9425-MPG	8 3/8	212.7	2 7/16	62.0	1 1/16	27.0	PT23267-MPG
8 5/32	207.2	3 13/16	96.8	1 11/16	42.9	PT9498-MPG	8 3/8	212.7	3 1/8	79.4	1 23/32	43.7	H9096
8 5/32	207.2	6	152.4	4 5/32	105.5	PT23403-MPG	8 3/8	212.7	3 1/8	79.4	1 23/32	43.7	H9097
8 5/32	207.2	6	152.4	4 5/32	105.5	PT23404-MPG	8 3/8	212.7	3 9/32	83.3	1 9/16	39.7	PT7188
8 3/16	208.0	1 3/4	44.4	15/16	23.8	PT23035-MPG	8 3/8	212.7	3 13/32	86.5	2 1/8	54.0	PT23024
8 3/16	208.0	1 25/32	45.2	1	25.4	PT9406-MPG	8 3/8	212.7	3 1/2	89.0	1 9/16	39.6	PT23246-MPG
8 3/16	208.0	2	50.8	15/16	23.8	PT23389-MPG	8 3/8	212.7	3 29/32	99.2	2 1/16	52.4	PT23044-MPG
8 3/16	208.0	3	76.2	1 1/16	27.0	PT535	8 3/8	212.7	5 3/8	136.5	7/8	22.2	PF7770
8 3/16	208.0	3 3/32	78.6	1 21/32	42.1	H9076-V	8 13/32	213.5	1 31/32	50.0	31/32	24.6	PT23442-MPG
8 3/16	208.0	3 3/32	78.6	1 11/16	42.9	PT685-MPG	8 13/32	213.5	1 31/32	50.0	31/32	24.6	PT23443-MPG
8 3/16	208.0	3 5/32	80.2	1 11/16	42.9	H9103	8 13/32	213.5	3 9/32	83.3	1 5/8	41.3	PT7145
8 3/16	208.0	3 1/2	88.9	1 5/8	41.3	P40003	8 7/16	214.3	1 13/16	46.0	15/16	46.0	PT23448-MPG
8 3/16	208.0	3 29/32	99.2	2 1/16	52.4	PT23012	8 7/16	214.3	2 3/4	69.9	1 19/32	40.5	PT9264
8 3/16	208.0	4 1/2	114.3	7/8	22.2	PF155	8 7/16	214.3	2 7/8	73.0	1 3/16	30.2	S16-1
8 3/16	208.0	4 1/2	114.3	7/8	22.2	PF7597	8 7/16	214.3	2 7/8	73.0	1 1/4	31.8	F845-A
8 3/16	208.0	5 1/8	130.2	1 15/16	49.2	PT9168	8 7/16	214.3	3 1/2	88.9	1 5/16	33.3	PT476
8 3/16	208.0	5 1/8	130.2	1 31/32	50.0	PT9182	8 1/2	216.0	2 11/16	68.3	1 9/16	39.7	PT23005
8 3/16	208.0	5 31/32	151.6	4 1/8	104.8	H9001	8 1/2	216.0	3 1/2	89.0	1 15/16	49.2	PT23274-MPG
8 7/32	208.8	1 3/4	44.5	1	25.4	H9051	8 1/2	216.0	3 15/16	100.0	2 1/2	63.5	PT23317
8 7/32	208.8	1 3/4	44.5	1	25.4	H9055	8 1/2	216.0	4	101.6	1 7/16	36.5	PT23041-MPG
8 7/32	208.8	1 3/4	44.5	1 1/32	26.2	H9045	8 1/2	216.0	5 15/16	150.8	3	76.2	PT23180
8 7/32	208.8	1 3/4	44.5	1 1/32	26.2	H9046	8 17/32	216.7	4 7/16	112.7	2 19/32	65.9	PT7330
8 7/32	208.8	1 3/4	44.5	1 1/32	26.2	H9047	8 17/32	216.7	6	152.4	3 17/32	89.7	PT193
8 7/32	208.8	1 3/4	44.5	1 1/32	26.2	H9048	8 17/32	216.7	6	152.4	3 17/32	89.7	PT193-3
8 7/32	208.8	1 25/32	45.2	15/16	23.8	H9231	8 17/32	216.7	6	152.4	3 17/32	89.7	PT193 KIT
8 7/32	208.8	1 25/32	45.2	1	25.4	H9052	8 9/16	217.5	2	50.8	1	25.4	PT23240-MPG
8 7/32	208.8	2	50.8	15/16	23.8	H9111	8 9/16	217.5	3 3/16	81.0	7/16	11.1	P352
8 7/32	208.8	2	50.8	15/16	23.8	H9112	8 9/16	217.5	3 7/32	81.8	-	-	PT23122
8 7/32	208.8	2	50.8	15/16	23.8	H9113	8 5/8	219.1	2 3/4	69.9	1 1/4	31.8	PT439
8 7/32	208.8	2	50.8	15/16	23.8	H9114	8 5/8	219.1	3 29/32	99.2	1 9/16	39.7	PT9175
8 7/32	208.8	2	50.8	31/32	24.6	PT8425	8 5/8	219.1	3 29/32	99.2	1 25/32	45.2	PT9181
8 7/32	208.8	3 9/16	90.5	1 5/8	41.3	PT7264	8 5/8	219.1	5 1/2	139.7	4	101.6	PT9517
8 1/4	209.6	1 25/32	45.2	1	25.4	PT23491-MPG	8 21/32	219.9	2 3/32	53.2	1 1/4	31.8	PT23572-MPG
8 1/4	209.6	1 31/32	50.0	31/32	24.6	PT23498-MPG	8 21/32	219.9	2 3/4	70.0	1 11/16	43.0	PT23476
8 1/4	209.6	2	50.8	15/16	23.8	PT23437-MPG	8 21/32	219.9	4 21/32	118.3	2 5/32	54.8	PT7354
8 1/4	209.6	2 3/4	69.8	1 5/16	33.3	PT23419-MPG	8 21/32	219.9	4 25/32	121.4	5/8	15.9	PT7512
8 1/4	209.6	2 3/4	69.9	1 5/16	33.3	PT23076-MPG	8 21/32	219.9	4 13/16	122.2	21/32	16.7	PT7267
8 1/4	209.6	3 1/16	77.7	1 11/16	42.8	PT23398-MPG	8 11/16	220.7	2 5/8	66.7	1 7/32	31.0	P162
8 1/4	209.6	3 1/16	77.7	1 11/16	42.8	PT23398-MPG	8 11/16	220.7	4 5/16	109.5	2 3/4	69.9	PT9170
8 1/4	209.6	3 1/16	77.7	1 23/32	43.6	PT23395-MPG	8 11/16	220.7	4 7/16	112.7	2	50.8	P40019
8 1/4	209.6	3 1/16	77.7	1 23/32	43.6	PT23414-MPG	8 11/16	220.7	5 1/32	127.8	1 1/2	38.1	PT7368
8 1/4	209.6	3 3/32	78.5	1 23/32	43.6	PT23509-MPG	8 3/4	222.3	5 27/32	148.4	31/32	24.6	PF316
8 1/4	209.6	3 1/8	79.4	1 11/16	42.9	H9073	8 13/16	223.8	2 7/8	73.0	1 9/16	39.7	PT23025
8 1/4	209.6	3 1/8	79.4	1 11/16	42.9	H9074	8 13/16	223.8	3 3/4	95.3	1 13/16	46.0	PF46086



WARNING: These products can expose you to chemicals, including Diisononyl Phthalate, Carbon black extracts, Nickel, 1,3 Butadiene, Ethylene Oxide, Epichlorohydrin, which are known to the State of California to cause cancer, and Bisphenol-A, Ethylene Glycol, Ethylene Oxide, 1,3 Butadiene, Epichlorohydrin, which are known to the State of California to cause birth defects or other reproductive harm. For more information go to www.P65Warnings.ca.gov.

LIQUID ELEMENTS BY LENGTH

LENGTH Inches	LENGTH (mm)	O.D. Inches	O.D. (mm)	I.D. Inches	I.D. (mm)	BALDWIN NUMBER	LENGTH Inches	LENGTH (mm)	O.D. Inches	O.D. (mm)	I.D. Inches	I.D. (mm)	BALDWIN NUMBER
8 13/16	223.8	4 13/32	111.9	1 1/8	28.6	P40031-MPG	9 1/16	230.2	5 1/8	130.2	3 3/8	85.7	PT8496-MPG
8 13/16	223.8	4 13/32	111.9	2 3/4	69.9	PT9169	9 1/16	230.2	6 25/32	172.2	3 15/16	100.0	PT9441-MPG
8 27/32	224.6	2 3/4	69.9	1 5/8	41.3	PT8481	9 1/16	230.2	6 25/32	172.2	3 15/16	100.0	PT9444-MPG
8 27/32	224.6	4 23/32	119.9	-	-	BF46129	9 3/32	231.0	2 1/2	63.5	1 1/16	27.0	PT9158
8 7/8	225.4	2 3/4	69.9	1 5/8	41.3	PT9384-MPG	9 3/32	231.0	3	76.2	1 1/32	26.2	PF7878
8 7/8	225.4	2 13/16	71.4	1 9/16	39.6	PT23176	9 3/32	231.0	3 1/16	77.7	1 19/32	40.4	PT23340-MPG
8 7/8	225.4	3 1/4	82.5	1 7/8	47.6	PT9536-MPG	9 3/32	231.0	5 1/8	130.2	3 3/8	85.7	PT568
8 7/8	225.4	3 5/8	92.0	2 1/2	63.5	PT23144	9 1/8	231.8	2 1/8	54.0	1 1/8	28.6	PT23047-MPG
8 7/8	225.4	3 29/32	99.2	1 9/16	39.7	PT9227	9 1/8	231.8	2 1/8	54.0	1 1/8	28.6	PT23084-MPG
8 7/8	225.4	4 27/32	123.0	2 1/32	16.7	PT7127	9 1/8	231.8	2 9/16	65.1	1 5/16	33.3	PT9522-MPG
8 29/32	226.2	3 29/32	99.2	1 9/16	39.7	PT8997-MPG	9 1/8	231.8	3	76.2	1 9/16	39.7	PT23056-MPG
8 29/32	226.2	4 5/16	109.5	1 3/16	20.6	PF7890	9 1/8	231.8	3 1/16	77.8	1 9/16	39.7	PT9205
8 29/32	226.2	4 5/16	109.5	1 3/16	20.6	PF7890-10	9 1/8	231.8	3 11/16	93.7	2	50.8	PT23213-MPG
8 29/32	226.2	4 5/16	109.5	1 3/16	20.6	PF7890-30	9 1/8	231.8	3 29/32	99.2	1 5/8	41.3	PT8885-MPG
8 29/32	226.2	4 11/32	110.3	1 13/16	46.0	PT9155	9 1/8	231.8	4 1/2	114.3	1 25/32	45.2	PT401-MPG
8 15/16	227.0	2 15/16	74.6	1 1/2	38.1	PT23312	9 5/32	232.6	3 1/16	77.7	1 9/16	39.6	PT23339-MPG
8 15/16	227.0	3 9/32	83.3	1 31/32	50.0	PT8459	9 5/32	232.6	3 17/32	89.7	1 9/16	39.7	PT8945-MPG
8 15/16	227.0	4 1/2	114.3	1 23/32	43.7	PT475	9 5/32	232.6	3 15/16	100.0	1 9/16	39.7	PT8363
8 15/16	227.0	4 1/2	114.3	1 23/32	43.7	PT510	9 3/16	233.4	3 1/16	77.8	1 1/2	38.1	PT23026
8 15/16	227.0	4 1/2	114.3	1 25/32	45.2	PT86-HD	9 3/16	233.4	3 1/16	77.8	1 1/2	38.1	PT23085-MPG
8 15/16	227.0	4 23/32	119.9	2 15/16	74.6	PT9258	9 3/16	233.4	3 15/32	88.1	1 11/32	34.1	PT375
8 15/16	227.0	5 1/8	130.2	3 5/16	84.1	PT9483-MPG	9 3/16	233.4	3 23/32	94.5	1 15/16	49.2	PT8404-MPG
8 15/16	227.0	5 1/8	130.2	3 3/8	85.7	PT88-HD	9 3/16	233.4	3 15/16	100.0	1 7/8	47.6	PT23209-MPG
8 31/32	227.8	2 9/16	65.1	1 9/32	32.5	PT8484	9 3/16	233.4	3 15/16	100.0	2 9/32	57.9	PT189
8 31/32	227.8	3 1/8	79.4	1 7/8	47.6	PT93	9 3/16	233.4	3 15/16	100.0	2 9/32	57.9	PT189-MPG
8 31/32	227.8	3 1/8	79.4	1 7/8	47.6	PT93-MPG	9 3/16	233.4	4 15/32	113.5	3/4	19.1	BF1392-SPS KIT
8 31/32	227.8	3 21/32	92.9	1 23/32	43.7	P1577	9 3/16	233.4	4 1/2	114.3	2 1/4	57.2	PT376
8 31/32	227.8	3 21/32	92.9	2 5/32	54.8	PT1585	9 3/16	233.4	4 17/32	115.1	1 3/32	27.8	PF1291
8 31/32	227.8	4 1/32	102.3	-	-	PT23475	9 7/32	234.2	3 15/16	100.0	1 5/8	41.3	PF7655
8 31/32	227.8	4 3/4	120.7	2 1/4	57.2	P507	9 1/4	235.0	2	50.8	1 1/4	31.8	PT23075-MPG
9	228.6	2 1/4	57.2	1 5/16	33.3	PT23103-MPG	9 1/4	235.0	2 1/2	63.5	1 3/16	30.1	PT23198-MPG
9	228.6	2 3/8	60.3	25/32	19.8	PT9372	9 1/4	235.0	3 1/16	77.8	1 1/2	38.1	PT23029-MPG
9	228.6	2 3/8	60.3	1 5/16	33.3	PT23093-MPG	9 1/4	235.0	3 1/16	77.8	1 17/32	38.9	PT8980-MPG
9	228.6	2 3/8	60.3	1 13/32	35.7	PT8958-MPG	9 1/4	235.0	3 1/2	88.9	1 5/8	41.3	PT9511
9	228.6	2 1/2	63.5	1 3/16	30.1	PT23162	9 1/4	235.0	3 17/32	89.7	1 5/8	41.3	PT737
9	228.6	2 3/4	69.8	1 13/16	46.0	PT23172	9 1/4	235.0	3 17/32	89.7	1 5/8	41.3	PT737-10
9	228.6	2 7/8	73.0	1 13/32	35.7	PT66-HD	9 1/4	235.0	3 29/32	99.2	1 5/8	41.3	PT9297-MPG
9	228.6	3 7/8	98.4	2 5/16	58.7	PT23138	9 1/4	235.0	3 29/32	99.2	1 21/32	42.0	PT23477
9	228.6	4	101.6	1 1/2	38.1	F844-A	9 1/4	235.0	3 29/32	92.2	1 21/32	42.0	PT23514-MPG
9	228.6	4 1/2	114.3	2 1/4	57.2	PT381	9 1/4	235.0	3 15/16	100.0	1 5/8	41.3	PT487
9	228.6	4 1/2	114.3	2 1/4	57.2	PT8331-MPG	9 1/4	235.0	3 15/16	100.0	1 5/8	41.3	PT708-HD
9	228.6	4 9/16	115.9	1 11/16	42.9	PT79	9 1/4	235.0	3 15/16	100.0	1 15/16	49.2	PT8306-10
9	228.6	4 27/32	123.0	2 7/8	73.0	PT538	9 1/4	235.0	3 15/16	100.0	1 15/16	49.2	PT8306-25
9	228.6	5	127.0	2 13/16	71.4	PT563	9 1/4	235.0	3 15/16	100.0	2 9/32	57.9	PT9555
9	228.6	5	127.0	2 13/16	71.4	PT566	9 1/4	235.0	4 7/32	107.2	-	-	PT23306
9	228.6	5	127.0	2 15/16	74.6	PT393	9 1/4	235.0	5 1/8	130.2	3 3/8	85.7	P555
9	228.6	5 1/8	130.2	3 3/8	85.7	PT90-10	9 9/32	235.7	3 1/16	77.8	1 9/16	39.7	PT9313-MPG
9	228.6	5 1/8	130.2	3 3/8	85.7	PT90-MPG	9 9/32	235.7	3 1/2	88.9	1 9/16	39.7	PT8452
9	228.6	5 1/8	130.2	3 3/8	85.7	PT8912	9 9/32	235.7	3 1/2	88.9	1 9/16	39.7	PT8470
9	228.6	5 1/8	130.2	3 3/8	85.7	PT9418	9 9/32	235.7	3 1/2	88.9	1 9/16	39.7	PT9463
9	228.6	6	152.4	2 5/8	66.7	PT499-5	9 9/32	235.7	3 29/32	99.2	1 5/8	41.3	PT9397-MPG
9	228.6	6 25/32	172.2	3 15/16	100.0	PT98-10	9 3/32	235.7	3 29/32	99.2	1 13/16	46.0	PT8370-MPG
9	228.6	6 25/32	172.2	3 15/16	100.0	PT98-MPG	9 9/32	235.7	3 15/16	100.0	1 19/32	40.5	PT670
9	228.6	6 25/32	172.2	4 1/4	108.0	PT9427-MPG	9 9/32	235.7	3 15/16	100.0	1 19/32	40.5	PT670-E
9 1/32	229.4	4 7/32	107.2	1 13/16	46.0	PT8338	9 9/32	235.7	3 15/16	100.0	1 19/32	40.5	PT707-HD
9 1/16	230.2	2 3/32	53.2	1 1/32	26.2	PT8978-MPG	9 9/32	235.7	3 15/16	100.0	1 19/32	40.5	PT707-HD10
9 1/16	230.2	2 3/32	53.2	1 3/32	26.2	PT23503-MPG	9 9/32	235.7	3 15/16	100.0	1 19/32	40.5	PT7332
9 1/16	230.2	2 17/32	64.3	1 1/8	28.6	PT9154	9 9/32	235.7	3 15/16	100.0	1 19/32	40.5	PT7332
9 1/16	230.2	3 23/32	94.5	1 23/32	43.7	PT8378-MPG	9 9/32	235.7	4	101.6	2 5/16	58.7	PT9532
9 1/16	230.2	3 23/32	94.5	1 23/32	43.7	PT8456-MPG	9 9/32	235.7	4 19/32	116.7	2 5/32	54.8	PF7899
9 1/16	230.2	4 7/16	112.7	1 1/2	38.1	P20-HD	9 5/16	236.5	3 1/8	79.3	1 13/32	28.9	PT23275-MPG
9 1/16	230.2	4 7/16	112.7	1 1/2	38.1	PT385	9 5/16	236.5	3 3/16	81.0	1 19/32	40.5	PT23125-MPG
9 1/16	230.2	4 7/16	112.7	1 1/2	38.1	PT385-E	9 5/16	236.5	3 5/8	92.0	1 3/4	44.4	PT23150
9 1/16	230.2	4 1/2	114.3	1 25/32	45.2	PT436	9 5/16	236.5	3 15/16	100.0	1 11/16	42.8	PT23297
9 1/16	230.2	4 17/32	115.1	2 9/32	57.9	PT275	9 5/16	236.5	3 15/16	100.0	2 9/32	57.9	PT8403-MPG
9 1/16	230.2	4 17/32	115.1	2 9/32	57.9	PT275-10	9 5/16	236.5	3 15/16	100.0	2 7/16	62.0	PT23342-MPG
9 1/16	230.2	4 31/32	126.2	1 9/16	39.7	PT431	9 5/16	236.5	4 19/32	116.7	1 3/32	27.8	PF7914
9 1/16	230.2	5 1/8	130.2	3 11/32	84.9	PT94	9 5/16	236.5	5	127.0	2 3/16	55.6	PT146
9 1/16	230.2	5 1/8	130.2	3 11/32	84.9	PT94	9 11/32	237.3	2 29/32	73.8	1 1/4	31.8	PT8985-MPG



WARNING: These products can expose you to chemicals, including Diisononyl Phthalate, Carbon black extracts, Nickel, 1,3 Butadiene, Ethylene Oxide, Epichlorohydrin, which are known to the State of California to cause cancer, and Bisphenol-A, Ethylene Glycol, Ethylene Oxide, 1,3 Butadiene, Epichlorohydrin, which are known to the State of California to cause birth defects or other reproductive harm. For more information go to www.P65Warnings.ca.gov.

LIQUID ELEMENTS BY LENGTH

LENGTH Inches	LENGTH (mm)	O.D. Inches	O.D. (mm)	I.D. Inches	I.D. (mm)	BALDWIN NUMBER	LENGTH Inches	LENGTH (mm)	O.D. Inches	O.D. (mm)	I.D. Inches	I.D. (mm)	BALDWIN NUMBER
9 3/8.....	238.1	3 1/8.....	79.0	3/4.....	19.0	P254	9 27/32.....	250.0	4 31/32.....	126.2	3 5/8.....	92.1	PT23579-MPG
9 3/8.....	238.1	3 13/16.....	96.8	2.....	50.8	PT23181	9 27/32.....	250.0	5 1/8.....	130.1	3.....	76.2	PT23457
9 3/8.....	238.1	3 13/16.....	96.8	2.....	50.8	PT23182	9 27/32.....	250.0	5 1/8.....	130.1	3.....	76.2	PT23458
9 3/8.....	238.1	5 1/16.....	128.6	19/32.....	15.1	PT8335	9 27/32.....	250.0	5 1/8.....	130.1	3.....	76.2	PT23471
9 13/32.....	238.9	6 29/32.....	175.4	3 5/8.....	92.1	PT8411	9 27/32.....	250.0	5 1/8.....	130.1	3.....	76.2	PT23502-MPG
9 7/16.....	239.7	3 3/4.....	95.2	2 1/4.....	57.1	PT23257-MPG	9 7/8.....	250.8	5 1/8.....	130.2	2 29/32.....	73.8	PT8942-MPG
9 7/16.....	239.7	6 13/32.....	162.7	9/16.....	14.3	PT9472	9 7/8.....	250.8	5 27/32.....	148.4	1 3/8.....	34.9	PF7980
9 1/2.....	241.3	2 7/8.....	73.0	1 3/32.....	27.7	PT23518-MPG	9 7/8.....	250.8	5 31/32.....	151.6	3 5/8.....	92.1	PT9515
9 1/2.....	241.3	2 7/8.....	73.0	1 17/32.....	38.9	PT23580-MPG	9 15/16.....	252.4	4 1/4.....	108.0	1 15/16.....	49.2	PT466
9 1/2.....	241.3	3.....	76.2	1 7/16.....	36.5	PT23261-MPG	9 31/32.....	253.2	5.....	127.0	31/32.....	24.6	PF811
9 1/2.....	241.3	4 7/16.....	112.7	1 11/16.....	42.9	PT8467	10.....	254.0	2 7/8.....	73.0	1 13/32.....	35.7	PF924
9 17/32.....	242.1	2 7/8.....	73.0	1 15/32.....	37.3	PT9389-MPG	10.....	254.0	3 5/16.....	84.1	1 7/8.....	47.6	PT23386-MPG
9 9/16.....	242.9	2 3/8.....	60.0	1 7/16.....	36.5	PT23516-MPG	10.....	254.0	3 1/2.....	88.9	1 7/8.....	47.6	PT23089-MPG
9 9/16.....	242.9	2 7/8.....	73.0	1 1/2.....	38.1	PT23556-MPG	10.....	254.0	3 17/32.....	89.7	2 1/32.....	51.6	PT213
9 9/16.....	242.9	3.....	76.2	1 9/16.....	39.7	PT23112-MPG	10.....	254.0	4 1/32.....	102.4	1 25/32.....	45.2	P7319
9 9/16.....	242.9	3 7/8.....	98.4	1 9/32.....	32.5	PT23281-MPG	10.....	254.0	4 3/4.....	120.7	13/16.....	20.6	V1009-W
9 9/16.....	242.9	4 3/8.....	111.1	3 5/8.....	92.1	PT471	10.....	254.0	5 1/2.....	139.7	2 15/32.....	62.7	F908-A
9 19/32.....	243.6	2 11/32.....	59.5	1 13/32.....	35.7	PT23444-MPG	10.....	254.0	5 3/4.....	146.1	1 9/16.....	39.7	DF408
9 19/32.....	243.7	6.....	152.4	13/16.....	20.6	PF7973	10.....	254.0	7 11/16.....	195.3	7/8.....	22.2	C704-L
9 5/8.....	244.5	2 3/8.....	60.3	1.....	25.4	PT8498	10 1/32.....	254.8	2 3/8.....	60.3	1 11/32.....	34.1	PT9502-MPG
9 5/8.....	244.5	2 5/8.....	66.7	1 1/8.....	27.0	PT23059-MPG	10 1/32.....	254.8	3 3/16.....	81.0	1 7/8.....	47.6	PT23020
9 5/8.....	244.5	2 5/8.....	66.7	1 1/8.....	28.6	PT23078-MPG	10 1/32.....	254.8	3 1/4.....	82.5	1 27/32.....	46.8	PT23385-MPG
9 5/8.....	244.5	2 11/16.....	68.2	1 1/8.....	28.5	PT23295-MPG	10 1/32.....	254.8	3 9/32.....	83.3	1 27/32.....	46.8	PT23383-MPG
9 5/8.....	244.5	2 7/8.....	73.0	1.....	25.4	PT8329	10 1/32.....	254.8	3 9/32.....	83.3	1 7/8.....	47.6	PT9494-MPG
9 5/8.....	244.5	2 7/8.....	73.0	1.....	25.4	PT8888	10 1/16.....	255.6	3 3/16.....	81.0	1 7/8.....	47.6	PT23014
9 5/8.....	244.5	2 7/8.....	73.0	1 11/16.....	27.0	PT543 KIT	10 1/16.....	255.6	3 3/16.....	81.0	1 7/8.....	47.6	PT23022
9 5/8.....	244.5	3 1/8.....	79.4	15/16.....	23.8	C40004	10 3/32.....	256.4	4 3/8.....	111.1	1 7/8.....	47.6	PT8427
9 5/8.....	244.5	3 1/4.....	82.6	7/8.....	22.2	PT9504-MPG	10 1/8.....	257.1	4 1/4.....	108.0	3.....	76.2	PT23187
9 5/8.....	244.5	3 15/16.....	100.0	19/32.....	15.1	P7052	10 3/16.....	258.8	4 3/16.....	106.4	2 27/32.....	72.2	PT7268
9 5/8.....	244.5	3 15/16.....	100.0	19/32.....	15.1	P7055	10 3/16.....	258.8	4 1/2.....	114.3	1 29/32.....	48.4	PT554
9 21/32.....	245.3	2 3/8.....	60.3	1.....	25.4	PT8458-MPG	10 3/16.....	258.8	5 1/8.....	130.2	2 1/2.....	63.5	PT23000
9 11/16.....	246.1	1 27/32.....	46.8	1.....	25.4	PT23382-MPG	10 3/16.....	258.8	5 1/8.....	130.2	2 17/32.....	64.3	PT9261-MPG
9 11/16.....	246.1	2 3/16.....	55.5	1 1/32.....	26.1	PT23044-MPG	10 3/16.....	258.8	5 1/8.....	130.2	2 9/16.....	65.1	PT23001
9 11/16.....	246.1	4 1/2.....	114.3	2 1/4.....	57.2	PT725-MPG	10 7/32.....	259.6	2 27/32.....	72.2	1 3/4.....	44.5	PT9150
9 11/16.....	246.1	4 31/32.....	126.2	1 9/16.....	39.7	P999-HD	10 7/32.....	259.6	3 5/16.....	84.1	-	-	PT9331
9 11/16.....	246.1	6 1/16.....	154.0	3 1/4.....	82.6	301	10 1/4.....	260.4	3 3/32.....	78.6	1 21/32.....	42.1	PT9409-MPG
9 11/16.....	246.1	6 1/16.....	154.0	3 1/4.....	82.6	301-30	10 1/4.....	260.4	3 29/32.....	99.2	1 19/32.....	26.1	PT23523-MPG
9 11/16.....	246.1	6 1/16.....	154.0	3 1/4.....	82.6	301-CS	10 1/4.....	260.4	3 29/32.....	99.2	1 19/32.....	40.4	PT23462
9 11/16.....	246.1	6 1/16.....	154.0	3 1/4.....	82.6	301-MPG	10 1/4.....	260.4	3 29/32.....	99.2	1 19/32.....	40.4	PT23479
9 11/16.....	246.1	6 1/16.....	154.0	3 1/4.....	82.6	301-W	10 1/4.....	260.4	4 1/8.....	104.7	2 13/16.....	71.4	PT23214-MPG
9 23/32.....	246.9	2 3/8.....	60.3	31/32.....	24.6	PT23135-MPG	10 1/4.....	260.4	4 5/32.....	105.6	2 3/4.....	69.9	PT8353
9 23/32.....	246.9	4 1/4.....	108.0	3 1/8.....	79.4	PT579	10 1/4.....	260.4	4 3/16.....	106.3	2 13/16.....	71.4	PT23345-MPG
9 23/32.....	246.9	6 1/16.....	154.0	1 15/32.....	37.3	501	10 1/4.....	260.4	4 3/16.....	106.3	2 27/32.....	72.2	PT23461
9 23/32.....	246.9	6 1/16.....	154.0	1 15/32.....	37.3	501-30	10 1/4.....	260.4	4 7/32.....	107.2	1 1/4.....	31.8	BF46042-D
9 23/32.....	246.9	6 1/16.....	154.0	1 15/32.....	37.3	501-W	10 1/4.....	260.4	4 7/32.....	107.2	1 1/4.....	31.8	BF46043-D
9 23/32.....	246.9	6 15/32.....	164.3	1 27/32.....	46.8	PT515	10 1/4.....	260.4	4 1/4.....	108.0	1 11/16.....	42.9	P40008
9 3/4.....	247.7	2 5/16.....	33.3	1 1/16.....	27.0	PT23200-MPG	10 1/4.....	260.4	5 1/8.....	130.2	2 15/32.....	62.7	PT9290-MPG
9 3/4.....	247.7	1 3/4.....	44.5	13/16.....	20.6	PT23108-MPG	10 9/32.....	261.1	2 23/32.....	94.4	1 29/32.....	48.4	PT23366-MPG
9 3/4.....	247.7	1 3/4.....	44.5	13/16.....	20.6	PT23109-MPG	10 9/32.....	261.1	4 3/16.....	106.4	2 27/32.....	72.2	PT8967-MPG
9 3/4.....	247.7	2 1/4.....	57.2	1 3/16.....	30.2	PT23009	10 9/32.....	261.1	7 3/8.....	187.3	2 27/32.....	72.2	PT7003
9 3/4.....	247.7	2 9/16.....	65.1	1 1/16.....	27.0	PT926	10 5/16.....	261.9	3 1/2.....	89.0	2 1/2.....	63.5	PT23179
9 3/4.....	247.7	3 1/16.....	77.8	1 9/16.....	39.7	PT23111-MPG	10 5/16.....	261.9	4 29/32.....	124.6	2 1/16.....	52.4	PF7900
9 3/4.....	247.7	3 9/16.....	90.5	1 7/8.....	45.3	PF7946	10 3/8.....	263.5	5 1/16.....	128.6	2 1/2.....	63.5	PT23019
9 3/4.....	247.7	4 1/8.....	104.8	1 1/4.....	31.8	V1044-O	10 13/32.....	264.3	4 5/8.....	117.5	-	-	B40053
9 3/4.....	247.7	4 1/4.....	108.0	3 1/8.....	79.4	PT9513	10 13/32.....	264.3	4 25/32.....	121.4	2 5/32.....	54.8	P294
9 3/4.....	247.7	4 1/2.....	114.3	2 1/4.....	57.2	PT139-10	10 7/16.....	265.1	4 3/4.....	120.7	2.....	50.8	PT7505
9 3/4.....	247.7	4 25/32.....	121.4	29/32.....	23.0	PT7185	10 7/16.....	265.1	5 1/16.....	128.6	2 3/32.....	53.2	PF7799
9 3/4.....	247.7	5 1/16.....	128.6	2 3/4.....	69.8	PT23119-MPG	10 15/32.....	265.9	3 9/32.....	83.3	1/2.....	12.7	PF9879
9 25/32.....	248.4	2 11/32.....	59.5	1 1/16.....	27.0	PT23347-MPG	10 15/32.....	265.9	4 3/4.....	120.7	2 1/16.....	52.4	PT7230
9 13/16.....	249.2	2 1/4.....	57.2	1 1/8.....	28.6	PT23117-MPG	10 15/32.....	265.9	4 29/32.....	124.6	2.....	50.8	PT9429-MPG
9 13/16.....	249.2	3.....	76.2	1.....	25.4	PT727-DL	10 15/32.....	265.9	4 29/32.....	124.6	2 1/16.....	52.4	PT9407-MPG
9 13/16.....	249.2	3 9/16.....	90.5	1 3/4.....	44.5	PF7947	10 21/32.....	270.7	4 29/32.....	124.6	1 11/16.....	42.9	P7321
9 13/16.....	249.2	4 1/4.....	108.0	3 1/16.....	77.7	PT23323	10 11/16.....	271.5	5 13/16.....	147.6	3 1/2.....	88.9	PT23011
9 13/16.....	249.2	5 1/8.....	130.2	2 29/32.....	73.8	PT8951-MPG	10 23/32.....	272.2	5 29/32.....	150.0	4 5/16.....	109.5	PT23335
9 13/16.....	249.2	5 5/16.....	135.0	3.....	76.2	PT23185	10 13/16.....	274.6	3 11/16.....	93.6	1 7/8.....	47.6	PT23243-MPG
9 13/16.....	249.2	5 27/32.....	148.4	31/32.....	24.6	P116	10 13/16.....	274.6	4 5/16.....	109.5	2 1/4.....	57.2	P1579
9 13/16.....	249.2	5 27/32.....	148.4	31/32.....	24.6	PF116	10 7/8.....	276.2	3 5/8.....	92.1	1 13/16.....	46.0	PT9525-MPG
9 27/32.....	250.0	3 29/32.....	99.2	1 5/8.....	41.3	PT23063-MPG	10 7/8.....	276.2	3 23/32.....	94.5	1 29/32.....	48.4	PT9359-MPG
9 27/32.....	250.0	4 31/32.....	126.2	3 5/8.....	92.1	PT23313							



WARNING: These products can expose you to chemicals, including Diisononyl Phthalate, Carbon black extracts, Nickel, 1,3 Butadiene, Ethylene Oxide, Epichlorohydrin, which are known to the State of California to cause cancer, and Bisphenol-A, Ethylene Glycol, Ethylene Oxide, 1,3 Butadiene, Epichlorohydrin, which are known to the State of California to cause birth defects or other reproductive harm. For more information go to www.P65Warnings.ca.gov.

LIQUID ELEMENTS BY LENGTH

LENGTH Inches	LENGTH (mm)	O.D. Inches	O.D. (mm)	I.D. Inches	I.D. (mm)	BALDWIN NUMBER	LENGTH Inches	LENGTH (mm)	O.D. Inches	O.D. (mm)	I.D. Inches	I.D. (mm)	BALDWIN NUMBER
10 7/8	276.2	4	101.6	2 3/8	60.3	PT23072-MPG	12 1/4	311.2	4 21/32	118.3	2 1/8	54.0	P7192
10 29/32	277.0	2 9/16	65.1	1 3/32	27.8	PT441	12 1/4	311.2	6	152.4	2 25/32	70.6	P1567
10 15/16	277.8	5 5/32	131.0	-	-	PT23186	12 5/16	312.7	3 1/16	77.8	1 23/32	43.7	PT9381-MPG
10 31/32	278.6	4 1/4	108.0	3/4	19.1	PT9129	12 5/16	312.7	3 9/32	83.3	1 3/4	44.5	PT9373-MPG
11	279.4	3 3/4	95.2	1 15/16	49.2	PT23359-MPG	12 5/16	312.7	4 1/8	104.8	2 13/32	61.1	PT8490-MPG
11	279.4	4 1/2	114.3	1 25/32	45.2	PT386	12 3/8	314.3	4 1/2	114.3	2 23/32	69.0	PT23364-MPG
11	279.4	5 1/16	128.6	3 11/32	84.9	PT83	12 15/32	316.7	3 19/32	91.3	2 15/32	62.7	PT9335-MPG
11	279.4	5 1/16	128.6	3 11/32	84.9	PT83-MPG	12 15/32	316.7	3 21/32	92.9	1 7/8	47.6	PT683
11	279.4	5 1/8	130.2	-	-	PT9251	12 1/2	317.5	2 7/8	73.0	1 5/16	33.3	PT9519-MPG
11	279.4	9 1/8	231.8	4 1/4	108.0	PT23027	12 9/16	319.1	3 11/16	93.7	1 3/4	44.5	PT23081-MPG
11 1/32	280.2	3 15/16	100.0	1 9/16	39.7	PT23585	12 9/16	319.1	5 1/16	128.5	2 13/16	71.4	PT23315
11 1/16	281.0	3 1/16	77.8	1 19/32	40.5	PT23590	12 19/32	319.8	3 11/16	93.7	1 29/32	48.4	PT23348-MPG
11 1/16	281.0	3 15/16	100.0	2 11/32	59.5	PT517	12 5/8	320.7	3 19/32	91.3	2 1/2	63.5	PT9506
11 1/16	281.0	5	127.0	2 13/16	71.4	PT285	12 5/8	320.7	3 11/16	93.6	1 7/8	47.6	PT23273-MPG
11 1/16	281.0	5 1/8	130.2	3 11/32	84.9	PT8461	12 5/8	320.7	3 3/4	95.2	1 7/8	47.6	PT23221-MPG
11 1/8	282.5	3 9/16	90.5	1 3/4	44.5	PT502	12 5/8	320.7	4 13/32	111.9	1 9/16	39.7	P40062
11 1/8	282.5	3 9/16	90.5	2 5/16	58.7	PT23165	12 21/32	321.5	4 3/8	111.1	1 9/16	39.7	P7495
11 1/8	282.5	4 11/32	110.3	2 3/16	55.6	PT9341	12 11/16	322.2	3 3/16	81.0	2	50.8	PT23441-MPG
11 13/32	289.7	6 1/32	153.2	2	50.8	P7193	12 11/16	322.2	4 1/32	102.3	1/4	6.3	PT23159
11 7/16	290.5	3 3/8	85.7	1 7/8	47.6	PT8359	12 3/4	323.9	3 11/16	93.7	1 15/16	49.2	PT23247-MPG
11 7/16	290.5	3 17/32	89.7	1 29/32	48.4	PT8479	12 3/4	323.9	4 7/16	112.7	1 3/4	44.5	PT571
11 7/16	290.5	4 31/32	126.2	3 5/8	92.1	PT722	12 27/32	326.2	3 13/16	96.8	1 11/16	42.9	H9036
11 7/16	290.5	4 31/32	126.2	3 5/8	92.1	PT7312	12 27/32	326.2	3 13/16	96.8	1 11/16	42.9	H9037
11 7/16	290.5	4 31/32	126.2	3 5/8	92.1	PT8414-MPG	12 7/8	327.0	3 3/32	78.6	1 11/16	42.9	PT317-MPG
11 7/16	290.5	4 31/32	126.2	3 5/8	92.1	PT8969-MPG	12 7/8	327.0	3 3/32	78.6	1 11/16	42.9	PT318-MPG
11 7/16	290.5	4 31/32	126.2	3 5/8	92.1	PT9254	12 7/8	327.0	3 7/16	87.3	2	50.8	PT23238-MPG
11 7/16	290.5	4 31/32	126.2	3 5/8	92.1	PT23390-MPG	12 7/8	327.0	3 9/16	90.4	1 13/16	46.0	PT23244-MPG
11 7/16	290.5	5 3/4	146.1	2 3/8	60.3	P7381	12 7/8	327.0	3 3/4	95.2	2 1/8	54.0	PT23224-MPG
11 17/32	292.9	5 1/8	130.2	3 3/8	85.7	PT8506-MPG	12 7/8	327.0	3 3/4	95.2	2 1/8	54.0	PT23221-MPG
11 9/16	293.7	2 9/16	65.1	1 5/16	33.3	PT9503-MPG	12 7/8	327.0	3 3/4	95.2	2 1/8	54.0	PT23241-MPG
11 9/16	293.7	4 13/32	111.9	2 3/4	69.9	PT400	12 7/8	327.0	3 3/4	95.2	2 1/4	57.1	PT23223-MPG
11 9/16	293.7	4 13/32	111.9	2 3/4	69.9	PT8893	12 7/8	327.0	3 3/4	95.2	2 5/16	58.7	PT23291-MPG
11 9/16	293.7	5 1/8	130.2	3 3/8	85.7	PT539	12 7/8	327.0	3 13/16	96.8	1 11/16	42.8	PT23506-MPG
11 5/8	295.3	2 5/8	66.7	1 1/4	31.8	PT9526-MPG	12 7/8	327.0	4 9/16	115.9	2 7/32	56.4	PT8402-MPG
11 5/8	295.3	4	101.6	13/16	20.6	PF46010 KIT	12 29/32	327.8	3 5/32	80.2	1 11/16	42.9	H9093
11 11/16	296.9	3 17/32	89.7	-	-	PT9446	12 29/32	327.8	3 13/32	86.5	1 31/32	50.0	PT23440-MPG
11 13/16	300.0	2 13/16	71.4	1 3/4	44.4	PT23163	12 29/32	327.8	3 15/32	88.1	1 19/32	40.5	PT23264-MPG
11 13/16	300.0	2 13/16	71.4	1 3/4	44.4	PT23459	12 29/32	327.8	3 1/2	88.9	1 31/32	50.0	PT9199
11 13/16	300.0	2 27/32	72.2	1 25/32	45.2	PT8400-MPG	12 29/32	327.8	3 9/16	90.4	1 29/32	48.4	PT23368-MPG
11 13/16	300.0	2 27/32	72.2	1 25/32	45.2	PT9479-MPG	12 29/32	327.8	3 25/32	96.0	2 7/32	56.3	PT23401-MPG
11 13/16	300.0	2 27/32	72.2	1 25/32	45.2	PT23504-MPG	12 15/16	328.6	3 5/32	80.2	1 9/16	39.7	PT9559-MPG
11 13/16	300.0	3 9/16	90.5	1 5/8	41.3	PT9148	12 15/16	328.6	3 5/32	80.2	1 23/32	43.7	H9078-V
11 13/16	300.0	5 29/32	150.0	3 5/16	84.1	PT9375	12 15/16	328.6	3 1/2	88.9	1 9/16	39.7	PT23010
11 13/16	300.0	5 29/32	150.0	4 11/32	110.3	PT397	12 15/16	328.6	3 9/16	90.4	1 9/16	39.6	PT23276-MPG
11 13/16	300.0	5 29/32	150.0	4 11/32	110.3	PT8889	12 15/16	328.6	3 9/16	90.5	1 23/32	46.8	PT9303-MPG
11 27/32	300.8	2 27/32	72.2	2 1/32	51.6	PT9132	12 15/16	328.6	3 25/32	96.0	2 1/8	54.0	PT9432-MPG
11 27/32	300.8	2 7/8	73.0	1 25/32	45.2	PT9332	12 31/32	329.4	1 31/32	50.0	31/32	24.6	PT23410-MPG
11 7/8	301.6	5	127.0	2 1/2	63.5	PT469	12 31/32	329.4	3 1/16	77.8	1 23/32	43.6	PT23438-MPG
11 7/8	301.6	5 1/16	128.6	11/16	17.5	PF7715	12 31/32	329.4	3 1/16	77.8	1 23/32	43.6	PT23507-MPG
11 29/32	302.4	5 5/8	142.8	4	101.6	PT23511-MPG	12 31/32	329.4	3 1/8	79.4	1 11/16	42.9	H9077
11 15/16	303.2	6 1/2	165.1	-	-	P7126	12 31/32	329.4	3 1/8	79.4	1 11/16	42.9	H9078
11 31/32	304.0	2 3/4	69.9	1 5/8	41.3	PT23569-MPG	12 31/32	329.4	3 1/8	79.4	1 11/16	42.9	H9079
12	304.8	4 1/8	104.8	1 1/16	27.0	V1240-C	12 31/32	329.4	3 1/8	79.4	1 11/16	42.9	H9080
12 1/8	308.0	2 5/8	66.7	15/16	23.8	PT23094-MPG	12 31/32	329.4	3 1/8	79.4	1 11/16	42.9	H9081
12 1/8	308.0	5 9/16	141.3	4	101.6	PT23170	12 31/32	329.4	3 1/8	79.4	1 11/16	42.9	H9082
12 1/8	308.0	5 9/16	141.3	4	101.6	PT23251-MPG	12 31/32	329.4	3 25/32	96.0	2 7/32	56.4	PT9489-MPG
12 1/8	308.0	5 11/16	144.5	4 3/32	104.0	PT8376-MPG	12 31/32	329.4	8	203.2	6 3/16	157.2	PT9125-MPG
12 1/8	308.0	5 13/16	147.6	4 1/16	103.1	PT23173	13	330.2	2 1/32	51.5	29/32	23.0	PT23432-MPG
12 5/32	308.8	5 1/16	128.6	1 1/4	31.8	P996	13	330.2	2 13/16	71.4	1 15/16	33.3	PT23278-MPG
12 3/16	309.6	2 1/2	63.5	1 1/8	28.6	PT9499-MPG	13	330.2	3	76.2	1 1/2	38.1	PT23393-MPG
12 3/16	309.6	3 3/8	85.7	-	-	PT23530	13	330.2	3	76.2	1 1/2	38.1	PT23416-MPG
12 3/16	309.6	5 1/2	139.7	4 3/16	106.3	PT23331	13	330.2	3 1/16	77.7	1 11/16	42.8	PT23429-MPG
12 3/16	309.6	5 5/8	142.9	4	101.6	PT23156	13	330.2	3 3/8	85.7	1 7/8	85.7	PT23052-MPG
12 3/16	309.6	6 1/2	165.1	5 1/2	139.7	PT503	13	330.2	3 13/16	96.8	2 1/4	57.1	PT23277-MPG
12 7/32	310.4	2 3/4	69.9	1 5/8	41.3	PT9259	13	330.2	4 3/8	111.1	2 9/16	65.0	PT23259-MPG
12 1/4	311.2	3 15/16	100.0	1 21/32	42.1	PF869	13	330.2	4 21/32	118.3	2 3/8	60.3	PT9159
12 1/4	311.2	4 1/2	114.3	1 29/32	48.4	PT573	13	330.2	6	152.4	3 17/32	89.7	P537



WARNING: These products can expose you to chemicals, including Diisononyl Phthalate, Carbon black extracts, Nickel, 1,3 Butadiene, Ethylene Oxide, Epichlorohydrin, which are known to the State of California to cause cancer, and Bisphenol-A, Ethylene Glycol, Ethylene Oxide, 1,3 Butadiene, Epichlorohydrin, which are known to the State of California to cause birth defects or other reproductive harm. For more information go to www.P65Warnings.ca.gov.

LIQUID ELEMENTS BY LENGTH

LENGTH Inches	LENGTH (mm)	O.D. Inches	O.D. (mm)	I.D. Inches	I.D. (mm)	BALDWIN NUMBER	LENGTH Inches	LENGTH (mm)	O.D. Inches	O.D. (mm)	I.D. Inches	I.D. (mm)	BALDWIN NUMBER
13	330.2	7 15/16	201.6	5 7/8	149.2	PT8938-MPG	15	381.0	4 1/2	114.3	2 1/4	57.2	PT550-10
13	330.2	7 31/32	202.4	6 3/16	157.0	PT23453	15	381.0	6 5/16	160.3	7/8	22.2	P7195
13 1/32	331.0	4 3/8	111.1	2 13/32	61.1	PT766	15 3/32	383.4	6 1/2	165.1	5 1/2	139.7	PT418
13 1/32	331.0	4 3/8	111.1	2 13/32	61.1	PT772	15 3/32	383.4	7 11/16	195.3	7/8	22.2	F7500
13 1/32	331.0	4 3/8	111.1	2 7/16	61.9	PT23137	15 3/32	383.4	7 11/16	195.3	7/8	22.2	P7500
13 1/16	331.7	3 15/16	100.0	2 3/8	60.3	PT23154	15 3/32	383.4	7 11/16	195.3	29/32	22.8	C750-L SINGLE
13 1/16	331.8	4 1/32	102.4	2 7/16	61.9	PT23582-MPG	15 3/32	383.4	7 23/32	196.1	29/32	22.8	C750-E
13 3/32	332.6	3 17/32	89.7	1 17/32	38.9	PT9161	15 3/32	383.4	7 23/32	196.1	29/32	22.8	C750-L
13 1/8	333.4	4 3/8	111.1	1 7/8	47.6	PT8441	15 5/32	385.0	2 7/8	73.0	1 11/32	34.1	PT8897-MPG
13 1/8	333.4	4 1/2	114.3	2 11/16	68.3	PT8981-MPG	15 1/4	387.4	4 31/32	126.2	3 5/8	92.1	PT9190
13 1/8	333.4	4 1/2	114.3	2 11/16	68.3	PT23106-MPG	15 1/4	387.4	6 1/2	165.1	3 15/32	88.1	PT8361
13 1/8	333.4	7	177.8	4 3/8	111.1	PT9528	15 9/32	388.1	3 27/32	97.6	2 9/16	65.0	PT23521-MPG
13 3/16	335.0	3 25/32	96.0	2 3/16	55.6	H9058	15 5/16	388.9	6 25/32	172.2	4 7/32	107.2	PT370
13 3/16	335.0	3 25/32	96.0	2 3/16	55.6	H9060	15 11/32	389.7	4 31/32	126.2	3 5/8	92.1	PT8433-MPG
13 3/16	335.0	4	101.6	2 7/16	61.9	PT9212	15 11/32	389.7	4 31/32	126.2	3 5/8	92.1	PT8970-MPG
13 7/32	335.8	3 25/32	96.0	2 3/16	55.6	H9057	15 3/8	390.5	3 1/4	82.6	1 3/8	34.9	PT9530
13 7/32	335.8	8 13/16	223.8	4 1/16	103.2	P1568	15 3/8	390.5	3 9/16	90.5	4 1/4	108.0	PT23004
13 1/4	336.5	4 1/2	114.3	2 5/16	58.7	PT23169	15 1/2	393.7	3 3/4	95.3	Spring Closure		V1542-C
13 1/2	342.9	3 1/4	82.6	1 5/8	41.3	PT9529	15 1/2	393.7	4 1/2	114.3	2 23/32	69.0	PT23362-MPG
13 1/2	342.9	6	152.4	3 11/32	85.0	PT23497-MPG	15 1/2	393.7	6 3/16	157.2	2 7/32	56.4	V414-B
13 19/32	345.3	7 5/16	185.7	3 13/32	86.5	P7012	15 1/2	393.7	6 3/16	157.2	2 7/32	56.4	V414-FF
13 5/8	346.1	3 15/16	100.0	3 1/8	79.4	PT8993-MPG	15 11/16	398.5	3 1/16	77.8	1 1/2	38.1	PT23113-MPG
13 21/32	346.9	7 13/32	188.1	3 13/32	86.5	P7514	15 11/16	398.5	3 1/8	79.4	1 1/2	38.1	PT23114-MPG
13 3/4	349.3	2 13/16	71.4	1 13/16	46.0	PT23042-MPG	15 11/16	398.5	3 1/8	79.4	1 5/8	41.3	PT23068-MPG
13 13/16	351.0	4 31/32	126.2	3 5/8	92.1	PT23158	15 11/16	398.5	3 17/32	89.7	1 19/32	40.5	PT23583-MPG
13 7/8	352.4	3 1/2	88.9	1 27/32	46.8	PT8453	15 11/16	398.5	6	152.4	3 1/2	88.9	PT23116-MPG
14	355.6	2 3/8	60.3	1 1/32	26.1	PT23265-MPG	14 7/32	398.5	5 31/32	151.6	3 15/16	100.0	PT23591-MPG
14	355.6	2 3/4	69.8	1 5/16	33.3	PT23356-MPG	15 23/32	399.3	4 1/2	114.3	2 23/32	69.1	PT23033-MPG
14	355.6	2 3/4	69.8	1 3/8	35.0	PT23220-MPG	15 3/4	400.1	1 27/32	46.8	1	25.4	PT23578-MPG
14	355.6	2 3/4	69.8	1 3/8	35.0	PT23272-MPG	15 3/4	400.1	4 1/8	104.8	2 13/16	74.1	PT23101-MPG
14	355.6	2 3/4	69.8	1 3/8	35.0	PT23287-MPG	15 3/4	400.1	5 1/8	130.2	2 11/16	68.3	PT23120-MPG
14 3/32	358.0	5 15/16	150.8	3 5/32	80.2	PT8994-MPG	15 3/4	400.1	5 15/16	150.8	3 19/32	91.3	PT9399-MPG
14 1/8	358.8	3 17/32	89.7	1 27/32	46.8	PT9172	15 27/32	402.4	3 23/32	94.5	1 29/32	48.4	PT23577-MPG
14 3/16	360.4	3 1/2	88.9	1 7/8	47.6	PT9376	15 29/32	404.0	5 1/8	130.1	2 17/32	64.2	PT23467
14 3/16	360.4	6 7/8	174.6	3 5/8	92.1	PT8410	15 29/32	404.0	5 1/8	130.1	2 9/16	65.0	PT23505-MPG
14 9/32	362.7	5 21/32	143.7	3 3/4	95.3	PT9500-MPG	16	406.4	4 1/4	108.0	1 1/16	27.0	F1645-DS
14 7/16	366.7	4 9/32	108.7	2 3/32	53.2	P1578	16	406.4	4 1/4	108.0	1 1/16	27.0	V1645-C
14 1/2	368.3	4 1/4	108.0	2 7/16	62.0	PT23167	16	406.4	4 3/8	111.1	2 7/16	61.9	PT694
14 1/2	368.3	4 19/32	116.7	2 5/16	58.7	PT9171	16	406.4	4 3/8	111.1	2 7/16	61.9	PT8371-MPG
14 1/2	368.3	6	152.4	1 1/8	28.6	PT117	16	406.4	4 1/2	114.3	1 1/16	27.0	V1656-O
14 1/2	368.3	6	152.4	1 1/8	28.6	PT117-25	16	406.4	4 1/2	114.3	1 1/16	27.0	V1656-T
14 1/2	368.3	6	152.4	3 1/2	88.9	PT119	16	406.4	5 5/16	135.0	2 1/2	63.5	PT23152
14 1/2	368.3	6	152.4	3 1/2	88.9	PT119-5	16	406.4	6	152.4	2 5/8	66.7	PT18-5
14 1/2	368.3	6	152.4	3 1/2	88.9	PT119-HD	16	406.4	7 21/32	194.5	4 21/32	118.3	P7337
14 1/2	368.3	6	152.4	3 1/2	88.9	PT119-HD5	16 1/32	407.2	4 3/8	111.1	2 7/16	61.9	PT8442
14 1/2	368.3	6 1/32	153.2	1	25.4	PF949	16 1/32	407.2	4 3/8	111.1	2 7/16	61.9	PT9340-MPG
14 9/16	369.9	3 1/4	82.5	1 7/8	47.6	PT23049-MPG	16 1/16	408.0	4 3/8	111.1	2 13/32	61.1	PT752
14 5/8	371.5	3 1/4	82.5	1 7/8	47.6	PT23023	16 1/16	408.0	4 3/8	111.1	2 13/32	61.1	PT8494
14 21/32	372.2	5 13/32	137.3	3 15/16	100.0	PT23427-MPG	16 1/16	408.0	4 3/8	111.1	2 13/32	61.1	PT9385-MPG
14 11/16	373.1	3 1/4	82.5	1 13/16	46.0	PT23254-MPG	16 1/16	408.0	4 3/8	111.1	2 7/16	61.9	PT763
14 11/16	373.1	3 9/32	83.3	1 27/32	46.8	PT23381-MPG	16 1/16	408.0	4 3/8	111.1	2 7/16	61.9	PT767
14 11/16	373.1	3 9/32	83.3	1 7/8	47.6	PT9495-MPG	16 1/16	408.0	4 3/8	111.1	2 7/16	61.9	PT773-MPG
14 11/16	373.1	3 5/16	84.2	2	50.8	PT23155	16 1/16	408.0	4 13/32	111.9	2 7/16	61.9	PT768
14 3/4	374.7	2 7/8	73.0	1 9/16	39.7	PT23054-MPG	16 1/8	409.6	3 5/16	84.1	1 1/2	38.1	PT9523-MPG
14 3/4	374.7	3	76.2	1 9/16	39.7	PT23057-MPG	16 5/32	410.4	5 1/8	130.2	2 17/32	64.3	PT9250
14 3/4	374.7	3 1/16	77.8	1 19/32	40.5	PT23353-MPG	16 3/16	411.2	4 1/2	114.3	2 3/4	69.9	PT9403-MPG
14 3/4	374.7	3 1/16	77.8	1 19/32	40.5	PT23354-MPG	16 7/32	412.0	4 1/2	114.3	2 1/2	63.5	PT9383-MPG
14 3/4	374.7	3 3/8	85.7	1 7/8	47.6	PT23168	16 7/32	412.0	4 5/8	117.5	2 19/32	65.9	PT23581-MPG
14 13/16	376.2	3 1/16	77.8	1 9/16	39.7	PT23050-MPG	16 7/32	412.0	5 1/8	130.2	2 15/32	62.7	PT8950-MPG
14 7/8	377.8	3 13/16	96.8	2 1/2	63.5	PT23406-MPG	16 1/4	412.7	3 1/2	89.0	1 1/2	38.1	PT23174
14 7/8	377.8	4	101.6	1 9/16	39.7	PT751	16 11/32	415.1	3 27/32	97.6	2 17/32	64.3	PT23236-MPG
14 7/8	377.8	4 15/32	113.5	2 27/32	72.2	PT9162	16 15/32	418.3	3	76.2	1 11/32	34.1	PT23271-MPG
14 15/16	379.4	7 1/2	190.5	23/32	18.3	P706-M	16 15/32	418.3	3 1/8	79.3	1 11/32	34.1	PT23279-MPG
15	381.0	3 1/16	77.7	1 19/32	40.4	PT23341-MPG	16 17/32	419.9	3 1/8	79.4	1 15/16	49.2	PT8495-MPG
15	381.0	3 1/8	79.0	1 1/2	38.1	PT23053-MPG	16 17/32	419.9	5 31/32	151.6	3 1/2	88.9	PT9480-MPG
15	381.0	3 3/4	95.3	1 1/16	27.0	V1544-T	16 9/16	420.6	3 1/16	77.8	2	50.8	PT23226-MPG
15	381.0	4 5/32	105.6	2 1/16	52.4	PT23565-MPG	16 9/16	420.6	3 3/32	78.5	2 1/32	51.5	PT23417-MPG
							16 11/16	423.9	5 19/32	142.1	3 7/8	98.4	PT9556-MPG



WARNING: These products can expose you to chemicals, including Diisononyl Phthalate, Carbon black extracts, Nickel, 1,3 Butadiene, Ethylene Oxide, Epichlorohydrin, which are known to the State of California to cause cancer, and Bisphenol-A, Ethylene Glycol, Ethylene Oxide, 1,3 Butadiene, Epichlorohydrin, which are known to the State of California to cause birth defects or other reproductive harm. For more information go to www.P65Warnings.ca.gov.

LIQUID ELEMENTS BY LENGTH

LENGTH Inches	LENGTH (mm)	O.D. Inches	O.D. (mm)	I.D. Inches	I.D. (mm)	BALDWIN NUMBER	LENGTH Inches	LENGTH (mm)	O.D. Inches	O.D. (mm)	I.D. Inches	I.D. (mm)	BALDWIN NUMBER
16 23/32	424.7	5 19/32	142.1	3 27/32	97.6	PT8436	18	457.2	6	152.4	2 5/8	66.7	P415-5A
16 13/16	427.0	3 3/32	78.5	1 5/8	41.2	PT23522-MPG	18	457.2	6	152.4	2 5/8	66.7	P415-10A
16 13/16	427.0	3 3/8	85.7	1 15/16	49.2	PT23237-MPG	18	457.2	6	152.4	2 5/8	66.7	P415-25A
16 13/16	427.0	3 3/8	85.7	1 15/16	49.2	PT23242-MPG	18	457.2	6	152.4	2 23/32	69.1	PT491
16 13/16	427.0	3 13/32	86.5	1 31/32	35.7	PT23402-MPG	18	457.2	6	152.4	2 23/32	69.1	PT491-10
16 13/16	427.0	3 13/32	86.5	1 31/32	50.0	PT23415-MPG	18	457.2	6	152.4	3 1/2	88.9	PT122-5
16 13/16	427.0	3 25/32	96.0	2 3/16	55.6	PT319-MPG	18	457.2	6 3/16	157.2	2 13/32	61.1	F415-B
16 13/16	427.0	3 25/32	96.0	2 3/16	55.6	PT320-MPG	18	457.2	6 3/16	157.2	2 13/32	61.1	V415-B
16 13/16	427.0	3 25/32	96.0	2 7/32	56.3	PT23394-MPG	18	457.2	6 3/16	157.2	2 13/32	61.1	V415-FF
16 13/16	427.0	5 29/32	150.0	4 5/32	105.5	PT23349-MPG	18	457.2	6 17/32	165.9	2 17/32	64.3	P415-GM
16 13/16	427.0	5 31/32	151.6	3 1/4	82.5	PT23355-MPG	18 1/32	458.0	4 13/32	111.9	2 9/16	65.1	PT8388
16 27/32	427.8	3 13/32	86.5	1 15/16	49.2	H9123	18 1/32	458.0	4 13/32	111.9	2 9/16	65.1	PT8389
16 27/32	427.8	5 31/32	151.6	4 1/8	104.8	H9007	18 1/32	458.0	6	152.4	3 17/32	89.7	PT8491
16 7/8	428.6	3 3/32	78.6	1 1/2	38.1	PT8519-MPG	18 1/16	458.8	3 11/16	93.7	1 23/32	43.7	P1576
16 7/8	428.6	3 1/8	79.4	1 11/16	42.9	H9083	18 1/16	458.8	6	152.4	2 5/8	66.7	PT212-5
16 7/8	428.6	3 1/8	79.4	1 11/16	42.9	H9084	18 1/16	458.8	7 7/16	188.9	4 13/16	122.2	PT8395
16 7/8	428.6	3 1/8	79.4	1 11/16	42.9	H9085	18 1/8	460.4	4 1/2	114.3	1 25/32	45.2	PT430-FF
16 7/8	428.6	3 1/8	79.4	1 11/16	42.9	H9086	18 1/8	460.4	4 5/8	117.5	5/8	15.9	V24-A2
16 7/8	428.6	3 1/8	79.4	1 11/16	42.9	H9087	18 5/32	461.2	6 1/8	155.6	3 15/16	100.0	PT9348-MPG
16 7/8	428.6	3 3/8	81.0	1 15/16	49.2	PT23030-MPG	18 5/32	461.2	7 7/16	188.9	4 13/16	122.2	PT8396
16 7/8	428.6	3 25/32	96.0	2 3/16	55.6	PT9453-MPG	18 5/32	461.2	8 25/32	223.0	4 3/32	104.0	PF1584
16 7/8	428.6	3 25/32	96.0	2 7/32	56.4	PT8447-MPG	18 7/32	462.8	8 13/16	223.8	4 1/16	103.2	P1562
16 7/8	428.6	6	152.4	3 1/4	82.6	H9020	18 1/4	463.5	4 1/8	104.7	2 3/4	69.9	PT23232-MPG
16 7/8	428.6	6	152.4	3 1/4	82.6	H9021	18 9/32	464.3	3 15/16	100.0	2 17/32	64.3	PT9288-MPG
16 7/8	428.6	6	152.4	4 1/32	102.4	PT23249-MPG	18 9/32	464.3	4 5/32	105.6	2 27/32	72.2	PT9189
16 29/32	429.4	3 25/32	96.0	2 7/32	56.3	PT23409-MPG	18 5/16	465.1	4 5/32	105.6	2 17/32	64.3	PT23134-MPG
16 31/32	431.0	6 1/8	155.6	4 13/16	122.2	PT9557	18 5/16	465.1	4 5/32	105.6	2 27/32	72.2	PT8455-MPG
17	431.8	3 1/32	77.0	2 1/32	77.0	PT23262-MPG	18 5/16	465.1	4 3/16	106.3	2 13/16	71.4	PT23392-MPG
17	431.8	3 1/16	77.7	1 13/16	46.0	PT23423-MPG	18 5/16	465.1	5	127.0	3 1/4	82.6	PT551-10
17	431.8	6 1/2	165.1	2 3/4	69.9	V1874-T	18 5/16	465.1	5	127.0	3 1/4	82.6	PT9554-MPG
17 3/32	434.1	3 23/32	94.4	1 29/32	48.4	PT23352-MPG	18 7/16	468.3	3 11/16	93.7	1 15/16	49.2	PT23446-MPG
17 3/32	434.1	6 5/8	168.3	3 13/32	86.5	P1561	18 7/16	468.3	5 7/32	132.6	3 3/8	85.7	PT9361
17 1/8	435.0	3 7/8	98.4	1 1/2	38.1	PT23098-MPG	18 1/2	469.9	3 21/32	92.4	1 3/4	44.5	PT8394-MPG
17 5/32	435.8	6	152.4	2 5/32	54.8	PT729	18 1/2	469.9	3 21/32	92.4	1 3/4	44.5	PT23324
17 1/4	438.2	6 1/16	154.0	3 3/4	95.3	PT9452	18 1/2	469.9	3 7/8	98.4	1 5/8	41.2	PT23211-MPG
17 5/16	439.7	7 15/16	201.6	6 3/16	157.2	PT9290	18 1/2	469.9	3 7/8	98.4	2 1/4	57.2	PT8446-MPG
17 5/16	439.7	7 31/32	202.4	6 3/16	157.1	PT23483-MPG	18 1/2	469.9	3 7/8	98.4	2 1/4	57.2	PT23616-MPG
17 1/2	444.5	3 11/16	93.7	1 13/16	46.0	PT23252-MPG	18 1/2	469.9	3 29/32	99.2	1 5/8	41.3	PT9487-MPG
17 17/32	445.3	4 3/16	106.4	2 1/16	52.4	PT23566-MPG	18 1/2	469.9	3 29/32	99.2	1 5/8	41.3	PT9488-MPG
17 11/16	449.3	4 13/32	111.9	2 3/4	69.9	PT8387	18 1/2	469.9	3 29/32	99.2	1 21/32	42.0	PT23515-MPG
17 23/32	450.1	5 29/32	150.0	4 11/32	110.3	PT483	18 1/2	469.9	3 29/32	99.2	1 21/32	42.0	PT23519-MPG
17 23/32	450.1	5 29/32	150.0	4 11/32	110.3	PT8366	18 1/2	469.9	3 29/32	99.2	1 27/32	46.8	PT8517-MPG
17 23/32	450.1	5 29/32	150.0	4 11/32	110.3	PT8896	18 1/2	469.9	3 29/32	99.2	2 1/4	57.2	PT23595-MPG
17 23/32	450.1	5 29/32	150.0	4 11/32	110.3	PT9338-MPG	18 1/2	469.9	3 15/16	100.0	1 19/32	40.5	PT757
17 23/32	450.1	5 29/32	150.0	4 11/32	110.3	PT9357	18 1/2	469.9	3 15/16	100.0	1 19/32	40.5	PT757-10
17 3/4	450.9	6	152.4	2 5/8	66.7	P415-5AN	18 9/16	471.5	3 1/2	88.9	1 9/16	39.7	PT8489
17 3/4	450.9	7	177.8	4 5/16	109.5	PT8478	18 9/16	471.5	3 1/2	88.9	1 9/16	39.7	PT8511
17 3/4	450.9	7	177.8	4 5/16	109.5	PT8492	18 5/8	473.1	4 31/32	126.2	1 3/16	30.2	PT493
17 3/4	450.9	7	177.8	4 5/16	109.5	PT9379	18 5/8	473.1	5 1/8	130.2	3 3/8	85.7	PT714
17 13/16	452.4	6	152.4	2 5/8	66.7	PT23133-MPG	18 5/8	473.1	6 1/2	165.1	2 31/32	75.4	PT527
17 13/16	452.4	6 1/16	154.0	2 5/8	66.6	PT23451	18 13/16	477.8	4 15/16	125.4	3 5/8	92.1	PT9191
17 27/32	453.2	6 3/32	154.7	2 5/8	66.7	PT23485-MPG	18 7/8	479.4	3 5/8	92.1	2 1/8	54.0	PT23070-MPG
17 27/32	453.2	6 3/32	154.7	2 5/8	66.7	PT23508-MPG	18 7/8	479.4	5	127.0	3 9/16	90.4	PT23234-MPG
17 7/8	454.0	5 29/32	150.0	4 11/32	110.3	PT8380	18 7/8	479.4	5 5/8	142.8	3 3/4	95.2	PT23253-MPG
17 29/32	454.8	5 29/32	150.0	4 11/32	110.3	PT8383	18 29/32	480.2	4	101.6	1 9/16	39.7	PT7617
17 29/32	454.8	5 29/32	150.0	4 11/32	110.3	PT8909	18 29/32	480.2	4 31/32	126.2	3 5/8	92.1	PT8971-MPG
17 15/16	455.6	3 21/32	92.9	1 23/32	43.7	PF1589	18 29/32	480.2	4 31/32	126.2	3 5/8	92.1	PT9306-MPG
17 15/16	455.6	3 15/16	100.0	2 9/32	57.9	PT8305	18 29/32	480.2	4 31/32	126.2	3 5/8	92.1	PT9445-MPG
17 15/16	455.6	5 15/16	150.8	3 5/16	84.1	PT23600	18 15/16	481.0	3 11/16	93.7	1 9/16	39.7	PT8891-MPG
18 5/16	456.1	4 31/32	126.2	3 5/16	8.1	PT23520-MPG	19	482.6	3 31/32	100.8	2 13/32	61.1	PT23588
18	457.2	4 13/32	111.9	2 19/32	65.9	PT8408	19	482.6	4	101.6	2 1/2	63.5	PT23318
18	457.2	4 15/16	125.4	1 17/32	38.9	PT490	19 1/32	483.4	5 21/32	143.6	3 25/32	96.0	PT23360-MPG
18	457.2	5	127.0	3 1/2	88.9	PT23151	19 7/16	493.7	4 5/32	105.6	2 27/32	72.2	PT8941-MPG
18	457.2	5 3/8	136.5	3	76.2	PT23245-MPG	19 7/16	493.7	5 5/16	134.9	3 3/4	95.3	PT23062-MPG
18	457.2	6	152.4	2 1/8	54.0	P415-5	19 1/2	495.3	2 7/8	73.0	1 1/16	27.0	PF952
18	457.2	6	152.4	2 1/8	54.0	P415-10	19 1/2	495.3	3	76.2	1 11/16	42.9	TC413-CPE5
18	457.2	6	152.4	2 1/8	54.0	P415-25	19 7/8	504.8	4 7/8	123.8	2 3/4	69.9	PT23139-MPG



WARNING: These products can expose you to chemicals, including Diisononyl Phthalate, Carbon black extracts, Nickel, 1,3 Butadiene, Ethylene Oxide, Epichlorohydrin, which are known to the State of California to cause cancer, and Bisphenol-A, Ethylene Glycol, Ethylene Oxide, 1,3 Butadiene, Epichlorohydrin, which are known to the State of California to cause birth defects or other reproductive harm. For more information go to www.P65Warnings.ca.gov.

LIQUID ELEMENTS BY LENGTH

LENGTH Inches	LENGTH (mm)	O.D. Inches	O.D. (mm)	I.D. Inches	I.D. (mm)	BALDWIN NUMBER	LENGTH Inches	LENGTH (mm)	O.D. Inches	O.D. (mm)	I.D. Inches	I.D. (mm)	BALDWIN NUMBER
20	508.0	4 1/2	114.3	1 23/32	43.7	PT512	27 31/32	710.4	3 29/32	99.2	1 21/32	42.0	PT23452
20 9/32	515.1	5 7/8	149.2	4 1/2	114.3	PT23239-MPG	28	711.2	3 15/16	100.0	1 11/16	42.8	PT23449-MPG
20 5/16	515.9	6	152.4	3 15/16	100.0	PT23589	29 1/4	743.0	6 3/16	157.2	2 1/2	63.5	V429-B
20 1/2	520.7	4 5/32	105.6	2 27/32	72.2	PT9244	29 1/4	743.0	6 3/16	157.2	2 1/2	63.5	V429-FF
20 1/2	520.7	6 1/8	155.6	3 15/16	100.0	PT9355-MPG	29 3/8	746.1	6 1/2	165.1	1 15/32	37.3	P1510
20 11/16	525.5	4 13/32	111.9	2 1/8	54.0	PT9443	30 3/32	764.4	6 13/32	162.7	1 15/32	37.3	P7183
20 15/16	531.8	5 1/16	128.6	1 1/16	17.5	PF7716	30 1/2	774.7	6 3/16	157.2	1 23/32	43.7	V1520-R
21 15/32	545.3	7 31/32	202.4	6 3/16	157.2	PT8990-MPG	31	787.4	4 3/8	111.1	1 5/8	41.3	C133-OW
21 1/2	546.1	8	203.2	6 3/16	157.2	PT753	31	787.4	4 3/8	111.1	1 5/8	41.3	C133-W
21 1/2	546.1	9	228.6	7 3/32	180.2	PT8943-MPG	31 1/4	793.8	4 3/8	111.1	1 5/32	29.4	V7129-C
21 9/16	547.7	8 15/16	227.0	7 1/16	179.4	PT9524-MPG	32	812.8	6 1/2	165.1	3 3/4	95.3	V1560
21 23/32	551.7	3 11/16	93.7	1 7/8	47.6	PT23531-MPG	32 15/32	824.7	8 9/32	210.3	6 5/32	156.3	PT23157
22	558.8	7 7/16	188.9	4 3/4	120.7	PT518	32 1/2	825.5	8	203.2	6 1/4	158.7	PT23256-MPG
22	558.8	7 7/16	188.9	4 3/4	120.7	PT518-10	32 11/16	830.3	5 31/32	151.6	3 7/16	87.3	PT9328-MPG
22 1/32	560.0	7 7/16	189.0	4 27/32	123.0	PT23486-MPG	33 7/8	860.4	6 13/32	162.7	1 15/32	37.3	P1511
22 13/16	579.4	4 15/16	125.4	3 1/4	82.6	PT9520-MPG	36 1/2	927.1	5 13/32	137.3	3 15/16	100.0	PT23424-MPG
22 27/32	580.2	4 31/32	126.2	3 5/8	92.0	PT23517-MPG	36 1/2	927.1	5 13/32	137.3	3 15/16	100.0	PT23425-MPG
23 5/8	600.0	4 21/32	118.3	2 11/32	59.5	PT9283-MPG	36 1/2	927.1	5 13/32	137.3	3 15/16	100.0	PT23428-MPG
23 5/8	600.0	4 23/32	120.0	2 13/16	71.4	PT23466	36 1/2	927.1	6	152.4	3 15/16	100.0	PT23411-MPG
24 3/32	612.0	3 23/32	94.4	1 29/32	48.4	PT23450-MPG	36 1/2	927.1	6	152.4	3 15/16	100.0	PT23426-MPG
24 1/2	622.3	5 31/32	151.6	3 1/2	88.9	PT9247	36 1/2	927.1	6	152.4	3 15/16	100.0	PT23431-MPG
24 13/16	630.2	6 1/8	155.6	3 29/32	99.2	PT9451-MPG	36 1/2	927.1	6	152.4	3 15/16	100.0	PT23439-MPG
25 1/2	647.7	6	152.4	3 15/16	100.0	PT9350-MPG	36 11/16	931.9	5 1/2	139.7	3 3/4	95.3	PT23065-MPG
25 5/8	650.9	6	152.4	3 1/4	82.6	H9024	36 11/16	931.9	5 1/2	139.7	3 13/16	96.8	PT23104-MPG
25 21/32	651.7	3 3/8	85.7	2	50.8	PT9496-MPG	36 3/4	933.5	2 3/8	60.3	-	-	F501-MD
25 21/32	651.7	3 3/8	85.7	2	50.8	PT9497-MPG	37 3/8	949.3	6 1/8	155.6	3 29/32	99.2	PT9459-MPG
25 21/32	651.7	3 13/16	96.8	1 11/16	42.9	H9039	38 1/2	978.0	6	152.4	4 1/2	114.3	PT23248-MPG
25 11/16	652.5	3 7/16	87.3	1 7/8	47.6	PT23250-MPG	38 5/8	981.0	6	152.4	4 1/32	102.3	PT23255-MPG
25 11/16	652.5	3 13/16	96.8	2 3/8	60.3	PT23435-MPG	38 11/16	982.7	5 31/32	151.6	4 1/8	104.8	H9013
25 13/16	655.6	3 13/16	96.8	2 3/16	55.5	PT23422-MPG	38 11/16	982.7	5 31/32	151.6	4 5/32	105.6	H9014
25 27/32	656.4	3 25/32	96.0	2 7/32	56.3	PT23420-MPG	38 13/16	985.8	3 25/32	96.0	2 7/32	56.3	PT23421-MPG
25 7/8	657.2	3 3/4	95.2	2 5/16	58.7	PT23413-MPG	38 13/16	985.8	3 25/32	96.0	2 7/32	56.3	PT23434-MPG
25 15/16	658.8	3 25/32	96.0	2 3/16	55.6	H9062	42 29/32	1089.8	7 31/32	202.4	6 3/16	157.1	PT23343-MPG
26	660.4	7 7/8	200.0	6 5/8	168.3	PT23051-MPG							
27 11/16	703.2	4	101.6	1 3/4	44.4	PT23282-MPG							
27 11/16	703.2	4	101.6	1 15/16	49.2	PT23227-MPG							



WARNING: These products can expose you to chemicals, including Diisononyl Phthalate, Carbon black extracts, Nickel, 1,3 Butadiene, Ethylene Oxide, Epichlorohydrin, which are known to the State of California to cause cancer, and Bisphenol-A, Ethylene Glycol, Ethylene Oxide, 1,3 Butadiene, Epichlorohydrin, which are known to the State of California to cause birth defects or other reproductive harm. For more information go to www.P65Warnings.ca.gov.

ROUND AIR FILTERS BY LENGTH

All Measurements in Inches and (Millimeters)

NOTE: All round air filters have been sorted by length and then outside diameter.
The larger outside and inside diameters have been listed.

LENGTH Inches	LENGTH (mm)	O.D. Inches	O.D. (mm)	I.D. Inches	I.D. (mm)	BALDWIN NUMBER	LENGTH Inches	LENGTH (mm)	O.D. Inches	O.D. (mm)	I.D. Inches	I.D. (mm)	BALDWIN NUMBER
19/32	15.1	1 31/32	50.0	1 13/32	35.7	PA30157	2 3/8	60.3	10 1/16	255.6	7 21/32	194.5	PA1735
15/16	23.8	2 7/16	61.9	1 31/32	50.0	S9475	2 3/8	60.3	10 1/8	257.2	7 15/16	201.6	PA1657
31/32	24.6	9 13/32	238.9	-	-	PA4701	2 3/8	60.3	13 1/16	331.8	-	-	PA4070
1	25.4	2 13/16	71.4	1 5/16	33.3	PA1909	2 7/16	61.9	8 1/2	215.9	6 15/16	176.2	PA2109
1 9/32	32.5	2 5/32	54.8	1 1/32	31.2	PA5276	2 7/16	61.9	10 1/4	260.4	8	203.2	PA2117
1 5/16	33.3	5	127.0	2 5/8	66.7	PA1627	2 15/32	62.7	5 19/32	142.1	4	101.6	PA2096
1 3/8	34.9	3	76.2	1 5/8	41.3	PA1704	2 15/32	62.7	7	177.8	5 9/16	141.3	PA2069
1 3/8	34.9	4	101.6	1 11/32	34.1	PA2256	2 15/32	62.7	7 27/32	199.2	5 9/16	141.3	PA30189
1 13/32	35.7	5 5/32	131.0	3 3/8	85.7	PA2070	2 15/32	62.7	9	228.6	7 1/2	190.5	PA691
1 1/2	38.1	2 5/32	54.8	1 7/32	31.0	PA5316	2 1/2	63.5	10 1/32	254.8	8 17/32	216.7	PA2113
1 1/2	38.1	4 1/4	108.0	3	76.2	PA677	2 1/2	63.5	11 13/16	300.0	9 13/16	249.2	PA2006
1 19/32	40.5	2 9/32	57.9	23/32	18.3	PA4978	2 1/2	63.5	13	330.2	11 9/32	286.5	PA2024
1 19/32	40.5	11 17/32	292.9	8 3/4	222.3	PA2124	2 17/32	64.3	4 9/32	108.7	2	50.8	PA30019
1 5/8	41.3	3 7/8	98.4	2 1/2	63.5	PA633(2)	2 9/16	65.1	2 15/16	254.8	1 7/8	47.6	PA1603
1 5/8	41.3	9 5/8	244.5	-	-	PA2216	2 9/16	65.1	5 3/4	146.1	3 1/2	88.9	PA696
1 21/32	42.1	2 29/32	73.8	1 19/32	40.5	PA4778	2 9/16	65.1	10 3/4	273.1	8 5/8	219.1	PA2007
1 23/32	43.7	10 3/8	263.5	7 13/16	198.4	PA2147	2 19/32	65.9	2 15/32	62.7	1 7/16	36.5	PA4815
1 25/32	45.2	3 5/8	92.1	2 3/4	69.9	PA4186	2 19/32	65.9	4 3/8	111.1	1 31/32	50.0	PA2477
1 25/32	45.2	4 1/8	104.8	2 1/8	54.0	PA4824	2 19/32	65.9	5 3/16	131.8	1 1/2	38.1	PA2347
1 25/32	45.2	7	177.8	5 9/16	141.3	PA2068	2 5/8	66.7	4 13/16	122.2	2 5/16	58.7	PA4910
1 25/32	45.2	11 7/32	285.0	9 3/8	238.1	PA2074	2 5/8	66.7	10 1/32	254.8	-	-	PA4061
1 13/16	46.0	1 31/32	50.0	1 1/8	28.6	PA2933	2 5/8	66.7	12 5/16	312.7	10 13/16	274.6	PA2009
1 13/16	46.0	10 3/32	256.4	-	-	PA2207	2 5/8	66.7	13 7/8	352.4	11 5/8	295.3	PA2110
1 13/16	46.0	10 7/32	259.6	7 7/32	183.4	PA3697	2 11/16	68.3	2 7/8	73.0	1 3/8	34.9	PA643
1 7/8	47.6	9 11/16	246.1	8 3/16	208.0	PA658	2 11/16	68.3	4 13/16	122.2	2 5/16	58.7	PA4694
1 15/16	49.2	5 5/32	131.0	3 3/8	85.7	PA2071	2 11/16	68.3	11 3/16	284.2	9 1/16	230.2	PA2051
1 15/16	49.2	6 1/16	154.0	4 5/8	117.5	PA678	2 23/32	69.1	2 17/32	64.3	1 1/2	38.1	PA4705
1 15/16	49.2	9	228.6	6 7/8	174.6	PA2031	2 23/32	69.1	2 17/32	64.3	1 1/2	38.1	PA4891
1 31/32	50.0	4 23/32	119.9	1 31/32	50.0	PA3959	2 23/32	69.1	4 31/32	126.2	2 5/16	58.7	PA4737
1 31/32	50.0	7	177.8	6 3/4	171.5	PA4187	2 23/32	69.1	6 25/32	172.2	-	-	PA4026
2	50.8	3 17/32	89.7	2	50.8	PA1834	2 23/32	69.1	8 19/32	218.3	-	-	PA2171
2	50.8	6 7/8	174.6	5 1/8	130.2	PA1814	2 3/4	69.9	2 3/4	69.9	1 1/4	31.8	PA2225
2	50.8	12 7/16	315.9	9 3/8	238.1	PA2065	2 3/4	69.9	3 7/8	98.4	2 11/32	59.5	PA697
2 1/32	51.6	4	101.6	2 3/4	69.9	PA1661(3)	2 3/4	69.9	6 23/32	170.7	2 3/8	60.3	PA2862
2 1/16	52.4	3 1/4	82.6	1 15/16	49.2	PA30035	2 3/4	69.9	7 7/16	188.9	5 1/2	139.7	PA3628
2 1/16	52.4	3 7/16	87.3	2 3/8	60.3	PA1757	2 3/4	69.9	10 1/16	255.6	4 9/32	108.7	PA2037
2 1/16	52.4	6 5/8	168.3	5	127.0	PA2050	2 3/4	69.9	12 3/4	323.9	11	279.4	PA2010
2 3/32	53.2	3 15/16	100.0	2 23/32	69.1	PA4830	2 25/32	70.6	2 3/4	69.9	1 1/4	31.8	PA4556
2 3/32	53.2	9 11/16	246.1	7 15/16	201.6	PA2114	2 25/32	70.6	5 31/32	151.6	3 15/32	88.1	PA2072
2 1/8	54.0	3 3/4	95.3	2 1/32	51.6	PA1666	2 25/32	70.6	13 9/32	337.3	11 9/32	286.5	PA2002
2 1/8	54.0	7 29/32	200.8	6 1/2	165.1	PA2063	2 13/16	71.4	3 5/16	84.1	2 3/8	60.3	PA4872
2 1/8	54.0	11 13/16	300.0	9 13/16	249.2	PA1802	2 13/16	71.4	3 15/32	88.1	1 9/16	39.7	PA3412
2 5/32	54.8	3 25/32	96.0	2 1/32	51.6	PA4873	2 13/16	71.4	9 11/16	246.1	8 3/16	208.0	PA2106
2 5/32	54.8	5 3/4	146.1	3 1/2	88.9	PA2053	2 27/32	72.2	3 5/8	92.1	1 31/32	50.0	PA2476
2 3/16	55.6	2 15/16	74.6	1 15/16	49.2	PA1915	2 7/8	73.0	1 23/32	43.7	7/8	22.2	PA4777
2 3/16	55.6	9 3/8	238.1	-	-	PA5418	2 7/8	73.0	3 13/16	96.8	1 5/16	33.3	PA2224
2 3/16	55.6	10 7/8	276.2	9	228.6	PA2005	2 7/8	73.0	4 5/32	105.6	2 15/32	62.7	PA5311
2 3/16	55.6	11 3/32	281.8	8 1/2	215.9	PA2075	2 7/8	73.0	5 7/8	149.2	3 7/16	87.3	PA3419
2 3/16	55.6	18 5/16	465.1	14 15/16	379.4	PA631	2 29/32	73.8	3 5/32	80.1	-	-	PA30153
2 7/32	56.4	3 1/32	77.0	1 15/32	37.3	BT8429	2 29/32	73.8	3 7/8	98.4	2 3/8	60.3	PA4708
2 7/32	56.4	13 9/32	337.3	11 9/32	286.5	PA1828	2 29/32	73.8	12 15/16	328.6	9 9/16	242.9	PA5689
2 1/4	57.2	6 29/32	175.4	5 9/16	141.3	PA2226	2 15/16	74.6	4 11/32	110.3	2 7/16	61.9	PA4733
2 1/4	57.2	8 11/16	220.7	5 29/32	145.3	PA4893	2 15/16	74.6	6 15/16	176.2	5 9/16	141.3	PA5737 KIT
2 1/4	57.2	9 11/16	246.1	7 15/16	201.6	PA642	2 15/16	74.6	7 13/16	198.4	5 7/8	149.2	PA5724
2 1/4	57.2	9 23/32	246.9	6 7/8	177.6	PA2125	2 15/16	74.6	9 11/16	246.1	7 1/2	190.5	PA2154
2 1/4	57.2	10 1/32	254.8	8 17/32	216.7	PA2077	3	76.2	3	76.2	1 5/8	41.3	PA1985
2 5/16	58.7	2 7/32	56.4	1 1/32	26.2	PA1763	3	76.2	6 5/8	168.3	5	127.0	PA634
2 5/16	58.7	5 1/2	139.7	3 1/4	82.6	PA1832	3	76.2	6 21/32	169.1	4 3/32	104.0	PA1648
2 3/8	60.3	3 17/32	89.7	2 7/16	61.9	PA4727	3	76.2	6 31/32	177.0	5 19/32	142.1	PA3901
2 3/8	60.3	4 1/4	108.0	2 1/4	57.2	PA4829	3	76.2	7 7/8	200.0	4 1/8	104.8	PA1889
2 3/8	60.3	4 13/32	111.9	2 15/16	74.6	PA1712	3	76.2	8 1/4	209.6	6 1/2	165.1	PA650
2 3/8	60.3	6 11/16	169.9	4 15/16	125.4	PA2036	3	76.2	9 3/4	247.7	7 15/16	201.6	PA648



WARNING: These products can expose you to chemicals, including Diisononyl Phthalate, Carbon black extracts, Nickel, 1,3 Butadiene, Ethylene Oxide, Epichlorohydrin, which are known to the State of California to cause cancer, and Bisphenol-A, Ethylene Glycol, Ethylene Oxide, 1,3 Butadiene, Epichlorohydrin, which are known to the State of California to cause birth defects or other reproductive harm. For more information go to www.P65Warnings.ca.gov.

ROUND AIR FILTERS BY LENGTH

LENGTH Inches	LENGTH (mm)	O.D. Inches	O.D. (mm)	I.D. Inches	I.D. (mm)	BALDWIN NUMBER	LENGTH Inches	LENGTH (mm)	O.D. Inches	O.D. (mm)	I.D. Inches	I.D. (mm)	BALDWIN NUMBER
3	76.2	10 1/32	254.8	8 17/32	216.7	PA621	4	101.6	13 7/8	352.4	11 5/8	295.3	PA2079
3	76.2	12 15/16	328.6	10 7/16	265.1	PA1786	4 1/32	102.4	4 5/32	105.6	1 1/4	31.8	PA3983-FN
3	76.2	13 7/8	352.4	11 5/8	295.3	PA1758	4 1/32	102.4	7 13/32	188.8	4 11/32	110.3	PA10020
3 1/32	77.0	6 7/32	158.0	4 27/32	123.0	PA2023	4 1/16	103.2	6	152.4	4 5/8	117.5	PA2064
3 1/32	77.0	6 11/32	161.1	4 5/32	105.6	PA1805	4 1/16	103.2	7 3/16	182.6	3 15/16	100.0	PA3773
3 1/16	77.8	6 13/16	173.0	5 1/16	128.6	PA699	4 1/16	103.2	9 23/32	246.9	7 5/16	185.7	PA4743
3 1/16	77.8	11 5/16	287.3	8 9/16	217.5	PA625	4 3/32	104.0	3 7/8	98.4	2 3/8	60.3	PA4900
3 3/32	78.6	4 15/32	113.5	2	50.8	PA4902	4 1/8	104.8	3 11/16	93.7	2 3/16	55.6	PA1748
3 1/8	79.4	3 3/32	78.6	2 9/32	57.9	PA4883	4 1/8	104.8	4 3/16	106.4	1 15/16	49.2	PA1858
3 1/8	79.4	3 31/32	100.8	2 21/32	67.5	PA4758	4 1/8	104.8	5 3/4	146.1	4 1/4	108.0	PA1857
3 1/8	79.4	5 3/8	136.5	3 13/16	96.8	PA649	4 1/8	104.8	6 13/32	162.7	3 1/32	77.0	PA2182
3 1/8	79.4	5 23/32	145.3	3 1/16	77.8	PA1973	4 5/32	105.6	4 7/32	107.2	2 1/32	51.6	PA4764
3 1/8	79.4	6	152.4	4 5/8	117.5	PA2067	4 3/16	106.4	3 9/16	90.5	2 1/8	54.0	PA1859
3 1/8	79.4	10 1/8	257.2	7 1/2	190.5	PA1841	4 3/16	106.4	3 13/16	96.8	1 31/32	50.0	PA4732
3 5/32	80.2	2 23/32	69.1	1 5/16	33.3	PA4895	4 3/16	106.4	7 7/8	200.0	4 5/8	117.5	PA30028
3 5/32	80.2	4	101.6	2 3/4	69.9	PA4557	4 3/16	106.4	7 15/16	201.6	6 9/32	159.5	PA1860
3 3/16	81.0	6 21/32	169.1	5 3/32	129.4	PA30011	4 3/16	106.4	8 1/32	204.0	5 5/16	134.9	PA2100
3 7/32	81.8	4 5/32	105.6	2 13/16	71.4	PA4823	4 3/16	106.4	13 23/32	348.5	11 5/8	295.3	PA4711
3 1/4	82.6	5 11/16	144.5	2	50.8	PA1951	4 9/32	108.7	6 1/2	165.1	3 1/2	88.9	PA1852
3 1/4	82.6	8 13/32	213.5	6 19/32	167.5	PA657	4 5/16	109.5	4 1/2	114.3	3 1/16	77.8	PA30020
3 1/4	82.6	9	228.6	6 1/2	165.1	PA2107	4 5/16	109.5	12 5/8	320.7	8 17/32	216.7	PA2878
3 1/4	82.6	10 1/4	260.4	7 5/8	193.7	PA607	4 11/32	110.3	11 7/8	301.6	7 1/2	190.5	PA2337
3 9/32	83.3	4 21/32	118.3	2 3/4	69.9	PA4763	4 3/8	111.1	8 1/2	215.9	3	76.2	PA2817
3 9/32	83.3	5 1/2	139.7	3 1/4	82.6	PA4166	4 13/32	111.9	7 9/32	184.9	4 21/32	118.3	PA2215
3 9/32	83.3	7 27/32	199.2	4 27/32	123.0	PA5563	4 13/32	111.9	12	304.8	8 19/32	218.3	PA4005
3 5/16	84.1	4 1/4	108.0	3	76.2	PA675	4 7/16	112.7	5 1/32	127.8	2 27/32	72.2	PA4930
3 5/16	84.1	7 3/8	187.3	5 3/16	131.8	PA30025	4 7/16	112.7	7	177.8	4 7/8	123.8	PA680
3 5/16	84.1	8 17/32	216.7	4 3/8	111.1	PA2479	4 1/2	114.3	3 17/32	89.7	1 17/32	38.9	PA4158
3 11/32	84.9	5 1/16	128.6	3 7/16	87.3	PA4810	4 1/2	114.3	5 1/16	128.6	3 1/16	77.8	PA2044
3 3/8	85.7	11 5/16	287.3	8 9/16	217.5	PA2081	4 1/2	114.3	5 1/2	139.7	3 1/4	82.6	PA1718
3 15/32	88.1	3 15/32	88.1	31/32	24.6	PA2798	4 9/16	115.9	12 1/4	311.2	8 5/8	219.1	PA3413
3 15/32	88.1	9 1/2	241.3	6 11/32	161.1	PA4707	4 19/32	116.7	3	76.2	1 21/32	42.1	PA4878
3 15/32	88.1	11 13/16	300.0	9 13/16	249.2	PA2008	4 5/8	117.5	7	177.8	4 7/8	123.8	PA1891
3 1/2	88.9	3 7/16	87.3	2 3/8	60.3	PA1875	4 5/8	117.5	9 3/8	238.1	7 9/16	192.1	PA30013
3 1/2	88.9	7 3/8	187.3	4 5/16	109.5	PA2167	4 23/32	119.9	5 1/2	139.7	3 1/4	82.6	PA2001
3 1/2	88.9	8	203.2	5 3/4	146.1	PA612	4 3/4	120.7	4 1/4	108.0	1 5/8	41.3	PA1633
3 1/2	88.9	12 3/4	323.9	11	279.4	PA693	4 3/4	120.7	4 13/32	111.9	2 15/16	74.6	PA2335
3 17/32	89.7	10 7/8	276.2	9	228.6	PA2052	4 3/4	120.7	8 1/16	204.8	5 25/32	146.8	PA30027
3 9/16	90.5	9 21/32	245.3	8 1/4	209.6	PA1680	4 3/4	120.7	9 15/32	240.5	4 11/32	110.3	PA4641
3 19/32	91.3	3 31/32	100.8			PT23535	4 25/32	121.4	4 13/32	111.9	3 1/32	77.0	PA2038
3 5/8	92.1	3 1/16	77.8	1 9/16	39.7	PA644	4 25/32	121.4	6 5/16	160.3	4 1/2	114.3	PA4713
3 5/8	92.1	5 29/32	150.0	3 13/32	86.5	PA4741	4 13/16	122.2	2 1/4	57.2	1 3/4	44.5	CV15001
3 5/8	92.1	9 1/16	230.2	6 3/4	171.5	PA602	4 13/16	122.2	7 13/16	198.4	4 1/16	103.2	PA2919
3 21/32	92.9	3 1/4	82.6	1 31/32	50.0	PA30034	4 13/16	122.2	8 5/8	219.1	4 5/16	109.5	PA4649
3 21/32	92.9	6 1/2	165.1	3 15/32	88.1	PA3941	4 27/32	123.0	5 1/2	139.7	3 1/8	79.4	PA2978
3 21/32	92.9	6 1/2	165.1	3 1/2	88.9	PA3970	4 27/32	123.0	5 11/16	144.5	3 9/16	90.5	PA3457
3 11/16	93.7	4 5/16	109.5	2 7/8	73.0	PA1697	4 27/32	123.0	6 5/8	168.3	4 23/32	119.9	PA4389
3 11/16	93.7	5	127.0	3 9/16	90.5	PA1696	4 27/32	123.0	7 7/8	200.0	4 1/8	104.8	PA4072
3 11/16	93.7	9 3/4	247.7	6 1/16	154.0	PA1861	4 15/16	125.4	5	127.0	2 17/32	72.2	PA4706
3 3/4	95.3	3 1/8	79.4	1 1/2	38.1	PA1679	4 15/16	125.4	5 3/8	136.5	3 13/16	96.8	PA2162
3 3/4	95.3	4 1/4	108.0	2	50.8	PA2223	4 15/16	125.4	5 3/4	146.1	3 1/2	88.9	PA2134
3 3/4	95.3	9 9/16	242.9	7 1/4	184.2	PA2984	4 31/32	126.2	5 29/32	150.0	3 15/32	88.1	PA4715
3 13/16	96.8	7 15/16	201.6	4 31/32	126.2	PA4781	5	127.0	4 13/32	111.9	2 15/16	74.6	PA1639
3 13/16	96.8	8 1/4	209.6	6 13/32	162.7	PA3967	5	127.0	6 5/16	160.3	3 11/16	93.7	PA1963
3 7/8	98.4	6	152.4	4 5/8	117.5	PA652	5	127.0	7	177.8	3 21/32	92.9	PA2858
3 7/8	98.4	9 1/16	230.2	6 3/4	171.5	PA604	5	127.0	10 7/32	259.6	5 1/2	139.7	PA1619
3 15/16	100.0	3 1/4	82.6	2	50.8	PA1688	5	127.0	11 7/16	290.5	8 5/8	219.1	PA2092
3 15/16	100.0	7 31/32	202.4	3 27/32	97.6	PA5664	5	127.0	11 7/16	290.5	8 5/8	219.1	PA2115
3 15/16	100.0	8 1/4	209.6	5 7/8	149.2	PA1719	5	127.0	12 5/8	320.7	9 3/4	247.7	PA2061
3 31/32	100.8	5 3/4	146.1	3 1/2	88.9	PA2153	5 1/32	127.8	10 27/32	275.4	6 1/2	165.1	PA2699
4	101.6	5 15/16	150.8	3 1/4	82.6	PA669	5 1/8	130.2	6 11/16	169.9	2 5/8	66.7	PA2576
4	101.6	7 7/8	200.0	4 1/8	104.8	PA1949	5 1/8	130.2	9 3/8	238.1	4 21/32	118.3	PA3919
4	101.6	8 1/16	204.8	5 3/4	146.1	PA662	5 3/16	131.8	3 7/16	87.3	31/32	24.6	PA3679
4	101.6	8 1/16	204.8	5 3/4	146.1	PA1698	5 3/16	131.8	4 3/32	104.0	1 13/32	35.7	PA4819
4	101.6	8 7/32	208.8	5 15/16	150.8	PA4871	5 3/16	131.8	5 21/32	143.7	3 1/2	88.9	PA4814
4	101.6	9 3/4	247.7	7 1/4	184.2	PA2095	5 3/16	131.8	7 13/16	198.4	3 5/8	92.1	PA3797
4	101.6	10 7/32	259.6	5 1/2	139.7	PA1618	5 3/16	131.8	7 7/8	200.0	6 1/8	155.6	PA1873
4	101.6	13 7/8	352.4	11 5/8	295.3	PA2073	5 3/16	131.8	12 1/4	311.2	9 7/16	239.7	PA654



WARNING: These products can expose you to chemicals, including Diisononyl Phthalate, Carbon black extracts, Nickel, 1,3 Butadiene, Ethylene Oxide, Epichlorohydrin, which are known to the State of California to cause cancer, and Bisphenol-A, Ethylene Glycol, Ethylene Oxide, 1,3 Butadiene, Epichlorohydrin, which are known to the State of California to cause birth defects or other reproductive harm. For more information go to www.P65Warnings.ca.gov.

ROUND AIR FILTERS BY LENGTH

LENGTH Inches	LENGTH (mm)	O.D. Inches	O.D. (mm)	I.D. Inches	I.D. (mm)	BALDWIN NUMBER	LENGTH Inches	LENGTH (mm)	O.D. Inches	O.D. (mm)	I.D. Inches	I.D. (mm)	BALDWIN NUMBER
5 7/32.....	132.6	5 1/8.....	130.2	3 3/8.....	85.7	PA2139	6 5/8.....	168.3	1 11/16.....	42.9	1 3/16.....	30.2	RS3930
5 1/4.....	133.4	2 31/32.....	75.4	1 21/32.....	42.1	PA4939	6 5/8.....	168.3	4 3/32.....	104.0	2 15/32.....	62.7	PA5579
5 1/4.....	133.4	6 7/8.....	174.6	4 3/16.....	106.4	PA2404	6 5/8.....	168.3	8 5/32.....	207.2	4 3/16.....	106.4	RS3528
5 5/16.....	134.9	4 5/8.....	117.5	2 5/8.....	66.7	PA30015	6 5/8.....	168.3	9 1/8.....	231.8	6 7/8.....	174.6	PA638
5 5/16.....	134.9	5.....	127.0	3 9/16.....	90.5	PA2140	6 21/32.....	169.1	4 1/4.....	108.0	2 3/4.....	69.9	RS3537
5 5/16.....	134.9	8 9/16.....	217.5	2 1/2.....	63.5	PA2825	6 11/16.....	169.9	4 31/32.....	126.2	3 11/32.....	84.9	PA2099
5 11/32.....	135.7	6 5/8.....	168.3	2.....	50.8	PA2823	6 11/16.....	169.9	6 15/32.....	164.3	2 15/32.....	62.7	PA5444-FN
5 3/8.....	136.5	5 1/2.....	139.7	1 3/4.....	44.5	PA4619	6 23/32.....	170.7	5 1/4.....	133.4	2 27/32.....	72.2	PA2536
5 13/32.....	137.3	6 11/16.....	169.9	2 11/32.....	59.5	PA2730	6 3/4.....	171.5	8 1/2.....	215.9	4 5/8.....	117.5	RS10035
5 13/32.....	137.3	9 3/4.....	247.7	6 1/16.....	154.0	PA1916	6 25/32.....	172.2	3 11/16.....	93.7	1 11/16.....	42.9	PA3757
5 7/16.....	138.1	6 5/8.....	168.3	4 1/4.....	108.0	PA2725	6 25/32.....	172.2	5 3/16.....	131.8	2 5/8.....	66.7	PA2912
5 7/16.....	138.1	11 13/16.....	300.0	9 13/16.....	249.2	PA2091	6 13/16.....	173.0	5.....	127.0	3 9/16.....	90.5	PA2193
5 7/16.....	138.1	11 13/16.....	300.0	9 13/16.....	249.2	PA2148	6 27/32.....	173.6	5 7/16.....	138.1	3 5/32.....	80.2	RS4189
5 1/2.....	139.7	6 15/32.....	164.3	3.....	76.2	PA4897	6 7/8.....	174.6	5 3/8.....	136.5	3 15/16.....	100.0	PA3654
5 1/2.....	139.7	7 7/16.....	188.9	4 9/32.....	108.7	PA2156	6 29/32.....	175.4	13 7/8.....	352.4	7 7/16.....	188.9	PA2343
5 1/2.....	139.7	12 19/32.....	319.9	8 9/32.....	210.3	PA2483	6 15/16.....	176.2	3 17/32.....	89.7	1 25/32.....	45.2	PA4632
5 1/2.....	139.7	12 5/8.....	320.7	9 3/4.....	247.7	PA2472	6 15/16.....	176.2	3 3/4.....	95.3	1 21/32.....	42.1	RS4804
5 9/16.....	141.3	11 5/16.....	287.3	8 9/16.....	217.5	PA1798	6 15/16.....	176.2	5 11/32.....	135.7	3 5/32.....	80.2	RS10005
5 9/16.....	141.3	12.....	304.8	8 9/16.....	217.5	PA1800	6 15/16.....	176.2	12 1/8.....	308.0	8 3/8.....	212.7	PA2179
5 19/32.....	142.1	6 3/16.....	157.2	4 13/16.....	122.2	PA4813	6 31/32.....	177.0	2 3/4.....	69.9	1 31/32.....	50.0	PA3812
5 5/8.....	142.9	7 1/32.....	178.6	5 7/16.....	138.1	PA4848	6 31/32.....	177.0	3 17/32.....	89.7	2 13/32.....	61.1	PA3819
5 11/16.....	144.5	7 17/32.....	191.3	3 5/16.....	84.1	PA3863	6 31/32.....	177.0	6 5/16.....	160.3	3 29/32.....	99.2	PA3836
5 11/16.....	144.5	7 11/16.....	195.3	3 5/16.....	84.1	PA4615	7.....	177.8	3 17/32.....	89.7	1 17/32.....	38.9	RS5273
5 11/16.....	144.5	8 5/8.....	219.1	4 9/32.....	108.7	PA4648	7.....	177.8	3 17/32.....	89.7	1 3/4.....	44.5	RS3715
5 23/32.....	145.3	8 29/32.....	226.2	4 9/32.....	108.7	PA2042	7.....	177.8	6 7/8.....	174.6	5 1/8.....	130.2	PA1653
5 3/4.....	146.1	4 3/16.....	106.4	1 15/16.....	49.2	PA1946	7.....	177.8	8 7/16.....	214.3	6 1/2.....	165.1	PA30075
5 3/4.....	146.1	4 13/32.....	111.9	2 15/16.....	74.6	PA2083	7.....	177.8	8 19/32.....	218.3	7 19/32.....	192.9	PA3958
5 3/4.....	146.1	7 3/4.....	196.9	3 1/4.....	82.6	PA4647	7.....	177.8	11 7/16.....	290.5	8 5/8.....	219.1	PA2116
5 13/16.....	147.6	4 1/8.....	104.8	1 7/32.....	31.0	PA3880	7.....	177.8	11 11/16.....	296.9	7 25/32.....	197.6	PA2328
5 13/16.....	147.6	6 7/8.....	174.6	5 1/8.....	130.2	PA2102	7 1/32.....	178.6	3 7/8.....	98.4	3 3/16.....	81.0	PA3909
5 27/32.....	148.4	4 1/4.....	108.0	2 3/4.....	69.9	RS3529	7 1/32.....	178.6	4 13/32.....	111.9	2 15/16.....	74.6	PA640
5 27/32.....	148.4	8 3/8.....	212.7	4.....	101.6	LL2575	7 1/16.....	179.4	3 5/8.....	92.1	2 5/16.....	58.7	PA30101
5 27/32.....	148.4	8 3/8.....	212.7	4.....	101.6	PA2575	7 1/8.....	181.0	8 1/8.....	206.4	3 25/32.....	96.0	PA2763
5 7/8.....	149.2	4 1/2.....	114.3	1 1/2.....	38.1	PA2832	7 1/8.....	181.0	13.....	330.2	7 11/16.....	195.3	PA2403
5 7/8.....	149.2	4 19/32.....	116.7	1 5/8.....	41.3	PA3643	7 5/32.....	181.8	4 1/4.....	108.0	2 1/8.....	54.0	PA4665-FN
5 29/32.....	150.0	6 23/32.....	170.7	3 1/32.....	77.0	PA4089	7 3/16.....	182.6	2 1/8.....	54.0	1 11/16.....	42.9	PA30100
5 31/32.....	151.6	3 25/32.....	96.0	7/8.....	22.2	CV15003	7 3/16.....	182.6	4 1/2.....	114.3	2.....	50.8	PA3632
5 31/32.....	151.6	5 3/4.....	146.1	4 1/8.....	104.8	PA1721	7 7/32.....	183.4	9 1/8.....	231.8	6 7/8.....	174.6	PA651
5 31/32.....	151.6	8 3/4.....	222.3	4 3/32.....	104.0	PA3890	7 1/4.....	184.2	4 7/32.....	107.2	1 11/16.....	42.9	PA5324-FN
6.....	152.4	5 3/4.....	146.1	3 5/8.....	92.1	PA2136	7 1/4.....	184.2	4 1/4.....	108.0	1 27/32.....	46.8	PA1865-FN
6.....	152.4	7.....	177.8	4 3/8.....	111.1	PA1888	7 1/4.....	184.2	4 1/4.....	108.0	1 27/32.....	46.8	PA3895-FN
6.....	152.4	9 23/32.....	246.9	7 9/32.....	184.9	PA5665	7 1/4.....	184.2	5.....	127.0	1 27/32.....	46.8	PA3664-FN
6.....	152.4	10 7/32.....	259.6	5 1/2.....	139.7	PA671	7 1/4.....	184.2	6 27/32.....	173.8	3 3/4.....	95.3	RS5670
6.....	152.4	10 1/4.....	260.4	7 3/8.....	187.3	PA671-1	7 1/4.....	184.2	15 1/16.....	382.6	7 7/16.....	188.9	PA1995
6 1/32.....	153.2	5 1/8.....	130.2	2 15/32.....	62.7	PA4834-FN	7 9/32.....	184.9	6 3/32.....	154.8	3 15/32.....	88.1	PA2613
6 1/32.....	153.2	5 9/32.....	134.1	1 15/32.....	37.3	PA30068	7 5/16.....	185.7	4 3/32.....	104.0	2 15/32.....	62.7	PA1921
6 1/16.....	154.0	6 7/8.....	174.6	5 9/16.....	141.3	PA2340	7 5/16.....	185.7	10 9/16.....	268.3	4 1/4.....	108.0	PA2830
6 3/32.....	154.8	5.....	127.0	2 17/32.....	64.3	PA4716	7 5/16.....	185.7	12 3/8.....	314.3	7 3/16.....	182.6	PA2339
6 3/32.....	154.8	7 13/16.....	198.4	3 15/32.....	88.1	PA2589-FN	7 11/32.....	186.5	5.....	127.0	1 3/4.....	44.5	PA30063
6 1/8.....	155.6	4 3/16.....	106.4	1 15/16.....	49.2	PA1969	7 3/8.....	187.3	4 1/2.....	114.3	1 1/2.....	38.1	PA30036
6 1/8.....	155.6	6 3/32.....	154.8	3 15/32.....	88.1	PA2885	7 3/8.....	187.3	5 1/32.....	127.8	1 13/16.....	46.0	PA4833-FN
6 3/16.....	157.2	6 7/8.....	174.6	4 3/16.....	106.4	PA1996	7 3/8.....	187.3	9 31/32.....	253.2	4 31/32.....	126.2	PA3660-FN
6 7/32.....	158.0	6 1/8.....	155.6	3 3/8.....	85.7	PA4041	7 7/16.....	188.9	3 11/32.....	84.9	1 13/16.....	46.0	PA4934
6 1/4.....	158.8	2 5/32.....	54.8	1 17/32.....	38.9	PA4666	7 15/32.....	189.7	6 13/32.....	162.7	3 3/16.....	81.0	PA4071
6 1/4.....	158.8	3 1/8.....	79.4	1 17/32.....	38.9	PA3565	7 15/32.....	189.7	6 13/16.....	173.0	3 3/32.....	78.6	PA4088
6 1/4.....	158.8	5 1/32.....	127.8	3 5/32.....	80.2	RS4130	7 15/32.....	189.7	6 29/32.....	175.4	3 3/32.....	78.6	PA2240
6 9/32.....	159.5	4 3/32.....	104.0	2 1/4.....	57.2	PA30021	7 1/2.....	190.5	3 1/4.....	82.6	2 1/8.....	54.0	PA3472
6 9/32.....	159.5	9 5/16.....	236.5	-.....	-.....	CA5352	7 1/2.....	190.5	4 1/4.....	108.0	2 1/8.....	54.0	PA3472-FN
6 5/16.....	160.3	6 5/8.....	168.3	2 5/16.....	58.7	PA5326	7 1/2.....	190.5	8 5/32.....	207.2	4 3/16.....	106.4	RS3536
6 5/16.....	160.3	8 9/16.....	217.5	3 1/4.....	82.6	PA2827	7 1/2.....	190.5	8 27/32.....	224.6	5 15/32.....	138.9	PA2558
6 3/8.....	161.9	6.....	152.4	-.....	-.....	BA16000	7 1/2.....	190.5	10 7/32.....	259.6	7 7/8.....	200.0	PA1606
6 3/8.....	161.9	6 1/16.....	154.0	4.....	101.6	PA2884	7 1/2.....	190.5	10 27/32.....	275.4	6 1/2.....	165.1	PA2610
6 3/8.....	161.9	8 19/32.....	218.3	2 1/2.....	63.5	PA2828	7 1/2.....	190.5	13 27/32.....	351.6	11 1/8.....	282.6	PA1641
6 7/16.....	163.5	1 21/32.....	42.1	1 7/32.....	31.0	PA4633	7 1/2.....	190.5	13 7/8.....	352.4	7 7/16.....	188.9	PA2789
6 15/32.....	164.3	8 1/16.....	204.8	5 23/32.....	145.3	PA4877	7 1/2.....	190.5	16 1/8.....	409.6	7 7/16.....	188.9	PA2406
6 1/2.....	165.1	7 5/16.....	185.7	5 5/16.....	134.9	PA1689	7 17/32.....	191.3	3 11/32.....	84.9	2 27/32.....	72.2	PA3684
6 9/16.....	166.7	9 5/8.....	244.5	5.....	127.0	PA1866	7 9/16.....	192.1	8 1/8.....	206.4	4 7/32.....	107.2	PA4075
6 19/32.....	167.5	5 5/8.....	142.9	2 13/32.....	61.1	PA4118	7 5/8.....	193.7	8 1/16.....	204.8	5 3/4.....	146.1	PA655



WARNING: These products can expose you to chemicals, including Diisonylol Phthalate, Carbon black extracts, Nickel, 1,3 Butadiene, Ethylene Oxide, Epichlorohydrin, which are known to the State of California to cause cancer, and Bisphenol-A, Ethylene Glycol, Ethylene Oxide, 1,3 Butadiene, Epichlorohydrin, which are known to the State of California to cause birth defects or other reproductive harm. For more information go to www.P65Warnings.ca.gov.

ROUND AIR FILTERS BY LENGTH

LENGTH Inches	LENGTH (mm)	O.D. Inches	O.D. (mm)	I.D. Inches	I.D. (mm)	BALDWIN NUMBER	LENGTH Inches	LENGTH (mm)	O.D. Inches	O.D. (mm)	I.D. Inches	I.D. (mm)	BALDWIN NUMBER
7 21/32.....	194.5	4 5/32.....	105.6	2 29/32.....	73.8	PA3911	8 7/8.....	225.4	6 3/32.....	154.8	2 31/32.....	75.4	PA1787
7 11/16.....	195.3	6 1/8.....	155.6	3 3/8.....	85.7	PA5554	8 7/8.....	225.4	13 13/16.....	350.8	9 1/2.....	241.3	PA1896
7 11/16.....	195.3	10 1/16.....	255.6	7 9/16.....	192.1	PA3755	8 15/16.....	227.0	5 3/8.....	136.5	1 31/32.....	50.0	PA3758
7 23/32.....	196.1	5 1/8.....	130.2	2 15/32.....	62.7	PA2778-FN	8 31/32.....	227.8	4 3/8.....	111.1	1 15/16.....	49.2	PA3612
7 3/4.....	196.9	6.....	152.4	4.....	101.6	PA3908	9.....	228.6	6 5/8.....	168.3	4 1/4.....	108.0	LL1608
7 3/4.....	196.9	6 3/32.....	154.8	3 15/32.....	88.1	PA4328	9.....	228.6	6 5/8.....	168.3	4 1/4.....	108.0	PA1608
7 25/32.....	197.6	4 3/32.....	104.0	2 15/32.....	62.7	PA3795	9.....	228.6	6 27/32.....	173.8	4 3/16.....	106.4	PA2932
7 13/16.....	198.4	8 9/16.....	217.5	2 1/2.....	63.5	PA2826	9.....	228.6	7 1/2.....	190.5	5 1/4.....	133.4	PA1957
7 27/32.....	199.2	2 1/8.....	54.0	1 5/16.....	33.3	PA4896	9.....	228.6	8 1/4.....	209.6	5 3/4.....	146.1	PA1613
7 27/32.....	199.2	2 17/32.....	64.3	1 1/2.....	38.1	PA4720	9.....	228.6	8 1/4.....	209.6	5 3/4.....	146.1	PA1613-S
7 27/32.....	199.2	3 5/32.....	80.2	2 13/32.....	61.1	PA3682	9.....	228.6	10 7/32.....	259.6	6 1/16.....	154.0	LL1621-2
7 27/32.....	199.2	10 7/32.....	259.6	6 1/16.....	154.0	PA1620-S	9.....	228.6	10 7/32.....	259.6	6 1/16.....	154.0	PA1621-2
7 7/8.....	200.0	6 3/32.....	154.8	3 15/32.....	88.1	PA2904	9.....	228.6	10 7/32.....	259.6	7 7/8.....	200.0	PA1621
7 7/8.....	200.0	6 5/8.....	168.3	4 1/4.....	108.0	PA641	9.....	228.6	10 7/32.....	259.6	7 7/8.....	200.0	PA1621-S
7 7/8.....	200.0	6 5/8.....	168.3	4 1/4.....	108.0	PA1602	9.....	228.6	12 3/4.....	323.9	8 11/32.....	211.9	PA2438
7 7/8.....	200.0	7 13/16.....	198.4	3 15/32.....	88.1	PA3406-FN	9 1/32.....	229.4	2 3/4.....	69.9	2.....	50.8	PA4740
8.....	203.2	2 23/32.....	69.1	1 31/32.....	50.0	PA2889	9 1/32.....	229.4	3 5/32.....	80.2	2 5/32.....	54.8	PA4548
8.....	203.2	5 1/4.....	133.4	2 5/8.....	66.7	PA1635	9 1/32.....	229.4	3 25/32.....	96.0	2 7/8.....	73.0	PA3950
8.....	203.2	5 31/32.....	151.6	3 7/32.....	81.8	RS4161	9 1/32.....	229.4	5 29/32.....	150.0	2 13/16.....	71.4	PA3753
8.....	203.2	12 1/32.....	305.6	6 23/32.....	170.7	PA2599	9 1/32.....	229.4	6 1/16.....	154.0	3 1/2.....	88.9	PA2906
8.....	203.2	12 3/32.....	307.2	8 11/16.....	220.7	PA2596	9 1/32.....	229.4	9 5/16.....	236.5	4 27/32.....	123.0	PA2585
8 1/32.....	204.0	7 7/8.....	200.0	6 1/8.....	155.6	PA1934	9 1/32.....	229.4	13 5/32.....	334.2	5 1/4.....	133.4	PA4942
8 1/32.....	204.0	8 5/16.....	211.1	6 1/32.....	153.2	PA2958	9 1/16.....	230.2	4 5/32.....	105.6	2 7/8.....	73.0	PA2622
8 1/32.....	204.0	11 21/32.....	296.1	-.....	-.....	CA5420	9 1/16.....	230.2	9 5/8.....	244.5	7 1/2.....	190.5	PA4832
8 1/32.....	204.0	12 25/32.....	324.6	-.....	-.....	CA4700	9 3/32.....	231.0	2 9/16.....	65.1	2 1/16.....	52.4	PA4658
8 1/32.....	204.0	14 7/8.....	377.8	-.....	-.....	CA5368	9 3/32.....	231.0	3 5/16.....	81.0	2 3/8.....	60.3	RS30078
8 1/32.....	204.0	14 7/8.....	377.8	-.....	-.....	CA5419	9 3/32.....	231.0	3 17/32.....	89.7	2 7/16.....	61.9	PA3817
8 1/32.....	204.0	17 5/8.....	447.7	11 1/32.....	280.2	PA2399	9 3/32.....	231.0	3 5/8.....	92.1	2 13/32.....	61.1	PA2717
8 1/16.....	204.8	5 1/16.....	128.6	1 1/4.....	31.8	CV15005	9 3/32.....	231.0	6 3/32.....	154.8	2 5/16.....	58.7	PA3833
8 1/16.....	204.8	8 3/4.....	222.3	6 1/16.....	154.0	PA3653	9 1/8.....	231.8	2 7/16.....	61.9	1 15/16.....	49.2	PA2861
8 1/16.....	204.8	9 5/8.....	244.5	5.....	127.0	PA1867	9 1/8.....	231.8	5 7/8.....	149.2	3 7/32.....	81.8	PA5567
8 1/16.....	204.8	12.....	304.8	4 15/16.....	125.4	PA2548	9 1/8.....	231.8	5 31/32.....	151.6	2 7/32.....	56.4	PA3651-FN
8 3/32.....	205.6	14 27/32.....	377.0	-.....	-.....	CA30131	9 1/8.....	231.8	9 29/32.....	251.6	-.....	-.....	CA5417
8 1/8.....	206.4	2 29/32.....	73.8	2 3/8.....	60.3	PA2748	9 1/4.....	235.0	4 3/32.....	104.0	3.....	76.2	PA3601
8 3/16.....	208.0	10 7/32.....	259.6	5 1/2.....	139.7	PA1620	9 1/4.....	235.0	4 15/16.....	125.4	2 3/4.....	69.9	PA4903
8 3/16.....	208.0	12 1/32.....	305.6	-.....	-.....	CA5421	9 1/4.....	235.0	7.....	177.8	4 3/8.....	111.1	PA1769
8 1/4.....	209.6	2 15/16.....	74.6	1 7/8.....	47.6	PA2702	9 9/32.....	235.7	6 5/8.....	168.3	4 1/4.....	108.0	PA2592
8 1/4.....	209.6	6 15/32.....	164.3	3 11/32.....	84.9	PA2422	9 5/16.....	236.5	5 1/8.....	130.2	2 15/32.....	62.7	PA1907-FN
8 9/32.....	210.3	7 7/8.....	200.0	3 15/32.....	88.1	PA3411-FN	9 5/16.....	236.5	6 3/8.....	161.9	3 15/16.....	100.0	PA3837
8 5/16.....	211.1	6 3/16.....	156.7	2 3/4.....	69.9	RS4450	9 5/16.....	236.5	8 3/8.....	212.7	3 15/32.....	88.1	PA3910-FN
8 5/16.....	211.1	9 7/32.....	234.2	4 27/32.....	123.0	PA1922	9 5/16.....	236.5	9 1/16.....	230.2	4 15/16.....	125.4	PA1987
8 5/16.....	211.1	11 5/8.....	295.3	4 27/32.....	123.0	PA1922-FN	9 11/32.....	237.3	4 19/32.....	116.7	2 15/32.....	62.7	PA2890
8 11/32.....	211.9	2 19/32.....	65.9	1 21/32.....	42.1	PA4867	9 11/32.....	237.3	5 3/4.....	146.1	3 1/32.....	77.0	PA2701
8 3/8.....	212.7	5 1/8.....	130.2	2 15/32.....	62.7	PA3557-FN	9 11/32.....	237.3	6 3/8.....	161.9	3 11/16.....	93.7	PA4693
8 3/8.....	212.7	5 1/2.....	139.7	1 3/4.....	44.5	PA2807	9 3/8.....	238.1	4 3/32.....	104.0	2 15/32.....	62.7	PA1821
8 3/8.....	212.7	5 1/2.....	139.7	1 3/4.....	44.5	PA2822	9 3/8.....	238.1	6 3/8.....	161.9	2 5/8.....	66.7	PA1752-FN
8 3/8.....	212.7	6 7/8.....	174.6	4 3/16.....	106.4	PA2446	9 3/8.....	238.1	6 15/32.....	164.3	3 11/32.....	84.9	PA2772
8 3/8.....	212.7	10 19/32.....	269.1	6.....	152.4	PA5491	9 3/8.....	238.1	10 1/16.....	255.6	3 9/16.....	90.5	PA1919-FN
8 13/32.....	213.5	5 21/32.....	143.7	2 15/32.....	62.7	PA3811-FN	9 3/8.....	238.1	13 3/4.....	349.3	6 3/4.....	171.5	PA1956-FN
8 15/32.....	215.1	4 1/2.....	114.3	2.....	50.8	PA2535	9 13/32.....	238.9	2 1/4.....	57.2	1 5/8.....	41.3	RS3991
8 15/32.....	215.1	6 3/8.....	161.9	2 5/8.....	66.7	PA2860-FN	9 13/32.....	238.9	5.....	127.0	2 11/16.....	68.3	PA4866
8 15/32.....	215.1	7 15/16.....	201.6	4 31/32.....	126.2	PA2895	9 7/16.....	239.7	12.....	304.8	4 15/16.....	125.4	PA2379
8 1/2.....	215.9	6 7/8.....	174.6	2 25/32.....	70.6	PA4614	9 7/16.....	239.7	12.....	304.8	4 15/16.....	125.4	PA2379-K
8 1/2.....	215.9	12 1/32.....	305.6	7 11/16.....	195.3	PA2473	9 1/2.....	241.3	4 1/2.....	114.3	3 9/16.....	90.5	RS5550
8 1/2.....	215.9	13 3/4.....	349.3	6 23/32.....	170.7	PA1892-FN	9 1/2.....	241.3	6 1/8.....	155.6	3 15/32.....	88.1	PA5752
8 9/16.....	217.5	6.....	152.4	4 5/8.....	117.5	PA653	9 1/2.....	241.3	6 3/8.....	161.9	2 27/32.....	72.2	PA2949-FN
8 19/32.....	218.3	4 1/2.....	114.3	2 5/8.....	66.7	PA4388	9 1/2.....	241.3	6 7/8.....	174.6	4 3/16.....	106.4	PA2740
8 5/8.....	219.1	5 27/32.....	148.4	3 5/8.....	92.1	PA4173	9 1/2.....	241.3	10 3/8.....	263.5	6 1/32.....	153.2	LL2557
8 5/8.....	219.1	6.....	152.4	3 1/2.....	88.9	PA1901	9 1/2.....	241.3	10 3/8.....	263.5	6 1/32.....	153.2	PA2557
8 5/8.....	219.1	6 25/32.....	172.2	2 13/16.....	71.4	PA3818-FN	9 1/2.....	241.3	13 7/8.....	352.4	7 7/16.....	188.9	PA2445
8 5/8.....	219.1	12 5/8.....	320.7	8 13/32.....	213.5	PA2552	9 17/32.....	242.1	3 1/4.....	82.6	2 1/8.....	54.0	PA3674
8 11/16.....	220.7	9 29/32.....	251.6	4 1/16.....	103.2	PA3807	9 9/16.....	242.9	5 3/16.....	131.8	3 31/32.....	100.8	PA3783
8 25/32.....	223.0	10 1/4.....	260.4	6.....	152.4	PA1817	9 9/16.....	242.9	7 15/16.....	201.6	4 5/8.....	117.5	PA2183
8 13/16.....	223.8	3 7/8.....	98.4	3 7/32.....	81.8	PA3973	9 19/32.....	243.7	4 7/32.....	107.2	2 5/32.....	54.8	RS4803
8 13/16.....	223.8	6 1/8.....	155.6	3 3/8.....	85.7	PA5555	9 19/32.....	243.7	6 3/32.....	154.8	3 15/32.....	88.1	PA2913
8 27/32.....	224.6	6 5/8.....	168.3	2.....	50.8	PA2824	9 5/8.....	244.5	5 15/16.....	150.8	4 27/32.....	123.0	PA2586
8 27/32.....	224.6	9 21/32.....	245.3	5 7/32.....	132.6	PA4610 KIT	9 5/8.....	244.5	6 3/32.....	154.8	4 3/32.....	104.0	PA3972
8 7/8.....	225.4	2 3/8.....	60.3	2.....	50.8	PA5437	9 5/8.....	244.5	8 1/4.....	209.6	4 9/16.....	115.9	PA30067



WARNING: These products can expose you to chemicals, including Diisononyl Phthalate, Carbon black extracts, Nickel, 1,3 Butadiene, Ethylene Oxide, Epichlorohydrin, which are known to the State of California to cause cancer, and Bisphenol-A, Ethylene Glycol, Ethylene Oxide, 1,3 Butadiene, Epichlorohydrin, which are known to the State of California to cause birth defects or other reproductive harm. For more information go to www.P65Warnings.ca.gov.

ROUND AIR FILTERS BY LENGTH

LENGTH Inches	LENGTH (mm)	O.D. Inches	O.D. (mm)	I.D. Inches	I.D. (mm)	BALDWIN NUMBER	LENGTH Inches	LENGTH (mm)	O.D. Inches	O.D. (mm)	I.D. Inches	I.D. (mm)	BALDWIN NUMBER
9 21/32	245.3	8 15/32	215.1	6 3/16	157.2	PA30026	10 3/8	263.5	5 3/4	146.1	2 1/2	63.5	PA4651
9 11/16	246.1	8 11/32	211.9	3 7/8	98.4	PA1700	10 3/8	263.5	5 7/8	149.2	2 15/32	62.7	PA4795
9 23/32	246.9	5 1/32	127.8	3 5/32	80.2	RS30077	10 3/8	263.5	5 31/32	151.6	4 27/32	123.0	PA2372
9 23/32	246.9	5 27/32	148.4	-	-	BA5372	10 3/8	263.5	6 3/32	154.8	3 15/32	88.1	PA2716
9 13/16	249.2	6 5/8	168.3	4 1/4	108.0	PA1664	10 3/8	263.5	6 1/2	165.1	2 1/4	57.2	PA4918
9 13/16	249.2	14 17/32	369.1	8 11/32	211.9	PA1816	10 3/8	263.5	7 5/16	185.7	3 1/2	88.9	PA1851
9 27/32	250.0	6 3/32	154.8	3 5/32	80.2	PA3856	10 3/8	263.5	9 13/16	249.2	3 9/16	90.5	PA2954-FN
9 27/32	250.0	8 9/16	217.5	-	-	PA2816	10 3/8	263.5	10 3/8	263.5	5 1/2	139.7	PA1789
9 7/8	250.8	2 11/32	59.5	1 7/8	47.6	PA1809	10 3/8	263.5	11 5/8	295.3	4 27/32	123.0	PA1750-FN
9 7/8	250.8	4 9/16	115.9	2 5/8	66.7	RS3990	10 3/8	263.5	12 1/32	305.6	7 11/16	195.3	PA1705-2
9 29/32	251.6	5	127.0	2	50.8	RS5387 KIT	10 3/8	263.5	12 3/8	314.3	4 15/16	125.4	PA1986-K
9 15/16	252.4	2 15/16	74.6	2 13/32	61.1	PA2514	10 3/8	263.5	13 3/4	349.3	6 3/4	171.5	PA1977-FN
9 15/16	252.4	4 3/32	104.0	2 1/2	63.5	PA3792	10 3/8	263.5	15 3/4	400.1	7 11/16	195.3	LL1980-FN
9 31/32	253.2	2 15/16	74.6	1 7/8	47.6	PA2678	10 3/8	263.5	15 3/4	400.1	7 11/16	195.3	PA1980-FN
10	254.0	3 11/16	93.7	2 9/16	65.1	PA2711	10 3/8	263.5	15 25/32	400.8	7 7/16	188.9	PA2349-FN
10	254.0	5 3/4	146.1	4 7/8	123.8	RS30120	10 13/32	264.3	2 13/32	61.1	1 3/4	44.5	RS3705
10	254.0	5 13/16	147.6	3 7/16	87.3	PA3416	10 13/32	264.3	7 13/16	198.4	3 15/32	88.1	PA1753-FN
10	254.0	7 3/8	187.3	3 1/2	88.9	PA30023	10 7/16	265.1	9 5/16	236.5	4 27/32	123.0	PA2412
10	254.0	8 5/32	207.2	4 3/16	106.4	RS3550	10 7/16	265.1	12 1/16	306.4	7 13/16	198.4	PA1663
10	254.0	8 7/8	225.4	4 11/32	110.3	PA656	10 15/32	265.9	3 5/32	80.2	2 7/16	61.9	RS4962
10	254.0	9	228.6	6 5/8	168.3	PA617	10 1/2	266.7	5 29/32	150.0	2 1/2	63.5	PA3785-FN
10	254.0	12 1/32	305.6	9 1/4	235.0	PA1626	10 1/2	266.7	6 7/16	163.5	4 1/16	103.2	PA1868
10	254.0	12 1/8	308.0	7 11/16	195.3	LL1626-2	10 1/2	266.7	7 15/16	201.6	3 9/16	90.5	PA3627
10	254.0	12 1/8	308.0	7 11/16	195.3	PA1626-2	10 1/2	266.7	8 1/4	209.6	5 3/8	136.5	PA2712
10	254.0	13 5/16	338.1	5 1/4	133.4	PA2812	10 1/2	266.7	8 3/8	212.7	4	101.6	PA1673
10	254.0	14 27/32	377.0	-	-	CA30132	10 1/2	266.7	8 13/16	223.8	4 5/32	105.6	PA1794-FN
10 1/32	254.8	7 13/16	198.4	4 1/16	103.2	PA3681	10 1/2	266.7	9 7/32	234.2	4 27/32	123.0	PA1646
10 1/16	255.6	6 1/4	158.8	3 9/16	90.5	RS5747	10 1/2	266.7	10 3/8	263.5	6 1/32	153.2	PA2465
10 1/16	255.6	6 11/16	169.9	2 5/8	66.7	PA3471	10 1/2	266.7	10 3/8	263.5	6 1/32	153.2	PA2656
10 1/16	255.6	12 3/4	323.9	6 5/16	160.3	PA2942	10 1/2	266.7	10 3/8	263.5	6 1/32	153.2	PA2843
10 1/16	255.6	15 1/4	387.4	6 9/16	166.7	PA2838	10 1/2	266.7	10 1/2	266.7	7 3/4	196.9	PA639
10 3/32	256.4	3 21/32	92.9	2 3/8	60.3	PA2760	10 1/2	266.7	11 5/8	295.3	4 27/32	123.0	LL1646-FN
10 3/32	256.4	4 5/32	105.6	2 29/32	73.8	PA2689	10 1/2	266.7	11 5/8	295.3	4 27/32	123.0	PA1646-FN
10 3/32	256.4	6 11/16	169.9	2 5/8	66.7	PA1674	10 1/2	266.7	11 21/32	296.1	8 31/32	227.8	PA1625
10 3/32	256.4	6 25/32	172.2	2 27/32	72.2	PA3816	10 1/2	266.7	13 7/8	352.4	7 7/16	188.9	LL2642
10 3/32	256.4	9 7/32	234.2	4 27/32	123.0	PA1840	10 1/2	266.7	13 7/8	352.4	7 7/16	188.9	PA2642
10 1/8	257.2	3 3/32	78.6	2 5/32	54.8	PA2489	10 17/32	267.5	4 3/4	120.7	2 1/4	57.2	PA5584
10 1/8	257.2	4 3/16	106.4	2	50.8	RS30209	10 9/16	268.3	5 29/32	150.0	2 17/32	64.3	PA3820-FN
10 1/8	257.2	5 31/32	151.6	3 1/32	77.0	RS4445	10 9/16	268.3	8	203.2	4	101.6	PA30042
10 1/8	257.2	8 7/8	225.4	5	127.0	PA1788	10 9/16	268.3	8 1/8	206.4	6 1/8	155.6	RS4577
10 1/8	257.2	9 11/32	237.3	6 1/4	158.8	PA2598	10 11/16	271.5	5 11/32	135.7	2 7/32	56.4	PA2496
10 5/32	258.0	4 15/32	113.5	2 21/32	67.5	PA4802	10 23/32	272.3	4 5/32	105.6	3	76.2	RS5325
10 5/32	258.0	9 5/8	244.5	5	127.0	PA2566	10 23/32	272.3	5 27/32	148.4	-	-	BA5377
10 1/4	260.4	2 5/8	66.7	1 3/4	44.5	PA30163	10 3/4	273.1	4 1/8	104.7	2 7/16	61.9	RS5449
10 1/4	260.4	2 29/32	73.8	2 7/32	56.4	PA4881	10 3/4	273.1	4 1/2	114.3	2 1/4	57.2	PA1683
10 1/4	260.4	3 3/8	85.7	2 1/4	57.2	PA2413	10 3/4	273.1	4 19/32	116.7	3 11/32	84.9	PA2896
10 1/4	260.4	4 3/32	104.0	2 15/32	62.7	PA4766	10 3/4	273.1	4 7/8	123.8	2 1/4	57.2	PA2331
10 1/4	260.4	6 5/16	160.3	3 7/32	81.8	PA3650	10 3/4	273.1	5 1/8	130.2	2 1/2	63.5	PA4645-FN
10 1/4	260.4	6 3/8	161.9	2 5/8	66.7	PA1830-FN	10 3/4	273.1	6 3/32	154.8	3 25/32	96.0	PA2710
10 1/4	260.4	10 1/16	255.6	3 9/16	90.5	LL1636-FN	10 3/4	273.1	19 9/32	489.7	12 7/16	315.9	PA5551
10 1/4	260.4	10 1/16	255.6	3 9/16	90.5	PA1636-FN	10 25/32	273.8	4 1/4	108.0	2 3/4	69.9	RS3883
10 5/16	261.9	5 1/8	130.2	2 15/32	62.7	PA2944-FN	10 25/32	273.8	5 9/16	141.3	4 7/32	107.2	PA2665
10 5/16	261.9	5 13/16	147.6	2 1/2	63.5	PA3476	10 13/16	274.6	4 1/8	104.8	2 5/16	58.7	RS3704
10 5/16	261.9	9 1/16	230.2	4 15/16	125.4	PA1986	10 13/16	274.6	4 1/8	104.8	2 5/16	58.7	RS3716
10 5/16	261.9	12 19/32	319.9	5	127.0	PA30125	10 13/16	274.6	5 1/4	133.4	2 1/4	57.2	PA1945
10 5/16	261.9	15 5/8	396.9	10 9/32	261.1	PA2848	10 13/16	274.6	6 3/32	154.8	3 1/8	79.4	PA3947
10 5/16	261.9	16 13/16	427.0	10	254.0	PA3838	10 13/16	274.6	8 9/16	217.5	2 1/2	63.5	PA2829
10 11/32	262.7	5 1/8	130.2	2 15/32	62.7	LL1690-FN	10 13/16	274.6	8 9/16	217.5	2 31/32	75.4	PA2805
10 11/32	262.7	5 1/8	130.2	2 15/32	62.7	PA1690-FN	10 7/8	276.2	6 3/8	161.9	2 27/32	72.2	PA2383
10 11/32	262.7	6 5/8	168.3	2	50.8	PA2803	10 7/8	276.2	6 7/8	174.6	5 5/16	134.9	RS4623
10 11/32	262.7	8 17/32	216.7	6 1/32	153.2	PA2869	10 29/32	277.0	4 3/32	104.0	3 17/32	89.7	PA5468
10 11/32	262.7	8 25/32	223.0	7 7/16	188.9	PA30070	10 29/32	277.0	6 1/4	158.8	2 3/4	69.9	RS5285
10 11/32	262.7	19 9/32	489.7	12 7/8	327.0	PA2653	10 15/16	277.8	5 3/32	129.4	2 11/16	68.3	RS5742
10 3/8	263.5	3 3/16	81.0	2 17/32	64.3	PA3672	10 15/16	277.8	8 1/32	204.0	5 5/16	134.9	PA3956
10 3/8	263.5	5 1/16	128.6	2 15/32	62.7	PA4604-FN	10 15/16	277.8	9 15/16	252.4	5 1/4	133.4	PA3479
10 3/8	263.5	5 1/8	130.2	2 1/2	63.5	PA5410-FN	11	279.4	3 9/16	90.5	2 1/32	51.6	PA1644
10 3/8	263.5	5 5/16	134.9	3 1/16	77.8	PA3969	11	279.4	4 3/16	106.4	2 19/32	65.9	PA3985
10 3/8	263.5	5 11/16	144.5	2 1/2	63.5	PA5436							



WARNING: These products can expose you to chemicals, including Diisononyl Phthalate, Carbon black extracts, Nickel, 1,3 Butadiene, Ethylene Oxide, Epichlorohydrin, which are known to the State of California to cause cancer, and Bisphenol-A, Ethylene Glycol, Ethylene Oxide, 1,3 Butadiene, Epichlorohydrin, which are known to the State of California to cause birth defects or other reproductive harm. For more information go to www.P65Warnings.ca.gov.

ROUND AIR FILTERS BY LENGTH

LENGTH Inches	LENGTH (mm)	O.D. Inches	O.D. (mm)	I.D. Inches	I.D. (mm)	BALDWIN NUMBER	LENGTH Inches	LENGTH (mm)	O.D. Inches	O.D. (mm)	I.D. Inches	I.D. (mm)	BALDWIN NUMBER
11	279.4	4 17/32	115.1	2 1/4	57.2	PA2636	11 1/2	292.1	9 7/32	234.2	4 27/32	123.0	PA3645
11	279.4	8 1/4	209.6	5 3/4	146.1	LL1614	11 23/32	292.7	6 13/16	173.0	2 27/32	72.2	PA5338-FN
11	279.4	8 1/4	209.6	5 3/4	146.1	PA1614	11 17/32	292.9	3 17/32	89.7	2 7/16	61.9	PA4685
11 1/32	280.2	5 3/16	131.8	2 17/32	64.3	PA4608	11 17/32	292.9	5	127.0	2 9/16	65.1	PA2792
11 1/32	280.2	5 13/32	137.3	3 3/16	81.0	RS3940	11 17/32	292.9	6 7/32	158.0	2 17/32	64.3	PA2905
11 1/32	280.2	6 1/2	165.1	3 9/16	90.5	RS3707	11 17/32	292.9	7 13/16	198.4	3 5/16	84.1	PA4674-FN
11 1/32	280.2	7 9/32	184.9	3 9/16	90.5	RS3735	11 17/32	292.9	12 13/16	325.4	8 11/32	211.9	PA645
11 1/32	280.2	8 5/16	211.1	3 7/16	87.3	PA5406-FN	11 9/16	293.7	2 15/16	74.6	1 7/8	47.6	PA2728
11 1/32	280.2	8 13/32	213.5	3 7/16	87.3	PA3790	11 9/16	293.7	4 1/8	104.8	3	76.2	PA2652
11 1/16	281.0	3 25/32	96.0	2 7/8	73.0	PA2321	11 9/16	293.7	6 7/16	163.5	3 5/8	92.1	PA5423-FN
11 1/16	281.0	4 1/8	104.8	2 29/32	73.8	PA4919	11 9/16	293.7	8 3/8	212.7	3 7/16	87.3	PA2970
11 1/16	281.0	5 5/32	131.0	3 15/16	100.0	PA30244	11 9/16	293.7	13 7/16	341.3	7 29/32	200.8	RS4576
11 1/16	281.0	6 3/8	161.9	2 5/8	66.7	PA3435-FN	11 19/32	294.5	3 7/8	98.4	3 3/16	81.0	PA4603
11 1/16	281.0	8 5/16	211.1	3 7/16	87.3	PA3853-FN	11 19/32	294.5	6 1/2	165.1	3 9/16	90.5	RS4597
11 3/32	281.8	4 5/32	105.6	2 29/32	73.8	PA2570	11 19/32	294.5	9 9/16	242.9	5 1/8	130.2	PA1701
11 3/32	281.8	7 11/32	186.5	3 19/32	91.3	RS3706	11 19/32	294.5	9 9/16	242.9	5 1/8	130.2	PA1701 ELE
11 1/8	282.6	2 29/32	73.8	2 13/32	61.1	PA4882	11 19/32	294.5	9 9/16	242.9	5 1/8	130.2	PA2627
11 1/8	282.6	3 21/32	92.9	2 7/16	61.9	PA2381	11 5/8	295.3	8 5/32	207.2	4 3/16	106.4	RS3882XP
11 3/16	284.2	2 3/4	69.9	2 1/16	52.4	PA3687	11 5/8	295.3	8 5/32	207.2	4 1/4	108.0	RS3882
11 7/32	285.0	4 3/16	106.4	2 15/16	74.6	PA4827	11 5/8	295.3	8 15/16	227.0	4 19/32	116.7	PA2891
11 7/32	285.0	9 1/8	231.8	4 23/32	119.9	RS4806	11 21/32	296.1	4 1/8	104.8	2 5/16	58.7	RS30147
11 1/4	285.8	2 15/16	74.6	2 15/32	62.7	PA30033	11 21/32	296.1	6 15/32	164.3	3 5/8	92.1	RS5761
11 1/4	285.8	4 9/16	115.9	3 7/16	87.3	PA1967	11 11/16	296.9	10 5/32	258.0	4 3/32	104.0	PA2865
11 1/4	285.8	4 3/4	120.7	2 1/8	54.0	PA3821	11 11/16	296.9	12 31/32	329.4	6 13/16	173.0	RS4622
11 1/4	285.8	5 1/4	133.4	4 1/8	104.8	PA1982	11 23/32	297.7	4 1/4	108.0	3 5/8	92.1	PA5576
11 1/4	285.8	6 3/32	154.8	3 15/32	88.1	PA1710	11 23/32	297.7	7 5/32	181.8	5 27/32	148.4	RS5355
11 1/4	285.8	6 3/8	161.9	2 5/8	66.7	PA2488-FN	11 23/32	297.7	9 9/16	242.9	5 3/16	131.8	PA3597
11 9/32	286.5	6 11/32	161.1	3 5/16	84.1	PA3671-FN	11 3/4	298.5	6 3/8	161.9	3 23/32	94.5	RS30106
11 9/32	286.5	6 3/8	161.9	2 5/8	66.7	PA3761-FN	11 3/4	298.5	8 5/16	211.1	6 1/32	153.2	RS3513
11 9/32	286.5	6 3/8	161.9	2 3/4	69.9	PA2657-FN	11 25/32	299.2	4 23/32	119.9	3 3/16	81.0	RS3503
11 5/16	287.3	5 1/4	133.4	4 1/8	104.8	PA2794	11 25/32	299.2	5 1/4	133.4	4 1/8	104.8	PA3417
11 5/16	287.3	6 3/8	161.9	2 5/8	66.7	PA3667-FN	11 13/16	300.0	10 9/16	268.3	-	-	PA2819
11 5/16	287.3	12 7/8	227.0	-	-	CA30079	11 13/16	300.0	10 9/16	268.3	4 1/4	108.0	PA2806
11 5/16	287.3	9 1/4	235.0	4 5/32	105.6	PA4710	11 27/32	300.8	4 1/8	104.8	2 5/16	58.7	RS3954
11 5/16	287.3	9 9/32	235.7	4 11/16	119.1	PA3415	11 27/32	300.8	6 1/2	165.1	3 9/16	90.5	RS5305
11 11/32	288.1	6 5/8	168.3	1 13/32	35.7	PA2804	11 27/32	300.8	7 1/16	179.4	2 27/32	72.2	PA3879-FN
11 11/32	288.1	6 11/16	169.9	3 3/4	95.3	PA2754	11 7/8	301.6	3 3/4	95.3	3 3/4	62.7	PA5572
11 11/32	288.1	9 5/8	244.5	4 7/8	123.8	RS5424	11 7/8	301.6	5 1/4	133.4	3 1/4	82.6	PA30032
11 3/8	288.9	5 15/16	150.8	4 27/32	123.0	PA2687	11 7/8	301.6	6 3/8	161.9	2 27/32	72.2	PA2391
11 3/8	288.9	6 3/8	161.9	3 1/4	82.6	PA2846-FN	11 7/8	301.6	9	228.6	4 7/8	123.8	RS5536
11 3/8	288.9	6 3/8	161.9	3 5/16	84.1	PA4583-FN	11 7/8	301.6	9 31/32	253.2	3 13/16	96.8	PA2961-FN
11 3/8	288.9	9 1/32	229.4	4 5/8	117.5	RS4807	11 7/8	301.6	10 1/2	266.7	4	101.6	PA2820
11 3/8	288.9	9 9/32	235.7	5 5/32	131.0	RS5434	11 15/16	303.2	6 1/8	155.6	3 3/8	85.7	PA5518
11 3/8	288.9	11 1/2	292.1	4 13/16	122.2	RS5458	11 15/16	303.2	6 5/8	168.3	3 13/16	96.8	PA4472
11 13/32	289.7	7 1/2	190.5	4 1/8	104.8	PA2948	11 15/16	303.2	9 7/32	234.2	5 5/16	134.9	PA3874
11 7/16	290.5	2 13/32	61.1	1 3/4	44.5	RS3547	11 31/32	304.0	3 5/16	84.1	2 15/32	62.7	RS3703
11 7/16	290.5	3 13/16	96.8	2 3/8	60.3	PA4594	11 31/32	304.0	5 1/4	133.4	4 1/8	104.8	PA30211
11 7/16	290.5	7 27/32	199.2	2 5/8	66.7	PA3608-FN							
11 15/32	291.3	4 7/16	112.7	3	76.2	PA3492	12	304.8	4 5/32	105.6	2 5/16	58.7	PA4692
11 15/32	291.3	6 3/4	171.5	3 11/32	84.9	PA5407	12	304.8	5 23/32	145.3	3 7/16	87.3	PA3657
11 15/32	291.3	10 7/32	259.6	7 7/8	200.0	PA1607	12	304.8	5 29/32	150.0	2 25/32	70.6	PA2888
11 1/2	292.1	4 3/4	120.7	3 5/8	92.1	PA2736	12	304.8	6 25/32	172.2	2 3/4	69.9	PA2976-FN
11 1/2	292.1	5 5/32	131.0	4 1/32	102.4	PA2646	12	304.8	7 1/8	181.0	2 27/32	72.2	PA3447
11 1/2	292.1	5 3/16	131.8	3 7/32	81.8	PA2662	12	304.8	7 5/16	185.7	3 5/8	92.1	PA1647
11 1/2	292.1	5 3/4	146.1	3 1/16	77.8	PA2513	12	304.8	8 1/32	204.0	6 1/16	154.0	PA2938
11 1/2	292.1	6 11/32	161.1	3 5/16	84.1	PA3801-FN	12	304.8	8 3/4	222.3	7 1/2	190.5	PA30076
11 1/2	292.1	6 3/8	161.9	2 5/8	66.7	LL1667-FN	12	304.8	8 29/32	226.2	4 21/32	118.3	RS5438
11 1/2	292.1	6 3/8	161.9	2 5/8	66.7	PA1667-FN	12	304.8	9 1/8	231.8	6 7/8	174.6	PA1795
11 1/2	292.1	6 3/8	161.9	2 5/8	66.7	PA3791-FN	12	304.8	9 15/16	252.4	5 1/2	139.7	PA1703
11 1/2	292.1	7	177.8	2 27/32	72.2	PA3979	12	304.8	10 7/32	259.6	5 1/2	139.7	PA618
11 1/2	292.1	7 1/8	181.0	2 5/8	66.7	PA3875-FN	12	304.8	10 7/32	259.6	6 1/16	154.0	PA618-S
11 1/2	292.1	7 13/16	198.4	3 15/32	88.1	PA2684-FN	12	304.8	10 7/32	259.6	7 7/8	200.0	PA616
11 1/2	292.1	7 13/16	198.4	3 15/32	88.1	PA3466-FN	12	304.8	10 3/8	263.5	7 13/16	198.4	PA1913
11 1/2	292.1	7 29/32	200.8	4 3/32	104.0	PA3894	12	304.8	10 13/32	264.3	6 15/16	176.2	PA2555
11 1/2	292.1	8 9/32	210.3	4 7/16	112.7	PA1848	12	304.8	11 3/8	288.9	6 31/32	177.0	PA2647
11 1/2	292.1	8 3/8	212.7	3 15/32	88.1	PA2968-FN	12	304.8	12 3/32	307.2	7 11/16	195.3	PA3598
11 1/2	292.1	8 3/8	212.7	3 15/32	88.1	PA3924-FN	12 1/32	305.6	3 5/16	84.1	2 15/32	62.7	RS3747
11 1/2	292.1	8 5/8	219.1	7 1/16	179.4	PA2735	12 1/32	305.6	3 21/32	92.9	2 3/8	60.3	PA2791
11 1/2	292.1	9 7/32	234.2	4 27/32	123.0	PA1932	12 1/32	305.6	5 1/4	133.4	3 23/32	94.5	RS3501



WARNING: These products can expose you to chemicals, including Diisononyl Phthalate, Carbon black extracts, Nickel, 1,3 Butadiene, Ethylene Oxide, Epichlorohydrin, which are known to the State of California to cause cancer, and Bisphenol-A, Ethylene Glycol, Ethylene Oxide, 1,3 Butadiene, Epichlorohydrin, which are known to the State of California to cause birth defects or other reproductive harm. For more information go to www.P65Warnings.ca.gov.

ROUND AIR FILTERS BY LENGTH

LENGTH Inches	LENGTH (mm)	O.D. Inches	O.D. (mm)	I.D. Inches	I.D. (mm)	BALDWIN NUMBER	LENGTH Inches	LENGTH (mm)	O.D. Inches	O.D. (mm)	I.D. Inches	I.D. (mm)	BALDWIN NUMBER
12 1/32	305.6	7 5/16	185.7	3 5/8	92.1	PA2719	12 1/2	317.5	9 7/32	234.2	4 27/32	123.0	PA2421
12 1/16	306.4	2 3/4	69.9	2 11/16	68.3	RS3943	12 1/2	317.5	9 1/4	235.0	4 27/32	123.0	LL1615
12 1/16	306.4	3 25/32	96.0	2 7/8	73.0	PA2670	12 1/2	317.5	9 1/4	235.0	4 27/32	123.0	PA1615
12 1/16	306.4	3 7/8	98.4	2 1/2	63.5	PA2512	12 1/2	317.5	9 1/4	235.0	4 27/32	123.0	PA1615XP
12 1/16	306.4	6 1/8	155.6	3 9/16	90.5	RS5741	12 1/2	317.5	9 29/32	251.6	5 3/8	136.5	PA2304-FN
12 1/16	306.4	6 15/32	164.3	2 15/16	74.6	PA3776	12 1/2	317.5	10 3/8	263.5	6 1/32	153.2	PA2371
12 1/16	306.4	7 27/32	199.2	3 15/32	88.1	PA3848-FN	12 1/2	317.5	12 1/32	305.6	7 11/16	195.3	PA1877
12 3/32	307.2	3 21/32	92.9	2 7/8	73.0	RS4995	12 1/2	317.5	13 3/4	349.3	6 23/32	170.7	LL1637-FN
12 3/32	307.2	5 3/4	146.1	4 7/32	107.2	PA2260	12 1/2	317.5	13 3/4	349.3	6 23/32	170.7	PA1637-FN
12 3/32	307.2	6 27/32	173.8	2 13/16	71.4	PA4870-FN	12 1/2	317.5	15 3/4	400.1	7 7/16	188.9	PA2389-FN
12 3/32	307.2	7 25/32	197.6	4 11/32	110.3	PA5467	12 17/32	318.3	4 31/32	126.2	2 31/32	75.4	RS3942
12 3/32	307.2	11 7/8	301.6	7 1/4	184.2	PA2549	12 17/32	318.3	6 1/2	165.1	3 9/16	90.5	RS3746
12 1/8	308.0	7 13/16	198.4	3 15/32	88.1	PA3989-FN	12 17/32	318.3	6 1/2	165.1	3 9/16	90.5	RS4994
12 1/8	308.0	13 13/16	350.8	9 1/2	241.3	PA1629-S	12 17/32	318.3	16 17/32	419.9	10	254.0	PA3844
12 5/32	308.8	8	203.2	6 1/8	155.6	PA3966	12 9/16	319.1	3 5/16	84.1	2 15/32	62.7	RS3543
12 3/16	309.6	7 13/16	198.4	4 5/32	105.6	PA5575	12 9/16	319.1	3 15/32	88.1	2 1/2	63.5	RS30242
12 3/16	309.6	9 5/8	244.5	5 3/8	136.5	PA1810	12 9/16	319.1	5 7/8	149.2	2 31/32	75.4	PA2727
12 7/32	310.4	3 5/16	84.1	2 15/32	62.7	RS5544	12 19/32	319.9	5 13/32	137.3	3 3/16	81.0	RS5543
12 7/32	310.4	11 7/32	285.0	4 21/32	118.2	PA3918	12 5/8	320.7	4 1/2	114.3	2 1/4	57.2	PA1684
12 1/4	311.2	4 1/8	104.8	3 1/16	77.8	PA1899	12 5/8	320.7	5 23/32	145.3	3	76.2	RS4680
12 1/4	311.2	4 9/16	115.9	3 17/32	115.1	PA3851	12 5/8	320.7	5 7/8	149.2	4 1/8	104.8	RS3505
12 1/4	311.2	5 1/8	130.2	3 9/16	90.5	PA4890	12 5/8	320.7	7	177.8	4 13/32	111.9	PA1849
12 1/4	311.2	5 1/4	133.4	4 1/8	104.8	PA2402	12 5/8	320.7	7 25/32	197.6	6 15/16	176.2	PA2773
12 1/4	311.2	5 29/32	150.0	3 31/32	100.8	PA3903	12 5/8	320.7	7 13/16	198.4	6 17/32	165.9	PA2775
12 1/4	311.2	7 15/16	201.6	3 17/32	89.7	PA5281	12 5/8	320.7	8 3/8	212.7	4	101.6	PA2553
12 1/4	311.2	9 9/32	235.7	3 19/32	91.3	PA3796	12 5/8	320.7	9 1/8	231.8	5 1/4	133.4	PA2645
12 1/4	311.2	10 1/16	255.6	3 9/16	90.5	PA1749-FN	12 21/32	321.5	13 13/16	350.8	9 1/2	241.3	PA4605
12 1/4	311.2	10 7/8	276.2	5 3/4	146.1	RS30121	12 11/16	322.3	12 3/32	307.2	7 13/16	198.4	RS5354
12 5/16	312.7	3 5/16	84.1	2 27/32	72.2	PA3685	12 11/16	322.3	15 7/8	403.2	8 23/32	221.5	RS30065
12 5/16	312.7	5 1/32	127.8	3 5/32	80.2	RS3549	12 23/32	323.1	5 1/4	133.4	3 23/32	94.5	RS3737
12 5/16	312.7	5 1/32	127.8	3 5/32	80.2	RS3988	12 3/4	323.9	7 3/16	182.6	5 27/32	148.4	RS30226
12 5/16	312.7	11 1/16	281.0	7 11/32	186.5	RS5693	12 3/4	323.9	8 1/2	215.9	5 3/8	136.5	PA2793
12 5/16	312.7	12 9/16	319.1	5	127.0	PA2831	12 3/4	323.9	8 21/32	219.9	4 5/8	117.5	PA4849
12 3/8	314.3	5 11/16	144.5	4 19/32	116.7	PA2545	12 3/4	323.9	9 9/32	235.7	5 5/32	131.0	RS2863
12 3/8	314.3	6 3/32	154.8	4 3/32	104.0	PA3636	12 3/4	323.9	9 9/32	235.7	5 5/32	131.0	RS2863XP
12 3/8	314.3	6 1/4	158.8	4 5/8	117.5	PA2737	12 25/32	324.6	3 7/8	98.4	2 3/8	60.3	PA30208
12 3/8	314.3	6 3/8	161.9	5 9/32	134.1	PA3915	12 25/32	324.6	3 7/8	98.4	3 5/8	92.1	PA5635
12 3/8	314.3	6 17/32	165.9	4 1/2	114.3	RS10021	12 25/32	324.6	4 23/32	119.9	3 1/4	82.6	RS5443
12 3/8	314.3	6 27/32	173.8	3 15/32	88.1	PA3698	12 13/16	325.4	3 17/32	89.7	2 3/4	69.9	PA3683
12 3/8	314.3	6 7/8	174.6	3 1/2	88.9	PA1926	12 27/32	326.2	3 5/32	80.2	21/32	16.7	PA3686
12 3/8	314.3	6 7/8	174.6	4 3/16	106.4	PA2498	12 7/8	327.0	5 9/16	141.3	2 13/16	71.4	PA5583
12 3/8	314.3	7 1/16	179.4	3 15/16	100.0	PA4593	12 29/32	327.0	6 1/8	155.6	3 3/8	85.7	PA5571
12 3/8	314.3	7 5/8	193.7	3 15/32	88.1	PA3670	12 7/8	327.0	6 7/8	174.6	4 1/4	108.0	PA1900
12 3/8	314.3	7 5/8	193.7	6 1/16	154.0	PA2415	12 7/8	327.0	7 7/8	200.0	4 3/32	104.0	PA4602
12 3/8	314.3	7 13/16	198.4	3 15/32	88.1	LL1681-FN	12 7/8	327.0	8 1/2	215.9	5 3/8	136.5	PA2880
12 3/8	314.3	7 13/16	198.4	3 15/32	88.1	PA1681-FN	12 29/32	327.8	5 9/16	141.3	4 7/16	112.7	PA4625
12 3/8	314.3	7 13/16	198.4	3 15/32	88.1	PA2877-FN	12 29/32	327.8	6 1/8	155.6	3 9/32	83.3	PA5570
12 3/8	314.3	7 31/32	202.4	5 3/8	136.5	PA2351	12 29/32	327.8	6 11/16	169.9	3 5/8	92.1	PA4684
12 3/8	314.3	8 13/32	213.5	5 25/32	146.8	PA2897	12 15/16	328.6	4 3/32	104.0	3 1/8	79.4	PA2342
12 3/8	314.3	8 1/2	215.9	3	76.2	PA2815	12 15/16	328.6	7 3/4	196.9	4	101.6	PA3483
12 3/8	314.3	8 1/2	215.9	4	101.6	PA2818	12 15/16	328.6	8 1/4	209.6	4 3/16	106.4	PA2651
12 3/8	314.3	8 1/2	215.9	4	101.6	PA3867	12 31/32	329.4	5 13/32	137.3	3 3/16	81.0	RS3542
12 3/8	314.3	8 17/32	216.7	3	76.2	PA3868	12 31/32	329.4	5 13/32	137.3	3 3/16	81.0	RS4578
12 3/8	314.3	9 7/32	234.2	4 27/32	123.0	PA3474	12 31/32	329.4	8 1/8	206.4	6	152.4	RS5456
12 3/8	314.3	10	254.0	4 27/32	123.0	PA3902	13	330.2	4 1/2	114.3	3 3/32	78.6	PA5786
12 3/8	314.3	10 3/8	263.5	6 1/32	153.2	PA2520	13	330.2	5 3/4	146.1	3 7/16	87.3	PA1911
12 13/32	315.1	6 7/8	174.6	3 1/2	88.9	PA2666	13	330.2	5 15/16	150.8	3 1/4	82.6	PA5634
12 13/32	315.1	6 7/8	174.6	3 1/2	88.9	PA4644	13	330.2	7 1/2	190.5	5 1/4	133.4	PA2871
12 7/16	315.9	5 1/32	127.8	3 5/32	80.2	RS4595	13	330.2	12 1/32	305.6	7 11/16	195.3	LL1642-2
12 7/16	315.9	13 3/4	349.3	5 11/16	144.5	PA2417-FN	13	330.2	12 1/32	305.6	7 11/16	195.3	PA1642-2
12 15/32	316.7	6 3/32	154.8	3 15/32	88.1	PA1882	13	330.2	3 25/32	96.0	2 7/8	73.0	PA2644
12 15/32	316.7	6 3/8	161.9	3 1/4	82.6	PA2380-FN	13 1/16	331.8	9 21/32	245.3	5 7/16	138.1	RS4968
12 1/2	317.5	5 1/4	133.4	3 1/4	82.6	PA3778	13 1/16	331.8	9 3/4	247.7	5 5/8	142.9	PA2664
12 1/2	317.5	5 9/16	141.3	4 1/2	114.3	PA2607	13 1/16	331.8	11 27/32	300.8	6 9/16	166.7	RS5483
12 1/2	317.5	5 15/16	150.8	4 27/32	123.0	PA1906	13 3/32	332.6	4 27/32	123.0	3 5/8	92.1	PA2634
12 1/2	317.5	7 5/8	193.7	6 1/16	154.0	PA2738	13 3/32	332.6	5 3/32	129.4	2 7/8	73.0	RS5746
12 1/2	317.5	7 13/16	198.4	3 7/8	98.4	PA3607-FN	13 3/32	332.6	6 15/32	164.3	3 11/32	84.9	PA2423
12 1/2	317.5	8 21/32	219.9	3 15/32	88.1	PA4640-FN	13 3/32	332.6	9 1/16	230.2	4 5/8	117.5	PA1675
12 1/2	317.5	9 5/32	232.6	4 5/8	117.5	RS3502							



WARNING: These products can expose you to chemicals, including Diisononyl Phthalate, Carbon black extracts, Nickel, 1,3 Butadiene, Ethylene Oxide, Epichlorohydrin, which are known to the State of California to cause cancer, and Bisphenol-A, Ethylene Glycol, Ethylene Oxide, 1,3 Butadiene, Epichlorohydrin, which are known to the State of California to cause birth defects or other reproductive harm. For more information go to www.P65Warnings.ca.gov.

ROUND AIR FILTERS BY LENGTH

LENGTH Inches	LENGTH (mm)	O.D. Inches	O.D. (mm)	I.D. Inches	I.D. (mm)	BALDWIN NUMBER	LENGTH Inches	LENGTH (mm)	O.D. Inches	O.D. (mm)	I.D. Inches	I.D. (mm)	BALDWIN NUMBER
13 3/32	332.6	9 1/16	230.2	4 5/8	117.5	PA2310	13 1/2	342.9	11 1/8	282.6	6 23/32	170.7	PA1634XP
13 1/8	333.4	3 21/32	92.9	2 7/8	73.0	RS4679	13 1/2	342.9	11 15/32	291.3	7 1/8	181.0	RS3508
13 1/8	333.4	6 29/32	175.4	2 13/16	71.4	PA3793	13 1/2	342.9	11 15/32	291.3	7 1/8	181.0	RS3508XP
13 5/32	334.2	5 13/32	137.3	3 3/16	81.0	RS4131	13 1/2	342.9	11 1/2	292.1	8 1/16	204.8	LL2358
13 3/16	335.0	3 7/8	98.4	3 3/16	81.0	PA2370	13 1/2	342.9	11 1/2	292.1	8 1/16	204.8	PA2358
13 3/16	335.0	6 3/16	157.2	3 5/32	84.2	PA5582	13 1/2	342.9	11 5/8	295.3	4 27/32	123.0	PA1941-FN
13 3/16	335.0	6 3/16	157.2	3 5/32	80.2	PA30206	13 1/2	342.9	11 5/8	295.3	4 27/32	123.0	PA3646-FN
13 3/16	335.0	6 3/16	157.2	3 5/32	80.2	PA30207	13 1/2	342.9	12 1/32	305.6	7 11/16	195.3	PA2414
13 3/16	335.0	7	177.8	2 13/16	71.4	PA3759	13 1/2	342.9	13 13/16	350.8	6 23/32	170.7	PA2870-FN
13 3/16	335.0	7 1/4	184.2	5 9/32	134.1	RS3509	13 1/2	342.9	13 7/8	352.4	7 7/16	188.9	PA3486
13 3/16	335.0	8 1/8	206.4	3 3/4	95.3	PA3491	13 1/2	342.9	13 7/8	352.4	9 1/2	241.3	PA4660
13 1/4	336.6	3 3/8	85.7	2 1/4	57.2	PA2305	13 17/32	343.7	6 3/32	154.8	3 5/32	80.2	PA3961
13 1/4	336.6	4 1/4	108.0	3 9/16	83.3	RS30169	13 17/32	343.7	16 1/8	409.6	7 7/16	188.9	PA2517
13 1/4	336.6	4 1/2	114.3	2	50.8	PA2602	13 9/16	344.5	4 17/32	115.1	3 7/16	87.3	PA2308
13 1/4	336.6	5 7/8	149.2	2 13/16	71.4	PA2767	13 9/16	344.5	10	254.0	5 11/16	144.5	PA2606
13 1/4	336.6	10 1/16	255.6	5 3/8	136.5	PA1989-FN	13 19/32	345.3	3 3/32	78.6	2 15/16	74.6	RS3921
13 1/4	336.6	11 29/32	302.4	7 17/32	191.3	PA3766	13 19/32	345.3	4 27/32	123.0	3 5/8	92.1	PA4628
13 9/32	337.3	4 5/8	117.5	3 1/32	77.0	PA4961	13 19/32	345.3	5 1/16	128.6	3 13/16	96.8	PA2668
13 9/32	337.3	7 13/16	198.4	3 15/32	88.1	PA3779-FN	13 19/32	345.3	11	279.4	4 27/32	123.0	PA3864
13 9/32	337.3	9 3/32	231.0	5 7/32	132.6	PA4145	13 19/32	345.3	11 13/32	289.7	4 29/32	121.6	PA4977-FN
13 5/16	338.1	6 3/32	154.8	3 15/32	88.1	PA2392	13 5/8	346.1	9 13/16	249.2	3 9/16	90.5	PA30233-FN
13 5/16	338.1	20 15/32	519.9	8 23/32	221.5	RS30065 KIT	13 21/32	346.9	3 5/16	84.1	2 1/4	57.2	PA3223
13 11/32	338.9	12 19/32	319.9	6	152.4	PA5762	13 21/32	346.9	6 1/8	155.6	2 1/2	63.5	RS5591XP
13 3/8	339.7	2 15/16	74.6	2 13/32	61.1	PA2588	13 21/32	346.9	6 13/32	162.7	3 17/32	89.7	RS5641
13 3/8	339.7	5 1/4	133.4	4 1/8	104.8	PA1836	13 11/16	347.7	4 31/32	126.2	4 3/16	106.4	RS5783
13 3/8	339.7	6 3/8	161.9	2 5/8	66.7	PA1883-FN	13 11/16	347.7	12 1/16	306.4	7 3/4	196.9	RS30225
13 3/8	339.7	7 11/32	186.5	3 31/32	100.8	PA2709	13 23/32	348.5	9 9/32	235.7	5 5/32	131.0	RS3733
13 3/8	339.7	7 15/16	201.6	3 9/16	90.5	PA2581	13 3/4	349.3	6 15/32	164.3	3 5/8	92.1	PA2845
13 3/8	339.7	7 31/32	202.4	3 5/16	84.1	PA2481	13 3/4	349.3	12 1/8	308.0	8 1/2	215.9	RS5455
13 3/8	339.7	8 1/4	209.6	7 3/32	180.2	PA4627	13 25/32	350.0	7 11/16	195.3	4 21/32	118.3	PA5787
13 3/8	339.7	8 13/32	213.5	4 29/32	124.6	RS5431	13 25/32	350.0	13 15/32	342.1	5 1/32	127.8	RS5342
13 3/8	339.7	8 7/8	225.4	4 1/8	104.8	PA3446	13 27/32	351.6	5 1/4	133.4	3 23/32	94.5	RS3535
13 3/8	339.7	9	228.6	5 3/8	136.5	PA2401	13 27/32	351.6	7 13/16	198.4	3 3/8	85.7	PA3752
13 3/8	339.7	10 1/16	255.6	3 9/16	90.5	PA1755-FN	13 27/32	351.6	19 9/32	489.7	12 7/8	327.0	PA3904
13 3/8	339.7	10 3/8	263.5	6 1/32	153.2	PA2616	13 7/8	352.4	3 5/8	92.1	2 15/16	74.6	PA2432
13 3/8	339.7	10 3/8	263.5	6 1/32	153.2	PA2616XP	13 7/8	352.4	5 15/16	150.8	4 27/32	123.0	PA2522
13 3/8	339.7	10 27/32	275.4	4 13/16	122.2	PA3850	13 7/8	352.4	7 11/32	186.5	5 8/32	136.5	PA3475
13 3/8	339.7	10 31/32	278.6	5 13/16	147.6	RS3504	13 7/8	352.4	7 11/16	195.3	4 21/32	118.3	PA5785
13 3/8	339.7	10 31/32	278.6	5 13/16	147.6	RS3504XP	13 29/32	353.2	7 1/8	181.0	2 27/32	72.2	PA3984
13 3/8	339.7	11 1/8	282.6	6 23/32	170.7	PA1881	13 29/32	353.2	9 3/4	247.7	5 1/4	133.4	PA1845
13 3/8	339.7	11 7/8	301.6	7 1/8	181.0	PA1790	13 15/16	354.0	4 15/16	125.4	3 31/32	100.8	RS3541
13 3/8	339.7	12 1/32	305.6	7 11/16	195.3	PA1920	13 15/16	354.0	5 5/16	134.9	4 1/4	108.0	RS5547
13 13/32	340.5	8 21/32	219.9	3 27/32	97.6	PA4683	13 15/16	354.0	7 1/16	179.4	2 13/16	71.4	PA3859
13 7/16	341.3	3 5/8	92.1	2 27/32	72.2	PA2837	13 15/16	354.0	8 13/32	213.5	3 15/32	88.1	PA3852-FN
13 7/16	341.3	4 3/32	104.0	2 15/32	62.7	PA2303	13 31/32	354.8	3 17/32	89.7	2 13/32	61.1	PA4753
13 7/16	341.3	6 1/2	165.1	3 9/16	90.5	RS4678	13 31/32	354.8	6 3/32	154.8	2 7/16	61.9	RS5685
13 7/16	341.3	6 7/8	174.6	3 1/2	88.9	PA2527	14	355.6	3 17/32	89.7	2 3/8	60.3	PA2306
13 7/16	341.3	9 5/32	232.6	4 5/8	117.5	RS5442	14	355.6	4 15/32	113.5	3 7/16	87.3	PA2319
13 7/16	341.3	10 1/32	254.8	5 5/16	134.9	PA2859-FN	14	355.6	6 1/2	165.1	3 3/4	95.3	RS5784
13 15/32	342.1	9 7/32	234.2	4 27/32	123.0	PA2950	14	355.6	7 23/32	196.1	4 11/16	119.1	RS5782
13 15/32	342.1	10 1/4	260.4	6	152.4	PA1819	14	355.6	8 7/8	225.4	4 15/16	125.4	RS30168
13 1/2	342.9	3 21/32	92.9	2 7/8	73.0	RS3545	14	355.6	13 13/16	350.8	9 1/2	241.3	LL1630-2
13 1/2	342.9	5 15/16	150.8	4 27/32	123.0	PA3774	14	355.6	13 13/16	350.8	9 1/2	241.3	PA1630-2
13 1/2	342.9	7 3/32	180.2	3 7/8	98.4	PA5519	14	355.6	13 13/16	350.8	11 1/8	282.6	PA1630
13 1/2	342.9	7 13/16	198.4	3 15/32	88.1	PA2320-FN	14	355.6	13 27/32	351.6	11 1/8	282.6	PA1643
13 1/2	342.9	7 13/16	198.4	3 15/32	88.1	PA2669-FN	14	355.6	13 27/32	351.6	11 1/8	282.6	PA3604
13 1/2	342.9	8 3/8	212.7	3 15/32	88.1	PA5388	14 1/32	356.4	3 29/32	99.2	3 1/16	77.8	RS4599
13 1/2	342.9	8 27/32	224.6	5 13/16	147.6	PA2504	14 1/32	356.4	6 1/2	165.1	3 9/16	90.5	RS3544
13 1/2	342.9	9 1/8	231.8	5 13/16	147.6	LL2779	14 1/32	356.4	6 1/2	165.1	3 9/16	90.5	RS5517
13 1/2	342.9	9 1/8	231.8	5 13/16	147.6	PA2779	14 1/32	356.4	6 7/8	174.6	6 1/2	165.1	RS3711
13 1/2	342.9	9 7/32	234.2	4 27/32	123.0	LL1884	14 1/32	356.4	7 11/32	186.5	4 5/32	105.6	RS5422
13 1/2	342.9	9 7/32	234.2	4 27/32	123.0	PA1884	14 1/32	356.4	15 1/4	387.4	6 9/16	166.7	PA2955
13 1/2	342.9	9 7/32	234.2	4 27/32	123.0	PA1884XP	14 1/16	357.2	3 25/32	96.0	2 7/8	73.0	PA2332
13 1/2	342.9	9 9/32	235.7	4 11/16	119.1	PA3448	14 1/16	357.2	6 1/4	158.8	3 9/16	90.5	RS5745
13 1/2	342.9	9 9/32	235.7	5 5/32	131.0	RS3736	14 1/16	357.2	6 1/2	165.1	2 27/32	72.2	PA2790-FN
13 1/2	342.9	10 1/4	260.4	6	152.4	PA2359	14 1/16	357.2	8 1/2	215.9	4 1/16	103.2	PA2528
13 1/2	342.9	10 3/8	263.5	5 11/32	135.7	PA2761	14 1/16	357.2	9 1/2	241.3	3 9/16	90.5	PA4960-FN
13 1/2	342.9	11 1/8	282.6	6 23/32	170.7	LL1634	14 3/32	358.0	3 5/8	92.1	2 7/16	61.9	PA2487
13 1/2	342.9	11 1/8	282.6	6 23/32	170.7	PA1634							



WARNING: These products can expose you to chemicals, including Diisononyl Phthalate, Carbon black extracts, Nickel, 1,3 Butadiene, Ethylene Oxide, Epichlorohydrin, which are known to the State of California to cause cancer, and Bisphenol-A, Ethylene Glycol, Ethylene Oxide, 1,3 Butadiene, Epichlorohydrin, which are known to the State of California to cause birth defects or other reproductive harm. For more information go to www.P65Warnings.ca.gov.

ROUND AIR FILTERS BY LENGTH

LENGTH Inches	LENGTH (mm)	O.D. Inches	O.D. (mm)	I.D. Inches	I.D. (mm)	BALDWIN NUMBER	LENGTH Inches	LENGTH (mm)	O.D. Inches	O.D. (mm)	I.D. Inches	I.D. (mm)	BALDWIN NUMBER
14 3/32	358.0	4 1/8	104.8	3 29/32	99.2	RS5684	14 19/32	370.7	4 21/32	118.3	3 15/16	100.0	PA2547
14 3/32	358.0	4 5/32	105.6	2 29/32	73.8	PA2419	14 19/32	370.7	8 5/32	207.2	4 27/32	123.0	RS3540
14 3/32	358.0	7 1/4	184.4	6 3/16	157.2	PA5702	14 19/32	370.7	9 9/32	235.7	5 5/32	131.0	RS3538
14 1/8	358.8	5 7/8	149.2	2 15/16	74.6	RS5750	14 5/8	371.5	4 1/8	104.8	3	76.2	PA1897
14 1/8	358.8	5 31/32	151.6	3 3/8	85.7	RS3920	14 5/8	371.5	4 13/32	111.9	3 5/16	84.1	PA2835
14 3/16	360.4	5 5/16	134.9	3 13/32	86.5	PA2322	14 5/8	371.5	6 1/2	165.1	3 11/16	93.7	RS4598
14 3/16	360.4	6	152.4	3 5/8	92.1	PA1609	14 5/8	371.5	7 7/16	188.9	4 3/16	106.4	PA2341
14 3/16	360.4	6 3/8	161.9	5 9/32	134.1	PA3689	14 5/8	371.5	8 3/8	212.7	3 15/32	88.1	PA2635-FN
14 3/16	360.4	7 1/8	181.0	3	76.2	PA3554	14 5/8	371.5	9 11/16	246.1	4 7/8	123.8	RS5301
14 7/32	361.2	3 17/32	88.7	3 13/32	86.5	RS3923	14 5/8	371.5	9 11/16	246.1	4 7/8	123.8	RS30236
14 7/32	361.2	5 1/4	133.4	3 23/32	94.5	RS3521	14 21/32	372.3	3 9/16	90.5	2 13/16	71.4	RS30061
14 1/4	362.0	4 1/8	104.8	3	76.2	PA3430	14 21/32	372.3	5 3/4	146.1	3 1/16	77.8	PA2587
14 1/4	362.0	5 1/2	139.7	3 1/8	79.4	PA1682	14 11/16	373.1	15 25/32	400.8	9 1/2	241.3	PA2867-FN
14 1/4	362.0	6 3/8	161.9	2 5/8	66.7	PA1707-FN	14 23/32	373.9	4 13/16	122.2	3 5/8	92.1	PA2469
14 1/4	362.0	9 7/32	234.2	5 3/16	131.8	PA30243	14 23/32	373.9	5 23/32	145.3	3 7/16	87.3	PA2452
14 1/4	362.0	12 1/16	306.4	6 3/32	154.8	PA2316	14 23/32	373.9	5 3/4	146.1	3 7/16	87.3	PA5486
14 1/4	362.0	15 5/8	396.9	10 9/32	261.1	PA3905	14 23/32	373.9	8 9/32	210.3	5 5/32	131.0	PA5503
14 9/32	362.7	4 1/4	108.0	3 1/2	88.9	PA5474	14 23/32	373.9	10 29/32	277.0	6 25/32	172.2	RS3710
14 9/32	362.7	7 21/32	194.5	6 31/32	177.0	RS5731	14 3/4	374.7	3 1/2	88.9	2 13/16	71.4	PA5764
14 9/32	362.7	19 9/32	489.7	12 7/16	315.9	PA5799	14 3/4	374.7	5 9/32	134.1	3 7/16	87.3	PA5557
14 5/16	363.5	5 1/8	130.2	2 15/32	62.7	LL2344-FN	14 3/4	374.7	6 3/8	161.9	3 3/4	95.3	RS3922
14 5/16	363.5	5 1/8	130.2	2 15/32	62.7	PA2344-FN	14 3/4	374.7	7 11/32	186.5	4	101.6	PA2511
14 5/16	363.5	5 1/8	130.2	2 15/32	62.7	PA3805-FN	14 3/4	374.7	7 13/16	198.4	4 3/32	104.0	PA2405
14 5/16	363.5	5 3/4	146.1	4 13/16	122.2	PA2301	14 3/4	374.7	9 7/32	234.2	5 27/32	148.4	PA4624
14 5/16	363.5	6 5/8	168.3	4 11/32	110.3	PA2637	14 3/4	374.7	11 1/4	285.8	4 3/4	120.7	PA3449
14 5/16	363.5	8 3/4	222.3	4 3/16	106.4	PA2302-FN	14 25/32	375.4	6 1/4	158.8	5 11/16	144.5	PA4809
14 5/16	363.5	10 1/16	255.6	5 3/8	136.5	PA1837-FN	14 25/32	375.4	7 25/32	197.6	3 15/16	100.0	PA5473
14 11/32	364.3	4 7/8	123.8	3 3/8	85.7	PA5504	14 13/16	376.2	7 1/2	190.5	5 11/16	144.5	RS5749
14 11/32	364.3	7 7/8	200.0	3 7/8	98.4	PA3405	14 13/16	376.2	9 3/4	247.7	4 1/16	103.2	PA2866
14 3/8	365.1	3 29/32	99.2	3 1/2	88.9	PA5523	14 27/32	377.0	4 5/8	117.5	3 11/16	93.7	PA1998
14 3/8	365.1	4 1/16	103.2	3 5/16	84.1	RS5490	14 27/32	377.0	5 1/4	133.4	3 23/32	94.5	RS3533
14 3/8	365.1	5 5/16	134.9	3 13/32	86.5	PA2486	14 27/32	377.0	9 17/32	242.1	5 3/16	131.8	RS3760
14 3/8	365.1	6 1/8	155.6	4 15/16	125.4	PA2460	14 7/8	377.8	3 5/16	84.1	2 15/32	62.7	RS3709
14 3/8	365.1	6 3/8	161.9	5 9/32	134.1	PA2578	14 7/8	377.8	7 1/2	190.5	5 1/4	133.4	PA3566
14 3/8	365.1	6 7/8	174.6	3 1/2	88.9	PA1940	14 7/8	377.8	11 29/32	302.4	7 17/32	191.3	PA2813
14 3/8	365.1	6 7/8	174.6	3 1/2	88.9	PA1972	14 29/32	378.6	10 31/32	278.6	-	-	PA5735
14 3/8	365.1	6 7/8	174.6	5 9/16	141.3	PA2605	14 15/16	379.4	4 25/32	121.4	3 11/16	93.7	PA2836
14 3/8	365.1	7 3/16	182.6	5 11/16	144.5	PA2579	15	381.0	4 1/4	108.0	2 3/4	69.9	RS3935
14 3/8	365.1	8 1/4	209.6	7 1/8	181.0	PA2960	15	381.0	4 1/4	108.0	3 3/8	85.7	RS5335
14 3/8	365.1	13 3/4	349.3	6 3/4	171.5	PA1978-FN	15	381.0	5 1/8	130.2	4 3/8	111.1	RS5345
14 3/8	365.1	15 25/32	400.8	9 1/2	241.3	LL2447-FN	15	381.0	5 1/4	133.4	2 5/8	66.7	PA3663
14 3/8	365.1	15 25/32	400.8	9 1/2	241.3	PA2447-FN	15	381.0	5 9/32	134.1	3 13/32	86.5	RS30060-FN
14 13/32	365.9	6 7/8	174.6	5 5/32	131.0	RS3519	15	381.0	5 11/16	144.5	4 13/32	111.9	PA3470
14 7/16	366.7	7	177.8	4 19/32	116.7	PA2307	15	381.0	5 29/32	150.0	4 13/32	111.9	RS3722
14 7/16	366.7	7 23/32	196.1	5 3/32	129.4	PA2759	15	381.0	5 15/16	150.8	4 27/32	123.0	PA3847
14 7/16	366.7	11 3/32	281.8	6 3/4	171.5	PA4889	15	381.0	5 15/16	150.8	4 29/32	124.6	PA3656
14 15/32	367.5	6 1/4	158.8	4 7/8	123.8	PA5529	15	381.0	6 5/16	160.3	2 13/16	71.4	PA4865-FN
14 15/32	367.5	7 13/16	198.4	3 15/32	88.1	PA1699-FN	15	381.0	6 1/2	165.1	3 3/8	85.7	PA5763
14 15/32	367.5	7 13/16	198.4	4 1/8	104.8	PA5522	15	381.0	7	177.8	3 3/8	85.7	PA1826
14 1/2	368.3	5 15/16	150.8	4 27/32	123.0	PA2539	15	381.0	7 1/4	184.2	5 7/16	138.1	RS5292
14 1/2	368.3	6 1/4	158.8	4 5/8	117.5	PA2739	15	381.0	7 1/2	190.5	5 1/4	133.4	PA2455
14 1/2	368.3	6 5/8	168.3	4 1/4	108.0	PA1726	15	381.0	8 27/32	224.6	5 15/32	138.9	PA2550
14 1/2	368.3	8 5/8	219.1	7 1/16	179.4	PA2625	15	381.0	8 15/16	227.0	4 19/32	116.7	PA2474
14 1/2	368.3	8 13/16	223.8	4 3/16	106.4	PA2633-FN	15	381.0	8 15/16	227.0	4 19/32	116.7	PA3605
14 1/2	368.3	10	254.0	4 5/8	117.5	PA2468	15	381.0	9 9/32	235.7	5 5/32	131.0	RS3520
14 1/2	368.3	10 7/32	259.6	6 1/16	154.0	LL1895	15	381.0	9 21/32	245.3	4 23/32	119.9	RS4775
14 1/2	368.3	10 27/32	275.4	6 1/16	154.0	PA1895	15	381.0	10 3/8	263.5	6 1/32	153.2	PA2556
14 1/2	368.3	12 1/32	305.6	7 11/16	195.3	PA1863	15	381.0	10 1/2	266.7	5	127.0	PA30158
14 1/2	368.3	12 1/32	305.6	7 7/8	200.0	PA2707	15	381.0	12 1/16	306.4	7 11/16	195.3	PA666
14 1/2	368.3	13 25/32	350.0	9 7/16	239.7	PA1706	15	381.0	12 1/4	311.2	10 1/8	257.2	PA30069
14 1/2	368.3	13 25/32	350.0	9 7/16	239.7	PA1706XP	15	381.0	12 3/4	323.9	8 11/32	211.9	LL2439
14 1/2	368.3	13 13/16	350.8	8 9/32	210.3	PA2774	15	381.0	12 3/4	323.9	8 11/32	211.9	PA2439
14 1/2	368.3	14 17/32	369.1	8 3/8	212.7	PA1818	15	381.0	12 3/4	323.9	8 11/32	211.9	PA2494
14 1/2	368.3	15 3/4	400.1	7 11/16	195.3	LL1676-FN	15 1/16	382.6	8 5/32	207.2	4 9/32	108.7	RS4972
14 1/2	368.3	15 3/4	400.1	7 11/16	195.3	PA1676-FN	15 1/16	382.6	9 5/8	244.5	4 3/32	104.0	PA2374
14 17/32	369.1	8 3/8	212.7	4 27/32	123.0	RS4864	15 1/16	382.6	8 31/32	277.8	4 7/16	112.7	PA5530
14 17/32	369.1	8 13/32	213.5	6 3/16	157.2	PA2834	15 3/32	383.4	4 25/32	121.4	3 5/8	92.1	PA2427
14 9/16	369.9	4 7/32	107.2	4 1/16	103.2	PA5531	15 3/32	383.4	7 17/32	191.3	3 7/16	87.3	PA4697-FN



WARNING: These products can expose you to chemicals, including Diisononyl Phthalate, Carbon black extracts, Nickel, 1,3 Butadiene, Ethylene Oxide, Epichlorohydrin, which are known to the State of California to cause cancer, and Bisphenol-A, Ethylene Glycol, Ethylene Oxide, 1,3 Butadiene, Epichlorohydrin, which are known to the State of California to cause birth defects or other reproductive harm. For more information go to www.P65Warnings.ca.gov.

ROUND AIR FILTERS BY LENGTH

LENGTH Inches	LENGTH (mm)	O.D. Inches	O.D. (mm)	I.D. Inches	I.D. (mm)	BALDWIN NUMBER	LENGTH Inches	LENGTH (mm)	O.D. Inches	O.D. (mm)	I.D. Inches	I.D. (mm)	BALDWIN NUMBER
15 3/32	383.4	10 15/16	277.8	4 9/16	115.9	PA2847	15 1/2	393.7	12 13/32	315.1	8 3/16	208.0	RS3512
15 1/8	384.3	10 15/16	277.8	4 19/32	116.7	PA2873	15 1/2	393.7	12 1/2	317.5	9 1/8	231.8	LL2384
15 5/32	385.0	4 1/4	108.0	3 3/8	85.7	RS5304	15 1/2	393.7	12 1/2	317.5	9 1/8	231.8	PA2384
15 5/32	385.0	4 11/32	110.3	3 9/16	90.5	RS3993	15 1/2	393.7	12 1/2	317.5	9 1/8	231.8	PA2384XP
15 5/32	385.0	6 1/4	158.8	5 1/4	133.4	RS5453	15 1/2	393.7	13 3/4	349.3	6 23/32	170.7	LL1864-FN
15 5/32	385.0	7 11/32	186.5	3 31/32	100.8	PA2369	15 1/2	393.7	13 3/4	349.3	6 23/32	170.7	PA1864-FN
15 7/32	386.6	6 23/32	170.7	5 1/2	139.7	RS5295	15 1/2	393.7	14 15/32	367.5	6 15/32	164.3	PA2600
15 7/32	386.6	8 5/16	211.1	6 1/32	153.2	RS3511	15 1/2	393.7	14 1/2	368.3	9 1/2	241.3	PA5264
15 7/32	386.6	8 5/16	211.1	6 1/32	153.2	RS3515	15 1/2	393.7	15 25/32	400.8	9 1/2	241.3	PA2959-FN
15 7/32	386.6	9 3/32	231.0	6 29/32	175.4	RS3713	15 17/32	394.5	6 5/8	168.3	4 1/4	108.0	PA2946
15 1/4	387.4	4 1/8	104.8	3	76.2	PA3610	15 17/32	394.5	7 11/32	186.5	4 5/32	105.6	RS5334
15 1/4	387.4	4 23/32	119.9	4	101.6	RS3995	15 17/32	394.5	13 15/32	342.1	8 5/32	207.2	RS4988
15 1/4	387.4	8 1/16	204.8	5 3/4	146.1	PA1686	15 17/32	394.5	14 7/32	361.2	8 15/16	227.0	RS3712
15 1/4	387.4	8 1/2	215.9	5 3/8	136.5	PA3467	15 17/32	394.5	16 1/8	409.6	7 7/16	188.9	PA2648
15 1/4	387.4	11 3/8	288.9	6 31/32	177.0	PA2385	15 9/16	395.3	3 29/32	99.2	3 7/16	87.3	PA5527
15 1/4	387.4	12 1/8	308.0	7 11/16	195.3	PA2833	15 9/16	395.3	4 1/8	104.8	3 7/16	87.3	RS5479
15 1/4	387.4	12 31/32	329.4	6 13/16	173.0	RS3518	15 9/16	395.3	5 9/16	141.3	4 7/16	112.7	PA2674
15 1/4	387.4	12 31/32	329.4	6 13/16	173.0	RS3518XP	15 9/16	395.3	5 11/16	144.5	4 15/16	125.4	PA2743
15 5/16	388.9	6 3/32	154.8	3 15/32	88.1	PA2314	15 9/16	395.3	7 3/4	196.9	3 15/32	88.1	PA4631-FN
15 5/16	388.9	6 3/32	154.8	3 15/32	88.1	PA2420	15 9/16	395.3	7 27/32	199.2	5	127.0	PA5297
15 5/16	388.9	7 1/2	190.5	3 3/4	95.3	PA2431	15 9/16	395.3	9 13/16	249.2	5 3/16	131.8	PA2677
15 5/16	388.9	7 13/16	198.4	3 15/32	88.1	LL2418-FN	15 9/16	395.3	9 29/32	251.6	6 1/16	154.0	PA3775
15 5/16	388.9	7 13/16	198.4	3 15/32	88.1	PA1822-FN	15 9/16	395.3	10	254.0	4 27/32	123.0	PA3948
15 5/16	388.9	7 13/16	198.4	3 15/32	88.1	PA2418-FN	15 19/32	396.1	8 13/32	213.5	4 29/32	124.6	RS5435
15 5/16	388.9	8 3/4	222.3	4 3/16	106.4	PA3439-FN	15 19/32	396.1	10	254.0	4 27/32	123.0	PA5357
15 5/16	388.9	11 1/8	282.6	6 23/32	170.7	PA3699	15 5/8	396.9	6 15/32	164.3	2 27/32	72.2	PA4825
15 5/16	388.9	12 1/32	305.6	7 11/16	195.3	LL2330	15 5/8	396.9	8 5/32	207.2	4 3/16	106.4	RS3934
15 5/16	388.9	12 1/32	305.6	7 11/16	195.3	PA2330	15 5/8	396.9	9 9/32	235.7	5 5/32	131.0	RS3532
15 11/32	389.7	8 1/32	204.0	5 1/32	127.8	RS4637	15 5/8	396.9	10 31/32	278.6	5 13/16	147.6	RS3548
15 11/32	389.7	9 23/32	246.9	6 5/16	160.3	RS5692	15 5/8	396.9	10 31/32	278.6	5 13/16	147.6	RS3548XP
15 11/32	389.7	12	304.8	6 31/32	177.0	PA1797	15 21/32	397.7	5 9/16	141.3	4 13/32	111.9	PA2435
15 3/8	390.5	4 9/16	115.9	3 7/16	87.3	PA1981	15 21/32	397.7	5 3/4	146.1	3 7/16	87.3	PA1912
15 3/8	390.5	5 29/32	150.0	3 31/32	100.8	PA3949	15 21/32	397.7	7 11/32	186.5	4 5/32	105.6	RS3971
15 3/8	390.5	6 3/8	161.9	3 1/4	82.6	LL2360-FN	15 21/32	397.7	7 7/8	200.0	6 3/16	157.2	RS3741
15 3/8	390.5	6 3/8	161.9	3 1/4	82.6	PA2360-FN	15 21/32	397.7	8 3/16	208.0	3 11/16	93.7	PA4709
15 3/8	390.5	6 27/32	173.8	3 15/32	88.1	PA2551	15 21/32	397.7	10 29/32	277.0	6 25/32	172.2	RS3750
15 3/8	390.5	7 3/32	180.2	3 15/32	88.1	PA3487	15 11/16	398.5	5 9/16	141.3	4 13/32	111.9	RS3507
15 3/8	390.5	8 3/4	222.3	3 1/2	88.9	PA2524-FN	15 11/16	398.5	6 23/32	170.7	6 1/16	154.0	RS30191
15 3/8	390.5	9 7/32	234.2	4 27/32	123.0	PA2953	15 11/16	398.5	11 1/2	292.1	7 1/4	184.2	PA2611
15 13/32	391.3	7 5/8	193.7	6 1/16	154.0	PA1904	15 11/16	398.5	12 1/16	306.4	5 11/16	144.5	PA2429
15 13/32	391.3	8 3/8	212.7	3 1/8	79.4	RS5395-FN	15 11/16	398.5	12 1/16	306.4	7 11/16	195.3	PA3558
15 13/32	391.3	9 15/16	252.4	6 15/16	176.2	RS4863	15 23/32	399.3	5 1/4	133.4	3 23/32	94.5	RS3732
15 7/16	392.1	6 7/8	174.6	4 1/4	108.0	PA1898	15 23/32	399.3	5 29/32	150.0	4 3/8	111.1	RS5392
15 7/16	392.1	7 5/16	185.7	6 19/32	167.5	RS5539	15 23/32	399.3	7 11/16	195.3	4 17/32	115.1	RS3992
15 7/16	392.1	8 13/32	213.5	3 15/32	88.1	PA3690	15 3/4	400.0	5 1/2	139.7	3 3/4	95.3	RS5559
15 15/32	392.9	5 13/32	137.3	3 3/16	81.0	RS3708	15 3/4	400.0	10	254.0	4 31/32	126.2	PA5485-FN
15 15/32	392.9	6 3/8	161.9	3 5/8	92.1	PA2541-FN	15 3/4	400.0	11	279.4	7 3/32	180.2	RS5291
15 15/32	392.9	9 5/32	232.6	4 7/8	123.8	PA2971	15 3/4	400.0	13 13/16	350.8	9 1/2	241.3	PA3602
15 15/32	392.9	12 3/32	307.2	6 3/32	154.8	PA3978	15 25/32	400.8	8 1/2	215.9	6 7/32	158.0	PA2883
15 1/2	393.7	5 1/4	133.4	4 1/8	104.8	PA2568	15 27/32	402.4	8 11/16	220.7	4 15/16	125.4	RS3994
15 1/2	393.7	5 3/4	146.1	4 7/8	123.8	RS5347	15 27/32	402.4	15 3/32	383.4	6 23/32	170.7	PA5425
15 1/2	393.7	6 1/16	154.0	3 15/32	88.1	PA1831	15 7/8	403.2	7 5/8	193.7	6 1/16	154.0	PA2526
15 1/2	393.7	7	177.8	3 5/8	92.1	PA2756	15 7/8	403.2	7 5/8	193.7	6 1/16	154.0	PA3480
15 1/2	393.7	7 5/16	185.7	6 5/32	156.4	PA3832	15 7/8	403.2	10 3/8	263.5	5 3/4	146.1	RS5627
15 1/2	393.7	7 15/16	201.6	4 5/8	117.5	PA4656	15 7/8	403.2	11 1/2	292.1	7 1/4	184.2	PA2604
15 1/2	393.7	8 3/8	212.7	3 15/32	88.1	PA2977-FN	15 7/8	403.2	12	304.8	6 1/2	165.1	RS30090-FN
15 1/2	393.7	8 3/8	212.7	3 15/32	88.1	PA3669-FN	15 29/32	404.0	5 5/16	134.9	4 3/8	111.1	RS5548
15 1/2	393.7	9 7/32	234.2	4 27/32	123.0	PA2451	15 29/32	404.0	6 1/16	154.0	4 3/4	120.7	PA4607
15 1/2	393.7	9 9/32	235.7	4 11/16	119.1	PA2788	15 29/32	404.0	8 1/2	215.9	4 13/16	122.2	PA5556
15 1/2	393.7	9 9/32	235.7	4 11/16	119.1	PA3629	15 29/32	404.0	10 1/4	260.4	7 15/16	201.6	RS4636
15 1/2	393.7	9 7/16	239.7	4 17/32	115.1	LL2318	15 15/16	404.8	14 5/32	359.6	9 1/2	241.3	PA1687
15 1/2	393.7	9 7/16	239.7	4 17/32	115.1	PA2393	15 15/16	404.8	16 1/16	408.0	8 21/32	219.9	PA2839
15 1/2	393.7	9 5/8	244.5	5 7/32	132.6	LL2667	15 31/32	405.6	13 17/32	343.7	5 1/32	127.8	RS5343
15 1/2	393.7	9 5/8	244.5	5 7/32	132.6	PA2667							
15 1/2	393.7	9 29/32	251.6	5 3/8	136.5	PA2887-FN	16	406.4	6 3/32	154.8	5 11/32	135.7	RS5361
15 1/2	393.7	10	254.0	5 3/8	136.5	PA2338-FN	16	406.4	7 1/2	190.5	5 1/4	133.4	PA1893
15 1/2	393.7	10 27/32	275.4	6 1/2	165.1	PA2577	16	406.4	7 13/16	193.4	4 1/16	103.2	PA5526
15 1/2	393.7	12 13/32	315.1	8 3/16	208.0	RS3510	16	406.4	8 21/32	219.9	5 3/16	131.8	PA2540
15 1/2	393.7	12 13/32	315.1	8 3/16	208.0	RS3510XP	16	406.4	9 1/16	230.2	4 5/8	117.5	PA1670



WARNING: These products can expose you to chemicals, including Diisononyl Phthalate, Carbon black extracts, Nickel, 1,3 Butadiene, Ethylene Oxide, Epichlorohydrin, which are known to the State of California to cause cancer, and Bisphenol-A, Ethylene Glycol, Ethylene Oxide, 1,3 Butadiene, Epichlorohydrin, which are known to the State of California to cause birth defects or other reproductive harm. For more information go to www.P65Warnings.ca.gov.

ROUND AIR FILTERS BY LENGTH

LENGTH Inches	LENGTH (mm)	O.D. Inches	O.D. (mm)	I.D. Inches	I.D. (mm)	BALDWIN NUMBER	LENGTH Inches	LENGTH (mm)	O.D. Inches	O.D. (mm)	I.D. Inches	I.D. (mm)	BALDWIN NUMBER
16	406.4	9 29/32	251.6	6 1/16	154.0	PA3655	16	417.5	10 31/32	278.6	5 13/16	147.6	RS3506
16	406.4	10 3/8	263.5	6 1/32	153.2	LL2425	16	417.5	10 31/32	278.6	5 13/16	147.6	RS3506XP
16	406.4	10 3/8	263.5	6 1/32	153.2	PA2425	16	417.5	10 31/32	278.6	5 13/16	147.6	RS4561
16	406.4	12 1/32	305.6	6 23/32	170.7	PA2643	16	417.5	11	279.4	5 3/8	136.5	PA3854-FN
16	406.4	12 1/16	306.4	7 11/16	195.3	LL2661	16	417.5	12 31/32	329.4	7 3/4	196.9	RS3740
16	406.4	12 1/16	306.4	7 11/16	195.3	PA2661	16	418.3	9 3/16	233.4	4 13/16	122.2	PA4925
16	406.4	12 15/32	316.7	7 7/8	200.0	PA1702	16	418.3	9 17/32	242.1	4 13/16	122.2	RS4861
16	406.4	13 13/16	350.8	9 1/2	241.3	LL1649	16	418.3	10 7/16	265.1	6 3/16	157.2	RS5360
16	406.4	13 13/16	350.8	9 1/2	241.3	PA1649	16	418.3	11	279.4	7 11/16	195.3	RS5296
16	406.4	13 13/16	350.8	9 1/2	241.3	LL2685	16	419.1	4 9/16	115.9	3 7/16	87.3	PA3809
16	406.4	16 5/8	422.3	12	304.8	PA1632	16	419.1	5 3/4	146.1	4 3/8	111.1	RS5628
16	407.2	13 5/16	338.1	9 7/8	250.8	RS5389-FN	16	419.1	7 1/4	184.2	6 3/16	157.2	PA2967
16	407.2	16 1/8	409.6	7 7/16	188.9	PA2544	16	419.1	7 5/8	193.7	4 1/4	108.0	LL2783
16	408.0	4 1/4	108.0	3 3/8	85.7	RS3885	16	419.1	7 5/8	193.7	4 1/4	108.0	PA2783
16	408.8	5 1/4	133.4	4 1/8	104.8	PA2443	16	419.1	7 15/16	201.6	3 9/16	90.5	PA2484
16	408.8	12 1/16	306.4	9 7/8	250.8	RS4862	16	419.1	7 15/16	201.6	3 9/16	90.5	PA2856
16	409.6	7 1/4	184.2	3 5/8	92.1	RS5329	16	419.1	7 15/16	201.6	3 9/16	90.5	PA3460
16	409.6	12 13/16	325.4	5 15/16	150.8	RS4966	16	419.1	7 15/16	201.6	5 3/8	136.5	PA2523
16	409.6	13 3/32	332.6	8 9/32	210.3	RS5730	16	419.1	9 7/32	234.2	4 27/32	123.0	LL2641
16	410.4	5 5/32	131.0	4 1/32	102.4	PA2530	16	419.1	9 7/32	234.2	4 27/32	123.0	PA2641
16	410.4	9 1/8	231.8	5 13/16	147.6	RS5535	16	419.1	9 11/32	237.3	4 5/32	105.6	RS30059-FN
16	410.4	9 25/32	248.4	5 21/32	143.7	RS5537	16	419.1	9 29/32	251.6	6 1/16	154.0	PA2777
16	410.4	16 7/16	417.5	9 15/16	252.4	PA1815	16	419.1	10	254.0	5 3/8	136.5	PA4650-FN
16	412.0	5 29/32	150.0	4 5/16	109.5	RS5676	16	419.1	10 3/8	263.5	6 1/32	153.2	PA2538
16	412.0	9 1/16	230.2	4 5/8	117.5	PA2733	16	419.1	10 7/8	276.2	4 13/16	122.2	PA3675
16	412.8	6 3/32	154.8	3 15/32	88.1	PA1709	16	419.1	10 29/32	277.0	6 25/32	172.2	RS5452
16	412.8	7 1/16	179.4	5 29/32	150.0	RS5708	16	419.1	11	279.4	6 1/32	153.2	PA2300
16	412.8	7 13/16	198.4	3 15/32	88.1	PA1850-FN	16	419.1	11 1/8	282.6	6 23/32	170.7	LL1669
16	412.8	10 7/32	259.6	6 1/2	165.1	PA5528	16	419.1	11 1/8	282.6	6 23/32	170.7	PA1669
16	412.8	11 31/32	304.0	5 27/32	148.4	RS5507	16	419.1	11 1/8	282.6	6 23/32	170.7	LL1885
16	412.8	12 15/16	328.6	8 19/32	218.3	PA5701	16	419.1	11 1/8	282.6	6 23/32	170.7	PA1885
16	412.8	14	355.6	7 25/32	197.6	RS5776	16	419.1	11 1/8	282.6	6 23/32	170.7	PA1885XP
16	413.5	9 1/2	241.3	8 1/8	206.4	RS5758	16	419.1	11 1/8	282.6	6 23/32	170.7	PA2951
16	414.3	5 29/32	150.0	4 1/32	102.4	PA5497	16	419.1	11 7/16	290.5	6 3/16	157.2	PA3862-FN
16	414.3	9 3/32	231.0	5 7/16	138.1	RS5409	16	419.1	12 1/32	305.6	7 7/8	200.0	PA3453
16	414.3	9 3/32	231.0	5 7/16	138.1	RS5441	16	419.1	12 1/8	308.0	7 11/16	195.3	LL1886
16	414.3	9 19/32	243.7	5 7/16	138.1	RS4969	16	419.1	12 1/8	308.0	7 11/16	195.3	PA1886
16	414.3	9 5/8	244.5	6 3/16	157.2	PA2459	16	419.1	12 1/8	308.0	7 11/16	195.3	PA1886XP
16	414.3	10	254.0	5 3/8	136.5	LL1902-FN	16	419.1	12 9/32	311.9	6 31/32	177.0	RS30112
16	414.3	10	254.0	5 3/8	136.5	PA1902-FN	16	419.1	12 15/32	316.7	6 3/16	157.2	PA3855-FN
16	414.3	14 7/8	377.8	7 7/8	200.0	PA3768	16	419.1	12 1/2	317.5	6	152.4	PA3652
16	415.1	5 1/4	133.4	4 1/8	104.8	PA3578	16	419.1	12 1/2	317.5	6	152.4	PA3860
16	415.1	9 9/32	235.7	5 5/32	131.0	RS3731	16	419.1	14 3/16	360.4	6 23/32	170.7	PA2533
16	415.1	9 15/32	240.5	5 9/16	141.3	RS5348	16	419.1	15 3/4	400.1	7 11/16	195.3	PA3786-FN
16	415.1	13 25/32	350.0	7 15/16	201.6	RS4967	16	419.9	8 13/32	213.5	4 11/16	119.1	RS5433
16	415.1	14 19/32	370.7	5 5/16	134.9	PA3408	16	420.7	8 5/32	207.2	4 3/16	106.4	RS3734
16	415.9	5 23/32	145.3	4 19/32	116.7	PA2467	16	420.7	8 5/32	207.2	4 3/16	106.4	RS3734XP
16	415.9	5 15/16	150.8	4 27/32	123.0	PA2510	16	420.7	8 5/32	207.2	4 3/16	106.4	RS3884
16	415.9	8 1/4	209.6	7 1/8	181.0	PA2630	16	420.7	8 7/8	225.4	4 1/8	104.8	PA2480
16	415.9	8 5/8	219.1	4 1/4	108.0	PA1997	16	420.7	10	254.0	5 11/16	144.5	PA2434
16	415.9	8 3/4	222.3	4 3/16	106.4	LL2426-FN	16	421.5	5 15/32	138.9	4 1/2	114.3	RS5398
16	415.9	8 3/4	222.3	4 3/16	106.4	PA2426-FN	16	421.5	13 1/2	342.9	-	-	PA30041
16	415.9	9 7/32	234.2	4 27/32	123.0	PA1827	16	421.5	14	355.6	7 25/32	197.6	PA3767
16	415.9	10	254.0	5 11/16	144.5	PA2569	16	422.3	5 23/32	145.3	4 19/32	116.7	PA5412
16	415.9	10 1/16	255.6	3 9/16	90.5	PA1650-FN	16	423.1	4 29/32	124.6	3 31/32	100.8	PA5298
16	415.9	11	279.4	4 27/32	123.0	PA3849	16	423.1	8	203.2	4 3/8	111.1	RS5489
16	415.9	12 1/32	305.6	7 11/16	195.3	LL1992	16	423.1	12 3/4	323.9	8 11/32	211.9	PA2797
16	415.9	12 1/2	317.5	6	152.4	PA2821	16	423.9	12 1/32	305.6	7 11/16	195.3	LL2945
16	415.9	13 3/4	349.3	6 3/4	171.5	PA1979-FN	16	423.9	12 1/32	305.6	7 11/16	195.3	PA2945
16	415.9	15 3/4	400.1	7 11/16	195.3	PA1992-FN	16	424.7	8 13/16	223.8	5 17/32	140.5	RS5558
16	416.7	5 1/4	133.4	3 3/4	95.3	RS4677	16	424.7	8 27/32	224.6	7 1/8	181.0	RS4992
16	417.5	4 21/32	118.3	3 15/16	100.0	PA2368	16	425.5	8 13/32	213.5	6 3/16	157.2	PA5464
16	417.5	6 11/16	169.9	2 27/32	72.2	PA4582	16	425.5	8 1/2	215.9	4 5/32	105.6	PA3609
16	417.5	8 3/8	212.7	4 11/16	119.1	RS4970	16	425.5	8 1/2	215.9	4 5/32	105.6	PA4581
16	417.5	8 1/2	215.9	4	101.6	RS5478-FN	16	425.5	8 5/16	211.2	6 1/32	153.2	RS3739
16	417.5	8 5/8	219.1	4 1/4	108.0	PA2495	16	427.8	13 1/2	342.9	-	-	PA4630
16	417.5	10 1/32	254.8	4 31/32	126.2	RS5344	16	428.6	8 13/16	223.8	5 5/32	131.0	RS5546
16	417.5	10 3/8	263.5	6 1/32	153.2	LL2521	16	428.6	9 7/32	234.2	5 5/16	134.9	PA5496
16	417.5	10 3/8	263.5	6 1/32	153.2	PA2521	16	429.4	11 1/2	292.1	-	-	PA3907



WARNING: These products can expose you to chemicals, including Diisononyl Phthalate, Carbon black extracts, Nickel, 1,3 Butadiene, Ethylene Oxide, Epichlorohydrin, which are known to the State of California to cause cancer, and Bisphenol-A, Ethylene Glycol, Ethylene Oxide, 1,3 Butadiene, Epichlorohydrin, which are known to the State of California to cause birth defects or other reproductive harm. For more information go to www.P65Warnings.ca.gov.

ROUND AIR FILTERS BY LENGTH

LENGTH Inches	LENGTH (mm)	O.D. Inches	O.D. (mm)	I.D. Inches	I.D. (mm)	BALDWIN NUMBER	LENGTH Inches	LENGTH (mm)	O.D. Inches	O.D. (mm)	I.D. Inches	I.D. (mm)	BALDWIN NUMBER
16 29/32.....	429.4	11 1/2	292.1	-	-	PA30038	18	457.2	7 1/2	190.5	5 1/4	133.4	PA2899
16 15/16.....	430.2	5 1/16	128.6	3 13/16	96.8	PA4611	18	457.2	10	254.0	5 1/32	127.8	RS5506
16 15/16.....	430.2	8 7/8	225.4	6 1/4	158.8	PA4626	18	457.2	12 3/4	323.9	8 11/32	211.9	PA2437
16 15/16.....	430.2	10 9/16	268.3	5 1/16	128.6	PA30171	18 1/32	458.0	12 3/32	307.2	7 23/32	196.1	PA5751
16 15/16.....	430.2	11	279.0	7 11/16	195.3	RS30192	18 3/32	459.6	12 3/32	307.2	8 1/8	206.4	PA2782
17	431.8	9 3/32	231.0	5 7/32	132.6	PA2546	18 1/8	460.4	11 1/8	282.6	6 3/16	157.2	PA1768
17	431.8	9 1/8	231.8	5 13/16	147.6	PA3469	18 1/8	460.4	11 15/16	303.2	6 19/32	167.5	RS30142
17	431.8	9 9/32	235.7	5 5/32	131.0	RS4676	18 1/8	460.4	13 13/16	350.8	9 1/2	241.3	PA1631-S
17	431.8	11 25/32	299.2	7 3/4	196.9	RS5707	18 1/8	460.4	14 3/8	365.1	6 19/32	167.5	RS30142 KIT
17	431.8	12 3/4	323.9	8 11/32	211.9	PA2571	18 5/32	461.2	7 7/8	200.0	7 5/8	193.7	PA5365
17	431.8	13 7/8	352.4	9 13/32	238.9	PA3573	18 5/32	461.2	11 7/8	301.6	10 1/4	260.4	PA2508
17 1/32	432.6	7	177.8	3 3/8	85.7	PA1825	18 3/16	462.0	10 31/32	278.6	5 13/16	147.6	RS30091
17 1/32	432.6	8 5/8	219.1	7 1/32	178.6	PA1905	18 7/32	462.8	5 1/4	133.4	4 15/16	125.4	RS3717
17 1/8	435.0	5 29/32	150.0	4 7/16	112.7	RS30092	18 7/32	462.8	12 7/32	310.3	8 1/32	204.0	RS5356
17 1/8	435.0	8 1/4	209.6	7 1/8	181.0	PA2957	18 1/4	463.6	6 13/32	162.7	2 25/32	70.6	PA2800-FN
17 5/32	435.8	12 3/32	307.2	7 23/32	196.1	PA3794	18 1/4	463.6	7 1/8	181.0	5 13/16	147.6	PA2397
17 3/16	436.6	6 19/32	167.5	3 21/32	92.9	PA2542	18 5/16	465.1	5 29/32	150.0	4 7/16	112.7	RS30217
17 3/16	436.6	7 5/16	185.7	6 5/16	160.3	RS5541	18 5/16	465.1	6	152.4	3 5/8	92.1	PA1610
17 3/16	436.6	8 3/32	205.6	-	-	PA4655	18 5/16	465.1	6 1/8	155.6	4 15/16	125.4	PA2388
17 3/16	436.6	8 1/8	206.4	4	101.6	PA3555	18 5/16	465.1	9 1/8	231.8	5 29/32	150.0	RS30062
17 3/16	436.6	9 7/8	250.8	5 5/16	134.9	RS5397	18 5/16	465.1	9 15/32	240.5	5 15/32	138.9	RS5440
17 1/4	438.2	5 1/2	139.7	3 1/8	79.4	PA1692	18 5/16	465.1	12 3/16	309.6	7 1/32	178.6	RS4963
17 1/4	438.2	10 7/16	265.1	5 5/8	142.9	RS30130	18 5/16	465.1	19 9/32	489.7	12 7/8	327.0	PA3932
17 9/32	438.9	12 31/32	329.4	6 13/16	173.0	RS3749	18 11/32	465.9	12 9/32	311.9	6 31/32	177.0	RS3727
17 5/16	439.7	6 5/8	168.3	5	127.0	RS5408	18 11/32	465.9	12 9/32	311.9	6 31/32	177.0	RS5390
17 5/16	439.7	7 1/4	184.2	6 1/16	154.0	PA5521	18 11/32	465.9	14 7/32	361.2	8 15/16	227.0	RS3700
17 5/16	439.7	10	254.0	5 1/2	139.7	PA2442	18 11/32	465.9	14 7/32	361.2	8 15/16	227.0	RS3700XP
17 3/8	441.3	7 5/8	193.7	6 1/16	154.0	PA2410	18 3/8	466.7	5 15/16	150.8	4 27/32	123.0	PA2462
17 3/8	441.3	9 1/16	230.2	5 3/8	136.5	PA2567	18 3/8	466.7	7 5/8	193.7	6 1/16	154.0	PA2519
17 13/32	442.1	7 7/8	197.7	4 9/16	115.9	RS4859	18 3/8	466.7	7 5/8	193.7	6 1/16	154.0	PA2708
17 7/16	442.9	5 5/16	134.9	3 11/16	93.7	RS30162	18 3/8	466.7	9 7/32	234.2	4 27/32	123.0	PA1824
17 7/16	442.9	7 15/32	189.7	6 7/32	158.0	PA5589	18 3/8	466.7	9 7/32	234.2	5 27/32	148.4	PA2466
17 7/16	442.9	9 1/32	229.4	7 1/32	178.6	RS30129	18 3/8	466.7	10 3/8	263.5	6 1/32	153.2	PA2509
17 7/16	442.9	9 11/16	246.1	4 29/32	124.6	RS4562	18 3/8	466.7	10 31/32	278.6	5 17/32	140.5	RS5675
17 7/16	442.9	12 19/32	319.9	7 27/32	199.2	PA30010	18 3/8	466.7	11	279.4	6 1/32	153.2	PA2591
17 1/2	444.5	5 23/32	145.3	4 19/32	116.7	PA2621	18 13/32	467.5	7 1/16	179.4	5 3/4	146.1	RS30136
17 1/2	444.5	6 3/8	161.9	5 9/32	134.1	PA2853	18 13/32	467.5	15 25/32	400.8	9 1/2	241.3	PA2956-FN
17 1/2	444.5	7 1/16	179.4	5 11/16	144.5	RS5351	18 13/32	467.5	16 1/8	409.6	7 1/16	188.9	PA2595
17 1/2	444.5	9 7/32	234.2	5 27/32	148.4	PA2673	18 7/16	468.3	6 1/8	155.6	5 1/8	130.2	RS5549
17 1/2	444.5	13 3/8	339.7	8 3/8	212.7	LL2326	18 7/16	468.3	6 5/16	160.3	21/32	16.7	PA3857
17 1/2	444.5	13 3/8	339.7	8 3/8	212.7	PA2326	18 7/16	468.3	12 3/32	307.2	7 11/16	195.3	PA5487
17 1/2	444.5	13 3/8	339.7	8 3/8	212.7	PA2326XP	18 1/2	469.9	6 7/8	174.6	6 7/16	163.5	RS4549
17 1/2	444.5	8 9/32	210.3	7 3/32	180.2	PA5445	18 1/2	469.9	7 1/4	184.2	6 3/16	157.2	PA3668
17 9/16	446.1	9 27/32	250.0	4 3/4	120.7	RS5411	18 1/2	469.9	7 5/8	193.7	6 3/16	157.2	PA3893
17 9/16	446.1	12 19/32	319.9	7 13/16	198.4	PA5505	18 1/2	469.9	7 7/8	200.0	4 3/4	120.7	RS4672
17 19/32	446.9	7 15/32	189.7	6 1/2	165.1	PA5275	18 1/2	469.9	8 1/4	209.6	4 23/32	119.9	PA2750
17 19/32	446.9	7 31/32	202.4	7	177.8	PA3925	18 1/2	469.9	8 9/32	210.3	7 3/32	180.2	PA5562
17 19/32	446.9	8 15/32	215.1	6 3/16	157.2	PA1880	18 1/2	469.9	8 17/32	216.7	7 11/16	195.3	RS4643
17 19/32	446.9	9 1/8	231.8	5 13/16	147.6	PA3906	18 1/2	469.9	8 5/8	219.1	7 1/16	179.4	PA2574
17 19/32	446.9	10	254.0	5 7/8	149.2	PA2742	18 1/2	469.9	9 1/8	231.8	5 13/16	147.6	LL2688
17 19/32	446.9	11 29/32	302.4	6 5/8	168.3	RS3724	18 1/2	469.9	9 1/8	231.8	5 13/16	147.6	PA2688
17 21/32	448.5	11 3/32	281.8	7 7/16	188.9	RS5538	18 1/2	469.9	9 7/32	234.2	4 27/32	123.0	PA3600
17 11/16	449.3	12 1/16	306.4	5 11/16	144.5	PA2428	18 1/2	469.9	9 3/4	247.7	5 13/16	147.6	PA2620
17 23/32	450.1	4 7/16	112.7	3 5/16	84.1	RS4673	18 1/2	469.9	10 27/32	275.4	6 1/2	165.1	PA2852
17 23/32	450.1	6 7/8	174.6	5 5/32	131.0	RS3531	18 1/2	469.9	11 1/8	282.6	6 23/32	170.7	PA1823
17 3/4	450.9	12 1/32	305.6	7 11/16	195.3	PA2612	18 1/2	469.9	12 1/32	305.6	7 11/16	195.3	PA2409
17 3/4	450.9	13 15/32	342.1	8 5/32	207.2	RS3738	18 1/2	469.9	12 1/16	306.4	7 11/16	195.3	PA3688
17 3/4	450.9	15 5/8	396.9	10 9/32	261.1	PA3933	18 1/2	469.9	12 3/32	307.2	7 11/16	195.3	LL2525
17 25/32	451.6	6 3/8	161.9	5 9/32	134.1	PA30108	18 1/2	469.9	12 3/32	307.2	7 11/16	195.3	PA2525
17 13/16	452.4	9 11/16	249.2	8 1/8	206.4	PA3551	18 1/2	469.9	12 3/32	307.2	7 11/16	195.3	PA2952
17 13/16	452.4	10 3/8	263.5	6 1/32	153.2	PA2382	18 1/2	469.9	12 3/32	307.2	6 25/32	172.2	RS30057
17 27/32	453.2	6 7/8	174.6	5 1/4	133.4	RS30058	18 1/2	469.9	12 1/8	308.0	7 11/16	195.3	LL1846
17 27/32	453.2	9 3/32	231.0	6 29/32	175.4	RS3701	18 1/2	469.9	12 1/8	308.0	7 11/16	195.3	PA1846
17 7/8	454.0	5 1/4	133.4	3 3/4	95.3	RS4621	18 1/2	469.9	12 1/8	308.0	7 11/16	195.3	PA1846XP
17 29/32	454.8	10 3/8	263.5	5 11/32	135.7	PA2784	18 1/2	469.9	13 13/16	350.8	9 1/2	241.3	LL1894
17 15/16	455.6	11	279.4	5 3/8	136.5	PA3808-FN	18 1/2	469.9	13 13/16	350.8	9 1/2	241.3	PA1894
17 15/16	455.6	12 19/32	319.9	7 27/32	199.2	PA30170	18 1/2	469.9	13 13/16	350.8	9 1/2	241.3	PA1894XP
							18 1/2	469.9	13 7/8	352.4	7 7/16	188.9	PA2468



WARNING: These products can expose you to chemicals, including Diisononyl Phthalate, Carbon black extracts, Nickel, 1,3 Butadiene, Ethylene Oxide, Epichlorohydrin, which are known to the State of California to cause cancer, and Bisphenol-A, Ethylene Glycol, Ethylene Oxide, 1,3 Butadiene, Epichlorohydrin, which are known to the State of California to cause birth defects or other reproductive harm. For more information go to www.P65Warnings.ca.gov.

ROUND AIR FILTERS BY LENGTH

LENGTH Inches	LENGTH (mm)	O.D. Inches	O.D. (mm)	I.D. Inches	I.D. (mm)	BALDWIN NUMBER	LENGTH Inches	LENGTH (mm)	O.D. Inches	O.D. (mm)	I.D. Inches	I.D. (mm)	BALDWIN NUMBER
18 1/2	469.9	13 7/8	352.4	7 7/16	188.9	LL2618	19 1/2	495.3	7 3/8	187.3	6 1/8	155.6	PA2491
18 1/2	469.9	13 7/8	352.4	7 7/16	188.9	PA2618	19 1/2	495.3	9 1/2	241.3	4 7/8	123.8	RS5391
18 1/2	469.9	14 1/2	368.3	9 1/2	241.3	PA2749	19 1/2	495.3	9 17/32	242.1	5 5/32	131.0	PA3572
18 1/2	469.9	14 13/16	376.2	7 11/16	195.3	PA2478	19 1/2	495.3	9 27/32	250.0	6 1/4	158.8	PA2751
18 1/2	469.9	15 25/32	400.8	9 1/2	241.3	PA2663-FN	19 1/2	495.3	11 17/32	292.9	6 17/32	165.9	PA3499
18 1/2	469.9	16 1/4	412.8	9 1/2	241.3	PA4571	19 1/2	495.3	12 1/32	305.6	7 11/16	195.3	PA2640
18 17/32	470.7	11 27/32	300.8	6 9/16	166.7	RS5484	19 1/2	495.3	12 3/32	307.2	7 11/16	195.3	PA3916
18 9/16	471.5	6 3/8	161.9	5 19/32	142.1	PA3494	19 1/2	495.3	12 1/8	308.0	7 11/16	195.3	LL2676
18 9/16	471.5	15 3/4	400.1	7 11/16	195.3	PA1847-FN	19 1/2	495.3	12 1/8	308.0	7 11/16	195.3	PA2676
18 9/16	471.5	16 5/32	410.4	7 7/16	188.9	LL2333	19 1/2	495.3	12 1/8	308.0	7 11/16	195.3	PA2676XP
18 9/16	471.5	16 5/32	410.4	9 1/2	241.3	PA2333	19 1/2	495.3	13	330.2	9 1/8	231.8	RS4642
18 19/32	472.3	9 9/32	235.7	5 5/32	131.0	RS4620	19 1/2	495.3	13 23/32	348.5	9 1/4	235.0	PA3497
18 19/32	472.3	11 13/16	300.0	7 7/8	200.0	PA5588	19 1/2	495.3	16 5/32	410.4	7 7/16	188.9	LL2393
18 5/8	473.1	5 9/16	141.3	4 11/16	119.1	PA2814	19 1/2	495.3	16 5/32	410.4	7 7/16	188.9	PA2393
18 5/8	473.1	6 13/32	162.7	5 9/32	134.1	PA5565	19 17/32	496.1	8 1/32	204.0	5 3/16	131.8	RS5430
18 5/8	473.1	12 31/32	329.4	6 13/16	173.0	RS3530	19 17/32	496.1	16 1/8	409.6	8 11/32	211.9	PA2629
18 5/8	473.1	12 31/32	329.4	6 13/16	173.0	RS3530XP	19 17/32	496.1	18 5/16	465.1	12 1/8	308.0	LL2507
18 21/32	473.9	11 15/16	303.2	7 17/32	191.3	PA2776	19 17/32	496.1	18 5/16	465.1	12 1/8	308.0	PA2507
18 21/32	473.9	11 15/16	303.2	7 17/32	191.3	PA30235	19 9/16	496.9	9 17/32	242.1	5 5/32	131.0	PA2475
18 21/32	473.9	14 1/4	362.0	9 29/32	251.6	PA2781	19 9/16	496.9	9 17/32	242.1	5 1/4	133.4	PA5524
18 11/16	474.7	12	304.8	7 11/16	195.3	PA5469	19 19/32	497.7	5 29/32	150.0	4 13/32	111.9	RS3745
18 23/32	475.5	10 17/32	267.5	6 19/32	167.5	RS5534	19 5/8	498.5	9 1/16	230.2	5 3/8	136.5	PA5259
18 23/32	475.5	12 1/16	306.4	7 11/16	195.3	PA3780	19 7/16	498.7	14	355.6	9	228.6	RS30128
18 3/4	476.3	11 13/16	300.0	7 7/8	200.0	PA5274	19 21/32	499.3	5 15/16	150.8	4 9/32	108.7	RS30160
18 3/4	476.3	12 7/8	327.0	8 1/2	215.9	PA3754	19 21/32	499.3	7 5/32	181.8	5 27/32	148.4	RS5510
18 3/4	476.3	15 1/32	381.8	9 9/16	242.9	PA2801	19 21/32	499.3	9 27/32	250.0	7 13/32	188.1	RS5461
18 13/16	477.8	4 7/8	123.8	4 11/16	119.1	PA5525	19 11/16	500.1	10 29/32	251.6	7	177.8	PA30040
18 7/8	479.4	9 31/32	253.2	5 23/32	145.3	RS30161	19 11/16	500.1	11	279.4	-	-	PA3987
18 7/8	479.4	10 1/2	266.7	6 11/16	169.9	RS4959	19 11/16	500.1	11 3/8	288.9	6 3/8	161.9	RS5756
18 7/8	479.4	10 31/32	278.6	5 13/16	147.6	RS3888	19 23/32	500.9	6 7/8	174.6	5 5/32	131.0	RS5313
18 7/8	479.4	11 7/8	301.6	7 17/32	191.3	PA5687	19 23/32	500.9	7 13/16	198.4	4 27/32	123.0	RS5767
18 7/8	479.4	12 29/32	327.8	7 17/32	191.3	PA3765	19 3/4	501.7	9 3/4	247.7	5 31/32	151.6	PA30037
18 29/32	480.2	9 29/32	251.6	6 3/16	157.2	RS5432	19 3/4	501.7	11	279.4	-	-	PA30073
18 15/16	481.0	9 9/32	235.7	5 5/32	131.0	RS3517	19 13/16	503.2	9 11/16	246.1	-	-	PA3891
18 15/16	481.0	9 9/32	235.7	5 5/32	131.0	RS3517XP	19 13/16	503.2	9 13/16	249.2	5 3/8	136.5	PA4984-FN
19	482.6	5 11/16	144.5	5 5/32	131.0	RS30224	19 13/16	503.2	10 3/8	263.5	6 1/32	153.2	PA2441
19	482.6	6 1/8	155.6	5 7/32	132.6	PA5499	19 13/16	503.2	11	279.4	-	-	PA4860
19	482.6	6 3/8	161.9	5 7/16	138.1	PA3896	19 13/16	503.2	11 1/32	280.2	-	-	PA4653
19	482.6	12 1/2	317.5	9 1/8	231.8	LL2609	19 13/16	503.2	13 1/2	342.9	-	-	PA30043
19	482.6	12 1/2	317.5	9 1/8	231.8	PA2609	19 13/16	503.2	13 17/32	343.7	-	-	PA2875
19 1/32	483.4	12 13/32	315.1	8 3/16	208.0	RS3514	19 7/8	504.8	7 1/4	184.2	6 3/16	157.2	PA5578
19 1/32	483.4	12 13/32	315.1	8 3/16	208.0	RS3514XP	19 7/8	504.8	9 3/32	231.0	4 13/16	122.2	PA2367
19 1/16	484.2	6 7/8	174.6	5 13/32	137.3	PA2654	19 7/8	504.8	10 27/32	275.4	6 1/2	165.1	PA5564
19 1/16	484.2	7 5/32	181.8	5 1/2	139.7	RS5462	19 29/32	505.6	10 31/32	278.6	5 13/16	147.6	RS3952
19 3/32	485.0	9 3/32	231.0	6 29/32	175.4	RS4580	19 15/16	506.4	4 1/4	108.0	3 7/16	87.3	RS5448
19 3/32	485.0	11 29/32	302.4	6 5/8	168.3	RS3714	19 31/32	507.2	7 1/16	179.4	5 11/16	144.5	RS3871
19 1/8	485.8	6 7/8	174.6	5 13/32	137.3	PA4574	19 31/32	507.2	7 1/16	179.4	5 11/16	144.5	RS4639
19 1/8	485.8	11 31/32	304.0	7 3/8	187.3	RS5332	19 31/32	507.2	12 1/32	305.6	7 11/16	195.3	PA2376
19 5/32	486.6	7 1/16	179.4	6 15/32	164.3	RS5673	20	508.0	7 1/2	190.5	5 1/4	133.4	PA2346
19 5/32	486.6	8 15/32	215.1	6 5/32	156.4	PA3861	20	508.0	10 11/16	271.5	6 11/16	164.9	RS4971
19 5/32	486.6	9 11/16	246.1	4 19/32	116.7	RS30180	20	508.0	11 25/32	299.2	7 3/4	196.9	RS5672
19 1/4	489.0	11 9/16	293.7	9	228.6	RS5744	20	508.0	12 3/4	323.9	8 3/8	212.7	PA5561
19 9/32	489.7	9 3/8	238.1	8 1/16	204.8	PA5574	20	508.0	13 7/8	352.4	7 7/16	188.9	LL2515
19 9/32	489.7	15 1/32	381.8	10 9/16	268.3	PA5552	20	508.0	13 7/8	352.4	7 7/16	188.9	PA2515
19 5/16	490.5	4 15/16	122.2	3 5/8	92.1	PA3631	20 1/32	508.8	10 31/32	278.6	5 13/16	147.6	RS5413
19 3/8	492.1	11	279.4	5 13/16	142.6	RS3730	20 1/8	511.2	9 5/8	244.5	5	127.0	PA3556
19 3/8	492.1	12 1/4	311.2	5 5/32	131.0	PA3477	20 5/32	512.0	13 19/32	345.3	5 25/32	146.8	RS5754
19 3/8	492.1	14 7/32	361.2	8 15/16	227.0	RS4579	20 3/16	512.8	11	279.4	6 1/2	165.1	PA5498
19 13/32	492.9	7 1/2	190.5	4 1/8	104.8	RS30237	20 3/16	512.8	12 29/32	327.8	8 5/8	219.1	PA3876
19 13/32	492.9	9 21/32	245.3	5 17/32	140.5	RS30223	20 1/4	514.4	7	177.8	4 13/32	111.9	PA1754
19 13/32	492.9	11 3/32	281.8	7 7/16	188.9	RS5540	20 1/4	514.4	7 15/16	201.6	3 9/16	90.5	PA3562
19 13/32	492.9	12 7/8	327.0	8 11/32	211.9	PA5445	20 9/32	515.1	12	304.8	7 11/16	195.3	PA5704
19 7/16	493.7	5 5/32	131.0	4 1/32	102.4	PA4983	20 11/32	516.7	9 3/32	231.0	6 29/32	175.4	RS4617
19 7/16	493.7	5 1/4	133.4	4 1/8	104.8	PA2378	20 3/8	517.5	7 5/8	193.7	6 1/16	154.0	PA2714
19 7/16	493.7	9 25/32	248.4	-	-	PA3493	20 3/8	517.5	7 15/16	201.6	4 5/8	117.5	PA2659
19 7/16	493.7	10 27/32	275.4	6 17/32	165.9	PA30109	20 3/8	517.5	10 3/8	263.5	6 1/32	153.2	PA2461
19 1/2	495.3	6 3/8	161.9	5 9/32	134.1	PA2583	20 3/8	517.5	12	304.8	6 7/8	174.6	PA2386
19 1/2	495.3	7 1/4	184.2	6 3/16	157.2	PA5705	20 3/8	517.5	12 3/16	309.6	7 1/4	184.2	RS30159



WARNING: These products can expose you to chemicals, including Diisononyl Phthalate, Carbon black extracts, Nickel, 1,3 Butadiene, Ethylene Oxide, Epichlorohydrin, which are known to the State of California to cause cancer, and Bisphenol-A, Ethylene Glycol, Ethylene Oxide, 1,3 Butadiene, Epichlorohydrin, which are known to the State of California to cause birth defects or other reproductive harm. For more information go to www.P65Warnings.ca.gov.

ROUND AIR FILTERS BY LENGTH

LENGTH Inches	LENGTH (mm)	O.D. Inches	O.D. (mm)	I.D. Inches	I.D. (mm)	BALDWIN NUMBER	LENGTH Inches	LENGTH (mm)	O.D. Inches	O.D. (mm)	I.D. Inches	I.D. (mm)	BALDWIN NUMBER
20 3/8.....	517.5	12 13/16.....	325.4	7 11/16.....	195.3	LL2518	21 1/2.....	546.1	16 1/8.....	409.6	7 7/16.....	188.9	PA2394
20 3/8.....	517.5	12 13/16.....	325.4	7 11/16.....	195.3	PA2518	21 17/32.....	546.9	10 15/16.....	277.8	6 9/32.....	159.5	PA2982
20 3/8.....	517.5	12 13/16.....	325.4	7 11/16.....	195.3	PA2518XP	21 17/32.....	546.9	16 5/32.....	410.4	9 1/2.....	241.3	PA2734
20 3/8.....	517.5	14.....	355.6	7 11/16.....	195.3	PA2396	21 9/16.....	547.7	7 1/8.....	181.0	5 1/2.....	139.7	PA2964
20 13/32.....	518.3	5 3/4.....	146.1	3 7/16.....	87.3	PA3899	21 19/32.....	548.5	6 7/8.....	174.6	5 7/16.....	138.1	PA2915
20 7/16.....	519.1	10 1/4.....	260.4	8.....	203.2	RS5429	21 5/8.....	549.3	5 1/4.....	133.4	4 1/8.....	104.8	PA1943
20 7/16.....	519.1	11 1/2.....	292.1	6 3/16.....	157.2	PA2387	21 5/8.....	549.3	10 31/32.....	278.6	5 27/32.....	148.4	RS3718
20 15/32.....	519.9	10 27/32.....	275.4	6 1/2.....	165.1	PA3938	21 5/8.....	549.3	12 13/32.....	315.1	8 3/16.....	208.0	RS3720
20 15/32.....	519.9	11 3/32.....	281.8	8.....	203.2	RS4993	21 11/16.....	550.9	13 3/32.....	332.6	7 3/8.....	187.3	RS4572
20 1/2.....	520.7	6 1/8.....	155.6	4 15/16.....	125.4	PA2787	21 11/16.....	550.9	13 3/32.....	332.6	7 3/8.....	187.3	RS4613
20 1/2.....	520.7	7 3/16.....	182.6	4 13/16.....	122.2	RS30134	21 25/32.....	553.2	12 3/32.....	307.2	7 11/16.....	195.3	PA30145
20 1/2.....	520.7	8 3/4.....	222.3	4 3/16.....	106.4	PA3630-FN	21 13/16.....	554.0	8 13/32.....	213.5	6 3/16.....	157.2	PA3889
20 1/2.....	520.7	10 13/32.....	264.3	6 15/16.....	176.2	PA2851	21 7/8.....	555.6	9 9/32.....	235.7	5 5/32.....	131.0	RS3974
20 1/2.....	520.7	10 27/32.....	275.4	6 1/2.....	165.1	LL2582	21 7/8.....	555.6	12 3/16.....	309.6	6 31/32.....	177.0	RS30116
20 1/2.....	520.7	10 27/32.....	275.4	6 1/2.....	165.1	PA2582	21 7/8.....	555.6	12 9/32.....	311.9	6 31/32.....	177.0	RS3728
20 1/2.....	520.7	11 1/8.....	282.6	6 3/4.....	171.5	PA2345	9 3/16.....	555.9	5 3/32.....	129.4	2 3/4.....	69.9	RS5748
20 1/2.....	520.7	11 1/2.....	292.1	7 1/4.....	184.2	PA2654	21 15/16.....	557.2	7 3/32.....	180.2	2 15/32.....	62.7	RS5593
20 1/2.....	520.7	12 1/8.....	308.0	7 23/32.....	196.1	PA2840	21 15/16.....	557.2	7 3/32.....	180.2	2 15/32.....	62.7	RS5593XP
20 1/2.....	520.7	12 15/32.....	316.7	7 7/8.....	200.0	PA3892							
20 1/2.....	520.7	13 13/16.....	350.8	9 1/2.....	241.3	PA2573	22 3/32.....	561.2	5 29/32.....	150.0	4 13/32.....	111.9	RS30181
20 1/2.....	520.7	13 13/16.....	350.8	9 1/2.....	241.3	PA2573XP	22 3/32.....	561.2	7 1/16.....	179.4	5 11/16.....	144.5	RS3827
20 1/2.....	520.7	14 7/32.....	361.2	8 15/16.....	227.0	RS4616	22 3/32.....	561.2	9 3/32.....	231.0	6 7/8.....	174.6	RS5460
20 17/32.....	521.5	11 11/16.....	296.9	6 11/16.....	169.9	PA2704	22 5/32.....	562.8	11 3/32.....	281.8	7 7/16.....	188.9	RS30175
20 17/32.....	521.5	12 9/32.....	311.9	6 31/32.....	177.0	RS3870	22 3/16.....	563.6	10 13/32.....	264.3	5 27/32.....	148.4	RS4563
20 9/16.....	522.3	5 17/32.....	140.5	4 25/32.....	121.4	RS3997	22 3/16.....	563.6	10 29/32.....	277.0	8 5/32.....	207.2	PA2364
20 9/16.....	522.3	10 31/32.....	278.6	5 13/16.....	147.6	RS3744	22 3/16.....	563.6	12 23/32.....	323.7	9 9/32.....	235.7	PA5465
20 9/16.....	522.3	10 31/32.....	278.6	5 13/16.....	147.6	RS3744XP	22 1/4.....	565.2	8 9/32.....	210.3	7 3/32.....	180.2	PA5569
20 9/16.....	522.3	12 3/32.....	307.2	7 11/16.....	195.3	RS5509	22 1/4.....	565.2	9 5/8.....	244.5	8 7/16.....	214.3	PA5481
20 9/16.....	522.3	12 5/32.....	308.8	5 3/16.....	131.8	PA2981	22 1/4.....	565.2	12 1/2.....	317.5	7 1/2.....	190.5	PA2614
20 9/16.....	522.3	12 9/32.....	311.9	6 31/32.....	177.0	RS4638	22 9/32.....	565.9	12 31/32.....	329.4	6 13/16.....	173.0	RS3926
20 5/8.....	523.9	8 5/32.....	207.2	4 3/16.....	106.4	RS5447	22 3/8.....	568.3	8 1/4.....	209.6	7 3/32.....	180.2	PA2457
20 5/8.....	523.9	12 1/8.....	308.0	7.....	1778.0	RS30135	22 7/16.....	569.9	14 7/32.....	361.2	8 15/16.....	227.0	RS5459
20 5/8.....	523.9	12 3/8.....	314.3	7 11/16.....	195.3	RS30133	22 7/16.....	569.9	15 1/32.....	381.8	10 9/16.....	268.3	RS5573
20 11/16.....	525.5	9 3/8.....	238.1	7 5/8.....	193.7	PA5553	22 15/32.....	570.7	11 11/16.....	296.9	6 23/32.....	170.7	PA2705
20 11/16.....	525.5	11.....	279.4	5 25/32.....	146.8	RS30216	22 15/32.....	570.7	11 11/16.....	296.9	6 23/32.....	170.7	PA4585
20 23/32.....	526.3	11 29/32.....	302.4	6 5/8.....	168.3	RS3726	22 1/2.....	571.5	7 1/16.....	179.4	6 13/32.....	162.7	RS5471
20 3/4.....	527.1	11 1/2.....	292.1	7 1/4.....	184.2	PA4573	22 1/2.....	571.5	7 15/16.....	201.6	9 9/16.....	90.5	PA3581
20 25/32.....	527.8	12.....	304.8	7 11/16.....	195.3	PA5577	22 1/2.....	571.5	10 1/4.....	260.4	9 1/8.....	231.8	PA2563
20 13/16.....	528.6	10 17/32.....	267.5	6 19/32.....	167.5	RS5358	22 1/2.....	571.5	10 13/32.....	264.3	6 15/16.....	176.2	PA2715
20 13/16.....	528.6	10 17/32.....	267.5	6 19/32.....	167.5	RS5508	22 1/2.....	571.5	11 7/8.....	301.6	10 1/4.....	260.4	PA2454
20 7/8.....	530.2	7 3/8.....	187.3	6 1/8.....	155.6	PA2615	22 1/2.....	571.5	12 3/32.....	307.2	7 11/16.....	195.3	PA3887
20 7/8.....	530.2	8 1/8.....	206.4	4 3/16.....	106.4	RS4794	22 1/2.....	571.5	12 1/2.....	317.5	7 1/2.....	190.5	PA3464
20 7/8.....	530.2	10.....	254.0	5 1/2.....	139.7	PA2377	22 1/2.....	571.5	12 3/4.....	323.9	8 11/32.....	211.9	PA2698
20 29/32.....	531.0	9 15/16.....	252.4	6.....	152.4	RS5488	22 1/2.....	571.5	12 3/4.....	323.9	8 11/32.....	211.9	PA3579
20 15/16.....	531.8	10 3/8.....	263.5	6 1/32.....	153.2	PA2430	22 1/2.....	571.5	13 13/16.....	350.8	9 1/2.....	241.3	PA1975
20 31/32.....	532.6	8 1/8.....	206.4	6 7/8.....	174.6	RS30009	22 1/2.....	571.5	13 13/16.....	350.8	9 1/2.....	241.3	PA3588
20 31/32.....	532.6	8 5/16.....	211.1	6 1/32.....	153.2	RS3721	22 1/2.....	571.5	13 7/8.....	352.4	9 1/2.....	241.3	PA5699
							22 1/2.....	571.5	14 1/2.....	368.3	9 1/2.....	241.3	PA2675
21.....	533.4	7 5/8.....	193.7	6 1/16.....	154.0	PA30146	22 17/32.....	572.3	16 5/32.....	410.4	7 7/16.....	188.9	PA2679
21.....	533.4	8 5/8.....	219.1	7 1/16.....	179.4	PA2672	22 9/16.....	573.1	6 7/8.....	174.6	5 7/16.....	138.1	RS5415
21.....	533.4	12.....	304.8	7 11/16.....	195.3	PA3559	22 19/32.....	573.9	7 15/16.....	201.6	4 5/8.....	117.5	PA3946
21.....	533.4	12 3/4.....	323.9	8 11/32.....	211.9	PA2398	22 19/32.....	573.9	9.....	228.6	5 11/16.....	144.5	PA2531
21 1/32.....	534.2	8 5/8.....	219.1	7 1/16.....	179.4	PA1976	22 5/8.....	574.7	7 29/32.....	200.8	7 9/16.....	192.1	RS3999
21 1/16.....	535.0	5 29/32.....	150.0	4 13/32.....	111.9	RS3719	22 5/8.....	574.7	12 3/4.....	23.9	8 5/16.....	211.1	PA2989
21 1/16.....	535.0	12 1/16.....	306.4	6 3/32.....	154.8	PA1952	22 11/16.....	576.3	10 5/8.....	269.9	6 1/4.....	158.8	PA2757
21 1/16.....	535.0	12 1/16.....	306.4	6 3/32.....	154.8	PA1953	22 13/16.....	579.4	10 3/8.....	263.5	6 1/32.....	153.2	LL2312
21 1/8.....	536.6	6 7/8.....	174.6	5 11/16.....	144.5	RS3729	22 13/16.....	579.4	10 3/8.....	263.5	6 1/32.....	153.2	PA2312
21 5/32.....	537.4	9 1/2.....	241.3	5 3/4.....	146.1	RS3996	22 13/16.....	579.4	10 5/8.....	269.9	7 1/4.....	184.2	PA2963
21 7/32.....	539.0	5 1/4.....	133.4	3 5/8.....	92.1	RS3975	22 27/32.....	580.2	6 25/32.....	172.2	5 3/8.....	136.5	PA3865
21 9/32.....	539.8	11 29/32.....	302.4	6 5/8.....	168.3	RS30143	22 27/32.....	580.2	10 5/8.....	269.9	7 1/4.....	184.2	PA2914
21 1/4.....	539.8	12 1/2.....	317.5	7 1/2.....	190.5	PA2490	22 29/32.....	581.8	10 31/32.....	278.6	5 13/16.....	147.6	RS30232
21 9/32.....	539.8	15 1/8.....	384.2	6 5/8.....	168.3	RS30143 KIT	22 29/32.....	581.8	11 1/32.....	280.2	5 13/16.....	147.6	RS30182
21 11/32.....	542.1	11 3/8.....	288.9	6 13/16.....	173.0	RS4564	22 29/32.....	581.8	11 13/32.....	289.7	7 5/8.....	193.7	RS5288XP
21 3/8.....	542.9	10 3/16.....	258.8	6 5/16.....	160.3	PA2786	22 29/32.....	581.8	12 9/32.....	311.9	6 31/32.....	177.0	RS3764
21 13/32.....	543.7	11 3/8.....	288.9	5 13/16.....	147.6	RS4618	22 29/32.....	581.8	12 9/32.....	311.9	6 31/32.....	177.0	RS3826
21 15/32.....	545.3	6 7/8.....	174.6	5 5/32.....	131.0	RS3927	22 15/16.....	582.6	8 1/2.....	215.9	5 3/8.....	136.5	PA1942
21 15/32.....	545.3	7 5/8.....	193.7	6 1/16.....	154.0	PA2362	22 31/32.....	583.4	8 23/32.....	221.5	7 1/32.....	178.6	RS30088
21 1/2.....	546.1	8 1/8.....	206.4	4 27/32.....	123.0	PA3898							
21 1/2.....	546.1	12 1/32.....	305.6	7 11/16.....	195.3	PA2713	23.....	584.2	8 21/32.....	219.9	5 3/16.....	131.8	PA2623



WARNING: These products can expose you to chemicals, including Diisononyl Phthalate, Carbon black extracts, Nickel, 1,3 Butadiene, Ethylene Oxide, Epichlorohydrin, which are known to the State of California to cause cancer, and Bisphenol-A, Ethylene Glycol, Ethylene Oxide, 1,3 Butadiene, Epichlorohydrin, which are known to the State of California to cause birth defects or other reproductive harm. For more information go to www.P65Warnings.ca.gov.

ROUND AIR FILTERS BY LENGTH

LENGTH Inches	LENGTH (mm)	O.D. Inches	O.D. (mm)	I.D. Inches	I.D. (mm)	BALDWIN NUMBER	LENGTH Inches	LENGTH (mm)	O.D. Inches	O.D. (mm)	I.D. Inches	I.D. (mm)	BALDWIN NUMBER
23	584.2	8 27/32	224.6	5 15/32	138.9	LL2482	25 13/32	645.3	11	279.4	-	-	PA2874
23	584.2	8 27/32	224.6	5 15/32	138.9	PA2482	25 1/2	647.7	9 9/32	235.7	5 25/32	146.8	RS4634
23	584.2	10 13/32	264.3	6 15/16	176.2	PA2703	25 1/2	647.7	9 9/32	235.7	5 25/32	146.8	RS4634XP
23	584.2	12 3/4	323.9	8 11/32	211.9	LL2317	25 17/32	648.5	9 9/32	235.7	5 25/32	146.8	RS3936
23	584.2	12 3/4	323.9	8 11/32	211.9	PA2317	25 17/32	648.5	13 17/32	343.7	-	-	PA2731
23 7/32	589.8	11 13/16	300.0	6 5/16	160.3	PA3484	25 19/32	650.1	11 1/2	292.1	7	177.8	PA3800
23 1/4	590.6	8 1/8	206.4	4 11/16	119.1	PA2785	25 19/32	650.1	13 1/2	342.9	-	-	PA4657
23 9/32	591.3	12 31/32	329.8	6 13/16	173.0	RS5414	25 19/32	650.1	13 1/2	342.9	-	-	PA30039
23 5/16	592.1	11 23/32	297.7	8 1/32	204.0	RS3998	25 23/32	653.3	10 31/32	278.6	-	-	PA5674
23 5/16	592.1	11 23/32	297.7	8 1/32	204.0	RS3998XP	25 3/4	654.1	7 3/8	187.3	6 1/8	155.6	PA2745
23 7/16	595.3	9 9/32	235.7	5 25/32	146.8	RS3516	25 13/16	655.6	13 3/32	332.6	7 3/8	187.3	RS3534
23 1/2	596.9	7 1/4	184.2	6 3/16	157.2	PA2903	25 7/8	657.2	7 3/8	187.3	6 1/8	155.6	PA1937
23 1/2	596.9	7 11/32	186.5	5 5/16	134.9	PA2726	25 7/8	657.2	9 3/4	247.7	-	-	PA2876
23 1/2	596.9	9 29/32	251.6	8 1/16	204.8	PA3498	25 7/8	657.2	9 25/32	248.4	-	-	PA2721
23 1/2	596.9	12 3/32	307.2	7 23/32	196.1	PA2962	25 7/8	657.2	11 1/32	280.2	-	-	PA2650
23 1/2	596.9	12 3/4	323.9	7 23/32	196.1	LL2361	25 7/8	657.2	11 1/32	280.2	-	-	PA2722
23 1/2	596.9	12 3/4	323.9	7 23/32	196.1	PA2361	25 7/8	657.2	13 17/32	343.7	-	-	PA2723
23 1/2	596.9	12 3/4	323.9	7 23/32	196.1	PA2361XP	25 7/8	657.2	13 17/32	343.7	-	-	PA2724
23 1/2	596.9	12 3/4	323.9	8 11/32	211.9	PA2580							
23 17/32	597.7	9 21/32	245.3	5 5/32	131.0	RS3743	26	660.4	13 7/8	352.4	7 7/16	188.9	PA2516
23 17/32	597.7	14 7/32	361.2	8	203.2	RS30008	26 1/32	661.2	14 13/16	376.2	9 19/32	243.7	PA5463
23 17/32	597.7	17 5/8	447.7	11 1/32	280.2	PA3637	26 7/32	666.0	13 9/32	337.3	7 5/32	131.8	PA3772
23 17/32	597.7	18 5/16	465.1	11	279.4	LL2363	26 1/2	673.1	10 3/8	263.5	6 1/16	154.0	PA3452
23 17/32	597.7	18 5/16	465.1	11	279.4	PA2363	26 1/2	673.1	11 7/8	301.6	7 1/8	181.0	PA2900
23 17/32	597.7	18 5/16	465.1	11	279.4	PA2363XP	26 1/2	673.1	12 3/4	323.9	8 11/32	211.9	PA2799
23 17/32	597.7	18 5/16	465.1	12 1/8	308.0	LL2453	26 1/2	673.1	12 3/4	323.9	8 11/32	211.9	PA2855
23 17/32	597.7	18 5/16	465.1	12 1/8	308.0	PA2453	26 1/2	673.1	12 3/4	323.9	8 11/32	211.9	PA2857
23 17/32	597.7	18 5/16	465.1	12 1/8	308.0	PA2453XP	26 1/2	673.1	12 3/4	323.9	8 11/32	211.9	PA2973
23 5/8	600.1	4 23/32	119.9	2 15/16	74.6	PA4876	26 1/2	673.1	12 3/4	323.9	8 11/32	211.9	PA3458
23 23/32	602.5	11 13/32	289.7	6 23/32	170.7	RS3539	26 1/2	673.1	12 25/32	324.6	8 11/32	211.9	PA3404
23 23/32	602.5	11 13/32	289.7	6 23/32	170.7	RS3539XP	26 1/2	673.1	12 25/32	324.6	8 11/32	211.9	PA3563
23 3/4	603.3	16 1/4	412.8	7 23/32	196.1	PA5323	26 1/2	673.1	13 13/16	350.8	9 1/2	241.3	PA3461
23 31/32	608.8	8 5/16	211.1	7 11/32	186.5	PA3787	26 1/2	673.1	13 13/16	350.8	9 1/2	241.3	PA3463
							26 1/2	673.1	13 13/16	350.8	9 1/2	241.3	PA3614
24	609.6	13 7/8	352.4	7 7/16	188.9	LL2559	26 5/8	676.3	12 3/4	323.9	8 11/32	211.9	PA3580
24	609.6	13 7/8	352.4	7 7/16	188.9	PA2559	26 5/8	676.3	13 7/8	352.4	8 7/16	214.3	PA3560
24 1/32	610.4	12 25/32	324.6	8 3/8	212.7	LL2456	26 5/8	676.3	15 31/32	405.6	8 5/16	211.1	PA2988
24 1/32	610.4	12 25/32	324.6	8 3/8	212.7	PA2456							
24 1/32	610.4	12 25/32	324.6	8 3/8	212.7	PA2456XP	27	685.8	10 3/8	263.5	6 1/32	153.2	LL2493
24 1/8	612.8	7 15/16	201.6	4 5/8	117.5	PA2649	27	685.8	10 3/8	263.5	6 1/32	153.2	PA2493
24 1/4	616.0	12 29/32	327.8	8 1/2	215.9	PA3606	27	685.8	12 3/4	323.9	8 11/32	211.9	LL2608
24 3/8	619.1	11 9/16	293.7	9	228.6	RS5294	27	685.8	12 3/4	323.9	8 11/32	211.9	PA2608
24 7/16	620.7	12 31/32	329.4	8 3/8	212.7	PA5568	27	685.8	12 3/4	323.9	8 3/8	212.7	PA2357
24 1/2	622.3	9 1/4	235.0	6 3/4	171.5	PA3691	27	685.8	13 7/8	352.4	7 7/16	188.9	LL2458
24 1/2	622.3	12 1/8	308.0	7 11/16	195.3	PA2902	27	685.8	13 7/8	352.4	7 7/16	188.9	PA2458
24 1/2	622.3	13 11/32	338.9	8 11/32	211.9	PA4566	27 1/16	687.4	12 1/2	317.5	7 1/2	190.5	PA2744
24 1/2	622.3	14 1/4	362.0	9 15/16	252.4	PA5480	27 5/16	693.7	14 1/2	368.3	9 1/2	241.3	PA3806
24 1/2	622.3	14 11/16	373.1	10 11/32	262.7	LL2562	27 5/16	693.7	14 1/2	368.3	9 1/2	241.3	PA4606
24 1/2	622.3	14 11/16	373.1	10 11/32	262.7	PA2562	27 1/2	698.5	12 1/2	317.5	7 1/2	190.5	PA1936
24 1/2	622.3	14 11/16	373.1	10 11/32	262.7	PA2562XP	27 1/2	698.5	13 13/16	350.8	9 1/2	241.3	PA3587
24 1/2	622.3	15 3/8	390.5	10 11/32	262.7	PA2849	27 5/8	701.7	10	254.0	4 23/32	119.9	PA4887
24 1/2	622.3	15 25/32	400.8	10	254.0	PA3496							
24 5/8	625.5	9 3/32	231.0	7	177.8	RS4629	28 3/16	716.0	7 3/4	196.9	4	101.6	PA2771
24 5/8	625.5	11 11/16	296.9	7 27/32	199.2	RS5470	28 1/4	717.6	9 29/32	251.6	8 1/16	204.8	PA2747
24 5/8	625.5	12 23/32	323.1	7 13/16	198.4	RS5472	28 13/32	721.5	11 11/16	296.9	6 11/16	169.9	PA2680
24 3/4	628.7	10 7/8	276.2	6 23/32	170.7	PA3644	28 7/16	722.3	9 1/2	241.3	6 1/2	165.1	PA2658
24 3/4	628.7	22	558.8	15 9/16	395.3	PA3633	28 1/2	723.9	8 21/32	219.9	5 3/16	131.8	PA3478
24 13/16	630.2	13 3/32	332.6	7 5/8	193.7	RS5287XP	28 1/2	723.9	8 21/32	219.9	5 3/16	131.8	PA3478XP
24 13/16	630.2	13 3/32	332.6	7 5/8	193.7	RS30187XP	28 1/2	723.9	8 27/32	224.6	5 13/16	147.6	PA2755
24 27/32	631.0	9 21/32	245.3	5 5/32	131.0	RS4646	28 1/2	723.9	9	228.6	5 11/16	144.5	PA2532
24 27/32	631.0	14 7/32	361.2	8 15/16	227.0	RS4989	28 1/2	723.9	9 1/2	241.3	6 1/2	165.1	PA2628
24 7/8	631.8	17 23/32	450.1	11 7/16	290.5	RS5743	28 1/2	723.9	9 11/16	246.1	5 3/16	131.8	PA2718
24 7/8	631.8	17 23/32	450.1	11 7/16	290.5	RS5743XP	28 1/2	723.9	10 13/32	264.3	6 15/16	176.2	PA2660
							28 1/2	723.9	13 13/16	350.8	9 1/2	241.3	PA3569
25	635.0	11 7/8	301.6	7 3/8	187.3	PA2729	29	736.6	8 11/16	220.7	2 3/16	55.6	PA2500
25	635.0	12 3/4	323.9	8 11/32	211.9	PA2631	29	736.6	8 27/32	224.6	5 13/16	147.6	LL2503
25	635.0	14	355.6	9	228.6	RS30087	29	736.6	8 27/32	224.6	5 13/16	147.6	PA2503
25	635.0	16 5/8	422.3	12	304.8	PA3584	29	736.6	10 13/32	264.3	6 15/16	176.2	PA2732
25 9/32	642.1	9 11/32	237.3	8 1/8	206.4	PA3810							



WARNING: These products can expose you to chemicals, including Diisononyl Phthalate, Carbon black extracts, Nickel, 1,3 Butadiene, Ethylene Oxide, Epichlorohydrin, which are known to the State of California to cause cancer, and Bisphenol-A, Ethylene Glycol, Ethylene Oxide, 1,3 Butadiene, Epichlorohydrin, which are known to the State of California to cause birth defects or other reproductive harm. For more information go to www.P65Warnings.ca.gov.

ROUND AIR FILTERS BY LENGTH

LENGTH Inches	LENGTH (mm)	O.D. Inches	O.D. (mm)	I.D. Inches	I.D. (mm)	BALDWIN NUMBER	LENGTH Inches	LENGTH (mm)	O.D. Inches	O.D. (mm)	I.D. Inches	I.D. (mm)	BALDWIN NUMBER
29	736.6	10 13/32	264.3	6 15/16	176.2	PA3951	34 5/8	879.5	12 3/4	323.9	8 3/8	212.7	PA3595
29	736.6	12 3/4	323.9	8 11/32	211.9	PA2632	34 5/8	879.5	12 3/4	323.9	8 5/16	211.1	PA3611
29 1/2	749.3	13 7/8	352.4	10	254.0	PA2746							
29 3/4	755.7	12 3/4	323.9	8 3/8	212.7	PA2796	36 5/8	930.3	12 3/4	323.9	8 3/8	212.7	PA3568
30 1/32	762.8	17 23/32	450.1	11 7/16	290.5	RS5293	36 1/2	927.1	12 25/32	324.6	8 11/32	211.9	PA3638
30 1/32	762.8	17 23/32	450.1	11 7/16	290.5	RS5293XP	36 5/8	930.3	13 7/8	352.4	8 3/8	212.7	PA3576
32 1/2	825.5	7 15/16	201.6	3 9/16	90.5	PA3640							

NOTES



WARNING: These products can expose you to chemicals, including Diisononyl Phthalate, Carbon black extracts, Nickel, 1,3 Butadiene, Ethylene Oxide, Epichlorohydrin, which are known to the State of California to cause cancer, and Bisphenol-A, Ethylene Glycol, Ethylene Oxide, 1,3 Butadiene, Epichlorohydrin, which are known to the State of California to cause birth defects or other reproductive harm. For more information go to www.P65Warnings.ca.gov.

PANEL AIR FILTERS

LENGTH x WIDTH x THICK Inches	LENGTH x WIDTH x THICK (mm)	BALDWIN NUMBER	LENGTH x WIDTH x THICK Inches	LENGTH x WIDTH x THICK (mm)	BALDWIN NUMBER
8 31/32 x 6 31/32 x 2 17/32	227.8 x 177.0 x 64.3	PA5312 KIT	9 21/32 x 8 1/8 x 2 1/16	245.3 x 206.4 x 52.4	PA4060
9 x 4 5/32 x 25/32	228.6 x 105.6 x 19.8	PA30229	9 11/16 x 5 5/8 x 2 5/16	246.1 x 142.9 x 58.7	PA10057
9 x (5 1/8 to 7) x 1 15/16	228.6 x (130.2 to 177.8) x 49.2	PA4421	9 11/16 x 6 5/16 x 1 15/32	246.1 x 160.3 x 37.3	PA4084
9 x 7 x 1 3/8	228.6 x 177.8 x 34.9	PA3777	9 11/16 x 7 5/16 x 1 15/16	246.1 x 185.7 x 49.2	PA4452
9 x 7 1/8 x 1 27/32	228.6 x 181.0 x 46.8	PA5631	9 23/32 x 6 17/32 x 1 3/8	246.9 x 165.9 x 34.9	PA5633
9 x 7 3/4 x 2 7/32	228.6 x 196.9 x 56.4	PA4160	9 23/32 x 7 29/32 x 1 29/32	246.9 x 200.8 x 48.4	PA4471
9 x 7 13/16 x 1 1/4	228.6 x 198.4 x 31.8	PA4405	9 23/32 x 8 1/2 x 29/32	246.9 x 215.9 x 23.0	PA4317
9 x 8 19/32 x 1 15/16	228.6 x 218.3 x 49.2	PA10064	9 3/4 x 9 5/32 x 1 3/16	247.7 x 232.6 x 30.2	PA4486
9 x 9 x 2 9/16	228.6 x 228.6 x 65.1	PA3495	9 13/16 x 4 11/16 x 2	249.2 x 119.1 x 50.8	PA4031
9 x 9 x 2 9/16	228.6 x 228.6 x 65.1	PA3804	9 13/16 x 4 3/4 x 2 3/32	249.2 x 120.7 x 53.2	PA4305
9 1/32 x 5 1/32 x 1/4	229.4 x 127.8 x 6.4	PA30165	9 13/16 x 6 5/8 x 1 17/32	249.2 x 168.3 x 38.9	PA4311
9 1/32 x 6 5/8 x 1 7/32	229.4 x 168.3 x 31.0	PA4018	9 27/32 x 5 15/32 x 2 1/16	250.0 x 138.9 x 52.4	PA4049
9 1/32 x 7 3/16 x 1 5/8	229.4 x 182.6 x 41.3	PA3929	9 27/32 x 6 11/16 x 2	250.0 x 169.9 x 50.8	PA2214
9 1/32 x 7 9/32 x 2 1/16	229.4 x 184.9 x 52.4	PA4015	9 27/32 x 7 13/16 x 25/32	250.0 x 198.4 x 19.8	PA30173
9 1/16 x 5 5/16 x 1 11/32	230.2 x 134.9 x 34.1	PA4442	9 27/32 x 8 x 1 13/32	250.0 x 203.2 x 35.7	PA4474
9 1/16 x 6 1/8 x 1 3/16	230.2 x 155.6 x 30.2	PA5714	9 27/32 x 9 1/4 x 31/32	250.0 x 235.0 x 24.6	PA5798
9 1/16 x 7 7/16 x 2 9/32	230.2 x 188.9 x 57.9	PA4441	9 7/8 x 8 13/32 x 2 3/32	250.8 x 213.5 x 53.2	PA4380
9 1/16 x 7 7/8 x 2 5/32	230.2 x 200.0 x 54.8	PA4108	9 7/8 x 8 23/32 x 1 3/16	250.8 x 221.5 x 30.2	PA4334
9 3/32 x 6 7/8 x 2 23/32	231.0 x 174.6 x 69.1	PA4938	9 29/32 x 7 27/32 x 2 1/16	251.6 x 199.2 x 52.4	PA4144
9 3/32 x 7 19/32 x 13 3/4	231.0 x 192.9 x 349.3	PA31006	9 15/16 x 7 1/32 x 1 9/16	252.4 x 178.6 x 39.7	PA4044
9 1/8 x 4 9/16 x 1 11/32	231.8 x 115.9 x 34.1	PA4469	9 15/16 x 7 1/32 x 2 3/16	252.4 x 178.6 x 55.6	PA4163
9 1/8 x 7 15/32 x 2 9/32	231.8 x 189.7 x 57.9	PA4447	(9 15/16 to 11 31/32) x 8 21/32 x 1/2	(252.4 to 304.0) x 219.9 x 12.7	PA10017
9 1/8 x 7 19/32 x 9 7/8	231.8 x 192.9 x 250.8	PA31004	9 31/32 x 6 1/32 x 2 3/16	253.2 x 153.2 x 55.6	PA5663
9 1/8 x 8 17/32 x 1 31/32	231.8 x 216.7 x 50.0	PA4198	9 31/32 x 6 25/32 x 1 13/32	253.2 x 172.2 x 35.7	PA10008
9 1/8 x 8 21/32 x 5/16	231.8 x 219.9 x 7.9	PA4392	9 31/32 x 6 13/16 x 1 23/32	253.2 x 173.0 x 43.7	PA4348
9 5/32 x 7 29/32 x 15/16	232.6 x 200.8 x 23.8	PA5622	9 31/32 x 9 3/16 x 1 23/32	253.2 x 233.4 x 43.7	PA4361
9 5/32 x 8 15/32 x 1 27/32	232.6 x 215.1 x 46.8	PA4436	10 x (5 1/2 to 9 9/32) x 2 1/4	254.0 x (139.7 to 235.7) x 57.2	PA4333
9 3/16 x 8 13/16 x 2 1/4	233.4 x 233.8 x 57.2	PA10041	10 x 5 5/8 x 25/32	254.0 x 142.9 x 19.8	PA5327
9 7/32 x 8 7/16 x 23/32	234.2 x 214.3 x 18.3	PA4371	10 x 6 x 2 3/16	254.0 x 152.4 x 55.6	PA3613
9 7/32 x 8 21/32 x 1 1/8	234.2 x 219.9 x 28.6	PA4196	10 x 6 7/8 x 1 5/8	254.0 x 174.6 x 41.3	PA4308
9 7/32 x 8 15/16 x 1 13/16	234.2 x 227.0 x 46.0	PA10004	10 x 10 x 2 9/16	254.0 x 254.0 x 65.1	PA3473
9 7/16 x 8 1/32 x 1 13/16	234.7 x 204.0 x 46.0	PA4386	10 1/32 x 7 7/16 x 1 15/32	254.8 x 188.9 x 37.3	PA4314
9 1/4 x 7 7/32 x 1 13/32	235.0 x 183.4 x 35.7	PA30141	10 1/32 x 7 15/16 x 1 7/32	254.8 x 210.6 x 31.0	PA30140
9 1/4 x 8 1/8 x 1 5/8	235.0 x 206.4 x 41.3	PA10070	10 1/16 x 7 5/32 x 1 9/16	255.6 x 181.8 x 39.7	PA4069
9 9/32 x 6 25/32 x 23/32	235.7 x 172.2 x 18.3	PA10002	10 1/16 x 8 3/4 x 11/16	255.6 x 222.3 x 17.5	PA4398
9 9/32 x 7 27/32 x 2 15/16	235.7 x 199.2 x 74.6	PA4407	10 3/32 x 7 x 1 5/16	256.4 x 177.8 x 33.3	PA2201
9 9/32 x 7 15/16 x 1 9/16	235.7 x 201.6 x 39.7	PA2212	10 3/32 x 7 15/16 x 1 23/32	256.4 x 201.6 x 43.7	PA4400
9 9/32 x 8 7/16 x 1 17/32	235.7 x 214.3 x 38.9	PA4335	10 3/32 x 9 13/16 x 1 21/32	256.4 x 249.2 x 42.1	PA4454
9 9/32 x 8 19/32 x 25/32	235.7 x 218.3 x 19.8	PA10009	10 3/32 x 10 1/32 x 1 3/4	256.4 x 254.8 x 44.5	PA10036
9 9/32 x 8 13/16 x 2 5/16	235.7 x 223.8 x 58.7	PA4349	10 1/8 x 5 1/32 x 3/16	257.2 x 127.8 x 4.8	PA5773
9 5/16 x 4 x 7/8 and	236.5 x 101.6 x 22.2	PA4403	10 1/8 x 7 3/4 x 1 11/16	257.2 x 196.9 x 42.9	PA4468
9 1/4 x 3 25/32 x 7/8	(235.0 x 96.0 x 22.2)		10 1/8 x 8 9/32 x 1 11/16	257.2 x 210.3 x 42.9	PA4023
9 5/16 x 6 11/32 x 2 9/32	236.5 x 161.1 x 57.9	PA5314	10 1/8 x 8 7/16 x 2 3/16	257.2 x 214.3 x 65.6	PA4091
9 5/16 x 7 3/32 x 1 19/32	236.5 x 180.2 x 40.5	PA2231	10 5/32 x 3 31/32 x 31/32	258.0 x 100.8 x 24.6	PA4410 KIT
9 11/32 x 5 7/16 x 29/32	237.3 x 138.1 x 23.0	PA4149 KIT	10 5/32 x 5 3/4 x 1 7/8	258.0 x 146.1 x 47.6	PA4479
9 11/32 x 8 7/16 x 1 3/8	237.3 x 214.3 x 34.9	PA4426	10 5/32 x 6 13/32 x 2 1/16	258.0 x 162.7 x 52.4	PA4480
9 11/32 x 8 7/16 x 1 21/32	237.3 x 214.3 x 42.1	PA4132	10 5/32 x 6 13/32 x 2 3/32	258.0 x 162.7 x 53.2	PA10027
9 3/8 x (4 1/2 to 8 3/8) x 1 25/32	238.1 x (114.3 to 212.7) x 45.2	PA4329	10 5/32 x 6 1/2 x 1 11/16	258.0 x 165.1 x 42.9	PA4325
9 3/8 x 7 1/2 x 1 9/16	238.1 x 190.5 x 39.7	PA4313	10 5/32 x 6 17/32 x 27/32	258.0 x 165.9 x 21.4	PA30177
9 3/8 x 8 27/32 x 1 31/32	238.1 x 224.6 x 50.0	PA4178	10 5/32 x 8 3/16 x 2 3/32	258.0 x 208.0 x 53.2	PA10000
9 7/16 x 6 31/32 x 2 3/32	239.7 x 177.0 x 53.2	PA4446	10 3/16 x 5 7/8 x 2 7/32	258.8 x 149.2 x 56.4	PA4047
9 7/16 x 7 11/16 x 1 17/32	239.7 x 195.3 x 38.9	PA30151	10 3/16 x 7 x 1 31/32	258.8 x 177.8 x 50.0	PA4309
9 7/16 x 8 x 1 3/16	239.7 x 203.2 x 30.2	PA10014	10 7/32 x 6 15/32 x 2 13/32	259.6 x 164.3 x 61.1	PA4463
9 7/16 x 8 7/8 x 2 1/4	239.7 x 225.4 x 57.2	PA4790	10 1/4 x 6 17/32 x 1 13/32	260.4 x 165.9 x 35.7	PA5733
9 1/2 x 7 x 1 3/32	241.3 x 177.8 x 27.8	PA30096	10 1/4 x 6 3/4 x 2	260.4 x 171.5 x 50.8	PA2168
9 17/32 x 4 1/2 x 1 1/4	242.1 x 114.3 x 31.8	PA2138	10 1/4 x 7 3/32 x 1 17/32	260.4 x 180.2 x 38.9	PA4138
9 17/32 x 6 23/32 x 1/4	242.1 x 170.8 x 6.4	PA30166	10 1/4 x 8 x 2 1/4	260.4 x 203.2 x 57.2	PA4126
9 17/32 x 6 25/32 x 1 31/32	242.1 x 172.2 x 50.0	PA10039	10 9/32 x 6 23/32 x 1 23/32	261.1 x 170.7 x 43.7	PA4095
9 17/32 x 7 3/32 x 1 19/32	242.1 x 180.2 x 40.5	PA4109	10 9/32 x 7 29/32 x 1 3/16	261.1 x 200.8 x 30.2	PA10067
9 17/32 x 7 5/8 x 2 1/32	242.1 x 193.7 x 51.6	PA4375	10 5/16 x (3 13/16 to 6 15/16) x 2 9/32	261.9 x (96.8 to 176.2) x 57.9	PA10037
9 17/32 x 9 17/32 x 1 9/16	242.1 x 242.1 x 39.7	PA2191	10 5/16 x 5 21/32 x 1 1/2	261.9 x 143.7 x 38.1	PA4376
9 9/16 x (5 9/32 to 7 15/32) x 2 3/16	242.9 x (134.1 to 189.7) x 55.6	PA10010	10 5/16 x 8 3/32 x 1 3/4	261.9 x 205.6 x 44.5	PA4364
9 9/16 x 6 15/32 x 2 1/8	242.9 x 164.3 x 54.0	PA4382	10 5/16 x 8 7/32 x 1 3/16	261.9 x 208.8 x 30.2	PA10042
9 9/16 x 8 29/32 x 2 1/8	242.9 x 226.2 x 54.0	PA4449	10 11/32 x 5 9/32 x 2 3/16	262.7 x 134.1 x 55.6	PA4363
9 19/32 x 9 1/8 x 1 5/16	243.7 x 231.8 x 33.3	PA30174	10 11/32 x 5 15/32 x 31/32	262.7 x 138.9 x 24.6	CV15002
9 5/8 x 8 3/4 x 2 3/16	244.5 x 222.3 x 55.6	PA4438	10 11/32 x 6 1/4 x 11/16	262.7 x 158.8 x 17.5	PA4757
9 21/32 x 5 5/16 x 25/32	245.3 x 134.9 x 18.3	PA30080	10 11/32 x 6 13/32 x 1 19/32	262.7 x 162.8 x 40.4	PA2229
9 21/32 x 5 7/16 x 1 9/16	245.3 x 138.1 x 39.7	PA2204	10 11/32 x 6 1/2 x 1 9/16	262.7 x 165.1 x 39.7	PA5341
9 21/32 x 6 5/16 x 1 15/32	245.3 x 160.3 x 37.3	PA4043	10 11/32 x 6 23/32 x 1 13/32	262.7 x 170.7 x 35.7	PA4370
9 21/32 x 7 x 2 5/16	245.3 x 177.8 x 58.7	PA4048	10 3/8 x 7 x 1 13/32	263.5 x 177.8 x 35.7	PA5772
9 21/32 x 8 1/32 x 3/4	245.3 x 204.0 x 19.1	PA4404	10 3/8 x 9 19/32 x 1 3/16	263.5 x 243.7 x 30.2	PA4462



WARNING: These products can expose you to chemicals, including Diisononyl Phthalate, Carbon black extracts, Nickel, 1,3 Butadiene, Ethylene Oxide, Epichlorohydrin, which are known to the State of California to cause cancer, and Bisphenol-A, Ethylene Glycol, Ethylene Oxide, 1,3 Butadiene, Epichlorohydrin, which are known to the State of California to cause birth defects or other reproductive harm. For more information go to www.P65Warnings.ca.gov.

PANEL AIR FILTERS

LENGTH x WIDTH x THICK Inches	LENGTH x WIDTH x THICK (mm)	BALDWIN NUMBER	LENGTH x WIDTH x THICK Inches	LENGTH x WIDTH x THICK (mm)	BALDWIN NUMBER
10 13/32 x 5 5/8 x 11/16	264.3 x 142.9 x 17.5	PA4756	11 1/8 x 8 15/16 x 2 21/32	282.6 x 227.0 x 67.5	CV15000
10 13/32 x 7 1/2 x 2 3/32	264.3 x 190.5 x 53.2	PA4477	11 3/16 x 8 15/16 x 1 7/8	284.2 x 227.0 x 47.6	PA4451
10 13/32 x 8 3/8 x 1 25/32	264.3 x 212.7 x 45.2	PA4073	11 3/16 x 9 15/16 x 1 9/16	284.2 x 252.4 x 39.7	PA4485
10 7/16 x 5 15/32 x 1 1/2	265.1 x 138.9 x 38.1	PA31011	11 3/16 x 9 15/16 x 1 11/16	284.2 x 252.4 x 42.9	PA4487
10 7/16 x 5 3/4 x 1 7/8	265.1 x 146.1 x 47.6	PA4123	11 3/16 x 10 3/16 x 2 9/32	284.2 x 258.8 x 57.9	PA10033
10 7/16 x 6 1/2 x 3/8	265.1 x 165.1 x 9.5	PA30107	11 7/32 x 6 1/8 x 1 7/32	285.0 x 155.6 x 31.0	PA2150
10 7/16 x 6 19/32 x 1 5/16	265.1 x 167.5 x 33.3	PA4114	11 7/32 x 6 11/32 x 1 5/8	285.0 x 161.1 x 41.3	PA4303
10 7/16 x 7 1/8 x 1 7/16	265.1 x 181.0 x 36.5	PA4353	11 7/32 x 7 x 29/32	285.0 x 177.8 x 23.0	PA30127
10 7/16 x 10 13/32 x 1 23/32	265.1 x 264.3 x 43.7	PA4465	11 7/32 x 7 17/32 x 1 25/32	285.0 x 191.3 x 45.2	PA2152
10 15/32 x 9 29/32 x 1 7/8	265.9 x 251.6 x 47.6	PA4323	11 1/4 x (5 1/2 to 6 13/32) x 2 9/16	285.8 x (139.7 to 162.7) x 65.1	PA4129
10 15/32 x 10 3/16 x 1 15/32	265.9 x 258.8 x 37.3	PA4453	11 1/4 x (6 to 8 9/32) x 2 1/4	285.8 x (152.4 to 210.3) x 57.2	PA4395
10 1/2 x 6 23/32 x 1 21/32	266.7 x 170.7 x 42.1	PA2243	11 1/4 x 6 19/32 x 1 21/32	285.8 x 167.5 x 42.1	PA2237
10 1/2 x 7 7/8 x 1 9/16	266.7 x 200.0 x 39.7	PA4146	11 1/4 x 8 5/8 x 29/32	285.8 x 219.1 x 23.0	PA4330
10 17/32 x (2 5/8 to 6 23/32) x 1 15/16	267.5 x (66.7 to 170.7) x 49.2	PA4417	11 9/32 x 8 29/32 x 1 19/32	286.5 x 226.2 x 40.5	PA2149
10 9/16 x (5 to 8 21/32) x 2 1/32	268.3 x (127.0 to 219.9) x 51.6	PA4374	11 9/32 x 8 15/16 x 1 29/32	286.5 x 227.0 x 48.4	PA3822
10 9/16 x 6 5/16 x 1 31/32	268.3 x 160.3 x 50.0	PA4175	11 9/32 x 9 13/16 x 2 23/32	286.5 x 249.2 x 69.1	PA4467
10 9/16 x 6 7/8 x 2 3/8	268.3 x 174.6 x 60.3	PA4402	11 5/16 x 10 x 1 25/32	287.3 x 254.0 x 45.2	PA10001
10 9/16 x 7 7/16 x 1 3/8	268.3 x 188.9 x 34.9	PA4357	11 5/16 x 10 1/2 x 1 1/2	287.3 x 266.7 x 38.1	PA31001
10 9/16 x 8 1/4 x 8 1/16	268.3 x 209.6 x 204.8	PA1774	11 11/32 x 3 15/32 x 25/32	288.1 x 88.1 x 19.8	PA5405
10 9/16 x 8 31/32 x 2 7/32	268.3 x 227.8 x 56.4	PA4082	11 11/32 x 6 5/8 x 1 7/16	288.1 x 168.3 x 36.5	PA5624
10 9/16 x 9 31/32 x 1 7/32	268.3 x 253.2 x 31.0	PA4133	11 11/32 x 7 1/4 x 1 1/16	288.1 x 184.2 x 27.0	PA4192
10 9/16 x 10 9/16 x 8 1/8	268.3 x 268.3 x 206.4	PA1776	11 11/32 x 8 15/32 x 1 13/32	288.1 x 215.1 x 35.7	PA4167
10 19/32 x 3 9/16 x 1 3/32	269.1 x 90.5 x 27.8	PA5698	11 3/8 x (2 1/8 to 6 15/32) x 1 5/8	288.9 x (54.0 to 164.3) x 41.3	PA4190
10 19/32 x 7 9/32 x 1 21/32	269.1 x 187.9 x 42.1	PA4484	11 3/8 x 5 1/16 x 15/16	288.9 x 128.6 x 23.8	PA4152
10 19/32 x 7 7/8 x 1 21/32	269.1 x 200.0 x 42.1	PA2189	11 3/8 x 5 29/32 x 2	288.9 x 150.0 x 50.8	PA4180
10 19/32 x 10 19/32 x 3/4	269.1 x 269.1 x 19.1	PA5319	11 3/8 x 6 9/16 x 3/8	288.9 x 166.7 x 9.5	PA5662
10 5/8 x 4 3/4 x 2 7/32	269.9 x 120.7 x 56.4	PA5774	11 3/8 x 9 3/8 x 2 3/32	288.9 x 238.1 x 53.2	PA4429
10 5/8 x 6 3/32 x 1 3/8	269.9 x 154.8 x 34.9	PA2121	11 3/8 x 9 3/4 x 1 15/32	288.9 x 247.7 x 37.3	PA4046
10 5/8 x 7 3/32 x 1 3/8	269.9 x 180.2 x 35.1	PA10040	11 3/8 x 10 7/16 x 6 19/32	288.9 x 265.1 x 167.5	PA31010
10 5/8 x 7 13/32 x 1 25/32	269.9 x 188.1 x 45.2	PA3414	11 3/8 x 11 3/8 x 1 3/32	288.9 x 288.9 x 27.8	PA10023
10 5/8 x 7 17/32 x 1 31/32	269.9 x 191.3 x 50.0	PA4387	11 3/8 x 11 3/8 x 1 3/4	288.9 x 288.9 x 44.5	PA4975
10 5/8 x 9 1/16 x 1 3/16	269.9 x 230.2 x 30.2	PA5516	11 13/32 x 4 23/32 x 1 23/32	289.7 x 119.9 x 43.7	PA3986
10 5/8 x 9 7/16 x 1	269.9 x 239.7 x 25.4	PA4169	11 13/32 x 6 1/8 x 1 1/8	289.7 x 155.6 x 28.6	PA10038
10 5/8 x 10 5/8 x 31/32	269.9 x 269.9 x 24.6	PA4857	11 13/32 x 6 5/16 x 1 3/16	289.7 x 160.3 x 30.2	PA4954
10 11/16 x 10 3/32 x 1 9/16	271.5 x 256.4 x 39.7	PA10015	11 13/32 x 7 19/32 x 1 31/32	289.7 x 192.9 x 50.0	PA4338
10 23/32 x 4 3/32 x 1 3/32	272.3 x 104.0 x 27.8	PA5650	11 15/32 x 5 3/32 x 1 13/16	291.3 x 129.4 x 46.0	PA4932
10 23/32 x 7 23/32 x 25/32	272.3 x 196.1 x 19.8	PA30113	11 15/32 x 7 11/32 x 1 5/32	291.3 x 186.5 x 29.4	PA4154
10 23/32 x 9 11/16 x 1 17/32	272.3 x 246.1 x 38.9	PA4164	11 15/32 x 8 5/16 x 1 19/32	291.3 x 211.1 x 40.5	PA4179
10 3/4 x 5 1/4 x 1 19/32	273.1 x 133.4 x 40.5	PA2103	11 15/32 x 8 11/32 x 1 1/2	291.3 x 211.9 x 38.1	PA4177
10 3/4 x 6 1/2 x 1 21/32	273.1 x 165.1 x 42.1	PA4079	11 15/32 x 9 1/16 x 2 5/16	291.3 x 230.2 x 58.7	PA4367
10 21/32 x 7 1/16 x 1 5/16	273.1 x 179.4 x 33.3	PA10025	11 1/2 x 7 1/32 x 1 21/32	292.1 x 178.6 x 42.1	PA2196
10 3/4 x 9 13/16 x 1 27/32	273.1 x 249.2 x 46.8	PA4425	11 1/2 x 7 3/32 x 2 1/4	292.1 x 180.2 x 57.2	PA4147
10 25/32 x 6 5/8 x 1 21/32	273.8 x 168.3 x 42.1	PA4104	11 1/2 x 8 3/16 x 1 23/32	292.1 x 208.0 x 43.7	PA4437
10 13/16 x 8 1/8 x 25/32	274.6 x 206.4 x 19.8	PA5320	11 17/32 x 6 1/32 x 1 5/8	292.9 x 153.2 x 41.3	PA2257
10 27/32 x 7 3/8 x 2 3/32	275.4 x 187.3 x 53.2	PA4345	11 17/32 x 7 9/16 x 1 3/16	292.9 x 191.0 x 30.2	PA5475
10 7/8 x 6 11/32 x 2 1/8	276.2 x 161.1 x 54.0	PA4193	11 17/32 x 7 7/8 x 1 11/16	292.9 x 200.0 x 42.9	PA4350
10 7/8 x 7 7/8 x 1 3/16	276.2 x 200.0 x 30.2	PA10043	11 9/16 x 6 1/2 x 1 7/8	293.7 x 165.1 x 47.6	PA10058
10 29/32 x 7 3/32 x 1 19/32	277.0 x 180.2 x 40.5	PA4076	11 9/16 x 6 31/32 x 31/32	293.7 x 177.0 x 24.6	PA30110
10 29/32 x 7 27/32 x 1 11/16	277.0 x 199.2 x 42.9	PA10044	11 19/32 x 3 3/4 x 1 3/16	294.5 x 95.3 x 30.2	PA4416
10 29/32 x 8 5/8 x 1 11/32	277.0 x 219.1 x 34.1	PA10018	11 5/8 x 5 9/32 x 2 3/32	295.3 x 134.1 x 53.2	PA4107
10 29/32 x 8 5/8 x 1 11/32	277.0 x 219.1 x 34.1	PA10034	11 5/8 x 6 1/2 x 31/32	295.3 x 165.1 x 24.6	PA4096
10 29/32 x 8 31/32 x 1 5/8	277.0 x 227.8 x 41.3	PA4476	11 5/8 x 6 7/8 x 1 5/8	295.3 x 174.6 x 41.3	PA10073
10 29/32 x 9 7/8 x 2 23/32	277.0 x 250.8 x 69.1	PA4162	11 5/8 x 7 3/32 x 1 23/32	295.3 x 180.2 x 43.7	PA4337
10 15/16 x (3 1/4 to 7) x 1 1/8	277.8 x (82.6 to 177.8) x 28.6	PA4112	11 5/8 x 10 3/8 x 25/32	295.3 x 263.5 x 19.8	PA4304
10 15/16 x 7 7/16 x 1 9/16	277.8 x 188.9 x 39.7	PA5720	11 21/32 x 8 13/16 x 7/8	296.1 x 223.8 x 22.2	PA4384
10 15/16 x 8 13/16 x 3/4	277.8 x 223.8 x 19.1	PA4475	11 21/32 x 9 3/8 x 1 5/16	296.1 x 238.1 x 33.3	PA4341
10 15/16 x 8 27/32 x 2 1/32	277.8 x 224.6 x 51.6	PA4431	11 11/16 x 5 1/8 x 3/8	296.9 x 130.2 x 9.5	PA5721
10 15/16 x 9 1/8 x 31/32	277.8 x 231.8 x 24.6	PA30000	11 23/32 x 5 11/32 x 1 27/32	297.7 x 135.7 x 46.3	PA4183
10 15/16 x 9 11/32 x 1 15/32	277.8 x 237.3 x 37.0	PA4157	11 23/32 x 10 31/32 x 14 1/16	297.7 x 278.6 x 357.2	PA31000
10 15/16 x 9 29/32 x 4 3/8	277.8 x 251.6 x 111.1	PA4318	11 25/32 x 10 7/32 x 2 9/16	299.2 x 259.6 x 65.1	PA10045
10 15/16 x 9 15/16 x 4 13/32	277.8 x 252.4 x 111.9	PA4458	11 13/16 x 6 7/8 x 1 19/32	300.0 x 174.6 x 40.5	PA4351
10 31/32 x 4 9/16 x 1/2	278.6 x 115.9 x 12.7	PA5643	11 13/16 x 7 3/16 x 2 29/32	300.0 x 182.6 x 73.8	PA4464
11 x 11 x 2 3/16	279.4 x 279.4 x 55.6	PA2497	11 13/16 x 7 15/32 x 1 25/32	300.0 x 189.7 x 45.2	PA5511
11 1/32 x 6 5/16 x 1 25/32	280.2 x 160.3 x 45.2	PA5666	11 13/16 x 7 17/32 x 25/32	300.0 x 191.3 x 19.8	PA30156
11 1/16 x 6 9/16 x 1 5/16	281.0 x 166.7 x 33.3	PA2135	11 13/16 x 9 13/16 x 1 1/16	300.0 x 249.2 x 27.0	PA4652
11 1/16 x 9 21/32 x 3/4	281.0 x 245.3 x 19.1	PA10031	11 13/16 x 10 3/4 x 2 3/16	300.0 x 273.1 x 55.6	PA3823
11 1/16 x 10 9/16 x 13/16	281.0 x 268.3 x 17.5	PA4444	11 13/16 x 10 25/32 x 2 11/16	300.0 x 273.8 x 68.3	PA3763
11 3/32 x 7 1/8 x 2 9/32	281.8 x 181.0 x 57.9	PA4793	11 13/16 x 11 7/32 x 17/32	300.0 x 285.0 x 14.0	PA5691
11 3/32 x 8 3/16 x 1 3/16	281.8 x 208.0 x 30.2	PA4331	11 27/32 x 9 3/8 x 1 27/32	300.8 x 174.6 x 46.8	PA4434
11 1/8 x 6 25/32 x 25/32	282.6 x 172.2 x 19.8	PA5321	11 27/32 x 9 x 1 15/32	300.8 x 228.6 x 37.3	PA4481
11 1/8 x 7 1/2 x 2	282.6 x 190.5 x 50.8	PA10047	11 7/8 x 7 29/32 x 1 1/4	301.6 x 200.8 x 31.8	PA30114
			11 29/32 x 6 23/32 x 1 7/8	302.4 x 170.7 x 47.6	PA10026



WARNING: These products can expose you to chemicals, including Diisononyl Phthalate, Carbon black extracts, Nickel, 1,3 Butadiene, Ethylene Oxide, Epichlorohydrin, which are known to the State of California to cause cancer, and Bisphenol-A, Ethylene Glycol, Ethylene Oxide, 1,3 Butadiene, Epichlorohydrin, which are known to the State of California to cause birth defects or other reproductive harm. For more information go to www.P65Warnings.ca.gov.

PANEL AIR FILTERS

LENGTH x WIDTH x THICK Inches	LENGTH x WIDTH x THICK (mm)	BALDWIN NUMBER	LENGTH x WIDTH x THICK Inches	LENGTH x WIDTH x THICK (mm)	BALDWIN NUMBER
11 29/32 x 8 15/32 x 1 13/32	302.4 x 215.1 x 35.7	PA4312	12 13/16 x 5 3/4 x 2 5/32	325.4 x 146.1 x 54.8	PA4420
11 15/16 x 5 7/16 x 7/8	303.2 x 138.1 x 22.2	PA5318	12 13/16 x 6 1/32 x 2 9/32	325.4 x 153.2 x 57.9	PA5317
11 15/16 x 7 1/8 x 1 7/8	303.2 x 181.0 x 47.6	PA10006	12 13/16 x 10 9/16 x 8 5/32	325.4 x 268.3 x 207.2	PA1778
11 15/16 x 7 23/32 x 1 5/16	303.2 x 196.1 x 33.3	PA4423	12 27/32 x 5 25/32 x 2 1/8	326.2 x 146.8 x 54.0	PA4355
11 15/16 x 7 29/32 x 1 5/8	303.2 x 200.8 x 41.3	PA10072	12 27/32 x 5 7/8 x 1 21/32	326.2 x 149.2 x 42.1	PA2164
11 31/32 x 6 9/32 x 2 1/8	304.0 x 159.5 x 54.0	PA4413	12 27/32 x 6 5/8 x 1 1/4	326.2 x 168.3 x 31.8	PA4362
11 31/32 x 6 11/16 x 1 3/4	304.0 x 169.9 x 44.5	PA4321	12 7/8 x 5 17/32 x 1 23/32	327.0 x 140.5 x 43.7	PA4385
11 31/32 x 9 15/16 x 2 23/32	304.0 x 252.4 x 69.1	PA3897	12 7/8 x 12 x 2 9/16	327.0 x 304.8 x 65.1	PA3803
			12 29/32 x 3 17/32 x 1/2	327.8 x 89.7 x 12.7	PA5727
12 1/16 x 4 1/32 x 2 7/16	306.4 x 102.4 x 61.9	PA5739	12 29/32 x 5 27/32 x 1 19/32	327.8 x 148.4 x 40.5	PA4306
12 1/16 x 7 9/32 x 2 1/8	306.4 x 184.9 x 54.0	PA4077	12 29/32 x 10 3/32 x 1 17/32	327.8 x 256.4 x 38.9	PA30007
12 1/16 x 7 5/8 x 2 9/32	306.4 x 193.7 x 57.9	PA10024	12 15/16 x 10 7/16 x 2 23/32	328.6 x 265.1 x 69.1	PA4723
12 3/32 x 4 7/32 x 1 3/16	307.2 x 107.2 x 30.2	PA5768	12 31/32 x (6 to 9 15/32) x 2 1/32	329.4 x (152.4 to 240.5) x 51.6	PA10060
12 1/8 x 7 27/32 x 1 11/16	308.0 x 199.2 x 42.9	PA4081			
12 5/32 x 6 1/8 x 1 21/32	308.8 x 155.6 x 42.1	PA2041	13 x 5 7/8 x 2 3/16	330.2 x 149.2 x 55.6	PA2235
12 5/32 x (7 1/4 to 12 19/32) x 1 25/32	308.8 x (184.2 to 319.9) x 45.2	PA4170	13 x 7 x 1/2	330.2 x 177.8 x 12.5	PA3931
12 5/32 x 8 5/16 x 1 3/16	309.1 x 211.1 x 30.0	PA4174	13 x 8 1/2 x 2 9/32	330.2 x 215.9 x 57.9	PA4359
12 3/16 x (4 to 7 1/16) x 25/32	309.6 x (101.6 to 179.4) x 19.8	PA4394	13 x 9 1/2 x 2 29/32	330.2 x 241.3 x 73.8	PA4466
12 3/16 x 4 1/32 x 1 11/16	309.6 x 102.4 x 42.9	PA30252	13 1/16 x 6 15/32 x 1 15/32	331.8 x 164.3 x 37.3	PA2181
12 3/16 x 7 3/8 x 1 11/16	309.6 x 187.3 x 42.9	PA4028	13 1/8 x 6 15/16 x 1 25/32	334.0 x 175.2 x 45.2	PA4377
12 3/16 x 9 17/32 x 2 3/16	309.6 x 242.1 x 55.6	PA30004	13 3/16 x 5 11/32 x 1 21/32	335.0 x 135.7 x 42.1	PA2101A
12 7/32 x 6 17/32 x 1 3/4	310.4 x 165.9 x 44.5	PA4181	13 7/32 x 6 17/32 x 2 1/8	335.8 x 165.9 x 24.0	PA4369
12 7/32 x 8 1/32 x 25/32	310.4 x 204.0 x 19.8	PA4986	13 7/32 x 6 7/8 x 1 1/32	335.8 x 174.6 x 26.2	PA4957
12 7/32 x 9 7/32 x 29/32	310.4 x 234.2 x 23.0	PA4159	13 1/4 x 4 x 2 9/16	336.6 x 101.6 x 65.1	PA3828
12 1/4 x 6 5/32 x 1 3/16	311.2 x 156.4 x 30.2	PA5679	13 1/4 x 7 1/16 x 2 19/32	336.6 x 179.4 x 65.9	PA4110
12 1/4 x 9 1/8 x 2 1/16	311.2 x 231.8 x 52.4	PA4127	13 1/4 x 11 15/16 x 13/16	336.6 x 303.2 x 20.6	PA3482
12 1/4 x 9 7/16 x 1 11/16	311.2 x 239.7 x 42.9	PA4427	13 9/32 x 8 21/32 x 2 13/16	337.3 x 219.9 x 71.4	PA5621
12 1/4 x 9 9/16 x 2 9/16	311.2 x 242.9 x 65.1	PA3781	13 5/16 x 6 23/32 x 1 17/32	338.1 x 170.7 x 38.9	PA4124
12 1/4 x 9 31/32 x 1 3/4	311.2 x 253.2 x 44.5	PA5766	13 11/32 x 9 3/32 x 5/8	338.9 x 231.0 x 15.9	PA5765
12 9/32 x 7 9/16 x 2 7/16	311.9 x 192.1 x 61.9	PA5331	13 3/8 x 7 1/4 x 2 5/16	339.7 x 184.27 x 58.7	PA4120
12 9/32 x 9 23/32 x 2 5/16	311.9 x 246.9 x 58.7	PA4113	13 3/8 x 7 5/16 x 3 13/32	339.7 x 185.7 x 86.5	PA4148
12 9/32 x 9 23/32 x 2 5/16	311.9 x 246.9 x 58.7	PA4134	13 3/8 x 12 13/16 x 25/32	339.7 x 325.4 x 19.8	PA5690
12 9/32 x 10 x 2	311.9 x 254.0 x 50.8	PA4412	13 7/16 x (4 7/16 to 5 15/16) x 1 25/32	341.3 x (112.7 to 150.8) x 45.2	PA4191
12 9/32 x 10 1/16 x 1 13/16	311.9 x 255.6 x 46.0	PA5482	13 7/16 x 8 3/8 x 25/32	341.3 x 212.7 x 19.8	PA4682
12 5/16 x 6 23/32 x 3 5/16	312.7 x 170.7 x 84.1	PA4171	13 15/32 x 10 7/8 x 1 1/4	341.9 x 276.1 x 31.8	PA4358
12 5/16 x 6 15/16 x 1 27/32	312.7 x 176.2 x 46.8	PA4360	13 15/32 x 10 19/32 x 2 3/16	342.1 x 269.1 x 55.6	PA30183
12 5/16 x 8 27/32 x 1 7/16	312.7 x 224.6 x 36.5	PA30122	13 1/2 x 6 1/4 x 1 5/16	342.9 x 158.8 x 33.3	PA4092
12 5/16 x 8 27/32 x 1 7/16	312.7 x 224.6 x 36.5	PA30123	13 17/32 x 6 21/32 x 1 19/32	343.7 x 169.1 x 40.5	PA2163
12 5/16 x 8 27/32 x 1 7/16	312.7 x 224.6 x 36.5	PA30124	13 9/16 x 5 11/32 x 2 25/32	344.5 x 135.7 x 70.6	PA4428
12 11/32 x 4 x 1 5/8	313.5 x 101.6 x 41.3	PA4319	13 5/8 x 8 25/32 x 1 31/32	346.1 x 223.0 x 50.0	PA4396
12 11/32 x 5 7/32 x 2 1/4	313.5 x 132.6 x 57.2	PA4399	13 21/32 x 10 1/32 x 19/32	346.9 x 254.8 x 15.1	PA5637
12 13/32 x 10 7/8 x 2 25/32	315.1 x 276.2 x 70.6	PA4600	13 11/16 x 5 11/16 x 9/16	347.7 x 144.5 x 14.3	PA5778
12 13/32 x 10 7/8 x 3 3/16	315.1 x 276.2 x 81.0	PA4601	13 11/16 x 10 1/32 x 25/32	347.7 x 254.8 x 19.8	PA5694
12 7/16 x 7 1/32 x 1 7/16	315.9 x 178.6 x 36.5	PA2230	13 3/4 x 4 5/32 x 1 19/32	349.3 x 105.6 x 40.5	PA2218
12 7/16 x 7 1/16 x 2 5/32	315.9 x 179.4 x 54.8	PA5632	13 3/4 x 5 3/16 x 2 5/16	349.3 x 131.8 x 58.7	PA2234
12 7/16 x 11 11/16 x 2	315.9 x 296.9 x 50.8	PA4322	13 3/4 x 9 11/32 x 1 15/16	349.3 x 237.3 x 49.2	PA4151
12 15/32 x 10 9/32 x 2 17/32	316.7 x 261.1 x 64.3	PA30149	13 13/16 x 7 9/32 x 2 3/16	350.8 x 184.9 x 55.6	PA2244
12 1/2 x 6 1/2 x 1 3/4	317.5 x 165.1 x 44.5	PA3900	13 7/8 x 4 29/32 x 2 9/32	352.4 x 124.6 x 57.9	PA4316
12 1/2 x 7 1/16 x 1 7/16	317.5 x 179.4 x 36.5	PA4659	13 7/8 x 9 x 1 1/4	352.4 x 228.6 x 31.8	PA4439
12 17/32 x 7 1/16 x 1 5/8	318.3 x 179.4 x 41.3	PA5669	13 7/8 x 9 3/8 x 2 9/32	352.4 x 238.1 x 57.9	PA10022
12 17/32 x 7 19/32 x 1 11/16	318.3 x 192.9 x 42.9	PA4150	13 7/8 x 10 3/32 x 7/8	352.4 x 256.4 x 22.2	PA5306
12 9/16 x 6 1/2 x 1 7/16	319.1 x 165.1 x 36.5	PA5652	13 29/32 x 5 1/4 x 1 3/4	353.2 x 133.4 x 44.5	PA4440 KIT
12 9/16 x 8 x 3 1/16	319.1 x 203.2 x 77.8	PA5656	13 29/32 x 10 7/16 x 2 1/4	353.2 x 265.1 x 57.2	PA4390
12 19/32 x 5 29/32 x 1 5/8	319.9 x 150.0 x 41.3	PA2200	13 15/16 x 6 x 2 9/16	354.0 x 152.4 x 65.1	PA4554
12 19/32 x 5 31/32 x 2 9/32	319.9 x 151.6 x 57.9	PA4888	13 31/32 x (3 1/8 to 6 17/32) x 2 7/16	354.8 x (79.4 to 165.9) x 61.9	PA4165
12 19/32 x 6 1/2 x 1 7/8	319.9 x 165.1 x 47.6	PA5580	13 31/32 x 6 3/16 x 1 19/32	354.8 x 157.2 x 40.5	PA5339
12 19/32 x 6 21/32 x 1 15/16	319.9 x 169.1 x 49.2	PA30005	13 31/32 x 9 7/32 x 1 3/8	354.8 x 234.2 x 34.9	PA4488
12 19/32 x 6 15/16 x 1 27/32	319.9 x 176.2 x 46.8	PA4310			
12 19/32 x 7 1/4 x 31/32	319.9 x 184.2 x 24.6	PA4985	14 1/32 x 5 3/32 x 2	356.4 x 131.0 x 50.8	PA10013
12 19/32 x 7 3/4 x 1 15/32	319.9 x 196.9 x 37.3	PA4182	14 1/16 x 6 11/16 x 4 9/32	357.2 x 169.9 x 108.7	PA4433
12 19/32 x 9 11/32 x 1 13/32	319.9 x 237.3 x 35.7	PA4121	14 3/32 x 11 7/32 x 2 3/16	358.0 x 285.0 x 55.6	PA30002
12 19/32 x 9 11/32 x 2 7/16	319.9 x 237.3 x 61.9	PA4435	14 1/8 x 7 1/8 x 2 9/16	358.8 x 181.0 x 65.1	PA4654 KIT
12 19/32 x 9 1/2 x 2 1/16	319.9 x 241.3 x 52.4	PA4356	14 5/32 x 10 3/8 x 2 1/8	359.6 x 263.5 x 54.0	PA10012
12 19/32 x 10 5/8 x 5/8	319.9 x 269.9 x 15.9	PA3825	14 1/4 x 5 3/32 x 1 31/32	362.0 x 129.4 x 50.0	PA4414
12 5/8 x 6 11/32 x 2 15/16	320.7 x 161.1 x 74.6	PA4106	14 1/4 x 9 1/8 x 1 15/32	362.0 x 231.8 x 37.3	PA4478
12 21/32 x 9 1/4 x 15/16	321.5 x 235.0 x 23.8	PA4612	14 1/4 x 10 23/32 x 1 13/32	362.0 x 272.3 x 35.7	PA5712
12 23/32 x 5 27/32 x 2 7/32	323.1 x 148.4 x 56.4	PA5770	14 5/16 x 6 3/16 x 1 29/32	363.5 x 157.2 x 48.4	PA4448
12 23/32 x 6 3/32 x 2 5/16	323.1 x 154.8 x 58.7	PA4785	14 5/16 x 7 1/4 x 1 31/32	363.5 x 184.2 x 50.0	PA4111
12 3/4 x 4 7/8 x 1 7/32	323.9 x 128.3 x 31.0	PA4714	14 7/16 x 6 1/32 x 2 9/32	366.7 x 153.2 x 57.9	PA5680
12 3/4 x 9 23/32 x 1 25/32	323.9 x 246.9 x 45.2	PA4456	14 1/2 x 4 9/32 x 15/16	368.3 x 108.7 x 23.8	PA5660
12 3/4 x 11 9/16 x 1 1/8	323.9 x 293.7 x 28.6	PA4681	14 1/2 x 6 11/32 x 15/16	368.3 x 161.1 x 23.8	PA5725
12 25/32 x 7 5/8 x 1 19/32	324.6 x 193.7 x 40.5	PA4107	14 9/16 x 9 9/16 x 1 5/32	369.9 x 242.9 x 29.4	PA4324



WARNING: These products can expose you to chemicals, including Diisononyl Phthalate, Carbon black extracts, Nickel, 1,3 Butadiene, Ethylene Oxide, Epichlorohydrin, which are known to the State of California to cause cancer, and Bisphenol-A, Ethylene Glycol, Ethylene Oxide, 1,3 Butadiene, Epichlorohydrin, which are known to the State of California to cause birth defects or other reproductive harm. For more information go to www.P65Warnings.ca.gov.

PANEL AIR FILTERS

LENGTH x WIDTH x THICK Inches	LENGTH x WIDTH x THICK (mm)	BALDWIN NUMBER	LENGTH x WIDTH x THICK Inches	LENGTH x WIDTH x THICK (mm)	BALDWIN NUMBER
14 9/16 x 11 5/32 x 1 3/8.....	369.9 x 283.4 x 34.9.....	PA4336	17 6 x 2 3/16.....	431.8 x 152.4 x 55.6.....	PA4592
14 9/16 x 6 7/16 x 31/32.....	370.0 x 163.5 x 24.6.....	PA4489	17 8 x 2 3/16.....	431.8 x 203.2 x 55.6.....	PA3420
14 5/8 x 4 5/8 x 1 3/16.....	371.5 x 117.5 x 30.2.....	PA5625	17 x 10 x 2 3/16.....	431.8 x 254.0 x 55.6.....	PA2534
14 5/8 x 4 7/8 x 2 9/16.....	371.5 x 123.8 x 65.1.....	PA4567	17 x 10 1/32 x 2 3/16.....	431.8 x 254.8 x 55.6.....	PA5653
14 21/32 x (3 3/8 to 5 1/4) x 2 7/16.....	372.3 x (85.7 to 133.4) x 61.9.....	PA3886	17 1/32 x 2 7/8 x 1 7/8.....	432.6 x 73.0 x 47.6.....	PA5401
14 21/32 x 6 7/16 x 1 9/32.....	372.3 x 166.7 x 32.5.....	PA4128	17 1/8 x 4 13/16 x 1 3/4.....	435.0 x 122.2 x 44.5.....	PA5310
14 23/32 x 5 5/16 x 25/32.....	373.9 x 134.9 x 19.8.....	PA5493	17 1/8 x 8 7/16 x 2 11/16.....	435.0 x 214.3 x 68.3.....	PA3945
14 23/32 x 6 13/16 x 2 3/4.....	373.9 x 173.0 x 69.9.....	PA4172	17 9/32 x 5 21/32 x 21/32.....	438.9 x 143.7 x 16.7.....	PA5779
14 3/4 x (3 7/8 to 5 11/32) x 2 1/8.....	374.7 x (98.4 to 135.7) x 54.0.....	PA4307	17 5/16 x 3 29/32 x 1 1/2.....	439.7 x 99.2 x 38.1.....	PA4947
14 3/4 x 6 7/8 x 2 7/16.....	374.7 x 174.6 x 61.9.....	PA4635	17 5/16 x 10 19/32 x 1 17/32.....	439.7 x 269.1 x 38.9.....	PA2241
14 13/16 x 4 x 2 11/16.....	376.2 x 101.6 x 68.3.....	PA3829	17 15/32 x 8 1/2 x 5/8.....	443.7 x 215.9 x 15.9.....	PA3917
14 13/16 x 6 5/8 x 1 3/32.....	376.2 x 168.3 x 27.8.....	PA4409	17 1/2 x 4 1/4 x 3/16.....	444.5 x 108.0 x 4.8.....	PA5630
14 7/8 x 5 1/2 x 1 9/16.....	377.8 x 139.7 x 39.7.....	PA5492	17 1/2 x 6 x 2 9/16.....	444.5 x 152.4 x 65.1.....	PA3782
14 15/16 x 5 5/16 x 1 17/32.....	379.4 x 134.9 x 38.9.....	PA4956	17 21/32 x 8 1/8 x 1.....	448.5 x 206.4 x 25.4.....	PA5336
14 31/32 x 3 9/32 x 2 5/16.....	380.2 x 83.3 x 58.7.....	PA10007	17 21/32 x 8 1/8 x 1.....	448.5 x 206.4 x 25.4.....	PA5476
14 31/32 x 5 1/8 x 1 31/32.....	380.2 x 130.2 x 50.0.....	PA5399	17 3/4 x 7 13/32 x 1 7/32.....	450.9 x 191.3 x 31.0.....	PA4945
14 31/32 x 5 1/8 x 2 1/8.....	380.2 x 130.2 x 54.0.....	PA5400	17 29/32 x 5 27/32 x 1 3/16.....	454.8 x 148.4 x 30.2.....	PA5645
14 31/32 x 5 27/32 x 2 3/32.....	380.2 x 148.4 x 53.2.....	PA5740	17 29/32 x 5 15/16 x 15/32.....	454.8 x 150.8 x 11.9.....	PA5597
14 31/32 x 9 21/32 x 1 3/16.....	380.2 x 245.2 x 30.2.....	PA30172			
15 x 7 x 2 3/16.....	381.0 x 177.8 x 55.6.....	PA2936	18 x 10 x 2 15/16.....	457.2 x 254.0 x 74.6.....	PA3878
15 x 11 1/2 x 5 1/2.....	381.0 x 292.1 x 139.7.....	PA2450	18 1/8 x 9 7/16 x 1 3/16.....	460.4 x 239.7 x 30.2.....	PA5532
15 x 15 x 2 3/16.....	381.0 x 381.0 x 55.6.....	PA1961	18 5/32 x 15 9/16 x 19/32.....	461.2 x 395.3 x 15.1.....	PA4559
15 x 15 x 2 9/16.....	381.0 x 381.0 x 65.1.....	PA1960	18 1/4 x 3 7/8 x 3 3/16.....	463.6 x 98.4 x 81.0.....	PA3798
15 x 15 x 5 1/2.....	381.0 x 381.0 x 139.7.....	PA2554	18 5/16 x 3 1/16 x 1 5/8.....	465.1 x 77.8 x 41.3.....	PA4168
15 1/32 x 5 3/16 x 1 19/32.....	381.8 x 131.8 x 40.5.....	PA4912	18 5/16 x 5 5/16 x 2 5/32.....	465.1 x 134.9 x 54.8.....	PA5667
15 1/16 x 7 9/32 x 1 5/16.....	382.6 x 184.9 x 33.3.....	PA4422	18 11/32 x 7 x 2 5/32.....	465.9 x 177.8 x 54.8.....	PA5777
15 1/8 x 7 1/4 x 1 3/16.....	384.2 x 184.2 x 30.2.....	PA4097	18 11/32 x 8 31/32 x 25/32.....	465.9 x 227.8 x 19.8.....	PA30155
15 5/32 x 5 23/32 x 13/32.....	384.0 x 145.3 x 10.32.....	PA30179	18 3/8 x 7 9/32 x 2 13/16.....	466.7 x 184.9 x 71.4.....	PA4955
15 5/32 x 8 1/16 x 1 9/32.....	385.0 x 204.8 x 32.5.....	PA4185	18 7/16 x 5 1/4 x 2 3/16.....	468.3 x 133.4 x 55.6.....	PA3481
15 3/16 x 5 15/16 x 8 5/32.....	385.8 x 150.8 x 207.2.....	PA1775	18 1/2 x 4 9/16 x 2 1/4.....	469.9 x 115.9 x 57.2.....	PA5649
15 3/16 x 8 1/4 x 8 1/8.....	385.8 x 209.6 x 206.4.....	PA1806	18 17/32 x 3 17/32 x 1/2.....	470.7 x 89.7 x 12.7.....	PA5718 KIT
15 3/16 x 10 9/16 x 8 5/32.....	385.8 x 268.3 x 207.2.....	PA1779	18 19/32 x 7 7/16 x 2 13/16.....	472.3 x 188.9 x 71.4.....	PA5477
15 1/4 x 4 29/32 x 1 7/32.....	387.4 x 124.6 x 31.0.....	PA30086	18 19/32 x 7 7/8 x 2 19/32.....	472.3 x 200.0 x 65.9.....	PA5736
15 1/4 x 5 1/4 x 1 15/32.....	387.4 x 133.4 x 37.3.....	PA31003	18 5/8 x 4 23/32 x 1 3/8.....	473.1 x 119.9 x 34.9.....	PA4415
15 1/4 x 7 5/16 x 2 3/16.....	387.4 x 185.7 x 55.6.....	PA3881	18 13/16 x 4 1/8 x 1/2.....	477.8 x 104.8 x 12.7.....	PA5716
15 11/32 x 4 29/32 x 1 7/16.....	389.7 x 124.6 x 36.5.....	PA5282	18 29/32 x 3 15/32 x 1/2.....	480.2 x 88.1 x 12.7.....	PA5715
15 11/32 x 5 3/32 x 21/32.....	389.7 x 129.4 x 16.7.....	PA5596	18 29/32 x 4 7/8 x 19/32.....	480.2 x 123.8 x 15.1.....	PA30081
15 3/8 x 5 19/32 x 23/32.....	390.5 x 142.1 x 18.3.....	PA5599			
15 7/16 x 6 3/32 x 21/32.....	392.1 x 154.8 x 16.7.....	PA5594	19 x 19 x 5 3/8.....	482.6 x 482.6 x 136.5.....	PA2350
15 9/16 x 8 9/32 x 3/16.....	395.3 x 210.3 x 4.8.....	PA5732	19 x 19 x 5 3/8.....	482.6 x 482.6 x 136.5.....	PA2375
15 19/32 x 12 27/32 x 2 3/4.....	396.1 x 326.2 x 69.9.....	PA4560	19 1/16 x 6 15/16 x 2 1/8.....	484.2 x 76.2 x 54.0.....	PA5796
15 5/8 x 5 29/32 x 1 19/32.....	396.9 x 150.0 x 43.0.....	PA2227	19 1/8 x 11 1/4 x 2 7/16.....	485.8 x 285.8 x 61.9.....	PA4991
15 5/8 x 10 1/32 x 1 1/32.....	396.9 x 254.8 x 26.2.....	PA5363	19 9/32 x 8 31/32 x 2 23/32.....	489.7 x 227.8 x 69.1.....	PA30003
15 21/32 x 6 7/16 x 1 17/32.....	397.7 x 163.5 x 38.9.....	PA5697	19 3/8 x 5 3/4 x 3/8.....	492.1 x 146.1 x 9.5.....	PA5545
15 23/32 x 7 3/32 x 1 9/16.....	399.3 x 180.2 x 39.7.....	PA3980	19 13/32 x 5 27/32 x 1 3/16.....	492.9 x 148.4 x 30.2.....	PA5644
15 3/4 x 5 3/16 x 25/32.....	400.0 x 131.8 x 19.8.....	PA5586	19 7/16 x 19 7/16 x 5 5/16.....	493.7 x 493.7 x 134.9.....	PA2690
15 3/4 x 6 3/8 x 2 1/8.....	400.1 x 161.9 x 54.0.....	PA30185	19 7/16 x 19 7/16 x 8 1/16.....	493.7 x 493.7 x 204.8.....	PA2694
15 13/16 x 7 3/32 x 1 5/8.....	401.6 x 180.2 x 41.3.....	PA4042	19 1/2 x 9 1/2 x 1 3/4.....	495.3 x 241.3 x 44.5.....	PA30138
15 7/8 x 7 27/32 x 1 19/32.....	403.2 x 199.2 x 40.5.....	PA2178	19 1/2 x 11 1/2 x 1 3/4.....	495.3 x 292.1 x 44.5.....	PA30139
15 29/32 x 6 25/32 x 1 13/32.....	404.0 x 172.2 x 35.7.....	PA4383	19 1/2 x 15 1/2 x 1 3/4.....	495.3 x 393.7 x 44.5.....	PA4664
15 29/32 x 7 7/8 x 2 3/16.....	404.0 x 200.0 x 55.6.....	PA5655	19 1/2 x 19 1/2 x 1 3/4.....	495.3 x 495.3 x 44.5.....	PA4661
15 31/32 x 3 5/8 x 14.....	405.6 x 149.2 x 355.6.....	PA31002	19 1/2 x 19 1/2 x 1 25/32.....	495.3 x 495.3 x 45.2.....	PA4874
15 31/32 x 7 1/16 x 1 3/16.....	405.6 x 179.4 x 30.2.....	PA5797	19 1/2 x 19 1/2 x 2 19/32.....	495.3 x 495.3 x 65.9.....	PA2692
15 31/32 x 7 29/32 x 2 5/32.....	405.6 x 200.8 x 54.8.....	PA2232	19 1/2 x 19 1/2 x 5 1/4.....	495.3 x 495.3 x 133.4.....	PA3814
			19 1/2 x 19 1/2 x 5 1/4.....	495.3 x 495.3 x 133.4.....	PA3815
16 x 7 1/16 x 1 3/16.....	406.4 x 179.4 x 30.2.....	PA5512	19 1/2 x 19 1/2 x 5 9/16.....	495.3 x 495.3 x 141.3.....	PA2593
16 x 8 x 2 3/16.....	406.4 x 203.2 x 55.6.....	PA3756	19 1/2 x 19 1/2 x 5 11/16.....	495.3 x 495.3 x 144.5.....	PA2696
16 x 11 31/32 x 2 3/16.....	406.4 x 304.0 x 58.7.....	PA5681	19 21/32 x 5 9/32 x 2 19/32.....	499.3 x 134.1 x 65.9.....	PA5686
16 1/16 x 4 23/32 x 2 5/16.....	408.0 x 119.9 x 58.7.....	PA5695	19 11/16 x 3 15/16 x 3 9/16.....	500.1 x 100.0 x 90.5.....	PA3802
16 3/32 x 11 23/32 x 1 3/16.....	408.9 x 297.7 x 30.2.....	PA5623	19 11/16 x 7 7/8 x 2 5/32.....	500.1 x 200.0 x 54.8.....	PA5682
16 1/8 x 5 31/32 x 2 19/32.....	409.6 x 151.6 x 65.9.....	PA5654	19 13/16 x 19 13/16 x 8 1/8.....	503.2 x 503.2 x 206.4.....	PA1784
16 3/8 x 3 5/8 x 1/2.....	415.9 x 92.1 x 12.7.....	PA30044	19 27/32 x 5 31/32 x 8 5/32.....	504.0 x 151.6 x 207.2.....	PA1777
16 3/8 x 8 9/16 x 1 9/16.....	415.9 x 217.5 x 39.7.....	PA4858	19 27/32 x 8 7/8 x 1 3/16.....	504.0 x 225.4 x 30.2.....	PA5648
16 3/8 x 9 27/32 x 27/32.....	415.9 x 250.0 x 21.4.....	PA5734	19 7/8 x 8 1/4 x 8 5/32.....	504.8 x 209.6 x 207.2.....	PA1780
16 7/16 x 5 x 1 7/16.....	417.5 x 127.0 x 36.5.....	PA2706	19 7/8 x 10 9/16 x 8 5/32.....	504.8 x 268.3 x 207.2.....	PA1781
16 7/16 x 5 9/16 x 2 9/16.....	417.5 x 141.3 x 65.1.....	PA3937	19 7/8 x 15 7/32 x 8 5/32.....	504.8 x 386.6 x 207.2.....	PA1783
16 7/16 x 6 5/32 x 29/32.....	417.5 x 156.4 x 23.0.....	PA4928	19 29/32 x 12 25/32 x 8 5/32.....	505.6 x 324.6 x 207.2.....	PA1782
16 17/32 x 5 x 1 3/16.....	419.9 x 127.0 x 30.2.....	PA30098	19 31/32 x 9 1/16 x 2 19/32.....	507.2 x 230.2 x 65.9.....	PA5711
16 11/16 x 8 7/8 x 2 1/4.....	423.9 x 225.4 x 57.2.....	PA5428			
16 3/4 x 4 13/32 x 1 1/8.....	425.5 x 111.9 x 28.6.....	PA4340	20 x 3 15/16 x 3 9/16.....	508.0 x 100.0 x 90.5.....	PA5757
16 13/16 x 11 11/16 x 2 9/16.....	427.0 x 296.97 x 65.1.....	PA5300	20 x 7 1/2 x 2 3/16.....	508.0 x 190.5 x 55.6.....	PA2354



WARNING: These products can expose you to chemicals, including Diisononyl Phthalate, Carbon black extracts, Nickel, 1,3 Butadiene, Ethylene Oxide, Epichlorohydrin, which are known to the State of California to cause cancer, and Bisphenol-A, Ethylene Glycol, Ethylene Oxide, 1,3 Butadiene, Epichlorohydrin, which are known to the State of California to cause birth defects or other reproductive harm. For more information go to www.P65Warnings.ca.gov.

PANEL AIR FILTERS

LENGTH x WIDTH x THICK Inches	LENGTH x WIDTH x THICK (mm)	BALDWIN NUMBER	LENGTH x WIDTH x THICK Inches	LENGTH x WIDTH x THICK (mm)	BALDWIN NUMBER
20 x 7 1/2 x 2 3/16	508.0 x 190.5 x 55.6	PA5315	28 x 7 1/2 x 2 3/16	711.2 x 190.5 x 55.6	PA2353
20 x 9 x 2 9/16	508.0 x 228.6 x 65.1	PA3869	28 x 7 1/2 x 2 9/16	711.2 x 190.5 x 65.1	PA2352
20 x 14 19/32 x 2 3/16	508.0 x 370.7 x 55.6	PA5636	28 1/2 x 19 x 5 3/8	723.9 x 482.6 x 136.5	PA2444
20 x 15 x 2 3/16	508.0 x 381.0 x 55.6	PA3944	28 1/2 x 19 x 5 3/8	723.9 x 482.6 x 136.5	PA2564
20 5/32 x 6 7/8 x 1 15/32	512.0 x 174.6 x 37.3	PA30126	29 x 9 1/4 x 2 3/16	736.6 x 235.0 x 55.6	PA2329
20 5/32 x 9 7/32 x 1 7/8	512.0 x 234.2 x 47.6	PA5642	29 3/32 x 5 9/16 x 2 3/16	739.0 x 141.3 x 55.6	PA5668
20 11/32 x 4 1/8 x 1 1/8	516.7 x 104.8 x 28.6	PA4153	29 1/2 x 5 x 2 9/16	749.3 x 127.0 x 65.1	PA2752
20 7/16 x 4 1/8 x 1 31/32	519.1 x 104.7 x 50.0	PA5710	29 1/2 x 19 x 5	749.3 x 482.6 x 127.0	PA30074
20 15/32 x 4 3/32 x 2	519.9 x 104.0 x 50.8	PA5404	29 17/32 x 4 1/8 x 31/32	750.1 x 104.8 x 24.6	PA5713
20 21/32 x 8 3/4 x 1 13/16	524.7 x 222.3 x 46.0	PA5647	29 29/32 x 4 5/32 x 1/2	759.6 x 105.6 x 12.7	PA5726
20 25/32 x 3 31/32 x 3 5/8	527.8 x 100.8 x 92.1	PA5755	29 29/32 x 9 17/32 x 2 3/16	759.6 x 242.1 x 55.6	PA5657
20 13/16 x 5 11/32 x 2 9/32	528.6 x 135.7 x 57.9	PA5581	29 15/16 x 6 x 2 9/16	760.4 x 152.4 x 65.1	PA3438
21 1/4 x 5 29/32 x 2 11/16	539.8 x 150.0 x 68.3	PA3440	30 x 5 31/32 x 2 1/8	762.0 x 151.6 x 54.0	PA30048
21 21/32 x 3 15/16 x 2 1/2	550.1 x 100.0 x 63.5	PA5396	30 x 20 x 3 9/16	762.0 x 508.0 x 90.5	PA2854
22 x 4 7/32 x 2 1/4	558.8 x 107.2 x 57.2	PA5402	31 x 5 x 2 3/16	787.4 x 127.0 x 55.6	PA3442
22 23/32 x 6 7/16 x 1 15/32	577.1 x 163.5 x 37.3	PA5340	32 x 6 3/4 x 2 3/16	812.8 x 171.5 x 55.6	PA2436
22 3/4 x 4 x 2 9/32	577.9 x 101.6 x 57.9	PA4801	32 x 9 x 2 9/16	812.8 x 228.6 x 65.1	PA3421
22 3/4 x 20 1/4 x (3 9/32 to 4 1/4)	577.9 x 514.4 x (83.3 to 108.0)	PA2313	32 3/16 x 9 13/32 x 3 1/2	817.6 x 238.9 x 88.9	PA4973
22 29/32 x 2 15/16 x 15/32	581.8 x 74.6 x 11.9	PA5717	33 x 4 x 2 7/32	838.2 x 101.6 x 56.4	PA5299
22 15/16 x 14 x (5 5/16 to 6 7/32)	582.6 x 355.6 x (134.9 to 158.0)	PA2315	33 x 6 1/2 x 2 3/16	838.2 x 165.1 x 55.6	PA2440
23 3/16 x 4 1/2 x 7/8	589.0 x 114.3 x 22.2	PA30137	33 5/16 x 9 23/32 x 27/32	846.1 x 246.9 x 21.4	PA5533
23 5/16 x (5 3/16 to 5 3/8) x 3 11/32	592.1 x (131.8 to 136.5) x 84.9	PA3928	33 31/32 x 5 15/16 x 1 21/32	862.8 x 150.8 x 42.1	PA5780
23 3/8 x 4 9/16 x 15/32	593.7 x 115.9 x 11.9	PA5598	34 17/32 x 5 5/16 x 2 13/32	877.1 x 134.9 x 61.1	PA5626
23 3/8 x 10 3/8 x 3 3/4	593.7 x 263.5 x 95.3	PA4668	35 7/16 x 18 1/2 x (4 17/32 to 10 13/16)	900.1 x 469.9 x (115.1 to 274.6)	PA3769
23 3/8 x 11 3/8 x 1 3/4	593.7 x 288.9 x 44.5	PA4663	36 x 6 1/2 x 2 3/16	914.4 x 165.1 x 55.6	PA2638
23 3/8 x 19 3/8 x 1 3/4	593.7 x 492.1 x 44.5	PA3873	36 7/16 x 14 x (5 5/16 to 6 3/16)	925.5 x 355.6 x (134.9 to 157.2)	PA2395
23 3/8 x 23 3/8 x 1 3/4	593.7 x 593.7 x 44.5	PA3872	37 x 6 x 2 3/16	939.8 x 152.4 x 55.6	PA2408
23 1/2 x 6 x 2 3/16	596.9 x 152.4 x 55.6	PA2626	38 x 5 x 2 3/16	965.2 x 127.0 x 55.6	PA2411
23 1/2 x 6 x 2 9/16	596.9 x 152.4 x 65.1	PA3658	38 x 6 x 2 3/16	965.2 x 152.4 x 55.6	PA2407
23 1/2 x 6 1/2 x 2 3/16	596.9 x 165.1 x 55.6	PA2502	38 x 6 x 2 9/16	965.2 x 152.4 x 65.1	PA2619
23 1/2 x 7 x 2 3/16	596.9 x 177.8 x 55.6	PA2356	38 x 7 x 2 3/16	965.2 x 177.8 x 55.6	PA2617
23 1/2 x 7 1/8 x 15/16	596.9 x 181.0 x 23.8	PA2499	44 x 4 x 2 9/16	1117.6 x 101.6 x 65.1	PA2601
23 17/32 x 6 23/32 x 2 13/32	597.7 x 170.7 x 61.1	PA3842	44 15/16 x 4 x 2 3/16	1141.4 x 101.6 x 55.6	PA30049
23 17/32 x 6 23/32 x 3 3/16	597.7 x 170.7 x 81.0	PA3843	45 3/8 x 14 x (5 5/16 to 6 3/16)	1152.5 x 355.6 x (134.9 to 157.2)	PA2390
23 5/8 x 4 9/32 x 2 7/32	600.1 x 108.7 x 56.4	PA30045	47 x 6 x 2 9/16	1193.8 x 152.4 x 65.1	PA2464
23 5/8 x 4 7/8 x 1 1/32	600.1 x 123.8 x 26.2	PA30190	47 x 7 x 2 3/16	1193.8 x 177.8 x 55.6	PA2485
23 5/8 x 4 7/8 x 1 1/16	600.1 x 123.8 x 27.0	PA3939	62 1/4 x 3 x 2	1581.2 x 76.2 x 50.8	PA5659
23 11/16 x 9 x 2 3/16	601.7 x 228.6 x 55.6	PA30064			
23 29/32 x 9 x 2 1/4	607.2 x 228.6 x 57.2	PA5283			
24 x 5 x 2 3/16	609.6 x 127.0 x 55.6	PA3676			
24 x 19 11/16 x 2 9/16	609.6 x 500.1 x 65.1	PA2947			
24 x 24 x 2 9/16	609.6 x 609.6 x 65.1	PA1765			
24 1/32 x 4 1/16 x 3 7/16	610.4 x 103.2 x 87.3	PA5696			
24 9/32 x 4 11/32 x 31/32	616.7 x 110.3 x 24.6	PA5678			
24 13/32 x 4 3/16 x 1 3/32	619.9 x 106.4 x 27.8	PA5618			
24 1/2 x 15 1/2 x 3/4	622.3 x 393.7 x 19.1	PA4669			
24 1/2 x 15 1/2 x 1 3/4	622.3 x 393.7 x 44.5	PA4662			
24 1/2 x 19 1/2 x 1 3/4	622.3 x 495.3 x 44.5	PA5457			
24 29/32 x 22 1/2 x 3 3/32	632.6 x 571.5 x 78.6	PA5426			
25 1/4 x 19 1/4 x 3 3/4	641.4 x 489.0 x 95.3	PA5454			
25 7/16 x 19 7/16 x 5 5/8	646.1 x 493.7 x 142.9	PA2691			
25 1/2 x 6 1/16 x 2 3/16	647.7 x 154.0 x 55.6	PA2572			
25 1/2 x 19 1/2 x 2 5/32	647.7 x 495.3 x 54.8	PA2693			
25 9/16 x 13 7/8 x 1 1/2	649.3 x 352.4 x 38.1	PA5688			
25 31/32 x 5 15/16 x 1 21/32	659.6 x 150.8 x 42.1	PA5781			
26 x 7 x 2 9/16	660.4 x 177.8 x 65.1	PA2753			
26 x 11 x 2 3/16	660.4 x 279.4 x 55.6	PA2935			
26 1/16 x 2 1/2 x 19/32	662.0 x 63.5 x 15.1	PA30164			
26 1/8 x 5 1/4 x 9 9/32	663.6 x 133.4 x 235.7	CA5790			
26 1/8 x 5 7/16 x 2 9/16	663.6 x 138.1 x 65.1	PA2844			
26 7/32 x 6 1/2 x 2 7/32	666.0 x 165.1 x 56.4	PA5771			
26 3/4 x 7 3/4 x 2 3/16	679.5 x 196.9 x 55.6	PA2448			
26 15/16 x 5 15/16 x 2 19/32	684.2 x 150.8 x 65.9	PA3877			
26 15/16 x 6 1/4 x 2 9/16	684.2 x 158.8 x 65.0	PA3824			
28 x 6 3/4 x 2 3/16	711.2 x 171.5 x 55.6	PA2463			



WARNING: These products can expose you to chemicals, including Diisononyl Phthalate, Carbon black extracts, Nickel, 1,3 Butadiene, Ethylene Oxide, Epichlorohydrin, which are known to the State of California to cause cancer, and Bisphenol-A, Ethylene Glycol, Ethylene Oxide, 1,3 Butadiene, Epichlorohydrin, which are known to the State of California to cause birth defects or other reproductive harm. For more information go to www.P65Warnings.ca.gov.

OVAL, OBLONG & MISCELLANEOUS AIR FILTERS

All Measurements in Inches and (Millimeters)

NOTE: All air filters have been sorted by length, outside diameter and inside diameter.
The larger outside and inside diameters have been listed.

LENGTH Inches	LENGTH (mm)	O.D. Inches	O.D. (mm)	I.D. Inches	I.D. (mm)	BALDWIN NUMBER	LENGTH Inches	LENGTH (mm)	O.D. Inches	O.D. (mm)	I.D. Inches	I.D. (mm)	BALDWIN NUMBER
1 7/32	31.0	4 25/32	121.4	3 15/16	100	PA4731	3 5/8	92.1	4 13/32	111.9	1 5/8	41.3	PA3957
1 1/2	38.1	10 5/16	261.9	—	—	PA5290	3 5/8	92.1	9 3/4	247.7	5 1/2	139.7	PA4093
1 9/16	39.7	9	228.6	—	—	PA30119							
1 19/32	40.5	8 7/32	208.8	—	—	PA4997	4 1/16	103.2	6 19/32	167.5	5 1/32	127.8	PA5658
1 11/16	42.9	10 11/16	271.5	1 31/32	50.0	PA4729							
1 11/16	42.9	10 7/8	276.2	—	—	PA30072	6	152.4	14 3/8	365.1	—	—	CA5793
1 23/32	43.7	5 11/16	144.5	3 7/8	98.4	PA30012	6 1/32	153.2	12 31/32	329.4	9 7/8	250.8	PA2233
1 3/4	44.5	20 23/32	526.3	18 5/16	465.1	PA632	6 9/32	159.5	10 29/32	277.0	—	—	CA5370
1 13/16	46.0	11 25/32	299.2	—	—	PA4704	6 1/2	165.1	18 23/32	475.5	—	—	CA30102
1 15/16	49.2	7 17/32	191.3	6 1/32	153.2	PA4698	6 11/16	169.9	10 1/4	260.4	4 13/16	122.2	PA30118
							6 13/16	173.0	6 7/32	158.0	2 7/8	73	PA10062
							6 7/8	174.6	9 1/8	231.8	—	—	CA4996
							6 7/8	174.6	8 1/16	204.8	5 9/32	134.1	PA2194
2 1/16	52.4	4	101.6	1 5/16	33.3	PA4551	7 1/8	181.0	9 13/16	249.2	—	—	CA5450
2 1/8	54.0	4 11/16	119.1	2 29/32	73.8	PA4688	7 7/32	183.4	10 29/32	277.0	—	—	CA5416
2 1/8	54.0	5 1/16	128.6	4 1/16	103.2	PA30029	7 5/16	185.7	12 13/16	325.4	—	—	CA5278
2 1/8	54.0	10 9/16	268.3	9 1/16	230.2	PA2076	7 11/32	186.5	12 7/32	320.4	—	—	CA4702
2 1/8	54.0	14 9/16	369.9	13 1/4	336.6	PA2094	7 7/16	188.9	13 3/8	339.7	—	—	CA5514
2 3/16	55.6	7 1/4	184.2	6	152.4	PA30022	7 5/8	193.7	19 3/8	492.1	—	—	CA30105
2 7/32	56.4	8 27/32	224.6	7 9/32	184.9	PA2158	7 23/32	196.1	21 3/4	552.5	12 7/16	315.9	PA30066
2 9/32	57.9	7 3/32	180.2	4 7/8	123.8	PA4772	7 3/4	196.9	11 11/16	296.9	—	—	CA30071
2 5/16	58.7	4 15/32	113.5	3 7/32	81.8	PA2258							
2 5/16	58.7	8	203.2	6 3/4	171.5	PA30016	8 1/16	204.8	11 1/4	285.8	4 3/8	111.1	PA30095
2 5/16	58.7	12 13/16	325.4	—	—	PA5515	8 3/8	212.7	11 7/8	301.6	7/8 to 622.2 to 152.4		PA5289
2 5/16	58.7	14 3/4	374.7	—	—	PA5792	8 3/8	212.7	6 19/32	167.5	5 3/16	131.8	PA2157
2 7/16	61.9	6	152.4	3 27/32	97.6	PA4935	8 5/8	219.1	5 9/16	141.3	3 1/4	82.6	RS30099
2 7/16	61.9	8 9/16	217.5	4 5/8	117.5	PA30017	8 23/32	221.5	11 7/8	301.6	—	—	CA5369
2 9/16	65.1	7 7/8	200.0	5 7/8	149.2	PA4553	8 27/32	224.6	19 3/8	492.1	—	—	CA30103
2 9/16	65.1	8 1/4	209.6	—	—	PA5451							
2 9/16	65.1	24 1/4	616.0	22 27/32	580.2	PA2093	9 3/16	233.4	11 7/16	290.5	—	—	CA5366
2 19/32	65.9	6 3/32	154.8	4 1/16	103.2	PA4755	9 5/16	236.5	15 1/16	382.8	—	—	CA5791
2 11/16	68.3	3 31/32	100.8	1 1/4	31.8	PA4820	9 5/16	236.5	12 3/32	307.2	—	—	CA4999
2 7/8	73.0	4 1/2	114.3	3 1/8	79.4	PA30031	9 9/16	242.9	9 7/8	250.8	6 11/16	169.9	PA10068
2 7/8	73.0	5 19/32	142.1	3 11/16	93.7	PA4886	9 9/16	242.9	11 1/32	280.2	6 11/16	169.9	PA10061
2 7/8	73.0	14 9/16	369.9	11 13/16	300	PA2881	9 27/32	250.0	17 11/32	440.5	—	—	CA5500
2 29/32	73.8	8 5/8	219.1	6 27/32	173.8	PA5619							
3 1/32	77.0	7 1/4	184.2	3 29/32	99.2	PA4773	10 1/4	260.4	19 3/8	492.1	—	—	CA30104
3 1/16	77.8	5 11/16	144.5	3 7/8	98.4	PA30030							
3 1/16	77.8	5 3/4	146.1	4 1/16	103.2	PA4907	11 3/16	284.2	12 7/32	310.4	—	—	CA4703
3 3/32	78.6	3 31/32	100.8	1 5/8	41.3	PA4552	11 7/32	285.0	13 13/32	340.5	—	—	CA5788
3 1/8	79.4	5 3/32	129.4	3 9/16	90.5	PA4695							
3 1/8	79.4	7 5/32	181.8	6	152.4	PA30018	12 21/32	321.5	3 1/16	77.8	2 1/16	52.4	RS30234
3 1/8	79.4	7 7/16	188.9	5 15/16	150.8	PA30014							
3 3/16	81.0	6 5/32	156.4	4 23/32	119.9	PA4769	13 1/4	336.6	15 5/8	396.9	—	—	CA5789
3 3/16	81.0	12 15/16	328.6	9 13/16	249.2	PA2192							
3 7/32	81.8	5 25/32	146.8	4 5/32	105.6	PA4689	25	635.0	13 31/32	354.8	5 7/16	138.1	PA4929
3 1/4	82.6	7 5/16	185.7	5 7/16	138.1	PA5728							
3 7/16	87.3	5 9/32	134.1	3 1/2	88.9	PA4760							
3 1/2	88.9	11 1/8	282.6	8 7/8	225.4	PA613							

NOTES



WARNING: These products can expose you to chemicals, including Diisononyl Phthalate, Carbon black extracts, Nickel, 1,3 Butadiene, Ethylene Oxide, Epichlorohydrin, which are known to the State of California to cause cancer, and Bisphenol-A, Ethylene Glycol, Ethylene Oxide, 1,3 Butadiene, Epichlorohydrin, which are known to the State of California to cause birth defects or other reproductive harm. For more information go to www.P65Warnings.ca.gov.

BOXSTYLE FUEL FILTERS

CANTYPE FUEL FILTERS

LENGTH x WIDTH x HEIGHT Inches	LENGTH x WIDTH x HEIGHT (mm)	BALDWIN NUMBER
2 31/32 x 2 31/32 x 2 1/8.....	75.4 x 75.4 x 54.0	BF7881
3 x 3 x 1.....	76.2 x 76.2 x 25.4	BF46125
3 15/32 x 3 7/16 x 2 1/8.....	88.1 x 87.3 x 54.0	BF7912
4 3/8 x 2 17/32 x 2 5/8.....	111.1 x 64.3 x 66.7	BF806
4 5/8 x 2 27/32 x 2 15/32.....	117.5 x 72.2 x 62.7	BF855
4 21/32 x 2 27/32 x 2 15/32.....	118.3 x 72.2 x 62.7	BF7576
4 21/32 x 2 27/32 x 2 15/32.....	118.3 x 72.2 x 62.7	BF7579
4 21/32 x 2 27/32 x 2 15/32.....	118.3 x 72.2 x 62.7	BF7580
4 15/16 x 3 11/16 x 3 11/32.....	125.4 x 93.7 x 84.9	BF909
4 15/16 x 3 11/16 x 3 11/32.....	125.4 x 93.7 x 84.9	BF912
5 1/8 x 3 11/16 x 3 7/32.....	130.2 x 93.7 x 81.8	BF959
6 11/32 x 3 9/32 x 2 21/32.....	161.1 x 83.3 x 67.5	BF856
7 1/4 x 7 7/32 x 2 5/32.....	184.2 x 183.4 x 54.8	BF46087

LENGTH Inches	LENGTH (mm)	O.D. Inches	O.D. (mm)	I.D. Inches	I.D. (mm)	BALDWIN NUMBER
Length: length mm OD1:.....od1mm ID1:.....id1mm.....Part Number:						
2 25/32.....	70.6	3 15/32.....	88.1	29/32.....	23.0	BF7871
2 13/16.....	71.4	3 7/16.....	87.3	3/4.....	19.1	BF825
2 13/16.....	71.4	3 7/16.....	87.3	3/4.....	19.1	BF838-F2
2 13/16.....	71.4	3 7/16.....	87.3	3/4.....	19.1	BF9915
3 13/32.....	86.5	3 7/16.....	87.3	3/4.....	19.1	BF7537
3 13/16.....	96.8	3 15/32.....	88.1	3/4.....	19.1	BF874
4.....	101.6	3 15/32.....	88.1	29/32.....	23.0	BF7870
4 7/16.....	112.7	3 15/32.....	88.1	3/4.....	19.1	BF884
5 13/32.....	137.3	3 15/32.....	88.1	3/4.....	19.1	BF812

NOTES



WARNING: These products can expose you to chemicals, including Diisononyl Phthalate, Carbon black extracts, Nickel, 1,3 Butadiene, Ethylene Oxide, Epichlorohydrin, which are known to the State of California to cause cancer, and Bisphenol-A, Ethylene Glycol, Ethylene Oxide, 1,3 Butadiene, Epichlorohydrin, which are known to the State of California to cause birth defects or other reproductive harm. For more information go to www.P65Warnings.ca.gov.

OIL/AIR SEPARATOR ELEMENTS BY LENGTH

All Measurements in Inches and (Millimeters)

NOTE: All oil/air separator element filters have been sorted by length and then outside diameter.
The larger outside and inside diameters have been listed.

LENGTH Inches	LENGTH (mm)	O.D. Inches	O.D. (mm)	I.D. Inches	I.D. (mm)	BALDWIN NUMBER	LENGTH Inches	LENGTH (mm)	O.D. Inches	O.D. (mm)	I.D. Inches	I.D. (mm)	BALDWIN NUMBER
4 3/4.....	120.7	3 29/32.....	99.2	1 5/8.....	41.3	OAS99019	12.....	304.8	5 1/2.....	139.7	2 5/8.....	66.7	OAS98019
5 9/16.....	141.3	5 3/16.....	131.8	2 27/32.....	72.2	OAS98011	12.....	304.8	9 13/32.....	238.9	6 31/32.....	177.0	OAS99046
5 29/32.....	150.0	3 29/32.....	99.2	1 5/8.....	41.3	OAS99040	12 15/16.....	328.6	6 5/8.....	168.3	4 25/32.....	121.4	OAS99038
6 1/8.....	155.6	3 15/16.....	100.0	1 15/16.....	49.2	OAS98012	13 11/16.....	347.7	5 7/16.....	138.1	2 11/16.....	68.3	OAS98043
6 5/16.....	160.3	3 11/16.....	93.7	2 31/32.....	75.4	OAS99005	13 31/32.....	354.8	10 5/16.....	261.9	6 1/2.....	165.1	OAS99008
6 5/16.....	160.3	6 19/32.....	167.5	4 11/32.....	110.3	OAS99023	14.....	355.6	8 5/16.....	211.1	5 3/32.....	129.4	OAS98009
6 3/8.....	161.9	5 3/8.....	136.5	2 1/4.....	57.2	OAS98035	14 1/16.....	357.2	3 13/16.....	96.8	1 1/2.....	38.1	OAS98023
6 9/16.....	166.7	4 5/16.....	109.5	1 5/32.....	29.4	OAS99037	15 11/16.....	398.5	15 5/8.....	396.9	12 13/32.....	315.1	OAS98034
6 23/32.....	170.7	5 9/32.....	134.1	3.....	76.2	OAS99025	16 3/32.....	408.8	8 3/8.....	212.7	5 1/4.....	133.4	OAS98010
6 3/4.....	171.5	2 9/32.....	134.1	3.....	76.2	OAS98036	16 11/32.....	415.1	3 15/16.....	100.0	2 5/32.....	54.8	OAS98028
6 13/16.....	173.0	6 23/32.....	170.7	3 3/8.....	98.4	OAS98002	16 15/32.....	418.3	13 25/32.....	350.0	10 7/16.....	265.1	OAS98050
6 7/8.....	174.6	5 9/32.....	134.1	3.....	76.2	OAS98056	16 15/32.....	418.3	14 7/8.....	377.8	11 13/32.....	289.7	OAS98047
7.....	177.8	6 5/8.....	168.3	4 7/32.....	107.2	OAS98007	17.....	431.8	10 27/32.....	275.4	8 7/32.....	208.8	OAS98041
7 1/2.....	190.5	6 19/32.....	167.5	4 13/16.....	122.2	OAS99011	17 5/16.....	439.7	14 7/8.....	377.8	11 13/32.....	289.7	OAS98013
7 9/16.....	192.1	8 11/32.....	219.9	6 15/32.....	164.3	OAS99016	17 1/2.....	444.5	6 9/16.....	165.7	4 11/32.....	110.3	OAS98018
7 5/8.....	193.7	3 29/32.....	99.2	2 7/32.....	56.4	OAS98029	17 9/16.....	446.1	13 25/32.....	350.0	10 3/8.....	263.5	OAS98053
7 25/32.....	197.6	4 15/16.....	125.4	1 3/32.....	27.8	OAS99001	17 29/32.....	454.8	11 7/8.....	301.6	8 7/16.....	214.3	OAS98040
7 7/8.....	200.0	5 29/32.....	150.0	3 15/16.....	100.0	OAS99024	18 1/16.....	458.8	10 3/4.....	273.1	8 5/8.....	219.1	OAS99014
8 1/8.....	206.4	5 3/4.....	146.1	3 5/16.....	84.1	OAS98005	18 3/16.....	462.0	5 3/4.....	146.1	3 9/32.....	83.3	OAS98049
8 11/32.....	211.9	6 23/32.....	170.7	3 13/16.....	96.8	OAS98003	18 7/16.....	468.3	6 25/32.....	172.2	3 13/16.....	96.8	OAS98027
9 1/32.....	229.4	6 17/32.....	165.9	4 9/32.....	108.7	OAS99020	19 9/16.....	496.9	6 5/8.....	168.3	4 13/16.....	122.2	OAS99006
9 1/16.....	230.2	4 27/32.....	123.0	2 15/32.....	62.7	OAS98008	19 11/16.....	500.1	10 7/8.....	276.2	7 15/32.....	189.7	OAS98017
9 1/16.....	230.2	6 19/32.....	167.5	4 1/4.....	108.0	OAS99021	19 11/16.....	500.1	10 7/8.....	276.6	8 9/32.....	210.3	OAS98026
9 1/16.....	230.2	6 21/32.....	169.1	3 29/32.....	99.2	OAS98016	19 13/16.....	503.2	11 7/8.....	301.6	8 21/32.....	220.0	OAS98052
9 1/16.....	230.2	6 23/32.....	170.7	3 13/16.....	96.8	OAS98014	22 1/16.....	560.4	10 11/32.....	262.7	6 1/4.....	158.8	OAS98054
9 1/16.....	230.2	10 27/32.....	275.4	8 7/32.....	208.8	OAS98015	22 1/4.....	565.2	18 13/16.....	477.8	14 7/8.....	377.8	OAS98037
9 17/32.....	242.1	6 5/8.....	168.3	4 13/16.....	122.2	OAS99015	22 17/32.....	572.3	8 3/8.....	212.7	5 25/32.....	146.8	OAS98039
9 17/32.....	242.1	6 5/8.....	168.3	4 13/16.....	122.2	OAS99042	22 5/8.....	574.7	5 1/2.....	139.7	2 13/32.....	61.1	OAS98020
9 17/32.....	242.1	8 21/32.....	219.9	6 9/16.....	166.7	OAS99034	24 3/32.....	612.0	8 3/8.....	212.7	5 1/4.....	133.4	OAS98057
9 21/32.....	245.3	10 13/16.....	274.6	8 9/32.....	210.3	OAS99004	24 1/2.....	622.3	8 21/32.....	219.9	5 25/32.....	146.8	OAS98025
9 11/16.....	246.1	5 3/4.....	146.1	3 1/4.....	82.6	OAS98031	24 1/2.....	622.3	10 5/8.....	269.9	7 7/16.....	188.9	OAS98024
9 3/4.....	247.7	5 9/32.....	134.1	3 15/32.....	88.1	OAS99043	24 21/32.....	626.3	8.....	203.2	5 21/32.....	143.7	OAS98046
9 27/32.....	250.0	4 5/16.....	109.5	2 3/8.....	60.3	OAS99002	26 1/16.....	662.0	11 23/32.....	297.7	8 11/32.....	211.9	OAS98021
9 27/32.....	250.0	6 23/32.....	170.7	3 13/16.....	96.8	OAS98032	29 27/32.....	758.0	11 1/2.....	292.1	9 1/4.....	235.0	OAS98042
9 31/32.....	253.2	3 1/16.....	77.8	1 19/32.....	40.5	OAS99035	32 9/32.....	819.9	10 27/32.....	275.4	8 1/2.....	215.9	OAS99018
10 3/32.....	256.4	5 3/4.....	146.1	5 19/32.....	142.1	OAS98058	32 9/16.....	827.1	20 31/32.....	735.8	18 7/32.....	462.8	OAS98030
10 7/8.....	276.2	5 9/32.....	134.1	3 7/16.....	87.3	OAS98022	36 11/32.....	923.1	20 31/32.....	532.6	18 7/32.....	462.8	OAS98048
10 29/32.....	277.0	10 7/8.....	276.2	7 7/16.....	188.9	OAS98033							
11.....	279.4	8 3/8.....	212.7	5 1/4.....	133.4	OAS98038							
11 5/16.....	287.3	6 23/32.....	170.7	4.....	101.6	OAS98004							
11 7/16.....	290.5	5 3/4.....	146.1	2 5/16.....	134.9	OAS98044							
11 17/32.....	292.9	5 9/32.....	134.1	2 15/16.....	74.6	OAS99003							
11 11/16.....	296.9	5 3/4.....	146.1	3 5/16.....	134.9	OAS98001							
11 25/32.....	299.2	3 7/32.....	81.8	1 5/16.....	33.3	OAS98045							
11 7/8.....	301.6	5 9/32.....	134.1	3 15/32.....	88.1	OAS99010							
11 7/8.....	301.6	5 5/16.....	134.9	3 15/32.....	88.1	OAS99017							



WARNING: These products can expose you to chemicals, including Diisononyl Phthalate, Carbon black extracts, Nickel, 1,3 Butadiene, Ethylene Oxide, Epichlorohydrin, which are known to the State of California to cause cancer, and Bisphenol-A, Ethylene Glycol, Ethylene Oxide, 1,3 Butadiene, Epichlorohydrin, which are known to the State of California to cause birth defects or other reproductive harm. For more information go to www.P65Warnings.ca.gov.

OIL/AIR SEPARATOR SPIN-ON FILTERS BY TAP SIZE (METRIC THREAD)

THREAD I.D.	O.D. Inches	O.D. (mm)	LENGTH Inches	LENGTH (mm)	GASKET	FEATURES	BALDWIN NUMBER
1 1/4-11 BSP	5 17/32.....	140.5	10 7/8.....	276.2	[1] Included		OAS98006
M16 x 1.5	3.....	76.2	4 29/32.....	124.6	[1] Included		OAS98000
M24 x 1.5	3 27/32.....	97.6	8 7/32.....	208.8	[1] Included	PS	OAS99032
M24 x 1.5	3 27/32.....	97.6	8 5/16.....	211.1	[1] Included		OAS99048
M32 x 1.5	4 11/32.....	110.3	10 3/8.....	263.5	[1] Included	PS	OAS99028
M39 x 1.5	5 13/32.....	137.3	11 31/32.....	304.0	[1] Included		OAS99031
M39 x 1.5	5 1/2.....	139.7	7 3/32.....	180.2	[1] Included	PS	OAS99029
M39 x 1.5	5 1/2.....	139.7	12 1/32.....	305.6	[1] Included		OAS99047

NOTES



WARNING: These products can expose you to chemicals, including Diisononyl Phthalate, Carbon black extracts, Nickel, 1,3 Butadiene, Ethylene Oxide, Epichlorohydrin, which are known to the State of California to cause cancer, and Bisphenol-A, Ethylene Glycol, Ethylene Oxide, 1,3 Butadiene, Epichlorohydrin, which are known to the State of California to cause birth defects or other reproductive harm. For more information go to www.P65Warnings.ca.gov.

IN-LINE FILTERS BY INLET SIZE

INLET	OUTLET	O.D. Inches	O.D. (mm)	LENGTH Inches	LENGTH (mm)	BALDWIN NUMBER	INLET	OUTLET	O.D. Inches	O.D. (mm)	LENGTH Inches	LENGTH (mm)	BALDWIN NUMBER
3/8	3/8	2 5/32	54.8	6 7/8	174.6	BF7771	7/8	7/8	5 1/2	139.7	11 15/16	303.2	PT8480
3/8	3/8	2 5/32	54.8	16 15/16	430.2	BF7630	1	1	4 1/32	102.4	7 31/32	202.4	PT8435-MPG
3/8	3/8	2 1/4	57.2	7	177.8	BF7742	1-14	1 1/16	4 1/4	107.9	5 11/32	135.7	BT8412
3/8	3/8	2 1/4	57.2	7 27/32	199.2	BF7805	M12 x 1.25	M12 x 1.25	2 17/32	64.3	3 31/32	100.8	BF7659
3/8	3/8	2 9/32	57.9	6 13/32	162.7	BF1046	M12 x 1.25	M12 x 1.25	2 3/4	69.9	4 13/32	111.9	BF1191
3/8	3/8	2 9/32	57.9	6 15/32	164.3	BF1045	M12 x 1.25	M12 x 1.25	2 3/4	69.9	4 29/32	124.6	BF1100
3/8	3/8	2 9/32	57.9	6 29/32	175.4	BF7802	M12 x 1.5	M14 x 1.5	3 13/32	86.5	5 23/32	145.3	BF1177
3/8	3/8	2 11/32	59.5	7 1/2	190.5	BF7937	M14 x 1.5	5/16	2 9/16	65.1	4 3/16	106.4	BF7661
3/8	3/8	2 11/32	59.5	8 15/32	215.1	BF9851	M14 x 1.5	7/16	2 3/4	69.9	4 1/8	104.8	BF7945
3/8	3/8	2 3/4	69.9	4 1/4	108.0	BF7944	M14 x 1.5	M12 x 1.25	2 9/16	65.1	3 31/32	100.8	BF1112
3/8	3/8	3 5/16	84.1	6 15/16	176.2	BF9857	M14 x 1.5	M12 x 1.25	2 9/16	65.1	4	101.6	BF1059
3/8	3/8	3 3/8	85.7	7 5/32	181.8	BF9881	M14 x 1.5	M12 x 1.25	2 9/16	65.1	4 1/32	102.4	BF1061
3/8	M16 x 1.5	2 5/32	54.8	4 7/8	123.8	BF868	M14 x 1.5	M12 x 1.25	2 9/16	65.1	4 9/32	108.7	BF1050
3/8	M16 x 1.5	2 5/32	54.8	5 3/8	136.5	BF1171	M14 x 1.5	M12 x 1.25	2 3/4	69.9	4 3/8	111.1	BF1179
3/8	M14 x 1.5	2 5/32	54.8	5 13/32	137.3	BF7667	M14 x 1.5	M12 x 1.25	2 15/16	74.6	4 7/16	112.7	BF1193
7/16	3/8	3 5/8	92.1	4 29/32	124.6	BF9846	M14 x 1.5	M12 x 1.25	3 3/8	85.7	3 21/32	92.9	BF1188
1/2-20	1/8-27	1 11/32	34.1	1 15/16	49.2	BF920	M14 x 1.5	M12 x 1.25	3 13/32	86.5	4 1/4	108.0	BF7721
1/2	1/2	1 29/32	48.4	4 1/4	108.0	BF7693	M14 x 1.5	M12 x 1.5	3 1/8	79.4	5 11/32	135.7	BF885
1/2	1/2	2	50.8	4 7/16	112.7	BF7691	M14 x 1.5	M14 x 1.5	1 13/16	46.0	3 7/16	87.3	BF46005
9/16-18	9/16-18	1 29/32	48.4	3 7/8	98.6	BF9886	M14 x 1.5	M14 x 1.5	2 5/32	54.8	4 7/16	112.7	BF1186
9/16-18	9/16-18	1 31/32	50.0	3 23/32	94.5	BF7690	M14 x 1.5	M14 x 1.5	2 17/32	64.3	3 3/4	95.3	BF7961
5/8-18	3/8	2 9/32	57.9	4 3/4	120.7	BF858	M14 x 1.5	M14 x 1.5	2 3/4	69.9	4 9/32	108.7	BF1148
5/8-24	5/8-24	1 29/32	48.4	3 17/32	89.7	BF7519	M16 x 1.5	3/8	2 1/8	54.0	6 1/4	158.8	BF7776
11/16-16	13/16-16	1 1/2	38.1	2 13/16	71.4	PT9470	M16 x 1.5	3/8	2 1/8	54.0	6 9/16	166.7	BF7775
11/16-16	13/16-16	2 3/16	55.6	3 11/16	93.7	PT9474	M16 x 1.5	3/8	2 9/32	57.9	5 3/8	136.5	BF7658
							M16 x 1.5	3/8	2 5/16	58.7	5 11/32	135.7	BF7808
							M16 x 1.5	M16 x 1.5	2 5/16	58.7	4 7/16	112.7	BF853

NOTES



WARNING: These products can expose you to chemicals, including Diisononyl Phthalate, Carbon black extracts, Nickel, 1,3 Butadiene, Ethylene Oxide, Epichlorohydrin, which are known to the State of California to cause cancer, and Bisphenol-A, Ethylene Glycol, Ethylene Oxide, 1,3 Butadiene, Epichlorohydrin, which are known to the State of California to cause birth defects or other reproductive harm. For more information go to www.P65Warnings.ca.gov.

DECIMAL EQUIVALENTS CHART

	1/64 →	.015625		33/64 →	.515625
	1/32	.03125		17/32	.53125
	3/64	.046875		35/64	.546875
1/16		.0625	9/16		.5625
	5/64	.078125		37/64	.578125
	3/32	.09375		19/32	.59375
	7/64	.109375		39/64	.609375
1/8	→	.125	5/8	→	.625
	9/64	.140625		41/64	.640625
	5/32	.15625		21/32	.65625
	11/64	.171875		43/64	.671875
3/16		.1875	11/16		.6875
	13/64	.203125		45/64	.703125
	7/32	.21875		23/32	.71875
	15/64	.234375		47/64	.734375
1/4	→	.25	3/4	→	.75
	17/64	.265625		49/64	.765625
	9/32	.28125		25/32	.78125
	19/64	.296875		51/64	.796875
5/16		.3125	13/16		.8125
	21/64	.328125		53/64	.828125
	11/32	.34375		27/32	.84375
	23/64	.359375		55/64	.859375
3/8	→	.375	7/8	→	.875
	25/64	.390625		57/64	.890625
	13/32	.40625		29/32	.90625
	27/64	.421875		59/64	.921875
7/16		.4375	15/16		.9375
	29/64	.453125		61/64	.953125
	15/32	.46875		31/32	.96875
	31/64	.484375		63/64	.984375
1/2	→	.5	1	→	1

UPC CODE EXPLANATION

Baldwin Filters uses the “A” version of the UPC code. This is a twelve digit numeric bar code symbol, utilizing a series of narrow and wide parallel bars and spaces to represent numeric characters in a machine readable format.

The first digit of the bar code identifies the product category. The second, third, fourth, fifth and sixth digits are the vendor’s identification code assigned by the UPC Council. The seventh, eighth, ninth, tenth and eleventh digits are the vendor’s product code numbers assigned by the vendor. The twelfth digit is a check digit confirming the code has been accurately read.

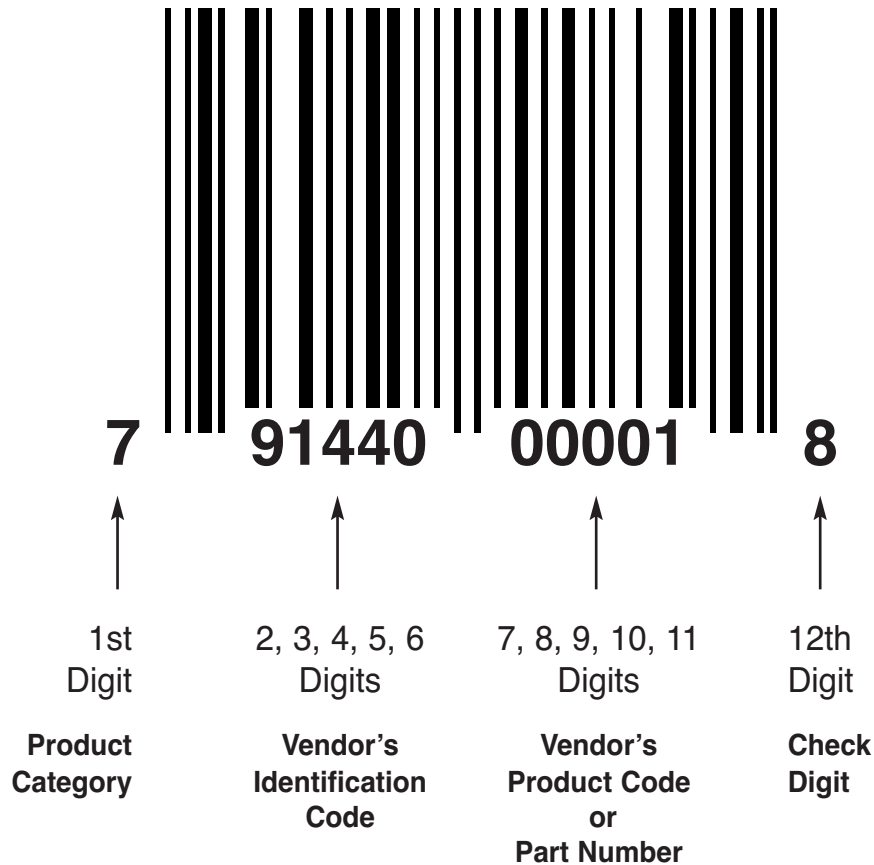

BALDWIN TO UPC (INDIVIDUAL PARTS)

BALDWIN NUMBER	UPC NUMBER	BALDWIN NUMBER	UPC NUMBER	BALDWIN NUMBER	UPC NUMBER	BALDWIN NUMBER	UPC NUMBER	BALDWIN NUMBER	UPC NUMBER
B2	79144000018	P82	791440001022	P140	791440001855	PT212-5	791440002715	PT289	791440003538
B2-HPG	79144000025	PT82-HD	791440001039	B141	791440001862	PT213	791440002722	PT289-10	791440003545
B4	791440000049	PT82-HD10	791440001046	BD142	791440001879	PT214(2)	791440002739	PT290	791440003552
BT5	791440000056	PT83	791440001053	B143	791440001886	BT215	791440002746	BT292	791440003576
B6	791440000063	PT83-MPG	791440001060	P144	791440001893	BT216	791440002753	P294	791440003590
B6-HPG	791440000070	P84-2	791440001084	PT146	791440001909	BT217	791440002760	B295	791440003606
B7	791440000087	PT85	791440001091	P148	791440001923	B218	791440002777	B296	791440003613
B9	791440000094	PT86-HD	791440001107	P150	791440001947	B220	791440002791	PT298-10	791440003620
B10-AL	791440000100	PT87-S	791440001114	PT151	791440001954	BT221	791440002807	B299	791440003637
B10-AL BOWL	791440000117	PT88-HD	791440001121	PT152	791440001961	B222	791440002814	T300-M	791440003644
B10-AL BSP	791440065482	PT89	791440001138	PT153	791440001978	BT223	791440002821	B301	791440003651
B10-AL BSPCS	791440088658	PT90-10	791440001145	PT154	791440001985	PF224	791440002838	PT302	791440003668
B10-AL CAP	791440000124	PT90-MPG	791440001152	PF155	791440001992	PF225	791440002852	T303-M	791440003675
PF10	791440000131	PT91	791440001169	B156	791440002005	PF226	791440002876	PT304	791440003682
PF10-CS	791440000148	PT93	791440001183	B157	791440002012	B227	791440002883	BT305	791440003859
PT11	791440000155	PT93-MPG	791440001190	B159	791440002036	B228	791440002890	B307	791440003705
PT11-HD	791440000162	B95	791440001213	B160	791440002043	B229	791440002906	T308-M	791440003712
PT12	791440000179	B95-MPG	791440001244	B161-S	791440002050	BT230	791440002913	B309	791440003729
BF13	791440000186	B95-SS	7914400050396	P162	791440002067	PF231	791440002920	BT310	791440003842
P15	791440000193	B96	791440001251	B163	791440002074	BD232	791440003845	PF311	791440003736
S16-1	791440000209	B96-MPG	791440001282	B164	791440002081	B233	791440002937	PF312	791440003743
P18	791440000230	B96-SS	7914400050389	B166	791440002104	BT234	791440002951	PF313	791440003750
P18-HD	791440000247	B97	791440001299	B167	791440002111	P235	791440002968	PF314	791440003767
P19	791440000254	PT98-10	791440001305	B168	791440002128	B236	791440002975	PF316	791440003774
P20-HD	791440000261	PT98-MPG	791440001312	P170	791440002142	BT237	791440002982	PT317-MPG	791440003781
V24-A2	791440000315	B99	791440001329	P171	791440002159	BT238	791440002999	PT318-MPG	791440003798
P25	791440000339	B99-B	791440001336	P172	791440002166	B239	791440003002	PT319-MPG	791440003804
P26	791440000346	B99-MPG	791440001350	BT173-S	791440002173	P240	791440003019	PT320-MPG	791440003811
B27	791440000353	B99-SS	7914400050419	P174	791440002180	BT241	791440003026	BD324	791440003859
BD28	791440000360	P102	791440001381	P176	791440002203	P242	791440003033	BD325	791440047518
PT29	791440000377	BD103	791440001398	P177	791440002210	B243	791440003040	B326	791440003866
AFG30	791440000384	BD103-MPG	791440042674	B178	791440002227	B244	791440003057	B329	791440003880
B30	791440000391	BD103-SS	791440050402	B179	791440002234	B246	791440003071	BF330	791440003897
B31	791440000407	P104	791440001404	PT181 KIT	791440002258	B247	791440003088	PF332	791440003903
B33	791440000421	B105	791440001411	P183	791440002272	BT248	791440003095	B333	791440003910
B34	791440000438	P106	791440001428	P184	791440002296	P249	791440003101	BT334	791440003927
B35-S	791440000445	P106-HD	791440001435	PT185	791440002302	BT251	791440003118	B336	791440003941
AFG37R	791440000469	PT108	791440001459	P186	791440002319	B252	791440003125	B337	791440003958
B37	791440000476	PT108-HD	791440001466	P187	791440002326	B253	791440003132	BT338	791440003965
AFG38D	791440000483	B109	791440001473	PT189	791440002340	P254	791440003149	BT339	791440003972
B39	791440000506	BC110	791440001480	PT189-MPG	791440002357	B255	791440003156	BT340	791440003989
P40	791440000513	BT111	791440001497	P190	791440002364	PT256	791440003163	BT341	791440003996
P41	791440000520	BT112	791440001503	PT191	791440002371	PT257	791440003170	BT342	791440004009
P42	791440000537	B113	791440001510	PT191-10	791440002388	PT258	791440003187	BT343	791440004016
B43-S	791440000544	B114	791440001527	PT191-5	791440002395	BT259	791440003194	BT344-S	791440004023
B45	791440000568	PT115	791440001534	PT193	791440002418	BT260	791440003200	BT345 KIT	791440004030
P47	791440000582	P116	791440001541	PT193 KIT	791440002425	BT260-10	791440003217	BT346	791440004047
PT48	791440000599	PF116	791440001558	PT193-3	791440002432	BT261	791440003224	BT347	791440004054
B49	791440000605	PT117	791440001565	P194	791440002449	B262	791440003231	BT348	791440004061
B50	791440000612	PT117-25	791440001572	P194-HD	791440002456	B263	791440003248	BT349	791440004078
P52	791440000636	B118	791440001589	P194-HD10	791440002463	BT264	791440003255	BT350	791440004085
P53	791440000643	PT119	791440001596	PF194	791440002470	PT265	791440003262	BT351	791440004092
P54	791440000650	PT119-5	791440001602	B195	791440002487	P266	791440003279	BT351-MPG	791440069701
B56	791440000674	PT119-HD	791440001619	B196	791440002494	BT267	791440003286	P352	791440004108
P60	791440000711	PT119-HD5	791440001626	B196-MPG	791440002500	PT268	791440003293	BT353	791440004115
PT61-HD	791440000728	B120	791440001640	P198	791440002517	PT269	791440003309	BT354	791440004122
PT62	791440000735	PF121	791440001657	B199	791440002524	P271	791440003323	BT355	791440004139
PT63-1	791440000742	PT122-5	791440001664	B201-S	791440002548	PT273	791440003347	P356	791440004146
PT66-HD	791440000773	BT124	791440001688	B202	791440002555	BT274	791440003354	BT357	791440004153
P67	791440000780	P125	791440001695	P203	791440002562	PT275	791440003361	B358	791440004160
P68	791440000797	BT126	791440001701	P203-HD	791440002579	PT275-10	791440003378	BT359	791440004177
PT70	791440000810	P127	7914400052918	P203-HD10	791440002586	P276	791440003385	B360	791440004184
PT71	791440000834	B128	791440001718	P204	791440002593	PT277	791440003408	BT361	791440004191
PT72	791440000858	B129	791440001725	P204-HD	791440002609	B279	791440003415	BT364	791440004211
P73	791440000872	B131	791440001749	P204-HD10	791440002616	P280	791440003422	BT365	791440004224
B74	791440000889	B132	791440001756	B205	791440002623	B281	791440003439	BT365-10	791440004238
B75	791440000896	C133-OW	791440001763	P206	791440002630	PT283	791440003460	BT366-10	791440004245
BT6	791440000902	C133-W	791440001770	PT207	791440002647	PT284	791440003477	BT366-MPG	791440006965
B76-MPG	791440000933	B134	791440001787	PT207-10	791440002654	PT285	791440003484	BT367	791440004252
B76-SS	791440050426	PT135	791440001794	PT207-HD	791440002661	BT287	791440003491	BT367-S	791440004269
PT79	791440000964	PT137	791440001817	PT207-HD10	791440002678	BT287-3	7914400058231	BT368	791440004276
P80	791440000988	PT138-10	791440001824	PT208	791440002685	BT287-10	791440003507	B369	791440004283
P80-HD	791440000995	PT138-25	791440001831	PT210	791440002692	PT288-HD	791440003514	PT370	791440004290
P81	791440001015	PT139-10	791440001848	B211	791440002708	PT288-HD10	791440003521	BT371-5	7914400069718



WARNING: These products can expose you to chemicals, including Diisononyl Phthalate, Carbon black extracts, Nickel, 1,3 Butadiene, Ethylene Oxide, Epichlorohydrin, which are known to the State of California to cause cancer, and Bisphenol-A, Ethylene Glycol, Ethylene Oxide, 1,3 Butadiene, Epichlorohydrin, which are known to the State of California to cause birth defects or other reproductive harm. For more information go to www.P65Warnings.ca.gov.

BALDWIN TO UPC (INDIVIDUAL PARTS)

BALDWIN NUMBER	UPC NUMBER	BALDWIN NUMBER	UPC NUMBER	BALDWIN NUMBER	UPC NUMBER	BALDWIN NUMBER	UPC NUMBER	BALDWIN NUMBER	UPC NUMBER
BT371-10	791440004306	PT435	791440005181	PT520	791440006058	BT611-MPG	791440045958	PT727-DL	791440007901
BT371-MPG	791440004313	PT436	791440005198	BT521	791440006072	PA612	791440007086	PT727-HD	791440007918
BT372-10	791440004320	PT437	791440005204	PT522	791440006089	PA613	791440007093	PT727-HD10	791440007925
BT372-MPG	7914400038127	BT438	791440005211	BT525	791440006096	BF614	791440007109	PT728-MPG	791440007932
PT373	791440004337	PT439	791440005228	BT526	791440006102	PA615	791440007116	PT729	791440007949
PT374	791440004344	BT440	791440005235	BT526-10	791440006119	PA616	791440007123	BT732	791440007970
PT375	791440004351	PT441	791440005242	PT527	791440006126	PA617	791440007130	BT735	791440007994
PT376	791440004368	PT442-MPG	791440005259	P528	791440006133	PA618	791440007147	PT737	791440008014
PT377	791440004375	BT443	791440005266	P529	791440006140	PA618 FOAM	791440007154	PT737-10	791440008021
PT377-10	791440004382	PT445-MPG	791440005273	PT534	791440006188	PA618-S	791440007161	V738-O	791440008038
B378	791440004399	P446	791440005280	PT535	791440006195	PA621	791440007185	BT739	791440008045
B378-10	791440004405	B447	791440005297	BT536	791440006201	PA625	791440007192	C740-S	791440008052
PT379 KIT	791440004412	PA50	791440005310	P537	791440006218	PA631	791440007208	C750-E	791440008144
PT380 KIT	791440004429	S451	791440005327	PT538	791440006225	PA632	791440007215	C750-L	791440008151
PT381	791440004436	BT452	791440005334	PT539	791440006232	PA633(2)	791440007222	C750-L SINGLE	791440008168
PT382	791440004443	PA54	791440005358	P540	791440006249	PA634	791440007239	PT751	791440008175
PT383	791440004450	S455	791440005365	BT541	791440006263	PA638	791440007246	PT752	791440008182
PT385	791440004467	S456	791440005372	PT543 KIT	791440006287	PA639	791440007253	PT753	791440008199
PT385-E	791440004474	PT461	791440005389	P545	791440006300	PA640	791440007260	PT757	791440008212
PT386	791440004481	PT459	791440005396	PT546	791440006317	PA641	791440007277	PT757-10	791440008229
BT387	791440004498	PT461	791440005402	PT548	791440006324	PA642	791440007284	PT760-10	791440008243
BT387-10	791440004504	PT462	791440005419	PT549	791440006331	PA643	791440007291	PT760-25	791440008250
BT388	791440004511	PT463	791440005426	PT550-10	791440006348	PA644	791440007307	PT761	791440008267
BT388-10	791440004528	PT466	791440005457	PT551-10	791440006355	PA645	791440007314	PT763	791440008281
BT389	791440004535	PT467-MPG	791440005464	BF553	791440006397	PA648	791440007338	PT764	791440008298
BT389-10	791440004542	PT468-MPG	791440005471	PT554	791440006379	PA649	791440007345	PT765	791440008304
PT390-MPG	791440004559	PT469	791440005488	P555	791440006386	PA650	791440007352	PT766	791440008311
PT391-MPG	791440004566	BT470	791440005495	BT556-10	791440006393	PA651	791440007369	PT767	791440008328
PT392	791440004573	PT471	791440005501	PT558	791440006416	PA652	791440007376	PT768	791440008335
PT393	791440004580	BT472	791440005518	PT560 KIT	791440006423	PA653	791440007383	PT772	791440008373
PT394-5	7914400045163	B474	791440005525	PT561	791440006430	PA654	791440007390	PT773-MPG	791440008380
PT394-15	791440004597	PT475	791440005532	PT562-10	791440006454	PA655	791440007406	BT774	791440008397
BT395	791440004603	PA76	791440005549	PT563	791440006461	PA656	791440007413	BT775	791440008403
PT396	791440004610	PT477	791440005556	BT564	791440006478	PA657	791440007420	PT776-MPG	791440008410
PT397	791440004627	S479	791440005570	PT565	791440006485	PA658	791440007437	PT777	791440008427
BT398	791440004634	PT480	791440005587	PT566	791440006492	PA662	791440007475	BT778	791440008434
PT400	791440004641	PT480-10	791440005594	PT567	791440006508	PA666	791440007505	BT779	791440008441
PT401-MPG	791440004658	PT480-MPG	791440005600	PT567-10	791440006515	PA669	791440007512	BF781	791440008458
BT402	791440004665	B481	791440005617	PT568	791440006522	PT670	791440007529	BF782	791440008465
B403	791440004672	PT483	791440005631	PT571	791440006533	PT670-E	791440007536	BF783	791440008472
B404	791440004689	S485	791440005655	PT573	791440006577	PA671	791440007543	BF784	791440008489
JC405	791440004696	BT486	791440005662	BF577	791440006607	PA671-1	791440007550	BF785	791440008496
CU406	791440004702	PT487	791440005679	PT578	791440006614	PA675	791440007567	BF786	791440008502
DF408	791440004719	B488	791440005693	PT579	791440006621	PT676	791440007574	BF788	791440008526
TC413-CPE5	791440004849	S489	791440005709	BF582	791440006676	PA677	791440007581	BF789	791440008533
V414-B	791440004863	PT490	791440005716	BF583	791440006683	PA678	791440007598	BF790	791440008540
V414-FF	791440004870	PT491	791440005723	BF584	791440006690	PT679	791440007598	BF791	791440008557
F415-B	791440004887	PT491-10	791440005747	BF584-B	791440006706	PA680	791440007604	BF791-O	7914400097612
P415-10	791440004894	PT492	791440005754	BF585	791440006713	PT682	7914400052970	BF792	791440008564
P415-10A	791440004900	PT493	791440005761	BF586	791440006720	PT683	7914400052987	BF794	791440008588
P415-25	791440004917	B494	791440005778	BF586-D	791440006737	PT685-MPG	791440007611	BF795	791440008595
P415-25A	791440004924	B495	791440005785	BF587	791440006744	PA691	791440007628	BF797	791440008618
P415-5	791440004931	B495-MPG	7914400062474	BF587-D	791440006751	PT691	7914400054844	BF798	791440008625
P415-5A	791440004948	B495-SS	7914400050341	BF588	791440006768	PA693	791440007635	BF799	791440008632
P415-5AN	791440004955	PA96	791440005815	BF591	791440006874	PT694	791440007642	PF802	791440008670
P415-GM	791440004962	PA97	791440005822	BF592	791440006881	PA696	791440007662	PF804	791440008694
V415-B	791440004979	PT498	791440005839	BF593	791440006898	PA697	791440007673	BF805	791440008700
V415-FF	791440004986	PT498-10	791440005846	F594-F	7914400052949	PA699	791440007680	BF806	791440008717
PT416	791440004993	PT499-5	791440005853	PF594	791440006904	C704-L	791440007727	PF807	791440008724
PT418	791440005013	F501-MD	791440005884	BT595	791440006911	P706-M	791440007741	PF809	791440008748
BT420	791440005037	PT503	791440005907	BF596	791440006928	PT707-HD	791440007765	PF810	791440008755
B421	791440005044	PF506	791440005921	BF597	791440006935	PT707-HD10	791440007772	PF811	791440008762
S423	791440005051	P507	791440005938	PF598	791440006942	PT707-HD3	791440007789	BF812	791440008779
BT424	791440005068	PT508-MPG	791440005945	PF598-10	791440006959	PT708-HD	791440007796	PF814	791440008793
BT425	791440005075	PT509-MPG KIT	791440005952	PF598-30	791440006966	PT710	791440007802	PF816	791440008816
PT426	791440005082	PT510	791440005969	PF599	791440006973	PT716	7914400050938	PF816-S	791440008823
BT427	791440005099	PT512	791440005976	PF599-10	791440006980	PF717	791440007819	PF818	791440008847
V429-B	791440005112	PT513	791440005983	PF599-30	791440006997	PT718-5	791440007833	PF819	791440008854
V429-FF	791440005129	PT514	791440005990	PA602	791440007000	BF719	791440007840	PF819-HD	791440008861
PT430-FF	791440005136	PT515	791440006003	PA604	791440007014	BF720	791440007857	PF820-S	791440008878
PT431	791440005143	PT516	791440006010	B605	791440007024	PT721	791440007864	PF821-S	791440008885
PT433	791440005150	PT517	791440006027	BT606-MPG	791440006467	PT722	791440007871	PF822	791440008892
PT434	791440005167	PT518	791440006034	PA607	791440007048	P723	791440007888	PF823	791440008908
PT434-10	791440005174	PT518-10	791440006041	BT610-MPG	791440045927	PT725-MPG	791440007895	PF823-E	791440008953



WARNING: These products can expose you to chemicals, including Diisononyl Phthalate, Carbon black extracts, Nickel, 1,3 Butadiene, Ethylene Oxide, Epichlorohydrin, which are known to the State of California to cause cancer, and Bisphenol-A, Ethylene Glycol, Ethylene Oxide, 1,3 Butadiene, Epichlorohydrin, which are known to the State of California to cause birth defects or other reproductive harm. For more information go to www.P65Warnings.ca.gov.

BALDWIN TO UPC (INDIVIDUAL PARTS)

BALDWIN NUMBER	UPC NUMBER	BALDWIN NUMBER	UPC NUMBER	BALDWIN NUMBER	UPC NUMBER	BALDWIN NUMBER	UPC NUMBER	BALDWIN NUMBER	UPC NUMBER
PF824	791440008960	BF900	791440009868	BF989	791440010901	BF1219	791440011564	FK1304	791440011762
BF825	791440008984	PF902	791440009899	BF991	791440010925	BF1220	791440011571	OB1305	791440011779
PF826	791440008991	PF902-S	791440009905	BF992	791440010932	BF1221	791440011588	FB1306	791440077447
PF827	791440009004	PT903	791440009912	BF995	791440010956	BF1222	791440045675	FB1307	791440011786
PF828	791440009028	PF906	791440009950	P996	791440010963	BF1222-O	791440087217	OB1308	791440011793
PF829(2)	791440009035	PF907	791440009967	PF997	791440053021	BF1222-SP	791440045668	FB1309	791440011809
BF830	791440009042	F908-A	791440009974	P998	791440010970	BF1223	791440011595	FB1310	791440011816
PF831	791440009059	BF909	791440009981	P999-HD	791440010994	BF1223-O	791440087354	FB1311	791440011823
BF833	791440009073	PF910	791440009998	BF1008	791440049871	BF1223-SP	791440046115	OB1313	791440011830
BF833-K2	791440009080	BF912	791440010024	V1009-W	791440011038	BF1224	791440045033	OB1314	791440011847
F834-F	791440009097	PF913	791440010031	BF1010	791440049888	BF1225	791440011601	OB1315	791440011854
PF834	791440009103	BF914	791440010048	V1044-O	791440011069	BF1226	791440011618	OB1316	791440011861
BF836	791440009127	BF915	791440010055	BF1045	791440049574	BF1231	791440043343	OB1317	791440011878
BF836-K3	791440009134	F916-C	791440010062	BF1046	791440049581	BF1232	791440011632	OB1318	791440011885
BF836-K4	791440009141	PF916	791440010079	BF1047	791440049598	BF1233	791440011649	OB1319	791440011892
BF837	791440009158	BF918-K	791440010109	BF1048	791440049604	BF1239	791440042520	OB1320	791440011908
BF838-F2	791440009165	F919-C	791440010147	BF1049	791440049611	BF1240	791440050327	VG1325	791440011953
PF838	791440009172	BF920	791440010192	BF1050	791440049628	V1240-C	791440011670	PG1326	791440011960
BT839	791440009189	PF924	791440010237	PF924	791440050549	BF1248	791440050286	BF1329	791440045705
BT839-10	791440009196	BF925	791440010246	BF1053	791440050563	BF1249	791440050983	BF1329-O	791440085893
BF840	791440009202	PF926	791440010253	BF1054	791440050716	BF1249-O	791440093423	BF1329-SP	791440045644
BF840-K1	791440009219	BF928	791440010277	BF1056	791440050822	BF1249-SP	791440052666	BF1330-SP	791440058033
BT841	791440053441	BF929	791440010284	BF1057	791440051171	BF1252	791440051041	BF1339-SP	791440065437
V7842-O	791440009233	BF930	791440010291	BF1059	791440051191	BF1253	791440051515	BF1345	791440037892
BF843	791440009240	BF932	791440010321	BF1061	791440051205	BF1256	791440054530	BF1345-O	791440087262
F844-A	791440009257	BF933	791440010338	BF1100	791440047723	BF1257	791440053366	BF1345-SP	791440045804
F845-A	791440009264	PF935	791440010352	BF1102	791440011076	BF1258	791440047174	BF1346	791440038356
PF845	791440009271	PF936	791440010369	BF1104	791440011090	BF1259	791440011694	BF1346-O	791440088467
PF846	791440009288	PF937	791440010376	BF1105	791440011106	BF1261	791440054875	BF1346-SP	791440066014
PF847	791440009295	BF938	791440010383	BF1110	791440011144	BF1262	791440056817	BF1347	791440045781
PT849	791440009318	BF939	791440010390	BF1112	791440057807	BF1265	791440058286	BF1347-O	791440104662
PT849-10	791440009325	BF940	791440010406	BF1123	791440011182	BF1266	791440058729	BF1348	791440045903
V852-O	791440009356	BF941	791440010413	BF1140	791440011250	BF1267	791440058781	BF1348-O	791440088474
BF853	791440009363	PF942	791440010420	BF1148	791440011281	BF1268	791440059023	BF1348-SP	791440051898
BF855	791440009387	PF943	791440010437	BF1150	791440011298	BF1269	791440059290	BF1349	791440050624
BF856	791440009394	PF945	791440010451	BF1160	791440011342	BF1270-SP	791440059375	BF1350-SP	791440065062
PF857	791440009400	PF946	791440010468	BF1163	791440011366	BF1271	791440059856	BF1351-SP	791440066038
BF858	791440009417	PF947	791440010475	BF1166	791440011380	BF1272-SPS	791440078055	BF1352-SPS	791440078161
PF859	791440009424	BF948	791440010482	BF1170	791440011427	BF1273-SP	791440056749	BF1353-SPS	791440067462
PF860	791440009431	BF948-JD	791440010512	BF1171	791440011434	BF1274-SP	791440059733	BF1354-SPS	791440080645
PF861	791440009448	PF949	791440010529	BF1172	791440050266	BF1274-SPS	791440059740	BF1355	791440078604
BF862	791440009455	F950-F	791440010536	BF1173	791440041493	BF1275	791440063785	BF1355-O	791440090460
BF863	791440009462	F950-F WO	791440053007	BF1174	791440048898	BF1276	791440011700	BF1355-SP	791440076419
PF864	791440009479	PF950	791440010543	BF1177	791440049024	BF1277-SP	791440056732	BF1356	791440076754
BF865	791440009486	PT951	791440010550	BF1178	791440049031	BF1277-SPS	791440059337	BF1357	791440076853
BF865-K	791440009493	PF952	791440010567	BF1179	791440049048	BF1278	791440064072	BF1358-O	791440091313
PF866	791440009509	PF953-F	791440053014	BF1181	791440049086	BF1278-O	791440054520	BF1358-SP	791440076877
BF868	791440009523	BF954	791440010574	BF1182	791440049116	BF1279	791440064089	BF1359-SP	791440077775
PF869	791440009530	BF955	791440010581	BF1184	791440049123	BF1280	791440011717	BF1360	791440077973
PF872	791440009554	BF956	791440010598	BF1185	791440049130	BF1281	791440063297	BF1360-O	791440104655
BF873	791440009561	BF957	791440010604	BF1186	791440049147	BF1281-O	791440093492	BF1360-SP	791440083325
BF874	791440009578	BF957-D	791440010628	BF1188	791440049215	BF1282	791440057906	BF1361	791440078185
BF876	791440009592	BF958	791440010635	BF1190	791440049413	BF1282-O	791440094529	BF1362	791440078499
BF877	791440009615	BF959	791440010642	BF1191	791440049420	BF1283	791440063280	BF1363	791440078611
BF879	791440009646	P960	791440010659	BF1193	791440049444	BF1283-O	791440093515	BF1365	791440078758
BF880-FP	791440037991	PF962	791440010673	BF1194	791440049451	BF1283-SP	791440078482	BF1366-O	791440085855
BF881	791440009660	PF963	791440010680	BF1195	791440049468	BF1285-SP	791440064805	BF1367	791440078994
PF882	791440009677	BF964	791440010697	BF1199	791440049529	BF1286	791440066052	OB1368	791440012011
PF883	791440009684	BF966	791440010710	BF1201	791440011441	BF1287-O	791440086395	OB1369	791440012028
BF884	791440009691	PF967	791440010727	BF1204	791440045828	BF1288-O	791440086401	BF1370	791440079014
BF885	791440009707	BF968	791440010734	BF1204-O	791440097605	BF1289-SP	791440086852	BF1371	791440079038
BF886	791440009714	BF970	791440010741	BF1204-SP	791440045910	BF1290-O	791440087439	BF1373-SP	791440079199
BF888	791440009721	BF971	791440010758	BF1205	791440045811	PF1291	791440062511	BF1372	791440079342
BF890	791440009745	BF974-D	791440010772	BF1205-SP	791440045833	BF1292-O	791440087446	BF1374-SP	791440079267
BF891	791440009752	B975	791440010789	BF1210	791440011472	BF1293-SPS	791440078048	BF1375	791440079274
BF892	791440009769	BF976	791440010796	BF1211	791440011489	BF1294-O	791440087453	BF1376	791440079304
PF893	791440009776	BF978	791440010819	BF1212	791440011496	BF1295-O	791440087590	BF1377	791440079359
PF893-RV	791440009783	BF979	791440010826	BF1212 FOAM	791440011502	BF1296-O	791440087613	BF1378-SPS	791440079502
PF894	791440009790	BF980	791440010833	BF1213	791440011526	BF1297-O	791440087620	BF1379	791440079618
PF894-RV	791440009806	PF981	791440010840	BF1214	791440011533	BF1298-O	791440088672	BF1380	791440079625
BF896	791440009820	BF984	791440010864	BF1215	791440049383	BF1299-O	791440089112	BF1381	791440079632
BF897 KIT	791440009837	PF986	791440010871	BF1216	791440011540	FB1301	791440011731	BF1381-O	791440109537
SF898	791440009844	PF987	791440010888	BF1217	791440051089	FB1302	791440011748	BF1382-SP	791440079656
PF899	791440009851	BF988	791440010895	BF1218	791440011557	OB1303	791440011755	BF1383-O	791440087125



WARNING: These products can expose you to chemicals, including Diisononyl Phthalate, Carbon black extracts, Nickel, 1,3 Butadiene, Ethylene Oxide, Epichlorohydrin, which are known to the State of California to cause cancer, and Bisphenol-A, Ethylene Glycol, Ethylene Oxide, 1,3 Butadiene, Epichlorohydrin, which are known to the State of California to cause birth defects or other reproductive harm. For more information go to www.P65Warnings.ca.gov.

BALDWIN TO UPC (INDIVIDUAL PARTS)

BALDWIN NUMBER	UPC NUMBER	BALDWIN NUMBER	UPC NUMBER	BALDWIN NUMBER	UPC NUMBER	BALDWIN NUMBER	UPC NUMBER	BALDWIN NUMBER	UPC NUMBER
BF1384-SP	791440080249	PA1608	791440012295	LL1681-FN	791440013056	PA1802	791440013865	PA1895	791440014640
BF1385-SPS	791440080843	PA1609	791440012301	PA1681-FN	791440013063	PA1805	791440013889	PA1896	791440014657
BF1386-O	791440081253	PA1610	791440012318	PA1682	791440013070	PA1806	791440013896	PA1897	791440014664
BF1387-O	791440081345	PA1613	791440012325	PA1683	791440013087	PA1809	791440013919	PA1898	791440014671
BF1388-O	791440081352	PA1613-S	791440012332	PA1684	791440013094	PA1810	791440013926	PA1899	791440014688
BF1389-O	791440081567	LL1614	791440012349	PA1686	791440013100	PA1814	791440013940	PA1900	791440014695
BF1390-O	791440082205	PA1614	791440012356	PA1687	791440013117	PA1815	791440013957	PA1901	791440014701
BF1391-O	791440082250	LL1615	791440012363	PA1688	791440013124	PA1816	791440013964	LL1902-FN	791440014718
PF1392	791440086562	PA1615	791440012370	PA1689	791440013131	PA1817	791440013971	PA1902-FN	791440014725
BF1392-SPS KIT	791440082748	PA1615XP	791440090613	LL1690-FN	791440013148	PA1818	791440013988	PA1904	791440014732
BF1393-SP	791440082922	PA1618	791440012394	PA1690-FN	791440013155	PA1819	791440013995	PA1905	791440014749
BF1394-SP	791440083042	PA1619	791440012400	PA1692	791440013162	PA1821	791440014008	PA1906	791440014756
BF1395-O	791440084001	PA1620	791440012417	PA1696	791440013179	PA1822-FN	791440014015	PA1907-FN	791440014763
BF1395-SP	791440083080	PA1620-S	791440012424	PA1697	791440013186	PA1823	791440014022	PA1909	791440014770
BF1396	791440083226	LL1621-2	791440012431	PA1698	791440013193	PA1824	791440014039	PA1911	791440014787
BF1397-SP	791440084001	PA1621	791440012448	PA1699-FN	791440013209	PA1825	791440014046	PA1912	791440014794
BF1398-O	791440083288	PA1621-2	791440012455	PA1700	791440013216	PA1826	791440014053	PA1913	791440014800
BF1399-SP	791440084094	PA1621-S	791440012462	PA1701	791440013230	PA1827	791440014060	PA1915	791440014817
B1400	791440012035	PA1625	791440012486	PA1701 ELE	791440013247	PA1828	791440014077	PA1916	791440014824
B1402	791440012059	LL1626-2	791440012493	PA1701 FOAM	791440013254	PA1830-FN	791440014084	PA1919-FN	791440014831
BD1403	791440054899	PA1626	791440012509	PA1702	791440013261	PA1831	791440014091	PA1920	791440014848
B1405	791440043442	PA1626-2	791440012516	PA1702 FOAM	791440013285	PA1832	791440014107	PA1921	791440014855
B1406	791440012080	PA1627	791440012523	PA1703	791440013292	PA1834	791440014114	PA1922	791440014879
B1407	791440012097	PA1629-S	791440012530	PA1704	791440013315	PA1836	791440014121	PA1922-FN	791440014886
B1410	791440043558	LL1630-2	791440012547	PA1705-2	791440013322	PA1837-FN	791440014138	PA1926	791440014916
B1413	791440045545	PA1630	791440012554	PA1706	791440013339	PA1840	791440014152	PA1932	791440014923
B1416	791440054691	PA1630-2	791440012561	PA1706XP	791440090637	PA1841	791440014169	PA1934	791440014930
P1418	791440050136	PA1631-S	791440012578	PA1707-FN	791440013346	PA1845	791440014176	PA1936	791440014947
P1419	791440050143	PA1632	791440012585	PA1709	791440013353	LL1846	791440014183	PA1937	791440014954
B1421	791440050587	PA1633	791440012608	PA1710	791440013360	PA1846	791440014190	PA1940	791440014961
B1422	791440050846	LL1634	791440012615	PA1712	791440013377	PA1846XP	791440090774	PA1941-FN	791440014978
B1425	791440051782	PA1634	791440012622	PA1718	791440013391	PA1847-FN	791440014213	PA1945	791440015005
B1428	791440012127	PA1634XP	791440090743	PA1719	791440013407	PA1848	791440014220	PA1946	791440015012
B1429	791440038219	PA1635	791440012639	PA1721	791440013414	PA1849	791440014237	PA1949	791440015029
B1430	791440043077	LL1636-FN	791440012646	PA1726	791440013421	PA1850-FN	791440014244	PA1951	791440015043
B1431	791440055865	PA1636-FN	791440012653	PA1735	791440013445	PA1851	791440014251	PA1952	791440015050
B1432	791440055919	LL1637-FN	791440012660	PA1748	791440013469	PA1852	791440014268	PA1953	791440015067
P1433	791440065859	PA1637-FN	791440012677	PA1749-FN	791440013476	PA1857	791440014299	PA1956-FN	791440015081
B1434	791440058477	PA1639	791440012684	PA1750-FN	791440013483	PA1858	791440014305	PA1957	791440015098
B1435	791440058910	PA1641	791440012691	PA1752-FN	791440013490	PA1859	791440014312	PA1960	791440015104
B1438	7914400658743	LL1642-2	791440012707	PA1753-FN	791440013506	PA1860	791440014329	PA1961	791440015111
P1440	791440058996	PA1642-2	791440012714	PA1754	791440013513	PA1861	791440014336	PA1963	791440015128
B1441	791440060654	PA1643	791440012721	PA1755-FN	791440013520	PA1863	791440014343	PA1967	791440015135
P1443	791440060678	PA1644	791440012738	PA1757	791440013537	PA1864-FN	791440014367	PA1969	791440015142
B1444	791440061651	F1645-DS	791440012745	PA1758	791440013544	PA1865-FN	791440014374	PA1972	791440015166
B1446	791440062559	V1645-C	791440012752	PA1763	791440013551	PA1866	791440014381	PA1973	791440015173
B1447	791440064928	LL1646-FN	791440012769	PA1765	791440013568	PA1867	791440014398	PA1975	791440015197
P1510	791440012172	PA1646	791440012776	PA1766 FOAM	791440013575	PA1868	791440014404	PA1976	791440015203
P1511	791440012189	PA1646-FN	791440012783	PA1768	791440013582	PA1873	791440014411	PA1977-FN	791440015210
V1520-R	791440012196	PA1647	791440012790	PA1769	791440013599	V1874-T	791440014428	PA1978-FN	791440015227
V1542-C	791440012219	PA1648	791440012806	PA1771	791440013612	PA1875	791440014435	PA1979-FN	791440015241
V1544-T	791440012226	LL1649	791440012813	PA1772	791440013629	PA1877	791440014442	PA1980-FN	791440015265
V1560	791440062580	PA1649	791440012820	PA1773	791440013636	PA1880	791440014459	PA1981	791440015272
P1561	791440075351	PA1650-FN	791440012837	PA1774	791440013643	PA1881	791440014466	PA1982	791440015289
P1562	791440075368	PA1653	791440012851	PA1775	791440013650	PA1882	791440014473	PA1985	791440015296
P1563	791440075375	V1656-O	791440012868	PA1776	791440013667	PA1883-FN	791440014480	PA1986	791440015302
P1565	791440075399	V1656-T	791440012875	PA1777	791440013674	LL1884	791440014497	PA1986-K	791440015319
P1566	791440075405	PA1657	791440012882	PA1778	791440013681	PA1884	791440014503	PA1987	791440015326
P1567	791440075436	PA1661(3)	791440012899	PA1779	791440013698	PA1884XP	791440090620	PA1989-FN	791440015333
P1568	791440075443	PA1663	791440012905	PA1780	791440013704	LL1885	791440014510	LL1992	791440015340
P1575	791440075559	PA1664	791440012912	PA1781	791440013711	PA1885	791440014527	PA1992-FN	791440015371
P1576	791440075566	PA1666	791440012929	PA1782	791440013728	PA1885XP	791440090545	PA1995	791440015388
P1577	791440075573	LL1667-FN	791440012936	PA1783	791440013735	LL1886	791440014534	PA1996	791440015395
P1578	791440075634	PA1667-FN	791440012943	PA1784	791440013742	PA1886	791440014541	PA1997	791440015401
PF1584	791440075528	LL1669	791440012950	PA1786	791440013759	PA1886XP	791440090736	PA1998	791440015418
PF1585	791440075535	PA1669	791440012967	PA1787	791440013766	PA1888	791440014565	PA2001	791440015425
PF1587	791440075597	PA1670	791440012974	PA1788	791440013773	PA1889	791440014572	PA2001 FOAM	791440042643
PF1589	791440075610	PA1673	791440012981	PA1789	791440013780	PA1891	791440014589	PA2002	791440015432
PA1600	791440012233	PA1674	791440012998	PA1790	791440013797	PA1892-FN	791440014596	PA2005	791440015456
PA1602	791440012240	PA1675	791440013001	PA1794-FN	791440013803	PA1893	791440014602	PA2006	791440015463
PA1603	791440012257	LL1676-FN	791440013018	PA1795	791440013810	LL1894	791440014619	PA2007	791440015470
PA1606	791440012264	PA1676-FN	791440013025	PA1797	791440013827	PA1894	791440014626	PA2008	791440015487
PA1607	791440012271	PA1679	791440013032	PA1798	791440013834	PA1894XP	791440090576	PA2009	791440015494
LL1608	791440012288	PA1680	791440013049	PA1800	791440013841	LL1895	791440014633	PA2010	791440015500



WARNING: These products can expose you to chemicals, including Diisononyl Phthalate, Carbon black extracts, Nickel, 1,3 Butadiene, Ethylene Oxide, Epichlorohydrin, which are known to the State of California to cause cancer, and Bisphenol-A, Ethylene Glycol, Ethylene Oxide, 1,3 Butadiene, Epichlorohydrin, which are known to the State of California to cause birth defects or other reproductive harm. For more information go to www.P65Warnings.ca.gov.

BALDWIN TO UPC (INDIVIDUAL PARTS)

BALDWIN NUMBER	UPC NUMBER	BALDWIN NUMBER	UPC NUMBER	BALDWIN NUMBER	UPC NUMBER	BALDWIN NUMBER	UPC NUMBER	BALDWIN NUMBER	UPC NUMBER
PA2023	791440015531	PA2150	791440016606	PA2315	791440017511	PA2384	791440018297	PA2453XP	791440090583
PA2024	791440015548	PA2152	791440016620	PA2316	791440017535	PA2384XP	791440090590	PA2454	791440019065
SA2027	791440015562	PA2153	791440016637	LL2317	791440017542	PA2385	791440018303	PA2455	791440019072
PA2031	791440015579	PA2154	791440016644	PA2317	791440017559	PA2386	791440018310	LL2456	791440019089
PA2036	791440015609	PA2156	791440016668	LL2318	791440017566	PA2387	791440018327	PA2456	791440019096
PA2037	791440015616	PA2157	791440016675	PA2318	791440017573	PA2388	791440018334	PA2456XP	791440091375
PA2038	791440015623	PA2158	791440016682	PA2319	791440017580	PA2389-FN	791440018358	PA2457	791440019102
SA2039	791440015630	SA2159	791440016699	PA2320-FN	791440017597	PA2390	791440018365	LL2458	791440019119
PA2041	791440015647	PA2160	791440016705	PA2321	791440017603	PA2391	791440018372	PA2458	791440019126
PA2042	791440015654	PA2162	791440016729	PA2322	791440017610	PA2392	791440018389	PA2459	791440019133
PA2044	791440015661	PA2163	791440016736	PA2323	791440017627	LL2393	791440018396	PA2460	791440019140
SA2047	791440051508	PA2164	791440016743	LL2326	791440017641	PA2393	791440018402	PA2461	791440019164
PA2050	791440015692	PA2167	791440016774	PA2326	791440017658	PA2394	791440018419	PA2462	791440019171
PA2051	791440015708	PA2168	791440016781	PA2326XP	791440090767	PA2395	791440018426	PA2463	791440019188
PA2052	791440015715	PA2169	791440016798	PA2328	791440017672	PA2396	791440018433	PA2464	791440019195
PA2053	791440015722	PA2171	791440016811	PA2329	791440017689	PA2397	791440018440	PA2465	791440019218
PA2061	791440015777	PA2178	791440016880	LL2330	791440017696	PA2398	791440018457	PA2466	791440019225
PA2063	791440015791	PA2181	791440016910	PA2330	791440017702	PA2399	791440018464	PA2467	791440019232
PA2064	791440015807	PA2182	791440016927	PA2331	791440017719	PA2401	791440018488	PA2468	791440019249
PA2065	791440015814	PA2183	791440016934	PA2332	791440017726	PA2402	791440018495	PA2469	791440019256
PA2067	791440015838	PA2189	791440016972	LL2333	791440017733	PA2403	791440018501	PA2472	791440019263
PA2067 FOAM	791440073432	PA2191	791440016996	PA2333	791440017740	PA2404	791440018518	PA2473	791440019270
PA2068	791440015845	PA2192	791440017009	PA2335	791440017757	PA2405	791440018525	PA2474	791440019287
PA2068 FOAM	791440067646	PA2193	791440017016	PA2337	791440017764	PA2406	791440018532	PA2475	791440019294
PA2069	791440015852	PA2194	791440017023	PA2338-FN	791440017771	PA2407	791440018549	PA2476	791440019300
PA2069 FOAM	791440073425	PA2196	791440017047	PA2339	791440017788	PA2408	791440018556	PA2477	791440019317
PA2070	791440015869	PA2200	791440043459	PA2340	791440017795	PA2409	791440018563	PA2478	791440019324
PA2071	791440015876	PA2201	791440017085	PA2341	791440017801	PA2410	791440018570	PA2479	791440019331
PA2072	791440015883	PA2204	791440017115	PA2342	791440017818	PA2411	791440018587	PA2480	791440038608
PA2073	791440015890	PA2207	791440017146	PA2343	791440017825	PA2412	791440018594	PA2481	791440019348
PA2074	791440015906	PA2208	791440017153	LL2344-FN	791440017832	PA2413	791440018600	LL2482	791440019355
PA2075	791440015913	PA2212	791440017191	PA2344-FN	791440017849	PA2414	791440018617	PA2482	791440019362
PA2076	791440015920	PA2214	791440017214	PA2345	791440017856	PA2415	791440018624	PA2483	791440019379
PA2077	791440015937	PA2215	791440017221	PA2346	791440017863	PA2417-FN	791440018631	PA2484	791440019386
PA2079	791440015951	PA2216	791440017238	PA2347	791440017870	LL2418-FN	791440018648	PA2485	791440019393
PA2081	791440015968	PA2218	791440017252	PA2349-FN	791440017894	PA2418-FN	791440018655	PA2486	791440019409
PA2083	791440015982	PA2221	791440017283	PA2350	791440017900	PA2419	791440018662	PA2487	791440019416
SA2084	791440015999	PA2222	791440017290	PA2351	791440017917	PA2420	791440018679	PA2488-FN	791440019423
SA2085	791440016002	PA2223	791440017306	PA2352	791440017924	PA2421	791440018686	PA2489	791440019430
PA2091	791440016057	PA2223 FOAM	791440067653	PA2353	791440017931	PA2422	791440018693	PA2490	791440019447
PA2092	791440016064	PA2224	791440017313	PA2354	791440017948	PA2423	791440018709	PA2491	791440019454
PA2093	791440016071	PA2225	791440017320	PA2356	791440017955	LL2425	791440018716	LL2493	791440019478
PA2094	791440016088	PA2226	791440017337	PA2357	791440017979	PA2425	791440018723	PA2493	791440019485
PA2095	791440016095	PA2227	791440043466	LL2358	791440017986	LL2426-FN	791440018730	PA2494	791440019508
PA2096	791440016101	PA2229	791440043480	PA2358	791440017993	PA2426-FN	791440018747	PA2495	791440019515
PA2099	791440016118	PA2230	791440043497	PA2359	791440018006	PA2427	791440018754	PA2496	791440019522
PA2100	791440016125	PA2231	791440045118	LL2360-FN	791440018013	PA2428	791440018761	PA2497	791440019539
PA2101A	791440016132	PA2232	791440045484	PA2360-FN	791440018020	PA2429	791440018778	PA2498	791440019546
PA2102	791440016149	PA2233	791440045699	LL2361	791440018037	PA2430	791440018785	PA2499	791440019553
PA2103	791440016156	PA2234	791440046078	PA2361	791440018044	PA2431	791440018792	PA2500	791440019560
PA2104	791440016163	PA2235	791440048881	PA2361XP	791440103481	PA2432	791440018808	PA2502	791440019584
PA2106	791440016187	PA2237	791440049093	PA2362	791440018051	PA2433	791440018815	LL2503	791440019591
PA2107	791440016194	PA2240	791440049734	LL2363	791440018068	PA2434	791440018822	PA2503	791440019607
PA2109	791440016217	PA2241	791440049741	PA2363	791440018075	PA2435	791440018839	PA2504	791440019614
PA2110	791440016224	PA2243	791440049765	PA2363XP	791440090606	PA2436	791440018846	LL2507	791440019621
PA2113	791440016255	PA2244	791440049772	PA2364	791440018082	PA2437	791440018853	PA2507	791440019638
PA2114	791440016262	PA2256	791440017344	PA2367	791440018099	PA2438	791440018877	PA2508	791440019645
PA2115	791440016279	PA2257	791440017351	PA2368	791440018105	LL2439	791440018884	PA2509	791440019652
PA2116	791440016286	PA2258	791440038592	PA2369	791440018112	PA2439	791440018891	PA2510	791440019669
PA2117	791440016293	PA2260	791440037601	PA2370	791440018129	PA2440	791440018907	PA2511	791440019676
PA2121	791440016323	PA2300	791440017368	PA2371	791440018136	PA2441	791440018914	PA2512	791440019683
PA2124	791440016354	PA2301	791440017375	PA2372	791440018143	PA2442	791440018921	PA2513	791440019690
PA2125	791440016361	PA2302-FN	791440017382	PA2374	791440018167	PA2443	791440018938	PA2514	791440019706
PA2127	791440016385	PA2303	791440017399	PA2375	791440018174	PA2444	791440018945	PA2515	791440019720
PA2134	791440016453	PA2304-FN	791440017405	PA2376	791440018181	PA2445	791440018952	LL2516	791440019737
PA2135	791440016460	PA2305	791440017412	PA2377	791440018198	PA2446	791440018969	PA2516	791440019744
PA2136	791440016477	PA2306	791440017429	PA2378	791440018204	LL2447-FN	791440018976	PA2517	791440019751
PA2138	791440016491	PA2307	791440017436	PA2379	791440018211	PA2447-FN	791440018983	LL2518	791440019768
PA2139	791440016507	PA2308	791440017443	PA2379-K	791440018228	PA2448	791440018990	PA2518	791440019775
PA2139 FOAM	791440038585	PA2310	791440017467	PA2380-FN	791440018235	PA2450	791440019017	PA2518XP	791440090729
PA2140	791440016514	LL2312	791440017474	PA2381	791440018242	PA2451	791440019020	PA2519	791440019782
PA2147	791440016576	PA2312	791440017481	PA2382	791440018266	PA2452	791440019034	PA2520	791440019805
PA2148	791440016583	PA2313	791440017498	PA2383	791440018273	LL2453	791440019041	LL2521	791440019812
PA2149	791440016590	PA2314	791440017504	LL2384	791440018280	PA2453	791440019058	PA2521	791440019829



WARNING: These products can expose you to chemicals, including Diisononyl Phthalate, Carbon black extracts, Nickel, 1,3 Butadiene, Ethylene Oxide, Epichlorohydrin, which are known to the State of California to cause cancer, and Bisphenol-A, Ethylene Glycol, Ethylene Oxide, 1,3 Butadiene, Epichlorohydrin, which are known to the State of California to cause birth defects or other reproductive harm. For more information go to www.P65Warnings.ca.gov.

BALDWIN TO UPC (INDIVIDUAL PARTS)

BALDWIN NUMBER	UPC NUMBER	BALDWIN NUMBER	UPC NUMBER	BALDWIN NUMBER	UPC NUMBER	BALDWIN NUMBER	UPC NUMBER	BALDWIN NUMBER	UPC NUMBER
PA2522	791440019836	PA2595	791440020672	PA2665	791440021471	PA2744	791440022324	PA2833	791440023062
PA2523	791440019843	PA2596	791440020696	PA2666	791440021488	PA2745	791440022331	PA2834	791440023079
PA2524-FN	791440019850	PA2598	791440020719	LL2667	791440021495	PA2746	791440022348	PA2835	791440023086
LL2525	791440019867	PA2599	791440020726	PA2667	791440021501	PA2747	791440022355	PA2836	791440023093
PA2525	791440019874	PA2600	791440020733	PA2668	791440021518	PA2748	791440022362	PA2837	791440023109
PA2526	791440019881	PA2601	791440020740	PA2669-FN	791440021525	PA2749	791440022386	PA2838	791440045361
PA2527	791440019898	PA2602	791440020757	PA2670	791440021532	PA2750	791440022393	PA2839	791440023116
PA2528	791440019904	PA2604	791440020771	PA2672	791440021556	PA2751	791440022409	PA2840	791440053557
PA2529	791440019911	PA2605	791440020788	PA2673	791440021563	PA2752	791440022416	PA2843	791440023123
PA2530	791440019928	PA2606	791440020795	PA2674	791440021570	PA2753	791440022423	PA2844	791440023130
PA2531	791440019942	PA2607	791440020801	PA2675	791440021594	PA2754	791440022430	PA2845	791440023147
PA2532	791440019966	LL2608	791440020818	LL2676	791440021600	PA2755	791440022447	PA2846-FN	791440023154
PA2533	791440019980	PA2608	791440020825	PA2676	791440021617	PA2756	791440022454	PA2847	791440023161
PA2534	791440019997	LL2609	791440020832	PA2676XP	791440090781	PA2757	791440022461	PA2848	791440023168
PA2535	791440020009	PA2609	791440020849	PA2677	791440021624	PA2759	791440053458	PA2849	791440023175
PA2536	791440020016	PA2610	791440020856	PA2678	791440021631	PA2761	791440022478	PA2851	791440023182
PA2538	791440020023	PA2611	791440020863	PA2679	791440021655	PA2763	791440022485	PA2852	791440023208
PA2539	791440020030	PA2612	791440020870	PA2680	791440021662	PA2767	791440022492	PA2853	791440023215
PA2540	791440020047	PA2613	791440020887	PA2684-FN	791440021693	PA2771	791440053489	PA2854	791440023222
PA2541-FN	791440020054	PA2614	791440020894	LL2685	791440021709	PA2772	791440022508	PA2855	791440023239
PA2542	791440020061	PA2615	791440020900	PA2687	791440021730	PA2773	791440022515	PA2856	791440023246
PA2544	791440020085	PA2616	791440020917	LL2688	791440021747	PA2774	791440022522	PA2857	791440023253
PA2545	791440020092	PA2616XP	791440090750	PA2688	791440021754	PA2775	791440022539	PA2858	791440023260
PA2546	791440020108	PA2617	791440020924	PA2689	791440021761	PA2776	791440022546	PA2859-FN	791440053588
PA2547	791440020115	LL2618	791440020931	PA2690	791440021778	PA2777	791440022553	PA2860-FN	791440045378
PA2548	791440020122	PA2618	791440020948	PA2691	791440021785	PA2778-FN	791440022560	PA2861	791440023277
PA2549	791440020139	PA2619	791440020955	PA2692	791440021792	LL2779	791440022577	PA2862	791440045385
PA2550	791440020146	PA2620	791440020962	PA2693	791440021808	PA2779	791440022584	PA2862 FOAM	791440053595
PA2551	791440020153	PA2621	791440020979	PA2694	791440021815	PA2781	791440022607	RS2863	791440023291
PA2552	791440020160	PA2622	791440020986	PA2696	791440021839	PA2782	791440022614	RS2863XP	791440090873
PA2553	791440020177	PA2623	791440020993	PA2698	791440021846	PA2783	791440022638	PA2865	791440023307
PA2554	791440020184	PA2624	791440021006	PA2699	791440021860	PA2784	791440022645	PA2866	791440053601
PA2554 FOAM	791440038615	PA2625	791440021013	PA2700	791440021877	PA2785	791440022652	PA2867-FN	791440053618
PA2555	791440020207	PA2626	791440021020	PA2701	791440021884	PA2786	791440022669	PA2869	791440045392
PA2556	791440020221	PA2627	791440021037	PA2702	791440021891	PA2787	791440022676	PA2870-FN	791440053625
LL2557	791440020238	PA2628	791440021044	PA2703	791440021907	PA2788	791440022683	PA2871	791440052536
PA2557	791440020245	PA2629	791440021051	PA2704	791440021914	PA2789	791440022690	PA2873	791440053632
PA2558	791440020269	PA2630	791440021068	PA2705	791440021921	PA2790-FN	791440022706	PA2874	791440023321
LL2559	791440020276	PA2631	791440021075	PA2706	791440021938	PA2791	791440022713	PA2875	791440023338
PA2559	791440020283	PA2632	791440021082	PA2707	791440021954	PA2792	791440022720	PA2876	791440023345
LL2562	791440020313	PA2633-FN	791440021099	PA2708	791440021962	PA2793	791440022737	PA2877-FN	791440052680
PA2562	791440020320	PA2634	791440021105	PA2709	791440021969	PA2794	791440022744	PA2878	791440045408
PA2562XP	791440090569	PA2635-FN	791440021112	PA2710	791440021976	PA2796	791440022758	PA2880	791440053656
PA2563	791440020337	PA2636	791440021129	PA2711	791440021983	PA2797	791440022765	PA2881	791440053663
PA2564	791440020344	PA2637	791440021136	PA2712	791440021990	PA2798	791440022782	PA2883	791440053687
PA2566	791440020368	PA2638	791440021143	PA2713	791440022003	PA2799	791440022799	PA2884	791440053694
PA2567	791440020375	PA2640	791440021150	PA2714	791440022010	PA2800-FN	791440053496	PA2885	791440053701
PA2568	791440020382	PA2641	791440021174	PA2715	791440022027	PA2801	791440022805	PA2887-FN	791440053717
PA2569	791440020399	LL2642	791440021181	PA2716	791440022034	PA2803	791440022812	PA2888	791440053724
PA2570	791440020405	PA2642	791440021198	PA2717	791440022041	PA2804	791440046924	PA2889	791440053731
PA2571	791440020412	PA2643	791440021204	PA2718	791440022058	PA2805	791440022836	PA2890	791440053748
PA2572	791440020429	PA2644	791440021211	PA2719	791440022065	PA2806	791440022843	PA2891	791440045415
PA2573	791440020436	PA2645	791440021228	PA2721	791440022089	PA2807	791440022850	PA2895	791440053762
PA2573XP	791440090552	PA2646	791440021235	PA2722	791440022096	PA2812	791440022867	PA2896	791440061330
LL2574	791440020443	PA2647	791440021242	PA2723	791440022102	PA2813	791440051317	PA2897	791440053779
PA2575	791440020450	PA2648	791440021259	PA2724	791440022119	PA2814	791440022874	PA2899	791440053793
PA2575	791440020467	PA2649	791440021266	PA2725	791440022126	PA2815	791440022881	PA2900	791440023352
PA2576	791440020474	PA2650	791440021273	PA2726	791440022133	PA2816	791440022898	PA2902	791440023369
PA2577	791440020481	PA2651	791440021280	PA2727	791440022140	PA2817	791440022905	PA2903	791440041141
PA2578	791440020498	PA2652	791440021297	PA2728	791440022157	PA2818	791440022911	PA2904	791440053809
PA2579	791440020504	PA2653	791440021303	PA2729	791440022164	PA2819	791440022928	PA2905	791440053816
PA2580	791440020511	PA2653 FOAM	791440021310	PA2730	791440022171	PA2820	791440022935	PA2906	791440053823
PA2581	791440020528	PA2654	791440021327	PA2731	791440022188	PA2821	791440022942	PA2909	791440053847
LL2582	791440020535	PA2655	791440021334	PA2732	791440022195	PA2822	791440022959	PA2912	791440053878
PA2582	791440020542	PA2656	791440021358	PA2733	791440022201	PA2823	791440022966	PA2913	791440053885
PA2583	791440020559	PA2657-FN	791440021365	PA2734	791440022225	PA2824	791440022973	PA2914	791440053892
PA2585	791440020573	PA2658	791440021372	PA2735	791440022232	PA2825	791440022980	PA2915	791440053909
PA2586	791440020580	PA2659	791440021396	PA2736	791440022249	PA2826	791440022997	PA2919	791440053915
PA2587	791440020597	PA2660	791440021402	PA2737	791440022256	PA2827	791440023000	PA2932	791440023376
PA2588	791440020603	LL2661	791440021419	PA2738	791440022263	PA2828	791440023017	PA2933	791440023383
PA2589-FN	791440020610	PA2661	791440021426	PA2739	791440022270	PA2829	791440023024	PA2935	791440023390
PA2591	791440020634	PA2662	791440021433	PA2740	791440022287	PA2830	791440023031	PA2936	791440023406
PA2592	791440020641	PA2663-FN	791440021457	PA2742	791440022300	PA2831	791440023048	PA2938	791440023413
PA2593	791440020658	PA2664	791440021464	PA2743	791440022317	PA2832	791440023055	PA2942	791440051645



WARNING: These products can expose you to chemicals, including Diisononyl Phthalate, Carbon black extracts, Nickel, 1,3 Butadiene, Ethylene Oxide, Epichlorohydrin, which are known to the State of California to cause cancer, and Bisphenol-A, Ethylene Glycol, Ethylene Oxide, 1,3 Butadiene, Epichlorohydrin, which are known to the State of California to cause birth defects or other reproductive harm. For more information go to www.P65Warnings.ca.gov.

BALDWIN TO UPC (INDIVIDUAL PARTS)

BALDWIN NUMBER	UPC NUMBER	BALDWIN NUMBER	UPC NUMBER	BALDWIN NUMBER	UPC NUMBER	BALDWIN NUMBER	UPC NUMBER	BALDWIN NUMBER	UPC NUMBER
PA2944-FN	791440023444	PA3469	791440025851	RS3543	791440041240	PA3660-FN	791440043800	RS3749	791440055193
LL2945	791440023451	PA3470	791440025868	RS3544	791440041257	PA3664-FN	791440045590	RS3750	791440056657
PA2945	791440023468	PA3471	791440025875	RS3545	791440041264	PA3667-FN	791440043831	PA3752	791440048485
PA2946	791440023475	PA3472	791440067691	RS3546	791440041271	PA3668	791440045620	PA3753	791440048492
PA2947	791440023482	PA3472-FN	791440025882	RS3547	791440041288	PA3669-FN	791440045637	PA3754	791440048508
PA2948	791440053939	PA3473	791440025899	RS3548	791440043060	PA3670	791440045672	PA3755	791440048614
PA2949-FN	791440023499	PA3474	791440025905	RS3548XP	791440098087	PA3671-FN	791440045996	PA3756	791440048621
PA2950	791440053946	PA3475	791440025912	RS3549	791440045729	PA3672	791440045989	PA3757	791440048638
PA2951	791440048836	PA3476	791440025929	RS3550	791440038448	PA3674	791440046016	PA3758	791440048645
PA2952	791440048850	PA3477	791440025936	PA3551	791440026278	PA3675	791440046085	PA3759	791440048652
PA2953	791440053953	PA3478	791440025943	PA3554	791440026285	PA3676	791440046092	PA3760	791440048669
PA2954-FN	791440053960	PA3478XP	791440103931	PA3555	791440026292	PA3679	791440046528	PA3761-FN	791440048683
PA2955	791440045446	PA3479	791440025950	PA3556	791440026308	PA3680	791440046795	PA3763	791440048737
PA2956-FN	791440052727	PA3480	791440030459	PA3557-FN	791440026315	PA3681	791440046818	RS3764	791440057456
PA2957	791440052710	PA3481	791440025967	PA3558	791440026322	PA3682	791440046825	PA3765	791440048805
PA2958	791440053977	PA3482	791440025974	PA3559	791440026339	PA3683	791440046832	PA3766	791440048812
PA2959-FN	791440052697	PA3483	791440049284	PA3560	791440026346	PA3684	791440046849	PA3767	791440049642
PA2960	791440052703	PA3484	791440049277	PA3562	791440026353	PA3685	791440046856	PA3768	791440049659
PA2961-FN	791440052673	PA3486	791440025981	PA3563	791440026360	PA3686	791440046863	PA3772	791440049390
PA2962	791440053984	PA3487	791440025998	PA3565	791440026377	PA3687	791440046870	PA3773	791440049567
PA2963	791440045453	PA3491	791440038660	PA3566	791440026384	PA3688	791440047228	PA3774	791440050051
PA2964	791440053991	PA3492	791440026001	PA3568	791440037915	PA3689	791440047549	PA3775	791440050068
PA2967	791440054004	PA3493	791440030527	PA3569	791440026391	PA3690	791440047525	PA3777	791440050235
PA2968-FN	791440056701	PA3494	791440047150	PA3572	791440026438	PA3691	791440048089	PA3778	791440050259
PA2970	791440054028	PA3495	791440026018	PA3573	791440026445	PA3697	791440047860	PA3779-FN	791440050310
PA2971	791440054035	PA3496	791440026025	PA3576	791440026469	PA3698	791440048171	PA3780	791440050365
PA2973	791440023505	PA3497	791440026032	PA3578	791440038035	PA3699	791440048201	PA3781	791440050495
PA2976-FN	791440054066	PA3498	791440026049	PA3579	791440038738	RS3700	791440043510	PA3782	791440050662
PA2977-FN	791440050273	PA3499	791440041325	PA3580	791440026483	RS3700XP	791440090859	PA3783	791440050679
PA2978	791440023529	RS3501	791440026056	PA3581	791440026490	RS3701	791440043527	PA3785-FN	791440051416
PA2980	791440054073	RS3502	791440026063	PA3584	791440038745	RS3703	791440045736	PA3786-FN	791440050952
PA2981	791440054080	RS3503	791440026070	PA3587	791440037908	RS3704	791440045743	PA3787	791440050921
PA2982	791440054097	RS3504	791440026087	PA3588	791440037947	RS3705	791440045750	PA3790	791440051546
PA2984	791440023536	RS3504XP	791440090941	PA3595	791440038096	RS3706	791440046344	PA3791-FN	791440051560
PA2988	791440023543	RS3505	791440026094	PA3597	791440037533	RS3707	791440046351	PA3792	791440051577
PA2989	791440023550	RS3506	791440026100	PA3598	791440037540	RS3708	791440046375	PA3793	791440051584
HSG3077	791440082847	RS3506XP	791440090927	PA3600	791440037595	RS3709	791440046382	PA3794	791440051607
HSG3078	791440085558	RS3507	791440026117	PA3601	791440037649	RS3710	791440046771	PA3795	791440051751
HSG3079	791440092006	RS3508	791440026124	PA3602	791440037700	RS3711	791440046788	PA3796	791440051713
HSG3080	791440092013	RS3508XP	791440090835	PA3604	791440037724	RS3712	791440047563	PA3797	791440051720
AB3349	791440085565	RS3509	791440026131	PA3605	791440037755	RS3713	791440050588	PA3798	791440051874
PA3404	791440025523	RS3510	791440026148	PA3606	791440037762	RS3714	791440048188	PA3800	791440052345
PA3405	791440054141	RS3510XP	791440090811	PA3607-FN	791440037779	RS3715	791440048232	PA3801-FN	791440052772
PA3406-FN	791440025530	RS3511	791440026155	PA3608-FN	791440037786	RS3716	791440049666	PA3802	791440052482
PA3408	791440025554	RS3512	791440026162	PA3609	791440037793	RS3717	791440049321	PA3803	791440052499
PA3411-FN	791440054158	RS3513	791440026179	PA3610	791440037809	RS3718	791440049307	PA3804	791440052503
PA3412	791440054851	RS3514	791440026186	PA3611	791440037816	RS3719	791440049314	PA3805-FN	791440052545
PA3414	791440054165	RS3514XP	791440090842	PA3612	791440038264	RS3720	791440049703	PA3806	791440053052
PA3415	791440054172	RS3515	791440026193	PA3613	791440038271	RS3721	791440052468	PA3807	791440054738
PA3416	791440054189	RS3516	791440026209	PA3614	791440038332	RS3722	791440050990	PA3808-FN	791440053038
PA3417	791440054196	RS3517	791440043039	PA3627	791440042469	RS3724	791440051294	PA3809	791440053045
PA3419	791440052215	RS3517XP	791440090880	PA3628	791440042476	RS3726	791440052246	PA3810	791440053106
PA3420	791440025592	RS3518	791440038431	PA3629	791440042483	RS3727	791440052239	PA3811-FN	791440053267
PA3421	791440025608	RS3518XP	791440108905	PA3630-FN	791440042575	RS3728	791440052246	PA3812	791440053274
PA3430	791440038028	RS3519	791440047501	PA3631	791440042582	RS3729	791440052253	PA3814	791440053311
PA3435-FN	791440061934	RS3520	791440038677	PA3632	791440042599	RS3730	791440051881	PA3815	791440053328
PA3438	791440025615	RS3521	791440050570	PA3633	791440042605	RS3731	791440052314	PA3816	791440053620
PA3439-FN	791440025622	RS3528	791440038424	PA3633 FOAM	791440055803	RS3732	791440056824	PA3817	791440058224
PA3440	791440025639	RS3529	791440042827	PA3636	791440042667	RS3733	791440051980	PA3818-FN	791440058217
PA3442	791440025653	RS3530	791440038363	PA3637	791440042704	RS3734	791440052734	PA3819	791440058590
PA3446	791440038646	RS3530XP	791440090910	PA3638	791440042711	RS3734XP	791440090934	PA3820-FN	791440058613
PA3447	791440025677	RS3531	791440048768	PA3640	791440042735	RS3735	791440052598	PA3821	791440058200
PA3448	791440025684	RS3532	791440039377	PA3643	791440042810	RS3736	791440052550	PA3822	791440054394
PA3449	791440038172	RS3533	791440039384	PA3644	791440042858	RS3737	791440052567	PA3823	791440054400
PA3452	791440038653	RS3534	791440045170	PA3645	791440042889	RS3738	791440052857	PA3824	791440054417
PA3453	791440025714	RS3535	791440039391	PA3650	791440043244	RS3739	791440052864	PA3825	791440058071
PA3457	791440025738	RS3536	791440045132	PA3651-FN	791440043251	RS3740	791440053175	RS3826	791440057463
PA3458	791440025745	RS3537	791440042834	PA3652	791440043268	RS3741	791440053182	RS3827	791440057470
PA3460	791440025769	RS3538	791440038370	PA3653	791440043299	RS3743	791440054370	PA3828	791440058088
PA3461	791440025776	RS3539	791440045187	PA3654	791440043428	RS3744	791440054707	PA3829	791440058095
PA3463	791440025790	RS3539XP	791440093188	PA3655	791440043589	RS3744XP	791440090804	PA3832	791440054523
PA3464	791440025806	RS3540	791440038042	PA3656	791440043602	RS3745	791440054714	PA3833	791440054561
PA3466-FN	791440025820	RS3541	791440043848	PA3657	791440043596	RS3746	791440055209	PA3834	791440054585
PA3467	791440025837	RS3542	791440041233	PA3658	791440043619	RS3747	791440055148	PA3835	791440054592



WARNING: These products can expose you to chemicals, including Diisononyl Phthalate, Carbon black extracts, Nickel, 1,3 Butadiene, Ethylene Oxide, Epichlorohydrin, which are known to the State of California to cause cancer, and Bisphenol-A, Ethylene Glycol, Ethylene Oxide, 1,3 Butadiene, Epichlorohydrin, which are known to the State of California to cause birth defects or other reproductive harm. For more information go to www.P65Warnings.ca.gov.

BALDWIN TO UPC (INDIVIDUAL PARTS)

BALDWIN NUMBER	UPC NUMBER	BALDWIN NUMBER	UPC NUMBER	BALDWIN NUMBER	UPC NUMBER	BALDWIN NUMBER	UPC NUMBER	BALDWIN NUMBER	UPC NUMBER
PA3836	791440055049	PA3915	791440057845	RS3997	791440061293	PA4145	791440062238	PA4324	791440081062
PA3837	791440055063	PA3916	791440057944	RS3998	791440061002	PA4146	791440062528	PA4325	791440081109
PA3838	791440056350	PA3917	791440058118	RS3998XP	791440090866	PA4147	791440062535	PA4327	791440081086
PA3839	791440056293	PA3918	791440058293	RS3999	791440061040	PA4148	791440062542	PA4328	791440081093
PA3840	791440055087	PA3919	791440058309	PA4005	791440043435	PA4149 KIT	791440063082	PA4329	791440081215
PA3842	791440054806	RS3920	791440058354	PA4015	791440038691	PA4150	791440063464	PA4330	791440081376
PA3843	791440054813	RS3921	791440058361	PA4016	791440026551	PA4151	791440064317	PA4331	791440081383
PA3844	791440056367	RS3922	791440058378	PA4018	791440026568	PA4152	791440064492	PA4332	791440081390
PA3847	791440056381	RS3923	791440058385	PA4023	791440026582	PA4153	791440064508	PA4333	791440081574
PA3848-FN	791440056398	PA3924-FN	791440058415	PA4028	791440026605	PA4154	791440064515	PA4334	791440081505
PA3849	791440056404	PA3925	791440058651	PA4031	791440026612	PA4156 KIT	791440065048	PA4335	791440081512
PA3850	791440056411	RS3926	791440058422	PA4041	791440043565	PA4157	791440065055	PA4336	791440081581
PA3851	791440056428	RS3927	791440058439	PA4042	791440048959	PA4158	791440065253	PA4337	791440081604
PA3852-FN	791440056435	PA3928	791440058491	PA4043	791440048966	PA4159	791440065406	PA4338	791440081796
PA3853-FN	791440056442	RS3929	791440058545	PA4044	791440049222	PA4160	791440065444	PA4340	791440081802
PA3854-FN	791440056459	PA3930	791440058675	RS3930	791440049239	RS4161	791440065451	PA4341	791440081819
PA3856	791440056473	PA3931	791440058736	PA4046	791440049246	PA4162	791440065536	PA4344	791440081826
PA3855-FN	791440056466	PA3932	791440058710	PA4048	791440049345	PA4163	791440065888	PA4345	791440081833
PA3857	791440056480	PA3933	791440058725	PA4049	791440049406	PA4164	791440066083	PA4348	791440081840
PA3859	791440056503	RS3934	791440058873	PA4050	791440026650	PA4165	791440066090	PA4349	791440081857
PA3860	791440056510	RS3935	791440058880	PA4060	791440026681	PA4166	791440066656	PA4350	791440081864
PA3861	791440056527	RS3936	791440058903	PA4069	791440043626	PA4167	791440066762	PA4351	791440081871
PA3862-FN	791440056534	PA3937	791440059047	PA4070	791440043633	PA4168	791440067073	PA4352	791440081888
PA3863	791440056541	PA3938	791440059078	PA4071	791440043640	PA4169	791440067134	PA4353	791440081994
PA3864	791440056558	PA3939	791440059351	PA4072	791440043794	PA4170	791440072602	PA4355	791440082014
PA3865	791440056565	RS3940	791440059368	PA4073	791440043817	PA4171	791440074927	PA4356	791440082021
PA3867	791440055155	PA3941	791440059399	PA4075	791440047068	PA4172	791440076761	PA4357	791440082038
PA3868	791440055162	RS3942	791440059429	PA4076	791440047075	PA4173	791440077188	PA4358	791440082045
PA3869	791440058064	RS3943	791440059436	PA4077	791440047532	PA4174	791440077195	PA4359	791440082052
RS3870	791440055179	PA3944	791440059443	PA4078	791440047679	PA4175	791440077997	PA4360	791440082069
RS3871	791440055186	PA3945	791440059450	PA4079	791440047877	PA4176	791440078000	PA4361	791440082076
PA3872	791440055926	PA3946	791440059467	PA4081	791440049536	PA4177	791440078123	PA4362	791440082083
PA3873	791440055933	PA3947	791440059474	PA4082	791440049543	PA4178	791440078666	PA4363	791440082212
PA3874	791440055230	PA3948	791440059481	PA4084	791440050044	PA4179	791440078673	PA4364	791440082229
PA3875-FN	791440056022	PA3949	791440060760	PA4085	791440050303	PA4180	791440078680	PA4365	791440082236
PA3876	791440056770	PA3950	791440059511	PA4088	791440051140	PA4181	791440078697	PA4366	791440082267
PA3877	791440055827	PA3951	791440059016	PA4089	791440051157	PA4182	791440078703	PA4367	791440082335
PA3878	791440055834	RS3952	791440059597	PA4091	791440051218	PA4183	791440078710	PA4368	791440082342
PA3879-FN	791440055841	PA3953	791440059498	PA4092	791440051409	PA4184	791440079090	PA4370	791440082366
PA3880	791440056039	RS3954	791440059603	PA4093	791440051737	PA4185	791440079366	PA4371	791440082373
PA3881	791440056091	PA3956	791440059801	PA4094	791440051744	PA4187	791440079649	PA4372	791440082380
RS3882	791440056046	PA3957	791440059863	PA4096	791440052017	PA4188	791440080270	PA4373	791440082397
RS3882XP	791440098985	PA3957 FOAM	791440073418	PA4099	791440052307	RS4189	791440080294	PA4374	791440082458
RS3883	791440056053	PA3958	791440059948	PA4100	791440052444	PA4190	791440080300	PA4375	791440082472
RS3884	791440056060	PA3959	791440060029	PA4102	791440053137	PA4191	791440080317	PA4376	791440082489
RS3885	791440056077	PA3961	791440059955	PA4103	791440054516	PA4192	791440080409	PA4377	791440082496
PA3886	791440056107	BA3964(4)	791440060074	PA4104	791440054639	PA4193	791440080416	PA4380	791440082502
PA3887	791440056220	BA3965(4)	791440060081	PA4105	791440054646	PA4194	791440080423	PA4381	791440082519
RS3888	791440056237	PA3966	791440060098	PA4106	791440054653	PA4195 KIT	791440080430	PA4382	791440082526
PA3889	791440056244	PA3967	791440060111	PA4107	791440054660	PA4196	791440080447	PA4383	791440082533
PA3890	791440056282	PA3969	791440060166	PA4108	791440054950	PA4197	791440080454	PA4384	791440082540
PA3891	791440056343	PA3970	791440060173	PA4109	791440054967	PA4198	791440080461	PA4385	791440082557
PA3892	791440056756	RS3971	791440061095	PA4110	791440055131	PA4199	791440080478	PA4386	791440082564
PA3893	791440056763	PA3972	791440060197	PA4111	791440055608	PA4303	791440080485	PA4387	791440082571
PA3894	791440056909	PA3973	791440060203	PA4112	791440055725	PA4304	791440080492	PA4388	791440082649
PA3895-FN	791440056923	RS3974	791440060227	PA4113	791440055780	PA4305	791440080508	PA4389	791440082656
PA3896	791440056954	RS3975	791440060234	PA4114	791440055810	PA4306	791440080515	PA4390	791440082670
PA3897	791440057005	PA3978	791440060265	PA4118	791440055916	PA4307	791440080522	PA4391	791440082762
PA3898	791440056961	PA3979	791440060272	PA4120	791440059085	PA4308	791440080539	PA4392	791440082786
PA3899	791440056978	PA3980	791440060357	PA4121	791440059320	PA4309	791440080546	PA4393	791440082793
PA3900	791440057418	PA3983-FN	791440060623	PA4123	791440059559	PA4310	791440080560	PA4394	791440082861
PA3901	791440057432	PA3984	791440060791	PA4124	791440059566	PA4311	791440080577	PA4395	791440082885
PA3901 FOAM	791440067660	PA3985	791440060777	PA4126	791440059849	PA4312	791440080584	PA4397	791440082984
PA3902	791440057548	PA3986	791440060920	PA4127	791440059924	PA4313	791440080591	PA4398	791440082991
PA3903	791440057555	PA3987	791440060937	PA4128	791440060319	PA4314	791440080607	PA4399	791440083004
PA3904	791440057562	RS3988	791440060944	PA4129	791440060326	SA4315	791440080553	PA4400	791440083011
PA3905	791440057579	PA3989-FN	791440061033	RS4130	791440060333	PA4316	791440080652	PA4401	791440083097
PA3906	791440057586	RS3990	791440060968	RS4131	791440060364	PA4317	791440080669	PA4402	791440083103
PA3907	791440057791	RS3991	791440061026	PA4132	791440060449	PA4318	791440080744	PA4403	791440083134
PA3908	791440057661	RS3992	791440060975	PA4133	791440060487	PA4319	791440080751	PA4404	791440083141
PA3909	791440057678	RS3993	791440061279	PA4134	791440060869	PA4320	791440080775	PA4405	791440083158
PA3910-FN	791440057777	RS3994	791440060982	PA4138	791440061125	PA4321	791440080881	PA4409	791440083240
PA3911	791440057784	RS3995	791440061286	SA4141	791440061194	PA4322	791440080898	PA4410 KIT	791440083516
PA3914	791440057838	RS3996	791440060999	PA4144	791440061965	PA4323	791440081048	PA4411	791440083578



WARNING: These products can expose you to chemicals, including Diisononyl Phthalate, Carbon black extracts, Nickel, 1,3 Butadiene, Ethylene Oxide, Epichlorohydrin, which are known to the State of California to cause cancer, and Bisphenol-A, Ethylene Glycol, Ethylene Oxide, 1,3 Butadiene, Epichlorohydrin, which are known to the State of California to cause birth defects or other reproductive harm. For more information go to www.P65Warnings.ca.gov.

BALDWIN TO UPC (INDIVIDUAL PARTS)

BALDWIN NUMBER	UPC NUMBER	BALDWIN NUMBER	UPC NUMBER	BALDWIN NUMBER	UPC NUMBER	BALDWIN NUMBER	UPC NUMBER	BALDWIN NUMBER	UPC NUMBER
PA4412	791440083592	PA4552	791440061248	RS4639	791440065512	PA4734	791440068117	PA4876	791440073401
PA4413	791440083608	PA4553	791440061354	PA4640-FN	791440077300	PA4735	791440068124	PA4877	791440072626
PA4414	791440083615	PA4554	791440061361	PA4641	791440065574	PA4736 FOAM	791440068131	PA4878	791440072633
PA4416 KIT	791440083677	PA4555	791440061378	RS4642	791440065581	PA4737	791440068148	PA4879	791440072640
PA4417	791440083776	PA4556	791440061385	RS4643	791440065598	PA4738	791440068155	PA4881	791440072664
PA4418	791440083868	PA4557	791440061392	PA4644	791440065611	PA4740	791440068179	PA4882	791440072671
PA4419	791440083875	PA4559	791440061880	PA4645-FN	791440065628	PA4741	791440068186	PA4883	791440072688
PA4421	791440084155	PA4560	791440061910	RS4646	791440065635	PA4743	791440068209	PA4885	791440072701
PA4422	791440085895	RS4561	791440061958	PA4647	791440065642	PA4750	791440068278	PA4886	791440072718
PA4423	791440085992	RS4562	791440061989	RS4648	791440065659	PA4753	791440068308	PA4887	791440072725
PA4425	791440086418	RS4563	791440062016	PA4649	791440065666	PA4754	791440068315	PA4888	791440072732
PA4426	791440086425	RS4564	791440062023	PA4650-FN	791440065673	PA4755	791440068322	PA4889	791440072739
PA4427	791440086593	PA4566	791440062153	PA4651	791440065758	PA4756	791440068339	PA4890	791440072756
PA4428	791440086685	PA4567	791440062177	PA4652	791440065895	PA4758	791440068353	PA4891	791440072763
PA4429	791440087025	PA4570	791440062382	PA4653	791440066106	PA4760	791440068377	PA4893	791440072787
PA4430	791440087056	PA4571	791440062394	PA4654 KIT	791440066151	PA4763	791440068407	PA4895	791440072800
PA4431	791440087231	RS4572	791440062597	PA4655	791440066182	PA4764	791440068414	PA4896	791440072817
PA4433	791440087675	PA4573	791440062832	PA4656	791440066267	PA4766	791440068438	PA4897	791440072824
PA4436	791440088160	PA4574	791440062849	PA4657	791440066281	PA4769	791440068469	PA4900	791440072848
PA4437	791440088177	RS4576	791440062870	PA4658	791440066311	PA4772	791440068490	PA4902	791440072862
PA4434	791440087965	RS4577	791440062887	PA4659	791440066328	PA4773	791440068506	PA4903	791440072879
PA4435	791440088108	RS4578	791440062900	PA4660	791440066335	RS4775	791440068520	PA4905	791440072893
PA4438	791440088443	RS4579	791440063129	PA4661	791440066847	PA4777	791440068551	PA4906	791440072909
PA4439	791440089167	RS4580	791440063136	PA4662	791440066854	PA4778	791440068568	PA4907	791440072916
PA4440 KIT	791440089174	PA4581	791440063143	PA4663	791440066861	PA4781	791440068599	PA4908	791440072923
PA4441	791440089181	PA4582	791440063150	PA4664	791440066878	PA4785	791440068636	PA4910	791440072947
PA4442	791440089297	PA4583-FN	791440063181	PA4665-FN	791440066901	PA4790	791440068681	PA4911	791440072954
PA4443	791440089303	PA4585	791440063327	PA4666	791440066618	PA4793	791440068711	PA4912	791440075092
PA4444	791440089310	PA4592	791440063457	PA4668	791440066885	RS4794	791440068728	PA4918	791440073029
RS4445	791440089419	PA4593	791440063471	PA4669	791440066892	PA4795	791440068735	PA4919	791440073036
PA4446	791440089426	PA4594	791440063488	RS4672	791440067042	PA4801	791440068797	PA4925	791440073098
PA4447	791440089433	RS4595	791440063587	RS4673	791440067059	PA4802	791440068803	PA4928	791440073128
PA4448	791440089440	RS4597	791440063792	PA4674-FN	791440067066	RS4803	791440068810	PA4929	791440073135
PA4449	791440089754	RS4598	791440063848	RS4676	791440067264	RS4804	791440068827	PA4930	791440073142
RS4450	791440089815	RS4599	791440063655	RS4677	791440067271	RS4806	791440068841	PA4931	791440073159
PA4451	791440089891	PA4600	791440063709	RS4678	791440067285	RS4807	791440068858	PA4932	791440073166
PA4452	791440089907	PA4601	791440063716	RS4679	791440067298	PA4809	791440068872	PA4934	791440073180
PA4453	791440089914	PA4602	791440063747	RS4680	791440067325	PA4810	791440068889	PA4935	791440073197
PA4454	791440089945	PA4603	791440064898	PA4681	791440067363	PA4813	791440068919	PA4938	791440073227
PA4455	791440089969	PA4604-FN	791440063808	PA4682	791440067424	PA4814	791440068926	PA4939	791440073234
PA4456	791440089983	PA4605	791440063815	PA4683	791440067523	PA4819	791440068971	PA4941	791440073258
PA4458	791440090019	PA4606	791440063822	PA4688	791440067615	PA4820	791440068988	PA4942	791440073265
PA4460 KIT	791440090101	PA4607	791440063846	PA4688 FOAM	791440067622	PA4823	791440069015	PA4945	791440075108
PA4461	791440090125	PA4608	791440063853	PA4689	791440067639	PA4824	791440069022	PA4947	791440075122
PA4462	791440090132	PA4610 KIT	791440063921	PA4692	791440067745	PA4825	791440069039	PA4954	791440075191
PA4463	791440090163	PA4611	791440063891	PA4693	791440067752	PA4827	791440069053	PA4955	791440075207
PA4464	791440090309	PA4612	791440063938	PA4694	791440067769	PA4829	791440069077	PA4956	791440075214
PA4465	791440090422	RS4613	791440064393	PA4695	791440067776	PA4830	791440069084	PA4957	791440075221
PA4466	791440091016	PA4614	791440063952	PA4696 FOAM	791440067783	PA4832	791440069091	RS4959	791440075252
PA4467	791440091252	PA4615	791440064676	PA4697-FN	791440067790	PA4833-FN	791440069107	PA4960-FN	791440075054
PA4468	791440091528	RS4616	791440064041	PA4698	791440067806	PA4834-FN	791440069114	PA4961	791440075078
PA4469	791440091535	RS4617	791440064058	CA4700	791440066571	PA4848	791440069251	RS4962	791440075269
PA4470	791440092297	RS4618	791440064386	PA4701	791440066588	PA4849	791440069268	RS4963	791440075276
PA4471	791440092310	PA4619	791440064690	CA4702	791440066724	PA4852	791440067547	RS4966	791440075283
PA4472	791440092365	RS4620	791440064409	CA4703	791440066731	PA4852 FOAM	791440067554	RS4967	791440075290
PA4473	791440092440	RS4621	791440064416	PA4704	791440066717	PA4853	791440067561	RS4968	791440075306
PA4474	791440092532	RS4622	791440064423	PA4705	791440067820	PA4854	791440067578	RS4969	791440075313
PA4475	791440092853	RS4623	791440065246	PA4706	791440067837	PA4855	791440067592	RS4970	791440075320
PA4476	791440093669	PA4624	791440064652	PA4707	791440067844	PA4857	791440072503	RS4971	791440075337
PA4477	791440093676	PA4625	791440064669	PA4708	791440067851	PA4858	791440072527	RS4972	791440075344
PA4478	791440093683	PA4626	791440064959	PA4709	791440067868	RS4859	791440072541	PA4973	791440076013
PA4479	791440093690	PA4627	791440064966	PA4711	791440067882	PA4860	791440072558	PA4975	791440075993
PA4480	791440093706	PA4628	791440065178	PA4713	791440067905	RS4861	791440073470	PA4977-FN	791440075979
PA4481	791440094390	RS4629	791440065215	PA4714	791440067912	RS4862	791440072565	PA4978	791440075962
PA4483	791440094536	PA4630	791440065550	PA4715	791440067929	RS4863	791440072572	PA4979	791440075955
PA4484	791440094666	PA4631-FN	791440065284	PA4716	791440067936	RS4864	791440073463	PA4983	791440076310
PA4485	791440094703	PA4632	791440065338	PA4720	791440067974	PA4865-FN	791440073333	PA4984-FN	791440076303
PA4486	791440095113	PA4633	791440065345	PA4723	791440068001	PA4866	791440073296	PA4985	791440076372
PA4487	791440095137	RS4634	791440065321	PA4727	791440068049	PA4867	791440073302	PA4986	791440076389
PA4488	791440095144	RS4634XP	791440104266	PA4729	791440068063	PA4870-FN	791440073340	PA4987	791440076396
PA4489	791440095151	PA4635	791440065413	PA4730	791440068070	PA4871	791440073357	RS4988	791440076518
PA4548	791440063341	RS4636	791440065369	PA4731	791440068087	PA4872	791440073364	RS4989	791440076563
RS4549	791440063334	RS4637	791440065376	PA4732	791440068094	PA4873	791440073371	PA4991	791440076594
PA4551	791440061231	RS4638	791440065390	PA4733	791440068100	PA4874	791440073388	RS4992	791440076679



WARNING: These products can expose you to chemicals, including Diisononyl Phthalate, Carbon black extracts, Nickel, 1,3 Butadiene, Ethylene Oxide, Epichlorohydrin, which are known to the State of California to cause cancer, and Bisphenol-A, Ethylene Glycol, Ethylene Oxide, 1,3 Butadiene, Epichlorohydrin, which are known to the State of California to cause birth defects or other reproductive harm. For more information go to www.P65Warnings.ca.gov.

BALDWIN TO UPC (INDIVIDUAL PARTS)

BALDWIN NUMBER	UPC NUMBER	BALDWIN NUMBER	UPC NUMBER	BALDWIN NUMBER	UPC NUMBER	BALDWIN NUMBER	UPC NUMBER	BALDWIN NUMBER	UPC NUMBER
RS4993	791440076785	RS5287XP	791440095212	CA5370	791440079908	RS5455	791440085671	RS5534	791440090361
RS4994	791440076686	RS5288XP	791440096608	BA5371	791440081956	RS5456	791440085688	RS5535	791440090453
RS4995	791440076693	PA5289	791440095236	BA5372	791440085602	PA5457	791440085787	RS5536	791440088757
CA4996	791440094796	PA5290	791440095229	BA5373	791440085619	RS5458	791440085831	RS5537	791440090439
PA4997	791440094802	RS5291	791440095250	BA5374	791440078840	RS5459	791440085930	RS5538	791440087996
CA4999	791440076808	RS5292	791440095267	BA5375	791440078857	RS5460	791440085947	RS5539	791440088009
CFB5000	791440026704	RS5293	791440096516	BA5376	791440078864	RS5461	791440086111	RS5540	791440088016
CS5007	791440026742	RS5293XP	791440103597	BA5377	791440085626	RS5462	791440086128	RS5541	791440088023
CS5008	791440026759	RS5294	791440096523	BA5378	791440085718	PA5463	791440087958	RS5543	791440089730
CS5009	791440026766	PA5297	791440096554	BA5379	791440085725	PA5464	791440086166	RS5544	791440089747
CS5010	791440026773	PA5298	791440096561	RS5387 KIT	791440079977	PA5465	791440086227	PA5545	791440088085
CS5011	791440026780	PA5299	791440096592	PA5388	791440079984	PA5467	791440086258	RS5546	791440088139
CSC5012	791440026797	RS5300	791440076907	RS5389-FN	791440080110	PA5468	791440092129	RS5547	791440088771
CSC5013	791440026803	RS5301	791440076990	RS5390	791440080034	PA5469	791440086296	RS5548	791440088788
CTK5028	791440026865	PA5302	791440077058	RS5391	791440080079	RS5470	791440086340	RS5549	791440088795
CTK5029	791440043237	PA5303	791440077072	RS5392	791440080181	RS5471	791440086357	RS5550	791440088764
CTK5029-M	791440079144	RS5304	791440077102	PA5393	791440080225	RS5472	791440086364	PA5551	791440088337
CTK5029-1	791440059528	RS5305	791440077126	RS5395-FN	791440080928	PA5473	791440086302	PA5552	791440088344
CTK5029-4	791440050211	PA5306	791440077133	PA5396	791440080935	PA5474	791440091603	PA5553	791440088351
CS5055	791440026872	PA5310	791440077256	RS5397	791440080942	PA5475	791440086319	PA5554	791440088368
CS5057	791440026889	PA5311	791440077331	RS5398	791440080959	PA5476	791440086326	PA5555	791440088375
CS5058	791440026896	PA5312 KIT	791440077348	PA5399	791440080966	PA5477	791440086333	PA5556	791440088382
OTK5060	791440026902	RS5313	791440077355	PA5400	791440080973	RS5478-FN	791440086630	PA5557	791440088399
OTK5061	791440026919	PA5314	791440077362	PA5401	791440080980	RS5479	791440086647	RS5558	791440088450
OTK5062	791440026926	PA5315	791440077454	PA5403	791440081000	PA5480	791440086494	RS5559	791440088641
OTK5063	791440026933	PA5316	791440077461	PA5404	791440081017	PA5481	791440091870	PA5560	791440088559
BW5070	791440026940	PA5317	791440077478	PA5405	791440081024	PA5482	791440086449	PA5561	791440088566
BW5071	791440026957	PA5318	791440077492	PA5406-FN	791440081103	RS5483	791440086500	PA5562	791440088573
BW5072	791440026964	PA5319	791440077508	PA5407	791440081079	RS5484	791440086517	PA5563	791440088597
BW5073	791440026971	PA5320	791440077515	RS5408	791440081123	PA5485-FN	791440086531	PA5564	791440088603
BW5074	791440026988	PA5321	791440077522	RS5409	791440081166	PA5486	791440086579	PA5565	791440088610
BW5075	791440026995	PA5323	791440077669	PA5410-FN	791440081130	PA5487	791440086548	BA5566	791440088665
BW5076	791440027008	PA5324-FN	791440077706	RS5411	791440081147	RS5488	791440086582	PA5567	791440088948
BW5082	791440043107	RS5325	791440077713	PA5412	791440081167	RS5489	791440094646	PA5568	791440088955
BW5086	791440057593	PA5326	791440077720	RS5413	791440081178	RS5490	791440094659	PA5569	791440088962
B5087	791440058262	PA5327	791440077867	RS5414	791440081239	PA5491	791440086753	PA5570	791440088979
B5088	791440058279	PA5328	791440077874	RS5415	791440081246	PA5492	791440086760	PA5571	791440089129
B5089	791440063440	RS5329	791440077881	CA5416	791440081420	PA5493	791440086777	PA5572	791440088986
B5090	791440065673	PA5330	791440078178	CA5417	791440081437	PA5494	791440086791	PA5573	791440089013
B5091	791440082830	PA5331	791440078192	PA5418	791440081444	PA5495	791440086807	PA5574	791440089020
P5092	791440091542	RS5332	791440078376	CA5419	791440081468	PA5496	791440086838	PA5575	791440089037
B5134	791440027046	PA5333	791440078444	CA5420	791440081475	PA5497	791440086845	PA5576	791440089044
BW5136	791440027053	RS5334	791440078741	CA5421	791440081451	PA5498	791440086890	PA5577	791440089068
BW5137	791440027060	RS5335	791440078745	RS5422	791440081895	PA5499	791440086906	PA5578	791440089075
BW5138	791440027077	PA5336	791440078543	PA5423-FN	791440081963	CA5500	791440086913	PA5579	791440089082
BW5139	791440027084	PA5337	791440078635	RS5424	791440082151	PA5503	791440086975	PA5580	791440089161
BW5140	791440027091	PA5338-FN	791440078642	PA5425	791440082663	PA5504	791440086982	PA5581	791440089778
BW5141	791440027107	PA5339	791440078871	PA5426	791440082687	PA5505	791440087071	PA5582	791440089785
BW5142	791440052581	PA5340	791440078895	PA5428	791440082878	RS5506	791440087460	PA5583	791440089792
BW5143	791440057029	PA5341	791440078918	RS5429	791440082939	RS5507	791440087132	PA5584	791440089808
B5144	791440064065	RS5342	791440078970	RS5430	791440082946	RS5508	791440087156	PA5585	791440089921
B5145	791440066922	RS5343	791440078987	RS5431	791440082960	RS5509	791440087194	PA5586	791440089938
B5176	791440027121	RS5344	791440081291	RS5432	791440083035	RS5510	791440087200	BF5587-D	791440076488
B5177	791440027138	RS5345	791440081307	RS5433	791440083059	PA5511	791440087248	PA5588	791440089822
BW5178	791440027145	RS5347	791440081321	RS5434	791440083493	PA5512	791440087255	PA5589	791440089839
BW5179	791440027152	RS5348	791440081338	RS5435	791440085633	CA5514	791440087293	RS5591XP	791440098336
BW5182	791440066298	PA5350	791440079045	PA5436	791440083639	PA5515	791440087309	BA5592	791440090002
BW5183	791440079021	RS5351	791440079120	PA5437	791440084100	PA5516	791440087347	RS5593	791440090026
BW5200	791440053281	CA5352	791440079137	RS5438	791440083370	RS5517	791440087491	RS5593XP	791440098343
BW5201	791440057401	PA5353	791440079403	RS5440	791440083646	PA5518	791440087774	PA5594	791440090033
BW5250	791440060050	RS5354	791440079236	RS5441	791440083653	PA5519	791440087781	PA5596	791440090040
PE5270	791440091894	RS5355	791440079243	RS5442	791440083844	PA5521	791440087903	PA5597	791440090057
PE5271	791440091900	RS5356	791440079427	RS5443	791440083851	PA5522	791440087798	PA5598	791440090064
PE5272	791440094925	PA5357	791440079434	PA5444-FN	791440083770	PA5523	791440087804	PA5599	791440090071
RS5273	791440094949	RS5358	791440079465	PA5445	791440083714	PA5524	791440087873	PA5618	791440090194
PA5274	791440094970	PA5359	791440079526	PA5446	791440083721	PA5525	791440087880	PA5619	791440090200
PA5275	791440094987	RS5360	791440079557	RS5447	791440083738	PA5526	791440087811	PA5620	791440090217
PA5276	791440094994	RS5361	791440079564	RS5448	791440083745	PA5527	791440087828	PA5621	791440090224
CA5278	791440095045	PA5363	791440079601	RS5449	791440085909	PA5528	791440087835	PA5622	791440090231
PA5281	791440095076	PA5364	791440079796	CA5450	791440094722	PA5529	791440087842	PA5623	791440090248
PA5282	791440095083	PA5365	791440079793	PA5451	791440085940	PA5530	791440087859	PA5624	791440090255
PA5283	791440095090	CA5366	791440079861	RS5452	791440085732	PA5531	791440087866	PA5625	791440090279
BA5284	791440095106	CA5368	791440079885	RS5453	791440085756	PA5532	791440087934	PA5626	791440090293
RS5285	791440095168	CA5369	791440079892	PA5454	791440085664	PA5533	791440087941	RS5627	791440090316



WARNING: These products can expose you to chemicals, including Diisononyl Phthalate, Carbon black extracts, Nickel, 1,3 Butadiene, Ethylene Oxide, Epichlorohydrin, which are known to the State of California to cause cancer, and Bisphenol-A, Ethylene Glycol, Ethylene Oxide, 1,3 Butadiene, Epichlorohydrin, which are known to the State of California to cause birth defects or other reproductive harm. For more information go to www.P65Warnings.ca.gov.

BALDWIN TO UPC (INDIVIDUAL PARTS)

BALDWIN NUMBER	UPC NUMBER	BALDWIN NUMBER	UPC NUMBER	BALDWIN NUMBER	UPC NUMBER	BALDWIN NUMBER	UPC NUMBER	BALDWIN NUMBER	UPC NUMBER
RS5628	791440090323	RS5708	791440092624	RS5783	791440094680	BK6077	791440092471	BK6666	791440077904
PA5629	791440090330	PA5710	791440092693	RS5784	791440094741	BK6078	791440092488	BK6670	791440067103
PA5630	791440090347	PA5711	791440092709	PA5785	791440094710	BK6079	791440092495	BK6675	791440065956
PA5631	791440090354	PA5712	791440092716	PA5786	791440094727	BK6080	791440092501	BK6676	791440065963
PA5632	791440090392	PA5713	791440092723	PA5787	791440094734	BK6081	791440093782	BK6683	791440063884
PA5633	791440090477	PA5714	791440092730	CA5788	791440094789	BK6082	791440109506	BK6685	791440063990
PA5634	791440090484	PA5715	791440092754	CA5789	791440094819	BK6083	791440109315	BK6686	791440063020
PA5635	791440090491	PA5716	791440092761	CA5790	791440094826	BK6085	791440109513	BK6691	791440067196
PA5636	791440090514	PA5717	791440092778	CA5791	791440094833	BK6086	791440104280	BK6693	791440066045
PA5637	791440090699	PA5718 KIT	791440092785	PA5792	791440094840	BK6087	791440104297	BK6694	791440062566
PA5638	791440090705	PA5719	791440092792	CA5793	791440094857	BK6088	791440109322	BK6696	791440061057
RS5641	791440091009	PA5720	791440092815	PA5796	791440094895	BK6089	791440108646	BK6700	791440028241
PA5642	791440091085	PA5721	791440092822	PA5797	791440094901	BK6090	791440108127	BK6702	791440045972
PA5643	791440091092	PA5722	791440092839	PA5798	791440094918	BK6092	791440108677	BK6704	791440056138
PA5644	791440091108	PA5723	791440092846	PA5799	791440094932	BK6093	791440108943	BK6705	791440056145
PA5645	791440091115	PA5724	791440092860	BF5800	791440027190	BK6094	791440109124	BK6710	791440028265
PA5646	791440091122	PA5724 FOAM	791440092877	BF5801	791440027183	BK6112	791440109858	BK6720	791440028296
PA5647	791440091139	PA5725	791440092884	BF5810	791440027206	BK6117	791440110533	BK6721	791440028302
PA5648	791440091146	PA5726	791440092907	BF5812	791440027213	BK6118	791440110649	BK6722	791440028319
PA5649	791440091245	PA5727	791440092914	BF5813	791440027220	BK6138	791440105447	BK6723	791440028326
PA5650	791440091276	PA5728	791440092921	BF5813-O	791440097599	BK6140	791440106789	BK6764	791440042254
PA5651	791440091283	PA5728 FOAM	791440092938	BF5815	791440060336	BK6161	791440086661	BK6780	791440028333
PA5652	791440091290	PA5729	791440092952	BF5816	791440066977	BK6167	791440087699	BK6799	791440046955
PA5653	791440091306	RS5730	791440092969	6020	791440027305	BK6181	791440079335	BK6903	791440064225
PA5654	791440091320	RS5731	791440092976	6021	791440027312	BK6183	791440072510	BK6923	791440078369
PA5655	791440091337	PA5732	791440092983	BK6022	791440084049	BK6184	791440067455	BK6930	791440080157
PA5656	791440091399	PA5733	791440093157	BK6023	791440084056	BK6185	791440076952	BK6931	791440080164
PA5657	791440091405	PA5734	791440093195	BK6024	791440084063	BK6186	791440077164	BK6933	791440080201
PA5658	791440091412	PA5735	791440093218	BK6025	791440084070	BK6187	791440078208	BK6934	791440066502
PA5659	791440091429	PA5736	791440093225	BK6026	791440084087	BK6189	791440065918	BK6942	791440083295
PA5660	791440091436	PA5737 KIT	791440093270	BK6027	791440084124	BK6195	791440056633	BK6943	791440083387
PA5661	791440091443	PA5738	791440093294	BK6028	791440085640	BK6196	791440056640	BK6944	791440083394
PA5662	791440091450	PA5739	791440093300	BK6029	791440085749	BK6215	791440062038	BK6945	791440083400
PA5663	791440091467	PA5740	791440093317	BK6030	791440085923	BK6287	791440052338	BK6946	791440083417
PA5664	791440091474	RS5741	791440093324	BK6031	791440085961	BK6299	791440079205	BK6947	791440083424
PA5665	791440091481	RS5742	791440093331	BK6032	791440085978	BK6341	791440062979	BK6948	791440083431
PA5666	791440091498	RS5743	791440093348	BK6033	791440086524	BK6375	791440046450	BK6949	791440083448
PA5667	791440091504	RS5743XP	791440093355	BK6034	791440088061	BK6376	791440046452	BK6950	791440083455
PA5668	791440091511	RS5744	791440093362	BK6035	791440088078	BK6380	791440027725	BK6951	791440083462
PA5669	791440091566	RS5745	791440093379	BK6041	791440086012	BK6426	791440077843	BK6952	791440084025
RS5670	791440091573	RS5746	791440093655	BK6043	791440086029	BK6429	791440079410	BK6953	791440083806
RS5672	791440091610	RS5747	791440093386	BK6044	791440088412	BK6438	791440086654	BK6954	791440083813
RS5673	791440091627	RS5748	791440093393	BK6045	791440088636	BK6440	791440066120	BK6955	791440083820
PA5674	791440091634	RS5749	791440093409	BK6046	791440088604	BK6444	791440077928	BK6956	791440085800
RS5675	791440091641	RS5750	791440093416	BK6047	791440088405	BK6451	791440077935	BK6980	791440081529
RS5676	791440091658	PA5751	791440093430	BK6048	791440088650	BK6452	791440077942	BK6981	791440081536
PA5678	791440091719	PA5752	791440093454	BK6049	791440088457	BK6457	791440087224	BK6982	791440081543
PA5679	791440091740	PA5753	791440093522	BK6050	791440088464	BK6463	791440078147	BK6983	791440081734
PA5680	791440091771	RS5754	791440093539	BK6051	791440089488	BK6464	791440078598	BK6984	791440081550
PA5681	791440091795	PA5755	791440093546	BK6052	791440089471	BK6467	791440064355	BK6985	791440083783
PA5682	791440091832	RS5756	791440093553	BK6053	791440089495	BK6561	791440028081	BK6986	791440083790
PA5683	791440091924	PA5757	791440093591	BK6054	791440089501	BK6562	791440028098	BK6987	791440083998
RS5684	791440092136	RS5758	791440093607	BK6055	791440089976	BK6579	791440046252	BK6988	791440086173
RS5685	791440092143	RS5759	791440093614	BK6056	791440090095	BK6583	791440047211	BK6993	791440080324
PA5686	791440092150	RS5761	791440093638	BK6057	791440108844	BK6595	791440054752	BK6996	791440087095
PA5687	791440092167	PA5762	791440093645	BK6058	791440090651	BK6600	791440028128	BK6997	791440084117
PA5688	791440092174	PA5763	791440093713	BK6059	791440090675	BK6601	791440028135	P7000 KIT	791440038134
PA5689	791440092181	PA5764	791440093720	BK6060	791440091269	BK6610	791440028203	B7001	791440048195
PA5690	791440092198	PA5765	791440093751	BK6061	791440091344	BK6613	791440077119	P7003	791440028487
PA5691	791440092204	PA5766	791440093805	BK6062	791440091351	BK6619	791440045538	B7004	791440028494
RS5692	791440092211	RS5767	791440093812	BK6063	791440091368	BK6634	791440053236	B7005	791440028500
RS5693	791440092228	PA5768	791440093836	BK6064	791440091597	BK6649	791440079779	P7007	791440038813
PA5694	791440092235	PA5770	791440094451	BK6065	791440091726	BK6650	791440085657	B7009	791440028531
PA5695	791440092242	PA5771	791440094468	BK6066	791440091733	BK6652	791440082175	B7010	791440028548
PA5696	791440092259	PA5772	791440094475	BK6067	791440091955	BK6653	791440083110	B7011	791440028555
PA5697	791440092266	PA5773	791440094482	BK6068	791440109445	BK6654	791440077966	P7012	791440038820
PA5698	791440092327	PA5774	791440094505	BK6069	791440109490	BK6656	791440082953	P7013	791440042568
PA5699	791440092334	RS5776	791440094550	BK6070	791440089060	BK6657	791440083127	B7014	791440028562
PA5700	791440092426	PA5777	791440094574	BK6071	791440092044	BK6658	791440076495	P7015	791440046627
PA5701	791440092556	PA5778	791440094581	BK6072	791440093119	BK6659	791440076501	P7016	791440046726
PA5702	791440092563	PA5779	791440094598	BK6073	791440093126	BK6661	791440076365	P7017	791440046733
PA5704	791440092594	PA5780	791440094628	BK6074	791440093133	BK6662	791440076099	B7018	791440028579
PA5705	791440092600	PA5781	791440094635	BK6075	791440093140	BK6663	791440076037	B7019	791440028586
RS5707	791440092617	RS5782	791440094673	BK6076	791440092464	BK6665	791440072596	B7020	791440028593



WARNING: These products can expose you to chemicals, including Diisononyl Phthalate, Carbon black extracts, Nickel, 1,3 Butadiene, Ethylene Oxide, Epichlorohydrin, which are known to the State of California to cause cancer, and Bisphenol-A, Ethylene Glycol, Ethylene Oxide, 1,3 Butadiene, Epichlorohydrin, which are known to the State of California to cause birth defects or other reproductive harm. For more information go to www.P65Warnings.ca.gov.

BALDWIN TO UPC (INDIVIDUAL PARTS)

BALDWIN NUMBER	UPC NUMBER	BALDWIN NUMBER	UPC NUMBER	BALDWIN NUMBER	UPC NUMBER	BALDWIN NUMBER	UPC NUMBER	BALDWIN NUMBER	UPC NUMBER
P7021	791440046474	B7155	791440056930	P7255	791440071735	B7359	791440085916	P7442	791440083028
B7022	791440028609	B7156	791440057494	P7256	791440071742	B7360	791440086135	B7443	791440083202
B7023	791440028616	B7157	791440057760	P7259	791440071773	B7361	791440086180	B7444	791440083219
B7024	791440028623	BD7158	791440057852	P7260	791440071803	B7362	791440086234	B7445	791440083233
B7025	791440028630	BD7159	791440057951	P7261	791440071797	B7363	791440086371	B7446	791440083264
B7026-MPG	791440048706	BD7160	791440057968	P7262	791440071803	P7364	791440086388	B7449	791440083950
BD7028	791440037618	B7161	791440058125	P7263	791440071810	P7365	791440086456	P7450	791440083301
BD7029	791440051225	B7162	791440058002	P7264	791440071827	B7367	791440086555	B7451	791440083318
B7030	791440040243	B7163	791440058019	P7265	791440071834	P7368	791440086623	B7452	791440083363
B7031	791440038851	B7164	791440058026	P7267	791440071858	B7369	791440086689	B7453	791440083486
B7033	791440054233	B7165	791440058057	P7268	791440071865	B7370	791440086920	BC7456 KIT	791440083837
B7034	791440054240	BD7166	791440058149	P7269	791440071872	P7371	791440086937	P7454	791440083585
P7035	791440038110	B7167	791440058446	B7271	791440071896	B7372	791440087187	P7455	791440083660
B7039	791440037854	BD7168	791440058644	B7273	791440071919	B7373	791440087316	B7457	791440088306
B7042	791440038875	BD7169	791440058668	B7274	791440071926	B7375	791440087385	B7458	791440088313
B7044	791440038387	B7170	791440058750	B7275	791440071933	B7376	791440087392	B7459	791440088320
B7045	791440043671	B7171	791440058767	B7276	791440071940	B7377	791440087408	B7460	791440088481
B7047	791440038066	B7172	791440059641	B7277	791440071957	B7378	791440087422	B7461	791440088498
B7049	791440044999	BC7173	791440059412	B7280	791440071988	B7379	791440087484	B7462	791440088528
P7050	791440043718	B7174-MPG	791440061262	B7281	791440071995	P7380	791440087729	B7464	791440088535
B7051	791440037625	B7175	791440058408	B7283	791440072015	P7381	791440087767	B7465	791440088542
P7052	791440045719	BD7176	791440060142	B7285	791440072039	B7383	791440087538	B7466	791440088689
P7053	791440037588	B7177	791440060210	B7286	791440072046	B7384	791440087545	B7467	791440088702
P7055	791440037731	P7178	791440060289	B7287	791440072053	B7385	791440087552	B7468	791440088719
P7058	791440038226	B7179	791440060296	B7289	791440072077	B7386	791440087569	B7469	791440088726
P7059	791440038233	B7180	791440058552	B7290	791440072084	B7387	791440087576	B7470	791440088740
P7081	791440043145	B7181	791440060739	B7291	791440072091	B7388	791440088146	B7472	791440088818
B7082	791440043282	B7182	791440060845	B7292	791440072107	B7389	791440088207	B7473	791440088825
P7083	791440043329	P7183	791440061064	B7293	791440072114	B7390	791440088238	B7474	791440088832
P7084	791440043350	P7185	791440061477	B7294	791440072121	B7392	791440088245	B7475	791440088849
B7089	791440045019	BC7186 KIT	791440061613	B7295	791440072138	B7393	791440088252	B7476	791440088856
B7091	791440045217	B7187	791440061736	B7298	791440074705	BC7394	791440092419	B7477	791440088863
P7092	791440045552	P7188	791440061941	B7299	791440066755	B7395	791440092549	B7478	791440088870
P7093	791440045569	B7189	791440060852	P7302	791440074736	B7396	791440077393	B7481	791440088917
BD7095	791440046061	P7190	791440061972	P7303	791440074743	B7397	791440079946	B7482	791440088924
B7097	791440046610	B7191	791440062047	P7305	791440075030	P7398	791440080348	B7483	791440088931
B7099	791440047020	P7192	791440062078	B7306	791440076297	P7399	791440080355	P7484	791440088993
P7102	791440047082	P7193	791440062092	P7308	791440076464	P7400	791440080362	BC7485	791440090511
P7103	791440047556	BC7194	791440062146	BD7309	791440058941	B7401	791440080379	B7486	791440089143
P7104	791440047587	P7195	791440062214	BD7310	791440060685	B7402	791440080614	B7487	791440089150
BD7105	791440047594	P7196	791440062399	B7311-MPG	791440076532	B7403	791440080621	P7488	791440089204
P7106	791440047600	B7197	791440064034	P7312	791440076549	P7405	791440080737	P7489	791440089211
P7107	791440047617	P7199	791440062603	P7313	791440076570	P7406	791440080811	B7491	791440089341
B7113	791440047846	B7215	791440062993	B7314	791440076747	B7407	791440081055	P7492	791440089860
P7114	791440048263	B7216	791440063105	BT7316	791440076914	P7408	791440081185	P7493	791440089952
B7116	791440048720	B7217	791440063112	BD7317	791440076969	B7409	791440081192	P7494	791440090088
B7117	791440048829	B7219	791440063761	B7318	791440077041	B7410	791440081208	P7495	791440090415
B7119	791440050297	B7220	791440063877	P7319	791440077089	P7411	791440081222	B7496	791440090538
BD7120	791440051102	B7221	791440063907	B7320	791440077171	P7413	791440081277	B7497	791440090965
B7121	791440050525	B7121	791440063914	P7321	791440077263	P7414	791440081284	B7499	791440091689
B7124	791440051300	B7223	791440064164	B7322	791440077324	P7415	791440081369	F7500	7914400928715
B7125	791440051393	B7224	791440064430	B7324	791440077676	B7416	791440081413	P7500	7914400928722
P7126	791440051324	B7225	791440064478	BD7325	791440077744	P7417	791440081987	B7501	791440091887
P7127	791440051478	B7227	791440064621	BC7326	791440078529	P7418	791440081611	P7502	791440091993
B7128	791440052086	BC7228	791440064645	B7327	791440078567	B7419	791440081789	B7503	791440092112
V7129-C	791440052529	B7229	791440064683	B7328	791440078659	B7420	791440081918	BD7504	791440092273
B7130	791440052604	P7230	791440064850	P7329	791440078963	B7422	791440081925	P7505	791440088290
B7131	791440052611	B7231	791440064881	P7330	791440079069	P7423	791440081949	B7506	791440092280
P7132	791440053120	P7232	791440064942	PT7332	791440079113	B7424	791440082090	B7507	791440092402
P7134	791440054325	P7233	791440065017	B7333	791440079830	P7426	791440082106	P7508	791440092587
B7135	791440054363	P7235	791440065086	B7334	791440080058	P7427	791440082113	BD7509	791440092686
P7136	791440054608	BT7237	791440087064	B7335-MPG	791440080041	B7428	791440082168	P7510	791440093232
P7137	791440054615	B7238	791440065383	P7336 KIT	791440080102	B7429	791440082281	B7511	791440093263
P7138	791440054622	B7239	791440065475	P7337	791440080263	B7430	791440082274	P7512	791440093737
B7139	791440054677	B7240	791440065499	P7338	791440080287	B7431	791440082304	B7513	791440093744
BD7141	791440055094	B7241	791440065680	BT7349	791440076266	B7432	791440082311	P7514	791440093768
B7142	791440055124	BC7242	791440066229	B7350	791440080418	B7433	791440082328	P7515	791440093829
B7143	791440055810	B7243	791440066366	B7351-MPG	791440085510	B7434	791440082441	P7517	791440094437
B7144	791440055957	B7245	791440066779	B7352	791440085596	B7435	791440082625	BF7519	791440028760
P7145	791440056619	B7246	791440067035	BD7353	791440085770	P7436	791440082717	BF7522	791440048911
B7151	791440056848	P7247	791440067165	P7354	791440085770	P7437	791440082724	BF7528	791440028821
B7152	791440056855	B7249-MPG	791440067219	BD7355	791440085794	P7438	791440083769	BF7529	791440028838
BD7153	791440056886	BD7250	791440067387	B7356	791440085848	B7440	791440082816	BF7531	791440038882
BD7154	791440056893	BD7252	791440067394	B7357	791440085886	B7441	791440082854	BF7532	791440046559



WARNING: These products can expose you to chemicals, including Diisononyl Phthalate, Carbon black extracts, Nickel, 1,3 Butadiene, Ethylene Oxide, Epichlorohydrin, which are known to the State of California to cause cancer, and Bisphenol-A, Ethylene Glycol, Ethylene Oxide, 1,3 Butadiene, Epichlorohydrin, which are known to the State of California to cause birth defects or other reproductive harm. For more information go to www.P65Warnings.ca.gov.

BALDWIN TO UPC (INDIVIDUAL PARTS)

BALDWIN NUMBER	UPC NUMBER	BALDWIN NUMBER	UPC NUMBER	BALDWIN NUMBER	UPC NUMBER	BALDWIN NUMBER	UPC NUMBER	BALDWIN NUMBER	UPC NUMBER
BF7534	791440041530	BF7645	791440052628	BF7765	791440064485	BF7857	791440074590	BF7941	791440080874
BF7535	791440045248	BF7648	791440053069	BF7766	791440065154	BF7859	791440074613	BF7942	791440080904
BF7537	791440054264	BF7653	791440056268	PF7767	791440065543	BF7860	791440074620	BF7943	791440081154
BF7538	791440028852	PF7655	791440057487	BF7768	791440065871	BF7861	791440074637	BF7944	791440081260
BF7541	791440037984	BF7656	791440054462	BF7769	791440066144	BF7863	791440074644	BF7945	791440081406
BF7544	791440037960	BF7657	791440055032	PF7770	791440066168	BF7864	791440074651	PF7946	791440081499
PF7545	791440043664	BF7658	791440054905	BF7771	791440066274	BF7865	791440074668	PF7947	791440081598
BF7546	791440037885	BF7659	791440054912	BF7772	791440066595	BF7866	791440074675	BF7948	791440081635
PF7549	791440037632	BF7661	791440054936	BF7773	791440066694	BF7868	791440074477	BF7949-D	791440081659
PF7550	791440037687	BF7663	791440054974	BF7774	791440066700	PF7869	791440074484	BF7949-DM	791440083332
PF7551	791440037694	BF7664	791440054981	BF7775	791440066953	BF7870	791440074491	BF7950-D	791440081666
BF7552	791440037748	BF7666	791440055056	BF7776	791440066960	BF7871	791440074507	BF7951-D	791440081741
PF7553	791440038240	BF7667	791440055117	PF7777	791440067004	PF7872	791440074514	BF7952-D	791440081758
PF7554	791440038257	BF7668	791440057500	BF7778	791440067011	PF7873	791440074521	BF7954-D	791440081772
PF7556	791440038325	BF7669	791440055858	PF7779	791440067080	PF7874	791440074538	BF7956-D	791440081932
PF7557	791440028869	BF7670	791440055940	BF7780	791440067141	PF7875	791440074545	BF7955	791440081901
BF7558	791440028883	BF7671	791440056121	PF7782	791440067486	PF7876	791440074552	BF7957	791440082182
BF7559	791440038349	BF7672-D	791440066403	BF7783-D	791440067493	PF7877	791440074569	BF7958	791440082403
BF7571	791440041295	BF7673-D	791440066434	BF7784-D	791440067509	PF7878	791440075047	BF7959	791440082410
PF7572	791440042537	BF7674-D	791440066441	BF7785-D	791440067516	BF7879	791440075665	BF7960	791440082427
BF7576	791440042766	BF7675-D	791440066427	BF7786-D	791440067530	BF7880	791440071889	BF7961	791440082434
BF7577	791440028906	BF7677-D	791440066458	PF7787	791440069299	PF7881	791440071929	BF7962	791440082588
BF7579	791440042773	PF7678	791440054578	PF7788	791440069305	PF7882	791440075917	BF7963	791440082595
BF7580	791440042780	BF7679-D	791440066397	BF7798-SP	791440076723	BF7883	791440076280	BF7964-D	791440082601
PF7583	791440043121	PF7680	791440057036	PF7799	791440064768	BF7886	791440076433	BF7965	791440082755
BF7584	791440043138	BF7681-D	791440066380	BF7800	791440064775	BF7888	791440076860	BF7966	791440082823
BF7585	791440043275	BF7682-D	791440066410	BF7801	791440064782	PF7889	791440076600	BF7967	791440082915
BF7586	791440043305	BF7683	791440059658	BF7802	791440064799	PF7889-10	791440076617	BF7968	791440083257
BF7587	791440043312	B7685	791440058392	BF7803	791440064973	PF7889-30	791440076624	BF7968-O	791440097629
PF7588	791440043336	BF7686	791440058507	BF7804	791440064980	PF7890	791440076631	BF7969	791440083684
PT490	791440089334	PF7687	791440058521	BF7805	791440064997	PF7890-10	791440076648	BF7970	791440085862
BF7591-D	791440045521	BF7690	791440058576	BF7806	791440065000	PF7890-30	791440076655	BF7971-D	791440083349
PF7592	791440045583	BF7691	791440058866	BF7807	791440065024	BF7892	791440076884	BF7971-DM	791440083356
BF7593	791440046122	BF7693	791440058897	BF7808	791440065031	PF7894	791440077027	BF7972	791440083752
PF7594	791440046283	BF7695	791440059283	BF7809	791440065079	PF7895	791440077034	PF7973	791440083981
PF7595	791440046290	BF7696	791440059665	PF7812 KIT	791440065130	PF7896	791440077096	PF7974	791440085503
PF7596	791440046412	BF7697	791440059917	BF7813	791440065314	BF7898-D	791440077157	PF7975	791440085589
PF7597	791440046535	PF7698	791440059900	BF7814	791440065352	PF7899	791440077270	BF7976	791440085695
BF7598	791440047570	BF7699-D	791440066489	BF7815	791440067233	PF7900	791440077287	PF7977	791440077690
B7600	791440028937	B7700	791440066830	PF7816	791440069312	BF7903	791440077379	PF7978	791440085763
B7600-SS	791440050433	BF7711	791440060715	PF7817	791440069329	BF7904-D	791440077386	BF7979	791440085879
BF7602	791440047662	BF7713	791440060470	PF7818	791440069336	BF7905-D	791440077416	PF7980	791440085954
BF7606	791440047822	PF7715	791440060494	PF7819	791440069343	BF7906-D	791440077423	BF7981	791440086005
PT607	791440051676	PF7716	791440060500	PF7820	791440069350	BF7907	791440077430	PF7982	791440086210
BF7608	791440048942	BF7717	791440060517	BF7821	791440069367	BF7908	791440077553	PF7983	791440086074
BF7609	791440050204	PF7718	791440060647	PF7822	791440069374	BF7909	791440077560	PF7984	791440086081
BF7612	791440050457	BF7719	791440061088	PF7823	791440069381	PF7910	791440077584	BF7985	791440086104
BF7613	791440050464	BF7720	791440061101	PF7824	791440069398	BF7911	791440077980	PF7986	791440086203
BF7614	791440050501	BF7721	791440061132	PF7825	791440069404	BF7912	791440078130	BF7987	791440086241
PT615	791440050518	BF7722	791440061163	BF7826	791440069411	PF7913	791440078154	BF7988	791440086265
PT7616	791440050600	BF7726	791440061408	PF7828	791440069428	PF7914	791440078406	BF7989-D	791440086289
PT7617	791440050617	PF7733	791440061859	PF7829	791440069435	BF7915	791440078413	BF7990	791440086432
PF7618	791440050907	PF7734	791440061866	PF7830	791440069442	PF7916	791440078536	BF7993	791440086487
BF7619	791440050969	PF7735	791440061927	PF7832	791440069466	BF7917	791440078550	PF7994	791440086609
BF7623	791440051492	BF7736	791440062276	PF7833	791440069473	BF7919	791440078819	BF7995	791440086616
BF7624	791440051669	BF7736-K1	791440069664	PF7834	791440069480	BF7921	791440078901	BF7996	791440086678
BF7625	791440051775	BF7742	791440062658	PF7836	791440069503	BF7922	791440079007	BF7997	791440086784
BF7626	791440052031	PF7744	791440062801	BF7837	791440069510	BF7923	791440079052	BF7998	791440086821
PF7627	791440052048	BF7745-D	791440066472	BF7838	791440069527	BF7924	791440079250	BT8301	791440029071
BF7628	791440052222	BF7746-D	791440066465	BF7839	791440069534	BF7925	791440079397	BT8302	791440038899
BF7629	791440052277	BF7747	7914400663204	BF7840	791440069541	FD7926	791440079380	BT8304	791440029095
BF7630	791440052291	PF7748	791440063211	BF7841	791440069558	BF7927	791440079151	PT8305	791440029101
BF7631	791440052321	PF7749	791440063228	BF7842	791440069565	PF7928	791440079533	PT8306-10	791440029118
BF7632	791440052352	BF7750	791440063273	BF7843	791440069572	BF7929 KIT	791440079540	PT8306-25	791440029125
BF7633	791440053113	PF7751	791440062955	BF7844	791440069589	PF7930	791440079687	BT8307-MPG	791440030466
BF7634	791440053298	BF7753	791440063679	BF7845	791440069596	BF7931	791440079847	BT8308-MPG	791440030473
BF7635	791440053373	PF7755	791440065420	BF7847	791440069619	BF7932	791440079854	BT8308-MPG KIT	791440051096
BF7637	791440074699	BF7756	791440063730	BF7848	791440069626	PF7934 KIT	791440080133	BT8309-MPG	791440030480
BF7637	791440086159	PF7758	791440063839	BF7849	791440069633	PF7935	791440080218	BT8310-MPG	791440030497
BF7639	791440054431	BF7759	791440064027	BF7850	791440069640	PF7936	791440080331	BT8312	791440029132
BF7639-D	791440054837	BF7760	791440063969	BF7851	791440069657	BF7937	791440080393	BT8314	791440029149
BF7640	791440056251	PF7761	791440064843	PF7852 KIT	791440072497	PF7938	791440080638	BT8316-MPG	791440038905
BF7641	791440052437	BF7762	791440064157	BF7853	791440072534	PF7939	791440080850	PT8318-MPG	791440029156
BF7644	791440052741	BF7763	791440064287	BF7855	791440074576	BF7940	791440080867	PT8319	791440043152



WARNING: These products can expose you to chemicals, including Diisononyl Phthalate, Carbon black extracts, Nickel, 1,3 Butadiene, Ethylene Oxide, Epichlorohydrin, which are known to the State of California to cause cancer, and Bisphenol-A, Ethylene Glycol, Ethylene Oxide, 1,3 Butadiene, Epichlorohydrin, which are known to the State of California to cause birth defects or other reproductive harm. For more information go to www.P65Warnings.ca.gov.

BALDWIN TO UPC (INDIVIDUAL PARTS)

BALDWIN NUMBER	UPC NUMBER	BALDWIN NUMBER	UPC NUMBER	BALDWIN NUMBER	UPC NUMBER	BALDWIN NUMBER	UPC NUMBER	BALDWIN NUMBER	UPC NUMBER
BT8320	791440029163	BT8424-MPG	791440058460	BT8503-MPG	791440063167	BT8870-MPG	791440046429	PT8960-MPG	791440070189
BT8323	791440038912	PT8425	791440057869	BT8504	791440063174	BT8873	791440046511	PT8962-MPG	791440070219
BT8328	791440038080	BT8426-MPG	791440057937	BT8505	791440063174	BT8874-MPG	791440046443	PT8963-MPG	791440070226
PT8329	791440042926	PT8427	791440058170	PT8506-MPG	791440063525	BT8875-MPG	791440046566	PT8967-MPG	791440070264
PT8330-MPG	791440038943	BT8428-MPG	791440058248	PT8507-MPG	791440063532	BT8876-MPG	791440048775	PT8968-MPG	791440070271
PT8331-MPG	791440038141	BT8429	791440058316	BT8509-MPG	791440063600	BT8877-MPG	791440055759	PT8969-MPG	791440070288
BT8333	791440038950	BT8432-MPG	791440058569	BT8510-MPG	791440063622	BT8878-MPG	791440055766	PT8970-MPG	791440070295
PT8334	791440043725	PT8433-MPG	791440058583	PT8511	791440065529	BT8879-MPG	791440055773	PT8971-MPG	791440070301
PT8335	791440043176	PT8435-MPG	791440058798	BT8512	791440064836	BT8880-MPG	791440056183	PT8972-MPG	791440070318
PT8338	791440043657	PT8436	791440058804	PT8517-MPG	791440066250	PT8883	791440064935	PT8974-MPG	791440070332
PT8339	791440045897	BT8437	791440058811	PT8519-MPG	791440065147	PT8884-MPG	791440065093	PT8975-MPG	791440070349
PT8341	791440043169	BT8439-MPG	791440059061	OV8700	791440057326	PT8885-MPG	791440065192	PT8978-MPG	791440070370
PT8344	791440037571	BT8440-MPG	791440059030	OV8701	791440063662	PT8886-MPG	791440065161	PT8980-MPG	791440070394
PT8345	791440038073	PT8441	791440059177	OS8703	791440057357	PT8887	791440065468	PT8981-MPG	791440070400
BT8347	791440038295	PT8442	791440059382	OS8704	791440057364	PT8888	791440065505	PT8982-MPG	791440070417
PT8350	791440039353	BT8443	791440059504	OS8705	791440057371	PT8889	791440065604	PT8984-MPG	791440070431
PT8351	791440041196	BT8444	791440059610	OS8706	791440066342	BT8890-MPG	791440065697	PT8985-MPG	791440070448
PT8352	791440041189	BT8445	791440059798	OS8707	791440066359	PT8891-MPG	791440065734	PT8986-MPG	791440070455
PT8353	791440041202	BT8446-MPG	791440059795	OB8709	791440057388	BT8892-MPG	791440065741	PT8987-MPG	791440070462
PT8354	791440042490	PT8447-MPG	791440059870	OB8711	791440055353	PT8893	791440065864	PT8989-MPG	791440070486
PT8355	791440042506	B8448	791440059887	OB8712	791440055360	PT8894-MPG	791440066069	PT8990-MPG	791440070493
PT8356	791440043091	BT8449	791440060005	OS8717	791440077591	PT8895-MPG	791440066076	PT8991-MPG	791440070509
BT8357	791440043206	BT8449-10	791440060012	OB8720	791440055445	PT8896	791440066113	PT8992-MPG	791440070516
PT8359	791440043374	BT8450	791440060104	OB8721	791440055452	PT8897-MPG	791440066212	PT8993-MPG	791440070523
PT8361	791440044968	PT8451-MPG	791440060135	OB8722	791440055469	BT8898	791440066236	PT8994-MPG	791440070530
PT8363	791440045095	PT8452	791440060159	OB8724	791440055483	BT8899	791440066243	PT8995-MPG	791440070547
PT8366	791440045231	PT8453	791440060340	OV8728	791440081642	BT8900	791440066304	PT8996-MPG	791440070554
BT8368	791440045491	BT8455-MPG	791440060616	OB8731	791440057627	BT8901-MPG	791440066496	PT8997-MPG	791440070561
PT8370-MPG	791440047112	PT8456-MPG	791440060692	OB8732	791440057074	BT8902	791440066649	PT8998-MPG	791440070578
PT8371-MPG	791440047129	BT8457-MPG	791440060753	OB8741	791440057135	BT8903	791440066663	PT8999-MPG	791440070585
PT8372	791440047655	BT8458-MPG	791440060784	OB8742	791440057142	BT8904-MPG	791440066670	H9001	791440029255
PT8375-MPG	791440048140	PT8459	791440060883	OB8743	791440057128	BT8905	791440067028	H9007	791440029279
PT8376-MPG	791440048157	BT8460	791440062931	OB8744	791440057173	BT8906	791440067127	H9013	791440029293
PT8378-MPG	791440048676	BT8461	791440063976	OB8745	791440057180	PT8907-MPG	791440067158	H9014	791440029309
PT8380	791440051805	PT8462-MPG	791440061415	OB8746	791440057166	BT8908	791440067226	H9020	791440029323
BT8381	791440049680	BT8463-MPG	791440061552	OP8750	791440083530	PT8909	791440067240	H9021	791440029330
BT8382	791440050105	BT8464	791440061569	OP8751	791440083547	BT8910-MPG	791440067301	H9024	791440029347
PT8383	791440050129	BT8465	791440061576	OP8752	791440083554	BT8911-MPG	791440067318	H9036	791440029361
BT8384	791440050334	BT8466-MPG	791440061583	OP8753	791440083561	PT8912	791440067400	H9037	791440029378
PT8385	791440050532	PT8467	791440061590	OB8771	791440057197	BT8913-MPG	791440069671	H9039	791440029385
BT8386	791440050594	BT8468	791440061439	OB8772	791440057203	BT8914	791440069725	H9041	791440029408
PT8387	791440050686	PT8470	791440061460	OB8773	791440057395	BT8915	791440069732	H9042	791440029415
PT8388	791440050693	BT8471-MPG	791440061484	CFB8784	791440092945	BT8916	791440069749	H9043	791440029422
PT8389	791440050709	BT8472	791440061491	BT8800-MPG	791440060548	BT8917	791440069756	H9043-V	791440029422
BT8391	791440050945	BT8473	791440061507	BT8801-MPG	791440060555	BT8918	791440069763	H9044	791440029439
PT8392	791440051003	BT8474	791440061514	BT8802-MPG	791440029194	BT8919	791440069770	H9045	791440029446
BT8393	791440051454	BT8475	791440061521	BT8803-MPG	791440029200	BT8920	791440069787	H9046	791440029453
PT8394-MPG	791440051553	BT8475-MPG	791440073548	BT8805-MPG	791440057913	BT8921	791440069794	H9047	791440029460
PT8395	791440051621	BT8476	791440061538	BT8812-MPG	791440029231	BT8922	791440069800	H9048	791440029477
PT8396	791440051638	BT8476-MPG	791440069688	BT8813-MPG	791440029248	BT8926	791440069848	H9049	791440029484
BT8397-MPG	791440051850	BT8477	791440061545	BT8830	791440042395	BT8927	791440069855	H9050	791440029491
BT8398-MPG	791440051904	BT8477-MPG	791440073555	BT8831	791440043015	BT8928	791440069862	H9051	791440029507
PT8400-MPG	791440052079	PT8478	791440061606	BT8832	791440043008	BT8930	791440069886	H9052	791440029514
BT8401-MPG	791440052123	PT8479	791440061637	BT8833	791440058163	BT8931	791440069893	H9054	791440029521
PT8402-MPG	791440052178	PT8480	791440061644	BT8834-MPG	791440062320	BT8935	791440069930	H9055	791440029538
PT8403-MPG	791440052192	PT8481	791440062634	BT8840-MPG	791440038394	BT8937	791440069954	H9056	791440029545
PT8404-MPG	791440052284	PT8484	791440061897	BT8841-MPG	791440046917	PT8938-MPG	791440069961	H9057	791440029552
PT8407	791440053076	PT8485	791440062054	BT8842-MPG	791440051973	PT8939-MPG	791440069978	H9058	791440029569
PT8408	791440053083	BT8486	791440062108	BT8844	791440042636	PT8940-MPG	791440069985	H9060	791440029576
BT8409	791440053199	PT8487	791440062122	BT8843-MPG	791440052000	PT8941-MPG	791440069992	H9062	791440029583
PT8410	791440058187	BT8488	791440062139	BT8845	791440042629	PT8943-MPG	791440070011	H9069	791440029600
PT8411	791440058194	PT8489	791440062160	BT8846	791440045934	PT8945-MPG	791440070035	H9070	791440029606
BT8412	791440054424	PT8490-MPG	791440062221	BT8847	791440059634	PT8946-MPG	791440070042	H9071	791440029613
BT8413	791440055896	PT8491	791440062283	BT8848-MPG	791440051652	PT8947-MPG	791440070059	H9072	791440029620
PT8414-MPG	791440055001	PT8492	791440062290	BT8849-MPG	791440055735	PT8948-MPG	791440070066	H9072-V	791440075757
BT8415	791440055889	BT8493	791440062375	BT8850-MPG	791440038967	PT8950-MPG	791440070080	H9073	791440029637
BT8416	791440055100	PT8494	791440062504	BT8851-MPG	791440039322	PT8951-MPG	791440070097	H9074	791440029644
BT8417	791440055872	BT8495-MPG	791440062665	BT8852-MPG	791440045941	PT8952-MPG	791440070103	H9075	791440029651
BT8418	791440056114	PT8496-MPG	791440062788	BT8853-MPG	791440053304	PT8954-MPG	791440070127	H9075-V	791440077539
PT8419	791440056190	BT8497-MPG	791440062856	BT8855-MPG	791440055742	PT8955-MPG	791440070134	H9076	791440029668
BT8420	791440056985	PT8498	791440062917	BT8856-MPG	791440059573	PT8956-MPG	791440070141	H9076-V	791440075764
BT8421-MPG	791440057517	BT8499	791440063006	BT8861	791440038981	PT8957-MPG	791440070158	H9077	791440029675
BT8422-MPG	791440057524	BT8501-MPG	791440063051	BT8862	791440038400	PT8958-MPG	791440070165	H9078	791440029682
BT8423	791440057531	BT8502	791440063099	BT8863	791440038417	PT8959-MPG	791440070172	H9078-V	791440075771



WARNING: These products can expose you to chemicals, including Diisononyl Phthalate, Carbon black extracts, Nickel, 1,3 Butadiene, Ethylene Oxide, Epichlorohydrin, which are known to the State of California to cause cancer, and Bisphenol-A, Ethylene Glycol, Ethylene Oxide, 1,3 Butadiene, Epichlorohydrin, which are known to the State of California to cause birth defects or other reproductive harm. For more information go to www.P65Warnings.ca.gov.

BALDWIN TO UPC (INDIVIDUAL PARTS)

BALDWIN NUMBER	UPC NUMBER	BALDWIN NUMBER	UPC NUMBER	BALDWIN NUMBER	UPC NUMBER	BALDWIN NUMBER	UPC NUMBER	BALDWIN NUMBER	UPC NUMBER
H9079	791440029699	PT9189	791440071261	PT9297-MPG	791440073807	PT9385-MPG	791440079472	PT9468	791440092457
H9080	791440029705	PT9190	791440071278	PT9300-MPG	791440073838	PT9386-MPG	791440079489	PT9469	791440092662
H9081	791440029712	PT9191	791440071285	PT9302-MPG	791440073852	BT9387	791440079915	PT9470	791440092679
H9082	791440029729	PT9193	791440071308	PT9303-MPG	791440073869	BT9388	791440079953	BT9471	791440092808
H9083	791440029736	PT9195	791440071322	PT9304-MPG	791440073876	PT9389-MPG	791440079991	PT9472	791440093256
H9084	791440029743	PT9196	791440071339	PT9306-MPG	791440073890	PT9390-MPG	791440080027	PT9473	791440093287
H9085	791440029750	PT9197	791440071346	PT9307-MPG	791440073906	BT9391-MPG	791440080065	PT9474	791440093447
H9086	791440029767	PT9198	791440071353	PT9308-MPG	791440073913	BT9392-MPG	791440080119	S9475	791440093461
H9087	791440062252	PT9199	791440071360	PT9309-MPG	791440073920	BT9393-MPG	791440080126	PT9476-MPG	791440093485
H9092	791440029774	PT9200	791440071377	PT9310-MPG	791440073937	PT9394-MPG	791440080270	PT9477	791440093843
H9093	791440029781	PT9202	791440071391	PT9311-MPG	791440073944	PT9395-MPG	791440080768	PT9478-MPG	791440093850
H9096	791440029804	PT9203	791440071407	PT9312-MPG	791440073951	PT9396	791440080829	PT9479-MPG	791440093867
H9097	791440029811	PT9205	791440071421	PT9313-MPG	791440073968	PT9397-MPG	791440080836	PT9480-MPG	791440093874
H9103	791440029828	PT9206	791440071438	PT9315 KIT	791440073982	BT9398-MPG	791440081482	PT9481-MPG	791440093881
H9107	791440029835	PT9207	791440071445	BT9316-MPG	791440073531	PT9399-MPG	791440081920	PT9482-MPG	791440093898
H9108	791440029842	PT9208	791440071452	BT9318	791440075009	BT9400-MPG	791440082170	PT9483-MPG	791440093904
H9110	791440029859	PT9209	791440071469	BT9320	791440073579	PT9401	791440082137	PT9484-MPG	791440093911
H9111	791440029866	PT9210	791440071476	BT9321	791440073586	BT9402	791440082144	PT9485-MPG	791440093928
H9112	791440029873	BT9211	791440071483	BT9324	791440073616	PT9403-MPG	791440082199	PT9486-MPG	791440093935
H9113	791440029880	PT9212	791440071490	BT9326	791440073630	PT9404-MPG	791440082243	PT9487-MPG	791440093942
H9114	791440029897	PT9213	791440071506	H9327	791440075016	PT9405	791440082298	PT9488-MPG	791440093959
H9123	791440029903	PT9214	791440071513	PT9328-MPG	791440075023	PT9406-MPG	791440082465	PT9489-MPG	791440093966
PT9125-MPG	791440070615	PT9215	791440071520	PT9329	791440075245	PT9407-MPG	791440082618	PT9490-MPG	791440093973
PT9126	791440070639	PT9217	791440071544	PT9330-MPG	791440075333	BT9408	791440082632	PT9491-MPG	791440093980
PT9127	791440070646	PT9221	791440071582	PT9331	791440075877	PT9409-MPG	791440082809	PT9492-MPG	791440093997
PT9129	791440070660	PT9222	791440071599	PT9332	791440075870	PT9410-MPG	791440083066	PT9493-MPG	791440094000
PT9130	791440070677	PT9223	791440071605	PT9335-MPG	791440075849	PT9411-MPG	791440083073	PT9494-MPG	791440094017
PT9131	791440070684	PT9224	791440071612	PT9337-MPG	791440076112	PT9412-MPG	791440083196	PT9495-MPG	791440094024
PT9132	791440070691	PT9225	791440071629	PT9338-MPG	791440076259	PT9413-MPG	791440083271	PT9496-MPG	791440094031
PT9134	791440070714	PT9227	791440071643	PT9340-MPG	791440076341	PT9414-MPG	791440083691	PT9497-MPG	791440094048
PT9135	791440070721	PT9228	791440071650	PT9341	791440076525	PT9415-MPG KIT	791440079212	PT9498-MPG	791440094055
PT9136	791440070738	H9231	791440071681	PT9342-MPG	791440076587	PT9416-MPG KIT	791440079229	PT9499-MPG	791440094062
PT9137	791440070745	PT9236-MPG	791440074002	BT9343-MPG	791440076662	PT9417	791440083943	PT9500-MPG	791440094079
PT9139	791440070769	PT9237	791440074019	PT9344	791440076730	PT9418	791440083974	PT9501-MPG	791440094086
PT9140	791440070776	PT9238	791440074026	BT9345	791440076792	PT9419-MPG	791440084148	PT9502-MPG	791440094093
PT9142	791440070790	PT9239	791440074033	BT9346-MPG	791440076815	PT9420-MPG	791440086272	PT9503-MPG	791440094109
PT9143	791440070806	PT9240	791440074040	BT9347-MPG	791440076822	BT9421-MPG	791440086692	PT9504-MPG	791440094116
PT9144	791440070813	PT9242	791440074064	PT9348-MPG	791440076839	BT9422	791440086814	PT9505-MPG	791440094123
PT9145	791440070820	PT9244	791440074088	BT9349-MPG	791440076846	PT9423	791440086883	PT9506	791440094130
PT9147	791440070844	PT9245	791440074095	PT9350-MPG	791440076976	PT9424	791440086968	PT9507	791440094147
PT9148	791440070851	PT9246	791440074101	PT9351-MPG	791440076983	PT9425-MPG	791440087019	PT9508	791440094154
PT9149	791440070868	PT9247	791440074118	PT9352	791440077317	PT9426	791440087033	PT9509	791440094161
PT9150	791440070875	PT9248	791440074125	BT9353-MPG	791440077409	PT9427-MPG	791440087101	PT9510	791440094178
PT9152	791440070899	PT9250	791440074149	PT9354-MPG	791440077485	PT9429-MPG	791440087118	PT9511	791440094185
PT9153	791440070905	PT9251	791440074156	PT9355-MPG	791440077577	PT9430-MPG	791440087477	PT9512	791440094192
PT9154	791440070912	PT9254	791440074187	BT9356	791440077652	PT9432-MPG	791440087910	PT9513	791440094208
PT9155	791440070929	PT9255	791440074194	PT9357	791440077683	BT9433	791440087972	PT9514	791440094215
PT9157	791440070943	PT9256-MPG	791440074200	BT9358	791440077911	PT9434	791440088092	PT9515	791440094222
PT9158	791440070950	PT9257	791440074217	PT9359-MPG	791440078017	PT9435-MPG	791440088184	PT9516	791440094239
PT9159	791440070967	PT9258	791440074224	BT9360	791440078024	BT9436-MPG	791440089136	PT9517	791440094246
PT9161	791440070981	PT9259	791440074231	PT9361	791440078031	BT9437	791440088504	PT9518-MPG	791440094260
PT9162	791440070998	PT9260	791440074248	BT9362-MPG	791440078109	BT9439	791440089716	PT9519-MPG	791440094277
PT9163	791440071001	PT9261-MPG	791440074255	BT9363-MPG	791440078116	BT9440	791440090378	PT9520-MPG	791440094284
BT9164	791440071018	PT9264	791440074286	BT9364	791440078390	PT9441-MPG	791440090668	PT9522-MPG	791440094301
PT9165	791440071025	PT9266	791440074309	BT9365-MPG	791440078420	BT9442-MPG	791440091023	PT9523-MPG	791440094317
PT9167	791440071049	PT9267	791440074316	BT9366-MPG	791440078437	PT9443	791440091054	PT9524-MPG	791440094334
PT9168	791440071056	PT9268	791440074323	BT9367-MPG	791440078451	PT9444-MPG	791440091061	PT9525-MPG	791440094321
PT9169	791440071063	PT9272	791440074361	BT9368-MPG	791440078505	PT9445-MPG	791440091153	PT9526-MPG	791440094338
PT9170	791440071070	PT9277	791440074415	BT9369-MPG	791440078512	PT9446	791440091160	PT9528	791440094345
PT9171	791440071087	PT9278	791440074422	BT9370-MPG	791440078574	PT9447	791440091177	PT9529	791440094352
PT9172	791440071094	PT9279	791440074439	PT9371-MPG	791440078727	PT9448	791440091184	PT9530	791440094369
PT9174	791440071117	PT9282-MPG	791440073647	PT9372	791440078796	PT9449	791440091191	PT9531	791440094376
PT9175	791440071124	PT9283-MPG	791440073654	PT9373-MPG	791440079106	PT9450-MPG	791440091207	PT9532	791440094383
PT9176	791440071131	PT9284-MPG	791440073661	PT9374	791440078888	PT9451-MPG	791440091214	BT9533	791440094420
PT9178	791440071155	PT9285-MPG	791440073678	PT9375	791440078932	PT9452	791440091221	PT9535-MPG	791440094611
PT9179	791440071162	PT9286-MPG	791440073685	PT9376	791440078949	PT9453-MPG	791440084490	PT9536-MPG	791440094765
PT9180	791440071179	PT9287-MPG	791440073692	PT9377	791440078956	BT9454	791440091238	PT9537-MPG	791440095021
PT9181	791440071186	PT9288-MPG	791440073708	BT9378-MPG	791440079083	BT9456	791440091180	BT9553	791440085497
PT9182	791440071193	PT9289-MPG	791440073715	PT9379	791440079168	PT9459-MPG	791440091788	PT9554-MPG	791440085527
PT9183	791440071209	PT9290-MPG	791440073722	PT9381-MPG	791440079281	PT9462	791440091825	PT9555	791440085534
PT9185	791440071223	PT9291-MPG	791440073739	PT9380-MPG	791440079182	PT9463	791440091856	PT9556-MPG	791440085541
PT9186	791440071230	PT9293-MPG	791440073760	BT9382	791440079298	BT9464	791440091849	PT9557	791440085572
PT9187	791440071247	PT9295-MPG	791440073784	PT9383-MPG	791440079441	BT9465	791440091917	BT9558-MPG	791440085817
PT9188	791440071254	PT9296-MPG	791440073791	PT9384-MPG	791440079458	BT9466-MPG	791440091962	PT9559-MPG	791440085824



WARNING: These products can expose you to chemicals, including Diisononyl Phthalate, Carbon black extracts, Nickel, 1,3 Butadiene, Ethylene Oxide, Epichlorohydrin, which are known to the State of California to cause cancer, and Bisphenol-A, Ethylene Glycol, Ethylene Oxide, 1,3 Butadiene, Epichlorohydrin, which are known to the State of California to cause birth defects or other reproductive harm. For more information go to www.P65Warnings.ca.gov.

BALDWIN TO UPC (INDIVIDUAL PARTS)

BALDWIN NUMBER	UPC NUMBER	BALDWIN NUMBER	UPC NUMBER	BALDWIN NUMBER	UPC NUMBER	BALDWIN NUMBER	UPC NUMBER	BALDWIN NUMBER	UPC NUMBER
BT9560-MPG	791440086067	PF9868	791440090507	PA10012	791440089892	18171	791440030053	PT23037-MPG	791440095656
BT9561	791440086197	BF9869	791440090644	PA10013	791440100589	18198	791440030077	PT23038-MPG	791440095663
P9600	791440094444	PF9870	791440090682	PA10014	791440100619	18236	791440030114	PT23039-MPG	791440095670
B9601	791440094567	BF9871-O	791440090798	PA10015	791440100787	18245	791440030121	PT23040-MPG	791440095687
P9602	791440095007	PF9872	791440090958	PA10016	791440100893	18264	791440060371	PT23041-MPG	791440095694
P9603	791440095014	PF9873	791440090996	PA10017	791440100909	18265	791440060388	PT23042-MPG	791440095700
B9604	791440096509	BF9874-DM	791440091030	PA10018	791440101005	18267	791440060456	PT23043-MPG	791440095717
P9605	791440096578	BF9875-DM	791440091047	PA10020	791440102484	19593	791440030244	PT23044-MPG	791440095724
B9606	791440096615	BF9876	791440091078	RS10021	791440102606	19739	791440030329	PT23045-MPG	791440095731
B9607	791440096622	BF9877	791440091382	PA10022	791440103412	19828	791440030343	PT23046-MPG	791440095748
BF9800	791440086999	BF9878	791440091559	PA10023	791440103610	19992	791440030442	PT23047-MPG	791440095755
PF9801	791440087002	PF9879	791440091757	PA10024	791440103627	19996	791440064553	PT23048-MPG	791440095762
BF9802	791440087040	BF9880	791440091764	PA10025	791440103634	19999	791440064584	PT23049-MPG	791440095779
PF9803	791440087088	BF9881	791440091801	PA10026	791440103641	20000	791440064591	PT23050-MPG	791440095786
PF9804	791440087149	BF9882	791440091818	PA10027	791440103658	20001	791440064607	PT23051-MPG	791440095793
BF9805	791440087170	BF9883	791440091863	PA10028	791440103665	20002	791440064614	PT23052-MPG	791440095809
BF9807	791440087323	BF9884	791440091931	PA10030	791440103689	20003	791440065765	PT23053-MPG	791440095816
BF9808-D	791440087330	BF9885	791440091948	PA10031	791440103696	20004	791440065796	PT23054-MPG	791440095823
BF9809-D	791440087361	BF9886	791440091986	PA10032	791440103702	20005	791440067370	PT23055-MPG	791440095830
BF9810-D	791440087378	BF9887	791440092020	PA10033	791440103924	20008	791440077805	PT23056-MPG	791440095847
BF9811-SP	791440087415	BF9888	791440092037	PA10034	791440103993	20009	791440077812	PT23057-MPG	791440095854
BF9812	791440087507	PF9889	791440092051	RS10035	791440104235	20010	791440077829	PT23058-MPG	791440095861
BF9813	791440087514	PF9890	791440092068	PA10036	791440104372	20011	791440077836	PT23059-MPG	791440095878
PF9814	791440087521	BF9891-D	791440092075	PA10037	791440104501	20012	791440077850	PT23060-MPG	791440095885
BF9815	791440087583	BF9892-D	791440092082	PA10038	791440105638	20013	791440078062	PT23061-MPG	791440095892
BF9816	791440087606	BF9893	791440092099	PA10039	791440105645	20014	791440080386	PT23062-MPG	791440095908
BF9817	791440087637	BF9894	791440092105	PA10040	791440105652	20015	791440081673	PT23063-MPG	791440095915
BF9818	791440087644	BF9895 KIT	791440092303	PA10041	791440105669	20016	791440081680	PT23064-MPG	791440095922
BF9819	791440087651	PF9896 KIT	791440092341	PA10042	791440105676	20017	791440081697	PT23065-MPG	791440095939
BF9820	791440087668	PF9897	791440092358	PA10043	791440105683	20019	791440081710	PT23066-MPG	791440095946
BF9821	791440087682	BF9898-O	791440092372	PA10044	791440105744	20020	791440081727	PT23067-MPG	791440095953
BF9822-D	791440087705	PF9899	791440092389	PA10045	791440105751	20021	791440086708	PT23068-MPG	791440095960
PF9823	791440087712	PF9900	791440092396	PA10046	791440105768	20022	791440086715	PT23069-MPG	791440095977
PF9824	791440087736	PF9901 KIT	791440092433	PA10047	791440107298	20023	791440086722	PT23070-MPG	791440095984
PF9825	791440087743	PF9902	791440092518	PA10057	791440107885	20024	791440086739	PT23071-MPG	791440095991
PF9826	791440087750	BF9903-SP	791440092525	PA10058	791440108356	20025	791440100848	PT23072-MPG	791440096004
BF9827-D	791440087927	BF9904	791440092570	PA10060	791440108455	BW21000	791440097488	PT23073-MPG	791440096011
BF9828-D	791440087989	BF9905	791440092747	PA10061	791440108547	PT23000	791440095298	PT23074-MPG	791440096028
PF9829 KIT	791440088153	PF9906	791440092891	PA10062	791440108622	PT23001	791440095281	PT23075-MPG	791440096035
BF9830-D	791440088191	PF9907	791440092990	PA10066	791440108936	PT23002	791440095304	PT23076-MPG	791440096042
BF9831	791440088214	PF9908 KIT	791440093164	PA10067	791440108950	PT23003	791440095311	PT23077-MPG	791440096059
BF9832	791440088221	PF9909	791440093171	PA10068	791440109001	PT23004	791440095328	PT23078-MPG	791440096066
BF9833-D	791440088269	BF9910	791440093201	PA10070	791440109049	PT23005	791440095335	PT23079-MPG	791440096073
BF9834	791440088276	PF9911	791440093249	PA10071	791440109056	PT23006	791440095342	PT23080-MPG	791440096080
BF9835-D	791440088283	BF9912-O	791440093478	PA10072	791440109063	PT23007	791440095359	PT23081-MPG	791440096097
BF9836-D	791440088436	BF9913	791440093508	PA10073	791440109070	PT23008	791440095366	PT23082-MPG	791440096103
BF9837-D	791440088511	PF9914 KIT	791440093577	PA30183	791440105171	PT23009	791440095373	PT23083-MPG	791440096110
PF9838	791440088580	BF9915	791440093584	CV15000	791440080432	PT23010	791440095380	PT23084-MPG	791440096127
BF9839-D	791440088627	BF9916	791440093652	CV15001	791440089853	PT23011	791440095397	PT23085-MPG	791440096134
BF9840	791440088696	BF9917	791440093775	CV15002	791440090156	PT23012	791440095403	PT23086-MPG	791440096141
BF9841	791440088733	BF9918 KIT	791440093799	CV15003	791440093560	PT23013	791440095410	PT23087-MPG	791440096158
BF9842	791440088801	PF9919	791440094499	CV15004	791440096943	PT23014	791440095427	PT23088-MPG	791440096165
BF9843	791440088887	BF9920	791440094604	CV15005	791440104693	PT23015	791440095434	PT23089-MPG	791440096172
BF9844	791440088900	BF9921-O	791440094697	CV15006	791440105546	PT23016	791440095441	PT23090-MPG	791440096189
PF9845	791440089006	BF9922-O	791440094758	BA16000	791440104204	PT23017	791440095458	PT23091-MPG	791440096196
BF9846	791440089099	BF9923-O	791440094956	PE17001	791440106918	PT23018	791440095465	PT23092-MPG	791440096202
BF9847-D	791440089105	PF9924 KIT	791440095175	18003	791440047891	PT23019	791440095472	PT23093-MPG	791440096219
BF9848	791440089198	BF9925-O	791440095199	18004	791440047907	PT23020	791440095489	PT23094-MPG	791440096226
BF9849	791440089228	BF9926-O	791440095243	18007	791440047938	PT23021	791440095496	PT23095-MPG	791440096233
BF9850	791440089235	BF9927	791440095274	18010	791440047969	PT23022	791440095502	PT23096-MPG	791440096240
BF9851	791440089327	PF9928	791440096639	18015	791440029910	PT23023	791440095519	PT23097-MPG	791440096257
BF9852	791440089358	PF9929	791440096646	18022	791440051355	PT23024	791440095526	PT23098-MPG	791440096264
BF9853	791440089365	PA10000	791440096677	18024	791440051348	PT23025	791440095533	PT23099-MPG	791440096271
BF9854	791440089372	PA10001	791440096684	18025	791440051331	PT23026	791440095540	PT23100-MPG	791440096288
BF9857	791440089488	PA10002	791440096691	18027	791440051379	PT23027	791440095557	PT23101-MPG	791440096295
BF9858 KIT	791440089518	PA10003	791440096813	18029	791440052758	PT23028-MPG	791440095564	PT23102-MPG	791440096301
BF9860	791440090119	PA10004	791440096868	18032	791440055728	PT23029-MPG	791440095571	PT23103-MPG	791440096318
PF9861	791440090148	RS10005	791440096875	18033	791440056206	PT23030-MPG	791440095588	PT23104-MPG	791440096325
PF9862	791440090170	PA10006	791440096905	18034	791440056213	PT23031-MPG	791440095595	PT23105-MPG	791440096332
BF9863	791440090187	PA10007	791440096929	18055	791440059757	PT23032-MPG	791440095601	PT23106-MPG	791440096349
BF9864	791440090262	PA10008	791440097995	18056	791440059764	PT23033-MPG	791440095618	PT23107-MPG	791440096356
PF9865	791440090286	PA10009	791440098312	18057	791440059771	PT23034-MPG	791440095625	PT23108-MPG	791440096363
BF9866-O	791440090385	PA10010	791440098930	18104	791440029989	PT23035-MPG	791440095632	PT23109-MPG	791440096370
BF9867-O	791440090446	PA10011	791440098947	18155	791440030039	PT23036-MPG	791440095649	PT23110-MPG	791440096387



WARNING: These products can expose you to chemicals, including Diisononyl Phthalate, Carbon black extracts, Nickel, 1,3 Butadiene, Ethylene Oxide, Epichlorohydrin, which are known to the State of California to cause cancer, and Bisphenol-A, Ethylene Glycol, Ethylene Oxide, 1,3 Butadiene, Epichlorohydrin, which are known to the State of California to cause birth defects or other reproductive harm. For more information go to www.P65Warnings.ca.gov.

BALDWIN TO UPC (INDIVIDUAL PARTS)

BALDWIN NUMBER	UPC NUMBER	BALDWIN NUMBER	UPC NUMBER	BALDWIN NUMBER	UPC NUMBER	BALDWIN NUMBER	UPC NUMBER	BALDWIN NUMBER	UPC NUMBER
PT23111-MPG	791440096394	PT23189	791440099494	PT23269-MPG	791440100299	PT23353-MPG	791440101470	PT23427-MPG	791440102217
PT23112-MPG	791440096400	PT23190	791440099500	PT23270-MPG	791440100305	PT23354-MPG	791440101487	PT23428-MPG	791440102224
PT23113-MPG	791440096417	PT23193-MPG	791440099531	PT23271-MPG	791440100312	PT23355-MPG	791440101794	PT23429-MPG	791440102231
PT23114-MPG	791440096424	PT23195-MPG	791440099555	PT23272-MPG	791440100329	PT23356-MPG	791440101500	PT23430-MPG	791440102248
PT23115-MPG	791440096431	PT23196-MPG	791440099562	PT23273-MPG	791440100336	PT23357-MPG	791440101517	PT23431-MPG	791440102255
PT23116-MPG	791440096448	PT23197-MPG	791440099579	PT23274-MPG	791440100343	PT23358-MPG	791440101524	PT23432-MPG	791440102262
PT23117-MPG	791440096455	PT23198-MPG	791440099586	PT23275-MPG	791440100350	PT23359-MPG	791440101531	PT23433-MPG	791440102279
PT23118-MPG	791440096462	PT23200-MPG	791440099609	PT23276-MPG	791440100367	PT23360-MPG	791440101548	PT23434-MPG	791440102286
PT23119-MPG	791440096479	PT23201-MPG	791440099616	PT23277-MPG	791440100374	PT23361-MPG	791440101555	PT23435-MPG	791440102293
PT23120-MPG	791440096486	PT23202-MPG	791440099623	PT23278-MPG	791440100381	PT23362-MPG	791440101562	PT23436-MPG	791440102309
PT23122	791440097803	PT23203-MPG	791440099630	PT23279-MPG	791440100398	PT23363-MPG	791440101579	PT23437-MPG	791440102316
PT23123	791440097810	PT23204-MPG	791440099647	PT23280-MPG	791440100404	PT23364-MPG	791440101586	PT23438-MPG	791440102323
PT23124	791440097834	PT23205-MPG	791440099654	PT23281-MPG	791440100411	PT23365-MPG	791440101593	PT23439-MPG	791440102330
PT23125-MPG	791440097841	PT23206-MPG	791440099661	PT23282-MPG	791440100428	PT23366-MPG	791440101609	PT23440-MPG	791440102347
PT23126-MPG	791440097858	PT23207-MPG	791440099678	PT23283-MPG	791440100435	PT23367-MPG	791440101616	PT23441-MPG	791440102354
PT23127-MPG	791440097865	PT23208-MPG	791440099685	PT23284-MPG	791440100442	PT23368-MPG	791440101623	PT23442-MPG	791440102361
PT23128-MPG	791440097872	PT23209-MPG	791440099692	PT23285-MPG	791440100459	PT23369-MPG	791440101630	PT23443-MPG	791440102378
PT23129-MPG	791440097889	PT23211-MPG	791440099715	PT23286-MPG	791440100466	PT23370-MPG	791440101647	PT23444-MPG	791440102385
PT23131-MPG	791440097902	PT23212-MPG	791440099722	PT23287-MPG	791440100473	PT23371-MPG	791440101654	PT23445-MPG	791440102392
PT23132-MPG	791440097919	PT23213-MPG	791440099739	PT23289-MPG	791440100497	PT23372-MPG	791440101661	PT23446-MPG	791440102408
PT23133-MPG	791440097926	PT23214-MPG	791440099746	PT23290-MPG	791440100503	PT23373-MPG	791440101678	PT23447-MPG	791440102415
PT23134-MPG	791440097933	PT23215-MPG	791440099753	PT23291-MPG	791440100510	PT23374-MPG	791440101685	PT23448-MPG	791440101422
PT23135-MPG	791440097940	PT23216-MPG	791440099760	PT23292-MPG	791440100527	PT23375-MPG	791440101692	PT23449-MPG	791440102439
PT23136	791440097780	PT23217-MPG	791440099777	PT23294-MPG	791440100541	PT23376-MPG	791440101708	PT23450-MPG	791440102446
PT23137	791440097827	PT23218-MPG	791440099784	PT23295-MPG	791440100558	PT23377-MPG	791440101715	PT23451-MPG	791440102613
PT23138	791440098015	PT23219-MPG	791440099791	PT23296-MPG	791440100565	PT23378-MPG	791440101722	PT23452	791440102620
PT23139-MPG	791440098268	PT23220-MPG	791440099807	PT23297	791440100572	PT23379-MPG	791440101739	PT23453	791440102637
BT1340-MPG	791177098275	PT23221-MPG	791440099814	PT23306	791440100597	PT23380-MPG	791440101746	PT23454	791440102644
PT23141	791440099012	PT23223-MPG	791440099838	PT23308	791440101029	PT23381-MPG	791440101753	PT23455	791440102651
PT23142	791440099029	PT23224-MPG	791440099845	PT23309	791440101036	PT23382-MPG	791440101760	PT23456	791440102668
PT23143	791440099036	PT23225-MPG	791440099852	PT23310	791440101043	PT23383-MPG	791440101777	PT23457	791440102675
PT23144	791440099043	PT23226-MPG	791440099869	PT23311	791440101050	PT23384-MPG	791440101784	PT23458	791440102682
PT23145	791440099050	PT23227-MPG	791440099876	PT23312	791440101067	PT23385-MPG	791440101791	PT23459	791440102699
PT23146	791440099067	PT23228-MPG	791440099883	PT23313	791440101074	PT23386-MPG	791440101807	PT23460	791440102705
PT23147	791440099074	PT23229-MPG	791440099890	PT23314	791440101081	PT23387-MPG	791440101814	PT23461	791440102712
PT23148	791440099081	PT23230-MPG	791440099906	PT23315	791440101098	PT23388-MPG	791440101821	PT23462	791440102729
PT23149	791440099098	PT23231-MPG	791440099913	PT23316	791440101104	PT23389-MPG	791440101838	PT23463	791440102736
PT23150	791440099104	PT23232-MPG	791440099920	PT23317	791440101111	PT23390-MPG	791440101845	PT23464	791440102743
PT23151	791440099111	PT23233-MPG	791440099937	PT23318	791440101128	PT23391-MPG	791440101852	PT23465	791440102750
PT23152	791440099128	PT23234-MPG	791440099944	PT23319	791440101135	PT23392-MPG	791440101869	PT23466	791440102767
PT23154	791440099142	PT23235-MPG	791440099951	PT23320	791440101142	PT23393-MPG	791440101876	PT23467	791440102774
PT23155	791440099159	PT23236-MPG	791440099968	PT23321	791440101159	PT23394-MPG	791440101883	PT23468	791440102781
PT23156	791440099166	PT23237-MPG	791440099975	PT23322	791440101166	PT23395-MPG	791440101890	PT23469	791440102798
PT23157	791440099173	PT23238-MPG	791440099982	PT23323	791440101173	PT23396-MPG	791440101906	PT23470	791440102804
PT23158	791440099180	PT23239-MPG	791440099999	PT23324	791440101180	PT23397-MPG	791440101913	PT23471	791440102811
PT23159	791440099197	PT23240-MPG	791440100008	PT23325	791440101197	PT23398-MPG	791440101920	PT23472	791440102828
PT23160	791440099203	PT23241-MPG	791440100015	PT23326	791440101203	PT23399-MPG	791440101937	PT23473	791440102835
PT23161	791440099210	PT23242-MPG	791440100022	PT23327	791440101210	PT23400-MPG	791440101944	PT23474	791440102842
PT23162	791440099227	PT23243-MPG	791440100039	PT23328	791440101227	PT23401-MPG	791440101951	PT23475	791440102859
PT23163	791440099234	PT23244-MPG	791440100046	PT23329	791440101234	PT23402-MPG	791440101968	PT23476	791440102866
PT23164	791440099241	PT23245-MPG	791440100053	PT23330	791440101241	PT23403-MPG	791440101975	PT23477	791440102873
PT23165	791440099258	PT23246-MPG	791440100060	PT23331	791440101258	PT23404-MPG	791440101982	PT23478	791440102880
PT23166	791440099265	PT23247-MPG	791440100077	PT23332	791440101265	PT23405-MPG	791440101999	PT23479	791440102887
PT23167	791440099272	PT23248-MPG	791440100084	PT23333	791440101272	PT23406-MPG	791440102006	PT23480	791440102903
PT23168	791440099289	PT23249-MPG	791440100091	PT23334	791440101289	PT23407-MPG	791440102013	PT23481	791440102910
PT23169	791440099296	PT23250-MPG	791440100107	PT23335	791440101296	PT23408-MPG	791440102020	PT23482	791440102927
PT23170	791440099302	PT23251-MPG	791440100114	PT23336	791440101302	PT23409-MPG	791440102033	PT23483-MPG	791440102934
PT23171	791440099319	PT23252-MPG	791440100121	PT23337	791440101319	PT23410-MPG	791440102040	PT23484-MPG	791440102941
PT23172	791440099326	PT23253-MPG	791440100138	PT23338-MPG	791440101326	PT23411-MPG	791440102057	PT23485-MPG	791440102958
PT23173	791440099333	PT23254-MPG	791440100145	PT23339-MPG	791440101333	PT23412-MPG	791440102064	PT23486-MPG	791440102965
PT23174	791440099340	PT23255-MPG	791440100152	PT23340-MPG	791440101340	PT23413-MPG	791440102071	PT23487-MPG	791440102972
PT23175	791440099357	PT23256-MPG	791440100169	PT23341-MPG	791440101357	PT23414-MPG	791440102095	PT23488-MPG	791440102989
PT23176	791440099364	PT23257-MPG	791440100176	PT23342-MPG	791440101364	PT23415-MPG	791440102088	PT23489-MPG	791440102996
PT23178	791440099388	PT23258-MPG	791440100183	PT23343-MPG	791440101371	PT23416-MPG	791440102101	PT23490-MPG	791440103003
PT23179	791440099395	PT23259-MPG	791440100190	PT23344-MPG	791440101388	PT23417-MPG	791440102118	PT23491-MPG	791440103010
PT23180	791440099401	PT23260-MPG	791440100206	PT23345-MPG	791440101395	PT23418-MPG	791440102125	PT23492-MPG	791440103023
PT23181	791440099418	PT23261-MPG	791440100213	PT23346-MPG	791440101401	PT23419-MPG	791440102132	PT23493-MPG	791440103030
PT23182	791440099425	PT23262-MPG	791440100220	PT23347-MPG	791440101418	PT23420-MPG	791440102149	PT23494-MPG	791440103047
PT23183	791440099432	PT23263-MPG	791440100237	PT23348-MPG	791440101425	PT23421-MPG	791440102156	PT23495-MPG	791440103054
PT23184	791440099449	PT23264-MPG	791440100244	PT23349-MPG	791440101432	PT23422-MPG	791440102163	PT23496-MPG	791440103061
PT23185	791440099456	PT23265-MPG	791440100251	PT23349-MPG	791440101449	PT23423-MPG	791440102170	PT23497-MPG	791440103078
PT23186	791440099463	PT23266-MPG	791440100268	PT23350-MPG	791440101456	PT23424-MPG	791440102187	PT23498-MPG	791440103085
PT23187	791440099470	PT23267-MPG	791440100275	PT23351-MPG	791440101463	PT23425-MPG	791440102194	PT23499-MPG	791440103092
PT23188	791440099487	PT23268-MPG	791440100282	PT23352-MPG	791440101470	PT23426-MPG	791440102201	PT23500-MPG	791440103109



WARNING: These products can expose you to chemicals, including Diisononyl Phthalate, Carbon black extracts, Nickel, 1,3 Butadiene, Ethylene Oxide, Epichlorohydrin, which are known to the State of California to cause cancer, and Bisphenol-A, Ethylene Glycol, Ethylene Oxide, 1,3 Butadiene, Epichlorohydrin, which are known to the State of California to cause birth defects or other reproductive harm. For more information go to www.P65Warnings.ca.gov.

BALDWIN TO UPC (INDIVIDUAL PARTS)

BALDWIN NUMBER	UPC NUMBER	BALDWIN NUMBER	UPC NUMBER	BALDWIN NUMBER	UPC NUMBER	BALDWIN NUMBER	UPC NUMBER	BALDWIN NUMBER	UPC NUMBER
PT23501-MPG	791440103115	BT23609-MPG	791440108325	PA30072	791440098176	PA30151	791440104389	B40000	791440096721
PT23502-MPG	791440103122	BT23611	791440108509	PA30073	791440098183	PA30152	791440105720	P40001	791440096738
PT23503-MPG	791440103139	PT23616-MPG	791440109179	PA30074	791440098190	PA30153	791440104440	P40002	791440097957
PT23504-MPG	791440103146	PA30000	791440096653	PA30075	791440098282	PA30154	791440104457	P40003	791440096912
PT23505-MPG	791440103153	PA30001	791440096660	PA30076	791440098305	PA30155	791440104464	C40004	791440097971
PT23506-MPG	791440103160	PA30002	791440096752	RS30077	791440098954	PA30156	791440104471	C40005	791440097989
PT23507-MPG	791440103177	PA30003	791440096769	RS30078	791440098961	PA30157	791440104488	B40006	791440097964
PT23508-MPG	791440103184	PA30004	791440096776	CA30079	791440099005	PA30158	791440104594	BC40007	791440098022
PT23509-MPG	791440103191	PA30005	791440096783	PA30080	791440100596	RS30159	791440104600	P40008	791440098077
PT23510-MPG	791440103207	PA30006	791440096790	PA30081	791440100602	RS30160	791440104617	BC40009	791440098084
PT23511-MPG	791440103214	PA30007	791440096806	PA30086	791440100770	RS30161	791440104624	P40010	791440098091
PT23512-MPG	791440103221	RS30008	791440096820	RS30087	791440103764	RS30162	791440104631	P40011	791440098237
PT23513-MPG	791440103238	RS30009	791440096837	RS30088	791440103771	PA30163	791440104679	P40012	791440098244
PT23514-MPG	791440103245	PA30010	791440096882	RS30090-FN	791440100831	PA30164	791440104761	B40013	791440098251
PT23515-MPG	791440103252	PA30011	791440096950	RS30091	791440100855	PA30165	791440105270	P40014	791440098329
PT23516-MPG	791440103269	PA30012	791440096967	RS30092	791440100862	PA30166	791440105263	BT40015	791440100763
PT23517-MPG	791440103276	PA30013	791440096974	PA30093	791440100886	RS30168	791440104877	P40017	791440104044
PT23518-MPG	791440103283	PA30014	791440096981	PA30094	791440100916	RS30169	791440104884	P40019	791440102491
PT23519-MPG	791440103290	PA30015	791440096998	PA30095	791440100930	PA30170	791440104822	P40020	791440103450
PT23520-MPG	791440103306	PA30016	791440097001	PA30096	791440100954	PA30171	791440104846	P40021	791440103603
PT23521-MPG	791440103313	PA30017	791440097018	PA30098	791440101012	PA30172	791440104907	B40022-MPG	791440103566
PT23522-MPG	791440103320	PA30018	791440097025	RS30099	791440102507	PA30173	791440104914	P40023	791440103719
PT23523-MPG	791440103337	PA30019	791440097032	PA30100	791440102514	PA30174	791440105041	P40024	791440103726
PT23524-MPG	791440103344	PA30020	791440097049	PA30101	791440102521	RS30175	791440105058	P40025	791440103733
BT23525-MPG	791440103429	PA30021	791440097056	CA30102	791440103504	PA30177	791440105089	BD40027	791440104556
PT23528-MPG	791440103757	PA30022	791440097063	CA30103	791440103498	PA30179	791440105126	BT40028	791440105027
PT23526	791440103474	PA30023	791440097070	CA30104	791440103528	RS30180	791440105140	PA40030	791440105034
PT23527	791440103535	PA30024	791440097087	CA30105	791440103511	RS30181	791440105157	P40031-MPG	791440105072
PT23530	791440104242	PA30025	791440097094	RS30106	791440102545	RS30182	791440105164	BT40032	791440105287
PT23531-MPG	791440104020	PA30026	791440097100	PA30107	791440102552	PA30185	791440105478	P40033	791440105386
PT23532-MPG	791440104211	PA30027	791440097117	PA30108	791440102576	RS30187XP	791440105492	BT40034	791440105461
PT23533	791440104259	PA30028	791440097124	PA30109	791440102569	PA30188	791440105539	P40035	791440105690
PT23534	791440104310	PA30029	791440097131	PA30110	791440102583	PA30189	791440105560	B40036	791440105706
PT23535	791440104327	PA30030	791440097148	RS30112	791440102590	PA30190	791440105577	BT40038	791440105782
PT23536	791440104334	PA30031	791440097155	PA30113	791440103382	RS30191	791440105584	B40050	791440107458
BT23537	791440104532	PA30032	791440097179	PA30114	791440103399	RS30192	791440105591	P40052	791440107687
BT23539	791440104570	PA30033	791440097186	PA30115	791440103405	PA30204	791440108608	B40053	791440107731
BT23540	791440104587	PA30034	791440097193	RS30116	791440103436	PA30206	791440108370	B40054	791440107748
BT23542-MPG	791440104686	PA30035	791440097209	PA30117	791440103467	PA30207	791440108387	B40056	791440107847
BT23543-MPG	791440104785	PA30036	791440097216	PA30118	791440103542	PA30208	791440108394	P40058	791440108226
PT23544-MPG	791440104792	PA30037	791440097223	PA30119	791440103559	RS30209	791440107908	PA40061	791440108578
PT23556-MPG	791440105256	PA30038	791440097230	RS30120	791440103573	PA30211	791440107922	P40062	791440108615
PT23560	791440105621	PA30039	791440097247	RS30121	791440103580	RS30216	791440107984	BF45000	791440098299
PT23565-MPG	791440106925	PA30040	791440097254	PA30122	791440103801	RS30217	791440107991	BF46000	791440096707
PT23566-MPG	791440106932	PA30041	791440097261	PA30123	791440103818	RS30223	791440108066	BF46001	791440096714
PT23567-MPG	791440106949	PA30042	791440097278	PA30124	791440103825	RS30224	791440108073	BF46002	791440096745
PT23568-MPG	791440106956	PA30043	791440097285	PA30125	791440103832	RS30225	791440108080	PF46003	791440096844
PT23569-MPG	791440106963	PA30044	791440097292	PA30126	791440103948	RS30226	791440108097	PF46004	791440096851
PT23570-MPG	791440106970	PA30045	791440097308	PA30127	791440103955	PA30228	791440108196	BF46005	791440096899
PT23571-MPG	791440106987	PA30048	791440097339	RS30128	791440103979	PA30229	791440108202	BF46006	791440097490
PT23572-MPG	791440106994	PA30049	791440097346	RS30129	791440103986	RS30232	791440108288	BF46007	791440097506
PT23573-MPG	791440107007	PA30050	791440097353	RS30130	791440104228	PA30233-FN	791440108301	BF46008	791440097513
PT23574-MPG	791440107014	PA30051	791440097360	CA30131	791440107267	RS30234	791440108332	PF46009	791440097520
PT23575-MPG	791440107021	PA30052	791440097377	CA30132	791440107274	PA30235	791440107939	PF46010 KIT	791440097537
PT23576-MPG	791440107038	PA30053	791440097384	RS30133	791440104105	RS30236	791440108004	BF46012	791440097551
PT23577-MPG	791440107045	PA30054	791440097391	RS30134	791440104112	RS30237	791440108561	BF46013	791440097568
PT23578-MPG	791440107052	PA30055	791440097407	RS30135	791440104181	RS30242	791440108448	BF46014	791440097575
PT23579-MPG	791440107069	PA30056	791440097414	RS30136	791440104198	PA30243	791440108660	BF46015	791440097582
PT23580-MPG	791440107076	RS30057	791440097421	PA30137	791440104129	PA30244	791440108653	BF46016-O	791440097636
PT23581-MPG	791440107083	RS30058	791440097438	PA30138	791440104136	PA30251	791440108868	BF46017-O	791440097643
PT23582-MPG	791440107090	RS30059-FN	791440097445	PA30139	791440104143	PA30252	791440108891	BF46018-O	791440097650
PT23583-MPG	791440107106	RS30060-FN	791440097452	PA30140	791440104150	PA31000	791440105317	BF46019-O	791440097667
PT23585	791440107120	RS30061	791440097469	PA30141	791440104167	PA31001	791440105348	BF46020-O	791440097674
PT23586	791440107137	RS30062	791440097476	RS30142	791440104976	PA31002	791440105324	BF46021-O	791440097681
PT23587	791440107144	PA30063	791440097162	RS30142 KIT	791440104983	PA31003	791440105355	BF46022-O	791440097698
PT23588	791440107151	PA30064	791440098008	RS30143	791440104990	PA31004	791440105393	BF46023-O	791440097704
PT23589	791440107168	RS30065	791440098039	RS30143 KIT	791440105003	PA31005	791440105423	BF46024-O	791440097711
PT23590	791440107175	RS30065 KIT	791440098046	PA30144	791440104174	PA31006	791440105409	BF46025-O	791440097728
PT23591-MPG	791440107199	PA30066	791440098114	PA30145	791440104426	PA31007	791440105430	BF46026-O	791440097735
PT23592	791440107304	PA30067	791440098121	PA30146	791440104433	PA31010	791440105331	BF46027-O	791440097742
PT23595-MPG	791440107717	PA30068	791440098138	RS30147	791440104419	PA31011	791440105362	BF46028-O	791440097759
PT23600	791440107830	PA30069	791440098145	PA30148	791440104273	PA31012	791440105416	BF46029-O	791440097766
BT23603-MPG	791440107762	PA30070	791440098152	PA30149	791440104358	PA32001	791440106819	BF46030-O	791440097773
BT23607-MPG	791440107878	CA30071	791440098169	PA30150	791440104365	PA32004	791440106826	BF46031	791440098053



WARNING: These products can expose you to chemicals, including Diisononyl Phthalate, Carbon black extracts, Nickel, 1,3 Butadiene, Ethylene Oxide, Epichlorohydrin, which are known to the State of California to cause cancer, and Bisphenol-A, Ethylene Glycol, Ethylene Oxide, 1,3 Butadiene, Epichlorohydrin, which are known to the State of California to cause birth defects or other reproductive harm. For more information go to www.P65Warnings.ca.gov.

BALDWIN TO UPC (INDIVIDUAL PARTS)

BALDWIN NUMBER	UPC NUMBER	BALDWIN NUMBER	UPC NUMBER	BALDWIN NUMBER	UPC NUMBER	BALDWIN NUMBER	UPC NUMBER	BALDWIN NUMBER	UPC NUMBER
BF46032	791440098107	OAS98025	791440098596	Gaskets		G253-A	791440031685	G409	791440032774
PF46033	791440098206	OAS98026	791440098602	G15-AF	791440033764	G255	791440031692	G410	791440032781
BF46034	791440098978	OAS98027	791440098619	G21-AF	791440033801	G257	791440031715	G411	791440032798
BF46037	791440100923	OAS98028	791440098626	ES24-B	791440030558	G260	791440031722	G412	791440032804
BF46038-D	791440100985	OAS98029	791440098633	ES24-D	791440054271	G261	791440031739	G416	791440032835
BF46039-D	791440100992	OAS98030	791440098640	G25-AF	791440033818	G263	791440031753	G417	791440032842
BF46040-D	791440102460	OAS98031	791440098657	OAS98031	791440034129	G264-A	791440031760	G422-AF	791440034587
BF46041-D	791440103351	OAS98032	791440098664	G34-AF	791440034150	G265	791440031777	G431	791440032880
BF46042-D	791440103368	OAS98033	791440098671	G37-AF	791440034177	G268	791440031791	G432	791440032897
BF46043-D	791440103375	OAS98034	791440098688	G39-AF	791440034164	G269	791440031807	G433	791440032903
BF46044-D	791440103443	OAS98035	791440098695	G102-A	791440030619	G270	791440031814	G434	791440032910
BF46045-D	791440103849	OAS98036	791440098701	G103	791440030626	G273	791440031821	G435	791440032927
PF46046	791440103962	OAS98037	791440098718	G103-N	791440054288	G274	791440031838	G436	791440032934
BF46048	791440104037	OAS98038	791440098725	G104	791440030633	G275	791440031845	G438	791440032958
PF46049	791440104549	OAS98039	791440098732	G105	791440030640	G278	791440031852	G439	791440032965
BF46050	791440104303	OAS98040	791440098749	G106	791440030657	G280	791440031876	G441	791440032972
BF46051	791440104341	OAS98041	791440098756	G107	791440030664	G281	791440031883	G442	791440032989
BF46052	791440104396	OAS98042	791440098763	G115-A	791440030718	G283	791440031906	G443	791440032996
PF46056	791440104709	OAS98043	791440098770	G115-MSB	791440030725	G285-AF	791440034771	G444	791440033009
PF46057	791440104719	OAS98044	791440098787	G120-A	791440030756	G286-C	791440047167	G445	791440033016
BF46062	791440104778	OAS98045	791440098794	G123	791440030877	G288	791440031913	G446	791440033023
BF46065-SPS	791440105607	OAS98046	791440098800	G127	791440030817	G289	791440031920	G447	791440033030
BF46071	791440105232	OAS98047	791440098817	G132	791440030855	G291	791440031944	G449-B	791440033047
BF46072	791440105249	OAS98048	791440098824	G133	791440030862	G293-B	791440059992	G458	791440033061
PF46077	791440105713	OAS98049	791440098831	G140-A	791440030923	G296	791440031951	G467	791440033108
BF46078-D	791440105799	OAS98050	791440098848	G141-AF	791440034396	G298-AF	791440034501	G468	791440033115
BF46083-O	791440106758	OAS98052	791440098862	G143	791440030954	G299	791440031968	G472-AF	791440059153
BF46084	791440106871	OAS98053	791440098879	G144	791440030961	G302	791440031982	G480	791440033139
BF46085	791440107182	OAS98054	791440098886	G145-AF	791440034419	G303	791440031999	G483	791440040106
PF46086	791440107212	OAS98056	791440098909	G147-A	791440030978	G304	791440032002	G494	791440076198
BF46087	791440107281	OAS98057	791440098916	G148	791440030985	G305	791440032019	G498-A	791440040052
PF46088	791440107311	OAS98058	791440098923	G153	791440031005	G306	791440032026	G499-AF	791440039650
PF46092	791440108493	OAS98060	791440103740	G154	791440031012	G307	791440032033	G501-AF	791440033832
BF46098-O	791440107366	OAS98061	791440105737	G155	791440031029	G309-B	791440032040	AF521-WN	791440049352
BF46099-O	791440107380	OAS99001	791440072169	G157	791440031036	G310	791440032057	G523-AF	791440076204
BF46100-O	791440107373	OAS99002	791440072176	G161	791440031074	G314	791440032071	AF525-WN	791440049369
PF46103	791440107700	OAS99003	791440072183	G162	791440031081	G315	791440032088	G534-AF	791440079519
BF46111	791440108257	OAS99004	791440072190	G164-A	791440031098	G323	791440032149	G704	791440065987
PF46112	791440104495	OAS99005	791440072206	G165	791440031104	G332	791440032187	G710	791440065994
BF46113-D	791440108318	OAS99006	791440072213	G168-B	791440031128	G333	791440032194	G717	791440062573
BF46117	791440108462	OAS99008	791440072237	G169	791440031135	G336	791440032217	G725	791440063303
BF46122	791440109605	OAS99010	791440072251	G171	791440031159	G340	791440032248	ES1001	791440033184
PF46119	791440108486	OAS99011	791440072268	G172-A	791440031173	G342	791440032255	ES1023	791440033207
BF46125	791440108721	OAS99014	791440072299	G173-C	791440031180	G343-A	791440032262	ES1026	791440033214
BF46127	791440108820	OAS99015	791440072305	G183	791440002265	G344	791440032279	ES1030	791440033238
BF46129	791440108998	OAS99016	791440072312	G184-A	791440031227	G347	791440032293	ES1031	791440059122
PF46130	791440109155	OAS99017	791440072329	G193	791440031265	G348-AF	791440039667	ES1032	791440033245
BF46147-O	791440109780	OAS99018	791440072336	G196-B	791440031289	G354	791440032316	ES1034	791440033252
BD50000	791440105096	OAS99019	791440072343	G202	791440031319	G356	791440032330	ES1036	791440033276
OAS98000	791440098963	OAS99020	791440072350	G203	791440031326	G359	791440032354	ES1039	791440076211
OAS98001	7914400989350	OAS99021	791440072367	G204-A	791440031333	G360	791440032361	ES1041	791440033283
OAS98002	7914400989367	OAS99023	791440072381	G206	791440031357	G362	791440032378	ES1049	791440033306
OAS98003	7914400989374	OAS99024	791440072398	G207-AF	791440033440	G363	791440032385	ES1066	791440033337
OAS98004	7914400989381	OAS99025	791440072404	G208-A	791440031364	G366	791440032408	ES1067	791440033344
OAS98005	7914400989398	OAS99028	791440072435	G210	791440031388	G368	791440032415	ES1068	791440033351
OAS98006	7914400989404	OAS99029	791440072442	G211	791440031395	G369-B	791440060913	ES1071	791440033368
OAS98007	7914400989411	OAS99031	791440072466	G214	791440031401	G369-V	791440066007	ES1074	791440033375
OAS98008	7914400989428	OAS99032	791440072473	G219	791440031425	G372	791440032446	G1086-AF	791440033825
OAS98009	7914400989435	OAS99034	791440074774	G220	791440031432	G376	791440032484	ES1092	791440033382
OAS98010	7914400989442	OAS99035	791440074781	G222-B	791440031449	G379	791440032507	ES1303-A	791440033399
OAS98011	7914400989459	OAS99037	791440074804	G225-AF	791440059146	G380	791440032514	ES1303-B	791440033405
OAS98012	7914400989466	OAS99038	791440074811	G229	791440031487	G381-A	791440032521	ES1369-A	791440033412
OAS98013	7914400989473	OAS99040	791440074835	G232	791440031500	G382	791440032538	ES1375	791440033429
OAS98014	7914400989480	OAS99042	791440074859	G233-A	791440031517	G382-V	791440032545	ES1376	791440051256
OAS98015	7914400989497	OAS99043	791440074866	G233-B	791440031524	G385	791440032576	ES1377	791440045651
OAS98016	7914400989503	OAS99046	791440075818	G236-A	791440031555	G386	791440032583	G1972	791440076235
OAS98017	7914400989510	OAS99047	791440107663	G238	791440031579	G392	791440032613	G1973	791440033177
OAS98018	7914400989527	OAS99048	791440107670	G239	791440031586	G394	791440032637	ES3012	791440033474
OAS98019	7914400989534			G240	791440031593	G397	791440032668	ES3028	791440033481
OAS98020	7914400989541			G241	791440031609	G400	791440032682	ES3029	791440033498
OAS98021	7914400989558			G243-A	791440031619	G401	791440032699	ES3063	791440033528
OAS98022	7914400989565			G247	791440031630	G402	791440032705	ES3231	791440066748
OAS98023	7914400989572			G251	791440031661	G403	791440032712	ES4007	791440039773
OAS98024	7914400989589			G252	791440031678	G406	791440032743	ES4008	791440039766



WARNING: These products can expose you to chemicals, including Diisononyl Phthalate, Carbon black extracts, Nickel, 1,3 Butadiene, Ethylene Oxide, Epichlorohydrin, which are known to the State of California to cause cancer, and Bisphenol-A, Ethylene Glycol, Ethylene Oxide, 1,3 Butadiene, Epichlorohydrin, which are known to the State of California to cause birth defects or other reproductive harm. For more information go to www.P65Warnings.ca.gov.

BALDWIN TO UPC (INDIVIDUAL PARTS)

BALDWIN NUMBER	UPC NUMBER	BALDWIN NUMBER	UPC NUMBER	BALDWIN NUMBER	UPC NUMBER	BALDWIN NUMBER	UPC NUMBER	BALDWIN NUMBER	UPC NUMBER
1S-9133	791440033559	100-21M	791440035270	200-31	791440036246	PKG401	791440040502	43573P	857123005203
4L-8212-R	791440033603	100-28	791440035324	200-DEPR KIT	791440080799	PKG402	791440040519	43574P	857123005197
5H-5601	791440033627	100-29	791440035331	200-GK	791440036321	PKG406	791440040557	38557C	857123005654
5M-954	791440033634	100-30	791440035348	200-H	791440036338	PKG406-W	791440040564	38559C	857123005418
6L-1540	791440033658	100-BP	791440035416	200-M	791440036369	PKG411	791440058842	38560C	857123005425
7B-7635	791440033665	100-DEPR KIT	791440080805	200-MFV	791440036390	PKG412	791440058859	38561C	857123005432
8M-7830	791440033740	100-GK	791440035454	200-MMV	791440036406	PKG470	791440063549	38562C	857123005449
		100-H	791440035461	200-W30	791440036451	PKG470-DVD	791440063556	38563C	857123005456
		100-M	791440035485	201	791440036468	PKG470-S	791440063570	38564C	857123005302
		100-MFV	791440035508	201-30	791440036475	PKG475	791440067431	38565C	857123005319
		100-MMV	791440035515	201-W	791440036499	PKG475-R	791440076440	38566C	857123005326
		100-MNTG KIT	791440080812	285-DS	791440036505	PKG475-S	791440067448	38567C	857123005333
		100-W	791440035546	286-SK	791440036512	PKG490-BANK	791440065949	38568C	857123005340
		100-W30	791440065826	300	791440036529			38574C	857123005463
DAHL		101	791440035577	300-DHRAP5	791440036659	Stanadyne Fuel Additives		38575C	857123005470
24-WLK	791440034778	101-30	791440001374	300-DHRAS5	791440036666	38557P	857123005210	38576C	857123005487
55-EK	791440034792	101-W	791440035591	300-H	791440036741	38559P	857123005050	43562C	857123005494
60-21	791440034822	140-10	791440035614	300-M	791440036758	38560P	857123005067	43564C	857123005500
60-21A	791440034839	140-50 KIT	791440035652	300-MFV	791440036796	38561P	857123005074	43566C	857123005517
60-30	791440034877	150	791440035737	300-MFV3	791440036802	38562P	857123005081	43568C	857123005555
60-35A	791440034914	150-31	791440035812	300-MMV	791440036833	38563P	857123005098	43570C	857123005562
60-GK	791440034921	150-GK	791440035850	300-MMV3	791440036840	38564P	857123005005	43572C	857123005579
61	791440034938	150-H	791440035867	300-W30	791440065840	38565P	857123005012	43573C	857123005593
61-W	791440034945	150-M	791440035881	301	791440036956	38566P	857123005029	43574C	857123005586
65	791440034952	150-W30	791440065833	301-30	791440036963	38567P	857123005036	38557S	857123005661
65-35A	791440034976	151	791440035911	301-CS	791440036970	38568P	857123005043	38564S	857123005357
65-W30	791440065802	151-30	791440035928	301-MPG	791440034624	38574P	857123005104	38565S	857123005364
66	791440034983	151-W	791440035935	301-W	791440036987	38575P	857123005111	38566S	857123005371
66-30	791440065857	185-DS	791440035942	500	791440036994	38576P	857123005128	38567S	857123005388
66-W	791440034990	186-SK	791440035997	500-12	791440037007	43562P	857123005135	38568S	857123005395
75	791440035003	200	791440036000	500-15	791440037014	43564P	857123005142	43562S	857123005524
75-21	791440035027	200-15	791440036079	500-BP	791440037021	43566P	857123005159	43564S	857123005531
75-21	791440035027	200-21	791440036130	500-BP22	791440037038	43568P	857123005166	43566S	857123005548
75-W30	791440065819	200-21AL	791440060425	500-MFVBP22	791440088122	43570P	857123005173	43568S	857123005609
85-EK	791440035034	200-21BP	791440036147	501	791440037052	43572P	857123005180	43570S	857123005616
85-P	791440035041	200-21H	791440036154	501-30	791440037069			43572S	857123005623
85-V	791440035058	200-21HBP	791440036161	501-W	791440037076			43573S	857123005647
100	791440035126	200-21M	791440036178	PKG50	791440046399			43574S	857123005630
100-12	791440035157	200-30U	791440036239	PKG400	791440040496				

NOTES



WARNING: These products can expose you to chemicals, including Diisononyl Phthalate, Carbon black extracts, Nickel, 1,3 Butadiene, Ethylene Oxide, Epichlorohydrin, which are known to the State of California to cause cancer, and Bisphenol-A, Ethylene Glycol, Ethylene Oxide, 1,3 Butadiene, Epichlorohydrin, which are known to the State of California to cause birth defects or other reproductive harm. For more information go to www.P65Warnings.ca.gov.

UPC TO BALDWIN (INDIVIDUAL PARTS)

UPC NUMBER	BALDWIN NUMBER	UPC NUMBER	BALDWIN NUMBER	UPC NUMBER	BALDWIN NUMBER	UPC NUMBER	BALDWIN NUMBER	UPC NUMBER	BALDWIN NUMBER
79144000018	B2	791440001053	PT83	791440001954	PT151	791440002791	B220	791440003644	T300-M
79144000025	B2-HPG	791440001060	PT83-MPG	791440001961	PT152	791440002807	BT221	791440003651	B301
79144000049	B4	791440001084	P84-2	791440001978	PT153	791440002814	B222	791440003668	PT302
79144000056	BT5	791440001091	PT85	791440001985	PT154	791440002821	BT223	791440003675	T303-M
79144000063	B6	791440001107	PT86-HD	791440001992	PF155	791440002838	PF224	791440003682	PT304
79144000070	B6-HPG	791440001114	PT87-S	791440002005	B156	791440002852	PF225	791440003705	B307
79144000087	B7	791440001121	PT88-HD	791440002012	B157	791440002876	PF226	791440003712	T308-M
79144000094	B9	791440001138	PT89	791440002036	B159	791440002883	B227	791440003729	B309
79144000100	B10-AL	791440001145	PT90-10	791440002043	B160	791440002890	B228	791440003736	PF311
79144000117	B10-AL BOWL	791440001152	PT90-MPG	791440002050	B161-S	791440002906	B229	791440003743	PF312
79144000124	B10-AL CAP	791440001169	PT91	791440002067	P162	791440002913	BT230	791440003750	PF313
79144000131	PF10	791440001183	PT93	791440002074	B163	791440002920	PF231	791440003767	PF314
79144000148	PF10-CS	791440001190	PT93-MPG	791440002081	B164	791440002937	B233	791440003774	PF316
79144000155	PT11	791440001213	B95	791440002104	B166	791440002951	BT234	791440003781	PT317-MPG
79144000162	PT11-HD	791440001244	B95-MPG	791440002111	B167	791440002968	P235	791440003798	PT318-MPG
79144000179	PT12	791440001251	B96	791440002128	B168	791440002975	B236	791440003804	PT319-MPG
79144000186	BF13	791440001282	B96-MPG	791440002142	P170	791440002982	BT237	791440003811	PT320-MPG
79144000193	P15	791440001299	B97	791440002159	P171	791440002999	BT238	791440003859	BD324
79144000209	S16-1	791440001305	PT98-10	791440002166	P172	791440003002	B239	791440003866	B326
79144000230	P18	791440001312	PT98-MPG	791440002173	B173-S	791440003019	P240	791440003880	B329
79144000247	P18-HD	791440001329	B99	791440002180	P174	791440003026	BT241	791440003897	BF330
79144000254	P19	791440001336	B99-B	791440002203	P176	791440003033	P242	791440003903	PF332
79144000261	P20-HD	791440001350	B99-MPG	791440002210	P177	791440003040	B243	791440003910	B333
79144000315	V24-A2	791440001374	101-30	791440002227	B178	791440003057	B244	791440003927	BT334
79144000339	P25	791440001381	P102	791440002234	B179	791440003071	B246	791440003941	B336
79144000346	P26	791440001398	BD103	791440002258	PT181 KIT	791440003088	B247	791440003958	B337
79144000353	B27	791440001404	P104	791440002265	G183	791440003095	BT248	791440003965	BT338
79144000360	BD28	791440001411	B105	791440002272	P183	791440003101	P249	791440003972	BT339
79144000377	PT29	791440001428	P106	791440002296	P184	791440003118	BT251	791440003989	BT340
79144000384	AFG30	791440001435	P106-HD	791440002302	PT185	791440003125	B252	791440003996	BT341
79144000391	B30	791440001459	PT108	791440002319	P186	791440003132	B253	791440004009	BT342
79144000407	B31	791440001466	PT108-HD	791440002326	P187	791440003149	P254	791440004016	BT343
79144000421	B33	791440001473	B109	791440002340	PT189	791440003156	B255	791440004023	BT344-S
79144000438	B34	791440001480	BC110	791440002357	PT189-MPG	791440003163	PT256	791440004030	BT345 KIT
79144000445	B35-S	791440001497	BT111	791440002364	P190	791440003170	PT257	791440004047	BT346
79144000469	AFG37R	791440001503	BT112	791440002371	PT191	791440003187	PT258	791440004054	BT347
79144000476	B37	791440001510	B113	791440002388	PT191-10	791440003194	BT259	791440004061	BT348
79144000483	AFG38D	791440001527	B114	791440002395	PT191-5	791440003200	BT260	791440004078	BT349
79144000506	B39	791440001534	PT115	791440002418	PT193	791440003217	BT260-10	791440004085	BT350
79144000513	P40	791440001541	P116	791440002425	PT193 KIT	791440003224	BT261	791440004092	BT351
79144000520	P41	791440001558	PF116	791440002432	PT193-3	791440003231	B262	791440004108	P352
79144000537	P42	791440001565	PT117	791440002449	P194	791440003248	B263	791440004115	BT353
79144000544	B43-S	791440001572	PT117-25	791440002456	P194-HD	791440003255	BT264	791440004122	BT354
79144000568	B45	791440001589	B118	791440002463	P194-HD10	791440003262	PT265	791440004139	BT355
79144000582	P47	791440001596	PT119	791440002470	PF194	791440003279	P266	791440004146	P356
79144000599	PT48	791440001602	PT119-5	791440002487	B195	791440003286	BT267	791440004153	BT357
79144000605	B49	791440001619	PT119-HD	791440002494	B196	791440003293	PT268	791440004160	B358
79144000612	B50	791440001626	PT119-HD5	791440002500	B196-MPG	791440003309	PT269	791440004177	BT359
79144000636	P52	791440001640	B120	791440002517	P198	791440003323	P271	791440004184	B360
79144000643	P53	791440001657	PF121	791440002524	B199	791440003347	PT273	791440004191	BT361
79144000650	P54	791440001664	PT122-5	791440002548	B201-S	791440003354	BT274	791440004214	BT364
79144000674	B56	791440001688	BT124	791440002555	B202	791440003361	PT275	791440004221	BT365
79144000711	P60	791440001695	P125	791440002562	P203	791440003378	PT275-10	791440004238	BT365-10
79144000728	PT61-HD	791440001701	BT126	791440002579	P203-HD	791440003385	P276	791440004245	BT366-10
79144000735	PT62	791440001718	B128	791440002586	P203-HD10	791440003408	PT277	791440004252	BT367
79144000742	PT63-1	791440001725	B129	791440002593	P204	791440003415	B279	791440004269	BT367-S
79144000773	PT66-HD	791440001749	B131	791440002609	P204-HD	791440003422	P280	791440004276	BT368
79144000780	P67	791440001756	B132	791440002616	P204-HD10	791440003439	B281	791440004283	B369
79144000797	P68	791440001763	C133-O-W	791440002623	B205	791440003460	PT283	791440004290	PT370
79144000810	PT70	791440001770	C133-W	791440002630	P206	791440003477	PT284	791440004306	BT371-10
79144000834	PT71	791440001787	B134	791440002647	PT207	791440003484	PT285	791440004313	BT371-MPG
79144000858	PT72	791440001794	PT135	791440002654	PT207-10	791440003491	BT287	791440004320	BT372-10
79144000872	P73	791440001817	PT137	791440002661	PT207-HD	791440003507	BT287-10	791440004337	PT373
79144000889	B74	791440001824	PT138-10	791440002678	PT207-HD10	791440003514	PT288-HD	791440004344	PT374
79144000896	B75	791440001831	PT138-25	791440002685	PT208	791440003521	PT288-HD10	791440004351	PT375
79144000902	B76	791440001848	PT139-10	791440002692	PT210	791440003538	PT289	791440004368	PT376
79144000933	B76-MPG	791440001855	P140	791440002708	B211	791440003545	PT289-10	791440004375	PT377
79144000964	PT79	791440001862	B141	791440002715	PT212-5	791440003552	PT290	791440004382	PT377-10
79144000988	P80	791440001879	BD142	791440002722	PT213	791440003576	BT292	791440004399	B378
79144000995	P80-HD	791440001886	B143	791440002739	PT214(2)	791440003590	P294	791440004405	B378-10
79144001015	P81	791440001893	P144	791440002746	BT215	791440003606	B295	791440004412	PT379 KIT
79144001022	P82	791440001909	PT146	791440002753	BT216	791440003613	B296	791440004429	PT380 KIT
79144001039	PT82-HD	791440001923	P148	791440002760	BT217	791440003620	PT298-10	791440004436	PT381
79144001046	PT82-HD10	791440001947	P150	791440002777	B218	791440003637	B299	791440004443	PT382



WARNING: These products can expose you to chemicals, including Diisononyl Phthalate, Carbon black extracts, Nickel, 1,3 Butadiene, Ethylene Oxide, Epichlorohydrin, which are known to the State of California to cause cancer, and Bisphenol-A, Ethylene Glycol, Ethylene Oxide, 1,3 Butadiene, Epichlorohydrin, which are known to the State of California to cause birth defects or other reproductive harm. For more information go to www.P65Warnings.ca.gov.

UPC TO BALDWIN (INDIVIDUAL PARTS)

UPC NUMBER	BALDWIN NUMBER	UPC NUMBER	BALDWIN NUMBER	UPC NUMBER	BALDWIN NUMBER	UPC NUMBER	BALDWIN NUMBER	UPC NUMBER	BALDWIN NUMBER
791440004450	PT383	791440005372	S456	791440006317	PT546	791440007338	PA648	791440008373	PT772
791440004467	PT385	791440005389	PT457-MPG	791440006324	PT548	791440007345	PA649	791440008380	PT773-MPG
791440004474	PT385-E	791440005396	PT459	791440006331	PT549	791440007352	PA650	791440008397	BT774
791440004481	PT386	791440005402	PT461	791440006348	PT550-10	791440007369	PA651	791440008403	BT775
791440004498	BT387	791440005419	PT462	791440006355	PT551-10	791440007376	PA652	791440008410	PT776-MPG
791440004504	BT387-10	791440005426	PT463	791440006379	PT554	791440007383	PA653	791440008427	PT777
791440004511	BT388	791440005457	PT466	791440006386	P555	791440007390	PA654	791440008434	BT778
791440004528	BT388-10	791440005464	PT467-MPG	791440006393	BT556-10	791440007406	PA655	791440008441	BT779
791440004535	BT389	791440005471	PT468-MPG	791440006416	PT558	791440007413	PA656	791440008458	BF781
791440004542	BT389-10	791440005488	PT469	791440006423	PT560 KIT	791440007420	PA657	791440008465	BF782
791440004559	PT390-MPG	791440005495	BT470	791440006430	PT561	791440007437	PA658	791440008472	BF783
791440004566	PT391-MPG	791440005501	PT471	791440006454	PT562-10	791440007475	PA662	791440008489	BF784
791440004573	PT392	791440005518	BT472	791440006461	PT563	791440007505	PA666	791440008496	BF785
791440004580	PT393	791440005525	B474	791440006478	BT564	791440007512	PA669	791440008502	BF786
791440004597	PT394-15	791440005532	PT475	791440006485	PT565	791440007529	PT670	791440008526	BF788
791440004603	BT395	791440005549	P476	791440006492	PT566	791440007536	PT670-E	791440008533	BF789
791440004610	PT396	791440005556	PT477	791440006508	PT567	791440007543	PA671	791440008540	BF790
791440004627	PT397	791440005570	S479	791440006515	PT567-10	791440007550	PA671-1	791440008557	BF791
791440004634	BT398	791440005587	PT480	791440006522	PT568	791440007567	PA675	791440008564	BF792
791440004641	PT400	791440005594	PT480-10	791440006553	PT571	791440007574	PT676	791440008588	BF794
791440004658	PT401-MPG	791440005600	PT480-MPG	791440006577	PT573	791440007581	PA677	791440008595	BF795
791440004665	BT402	791440005617	B481	791440006607	BF577	791440007598	PA678	791440008618	BF797
791440004672	B403	791440005631	PT483	791440006614	PT578	791440007604	PA680	791440008625	BF798
791440004689	B404	791440005655	S485	791440006621	PT579	791440007611	PT685-MPG	791440008632	BF799
791440004696	JC405	791440005662	BT486	791440006676	BF582	791440007628	PA691	791440008670	PF802
791440004702	CU406	791440005679	PT487	791440006683	BF583	791440007635	PA693	791440008694	PF804
791440004719	DF408	791440005693	B488	791440006690	BF584	791440007642	PT694	791440008700	BF805
791440004849	TC413-CP55	791440005709	S489	791440006706	BF584-B	791440007666	PA696	791440008717	BF806
791440004863	V414-B	791440005716	PT490	791440006713	BF585	791440007673	PA697	791440008724	PF807
791440004870	V414-BB	791440005723	PT491	791440006720	BF586	791440007680	PA699	791440008748	PF809
791440004887	F415-F	791440005747	PT491-10	791440006737	BF586-D	791440007727	C704-L	791440008755	PF810
791440004894	P415-10	791440005754	PT492	791440006744	BF587	791440007741	P706-M	791440008762	PF811
791440004900	P415-10A	791440005761	PT493	791440006751	BF587-D	791440007765	PT707-HD	791440008779	BF812
791440004917	P415-25	791440005778	B494	791440006768	BF588	791440007772	PT707-HD10	791440008793	PF814
791440004924	P415-25A	791440005785	B495	791440006874	BF591	791440007789	PT707-HD3	791440008816	PF816
791440004931	P415-5	791440005815	P496	791440006881	BF592	791440007796	PT708-HD	791440008823	PF816-S
791440004948	P415-5A	791440005822	P497	791440006898	BF593	791440007802	PT714	791440008847	PF818
791440004955	P415-5AN	791440005839	PT498	791440006904	PF594	791440007819	PF717	791440008854	PF819
791440004962	P415-GM	791440005846	PT498-10	791440006911	BT595	791440007833	P718-5	791440008861	PF819-HD
791440004979	V415-B	791440005853	PT499-5	791440006928	BF596	791440007840	BF719	791440008878	PF820-S
791440004986	V415-BB	791440005884	F501-MD	791440006935	BF597	791440007857	BF720	791440008885	PF821-S
791440004993	PT416	791440005907	PT503	791440006942	PF598	791440007864	P721	791440008892	PF822
791440005013	PT418	791440005921	PF506	791440006959	PF598-10	791440007871	PT722	791440008908	PF823
791440005037	BT420	791440005938	P507	791440006966	PF598-30	791440007888	P723	791440008953	PF823-E
791440005044	B421	791440005945	PT508-MPG	791440006973	PF599	791440007895	PT725-MPG	791440008960	PF824
791440005051	S423	791440005952	PT509-MPG KIT	791440006980	PF599-10	791440007901	PT727-HD	791440008984	BF825
791440005068	BT424	791440005969	PT510	791440006997	PF599-30	791440007918	PT727-DL	791440008991	PF826
791440005075	BT425	791440005976	PT512	791440007000	PA602	791440007925	PT727-HD10	791440009004	PF827
791440005082	PT426	791440005983	PT513	791440007017	PA604	791440007932	PT728-MPG	791440009028	PF828
791440005099	BT427	791440005990	PT514	791440007024	B605	791440007949	PT729	791440009035	PF829(2)
791440005112	V429-B	791440006003	PT515	791440007048	PA607	791440007970	BT732	791440009042	BF830
791440005129	V429-BB	791440006010	PT516	791440007086	PA612	791440007994	BT735	791440009059	PF831
791440005136	PT430-BB	791440006027	PT517	791440007093	PA613	791440008014	PT737	791440009073	BF833
791440005143	PT431	791440006034	PT518	791440007109	BF614	791440008021	PT737-10	791440009080	BF833-K2
791440005150	PT433	791440006041	PT518-10	791440007116	PA615	791440008038	V738-O	791440009097	BF834-F
791440005167	PT434	791440006058	PT520	791440007123	PA616	791440008045	BT739	791440009103	PF834
791440005174	PT434-10	791440006072	BT521	791440007130	PA617	791440008052	C740-S	791440009127	BF836
791440005181	PT435	791440006089	PT522	791440007147	PA618	791440008144	C750-E	791440009134	BF836-K3
791440005198	PT436	791440006096	BT525	791440007154	PA618 FOAM	791440008151	C750-L	791440009141	BF836-K4
791440005204	PT437	791440006102	BT526	791440007161	PA618-S	791440008168	C750-L SINGLE	791440009158	BF837
791440005211	BT438	791440006119	BT526-10	791440007185	PA621	791440008175	PT751	791440009165	BF838-F2
791440005228	PT439	791440006126	PT527	791440007192	PA625	791440008182	PT752	791440009172	PF838
791440005235	BT440	791440006133	P528	791440007208	PA631	791440008199	PT753	791440009189	BT839
791440005242	PT441	791440006140	P529	791440007215	PA632	791440008212	PT757	791440009196	BT839-10
791440005259	PT442-MPG	791440006188	PT534	791440007222	PA633(2)	791440008229	PT757-10	791440009202	BF840
791440005266	BT443	791440006195	PT535	791440007239	PA634	791440008243	PT760-10	791440009219	BF840-K1
791440005273	PT445-MPG	791440006201	BT536	791440007246	PA638	791440008250	PT760-25	791440009233	VT842-O
791440005280	P446	791440006218	P537	791440007253	PA639	791440008267	PT761	791440009240	BF843
791440005297	B447	791440006225	PT538	791440007260	PA640	791440008281	PT763	791440009257	BF844-A
791440005310	P450	791440006232	PT539	791440007277	PA641	791440008298	PT764	791440009264	BF845-A
791440005327	S451	791440006249	P540	791440007284	PA642	791440008304	PT765	791440009271	PF845
791440005334	BT452	791440006263	BT541	791440007291	PA643	791440008311	PT766	791440009288	PF846
791440005358	P454	791440006287	PT543 KIT	791440007307	PA644	791440008328	PT767	791440009295	PF847
791440005365	S455	791440006300	P545	791440007314	PA645	791440008335	PT768	791440009318	PT849



WARNING: These products can expose you to chemicals, including Diisononyl Phthalate, Carbon black extracts, Nickel, 1,3 Butadiene, Ethylene Oxide, Epichlorohydrin, which are known to the State of California to cause cancer, and Bisphenol-A, Ethylene Glycol, Ethylene Oxide, 1,3 Butadiene, Epichlorohydrin, which are known to the State of California to cause birth defects or other reproductive harm. For more information go to www.P65Warnings.ca.gov.

UPC TO BALDWIN (INDIVIDUAL PARTS)

UPC NUMBER	BALDWIN NUMBER	UPC NUMBER	BALDWIN NUMBER	UPC NUMBER	BALDWIN NUMBER	UPC NUMBER	BALDWIN NUMBER	UPC NUMBER	BALDWIN NUMBER
79144009325	PT849-10	791440010413	BF941	791440011595	BF1223	791440012585	PA1632	791440013377	PA1712
79144009356	V852-O	791440010420	PF942	791440011601	BF1225	791440012608	PA1633	791440013391	PA1718
79144009363	BF853	791440010437	PF943	791440011618	BF1226	791440012615	LL1634	791440013407	PA1719
79144009387	BF855	791440010451	PF945	791440011632	BF1232	791440012622	PA1634	791440013414	PA1721
79144009394	BF856	791440010468	PF946	791440011649	BF1233	791440012639	PA1635	791440013421	PA1726
79144009400	PF857	791440010475	PF947	791440011670	V1240-C	791440012646	LL1636-FN	791440013445	PA1735
79144009417	BF858	791440010482	BF948	791440011694	BF1259	791440012653	PA1636-FN	791440013469	PA1748
79144009424	PF859	791440010512	BF948-JD	791440011700	BF1276	791440012660	LL1637-FN	791440013476	PA1749-FN
79144009431	PF860	791440010529	PF949	791440011717	BF1280	791440012677	PA1637-FN	791440013483	PA1750-FN
79144009448	PF861	791440010536	F950-F	791440011731	FB1301	791440012684	PA1639	791440013490	PA1752-FN
79144009455	BF862	791440010543	PF950	791440011748	FB1302	791440012691	PA1641	791440013506	PA1753-FN
79144009462	BF863	791440010550	PT951	791440011755	OB1303	791440012707	LL1642-Z	791440013513	PA1754
79144009479	PF864	791440010567	PF952	791440011762	FK1304	791440012714	PA1642-Z	791440013520	PA1755-FN
79144009486	BF865	791440010574	BF954	791440011779	OB1305	791440012721	PA1643	791440013537	PA1757
79144009493	BF865-K	791440010581	BF955	791440011786	FB1307	791440012738	PA1644	791440013544	PA1758
79144009509	PF866	791440010598	BF956	791440011793	OB1308	791440012745	F1645-DS	791440013551	PA1763
79144009523	BF868	791440010604	BF957	791440011809	FB1309	791440012752	V1645-C	791440013568	PA1765
79144009530	PF869	791440010628	BF957-D	791440011816	FB1310	791440012769	LL1646-FN	791440013575	PA1765 FOAM
79144009554	PF872	791440010635	BF958	791440011823	FB1311	791440012776	PA1646	791440013582	PA1768
79144009561	BF873	791440010642	BF959	791440011830	OB1313	791440012783	PA1646-FN	791440013599	PA1769
79144009578	BF874	791440010659	P960	791440011847	OB1314	791440012790	PA1647	791440013612	PA1771
79144009592	BF876	791440010673	BF962	791440011854	OB1315	791440012806	PA1648	791440013629	PA1772
79144009615	BF877	791440010680	PF963	791440011861	OB1316	791440012813	LL1649	791440013636	PA1773
79144009646	BF879	791440010697	BF964	791440011878	OB1317	791440012820	PA1649	791440013643	PA1774
79144009660	BF881	791440010710	BF966	791440011885	OB1318	791440012837	PA1650-FN	791440013650	PA1775
79144009677	PF882	791440010727	PF967	791440011892	OB1319	791440012851	PA1653	791440013667	PA1776
79144009684	PF883	791440010734	BF968	791440011908	OB1320	791440012868	V1656-O	791440013674	PA1777
79144009691	BF884	791440010741	BF970	791440011953	VG1325	791440012875	V1656-T	791440013681	PA1778
79144009707	BF885	791440010758	BF971	791440011960	PG1326	791440012882	PA1657	791440013698	PA1779
79144009714	BF886	791440010772	BF974-D	791440012011	OB1368	791440012899	PA1661(3)	791440013704	PA1780
79144009721	BF888	791440010789	B975	791440012028	OB1369	791440012905	PA1663	791440013711	PA1781
79144009745	BF890	791440010796	BF976	791440012035	B1400	791440012912	PA1664	791440013728	PA1782
79144009752	BF891	791440010819	BF978	791440012059	B1402	791440012929	PA1666	791440013735	PA1783
79144009769	BF892	791440010826	BF979	791440012080	B1406	791440012936	LL1667-FN	791440013742	PA1784
79144009776	PF893	791440010833	BF980	791440012097	B1407	791440012943	PA1667-FN	791440013759	PA1786
79144009783	PF893-RV	791440010840	PF981	791440012127	B1428	791440012950	LL1669	791440013766	PA1787
79144009790	PF894	791440010864	BF984	791440012172	P1510	791440012967	PA1669	791440013773	PA1788
79144009806	PF894-RV	791440010871	PF986	791440012189	P1511	791440012974	PA1670	791440013780	PA1789
79144009820	BF896	791440010888	PF987	791440012196	V1520-R	791440012981	PA1673	791440013797	PA1790
79144009837	BF897 KIT	791440010895	BF988	791440012219	V1542-C	791440012998	PA1674	791440013803	PA1794-FN
79144009844	SF898	791440010901	BF989	791440012226	V1544-T	791440013001	PA1675	791440013810	PA1795
79144009851	PF899	791440010925	BF991	791440012233	PA1600	791440013018	LL1676-FN	791440013827	PA1797
79144009868	BF900	791440010932	BF992	791440012240	PA1602	791440013025	PA1676-FN	791440013834	PA1798
79144009899	PF902	791440010956	BF995	791440012257	PA1603	791440013032	PA1679	791440013841	PA1800
79144009905	PF902-S	791440010963	P996	791440012264	PA1606	791440013049	PA1680	791440013865	PA1802
79144009912	PT903	791440010970	P998	791440012271	PA1607	791440013056	LL1681-FN	791440013889	PA1805
79144009950	PF906	791440010994	P999-HD	791440012288	LL1608	791440013063	PA1681-FN	791440013896	PA1806
79144009967	PF907	791440011038	V1009-W	791440012295	PA1608	791440013070	PA1682	791440013919	PA1809
79144009974	F908-A	791440011069	V1044-O	791440012301	PA1609	791440013087	PA1683	791440013926	PA1810
79144009981	BF909	791440011076	BF1102	791440012318	PA1610	791440013094	PA1684	791440013940	PA1814
79144009998	PF910	791440011090	BF1104	791440012325	PA1613	791440013100	PA1686	791440013957	PA1815
791440010024	BF912	791440011106	BF1105	791440012332	PA1613-S	791440013117	PA1687	791440013964	PA1816
791440010031	PF913	791440011144	BF1110	791440012349	LL1614	791440013124	PA1688	791440013971	PA1817
791440010048	BF914	791440011182	BF1123	791440012356	PA1614	791440013131	PA1689	791440013988	PA1818
791440010055	BF915	791440011250	BF1140	791440012363	LL1615	791440013148	LL1690-FN	791440013995	PA1819
791440010062	F916-C	791440011281	BF1148	791440012370	PA1615	791440013155	PA1690-FN	791440014008	PA1821
791440010079	PF916	791440011298	BF1150	791440012394	PA1618	791440013162	PA1692	791440014015	PA1822-FN
791440010109	BF918-K	791440011342	BF1160	791440012400	PA1619	791440013179	PA1696	791440014022	PA1823
791440010147	F919-C	791440011366	BF1163	791440012417	PA1620	791440013186	PA1697	791440014039	PA1824
791440010192	BF920	791440011380	BF1166	791440012424	PA1620-S	791440013193	PA1698	791440014046	PA1825
791440010239	PF924	791440011427	BF1170	791440012431	LL1621-Z	791440013209	PA1699-FN	791440014053	PA1826
791440010246	BF925	791440011434	BF1171	791440012448	PA1621	791440013216	PA1700	791440014060	PA1827
791440010253	PF926	791440011441	BF1201	791440012455	PA1621-2	791440013230	PA1701	791440014077	PA1828
791440010277	BF928	791440011472	BF1210	791440012462	PA1621-S	791440013247	PA1701 ELE	791440014084	PA1830-FN
791440010284	BF929	791440011489	BF1211	791440012486	PA1625	791440013254	PA1701 FOAM	791440014091	PA1831
791440010291	BF930	791440011496	BF1212	791440012493	LL1626-2	791440013261	PA1702	791440014107	PA1832
791440010321	BF932	791440011502	BF1212 FOAM	791440012509	PA1626	791440013285	PA1702 FOAM	791440014114	PA1834
791440010338	BF933	791440011526	BF1213	791440012516	PA1626-2	791440013292	PA1703	791440014121	PA1836
791440010352	PF935	791440011533	BF1214	791440012523	PA1627	791440013315	PA1704	791440014138	PA1837-FN
791440010369	PF936	791440011540	BF1216	791440012530	PA1629-S	791440013322	PA1705-2	791440014152	PA1840
791440010376	PF937	791440011557	BF1218	791440012547	LL1630-2	791440013339	PA1706	791440014169	PA1841
791440010383	BF938	791440011564	BF1219	791440012554	PA1630	791440013346	PA1707-FN	791440014176	PA1845
791440010390	BF939	791440011571	BF1220	791440012561	PA1630-2	791440013353	PA1709	791440014183	LL1846
791440010406	BF940	791440011588	BF1221	791440012578	PA1631-S	791440013360	PA1710	791440014190	PA1846



WARNING: These products can expose you to chemicals, including Diisononyl Phthalate, Carbon black extracts, Nickel, 1,3 Butadiene, Ethylene Oxide, Epichlorohydrin, which are known to the State of California to cause cancer, and Bisphenol-A, Ethylene Glycol, Ethylene Oxide, 1,3 Butadiene, Epichlorohydrin, which are known to the State of California to cause birth defects or other reproductive harm. For more information go to www.P65Warnings.ca.gov.

UPC TO BALDWIN (INDIVIDUAL PARTS)

UPC NUMBER	BALDWIN NUMBER	UPC NUMBER	BALDWIN NUMBER	UPC NUMBER	BALDWIN NUMBER	UPC NUMBER	BALDWIN NUMBER	UPC NUMBER	BALDWIN NUMBER
791440014213	PA1847-FN	791440015050	PA1952	791440016064	PA2092	791440017344	PA2256	791440018143	PA2372
791440014220	PA1848	791440015067	PA1953	791440016071	PA2093	791440017351	PA2257	791440018167	PA2374
791440014237	PA1849	791440015081	PA1956-FN	791440016088	PA2094	791440017368	PA2300	791440018174	PA2375
791440014244	PA1850-FN	791440015098	PA1957	791440016095	PA2095	791440017375	PA2301	791440018181	PA2376
791440014251	PA1851	791440015104	PA1960	791440016101	PA2096	791440017382	PA2302-FN	791440018198	PA2377
791440014268	PA1852	791440015111	PA1961	791440016118	PA2099	791440017399	PA2303	791440018204	PA2378
791440014299	PA1857	791440015128	PA1963	791440016125	PA2100	791440017405	PA2304-FN	791440018211	PA2379
791440014305	PA1858	791440015135	PA1967	791440016132	PA2101A	791440017412	PA2305	791440018228	PA2379-K
791440014312	PA1859	791440015142	PA1969	791440016149	PA2102	791440017429	PA2306	791440018235	PA2380-FN
791440014329	PA1860	791440015166	PA1972	791440016156	PA2103	791440017436	PA2307	791440018242	PA2381
791440014336	PA1861	791440015173	PA1973	791440016163	PA2104	791440017443	PA2308	791440018266	PA2382
791440014343	PA1863	791440015197	PA1975	791440016187	PA2106	791440017467	PA2310	791440018273	PA2383
791440014367	PA1864-FN	791440015203	PA1976	791440016194	PA2107	791440017474	LL2312	791440018280	LL2384
791440014374	PA1865-FN	791440015210	PA1977-FN	791440016217	PA2109	791440017481	PA2312	791440018297	PA2384
791440014381	PA1866	791440015227	PA1978-FN	791440016224	PA2110	791440017498	PA2313	791440018303	PA2385
791440014398	PA1867	791440015241	PA1979-FN	791440016255	PA2113	791440017504	PA2314	791440018310	PA2386
791440014404	PA1868	791440015265	PA1980-FN	791440016262	PA2114	791440017511	PA2315	791440018327	PA2387
791440014411	PA1873	791440015272	PA1981	791440016279	PA2115	791440017535	PA2316	791440018334	PA2388
791440014428	V1874-T	791440015289	PA1982	791440016286	PA2116	791440017542	LL2317	791440018358	PA2389-FN
791440014435	PA1875	791440015296	PA1985	791440016293	PA2117	791440017559	PA2317	791440018365	PA2390
791440014442	PA1877	791440015302	PA1986	791440016323	PA2121	791440017566	LL2318	791440018372	PA2391
791440014459	PA1880	791440015319	PA1986-K	791440016354	PA2124	791440017573	PA2318	791440018389	PA2392
791440014466	PA1881	791440015326	PA1987	791440016361	PA2125	791440017580	PA2319	791440018396	LL2393
791440014473	PA1882	791440015333	PA1989-FN	791440016385	PA2127	791440017597	PA2320-FN	791440018402	PA2393
791440014480	PA1883-FN	791440015340	LL1992	791440016453	PA2134	791440017603	PA2321	791440018419	PA2394
791440014497	LL1884	791440015371	PA1992-FN	791440016460	PA2135	791440017610	PA2322	791440018426	PA2395
791440014503	PA1884	791440015388	PA1995	791440016477	PA2136	791440017627	PA2323	791440018433	PA2396
791440014510	LL1885	791440015395	PA1996	791440016491	PA2138	791440017641	LL2326	791440018440	PA2397
791440014527	PA1885	791440015401	PA1997	791440016507	PA2139	791440017658	PA2326	791440018457	PA2398
791440014534	LL1886	791440015418	PA1998	791440016514	PA2140	791440017672	PA2328	791440018464	PA2399
791440014541	PA1886	791440015425	PA2001	791440016576	PA2147	791440017689	PA2329	791440018488	PA2401
791440014565	PA1888	791440015432	PA2002	791440016583	PA2148	791440017696	LL2330	791440018495	PA2402
791440014572	PA1889	791440015456	PA2005	791440016590	PA2149	791440017702	PA2330	791440018501	PA2403
791440014589	PA1891	791440015463	PA2006	791440016606	PA2150	791440017719	PA2331	791440018518	PA2404
791440014596	PA1892-FN	791440015470	PA2007	791440016620	PA2152	791440017726	PA2332	791440018525	PA2405
791440014602	PA1893	791440015487	PA2008	791440016637	PA2153	791440017733	LL2333	791440018532	PA2406
791440014619	LL1894	791440015494	PA2009	791440016644	PA2154	791440017740	PA2333	791440018549	PA2407
791440014626	PA1894	791440015500	PA2010	791440016668	PA2156	791440017757	PA2335	791440018556	PA2408
791440014633	LL1895	791440015531	PA2023	791440016675	PA2157	791440017764	PA2337	791440018563	PA2409
791440014640	PA1895	791440015548	PA2024	791440016682	PA2158	791440017771	PA2338-FN	791440018570	PA2410
791440014657	PA1896	791440015562	SA2027	791440016699	SA2159	791440017788	PA2339	791440018587	PA2411
791440014664	PA1897	791440015579	PA2031	791440016705	PA2160	791440017795	PA2340	791440018594	PA2412
791440014671	PA1898	791440015609	PA2036	791440016729	PA2162	791440017801	PA2341	791440018600	PA2413
791440014688	PA1899	791440015616	PA2037	791440016736	PA2163	791440017818	PA2342	791440018617	PA2414
791440014695	PA1900	791440015623	PA2038	791440016743	PA2164	791440017825	PA2343	791440018624	PA2415
791440014701	PA1901	791440015630	SA2039	791440016774	PA2167	791440017832	LL2344-FN	791440018631	PA2417-FN
791440014718	LL1902-FN	791440015647	PA2041	791440016781	PA2168	791440017849	PA2344-FN	791440018648	LL2418-FN
791440014725	PA1902-FN	791440015654	PA2042	791440016798	PA2169	791440017856	PA2345	791440018655	PA2418-FN
791440014732	PA1904	791440015661	PA2044	791440016811	PA2171	791440017863	PA2346	791440018662	PA2419
791440014749	PA1905	791440015692	PA2050	791440016880	PA2178	791440017870	PA2347	791440018679	PA2420
791440014756	PA1906	791440015708	PA2051	791440016910	PA2181	791440017894	PA2349-FN	791440018686	PA2421
791440014763	PA1907-FN	791440015715	PA2052	791440016927	PA2182	791440017900	PA2350	791440018693	PA2422
791440014770	PA1909	791440015722	PA2053	791440016934	PA2183	791440017917	PA2351	791440018709	PA2423
791440014787	PA1911	791440015777	PA2061	791440016972	PA2189	791440017924	PA2352	791440018716	LL2425
791440014794	PA1912	791440015791	PA2063	791440016996	PA2191	791440017931	PA2353	791440018723	PA2425
791440014800	PA1913	791440015807	PA2064	791440017009	PA2192	791440017948	PA2354	791440018730	LL2426-FN
791440014817	PA1915	791440015814	PA2065	791440017016	PA2193	791440017955	PA2356	791440018747	PA2426-FN
791440014824	PA1916	791440015838	PA2067	791440017023	PA2194	791440017979	PA2357	791440018754	PA2427
791440014831	PA1919-FN	791440015845	PA2068	791440017047	PA2196	791440017986	LL2358	791440018761	PA2428
791440014848	PA1920	791440015852	PA2069	791440017085	PA2201	791440017993	PA2358	791440018778	PA2429
791440014855	PA1921	791440015869	PA2070	791440017115	PA2204	791440018006	PA2359	791440018785	PA2430
791440014879	PA1922	791440015876	PA2071	791440017146	PA2207	791440018013	LL2360-FN	791440018792	PA2431
791440014886	PA1922-FN	791440015883	PA2072	791440017153	PA2208	791440018020	PA2360-FN	791440018808	PA2432
791440014916	PA1926	791440015890	PA2073	791440017191	PA2212	791440018037	LL2361	791440018815	PA2433
791440014923	PA1932	791440015906	PA2074	791440017214	PA2214	791440018044	PA2361	791440018822	PA2434
791440014930	PA1934	791440015913	PA2075	791440017221	PA2215	791440018051	PA2362	791440018839	PA2435
791440014947	PA1936	791440015920	PA2076	791440017238	PA2216	791440018068	LL2363	791440018846	PA2436
791440014954	PA1937	791440015937	PA2077	791440017252	PA2218	791440018075	PA2363	791440018853	PA2437
791440014961	PA1940	791440015951	PA2079	791440017283	PA2221	791440018082	PA2364	791440018877	PA2438
791440014978	PA1941-FN	791440015968	PA2081	791440017290	PA2222	791440018099	PA2367	791440018884	LL2439
791440015005	PA1945	791440015982	PA2083	791440017306	PA2223	791440018105	PA2368	791440018891	PA2439
791440015012	PA1946	791440015999	SA2084	791440017313	PA2224	791440018112	PA2369	791440018907	PA2440
791440015029	PA1949	791440016002	SA2085	791440017320	PA2225	791440018129	PA2370	791440018914	PA2441
791440015043	PA1951	791440016057	PA2091	791440017337	PA2226	791440018136	PA2371	791440018921	PA2442



WARNING: These products can expose you to chemicals, including Diisononyl Phthalate, Carbon black extracts, Nickel, 1,3 Butadiene, Ethylene Oxide, Epichlorohydrin, which are known to the State of California to cause cancer, and Bisphenol-A, Ethylene Glycol, Ethylene Oxide, 1,3 Butadiene, Epichlorohydrin, which are known to the State of California to cause birth defects or other reproductive harm. For more information go to www.P65Warnings.ca.gov.

UPC TO BALDWIN (INDIVIDUAL PARTS)

UPC NUMBER	BALDWIN NUMBER	UPC NUMBER	BALDWIN NUMBER	UPC NUMBER	BALDWIN NUMBER	UPC NUMBER	BALDWIN NUMBER	UPC NUMBER	BALDWIN NUMBER
791440018938	PA2443	791440019744	PA2516	791440020603	PA2588	791440021426	PA2661	791440022287	PA2740
791440018945	PA2444	791440019751	PA2517	791440020610	PA2589-FN	791440021433	PA2662	791440022300	PA2742
791440018952	PA2445	791440019768	LL2518	791440020634	PA2591	791440021457	PA2663-FN	791440022317	PA2743
791440018969	PA2446	791440019775	PA2518	791440020641	PA2592	791440021464	PA2664	791440022324	PA2744
791440018976	LL2447-FN	791440019782	PA2519	791440020658	PA2593	791440021471	PA2665	791440022331	PA2745
791440018983	PA2447-FN	791440019805	PA2520	791440020672	PA2595	791440021488	PA2666	791440022348	PA2746
791440018990	PA2448	791440019812	LL2521	791440020696	PA2596	791440021495	LL2667	791440022355	PA2747
791440019010	PA2450	791440019829	PA2521	791440020719	PA2598	791440021501	PA2667	791440022362	PA2748
791440019027	PA2451	791440019836	PA2522	791440020726	PA2599	791440021518	PA2668	791440022386	PA2749
791440019034	PA2452	791440019843	PA2523	791440020733	PA2600	791440021525	PA2669-FN	791440022393	PA2750
791440019041	LL2453	791440019850	PA2524-FN	791440020740	PA2601	791440021532	PA2670	791440022409	PA2751
791440019058	PA2453	791440019867	LL2525	791440020757	PA2602	791440021556	PA2672	791440022416	PA2752
791440019065	PA2454	791440019874	PA2525	791440020771	PA2604	791440021563	PA2673	791440022423	PA2753
791440019072	PA2455	791440019881	PA2526	791440020788	PA2605	791440021570	PA2674	791440022430	PA2754
791440019089	LL2456	791440019898	PA2527	791440020795	PA2606	791440021594	PA2675	791440022447	PA2755
791440019096	PA2456	791440019904	PA2528	791440020801	PA2607	791440021600	LL2676	791440022454	PA2756
791440019102	PA2457	791440019911	PA2529	791440020818	LL2608	791440021617	PA2676	791440022461	PA2757
791440019119	LL2458	791440019928	PA2530	791440020825	PA2608	791440021624	PA2677	791440022478	PA2761
791440019126	PA2458	791440019942	PA2531	791440020832	LL2609	791440021631	PA2678	791440022485	PA2763
791440019133	PA2459	791440019966	PA2532	791440020849	PA2609	791440021655	PA2679	791440022492	PA2767
791440019140	PA2460	791440019980	PA2533	791440020856	PA2610	791440021662	PA2680	791440022508	PA2772
791440019164	PA2461	791440019997	PA2534	791440020863	PA2611	791440021693	PA2684-FN	791440022515	PA2773
791440019171	PA2462	791440020009	PA2535	791440020870	PA2612	791440021709	LL2685	791440022522	PA2774
791440019188	PA2463	791440020016	PA2536	791440020887	PA2613	791440021730	PA2687	791440022539	PA2775
791440019195	PA2464	791440020023	PA2538	791440020894	PA2614	791440021747	LL2688	791440022546	PA2776
791440019218	PA2465	791440020030	PA2539	791440020900	PA2615	791440021754	PA2688	791440022553	PA2777
791440019225	PA2466	791440020047	PA2540	791440020917	PA2616	791440021761	PA2689	791440022560	PA2778-FN
791440019232	PA2467	791440020054	PA2541-FN	791440020924	PA2617	791440021778	PA2690	791440022577	LL2779
791440019249	PA2468	791440020061	PA2542	791440020931	LL2618	791440021785	PA2691	791440022584	PA2779
791440019256	PA2469	791440020085	PA2544	791440020948	PA2618	791440021792	PA2692	791440022607	PA2781
791440019263	PA2472	791440020092	PA2545	791440020955	PA2619	791440021808	PA2693	791440022614	PA2782
791440019270	PA2473	791440020108	PA2546	791440020962	PA2620	791440021815	PA2694	791440022638	PA2783
791440019287	PA2474	791440020115	PA2547	791440020979	PA2621	791440021839	PA2696	791440022645	PA2784
791440019294	PA2475	791440020122	PA2548	791440020986	PA2622	791440021846	PA2698	791440022652	PA2785
791440019300	PA2476	791440020139	PA2549	791440020993	PA2623	791440021860	PA2699	791440022669	PA2786
791440019317	PA2477	791440020146	PA2550	791440021006	PA2624	791440021877	PA2700	791440022676	PA2787
791440019324	PA2478	791440020153	PA2551	791440021013	PA2625	791440021884	PA2701	791440022683	PA2788
791440019331	PA2479	791440020160	PA2552	791440021020	PA2626	791440021891	PA2702	791440022690	PA2789
791440019348	PA2481	791440020177	PA2553	791440021037	PA2627	791440021907	PA2703	791440022706	PA2790-FN
791440019355	LL2482	791440020184	PA2554	791440021044	PA2628	791440021914	PA2704	791440022713	PA2791
791440019362	PA2482	791440020207	PA2555	791440021051	PA2629	791440021921	PA2705	791440022720	PA2792
791440019379	PA2483	791440020221	PA2556	791440021068	PA2630	791440021938	PA2706	791440022737	PA2793
791440019386	PA2484	791440020238	LL2557	791440021075	PA2631	791440021945	PA2707	791440022744	PA2794
791440019393	PA2485	791440020245	PA2557	791440021082	PA2632	791440021952	PA2708	791440022768	PA2796
791440019409	PA2486	791440020269	PA2558	791440021099	PA2633-FN	791440021969	PA2709	791440022775	PA2797
791440019416	PA2487	791440020276	LL2559	791440021105	PA2634	791440021976	PA2710	791440022782	PA2798
791440019423	PA2488-FN	791440020283	PA2559	791440021112	PA2635-FN	791440021983	PA2711	791440022799	PA2799
791440019430	PA2489	791440020313	LL2562	791440021129	PA2636	791440021990	PA2712	791440022805	PA2801
791440019447	PA2490	791440020320	PA2562	791440021136	PA2637	791440022003	PA2713	791440022812	PA2803
791440019454	PA2491	791440020337	PA2563	791440021143	PA2638	791440022010	PA2714	791440022836	PA2805
791440019478	LL2493	791440020344	PA2564	791440021150	PA2640	791440022027	PA2715	791440022843	PA2806
791440019485	PA2493	791440020368	PA2566	791440021174	PA2641	791440022034	PA2716	791440022850	PA2807
791440019508	PA2494	791440020375	PA2567	791440021181	LL2642	791440022041	PA2717	791440022867	PA2812
791440019515	PA2495	791440020382	PA2568	791440021198	PA2642	791440022058	PA2718	791440022874	PA2814
791440019522	PA2496	791440020399	PA2569	791440021204	PA2643	791440022065	PA2719	791440022881	PA2815
791440019539	PA2497	791440020405	PA2570	791440021211	PA2644	791440022089	PA2721	791440022898	PA2816
791440019546	PA2498	791440020412	PA2571	791440021228	PA2645	791440022096	PA2722	791440022904	PA2817
791440019553	PA2499	791440020429	PA2572	791440021235	PA2646	791440022102	PA2723	791440022911	PA2818
791440019560	PA2500	791440020436	PA2573	791440021242	PA2647	791440022119	PA2724	791440022928	PA2819
791440019584	PA2502	791440020443	PA2574	791440021259	PA2648	791440022126	PA2725	791440022935	PA2820
791440019591	LL2503	791440020450	LL2575	791440021266	PA2649	791440022133	PA2726	791440022942	PA2821
791440019607	PA2503	791440020467	PA2575	791440021273	PA2650	791440022140	PA2727	791440022959	PA2822
791440019614	PA2504	791440020474	PA2576	791440021280	PA2651	791440022157	PA2728	791440022966	PA2823
791440019621	LL2507	791440020481	PA2577	791440021297	PA2652	791440022164	PA2729	791440022973	PA2824
791440019638	PA2507	791440020498	PA2578	791440021303	PA2653	791440022171	PA2730	791440022980	PA2825
791440019645	PA2508	791440020504	PA2579	791440021310	PA2653 FOAM	791440022188	PA2731	791440022997	PA2826
791440019652	PA2509	791440020511	PA2580	791440021327	PA2654	791440022195	PA2732	791440023000	PA2827
791440019669	PA2510	791440020528	PA2581	791440021334	PA2655	791440022202	PA2733	791440023017	PA2828
791440019676	PA2511	791440020535	LL2582	791440021358	PA2656	791440022225	PA2734	791440023024	PA2829
791440019683	PA2512	791440020542	PA2582	791440021365	PA2657-FN	791440022232	PA2735	791440023031	PA2830
791440019690	PA2513	791440020559	PA2583	791440021372	PA2658	791440022249	PA2736	791440023048	PA2831
791440019706	PA2514	791440020573	PA2585	791440021396	PA2659	791440022256	PA2737	791440023055	PA2832
791440019720	PA2515	791440020580	PA2586	791440021402	PA2660	791440022263	PA2738	791440023062	PA2833
791440019737	LL2516	791440020597	PA2587	791440021419	LL2661	791440022270	PA2739	791440023079	PA2834



WARNING: These products can expose you to chemicals, including Diisononyl Phthalate, Carbon black extracts, Nickel, 1,3 Butadiene, Ethylene Oxide, Epichlorohydrin, which are known to the State of California to cause cancer, and Bisphenol-A, Ethylene Glycol, Ethylene Oxide, 1,3 Butadiene, Epichlorohydrin, which are known to the State of California to cause birth defects or other reproductive harm. For more information go to www.P65Warnings.ca.gov.

UPC TO BALDWIN (INDIVIDUAL PARTS)

UPC NUMBER	BALDWIN NUMBER	UPC NUMBER	BALDWIN NUMBER	UPC NUMBER	BALDWIN NUMBER	UPC NUMBER	BALDWIN NUMBER	UPC NUMBER	BALDWIN NUMBER
791440023086	PA2835	791440025974	PA3482	791440027060	BW5137	791440029378	H9037	791440030664	G107
791440023093	PA2836	791440025981	PA3486	791440027077	BW5138	791440029385	H9039	791440030718	G115-A
791440023109	PA2837	791440025998	PA3487	791440027084	BW5139	791440029408	H9041	791440030725	G115-MSB
791440023116	PA2839	791440026001	PA3492	791440027091	BW5140	791440029415	H9042	791440030756	G120-A
791440023123	PA2843	791440026018	PA3495	791440027107	BW5141	791440029422	H9043	791440030787	G123
791440023130	PA2844	791440026025	PA3496	791440027121	B5176	791440029439	H9044	791440030817	G127
791440023147	PA2845	791440026032	PA3497	791440027138	B5177	791440029446	H9045	791440030855	G132
791440023154	PA2846-FN	791440026049	PA3498	791440027145	BW5178	791440029453	H9046	791440030862	G133
791440023161	PA2848	791440026056	RS3501	791440027152	BW5179	791440029460	H9047	791440030923	G140-A
791440023178	PA2849	791440026063	RS3502	791440027183	BF5801	791440029477	H9048	791440030954	G143
791440023192	PA2851	791440026070	RS3503	791440027190	BF5800	791440029484	H9049	791440030961	G144
791440023208	PA2852	791440026087	RS3504	791440027206	BF5810	791440029491	H9050	791440030978	G147-A
791440023215	PA2853	791440026094	RS3505	791440027213	BF5812	791440029507	H9051	791440030985	G148
791440023222	PA2854	791440026100	RS3506	791440027220	BF5813	791440029521	H9054	791440031005	G153
791440023239	PA2855	791440026117	RS3507	791440027305	6020	791440029538	H9055	791440031012	G154
791440023246	PA2856	791440026124	RS3508	791440027312	6021	791440029545	H9056	791440031029	G155
791440023253	PA2857	791440026131	RS3509	791440027725	BK6380	791440029552	H9057	791440031036	G157
791440023260	PA2858	791440026148	RS3510	791440028081	BK6561	791440029569	H9058	791440031074	G161
791440023277	PA2861	791440026155	RS3511	791440028098	BK6562	791440029576	H9060	791440031081	G162
791440023291	RS2863	791440026162	RS3512	791440028128	BK6600	791440029583	H9062	791440031098	G164-A
791440023307	PA2865	791440026179	RS3513	791440028135	BK6601	791440029590	H9069	791440031104	G165
791440023321	PA2874	791440026186	RS3514	791440028203	BK6610	791440029606	H9070	791440031128	G168-B
791440023338	PA2875	791440026193	RS3515	791440028241	BK6700	791440029613	H9071	791440031135	G169
791440023345	PA2876	791440026209	RS3516	791440028265	BK6710	791440029620	H9072	791440031159	G171
791440023352	PA2900	791440026278	PA3551	791440028296	BK6720	791440029637	H9073	791440031173	G172-A
791440023369	PA2902	791440026285	PA3554	791440028302	BK6721	791440029644	H9074	791440031180	G173-C
791440023376	PA2932	791440026292	PA3555	791440028319	BK6722	791440029651	H9075	791440031227	G184-A
791440023383	PA2933	791440026308	PA3556	791440028326	BK6723	791440029668	H9076	791440031265	G193
791440023390	PA2935	791440026315	PA3557-FN	791440028333	BK6780	791440029675	H9077	791440031289	G196-B
791440023406	PA2936	791440026322	PA3558	791440028487	P7003	791440029682	H9078	791440031319	G202
791440023413	PA2938	791440026339	PA3559	791440028494	B7004	791440029699	H9079	791440031326	G203
791440023444	PA2944-FN	791440026346	PA3560	791440028500	B7005	791440029705	H9080	791440031333	G204-A
791440023451	LL2945	791440026353	PA3562	791440028531	B7009	791440029712	H9081	791440031357	G206
791440023468	PA2945	791440026360	PA3563	791440028548	B7010	791440029729	H9082	791440031364	G208-A
791440023475	PA2946	791440026377	PA3565	791440028555	B7011	791440029736	H9083	791440031388	G210
791440023482	PA2947	791440026384	PA3566	791440028562	B7014	791440029743	H9084	791440031395	G211
791440023499	PA2949-FN	791440026391	PA3569	791440028579	B7018	791440029750	H9085	791440031401	G214
791440023505	PA2973	791440026438	PA3572	791440028586	B7019	791440029767	H9086	791440031425	G219
791440023529	PA2978	791440026445	PA3573	791440028593	B7020	791440029774	H9092	791440031432	G220
791440023536	PA2984	791440026469	PA3576	791440028609	B7022	791440029781	H9093	791440031449	G222-B
791440023543	PA2988	791440026483	PA3580	791440028616	B7023	791440029804	H9096	791440031487	G229
791440023550	PA2989	791440026490	PA3581	791440028623	B7024	791440029811	H9097	791440031500	G232
791440023552	PA3404	791440026551	PA4016	791440028630	B7025	791440029828	H9103	791440031517	G233-A
791440023530	PA3406-FN	791440026568	PA4018	791440028715	F7500	791440029835	H9107	791440031524	G233-B
791440023554	PA3408	791440026582	PA4023	791440028722	P7500	791440029842	H9108	791440031555	G236-A
791440025592	PA3420	791440026605	PA4028	791440028760	BF7519	791440029859	H9110	791440031579	G238
791440025608	PA3421	791440026612	PA4031	791440028821	BF7528	791440029866	H9111	791440031586	G239
791440025615	PA3438	791440026650	PA4050	791440028838	BF7529	791440029873	H9112	791440031593	G240
791440025622	PA3439-FN	791440026681	PA4060	791440028852	BF7538	791440029880	H9113	791440031609	G241
791440025639	PA3440	791440026704	CFB5000	791440028869	BF7557	791440029897	H9114	791440031616	G243-A
791440025653	PA3442	791440026742	CS5007	791440028883	BF7558	791440029903	H9123	791440031630	G247
791440025677	PA3447	791440026759	CS5008	791440028906	B7577	791440029910	18015	791440031661	G251
791440025684	PA3448	791440026766	CS5009	791440028937	B7600	791440029989	18104	791440031678	G252
791440025714	PA3453	791440026773	CS5010	791440029071	BT8301	791440030039	18155	791440031685	G253-A
791440025738	PA3457	791440026780	CS5011	791440029095	BT8304	791440030053	18171	791440031692	G255
791440025745	PA3458	791440026797	CSC5012	791440029101	PT8305	791440030077	18198	791440031715	G257
791440025769	PA3460	791440026803	CSC5013	791440029118	PT8306-10	791440030114	18236	791440031722	G260
791440025776	PA3461	791440026865	CTK5028	791440029125	PT8306-25	791440030121	18245	791440031739	G261
791440025790	PA3463	791440026872	CS5055	791440029132	BT8312	791440030244	19593	791440031753	G263
791440025806	PA3464	791440026889	CS5057	791440029149	BT8314	791440030329	19739	791440031760	G264-A
791440025820	PA3466-FN	791440026896	CS5058	791440029156	PT8318-MPG	791440030343	19828	791440031777	G265
791440025837	PA3467	791440026902	OTK5060	791440029163	BT8320	791440030442	19992	791440031791	G268
791440025851	PA3469	791440026919	OTK5061	791440029194	BT8802-MPG	791440030459	PA3480	791440031807	G269
791440025868	PA3470	791440026926	OTK5062	791440029200	BT8803-MPG	791440030466	BT8307-MPG	791440031814	G270
791440025875	PA3471	791440026933	OTK5063	791440029231	BT8812-MPG	791440030473	BT8308-MPG	791440031821	G273
791440025882	PA3472-FN	791440026940	BW5070	791440029248	BT8813-MPG	791440030480	BT8309-MPG	791440031838	G274
791440025899	PA3473	791440026957	BW5071	791440029255	H9001	791440030497	BT8310-MPG	791440031845	G275
791440025905	PA3474	791440026964	BW5072	791440029279	H9007	791440030527	PA3493	791440031852	G278
791440025912	PA3475	791440026971	BW5073	791440029293	H9013	791440030558	ES24-B	791440031876	G280
791440025929	PA3476	791440026988	BW5074	791440029309	H9014	791440030619	G102-A	791440031883	G281
791440025936	PA3477	791440026995	BW5075	791440029323	H9020	791440030626	G103	791440031906	G283
791440025943	PA3478	791440027008	BW5076	791440029330	H9021	791440030633	G104	791440031913	G288
791440025950	PA3479	791440027046	B5134	791440029347	H9024	791440030640	G105	791440031920	G289
791440025967	PA3481	791440027053	BW5136	791440029361	H9036	791440030657	G106	791440031944	G291



WARNING: These products can expose you to chemicals, including Diisononyl Phthalate, Carbon black extracts, Nickel, 1,3 Butadiene, Ethylene Oxide, Epichlorohydrin, which are known to the State of California to cause cancer, and Bisphenol-A, Ethylene Glycol, Ethylene Oxide, 1,3 Butadiene, Epichlorohydrin, which are known to the State of California to cause birth defects or other reproductive harm. For more information go to www.P65Warnings.ca.gov.

UPC TO BALDWIN (INDIVIDUAL PARTS)

UPC NUMBER	BALDWIN NUMBER	UPC NUMBER	BALDWIN NUMBER	UPC NUMBER	BALDWIN NUMBER	UPC NUMBER	BALDWIN NUMBER	UPC NUMBER	BALDWIN NUMBER
791440031951	G296	791440033207	ES1023	791440035485	100-M	791440037748	BF7552	791440038967	BT8850-MPG
791440031968	G299	791440033214	ES1026	791440035508	100-MFV	791440037755	PA3605	791440038981	BT8861
791440031982	G302	791440033238	ES1030	791440035515	100-MMV	791440037762	PA3606	791440039322	BT8851-MPG
791440031999	G303	791440033245	ES1032	791440035546	100-W	791440037779	PA3607-FN	791440039353	PT8350
791440032002	G304	791440033252	ES1034	791440035577	101	791440037786	PA3608-FN	791440039377	RS3532
791440032019	G305	791440033276	ES1036	791440035591	101-W	791440037793	PA3609	791440039384	RS3533
791440032026	G306	791440033283	ES1041	791440035614	140-10	791440037809	PA3610	791440039391	RS3535
791440032033	G307	791440033306	ES1049	791440035652	140-50 KIT	791440037816	PA3611	791440039650	G499-AF
791440032040	G309-B	791440033337	ES1066	791440035737	150	791440037854	B7039	791440039667	G348-AF
791440032057	G310	791440033344	ES1067	791440035812	150-31	791440037885	BF7546	791440039766	ES4008
791440032071	G314	791440033351	ES1068	791440035850	150-GK	791440037892	BF1345	791440039773	ES4007
791440032088	G315	791440033368	ES1071	791440035867	150-H	791440037908	PA3587	791440040052	G498-A
791440032149	G323	791440033375	ES1074	791440035881	150-M	791440037915	PA3568	791440040106	G483
791440032187	G332	791440033382	ES1092	791440035911	151	791440037946	PA3588	791440040243	B7030
791440032194	G333	791440033399	ES1303-A	791440035928	151-30	791440037960	BF7544	791440040496	PKG400
791440032217	G336	791440033405	ES1303-B	791440035935	151-W	791440037984	BF7541	791440040502	PKG401
791440032248	G340	791440033412	ES1369-A	791440035942	185-DS	791440037991	BF880-FP	791440040519	PKG402
791440032255	G342	791440033429	ES1375	791440035977	186-SK	791440038028	PA3430	791440040557	PKG406
791440032262	G343-A	791440033474	ES3012	791440036000	200	791440038035	PA3578	791440040564	PKG400-W
791440032279	G344	791440033481	ES3028	791440036079	200-15	791440038042	RS3540	791440041141	PA2903
791440032293	G347	791440033498	ES3029	791440036130	200-21	791440038059	BT305	791440041189	PT8352
791440032316	G354	791440033528	ES3063	791440036147	200-21BP	791440038066	B7047	791440041196	PT8351
791440032330	G356	791440033559	1S-9133	791440036154	200-21H	791440038073	PT8345	791440041202	PT8353
791440032354	G359	791440033603	4L-8212-R	791440036161	200-21HBP	791440038080	BT8328	791440041233	RS3542
791440032361	G360	791440033627	5H-5601	791440036178	200-21M	791440038097	PA3595	791440041240	RS3543
791440032378	G362	791440033634	5M-954	791440036239	200-30U	791440038110	P7035	791440041257	RS3544
791440032385	G363	791440033658	6L-1540	791440036246	200-31	791440038127	BT372-MPG	791440041264	RS3545
791440032408	G366	791440033665	7B-7635	791440036321	200-GK	791440038134	P7000 KIT	791440041271	RS3546
791440032415	G368	791440033740	8M-7830	791440036338	200-H	791440038141	PT8331-MPG	791440041288	RS3547
791440032446	G372	791440033764	G15-AF	791440036369	200-M	791440038172	PA3449	791440041295	BF7571
791440032484	G376	791440033801	G21-AF	791440036390	200-MFV	791440038219	B1429	791440041325	PA3499
791440032507	G379	791440033818	G25-AF	791440036406	200-MMV	791440038226	P7058	791440041493	BF1173
791440032514	G380	791440033825	G1086-AF	791440036451	200-W30	791440038233	P7059	791440041530	BF7534
791440032521	G381-A	791440033832	G501-AF	791440036468	201	791440038240	PF7553	791440042254	BK6764
791440032538	G382	791440034129	G31-AF	791440036475	201-30	791440038257	PF7554	791440042469	PA3627
791440032545	G382-V	791440034150	G34-AF	791440036499	201-W	791440038264	PA3612	791440042476	PA3628
791440032576	G385	791440034167	G37-AF	791440036505	285-DS	791440038271	PA3613	791440042483	PA3629
791440032583	G386	791440034174	G39-AF	791440036512	286-SK	791440038295	BT8347	791440042490	PT8354
791440032613	G392	791440034396	G141-AF	791440036529	300	791440038325	PF7556	791440042506	PT8355
791440032637	G394	791440034419	G145-AF	791440036659	300-DHRAP5	791440038332	PA3614	791440042520	BF1239
791440032668	G397	791440034440	G207-AF	791440036666	300-DHRAS5	791440038349	BF7559	791440042537	PF7572
791440032682	G400	791440034471	G285-AF	791440036741	300-H	791440038356	BF1346	791440042568	PT013
791440032699	G401	791440034501	G298-AF	791440036758	300-M	791440038363	RS3530	791440042575	PA3630-FN
791440032705	G402	791440034587	G422-AF	791440036796	300-MFV	791440038370	RS3538	791440042582	PA3631
791440032712	G403	791440034624	301-MPG	791440036802	300-MFV3	791440038387	B7044	791440042599	PA3632
791440032743	G406	791440034778	24-WLK	791440036833	300-MMV	791440038394	BT8840-MPG	791440042605	PA3633
791440032774	G409	791440034792	55-EK	791440036840	300-MMV3	791440038400	BT8862	791440042629	BT8845
791440032781	G410	791440034822	60-21	791440036956	301	791440038417	BT8863	791440042636	BT8844
791440032798	G411	791440034839	60-21A	791440036963	301-30	791440038424	RS3528	791440042643	PA2001 FOAM
791440032804	G412	791440034877	60-30	791440036970	301-CS	791440038431	RS3518	791440042667	PA3636
791440032835	G416	791440034914	60-35A	791440036987	301-W	791440038448	RS3550	791440042674	BD103-MPG
791440032842	G417	791440034921	60-GK	791440036994	500	791440038455	BD232	791440042704	PA3637
791440032880	G431	791440034938	61	791440037007	500-12	791440038462	BT310	791440042711	PA3638
791440032897	G432	791440034945	61-W	791440037014	500-15	791440038585	PA2139 FOAM	791440042735	PA3640
791440032903	G433	791440034952	65	791440037021	500-BP	791440038592	PA2258	791440042766	BF7576
791440032910	G434	791440034976	65-35A	791440037038	500-BP22	791440038608	PA2480	791440042773	BF7579
791440032927	G435	791440034983	66	791440037052	501	791440038615	PA2554 FOAM	791440042780	BF7580
791440032934	G436	791440034990	66-W	791440037069	501-30	791440038646	PA3446	791440042810	PA3643
791440032958	G438	791440035003	75	791440037076	501-W	791440038653	PA3452	791440042827	RS3529
791440032965	G439	791440035027	75-21	791440037533	PA3597	791440038660	PA3491	791440042834	RS3537
791440032972	G441	791440035034	85-EK	791440037540	PA3598	791440038677	RS3520	791440042858	PA3644
791440032989	G442	791440035041	85-P	791440037571	PT8344	791440038691	PA4015	791440042889	PA3645
791440032996	G443	791440035058	85-V	791440037588	P7053	791440038738	PA3579	791440042926	PT8329
791440033009	G444	791440035126	100	791440037595	PA3600	791440038745	PA3584	791440042995	BT8830
791440033016	G445	791440035157	100-12	791440037601	PA2260	791440038813	P7007	791440043008	BT8832
791440033023	G446	791440035232	100-21	791440037618	BD7028	791440038820	P7012	791440043015	BT8831
791440033030	G447	791440035249	100-21BP	791440037625	B7051	791440038851	B7031	791440043039	RS3517
791440033047	G449-B	791440035270	100-21M	791440037632	PF7549	791440038875	B7042	791440043060	RS3548
791440033061	G458	791440035324	100-28	791440037649	PA3601	791440038882	BF7531	791440043077	B1430
791440033108	G467	791440035331	100-29	791440037687	PF7550	791440038899	BT8302	791440043091	PT8356
791440033115	G468	791440035348	100-30	791440037694	PF7551	791440038905	BT8316-MPG	791440043107	BW5082
791440033139	G480	791440035416	100-BP	791440037700	PA3602	791440038912	BT8323	791440043121	PF7583
791440033177	G1973	791440035454	100-GK	791440037724	PA3604	791440038943	PT8330-MPG	791440043138	BF7584
791440033184	ES1001	791440035461	100-H	791440037731	P7055	791440038950	BT8333	791440043145	P7081



WARNING: These products can expose you to chemicals, including Diisononyl Phthalate, Carbon black extracts, Nickel, 1,3 Butadiene, Ethylene Oxide, Epichlorohydrin, which are known to the State of California to cause cancer, and Bisphenol-A, Ethylene Glycol, Ethylene Oxide, 1,3 Butadiene, Epichlorohydrin, which are known to the State of California to cause birth defects or other reproductive harm. For more information go to www.P65Warnings.ca.gov.

UPC TO BALDWIN (INDIVIDUAL PARTS)

UPC NUMBER	BALDWIN NUMBER	UPC NUMBER	BALDWIN NUMBER	UPC NUMBER	BALDWIN NUMBER	UPC NUMBER	BALDWIN NUMBER	UPC NUMBER	BALDWIN NUMBER
791440043152	PT8319	791440045583	PF7592	791440046955	BK6799	791440049048	BF1179	791440050433	B7600-SS
791440043169	PT8341	791440045590	PA3664-FN	791440047020	B7099	791440049086	BF1181	791440050457	BF7612
791440043176	PT8335	791440045620	PA3668	791440047068	PA4075	791440049093	PA2237	791440050464	BF7613
791440043206	BT8357	791440045637	PA3669-FN	791440047075	PA4076	791440049116	BF1182	791440050488	BF1248
791440043237	CTK5029	791440045644	BF1329-SP	791440047082	P7102	791440049123	BF1184	791440050495	PA3781
791440043244	PA3650	791440045651	ES1377	791440047112	PT8370-MPG	791440049130	BF1185	791440050501	BF7614
791440043251	PA3651-FN	791440045668	BF1222-SP	791440047129	PT8371-MPG	791440049147	BF1186	791440050518	P7615
791440043268	PA3652	791440045675	BF1222	791440047150	PA3494	791440049215	BF1188	791440050525	B7121
791440043275	B7585	791440045699	PA2233	791440047167	G286-C	791440049222	PA4044	791440050532	PT8385
791440043282	B7082	791440045705	BF1329	791440047174	BF1258	791440049239	PA4045	791440050549	BF1052
791440043299	PA3653	791440045712	P7052	791440047211	BK6583	791440049246	PA4046	791440050563	BF1053
791440043305	BF7586	791440045729	RS3549	791440047228	PA3688	791440049277	PA3484	791440050570	RS3521
791440043312	BF7587	791440045736	RS3703	791440047501	RS3519	791440049284	PA3483	791440050587	B1421
791440043329	P7083	791440045743	RS3704	791440047518	BD325	791440049307	RS3718	791440050594	BT8386
791440043336	PF7588	791440045750	RS3705	791440047525	PA3690	791440049314	RS3719	791440050600	PT7616
791440043343	BF1231	791440045767	PA3670	791440047532	PA4077	791440049321	RS3717	791440050617	PT7617
791440043350	P7084	791440045781	BF1347	791440047549	PA3689	791440049345	PA4048	791440050624	BF1349
791440043374	PT8359	791440045804	BF1345-SP	791440047556	P7103	791440049352	AF521-WN	791440050662	PA3782
791440043428	PA3654	791440045811	BF1205	791440047563	RS3712	791440049369	AF525-WN	791440050679	PA3783
791440043435	PA4005	791440045828	BF1204	791440047570	BF7598	791440049383	BF1215	791440050686	PT8387
791440043442	B1405	791440045835	BF1205-SP	791440047587	P7104	791440049390	PA3772	791440050693	PT8388
791440043459	PA2200	791440045897	PT8339	791440047594	BD7105	791440049406	PA4049	791440050709	PT8389
791440043466	PA2227	791440045903	BF1348	791440047600	P7106	791440049413	BF1190	791440050716	BF1054
791440043480	PA2229	791440045910	BF1204-SP	791440047617	P7107	791440049420	BF1191	791440050822	BF1056
791440043497	PA2230	791440045927	BT610-MPG	791440047655	PT8372	791440049444	BF1193	791440050846	B1422
791440043510	RS3700	791440045934	BT8846	791440047662	BF7602	791440049451	BF1194	791440050907	PF7618
791440043527	RS3701	791440045941	BT8852-MPG	791440047679	PA4078	791440049468	BF1195	791440050921	PA3787
791440043558	B1410	791440045958	BT611-MPG	791440047723	BF1100	791440049529	BF1199	791440050938	PT7716
791440043565	PA4041	791440045972	BK6702	791440047822	BF7606	791440049536	PA4081	791440050945	BT8391
791440043589	PA3655	791440045989	PA3672	791440047846	B7113	791440049543	PA4082	791440050952	PA3786-FN
791440043596	PA3657	791440045996	PA3671-FN	791440047860	PA3697	791440049567	PA3773	791440050969	BF7619
791440043602	PA3656	791440046016	PA3674	791440047877	PA4079	791440049574	BF1045	791440050983	BF1249
791440043619	PA3658	791440046061	BD7095	791440047891	18003	791440049581	BF1046	791440050990	RS3722
791440043626	PA4069	791440046078	PA2234	791440047907	18004	791440049598	BF1047	791440051003	PT8392
791440043633	PA4070	791440046085	PA3675	791440047938	18007	791440049604	BF1048	791440051041	BF1252
791440043640	PA4071	791440046092	PA3676	791440047969	18010	791440049611	BF1049	791440051089	BF1217
791440043657	PT8338	791440046115	BF1223-SP	791440048089	PA3691	791440049628	BF1050	791440051096	BT8308-MPG KIT
791440043664	PF7545	791440046122	BF7593	791440048140	PT8375-MPG	791440049642	PA3767	791440051102	BD7120
791440043671	B7045	791440046252	BK6579	791440048157	PT8376-MPG	791440049659	PA3768	791440051140	PA4088
791440043718	P7050	791440046283	PF7594	791440048171	PA3698	791440049666	RS3716	791440051157	PA4089
791440043725	PT8334	791440046290	PF7595	791440048188	RS3714	791440049680	BT8381	791440051171	BF1057
791440043794	PA4072	791440046344	RS3706	791440048195	B7001	791440049703	RS3720	791440051195	BF1059
791440043800	PA3660-FN	791440046351	RS3707	791440048201	PA3699	791440049734	PA2240	791440051201	BF1061
791440043817	PA4073	791440046375	RS3708	791440048232	RS3715	791440049741	PA2241	791440051218	PA4091
791440043831	PA3667-FN	791440046382	RS3709	791440048263	P7114	791440049765	PA2243	791440051225	BD7029
791440043848	RS3541	791440046399	PKG50	791440048485	PA3752	791440049772	PA2244	791440051256	ES1376
791440043968	RS8361	791440046412	PF7596	791440048492	PA3753	791440049871	BF1008	791440051294	RS3724
791440044999	B7049	791440046429	BT8870-MPG	791440048508	PA3754	791440049888	BF1010	791440051300	B7124
791440045019	B7089	791440046443	BT8874-MPG	791440048614	PA3755	791440050044	PA4084	791440051317	PA2813
791440045033	BF1224	791440046450	BK6375	791440048621	PA3756	791440050051	PA3774	791440051324	PT7126
791440045095	PT8363	791440046467	BT606-MPG	791440048638	PA3757	791440050068	PA3775	791440051331	18025
791440045118	PA2231	791440046474	P7021	791440048645	PA3758	791440050105	BT8382	791440051348	18024
791440045132	RS3536	791440046511	BT8873	791440048652	PA3759	791440050129	PT8383	791440051355	18022
791440045163	PT394-5	791440046528	PA3679	791440048669	PA3760	791440050136	P1418	791440051379	18027
791440045170	RS3534	791440046535	PF7597	791440048676	PT8378-MPG	791440050143	P1419	791440051393	BF125
791440045187	RS3539	791440046542	BK6376	791440048683	PA3761-FN	791440050204	BF7609	791440051409	PA4092
791440045217	B7091	791440046559	BF7532	791440048706	B7026-MPG	791440050211	CTK5029-4	791440051416	PA3785-FN
791440045231	PT8366	791440046566	BT8875-MPG	791440048720	B7116	791440050235	PA3777	791440051454	BT8393
791440045248	BF7535	791440046610	B7097	791440048737	PA3763	791440050259	PA3778	791440051478	PT7127
791440045361	PA2838	791440046627	P7015	791440048768	RS3531	791440050266	BF1172	791440051492	BF7623
791440045378	PA2860-FN	791440046726	P7016	791440048775	BT8876-MPG	791440050273	PA2977-FN	791440051508	SA2047
791440045385	PA2862	791440046733	P7017	791440048805	PA3765	791440050297	BF1119	791440051515	BF1253
791440045392	PA2869	791440046771	RS3710	791440048812	PA3766	791440050303	PA4085	791440051546	PA3790
791440045408	PA2878	791440046788	RS3711	791440048829	B7117	791440050310	PA3779-FN	791440051553	PT8394-MPG
791440045415	PA2891	791440046795	PA3680	791440048836	PA2951	791440050327	BF1240	791440051560	PA3791-FN
791440045446	PA2955	791440046818	PA3681	791440048850	PA2952	791440050334	BT8384	791440051577	PA3792
791440045453	PA2963	791440046825	PA3682	791440048881	PA2235	791440050341	B495-SS	791440051584	PA3793
791440045484	PA2232	791440046832	PA3683	791440048898	BF1174	791440050358	RS3713	791440051607	PA3794
791440045491	BT8368	791440046849	PA3684	791440048911	BF7522	791440050365	PA3780	791440051621	PT8395
791440045521	BF7591-D	791440046856	PA3685	791440048942	BF7608	791440050389	B96-SS	791440051638	PT8396
791440045538	BK6619	791440046863	PA3686	791440048959	PA4042	791440050396	B95-SS	791440051645	PA2942
791440045545	B1413	791440046870	PA3687	791440048966	PA4043	791440050402	BD103-SS	791440051652	BT8848-MPG
791440045552	P7092	791440046917	BT8841-MPG	791440049024	BF1177	791440050419	B99-SS	791440051669	BF7624
791440045569	P7093	791440046924	PA2804	791440049031	BF1178	791440050426	B76-SS	791440051676	P7607



WARNING: These products can expose you to chemicals, including Diisononyl Phthalate, Carbon black extracts, Nickel, 1,3 Butadiene, Ethylene Oxide, Epichlorohydrin, which are known to the State of California to cause cancer, and Bisphenol-A, Ethylene Glycol, Ethylene Oxide, 1,3 Butadiene, Epichlorohydrin, which are known to the State of California to cause birth defects or other reproductive harm. For more information go to www.P65Warnings.ca.gov.

UPC TO BALDWIN (INDIVIDUAL PARTS)

UPC NUMBER	BALDWIN NUMBER	UPC NUMBER	BALDWIN NUMBER	UPC NUMBER	BALDWIN NUMBER	UPC NUMBER	BALDWIN NUMBER	UPC NUMBER	BALDWIN NUMBER
791440051713	PA3796	791440053014	F953-F	791440054158	PA3411-FN	791440055360	OB8712	791440056657	RS3750
791440051720	PA3797	791440053021	PF997	791440054165	PA3414	791440055445	OB8720	791440056701	PA2968-FN
791440051737	PA4093	791440053038	PA3808-FN	791440054172	PA3415	791440055452	OB8721	791440056732	BF1277-SP
791440051744	PA4094	791440053045	PA3809	791440054189	PA3416	791440055469	OB8722	791440056749	BF1273-SP
791440051751	PA3795	791440053052	PA3806	791440054196	PA3417	791440055483	OB8724	791440056756	PA3892
791440051775	BF7625	791440053069	BF7648	791440054233	B7033	791440055728	18032	791440056763	PA3893
791440051782	B1425	791440053076	PT8407	791440054240	B7034	791440055735	BT8849-MPG	791440056770	PA3876
791440051805	PT8380	791440053083	PT8408	791440054264	BF7537	791440055742	BT8855-MPG	791440056817	BF1262
791440051850	BT8397-MPG	791440053106	PA3810	791440054271	ES24-D	791440055759	BT8877-MPG	791440056824	RS3732
791440051874	PA3798	791440053113	BF7633	791440054288	G103-N	791440055766	BT8878-MPG	791440056848	BF1271
791440051881	RS3730	791440053120	P7132	791440054325	P7134	791440055773	BT8879-MPG	791440056855	B7152
791440051898	BF1348-SP	791440053137	PA4102	791440054363	B7135	791440055803	PA3633 FOAM	791440056886	BD7153
791440051904	BT8398-MPG	791440053175	RS3740	791440054370	RS3743	791440055810	B7143	791440056893	BD7154
791440051973	BT8842-MPG	791440053182	RS3741	791440054394	PA3822	791440055827	PA3877	791440056909	PA3894
791440051980	RS3733	791440053199	BT8409	791440054400	PA3823	791440055834	PA3878	791440056923	PA3895-FN
791440052000	BT8843-MPG	791440053236	BK6634	791440054417	PA3824	791440055841	PA3879-FG	791440056930	BT7155
791440052017	PA4096	791440053267	PA3811-FN	791440054424	BT8412	791440055858	BF7669	791440056954	PA3896
791440052031	BF7626	791440053274	PA3812	791440054431	BF7639	791440055865	B1431	791440056961	PA3898
791440052048	PF7627	791440053281	BW5200	791440054462	BF7656	791440055872	BT8417	791440056978	PA3899
791440052079	PT8400-MPG	791440053298	BF7634	791440054516	PA4103	791440055889	BT8415	791440056985	BT8420
791440052086	B7128	791440053304	BT8853-MPG	791440054523	PA3832	791440055896	BT8413	791440057005	PA3897
791440052123	BT8401-MPG	791440053311	PA3814	791440054530	BF1256	791440055919	B1432	791440057029	BW5143
791440052178	PT8402-MPG	791440053328	PA3815	791440054561	PA3833	791440055926	PA3872	791440057036	PF7680
791440052192	PT8403-MPG	791440053366	BF1257	791440054578	PF7678	791440055933	PA3873	791440057067	OB8731
791440052208	RS3726	791440053373	BF7635	791440054585	PA3834	791440055940	BF7670	791440057074	OB8732
791440052215	PA3419	791440053397	BF553	791440054592	PA3835	791440055957	B7144	791440057128	OB8743
791440052222	BF7628	791440053441	BT841	791440054608	P7136	791440056022	PA3875-FN	791440057135	OB8741
791440052239	RS3727	791440053458	PA2759	791440054615	P7137	791440056039	PA3880	791440057142	OB8742
791440052246	RS3728	791440053489	PA2771	791440054622	P7138	791440056046	RS3882	791440057166	OB8746
791440052253	RS3729	791440053496	PA2800-FN	791440054639	PA4104	791440056053	RS3883	791440057173	OB8744
791440052277	BF7629	791440053557	PA2840	791440054646	PA4105	791440056060	RS3884	791440057180	OB8745
791440052284	PT8404-MPG	791440053571	PA2847	791440054653	PA4106	791440056077	RS3885	791440057197	OB8771
791440052291	BF7630	791440053588	PA2859-FN	791440054660	PA4107	791440056084	PA4111	791440057203	OB8772
791440052307	PA4099	791440053595	PA2862 FOAM	791440054677	B7139	791440056091	PA3881	791440057326	OV8700
791440052314	RS3731	791440053601	PA2866	791440054691	B1416	791440056107	PA3886	791440057333	OV8701
791440052321	BF7631	791440053618	PA2867-FN	791440054707	RS3744	791440056114	BT8418	791440057357	OS8703
791440052338	BK6287	791440053625	PA2870-FN	791440054714	RS3745	791440056121	BF7671	791440057364	OS8704
791440052345	PA3800	791440053632	PA2873	791440054738	PA3807	791440056138	BK6704	791440057371	OS8705
791440052352	BF7632	791440053656	PA2880	791440054752	BK6595	791440056145	BK6705	791440057388	OB8709
791440052437	BF7641	791440053663	PA2881	791440054806	PA3842	791440056183	BT8880-MPG	791440057395	OB8773
791440052444	PA4100	791440053687	PA2883	791440054813	PA3843	791440056190	PT8419	791440057401	BW5201
791440052468	RS3721	791440053694	PA2884	791440054837	BF7639-D	791440056206	18033	791440057418	PA3900
791440052482	PA3802	791440053700	PA2885	791440054844	PT691	791440056213	18034	791440057425	PA4112
791440052499	PA3803	791440053717	PA2887-FN	791440054851	PA3412	791440056220	PA3887	791440057432	PA3901
791440052505	PA3804	791440053724	PA2888	791440054875	BF1261	791440056237	RS3888	791440057456	RS3764
791440052529	V7129-C	791440053731	PA2889	791440054899	BD1403	791440056244	PA3889	791440057463	RS3826
791440052536	PA2871	791440053748	PA2890	791440054905	BF7658	791440056251	BF7640	791440057470	RS3827
791440052543	PA3805-FN	791440053762	PA2895	791440054912	BF7659	791440056268	BF7653	791440057487	PF7655
791440052550	RS3736	791440053779	PA2897	791440054936	BF7661	791440056282	PA3890	791440057494	BT7156
791440052567	RS3737	791440053793	PA2899	791440054950	PA4108	791440056343	PA3891	791440057500	BF7668
791440052581	BW5142	791440053809	PA2904	791440054967	PA4109	791440056350	PA3838	791440057517	BT8421-MPG
791440052598	RS3735	791440053816	PA2905	791440054974	BF7663	791440056367	PA3844	791440057524	BT8422-MPG
791440052604	B7130	791440053823	PA2906	791440054981	BF7664	791440056381	PA3847	791440057531	BT8423
791440052611	B7131	791440053847	PA2909	791440055001	PT8414-MPG	791440056398	PA3848-FN	791440057548	PA3902
791440052628	BF7645	791440053878	PA2912	791440055032	BF7657	791440056404	PA3849	791440057555	PA3903
791440052666	BF1249-SP	791440053885	PA2913	791440055049	PA3836	791440056411	PA3850	791440057562	PA3904
791440052673	PA2961-FN	791440053892	PA2914	791440055056	BF7666	791440056428	PA3851	791440057579	PA3905
791440052680	PA2877-FN	791440053908	PA2915	791440055063	PA3837	791440056435	PA3852-FN	791440057586	PA3906
791440052697	PA2959-FN	791440053915	PA2919	791440055070	PA3839	791440056442	PA3853-FN	791440057593	BW5086
791440052703	PA2960	791440053939	PA2948	791440055087	PA3840	791440056459	PA3854-FN	791440057661	PA3908
791440052710	PA2957	791440053946	PA2950	791440055094	BD7141	791440056466	PA3855-FN	791440057678	PA3909
791440052727	PA2956-FN	791440053953	PA2953	791440055100	BT8416	791440056473	PA3856	791440057760	BT7157
791440052734	RS3734	791440053960	PA2954-FN	791440055117	BF7667	791440056480	PA3857	791440057777	PA3910-FN
791440052741	BF7644	791440053977	PA2958	791440055124	B7142	791440056503	PA3859	791440057784	PA3911
791440052758	18029	791440053984	PA2962	791440055131	PA4110	791440056510	PA3860	791440057791	PA3907
791440052772	PA3801-FN	791440053991	PA2964	791440055148	RS3747	791440056527	PA3861	791440057801	BF1112
791440052857	RS3738	791440054004	PA2967	791440055155	PA3867	791440056534	PA3862-FN	791440057838	PA3914
791440052864	RS3739	791440054028	PA2970	791440055162	PA3868	791440056541	PA3863	791440057845	PA3915
791440052918	P127	791440054035	PA2971	791440055179	RS3870	791440056558	PA3864	791440057852	BD7158
791440052949	F594-F	791440054066	PA2976-FN	791440055186	RS3871	791440056565	PA3865	791440057869	PT8425
791440052956	PT679	791440054073	PA2980	791440055193	RS3749	791440056589	P1433	791440057890	PA4113
791440052970	PT682	791440054080	PA2981	791440055209	RS3746	791440056619	P7145	791440057906	BF1282
791440052987	PT683	791440054097	PA2982	791440055230	PA3874	791440056633	BK6195	791440057913	BT8805-MPG
791440053007	F950-F WO	791440054141	PA3405	791440055353	OB8711	791440056640	BK6196	791440057937	BT8426-MPG



WARNING: These products can expose you to chemicals, including Diisononyl Phthalate, Carbon black extracts, Nickel, 1,3 Butadiene, Ethylene Oxide, Epichlorohydrin, which are known to the State of California to cause cancer, and Bisphenol-A, Ethylene Glycol, Ethylene Oxide, 1,3 Butadiene, Epichlorohydrin, which are known to the State of California to cause birth defects or other reproductive harm. For more information go to www.P65Warnings.ca.gov.

UPC TO BALDWIN (INDIVIDUAL PARTS)

UPC NUMBER	BALDWIN NUMBER	UPC NUMBER	BALDWIN NUMBER	UPC NUMBER	BALDWIN NUMBER	UPC NUMBER	BALDWIN NUMBER	UPC NUMBER	BALDWIN NUMBER
791440057944	PA3916	791440058897	BF7693	791440060098	PA3966	791440061194	SA4141	791440062504	PT8494
791440057951	BD7159	791440058903	RS3936	791440060104	BT8450	791440061231	PA4551	791440062511	PF1291
791440057968	BD7160	791440058910	B1435	791440060111	PA3967	791440061248	PA4552	791440062528	PA4146
791440058002	BF162	791440058941	BD7309	791440060135	PT8451-MPG	791440061262	B7174-MPG	791440062535	PA4147
791440058019	BT163	791440058966	P1440	791440060142	BD7175	791440061279	RS3993	791440062542	PA4148
791440058026	BT164	791440059016	PA3951	791440060159	PT8452	791440061286	RS3995	791440062559	B1446
791440058033	BF1330-SP	791440059023	BF1268	791440060166	PA3969	791440061293	RS3997	791440062566	BK6694
791440058057	BT165	791440059030	BT8440-MPG	791440060173	PA3970	791440061330	PA2896	791440062573	G717
791440058064	PA3869	791440059047	PA3937	791440060197	PA3972	791440061354	PA4553	791440062580	V1560
791440058071	PA3825	791440059061	BT8439-MPG	791440060203	PA3973	791440061361	PA4554	791440062597	RS4572
791440058088	PA3828	791440059078	PA3938	791440060210	B7177	791440061378	PA4555	791440062603	PT7199
791440058095	PA3829	791440059085	PA4120	791440060227	RS3974	791440061385	PA4556	791440062634	PT8481
791440058101	PA4114	791440059092	G293-B	791440060234	RS3975	791440061392	PA4557	791440062658	BF7742
791440058118	PA3917	791440059122	ES1031	791440060265	PA3978	791440061408	BF7726	791440062665	PT8495-MPG
791440058125	BT161	791440059146	G225-AF	791440060272	PA3979	791440061415	PT8462-MPG	791440062788	PT8496-MPG
791440058149	BD7166	791440059153	G472-F	791440060289	P7178	791440061439	PT8468	791440062801	PF7744
791440058163	BT8833	791440059160	PA4118	791440060296	B7179	791440061460	PT8470	791440062832	PA4573
791440058170	PT8427	791440059177	PT8441	791440060319	PA4128	791440061477	P7185	791440062849	PA4574
791440058187	PT8410	791440059283	BF7695	791440060326	PA4129	791440061484	BT8471-MPG	791440062856	BT8497-MPG
791440058194	PT8411	791440059290	BF1269	791440060333	RS4130	791440061491	BT8472	791440062870	RS4576
791440058200	PA3821	791440059320	PA4121	791440060340	PT8453	791440061507	BT8473	791440062887	RS4577
791440058217	PA3818-FN	791440059337	BF1277-SPS	791440060357	PA3980	791440061514	BT8474	791440062900	RS4578
791440058224	PA3817	791440059351	PA3939	791440060364	RS4131	791440061521	BT8475	791440062917	PT8498
791440058231	BT287-3	791440059368	RS3940	791440060371	18264	791440061538	BT8476	791440062924	PA4571
791440058248	BT8428-MPG	791440059375	BF1270-SP	791440060388	18265	791440061545	BT8477	791440062931	BT8460
791440058262	B5087	791440059382	PT8442	791440060418	100-21AL	791440061552	BT8463-MPG	791440062955	PF7751
791440058279	B5088	791440059399	PA3941	791440060425	200-21AL	791440061569	BT8464	791440062979	BK6341
791440058286	BF1265	791440059412	BC7173	791440060449	PA4132	791440061576	BT8465	791440062993	BT215
791440058293	PA3918	791440059429	RS3942	791440060456	18267	791440061583	BT8466-MPG	791440063006	BT8499
791440058309	PA3919	791440059436	RS3943	791440060470	BF7713	791440061590	PT8467	791440063020	BK6686
791440058316	BT8429	791440059443	PA3944	791440060487	PA4133	791440061606	PT8478	791440063051	BT8501-MPG
791440058354	RS3920	791440059450	PA3945	791440060494	PF7715	791440061613	BC7186 KIT	791440063082	PA4149 KIT
791440058361	RS3921	791440059467	PA3946	791440060500	PF7716	791440061637	PT8479	791440063099	BT8502
791440058378	RS3922	791440059474	PA3948	791440060517	BF7717	791440061644	PT8480	791440063105	B7216
791440058385	RS3923	791440059481	PA3947	791440060548	BT8800-MPG	791440061651	B1444	791440063112	BT217
791440058392	B7685	791440059498	PA3953	791440060555	BT8801-MPG	791440061736	B7187	791440063129	RS4579
791440058408	B7175	791440059504	BT8443	791440060616	PT8455-MPG	791440061859	PF7733	791440063136	RS4580
791440058415	PA3924-FN	791440059511	PA3950	791440060623	PA3983-FN	791440061866	PF7734	791440063143	PA4581
791440058422	RS3926	791440059528	CTK5029-1	791440060647	PF7718	791440061880	PA4559	791440063150	PA4582
791440058439	RS3927	791440059559	PA4123	791440060654	B1441	791440061897	PT8484	791440063167	BT8503-MPG
791440058446	BT167	791440059566	PA4124	791440060678	P1443	791440061910	PA4560	791440063174	BT8504
791440058460	BT8424-MPG	791440059573	BT8856-MPG	791440060685	BD7310	791440061927	PF7735	791440063181	PA4583-FN
791440058477	B1434	791440059597	RS3952	791440060692	PT8456-MPG	791440061934	PA3435-FN	791440063204	BF7747
791440058491	PA3928	791440059603	RS3954	791440060715	BF7711	791440061941	P7188	791440063211	PF7748
791440058507	BF7686	791440059610	BT8444	791440060739	B7181	791440061958	RS4561	791440063228	PF7749
791440058521	PF7687	791440059634	BT8847	791440060753	BT8457-MPG	791440061965	PA4144	791440063273	BF7750
791440058545	PA3929	791440059641	B7172	791440060760	PA3949	791440061972	P7190	791440063280	BF1283
791440058552	BT180	791440059658	BF7683	791440060777	PA3985	791440061989	RS4562	791440063297	BF1281
791440058569	BT8432-MPG	791440059665	BF7696	791440060784	PT8458-MPG	791440062016	RS4563	791440063303	G725
791440058576	BF7690	791440059733	BF1274-SP	791440060791	PA3984	791440062023	RS4564	791440063327	PA4585
791440058583	PT8433-MPG	791440059740	BF1274-SPS	791440060845	B7182	791440062030	BK6215	791440063334	RS4549
791440058590	PA3819	791440059757	18055	791440060852	B7189	791440062047	B7191	791440063341	PA4548
791440058613	PA3820-FN	791440059764	18056	791440060869	PA4134	791440062054	PT8485	791440063440	B5089
791440058620	PA3816	791440059771	18057	791440060883	PT8459	791440062078	P7192	791440063457	PA4592
791440058644	BD7168	791440059788	BT8445	791440060913	G369-B	791440062092	P7193	791440063464	PA4150
791440058651	PA3925	791440059795	PT8446-MPG	791440060920	PA3986	791440062108	BT8486	791440063471	PA4593
791440058668	BD7169	791440059801	PA3956	791440060937	PA3987	791440062122	PT8487	791440063488	PA4594
791440058675	RS3930	791440059849	PA4126	791440060944	RS3988	791440062139	BT8488	791440063525	PT8506-MPG
791440058705	PA3932	791440059856	BF1271	791440060968	RS3990	791440062146	BC7194	791440063532	PT8507-MPG
791440058712	PA3933	791440059863	PA3957	791440060975	RS3992	791440062153	PA4566	791440063549	PKG470
791440058729	BF1266	791440059870	PT8447-MPG	791440060982	RS3994	791440062160	PT8489	791440063556	PKG470-DVD
791440058736	PA3931	791440059887	P8448	791440060999	RS3996	791440062177	PA4567	791440063570	PKG470-S
791440058743	B1438	791440059900	PF7698	791440061002	RS3998	791440062214	P7195	791440063587	RS4595
791440058750	B7170	791440059917	BF7697	791440061026	RS3991	791440062221	PT8490-MPG	791440063600	BT8509-MPG
791440058767	B7171	791440059924	PA4127	791440061033	PA3989-FN	791440062238	PA4145	791440063617	BT8505
791440058781	BF1267	791440059948	PA3958	791440061040	RS3999	791440062252	H9087	791440063631	H9052
791440058798	PT8435-MPG	791440059955	PA3961	791440061057	BK6696	791440062276	BF7736	791440063648	RS4598
791440058804	PT8436	791440060005	BT8449	791440061064	P7183	791440062283	BT8491	791440063655	RS4599
791440058811	BT8437	791440060012	BT8449-10	791440061088	BF7719	791440062290	PT8492	791440063662	BT8510-MPG
791440058842	PKG411	791440060029	PA3959	791440061095	RS3971	791440062320	BT8834-MPG	791440063679	BF7753
791440058859	PKG412	791440060036	BF5815	791440061101	BF7720	791440062375	BT8493	791440063709	PA4600
791440058866	BF7691	791440060050	BW5250	791440061125	PA4138	791440062382	PA4570	791440063716	PA4601
791440058873	RS3934	791440060074	BA3964(4)	791440061132	BF7721	791440062399	P7196	791440063730	BF7756
791440058880	RS3935	791440060081	BA3965(4)	791440061163	BF7725	791440062474	B495-MPG	791440063747	PA4602



WARNING: These products can expose you to chemicals, including Diisononyl Phthalate, Carbon black extracts, Nickel, 1,3 Butadiene, Ethylene Oxide, Epichlorohydrin, which are known to the State of California to cause cancer, and Bisphenol-A, Ethylene Glycol, Ethylene Oxide, 1,3 Butadiene, Epichlorohydrin, which are known to the State of California to cause birth defects or other reproductive harm. For more information go to www.P65Warnings.ca.gov.

UPC TO BALDWIN (INDIVIDUAL PARTS)

UPC NUMBER	BALDWIN NUMBER	UPC NUMBER	BALDWIN NUMBER	UPC NUMBER	BALDWIN NUMBER	UPC NUMBER	BALDWIN NUMBER	UPC NUMBER	BALDWIN NUMBER
791440063761	B7219	791440065000	BF7806	791440065918	BK6189	791440066885	PA4668	791440067905	PA4713
791440063785	BF1275	791440065017	P7233	791440065949	PKG490-BANK	791440066892	PA4669	791440067912	PA4714
791440063792	RS4597	791440065024	BF7807	791440065956	BK6675	791440066922	B5145	791440067929	PA4715
791440063808	PA4604-FN	791440065031	BF7808	791440065963	BK6676	791440066953	BF7775	791440067936	PA4716
791440063815	PA4605	791440065048	PA4156 KIT	791440065987	G704	791440066960	BF7776	791440067974	PA4720
791440063822	PA4606	791440065055	PA4157	791440065994	G710	791440066977	BF5816	791440068001	PA4723
791440063839	PF7758	791440065062	BF1350-SP	791440066007	G369-V	791440067004	PF7777	791440068049	PA4727
791440063846	PA4607	791440065079	BF7809	791440066014	BF1346-SP	791440067011	BF7778	791440068063	PA4729
791440063853	PA4608	791440065086	P7235	791440066038	BF1351-SP	791440067028	BT8905	791440068070	PA4730
791440063877	B7220	791440065093	PT8884-MPG	791440066045	BK6693	791440067035	B7246	791440068087	PA4731
791440063884	BK6683	791440065130	PF7812 KIT	791440066052	BF1286	791440067042	RS4672	791440068094	PA4732
791440063891	PA4611	791440065147	PT8519-MPG	791440066069	PT8894-MPG	791440067059	RS4673	791440068100	PA4733
791440063907	B7221	791440065154	BF7766	791440066076	PT8895-MPG	791440067066	PA4674-FN	791440068117	PA4734
791440063914	B7222	791440065161	PT8885-MPG	791440066083	PA4164	791440067073	PA4168	791440068124	PA4735
791440063921	PA4610 KIT	791440065178	PA4628	791440066090	PA4165	791440067080	PF7779	791440068131	PA4736 FOAM
791440063938	PA4612	791440065192	BT8886-MPG	791440066106	PA4653	791440067103	BK6670	791440068148	PA4737
791440063952	PA4614	791440065215	RS4629	791440066113	PT8896	791440067127	BT8906	791440068155	PA4738
791440063969	BF7760	791440065246	RS4623	791440066120	BK6440	791440067134	PA4169	791440068179	PA4740
791440063976	PT8461	791440065253	PA4158	791440066144	BF7769	791440067141	BF7780	791440068186	PA4741
791440063990	BK6685	791440065284	PA4631-FN	791440066151	PA4654 KIT	791440067158	PT8907-MPG	791440068209	PA4743
791440064027	BF7759	791440065314	BF7813	791440066168	PF7770	791440067165	P7247	791440068278	PA4750
791440064034	B7197	791440065321	RS4634	791440066182	PA4655	791440067196	BK6691	791440068308	PA4753
791440064041	RS4616	791440065338	PA4632	791440066212	PT8897-MPG	791440067219	B7249-MPG	791440068315	PA4754
791440064058	RS4617	791440065345	PA4633	791440066229	BC7242	791440067226	BT8908	791440068322	PA4755
791440064065	B5144	791440065352	BF7814	791440066236	BT8898	791440067233	BF7815	791440068339	PA4756
791440064072	BF1278	791440065369	RS4636	791440066243	BT8899	791440067240	PT8909	791440068353	PA4758
791440064089	BF1279	791440065376	RS4637	791440066250	PT8517-MPG	791440067264	RS4676	791440068377	PA4760
791440064157	BF7762	791440065383	B7238	791440066267	PA4656	791440067271	RS4677	791440068407	PA4763
791440064164	B7223	791440065390	RS4638	791440066274	BF7771	791440067288	RS4678	791440068414	PA4764
791440064225	BK6903	791440065406	PA4159	791440066281	PA4657	791440067295	RS4679	791440068438	PA4766
791440064287	BF7763	791440065413	PA4635	791440066298	BW5182	791440067301	BT8910-MPG	791440068469	PA4769
791440064317	PA4151	791440065420	PF7755	791440066304	BT8900	791440067318	BT8911-MPG	791440068490	PA4772
791440064355	BK6467	791440065437	BF1339-SP	791440066311	PA4658	791440067325	RS4680	791440068506	PA4773
791440064386	RS4618	791440065444	PA4160	791440066328	PA4659	791440067363	PA4681	791440068520	RS4775
791440064393	RS4613	791440065451	RS4161	791440066335	PA4660	791440067370	20005	791440068551	PA4777
791440064409	RS4620	791440065468	PT8887	791440066342	OS8706	791440067387	BD7250	791440068568	PA4778
791440064416	RS4621	791440065475	B7239	791440066359	OS8707	791440067394	BD7252	791440068599	PA4781
791440064423	RS4622	791440065482	B10-AL BSP	791440066366	B7243	791440067400	PT8912	791440068636	PA4785
791440064430	B7224	791440065499	B7240	791440066380	BF7681-D	791440067424	PA4682	791440068681	PA4790
791440064478	B7225	791440065505	PT8888	791440066397	BF7679-D	791440067431	PKG475	791440068711	PA4793
791440064485	BF7765	791440065512	RS4639	791440066403	BF7672-D	791440067448	PKG475-S	791440068728	RS4794
791440064492	PA4152	791440065529	PT8511	791440066410	BF7682-D	791440067455	BK6184	791440068735	PA4795
791440064508	PA4153	791440065536	PA4162	791440066427	BF7675-D	791440067462	BF1353-SPS	791440068797	PA4801
791440064515	PA4154	791440065543	PF7767	791440066434	BF7673-D	791440067486	PF7782	791440068803	PA4802
791440064553	19996	791440065550	PA4630	791440066441	BF7674-D	791440067493	BF7783-D	791440068810	RS4803
791440064584	19999	791440065574	PA4641	791440066458	BF7677-D	791440067509	BF7784-D	791440068827	RS4804
791440064591	20000	791440065581	RS4642	791440066465	BF7746-D	791440067516	BF7785-D	791440068841	RS4806
791440064607	20001	791440065598	RS4643	791440066472	BF7745-D	791440067523	PA4683	791440068858	RS4807
791440064614	20002	791440065604	PT8889	791440066489	BF7699-D	791440067530	BF7786-D	791440068872	PA4809
791440064621	B7227	791440065611	PA4644	791440066496	BT8901-MPG	791440067547	PA4852	791440068889	PA4810
791440064645	BC7228	791440065628	PA4645-FN	791440066502	BK6934	791440067554	PA4852 FOAM	791440068919	PA4813
791440064652	PA4624	791440065635	RS4646	791440066511	CA4700	791440067561	PA4853	791440068926	PA4814
791440064669	PA4625	791440065642	PA4647	791440066588	PA4701	791440067578	PA4854	791440068971	PA4819
791440064676	PA4615	791440065659	PA4648	791440066595	BF7772	791440067592	PA4855	791440068988	PA4820
791440064683	B7229	791440065666	PA4649	791440066601	PA4665-FN	791440067615	PA4688	791440069015	PA4823
791440064690	PA4619	791440065673	B5090	791440066618	PA4666	791440067622	PA4688 FOAM	791440069022	PA4824
791440064768	PF7799	791440065680	B7241	791440066649	BT8902	791440067639	PA4689	791440069039	PA4825
791440064775	BF7800	791440065697	BT8890-MPG	791440066656	PA4166	791440067646	PA2068 FOAM	791440069053	PA4827
791440064782	BF7801	791440065727	PA4650-FN	791440066663	BT8903	791440067653	PA2223 FOAM	791440069077	PA4829
791440064799	BF7802	791440065734	PT8891-MPG	791440066670	BT8904-MPG	791440067660	PA3901 FOAM	791440069084	PA4830
791440064805	BF1285-SP	791440065741	BT8892-MPG	791440066694	BF7773	791440067691	PA3472	791440069091	PA4832
791440064836	BT8512	791440065758	PA4651	791440066700	BF7774	791440067745	PA4692	791440069107	PA4833-FN
791440064843	PF7761	791440065765	20003	791440066717	PA4704	791440067752	PA4693	791440069114	PA4834-FN
791440064850	P7230	791440065796	20004	791440066724	CA4702	791440067769	PA4694	791440069251	PA4848
791440064881	B7231	791440065802	65-W30	791440066731	CA4703	791440067776	PA4695	791440069268	PA4849
791440064898	PA4603	791440065819	75-W30	791440066748	ES3231	791440067783	PA4696 FOAM	791440069299	PF7787
791440064928	B1447	791440065826	100-W30	791440066755	B7299	791440067790	PA4697-FN	791440069305	PF7788
791440064935	PT8883	791440065833	150-W30	791440066762	PA4167	791440067806	PA4698	791440069312	PF7816
791440064942	P7232	791440065840	300-W30	791440066779	B7245	791440067820	PA4705	791440069329	PF7817
791440064959	PA4626	791440065857	66-30	791440066830	B7700	791440067837	PA4706	791440069336	PF7818
791440064966	PA4627	791440065864	PT8893	791440066847	PA4661	791440067844	PA4707	791440069343	PF7819
791440064973	BF7803	791440065871	BF7768	791440066854	PA4662	791440067851	PA4708	791440069350	PF7820
791440064980	BF7804	791440065888	PA4163	791440066861	PA4663	791440067868	PA4709	791440069367	BF7821
791440064997	BF7805	791440065895	PA4652	791440066878	PA4664	791440067882	PA4711	791440069374	PF7822



WARNING: These products can expose you to chemicals, including Diisononyl Phthalate, Carbon black extracts, Nickel, 1,3 Butadiene, Ethylene Oxide, Epichlorohydrin, which are known to the State of California to cause cancer, and Bisphenol-A, Ethylene Glycol, Ethylene Oxide, 1,3 Butadiene, Epichlorohydrin, which are known to the State of California to cause birth defects or other reproductive harm. For more information go to www.P65Warnings.ca.gov.

UPC TO BALDWIN (INDIVIDUAL PARTS)

UPC NUMBER	BALDWIN NUMBER	UPC NUMBER	BALDWIN NUMBER	UPC NUMBER	BALDWIN NUMBER	UPC NUMBER	BALDWIN NUMBER	UPC NUMBER	BALDWIN NUMBER
791440069381	PF7823	791440070332	PT8974-MPG	791440071278	PT9190	791440072312	OAS99016	791440073425	PA2069 FOAM
791440069398	PF7824	791440070349	PT8975-MPG	791440071285	PT9191	791440072329	OAS99017	791440073432	PA2067 FOAM
791440069404	PF7825	791440070370	PT8978-MPG	791440071308	PT9193	791440072336	OAS99018	791440073463	RS4864
791440069411	PF7826	791440070394	PT8980-MPG	791440071322	PT9195	791440072343	OAS99019	791440073470	RS4861
791440069428	PF7828	791440070400	PT8981-MPG	791440071339	PT9196	791440072350	OAS99020	791440073531	BT9316-MPG
791440069435	PF7829	791440070417	PT8982-MPG	791440071346	PT9197	791440072367	OAS99021	791440073548	BT8475-MPG
791440069442	PF7830	791440070431	PT8984-MPG	791440071353	PT9198	791440072381	OAS99023	791440073555	BT8477-MPG
791440069466	PF7832	791440070448	PT8985-MPG	791440071360	PT9199	791440072398	OAS99024	791440073579	BT9320
791440069473	PF7833	791440070455	PT8986-MPG	791440071377	PT9200	791440072404	OAS99025	791440073586	BT9321
791440069480	PF7834	791440070462	PT8987-MPG	791440071391	PT9202	791440072435	OAS99028	791440073616	BT9324
791440069503	PF7836	791440070486	PT8989-MPG	791440071407	PT9203	791440072442	OAS99029	791440073630	BT9326
791440069510	BF7837	791440070493	PT8990-MPG	791440071421	PT9205	791440072466	OAS99031	791440073647	PT9282-MPG
791440069527	BF7838	791440070509	PT8991-MPG	791440071438	PT9206	791440072473	OAS99032	791440073654	PT9283-MPG
791440069534	BF7839	791440070516	PT8992-MPG	791440071445	PT9207	791440072497	PF7852 KIT	791440073661	PT9284-MPG
791440069541	BF7840	791440070523	PT8993-MPG	791440071452	PT9208	791440072503	PA4857	791440073678	PT9285-MPG
791440069558	BF7841	791440070530	PT8994-MPG	791440071469	PT9209	791440072510	BK6183	791440073685	PT9289-MPG
791440069565	BF7842	791440070547	PT8995-MPG	791440071476	PT9210	791440072527	PA4858	791440073692	PT9287-MPG
791440069572	BF7843	791440070554	PT8996-MPG	791440071483	BT9211	791440072534	BF7853	791440073708	PT9288-MPG
791440069589	BF7844	791440070561	PT8997-MPG	791440071490	PT9212	791440072541	RS4859	791440073715	PT9289-MPG
791440069596	BF7845	791440070578	PT8998-MPG	791440071506	PT9213	791440072558	PA4860	791440073722	PT9290-MPG
791440069619	BF7847	791440070585	PT8999-MPG	791440071513	PT9214	791440072565	RS4862	791440073739	PT9291-MPG
791440069626	BF7848	791440070615	PT9125-MPG	791440071520	PT9215	791440072572	RS4863	791440073760	PT9283-MPG
791440069633	BF7849	791440070639	PT9126	791440071544	PT9217	791440072596	BK6665	791440073784	PT9295-MPG
791440069640	BF7850	791440070646	PT9127	791440071582	PT9221	791440072602	PA4170	791440073791	PT9296-MPG
791440069657	BF7851	791440070660	PT9129	791440071599	PT9222	791440072626	PA4877	791440073807	PT9289-MPG
791440069664	BF7736-K1	791440070677	PT9130	791440071605	PT9223	791440072633	PA4878	791440073838	PT9300-MPG
791440069671	BT8913-MPG	791440070684	PT9131	791440071612	PT9224	791440072640	PA4879	791440073852	PT9302-MPG
791440069688	BT8476-MPG	791440070691	PT9132	791440071629	PT9225	791440072664	PA4881	791440073869	PT9303-MPG
791440069695	BT366-MPG	791440070714	PT9134	791440071643	PT9227	791440072671	PA4882	791440073876	PT9304-MPG
791440069701	BT351-MPG	791440070721	PT9135	791440071650	PT9228	791440072688	PA4883	791440073890	PT9306-MPG
791440069718	BT371-5	791440070738	PT9136	791440071681	H9231	791440072701	PA4885	791440073906	PT9307-MPG
791440069725	BT8914	791440070745	PT9137	791440071735	PT7255	791440072718	PA4886	791440073913	PT9308-MPG
791440069732	BT8915	791440070769	PT9139	791440071742	PT7256	791440072725	PA4887	791440073920	PT9309-MPG
791440069749	BT8916	791440070776	PT9140	791440071773	PT7259	791440072732	PA4888	791440073937	PT9310-MPG
791440069756	BT8917	791440070790	PT9142	791440071780	PT7260	791440072749	PA4889	791440073944	PT9311-MPG
791440069763	BT8918	791440070806	PT9143	791440071797	PT7261	791440072756	PA4890	791440073951	PT9312-MPG
791440069770	BT8919	791440070813	PT9144	791440071803	PT7262	791440072763	PA4891	791440073968	PT9313-MPG
791440069787	BT8920	791440070820	PT9145	791440071810	PT7263	791440072787	PA4893	791440073982	PT9315 KIT
791440069794	BT8921	791440070844	PT9147	791440071827	PT7264	791440072800	PA4895	791440074002	PT9236-MPG
791440069800	BT8922	791440070851	PT9148	791440071834	PT7265	791440072817	PA4896	791440074019	PT9237
791440069848	BT8926	791440070868	PT9149	791440071858	PT7267	791440072824	PA4897	791440074026	PT9238
791440069855	BT8927	791440070875	PT9150	791440071865	PT7268	791440072848	PA4900	791440074033	PT9239
791440069862	BT8928	791440070899	PT9152	791440071872	PT7269	791440072862	PA4902	791440074040	PT9240
791440069886	BT8930	791440070905	PT9153	791440071889	BF7880	791440072879	PA4903	791440074064	PT9242
791440069893	BT8931	791440070912	PT9154	791440071896	B7271	791440072893	PA4905	791440074088	PT9244
791440069930	BT8935	791440070929	PT9155	791440071919	B7273	791440072909	PA4906	791440074095	PT9245
791440069954	BT8937	791440070943	PT9157	791440071926	B7274	791440072916	PA4907	791440074101	PT9246
791440069961	PT8938-MPG	791440070950	PT9158	791440071933	B7275	791440072923	PA4908	791440074118	PT9247
791440069978	PT8939-MPG	791440070967	PT9159	791440071940	B7276	791440072947	PA4910	791440074125	PT9248
791440069985	PT8940-MPG	791440070981	PT9161	791440071957	B7277	791440072954	PA4911	791440074149	PT9250
791440069992	PT8941-MPG	791440070998	PT9162	791440071988	B7280	791440073029	PA4918	791440074156	PT9251
791440070011	PT8943-MPG	791440071001	PT9163	791440071995	B7281	791440073036	PA4919	791440074187	PT9254
791440070035	PT8945-MPG	791440071018	PT9164	791440072015	B7283	791440073098	PA4925	791440074194	PT9255
791440070042	PT8946-MPG	791440071025	PT9165	791440072039	B7285	791440073128	PA4928	791440074200	PT9256-MPG
791440070059	PT8947-MPG	791440071049	PT9167	791440072046	B7286	791440073135	PA4929	791440074217	PT9257
791440070066	PT8948-MPG	791440071056	PT9168	791440072053	B7287	791440073142	PA4930	791440074224	PT9258
791440070080	PT8950-MPG	791440071063	PT9169	791440072077	B7289	791440073159	PA4931	791440074231	PT9259
791440070097	PT8951-MPG	791440071070	PT9170	791440072084	B7290	791440073166	PA4932	791440074248	PT9260
791440070103	PT8952-MPG	791440071087	PT9171	791440072091	B7291	791440073180	PA4934	791440074255	PT9261-MPG
791440070127	PT8954-MPG	791440071094	PT9172	791440072107	B7292	791440073197	PA4935	791440074286	PT9264
791440070134	PT8955-MPG	791440071117	PT9174	791440072114	B7293	791440073227	PA4938	791440074309	PT9266
791440070141	PT8956-MPG	791440071124	PT9175	791440072121	B7294	791440073234	PA4939	791440074316	PT9267
791440070158	PT8957-MPG	791440071131	PT9176	791440072138	B7295	791440073258	PA4941	791440074323	PT9268
791440070165	PT8958-MPG	791440071155	PT9178	791440072169	OAS99001	791440073265	PA4942	791440074361	PT9272
791440070172	PT8959-MPG	791440071162	PT9179	791440072176	OAS99002	791440073296	PA4866	791440074415	PT9277
791440070189	PT8960-MPG	791440071179	PT9180	791440072183	OAS99003	791440073302	PA4867	791440074422	PT9278
791440070219	PT8962-MPG	791440071186	PT9181	791440072190	OAS99004	791440073333	PA4865-FN	791440074439	PT9279
791440070226	PT8963-MPG	791440071193	PT9182	791440072206	OAS99005	791440073340	PA4870-FN	791440074477	BF7868
791440070264	PT8967-MPG	791440071209	PT9183	791440072213	OAS99006	791440073357	PA4871	791440074484	PF7869
791440070271	PT8968-MPG	791440071223	PT9185	791440072237	OAS99008	791440073364	PA4872	791440074491	BF7870
791440070288	PT8969-MPG	791440071230	PT9186	791440072251	OAS99010	791440073371	PA4873	791440074507	BF7871
791440070295	PT8970-MPG	791440071247	PT9187	791440072268	OAS99011	791440073388	PA4874	791440074514	PF7872
791440070301	PT8971-MPG	791440071254	PT9188	791440072299	OAS99014	791440073401	PA4876	791440074521	PF7873
791440070318	PT8972-MPG	791440071261	PT9189	791440072305	OAS99015	791440073418	PA3957 FOAM	791440074538	PF7874



WARNING: These products can expose you to chemicals, including Diisononyl Phthalate, Carbon black extracts, Nickel, 1,3 Butadiene, Ethylene Oxide, Epichlorohydrin, which are known to the State of California to cause cancer, and Bisphenol-A, Ethylene Glycol, Ethylene Oxide, 1,3 Butadiene, Epichlorohydrin, which are known to the State of California to cause birth defects or other reproductive harm. For more information go to www.P65Warnings.ca.gov.

UPC TO BALDWIN (INDIVIDUAL PARTS)

UPC NUMBER	BALDWIN NUMBER	UPC NUMBER	BALDWIN NUMBER	UPC NUMBER	BALDWIN NUMBER	UPC NUMBER	BALDWIN NUMBER	UPC NUMBER	BALDWIN NUMBER
791440074545	PF7875	791440075924	BF7881	791440077041	B7318	791440077980	BF7911	791440079021	BW5183
791440074552	PF7877	791440075955	PA4979	791440077058	PA5302	791440077997	PA4175	791440079038	BF1371
791440074569	PF7877	791440075962	PA4978	791440077072	PA5303	791440078000	PA4176	791440079045	PA5350
791440074576	BF7855	791440075979	PA4977-FN	791440077089	P7319	791440078017	PT9359-MPG	791440079052	BF7923
791440074590	BF7857	791440075993	PA4975	791440077096	PF7896	791440078024	BT9360	791440079069	P7330
791440074613	BF7859	791440076013	PA4973	791440077102	RS5304	791440078031	PT9361	791440079083	PT9378-MPG
791440074620	BF7860	791440076037	BK6663	791440077119	BK6613	791440078048	BF1293-SPS	791440079090	PA4184
791440074637	BF7861	791440076099	BK6662	791440077126	RS5305	791440078055	BF1272-SPS	791440079106	PT9373-MPG
791440074644	BF7863	791440076112	PT9337-MPG	791440077133	PA5306	791440078062	20013	791440079113	PT7332
791440074651	BF7864	791440076198	G494	791440077157	BF7898-D	791440078109	BT9362-MPG	791440079120	RS5351
791440074668	BF7865	791440076204	G523-AF	791440077164	BK6186	791440078116	BT9363-MPG	791440079137	CA5352
791440074675	BF7866	791440076211	ES1039	791440077171	B7320	791440078123	PA4177	791440079144	CTK5029-M
791440074699	B7837	791440076235	G1972	791440077188	PA4173	791440078130	BF7912	791440079151	BF7927
791440074705	B7298	791440076259	PT9338-MPG	791440077195	PA4174	791440078147	BK6463	791440079168	PT9379
791440074736	P7302	791440076266	BT7349	791440077256	PA5310	791440078154	BF7913	791440079182	PT9380-MPG
791440074743	P7303	791440076280	BF7883	791440077263	P7321	791440078161	BF1252-SPS	791440079199	BF1373-SP
791440074774	OAS99034	791440076297	B7306	791440077270	PF7899	791440078178	PA5330	791440079205	BK6299
791440074781	OAS99035	791440076303	PA4984-FN	791440077287	PF900	791440078185	BF1361	791440079212	PT9415-MPG KIT
791440074804	OAS99037	791440076310	PA4983	791440077300	PA4640-FN	791440078192	PA5331	791440079229	PT9416-MPG KIT
791440074811	OAS99038	791440076341	PT9340-MPG	791440077317	PT9352	791440078208	BK6187	791440079236	RS5354
791440074835	OAS99040	791440076365	BK6661	791440077324	B7322	791440078369	BK6923	791440079243	RS5355
791440074859	OAS99042	791440076372	PA4985	791440077331	PA5311	791440078376	RS5332	791440079250	BF7924
791440074866	OAS99043	791440076389	PA4986	791440077348	PA5312 KIT	791440078390	BT9364	791440079267	BF1374-SP
791440074927	PA4171	791440076396	PA4987	791440077355	RS5313	791440078406	PF7914	791440079274	BF1375
791440075009	BT9318	791440076419	BF1355-SP	791440077362	PA5314	791440078413	BF7915	791440079281	PT9381-MPG
791440075016	H9327	791440076433	BF7886	791440077379	BF7903	791440078420	BT9365-MPG	791440079298	BT9382
791440075023	PT9328-MPG	791440076440	PKG475-R	791440077386	BF7904-D	791440078437	BT9366-MPG	791440079304	BF1376
791440075030	P7305	791440076464	P7308	791440077393	B7396	791440078444	PA5333	791440079335	BK6181
791440075047	PF7878	791440076488	BF5587-D	791440077409	BT9353-MPG	791440078451	BT9367-MPG	791440079342	BF1372
791440075054	PA4960-FN	791440076495	BK6658	791440077416	BF7905-D	791440078475	RS5335	791440079359	BF1377
791440075078	PA4961	791440076501	BK6659	791440077423	BF7906-D	791440078482	BF1283-SP	791440079366	PA4185
791440075092	PA4912	791440076518	RS4988	791440077430	BF7907	791440078499	BF1362	791440079380	FD7926
791440075108	PA4945	791440076525	PT9341	791440077447	F81306	791440078505	BT9368-MPG	791440079397	BF7925
791440075122	PA4947	791440076532	B7311-MPG	791440077454	PA5315	791440078512	BT9369-MPG	791440079403	PA5353
791440075191	PA4954	791440076549	P7312	791440077461	PA5316	791440078529	BC7326	791440079410	BK6429
791440075207	PA4955	791440076563	RS4989	791440077478	PA5317	791440078536	PF7916	791440079427	RS5356
791440075214	PA4956	791440076570	P7313	791440077485	PT9354-MPG	791440078543	PA5336	791440079434	PA5357
791440075221	PA4957	791440076587	PT9342-MPG	791440077492	PA5318	791440078550	BF7917	791440079441	PT9383-MPG
791440075245	PT9329	791440076594	PA4991	791440077508	PA5319	791440078567	B7327	791440079458	PT9384-MPG
791440075252	RS4959	791440076600	PF7889	791440077515	PA5320	791440078574	BT9370-MPG	791440079465	RS5358
791440075269	RS4962	791440076617	PF7889-10	791440077522	PA5321	791440078598	BK6464	791440079472	PT9385-MPG
791440075276	RS4963	791440076624	PF7889-30	791440077539	H9075-V	791440078604	BF1355	791440079489	PT9386-MPG
791440075283	RS4966	791440076631	PF7890	791440077553	BF7908	791440078611	BF1363	791440079502	BF1378-SPS
791440075290	RS4967	791440076648	PF7890-10	791440077560	BF7909	791440078635	PA5337	791440079519	G534-AF
791440075306	RS4968	791440076655	PF7890-30	791440077577	PT9355-MPG	791440078642	PA5338-FN	791440079526	PA5359
791440075313	RS4969	791440076662	BT9343-MPG	791440077584	PF7910	791440078659	B7328	791440079533	PF7928
791440075320	RS4970	791440076679	RS4992	791440077591	O58717	791440078666	PA4178	791440079540	BF7929 KIT
791440075337	RS4971	791440076686	RS4994	791440077621	H9043-V	791440078673	PA4179	791440079557	RS5360
791440075344	RS4972	791440076693	RS4995	791440077652	BT9356	791440078680	PA4180	791440079564	RS5361
791440075351	P1561	791440076723	BF798-SP	791440077669	PA5323	791440078687	PA4181	791440079561	PA5363
791440075368	P1562	791440076730	PT9344	791440077676	B7324	791440078703	PA4182	791440079568	BF1379
791440075375	P1563	791440076747	B7314	791440077683	PT9357	791440078710	PA4183	791440079625	BF1380
791440075399	P1565	791440076754	BF1356	791440077690	PF7977	791440078727	BT9371-MPG	791440079632	BF1381
791440075405	P1566	791440076761	PA4172	791440077706	PA5324-FN	791440078741	RS5334	791440079649	PA4187
791440075436	P1567	791440076785	RS4993	791440077713	RS5325	791440078758	BF1365	791440079656	BF1382-SP
791440075443	P1568	791440076792	BT9345	791440077720	PA5326	791440078796	PT9372	791440079687	PF7930
791440075528	PF1584	791440076808	CA4999	791440077744	BD7325	791440078819	BF7919	791440079779	BK6649
791440075535	PF1585	791440076815	BT9346-MPG	791440077775	BF1359-SP	791440078840	BA5374	791440079786	PA5364
791440075559	P1575	791440076822	BT9347-MPG	791440077805	20008	791440078857	BA5375	791440079793	PA5365
791440075566	P1576	791440076839	PT9348-MPG	791440077812	20009	791440078864	BA5376	791440079830	B7333
791440075573	P1577	791440076846	BT9349-MPG	791440077829	20010	791440078871	PA5339	791440079847	BF7931
791440075597	PF1587	791440076853	BF1357	791440077836	20011	791440078888	PT9374	791440079854	BF7932
791440075610	PF1589	791440076860	BF7888	791440077843	BK6426	791440078895	PA5340	791440079861	CA5366
791440075634	P1578	791440076877	BF1358-SP	791440077850	20012	791440078901	BF7921	791440079885	CA5368
791440075665	BF7879	791440076884	BF7892	791440077867	PA5327	791440078918	PA5341	791440079892	CA5369
791440075733	PT9330-MPG	791440076907	PA5300	791440077874	PA5328	791440078932	PT9375	791440079908	CA5370
791440075757	H9072-V	791440076914	BT7316	791440077881	RS5329	791440078949	PT9376	791440079915	BT9387
791440075764	H9076-V	791440076952	BK6185	791440077904	BK6666	791440078956	BT9377	791440079946	BT7397
791440075771	H9078-V	791440076969	BD7317	791440077911	BT9358	791440078963	P7329	791440079953	BT9388
791440075818	OAS99046	791440076976	PT9350-MPG	791440077928	BK6444	791440078970	RS5342	791440079977	RS5387 KIT
791440075849	PT9335-MPG	791440076983	PT9351-MPG	791440077935	BK6451	791440078987	RS5343	791440079984	PA5388
791440075870	PT9332	791440076990	RS5301	791440077942	BK6452	791440078994	BF1367	791440079991	PT9389-MPG
791440075887	PT9331	791440077027	PF7894	791440077966	BK6654	791440079007	BF7922	791440080010	RS5389-FN
791440075917	PF7882	791440077034	PF7895	791440077973	BF1360	791440079014	BF1370	791440080027	PT9390-MPG



WARNING: These products can expose you to chemicals, including Diisononyl Phthalate, Carbon black extracts, Nickel, 1,3 Butadiene, Ethylene Oxide, Epichlorohydrin, which are known to the State of California to cause cancer, and Bisphenol-A, Ethylene Glycol, Ethylene Oxide, 1,3 Butadiene, Epichlorohydrin, which are known to the State of California to cause birth defects or other reproductive harm. For more information go to www.P65Warnings.ca.gov.

UPC TO BALDWIN (INDIVIDUAL PARTS)

UPC NUMBER	BALDWIN NUMBER	UPC NUMBER	BALDWIN NUMBER	UPC NUMBER	BALDWIN NUMBER	UPC NUMBER	BALDWIN NUMBER	UPC NUMBER	BALDWIN NUMBER
791440080034	RS5390	791440080904	BF7942	791440081673	20015	791440082458	PA4374	791440083295	BK6942
791440080041	B7335-MPG	791440080911	P7406	791440081680	20016	791440082465	PT9406-MPG	791440083301	PT450
791440080058	B7334	791440080928	RS5395-FN	791440081697	20017	791440082472	PA4375	791440083318	B7451
791440080065	BT9391-MPG	791440080935	PA5396	791440081710	20019	791440082489	PA4376	791440083325	BF1360-SP
791440080089	RS5391	791440080942	RS5397	791440081727	20020	791440082496	PA4377	791440083332	BF7949-DM
791440080102	P7336 KIT	791440080959	RS5398	791440081734	BK6983	791440082502	PA4380	791440083340	BF7971-D
791440080119	BT9392-MPG	791440080966	PA5399	791440081741	BF7951-D	791440082519	PA4381	791440083356	BF7971-DM
791440080126	BT9393-MPG	791440080973	PA5400	791440081758	BF7952-D	791440082526	PA4382	791440083363	B7452
791440080133	PF7934 KIT	791440080980	PA5401	791440081772	BF7954-D	791440082533	PA4383	791440083370	RS5438
791440080157	BK6930	791440081000	PA5403	791440081789	B7419	791440082540	PA4384	791440083387	BK6943
791440080164	BK6931	791440081017	PA5404	791440081796	PA4338	791440082557	PA4385	791440083394	BK6944
791440080171	RS5392	791440081024	PA5405	791440081802	PA4340	791440082564	PA4386	791440083400	BK6945
791440080201	BK6933	791440081031	PA5406-FN	791440081819	PA4341	791440082571	PA4387	791440083417	BK6946
791440080218	PF7935	791440081048	PA4323	791440081826	PA4344	791440082588	BF7962	791440083424	BK6947
791440080225	PA5393	791440081055	B7407	791440081833	PA4345	791440082595	BF7963	791440083431	BK6948
791440080249	BF1384-SP	791440081062	PA4324	791440081840	PA4348	791440082601	BF7964-D	791440083448	BK6949
791440080263	P7337	791440081079	PA5407	791440081857	PA4349	791440082618	PT9407-MPG	791440083455	BK6950
791440080270	PA4188	791440081086	PA4327	791440081864	PA4350	791440082625	B7405	791440083462	BK6951
791440080287	P7338	791440081093	PA4328	791440081871	PA4351	791440082632	BT9408	791440083486	B7453
791440080294	RS4189	791440081109	PA4325	791440081888	PA4352	791440082649	PA4388	791440083493	RS5434
791440080300	PA4190	791440081116	RS5409	791440081895	RS5422	791440082656	PA4389	791440083516	PA4410 KIT
791440080317	PA4191	791440081123	RS5408	791440081901	BF7955	791440082663	PA5425	791440083530	OP8750
791440080324	BK6993	791440081130	PA5410-FN	791440081918	B7420	791440082670	PA4390	791440083547	OP8751
791440080331	PF7936	791440081147	RS5411	791440081925	B7422	791440082687	PA5426	791440083554	OP8752
791440080348	P7398	791440081154	BF7943	791440081932	BF7956-D	791440082717	P7436	791440083561	OP8753
791440080355	P7399	791440081161	PA5412	791440081949	P7423	791440082724	P7437	791440083578	PA4411
791440080362	P7400	791440081178	RS5413	791440081956	BA5371	791440082748	BF1392-SPS KIT	791440083585	P7454
791440080379	B7401	791440081185	P7408	791440081963	PA5423-FN	791440082755	BF7965	791440083592	PA4412
791440080386	20014	791440081192	B7409	791440081970	PT9399-MPG	791440082762	PA4391	791440083608	PA4413
791440080393	BF7937	791440081208	B7410	791440081987	P7417	791440082786	PA4392	791440083615	PA4414
791440080409	PA4192	791440081215	PA4329	791440081994	PA4353	791440082793	PA4393	791440083639	PA5436
791440080416	PA4193	791440081222	P7411	791440082014	PA4355	791440082809	PT9409-MPG	791440083646	RS5440
791440080423	PA4194	791440081239	RS5414	791440082021	PA4356	791440082816	B7440	791440083653	RS5441
791440080430	PA4195 KIT	791440081246	RS5415	791440082038	PA4357	791440082823	BF7966	791440083660	P7455
791440080447	PA4196	791440081253	BF1386-O	791440082045	PA4358	791440082830	B5091	791440083677	PA4416 KIT
791440080454	PA4197	791440081260	BF7944	791440082052	PA4359	791440082847	HSG3077	791440083684	BF7969
791440080461	PA4198	791440081277	P7413	791440082069	PA4360	791440082854	B7441	791440083691	PT9414-MPG
791440080478	PA4199	791440081284	P7414	791440082076	PA4361	791440082861	PA4394	791440083707	PA5444-FN
791440080485	PA4303	791440081291	RS5344	791440082083	PA4362	791440082878	PA5428	791440083714	PA5445
791440080492	PA4304	791440081307	RS5345	791440082090	B7424	791440082885	PA4395	791440083721	PA5446
791440080508	PA4305	791440081321	RS5347	791440082106	P7426	791440082915	BF7967	791440083738	RS5447
791440080515	PA4306	791440081338	RS5348	791440082113	P7427	791440082922	BF1393-SP	791440083745	RS5448
791440080522	PA4307	791440081345	BF1387-O	791440082120	BT9400-MPG	791440082939	RS5429	791440083752	BF7972
791440080539	PA4308	791440081352	BF1388-O	791440082137	PT9401	791440082946	RS5430	791440083769	P7438
791440080546	PA4309	791440081369	P7415	791440082144	BT9402	791440082953	BK6656	791440083776	PA4417
791440080553	SA4315	791440081376	PA4330	791440082151	RS5424	791440082960	RS5431	791440083783	BK6985
791440080560	PA4310	791440081383	PA4331	791440082168	B7428	791440082984	PA4397	791440083790	BK6986
791440080577	PA4311	791440081390	PA4332	791440082175	BK6652	791440082991	PA4398	791440083806	BK6953
791440080584	PA4312	791440081406	BF7945	791440082182	BF7957	791440083004	PA4399	791440083813	BK6954
791440080591	PA4313	791440081413	B7416	791440082199	PT9403-MPG	791440083011	PA4400	791440083820	BK6955
791440080607	PA4314	791440081420	CA5416	791440082205	BF1390-O	791440083028	P7442	791440083837	BC7456 KIT
791440080614	B7402	791440081437	CA5417	791440082212	PA4363	791440083035	RS5432	791440083844	RS5442
791440080621	B7403	791440081444	PA5418	791440082229	PA4364	791440083042	BF1394-SP	791440083851	RS5443
791440080638	PF7938	791440081451	CA5421	791440082236	PA4365	791440083059	RS5433	791440083868	PA4418
791440080645	BF1354-SPS	791440081468	CA5419	791440082243	PT9404-MPG	791440083066	PT9410-MPG	791440083875	PA4419
791440080652	PA4316	791440081475	CA5420	791440082250	BF1391-O	791440083073	PT9411-MPG	791440083893	PT9417
791440080669	PA4317	791440081482	BT9398-MPG	791440082267	PA4366	791440083080	BF1395-SP	791440083950	B7449
791440080720	PT9394-MPG	791440081499	PF7946	791440082274	B7430	791440083097	PA4401	791440083974	PT9418
791440080737	P7405	791440081505	PA4334	791440082281	B7429	791440083103	PA4402	791440083981	PF7973
791440080744	PA4318	791440081512	PA4335	791440082298	PT9405	791440083110	BK6653	791440083998	BK6987
791440080751	PA4319	791440081529	BK6980	791440082304	B7431	791440083127	BK6657	791440084001	BF1397-SP
791440080768	PT9395-MPG	791440081536	BK6981	791440082311	B7432	791440083134	PA4403	791440084018	B7350
791440080775	PA4320	791440081543	BK6982	791440082328	B7433	791440083141	PA4404	791440084025	BK6952
791440080799	200-DEPR KIT	791440081550	BK6984	791440082335	PA4367	791440083158	PA4405	791440084032	CV15000
791440080805	100-DEPR KIT	791440081567	BF1389-O	791440082342	PA4368	791440083196	PT9412-MPG	791440084049	BK6022
791440080812	100-MNTG KIT	791440081574	PA4333	791440082366	PA4370	791440083202	B7443	791440084056	BK6023
791440080829	PT9396	791440081581	PA4336	791440082373	PA4371	791440083219	B7444	791440084063	BK6024
791440080836	PT9397-MPG	791440081598	PF7947	791440082380	PA4372	791440083226	BF1396	791440084070	BK6025
791440080843	BF1385-SPS	791440081604	PA4337	791440082397	PA4373	791440083233	B7445	791440084087	BK6026
791440080850	PF7939	791440081611	P7418	791440082403	BF7958	791440083240	PA4409	791440084094	BF1399-SP
791440080867	BF7940	791440081635	BF7948	791440082410	BF7959	791440083257	BF7968	791440084100	PA5437
791440080874	BF7941	791440081642	OV8728	791440082427	BF7960	791440083264	B7446	791440084117	BK6997
791440080881	PA4321	791440081659	BF7949-D	791440082434	BF7961	791440083271	PT9413-MPG	791440084124	BK6027
791440080898	PA4322	791440081666	BF7950-D	791440082441	B7434	791440083288	BF1398-O	791440084148	PT9419-MPG



WARNING: These products can expose you to chemicals, including Diisononyl Phthalate, Carbon black extracts, Nickel, 1,3 Butadiene, Ethylene Oxide, Epichlorohydrin, which are known to the State of California to cause cancer, and Bisphenol-A, Ethylene Glycol, Ethylene Oxide, 1,3 Butadiene, Epichlorohydrin, which are known to the State of California to cause birth defects or other reproductive harm. For more information go to www.P65Warnings.ca.gov.

UPC TO BALDWIN (INDIVIDUAL PARTS)

UPC NUMBER	BALDWIN NUMBER	UPC NUMBER	BALDWIN NUMBER	UPC NUMBER	BALDWIN NUMBER	UPC NUMBER	BALDWIN NUMBER	UPC NUMBER	BALDWIN NUMBER
791440084155	PA4421	791440086234	B7362	791440087033	PT9426	791440087804	PA5523	791440088603	PA5564
791440084490	PT9453-MPG	791440086241	BF7987	791440087040	BF9802	791440087811	PA5526	791440088610	PA5565
791440085497	BT9553	791440086258	PA5467	791440087057	PA4430	791440087828	PA5527	791440088627	BF9839-D
791440085503	PF7974	791440086265	BF7988	791440087064	BT7237	791440087835	PA5528	791440088641	RS5559
791440085510	B7351-MPG	791440086272	PT9420-MPG	791440087071	PA5505	791440087842	PA5529	791440088658	B10-AL BSPCS
791440085527	PT9554-MPG	791440086289	BF7989-D	791440087088	PF9803	791440087859	PA5530	791440088665	BA5566
791440085534	PT9555	791440086296	PA5469	791440087095	BK6996	791440087866	PA5531	791440088672	BF1298-O
791440085541	PT9556-MPG	791440086302	PA5473	791440087101	PT9427-MPG	791440087873	PA5524	791440088689	B7466
791440085558	HSG3078	791440086319	PA5475	791440087118	PT9429-MPG	791440087880	PA5525	791440088696	BF9840
791440085565	AB3349	791440086326	PA5476	791440087125	BF1383-C	791440087903	PA5521	791440088702	B7467
791440085572	PT9557	791440086333	PA5477	791440087132	RS5507	791440087910	PT9432-MPG	791440088719	B7468
791440085589	PF7975	791440086340	RS5470	791440087149	PF9804	791440087927	BF9827-D	791440088726	B7469
791440085596	B7352	791440086357	RS5471	791440087156	RS5508	791440087934	PA5532	791440088733	BF9841
791440085602	BA5372	791440086364	RS5472	791440087170	BF9805	791440087941	PA5533	791440088740	B7470
791440085619	BA5373	791440086371	B7363	791440087187	B7372	791440087958	PA5463	791440088757	RS5536
791440085626	BA5377	791440086388	P7364	791440087194	RS5509	791440087965	PA4544	791440088764	RS5550
791440085633	RS5435	791440086395	BF1287-O	791440087200	RS5510	791440087972	BT9433	791440088771	RS5547
791440085640	BK6028	791440086401	BF1288-O	791440087217	BF1222-O	791440087989	BF9828-D	791440088788	RS5548
791440085657	BK6650	791440086418	PA4425	791440087224	BK6457	791440087996	RS5538	791440088795	RS5549
791440085664	PA5454	791440086425	PA4426	791440087231	PA4431	791440088009	RS5539	791440088801	BF9842
791440085671	RS5455	791440086432	BF7990	791440087248	PA5511	791440088016	RS5540	791440088818	B7472
791440085688	RS5456	791440086449	PA5482	791440087255	PA5512	791440088023	RS5541	791440088825	B7473
791440085695	BF7976	791440086456	P7365	791440087262	BF1345-O	791440088061	BK6034	791440088832	B7474
791440085701	BD7353	791440086487	BF7993	791440087293	CA5514	791440088078	BK6035	791440088849	B7475
791440085718	BA5378	791440086494	PA5480	791440087309	PA5515	791440088085	PA5545	791440088856	B7476
791440085725	BA5379	791440086500	RS5483	791440087316	B7373	791440088092	PT9434	791440088863	B7477
791440085732	RS5452	791440086517	RS5484	791440087323	BF9807	791440088108	PA4435	791440088870	B7478
791440085749	BK6029	791440086524	BK6033	791440087330	BF9808-D	791440088122	500-MFVBP22	791440088887	BF9843
791440085756	RS5453	791440086531	PA5485-FN	791440087347	PA5516	791440088139	RS5546	791440088900	BF9844
791440085763	PF7978	791440086548	PA5487	791440087354	BF1223-O	791440088146	BF9829-KIT	791440088917	B7481
791440085770	P7354	791440086555	B7367	791440087361	BF9809-D	791440088153	PF9829-KIT	791440088924	B7482
791440085787	PA5457	791440086562	PF1392	791440087378	BF9810-D	791440088160	PA4436	791440088931	B7483
791440085794	BD7355	791440086579	PA5486	791440087385	B7375	791440088177	PA4437	791440088948	PA5567
791440085800	BK6956	791440086586	RS5488	791440087392	B7376	791440088184	PT9435-MPG	791440088955	PA5568
791440085817	BT9558-MPG	791440086593	PA4427	791440087408	B7377	791440088191	BF9830-D	791440088962	PA5569
791440085824	PT9559-MPG	791440086609	PF7994	791440087415	BF9811-SP	791440088207	B7389	791440088979	PA5570
791440085831	RS5458	791440086616	BF7995	791440087422	B7378	791440088214	BF9831	791440088986	PA5572
791440085848	B7356	791440086623	P7368	791440087439	BF1290-O	791440088221	BF9832	791440088993	P7484
791440085855	BF1366-O	791440086630	RS5478-FN	791440087446	BF1292-O	791440088238	B7390	791440089006	PF9845
791440085862	BF7970	791440086647	RS5479	791440087453	BF1294-O	791440088245	B7392	791440089013	PA5573
791440085879	BF7979	791440086654	BK6438	791440087460	RS5506	791440088252	B7393	791440089020	PA5574
791440085886	B7357	791440086661	BK6161	791440087477	PT9430-MPG	791440088269	BF9833-D	791440089037	PA5575
791440085893	BF1329-O	791440086678	BF7996	791440087484	B7379	791440088276	BF9834	791440089044	PA5576
791440085909	RS5449	791440086685	PA4428	791440087491	RS5517	791440088283	BF9835-D	791440089051	BCT485
791440085916	B7359	791440086692	BT9421-MPG	791440087507	BF9812	791440088290	P7505	791440089068	PA5577
791440085923	BK6030	791440086708	20021	791440087514	BF9813	791440088306	B7457	791440089075	PA5578
791440085930	RS5459	791440086715	20022	791440087521	PF9814	791440088313	B7458	791440089082	PA5579
791440085947	RS5460	791440086722	20023	791440087538	B7383	791440088320	B7459	791440089099	BF9846
791440085954	PF7980	791440086739	20024	791440087545	B7384	791440088337	PA5551	791440089105	BF9847-D
791440085961	BK6031	791440086753	PA5491	791440087552	B7385	791440088344	PA5552	791440089112	BF1299-O
791440085978	BK6032	791440086760	PA5492	791440087569	B7386	791440088351	PA5553	791440089129	PA5571
791440085985	PA4422	791440086777	PA5493	791440087576	B7387	791440088368	PA5554	791440089136	BT9436-MPG
791440085992	PA4423	791440086784	BF7997	791440087583	BF9815	791440088375	PA5555	791440089143	B7486
791440086005	BF7981	791440086791	PA5494	791440087590	BF1295-O	791440088382	PA5556	791440089150	B7487
791440086012	BK6041	791440086807	PA5495	791440087606	BF9816	791440088399	PA5557	791440089167	PA4439
791440086029	BK6043	791440086814	BT9422	791440087613	BF1296-O	791440088405	BK6047	791440089174	PA4440 KIT
791440086036	BK6045	791440086821	BF7998	791440087620	BF1297-O	791440088412	BK6044	791440089181	PA4441
791440086043	BK6046	791440086838	PA5496	791440087637	BF9817	791440088436	BF9836-D	791440089198	BF9848
791440086050	BK6048	791440086845	PA5497	791440087644	BF9818	791440088443	PA4438	791440089204	P7488
791440086067	BT9560-MPG	791440086852	BF1289-SP	791440087651	BF9819	791440088450	RS5558	791440089211	P7489
791440086074	PF7983	791440086869	B7369	791440087668	BF9820	791440088467	BF1346-O	791440089228	BF9849
791440086081	PF7984	791440086883	PT9423	791440087675	PA4433	791440088474	BF1348-O	791440089235	BF9850
791440086104	BF7985	791440086890	PA5498	791440087682	BF9821	791440088481	B7460	791440089297	PA4442
791440086111	RS5461	791440086906	PA5499	791440087699	BK6167	791440088498	B7461	791440089303	PA4443
791440086128	RS5462	791440086913	CA5500	791440087705	BF9822-D	791440088504	BT9437	791440089310	PA4444
791440086135	B7360	791440086920	B7370	791440087712	PF9823	791440088511	BF9837-D	791440089327	BF9851
791440086159	BF7637	791440086937	P7371	791440087729	P7380	791440088528	B7462	791440089334	P7490
791440086166	PA5464	791440086968	PT9424	791440087736	PF9824	791440088535	B7463	791440089341	B7491
791440086173	BK6988	791440086975	PA5503	791440087743	PF9825	791440088542	B7465	791440089358	BF9852
791440086180	B7361	791440086982	PA5504	791440087750	PF9826	791440088559	PA5560	791440089365	BF9853
791440086197	BT9561	791440086999	BF9800	791440087767	P7381	791440088566	PA5561	791440089372	BF9854
791440086203	PF7986	791440087002	PF9801	791440087774	PA5518	791440088573	PA5562	791440089402	PA5451
791440086210	PF7982	791440087019	PT9425-MPG	791440087781	PA5519	791440088580	PF9838	791440089419	RS4445
791440086227	PA5465	791440087026	PA4429	791440087798	PA5522	791440088597	PA5563	791440089426	PA4446



WARNING: These products can expose you to chemicals, including Diisononyl Phthalate, Carbon black extracts, Nickel, 1,3 Butadiene, Ethylene Oxide, Epichlorohydrin, which are known to the State of California to cause cancer, and Bisphenol-A, Ethylene Glycol, Ethylene Oxide, 1,3 Butadiene, Epichlorohydrin, which are known to the State of California to cause birth defects or other reproductive harm. For more information go to www.P65Warnings.ca.gov.

UPC TO BALDWIN (INDIVIDUAL PARTS)

UPC NUMBER	BALDWIN NUMBER	UPC NUMBER	BALDWIN NUMBER	UPC NUMBER	BALDWIN NUMBER	UPC NUMBER	BALDWIN NUMBER	UPC NUMBER	BALDWIN NUMBER
791440089433	PA4447	791440090422	PA4465	791440091214	PT9451-MPG	791440092006	HSG3079	791440092778	PA5717
791440089440	PA4448	791440090439	RS5537	791440091221	PT9452	791440092013	HSG3080	791440092785	PA5718 KIT
791440089457	BK6049	791440090446	BF9867-O	791440091238	BT9454	791440092020	BF9887	791440092792	PA5719
791440089464	BK6050	791440090453	RS5535	791440091245	PA5649	791440092037	BF9888	791440092808	BT9471
791440089471	BK6052	791440090460	BF1355-O	791440091252	PA4467	791440092044	BK6071	791440092815	PA5720
791440089488	BF9857	791440090477	PA5633	791440091269	BK6060	791440092051	PF9889	791440092822	PA5721
791440089495	BK6053	791440090484	PA5634	791440091276	PA5650	791440092068	PF9890	791440092839	PA5722
791440089501	BK6054	791440090491	PA5635	791440091283	PA5651	791440092075	BF9891-D	791440092846	PA5723
791440089518	BF9858 KIT	791440090507	PF9868	791440091290	PA5652	791440092082	BF9892-D	791440092853	PA4475
791440089716	BT9439	791440090514	PA5636	791440091306	PA5653	791440092099	BF9893	791440092860	PA5724
791440089730	RS5543	791440090521	BF1395-O	791440091313	BF1358-O	791440092105	BF9894	791440092877	PA5724 FOAM
791440089747	RS5544	791440090538	B7496	791440091320	PA5654	791440092112	B7503	791440092884	PA5725
791440089754	PA4449	791440090545	PA1885XP	791440091337	PA5655	791440092129	PA5688	791440092891	BF9906
791440089761	PA5580	791440090552	PA2573XP	791440091344	BK6061	791440092136	RS5684	791440092907	PA5726
791440089778	PA5581	791440090569	PA2562XP	791440091351	BK6062	791440092143	RS5685	791440092914	PA5727
791440089785	PA5582	791440090576	PA1894XP	791440091368	BK6063	791440092150	PA5686	791440092921	PA5728
791440089792	PA5583	791440090583	PA2453XP	791440091375	PA2456XP	791440092167	PA5687	791440092938	PA5728 FOAM
791440089808	PA5584	791440090590	PA2384XP	791440091382	BF9877	791440092174	PA5688	791440092945	CFB8784
791440089815	RS4450	791440090606	PA2363XP	791440091399	PA5656	791440092181	PA5689	791440092952	PA5729
791440089822	PA5588	791440090613	PA1615XP	791440091405	PA5657	791440092198	PA5690	791440092969	RS5730
791440089839	PA5589	791440090620	PA1884XP	791440091412	PA5658	791440092204	PA5691	791440092976	RS5731
791440089853	CV15001	791440090637	PA1706XP	791440091429	PA5659	791440092211	RS5692	791440092983	PA5732
791440089860	P7492	791440090644	BF9869	791440091436	PA5660	791440092228	RS5693	791440092990	PF9907
791440089891	PA4451	791440090651	BK6058	791440091443	PA5661	791440092235	PA5694	791440093119	BK6072
791440089907	PA4452	791440090668	PT9441-MPG	791440091450	PA5662	791440092242	PA5695	791440093126	BK6073
791440089914	PA4453	791440090675	BK6059	791440091467	PA5663	791440092259	PA5696	791440093133	BK6074
791440089921	PA5585	791440090682	PF9870	791440091474	PA5664	791440092266	PA5697	791440093140	BK6075
791440089938	PA5586	791440090699	PA5637	791440091481	PA5665	791440092273	BD7504	791440093157	PA5733
791440089945	PA4454	791440090705	PA5638	791440091498	PA5666	791440092280	B7506	791440093164	PF9908 KIT
791440089952	P7493	791440090729	PA2518XP	791440091504	PA5667	791440092297	PA4470	791440093171	PF9909
791440089969	PA4455	791440090736	PA1886XP	791440091511	PA5668	791440092303	BF9895 KIT	791440093188	RS3539XP
791440089976	BK6055	791440090743	PA1634XP	791440091528	PA4468	791440092310	PA4471	791440093195	PA5734
791440089983	PA4456	791440090750	PA2616XP	791440091535	PA4469	791440092327	PA5698	791440093201	BF9910
791440090002	BA5592	791440090767	PA2326XP	791440091542	P5092	791440092334	PA5699	791440093218	PA5735
791440090019	PA4458	791440090774	PA1846XP	791440091559	BF9878	791440092341	PF9896 KIT	791440093225	PA5736
791440090026	RS5593	791440090781	PA2676XP	791440091566	PA5669	791440092358	PF9897	791440093232	PT510
791440090033	PA5594	791440090798	BF9871-O	791440091573	RS5670	791440092365	PA4472	791440093249	PF9911
791440090040	PA5596	791440090804	RS3744XP	791440091597	BK6064	791440092372	BF9898-O	791440093256	PT9472
791440090057	PA5597	791440090811	RS3510XP	791440091603	PA5474	791440092389	PF9899	791440093263	B7511
791440090064	PA5598	791440090835	RS3508XP	791440091610	RS5672	791440092396	PF9900	791440093270	PA5737 KIT
791440090071	PA5599	791440090842	RS3514XP	791440091627	RS5673	791440092402	B7507	791440093287	PT9473
791440090088	P7494	791440090859	RS3700XP	791440091634	PA5674	791440092419	BC7394	791440093294	PA5738
791440090095	BK6056	791440090866	RS3998XP	791440091641	RS5675	791440092426	PA5700	791440093300	PA5739
791440090101	PA4460 KIT	791440090873	RS2863XP	791440091658	RS5676	791440092433	PF9901 KIT	791440093317	PA5740
791440090118	BF9860	791440090880	RS3517XP	791440091689	B7499	791440092440	PA4473	791440093324	RS5741
791440090125	PA4461	791440090897	RS3548XP	791440091702	BT9456	791440092457	PT9468	791440093331	RS5742
791440090132	PA4462	791440090910	RS3530XP	791440091719	PA5678	791440092464	BK6076	791440093348	RS5743
791440090149	PF9861	791440090927	RS3506XP	791440091726	BK6065	791440092471	BK6077	791440093355	RS5743XP
791440090156	CV15002	791440090934	RS3734XP	791440091733	BK6066	791440092488	BK6078	791440093362	RS5744
791440090163	PA4463	791440090941	RS3504XP	791440091740	PA5679	791440092495	BK6079	791440093379	RS5745
791440090170	PF9862	791440090958	PF9872	791440091757	PF9879	791440092501	BK6080	791440093386	RS5747
791440090187	BF9863	791440090965	B7497	791440091764	BF9880	791440092518	PF9902	791440093393	RS5748
791440090194	PA5618	791440090996	PF9873	791440091771	PA5680	791440092525	BF9903-SP	791440093409	RS5749
791440090200	PA5619	791440091009	RS5641	791440091788	PT9459-MPG	791440092532	PA4474	791440093416	RS5750
791440090217	PA5620	791440091016	PA4466	791440091795	PA5681	791440092549	B7395	791440093423	BF1249-O
791440090224	PA5621	791440091023	BT9442-MPG	791440091801	PF9881	791440092556	PA5701	791440093430	PA5751
791440090231	PA5622	791440091030	BF9874-DM	791440091818	BF9882	791440092563	PA5702	791440093447	PT9474
791440090248	PA5623	791440091047	BF9875-DM	791440091825	PT9462	791440092570	BF9904	791440093454	PA5752
791440090255	PA5624	791440091054	PT9443	791440091832	PA5682	791440092587	P7508	791440093461	S9475
791440090262	BF9864	791440091061	PT9444-MPG	791440091849	BT9464	791440092594	PA5704	791440093478	BF9912-O
791440090279	PA5625	791440091078	BF9876	791440091856	PT9463	791440092600	PA5705	791440093485	PT9476-MPG
791440090286	PF9865	791440091085	PA5642	791440091863	BF9883	791440092617	RS5707	791440093492	BF1281-O
791440090293	PA5626	791440091092	PA5643	791440091870	PA5481	791440092624	RS5708	791440093508	BF9913
791440090309	PA4464	791440091108	PA5644	791440091887	B7501	791440092631	PT9469	791440093515	BF1283-O
791440090316	RS5627	791440091115	PA5645	791440091894	PE5270	791440092648	PT9470	791440093522	PA5753
791440090323	RS5628	791440091122	PA5646	791440091900	PE5271	791440092665	BD7509	791440093539	RS5754
791440090330	PA5629	791440091139	PA5647	791440091917	BT9465	791440092682	PA5710	791440093546	PA5755
791440090347	PA5630	791440091146	PA5648	791440091924	PA5683	791440092699	PA5711	791440093553	RS5756
791440090354	PA5631	791440091153	PT9445-MPG	791440091931	BF9884	791440092716	PA5712	791440093560	CV15003
791440090361	RS5534	791440091160	PT9446	791440091948	BF9885	791440092733	PA5713	791440093577	PF9914 KIT
791440090378	BT9440	791440091177	PT9447	791440091955	BK6067	791440092750	PA5714	791440093584	BF9915
791440090385	BF9866-O	791440091184	PT9448	791440091962	BT9466-MPG	791440092767	BF9905	791440093591	PA5757
791440090392	PA5632	791440091191	PT9449	791440091986	BF9886	791440092784	PA5715	791440093607	RS5758
791440090415	P7495	791440091207	PT9450-MPG	791440091993	P7502	791440092791	PA5716	791440093614	RS5759



WARNING: These products can expose you to chemicals, including Diisononyl Phthalate, Carbon black extracts, Nickel, 1,3 Butadiene, Ethylene Oxide, Epichlorohydrin, which are known to the State of California to cause cancer, and Bisphenol-A, Ethylene Glycol, Ethylene Oxide, 1,3 Butadiene, Epichlorohydrin, which are known to the State of California to cause birth defects or other reproductive harm. For more information go to www.P65Warnings.ca.gov.

UPC TO BALDWIN (INDIVIDUAL PARTS)

UPC NUMBER	BALDWIN NUMBER	UPC NUMBER	BALDWIN NUMBER	UPC NUMBER	BALDWIN NUMBER	UPC NUMBER	BALDWIN NUMBER	UPC NUMBER	BALDWIN NUMBER
791440093638	RS5761	791440094383	PT9532	791440095243	BF9926-O	791440095984	PT23070-MPG	791440096752	PA30002
791440093645	PA5762	791440094390	PA4481	791440095250	RS5291	791440095991	PT23071-MPG	791440096769	PA30003
791440093652	BF9916	791440094420	BT9533	791440095267	RS5292	791440096004	PT23072-MPG	791440096776	PA30004
791440093669	PA4476	791440094437	P7517	791440095274	BF9927	791440096011	PT23073-MPG	791440096783	PA30005
791440093676	PA4477	791440094444	P9600	791440095281	PT23001	791440096028	PT23074-MPG	791440096790	PA30006
791440093683	PA4478	791440094451	PA5770	791440095298	PT23000	791440096035	PT23075-MPG	791440096806	PA30007
791440093690	PA4479	791440094468	PA5771	791440095304	PT23002	791440096042	PT23076-MPG	791440096813	PA10003
791440093706	PA4480	791440094475	PA5772	791440095311	PT23003	791440096059	PT23077-MPG	791440096820	RS30008
791440093713	PA5763	791440094482	PA5773	791440095328	PT23004	791440096066	PT23078-MPG	791440096837	RS30009
791440093720	PA5764	791440094499	PF9919	791440095335	PT23005	791440096073	PT23079-MPG	791440096844	PF46003
791440093737	P7512	791440094505	PA5774	791440095342	PT23006	791440096080	PT23080-MPG	791440096851	PF46004
791440093744	B7513	791440094529	BF1282-O	791440095359	PT23007	791440096097	PT23081-MPG	791440096868	PA10004
791440093751	PA5765	791440094536	PA4483	791440095366	PT23008	791440096103	PT23082-MPG	791440096875	RS10005
791440093768	P7514	791440094550	RS5776	791440095373	PT23009	791440096110	PT23083-MPG	791440096882	PA30010
791440093775	BF9917	791440094567	B9601	791440095380	PT23010	791440096127	PT23084-MPG	791440096899	BF46005
791440093782	BK6081	791440094574	PA5777	791440095397	PT23011	791440096134	PT23085-MPG	791440096905	PA10006
791440093799	BF9918 KIT	791440094581	PA5778	791440095403	PT23012	791440096141	PT23086-MPG	791440096912	P40003
791440093805	PA5766	791440094598	PA5779	791440095410	PT23013	791440096158	PT23087-MPG	791440096929	PA10007
791440093812	RS5767	791440094604	BF9920	791440095427	PT23014	791440096165	PT23088-MPG	791440096943	CV15004
791440093829	P7515	791440094611	PT9535-MPG	791440095434	PT23015	791440096172	PT23089-MPG	791440096950	PA30011
791440093836	PA5768	791440094628	PA5780	791440095441	PT23016	791440096189	PT23090-MPG	791440096963	OAS98000
791440093843	PT9477	791440094635	PA5781	791440095458	PT23017	791440096196	PT23091-MPG	791440096967	PA30012
791440093850	PT9478-MPG	791440094642	RS5489	791440095465	PT23018	791440096202	PT23092-MPG	791440096974	PA30013
791440093867	PT9479-MPG	791440094659	RS5490	791440095472	PT23019	791440096219	PT23093-MPG	791440096981	PA30014
791440093874	PT9480-MPG	791440094666	PA4484	791440095489	PT23020	791440096226	PT23094-MPG	791440096998	PA30015
791440093881	PT9481-MPG	791440094673	RS5782	791440095496	PT23021	791440096233	PT23095-MPG	791440097001	PA30016
791440093898	PT9482-MPG	791440094680	RS5783	791440095502	PT23022	791440096240	PT23096-MPG	791440097018	PA30017
791440093904	PT9483-MPG	791440094697	BF9921-O	791440095519	PT23023	791440096257	PT23097-MPG	791440097025	PA30018
791440093911	PT9484-MPG	791440094703	PA4485	791440095526	PT23024	791440096264	PT23098-MPG	791440097032	PA30019
791440093928	PT9485-MPG	791440094710	PA5785	791440095533	PT23025	791440096271	PT23099-MPG	791440097049	PA30020
791440093935	PT9486-MPG	791440094727	PA5786	791440095540	PT23026	791440096288	PT23100-MPG	791440097056	PA30021
791440093942	PT9487-MPG	791440094734	PA5787	791440095557	PT23027	791440096295	PT23101-MPG	791440097063	PA30022
791440093959	PT9488-MPG	791440094741	RS5784	791440095564	PT23028-MPG	791440096301	PT23102-MPG	791440097070	PA30023
791440093966	PT9489-MPG	791440094758	BF9922-O	791440095571	PT23029-MPG	791440096318	PT23103-MPG	791440097087	PA30024
791440093973	PT9490-MPG	791440094765	PT9536-MPG	791440095588	PT23030-MPG	791440096325	PT23104-MPG	791440097094	PA30025
791440093980	PT9491-MPG	791440094772	CA5450	791440095595	PT23031-MPG	791440096332	PT23105-MPG	791440097101	PA30026
791440093997	PT9492-MPG	791440094789	CA5788	791440095601	PT23032-MPG	791440096349	PT23106-MPG	791440097117	PA30027
791440094000	PT9493-MPG	791440094796	CA4996	791440095618	PT23033-MPG	791440096356	PT23107-MPG	791440097124	PA30028
791440094017	PT9494-MPG	791440094802	PA4997	791440095625	PT23034-MPG	791440096363	PT23108-MPG	791440097131	PA30029
791440094024	PT9495-MPG	791440094819	CA5789	791440095632	PT23035-MPG	791440096370	PT23109-MPG	791440097148	PA30030
791440094031	PT9496-MPG	791440094826	CA5790	791440095649	PT23036-MPG	791440096387	PT23110-MPG	791440097155	PA30031
791440094048	PT9497-MPG	791440094833	CA5791	791440095656	PT23037-MPG	791440096394	PT23111-MPG	791440097162	PA30032
791440094055	PT9498-MPG	791440094840	PA5792	791440095663	PT23038-MPG	791440096400	PT23112-MPG	791440097179	PA30033
791440094062	PT9499-MPG	791440094857	CA5793	791440095670	PT23039-MPG	791440096417	PT23113-MPG	791440097186	PA30034
791440094079	PT9500-MPG	791440094888	BK6051	791440095687	PT23040-MPG	791440096424	PT23114-MPG	791440097193	PA30035
791440094086	PT9501-MPG	791440094895	PA5796	791440095694	PT23041-MPG	791440096431	PT23115-MPG	791440097209	PA30036
791440094093	PT9502-MPG	791440094901	PA5797	791440095700	PT23042-MPG	791440096448	PT23116-MPG	791440097216	PA30037
791440094109	PT9503-MPG	791440094918	PA5798	791440095717	PT23043-MPG	791440096455	PT23117-MPG	791440097223	PA30038
791440094116	PT9504-MPG	791440094925	PE5272	791440095724	PT23044-MPG	791440096462	PT23118-MPG	791440097230	PA30039
791440094123	PT9505-MPG	791440094932	PA5799	791440095731	PT23045-MPG	791440096479	PT23119-MPG	791440097247	PA30040
791440094130	PT9506	791440094949	RS5273	791440095748	PT23046-MPG	791440096486	PT23120-MPG	791440097254	PA30041
791440094147	PT9507	791440094956	BF9923-O	791440095755	PT23047-MPG	791440096509	B9604	791440097261	PA30042
791440094154	PT9508	791440094970	PA5274	791440095762	PT23048-MPG	791440096516	RS5293	791440097278	PA30043
791440094161	PT9509	791440094987	PA5275	791440095779	PT23049-MPG	791440096523	RS5294	791440097285	PA30044
791440094178	PT9510	791440094994	PA5276	791440095786	PT23050-MPG	791440096554	PA5297	791440097292	PA30045
791440094185	PT9511	791440095007	P9602	791440095793	PT23051-MPG	791440096561	PA5298	791440097308	PA30046
791440094192	PT9512	791440095014	P9603	791440095809	PT23052-MPG	791440096578	P9605	791440097339	PA30047
791440094208	PT9513	791440095021	PT9537-MPG	791440095816	PT23053-MPG	791440096585	RS5274	791440097346	PA30048
791440094215	PT9514	791440095045	CA5278	791440095823	PT23054-MPG	791440096592	PA5299	791440097353	PA30049
791440094222	PT9515	791440095076	PA5281	791440095830	PT23055-MPG	791440096608	RS5288XP	791440097360	PA30050
791440094239	PT9516	791440095083	PA5282	791440095847	PT23056-MPG	791440096615	B9606	791440097377	PA30051
791440094246	PT9517	791440095090	PA5283	791440095854	PT23057-MPG	791440096622	B9607	791440097384	PA30052
791440094260	PT9518-MPG	791440095106	BA5284	791440095861	PT23058-MPG	791440096639	PF9928	791440097391	PA30053
791440094277	PT9519-MPG	791440095113	PA4486	791440095878	PT23059-MPG	791440096646	PF9929	791440097407	PA30054
791440094284	PT9520-MPG	791440095120	BF1278-O	791440095885	PT23060-MPG	791440096653	PA30000	791440097414	PA30055
791440094291	PT9522-MPG	791440095137	PA4487	791440095892	PT23061-MPG	791440096660	PA30001	791440097421	RS30057
791440094307	PT9523-MPG	791440095144	PA4488	791440095908	PT23062-MPG	791440096677	PA10000	791440097438	RS30058
791440094314	PT9524-MPG	791440095151	PA4489	791440095915	PT23063-MPG	791440096684	PA10001	791440097445	RS30059-FN
791440094321	PT9525-MPG	791440095168	RS5285	791440095922	PT23064-MPG	791440096691	PA10002	791440097452	RS30060-FN
791440094338	PT9526-MPG	791440095175	PF9924 KIT	791440095939	PT23065-MPG	791440096707	BF46000	791440097469	RS30061
791440094345	PT9528	791440095199	BF9925-O	791440095946	PT23066-MPG	791440096714	BF46001	791440097476	RS30062
791440094352	PT9529	791440095212	RS5287XP	791440095953	PT23067-MPG	791440096721	B40000	791440097483	BW21000
791440094369	PT9530	791440095229	PA5290	791440095960	PT23068-MPG	791440096738	PA0001	791440097490	BF46006
791440094376	PT9531	791440095236	PA5289	791440095977	PT23069-MPG	791440096745	BF46002	791440097506	BF46007



WARNING: These products can expose you to chemicals, including Diisononyl Phthalate, Carbon black extracts, Nickel, 1,3 Butadiene, Ethylene Oxide, Epichlorohydrin, which are known to the State of California to cause cancer, and Bisphenol-A, Ethylene Glycol, Ethylene Oxide, 1,3 Butadiene, Epichlorohydrin, which are known to the State of California to cause birth defects or other reproductive harm. For more information go to www.P65Warnings.ca.gov.

UPC TO BALDWIN (INDIVIDUAL PARTS)

UPC NUMBER	BALDWIN NUMBER	UPC NUMBER	BALDWIN NUMBER	UPC NUMBER	BALDWIN NUMBER	UPC NUMBER	BALDWIN NUMBER	UPC NUMBER	BALDWIN NUMBER
791440097513	BF46008	791440098312	PA10009	791440099074	PT23147	791440099890	PT23229-MPG	791440100831	RS30090-FN
791440097520	PF46009	791440098329	P40014	791440099081	PT23148	791440099906	PT23230-MPG	791440100848	20025
791440097537	PF46010 KIT	791440098336	RS5591XP	791440099098	PT23149	791440099913	PT23231-MPG	791440100855	RS30091
791440097551	BF46012	791440098343	RS5593XP	791440099104	PT23150	791440099920	PT23232-MPG	791440100862	RS30092
791440097568	BF46013	791440098350	OAS98001	791440099111	PT23151	791440099937	PT23233-MPG	791440100868	PA30093
791440097575	BF46014	791440098367	OAS98002	791440099128	PT23152	791440099944	PT23234-MPG	791440100893	PA10016
791440097582	BF46015	791440098374	OAS98003	791440099142	PT23154	791440099951	PT23235-MPG	791440100909	PA10017
791440097599	BF5813-O	791440098381	OAS98004	791440099159	PT23155	791440099968	PT23236-MPG	791440100916	PA30094
791440097605	BF1204-O	791440098398	OAS98005	791440099166	PT23156	791440099975	PT23237-MPG	791440100923	BF46037
791440097612	BF791-O	791440098404	OAS98006	791440099173	PT23157	791440099982	PT23238-MPG	791440100930	PA30095
791440097629	BF7968-O	791440098411	OAS98007	791440099180	PT23158	791440099999	PT23239-MPG	791440100947	PT23306
791440097636	BF46016-O	791440098428	OAS98008	791440099197	PT23159	791440100008	PT23240-MPG	791440100954	PA30096
791440097643	BF46017-O	791440098435	OAS98009	791440099203	PT23160	791440100015	PT23241-MPG	791440100985	BF46038-D
791440097650	BF46018-O	791440098442	OAS98010	791440099210	PT23161	791440100022	PT23242-MPG	791440100992	BF46039-D
791440097667	BF46019-O	791440098459	OAS98011	791440099227	PT23162	791440100039	PT23243-MPG	791440101005	PA10018
791440097674	BF46020-O	791440098466	OAS98012	791440099234	PT23163	791440100046	PT23244-MPG	791440101012	PA30098
791440097681	BF46021-O	791440098473	OAS98013	791440099241	PT23164	791440100053	PT23245-MPG	791440101029	PT23308
791440097698	BF46022-O	791440098480	OAS98014	791440099258	PT23165	791440100060	PT23246-MPG	791440101036	PT23309
791440097704	BF46023-O	791440098497	OAS98015	791440099265	PT23166	791440100077	PT23247-MPG	791440101043	PT23310
791440097711	BF46024-O	791440098503	OAS98016	791440099272	PT23167	791440100084	PT23248-MPG	791440101050	PT23311
791440097728	BF46025-O	791440098510	OAS98017	791440099289	PT23168	791440100091	PT23249-MPG	791440101067	PT23312
791440097735	BF46026-O	791440098527	OAS98018	791440099296	PT23169	791440100107	PT23250-MPG	791440101074	PT23313
791440097742	BF46027-O	791440098534	OAS98019	791440099302	PT23170	791440100114	PT23251-MPG	791440101081	PT23314
791440097759	BF46028-O	791440098541	OAS98020	791440099319	PT23171	791440100121	PT23252-MPG	791440101098	PT23315
791440097766	BF46029-O	791440098558	OAS98021	791440099326	PT23172	791440100138	PT23253-MPG	791440101104	PT23316
791440097773	BF46030-O	791440098565	OAS98022	791440099333	PT23173	791440100145	PT23254-MPG	791440101111	PT23317
791440097780	PT23136	791440098572	OAS98023	791440099340	PT23174	791440100152	PT23255-MPG	791440101128	PT23318
791440097803	PT23122	791440098589	OAS98024	791440099357	PT23175	791440100169	PT23256-MPG	791440101135	PT23319
791440097810	PT23123	791440098596	OAS98025	791440099364	PT23176	791440100176	PT23257-MPG	791440101142	PT23320
791440097827	PT23137	791440098603	OAS98026	791440099371	PT23177	791440100183	PT23258-MPG	791440101159	PT23321
791440097834	PT23124	791440098619	OAS98027	791440099378	PT23178	791440100190	PT23259-MPG	791440101166	PT23322
791440097841	PT23125-MPG	791440098626	OAS98028	791440099385	PT23179	791440100206	PT23260-MPG	791440101173	PT23323
791440097858	PT23126-MPG	791440098633	OAS98029	791440099392	PT23180	791440100213	PT23261-MPG	791440101180	PT23324
791440097865	PT23127-MPG	791440098640	OAS98030	791440099401	PT23181	791440100220	PT23262-MPG	791440101197	PT23325
791440097872	PT23128-MPG	791440098647	OAS98031	791440099408	PT23182	791440100227	PT23263-MPG	791440101203	PT23326
791440097889	PT23129-MPG	791440098654	OAS98032	791440099415	PT23183	791440100234	PT23264-MPG	791440101210	PT23327
791440097902	PT23131-MPG	791440098661	OAS98033	791440099422	PT23184	791440100241	PT23265-MPG	791440101227	PT23328
791440097919	PT23132-MPG	791440098668	OAS98034	791440099429	PT23185	791440100251	PT23266-MPG	791440101234	PT23329
791440097926	PT23133-MPG	791440098675	OAS98035	791440099436	PT23186	791440100268	PT23267-MPG	791440101241	PT23330
791440097933	PT23134-MPG	791440098682	OAS98036	791440099443	PT23187	791440100275	PT23268-MPG	791440101258	PT23331
791440097940	PT23135-MPG	791440098689	OAS98037	791440099450	PT23188	791440100282	PT23269-MPG	791440101265	PT23332
791440097957	P40002	791440098696	OAS98038	791440099457	PT23189	791440100299	PT23270-MPG	791440101272	PT23333
791440097964	B40006	791440098703	OAS98039	791440099464	PT23190	791440100305	PT23271-MPG	791440101289	PT23334
791440097971	C40004	791440098710	OAS98040	791440099471	PT23191	791440100312	PT23272-MPG	791440101296	PT23335
791440097989	C40005	791440098717	OAS98041	791440099478	PT23192	791440100329	PT23273-MPG	791440101302	PT23336
791440097995	PA10008	791440098724	OAS98042	791440099485	PT23193	791440100336	PT23274-MPG	791440101319	PT23337
791440098008	PA30064	791440098731	OAS98043	791440099492	PT23194	791440100343	PT23275-MPG	791440101326	PT23338
791440098015	PT23138	791440098738	OAS98044	791440099499	PT23195	791440100350	PT23276-MPG	791440101333	PT23339
791440098022	BC40007	791440098745	OAS98045	791440099506	PT23196	791440100367	PT23277-MPG	791440101340	PT23340
791440098039	RS30065	791440098752	OAS98046	791440099513	PT23197	791440100374	PT23278-MPG	791440101357	PT23341-MPG
791440098046	RS30065 KIT	791440098759	OAS98047	791440099520	PT23198	791440100381	PT23279-MPG	791440101364	PT23342-MPG
791440098053	BF46031	791440098766	OAS98048	791440099527	PT23199	791440100398	PT23280-MPG	791440101371	PT23343-MPG
791440098060	BK6070	791440098773	OAS98049	791440099534	PT23200	791440100404	PT23281-MPG	791440101388	PT23344-MPG
791440098077	P40008	791440098780	OAS98050	791440099541	PT23201	791440100428	PT23282-MPG	791440101395	PT23345-MPG
791440098084	BC40009	791440098787	OAS98051	791440099548	PT23202	791440100435	PT23283-MPG	791440101401	PT23346-MPG
791440098091	PA0010	791440098794	OAS98052	791440099555	PT23203	791440100442	PT23284-MPG	791440101418	PT23347-MPG
791440098107	BF46032	791440098801	OAS98053	791440099562	PT23204	791440100459	PT23285-MPG	791440101422	PT23348-MPG
791440098114	PA30066	791440098808	OAS98054	791440099569	PT23205	791440100466	PT23286-MPG	791440101425	PT23349-MPG
791440098121	PA30067	791440098815	OAS98055	791440099576	PT23206	791440100473	PT23287-MPG	791440101432	PT23349-MPG
791440098138	PA30068	791440098822	OAS98056	791440099583	PT23207	791440100497	PT23288-MPG	791440101449	PT23350-MPG
791440098145	PA30069	791440098829	OAS98057	791440099590	PT23208	791440100503	PT23289-MPG	791440101456	PT23351-MPG
791440098152	PA30070	791440098836	OAS98058	791440099597	PT23209	791440100510	PT23290-MPG	791440101463	PT23352-MPG
791440098169	CA30071	791440098843	OAS98059	791440099604	PT23210	791440100527	PT23291-MPG	791440101470	PT23353-MPG
791440098176	PA30072	791440098850	OAS98060	791440099611	PT23211	791440100541	PT23292-MPG	791440101487	PT23354-MPG
791440098183	PA30073	791440098857	OAS98061	791440099618	PT23212	791440100558	PT23293-MPG	791440101500	PT23355-MPG
791440098190	PA30074	791440098864	OAS98062	791440099625	PT23213	791440100565	PT23294-MPG	791440101517	PT23357-MPG
791440098206	PF46033	791440098871	OAS98063	791440099632	PT23214	791440100589	PT23295-MPG	791440101524	PT23358-MPG
791440098237	P40011	791440098878	OAS98064	791440099639	PT23215	791440100596	PT23296-MPG	791440101531	PT23359-MPG
791440098244	P40012	791440098885	OAS98065	791440099646	PT23216	791440100602	PT23297-MPG	791440101548	PT23360-MPG
791440098251	B40013	791440098892	OAS98066	791440099653	PT23217	791440100619	PT23298-MPG	791440101555	PT23361-MPG
791440098268	PT23139-MPG	791440098900	OAS98067	791440099660	PT23218	791440100636	PT23299-MPG	791440101562	PT23362-MPG
791440098282	PA30075	791440098907	OAS98068	791440099667	PT23219	791440100653	PT23300-MPG	791440101579	PT23363-MPG
791440098299	BF45000	791440098914	OAS98069	791440099674	PT23220	791440100673	PT23301-MPG	791440101586	PT23364-MPG
791440098305	PA30076	791440098921	OAS98070	791440099681	PT23221	791440100703	PT23302-MPG		
		791440098928	OAS98071	791440099688	PT23222				
		791440098935	OAS98072	791440099695	PT23223				
		791440098942	OAS98073	791440099702	PT23224				
		791440098949	OAS98074	791440099709	PT23225				
		791440098956	OAS98075	791440099716	PT23226				
		791440098963	OAS98076	791440099723	PT23227				
		791440098970	OAS98077	791440099730	PT23228				
		791440098977	OAS98078	791440099737	PT23229				
		791440098984	OAS98079	791440099744	PT23230				
		791440098991	OAS98080	791440099751	PT23231				
		791440098998	OAS98081	791440099758	PT23232				
		791440099005	OAS98082	791440099765	PT23233				
		791440099012	OAS98083	791440099772	PT23234				
		791440099019	OAS98084	791440099779					

UPC TO BALDWIN (INDIVIDUAL PARTS)

UPC NUMBER	BALDWIN NUMBER	UPC NUMBER	BALDWIN NUMBER	UPC NUMBER	BALDWIN NUMBER	UPC NUMBER	BALDWIN NUMBER	UPC NUMBER	BALDWIN NUMBER
791440101593	PT23365-MPG	791440102323	PT23438-MPG	791440103108	PT23500-MPG	791440103948	PA30126	791440104907	PA30172
791440101609	PT23366-MPG	791440102330	PT23439-MPG	791440103115	PT23501-MPG	791440103955	PA30127	791440104914	PA30173
791440101616	PT23367-MPG	791440102347	PT23440-MPG	791440103122	PT23502-MPG	791440103962	PF46046	791440104976	RS30142
791440101623	PT23368-MPG	791440102354	PT23441-MPG	791440103139	PT23503-MPG	791440103979	RS30128	791440104983	RS30142 KIT
791440101630	PT23369-MPG	791440102361	PT23442-MPG	791440103146	PT23504-MPG	791440103986	RS30129	791440104990	RS30143
791440101647	PT23370-MPG	791440102378	PT23443-MPG	791440103153	PT23505-MPG	791440103993	PA10034	791440105003	RS30143 KIT
791440101654	PT23371-MPG	791440102385	PT23444-MPG	791440103160	PT23506-MPG	791440104020	PT23531-MPG	791440105027	BT40028
791440101661	PT23372-MPG	791440102392	PT23445-MPG	791440103177	PT23507-MPG	791440104037	BF46048	791440105034	PA0030
791440101678	PT23373-MPG	791440102408	PT23446-MPG	791440103184	PT23508-MPG	791440104044	PA00117	791440105041	PA30174
791440101685	PT23374-MPG	791440102415	PT23447-MPG	791440103191	PT23509-MPG	791440104105	RS30133	791440105058	RS30175
791440101692	PT23375-MPG	791440102439	PT23449-MPG	791440103207	PT23510-MPG	791440104112	RS30134	791440105072	PA0031-MPG
791440101708	PT23376-MPG	791440102446	PT23450-MPG	791440103214	PT23511-MPG	791440104129	PA30137	791440105089	PA30177
791440101715	PT23377-MPG	791440102460	BF46040-D	791440103221	PT23512-MPG	791440104136	BD30000	791440105096	BD50000
791440101722	PT23378-MPG	791440102484	PA10020	791440103238	PT23513-MPG	791440104143	PA30139	791440105126	PA30179
791440101739	PT23379-MPG	791440102491	PA0019	791440103245	PT23514-MPG	791440104150	PA30140	791440105140	RS30180
791440101746	PT23380-MPG	791440102507	RS30099	791440103252	PT23515-MPG	791440104167	PA30141	791440105157	RS30181
791440101753	PT23381-MPG	791440102514	PA30100	791440103269	PT23516-MPG	791440104174	PA30144	791440105164	RS30182
791440101760	PT23382-MPG	791440102521	PA30101	791440103276	PT23517-MPG	791440104181	RS30135	791440105171	PA30183
791440101777	PT23383-MPG	791440102545	RS30106	791440103283	PT23518-MPG	791440104198	RS30136	791440105232	BF46071
791440101784	PT23384-MPG	791440102552	PA30107	791440103290	PT23519-MPG	791440104204	BA16000	791440105249	BF46072
791440101791	PT23385-MPG	791440102569	PA30109	791440103306	PT23520-MPG	791440104211	PT23532-MPG	791440105256	PT23556-MPG
791440101794	PT23355-MPG	791440102576	PA30108	791440103313	PT23521-MPG	791440104228	RS30130	791440105263	PA30166
791440101807	PT23386-MPG	791440102583	PA30110	791440103320	PT23522-MPG	791440104235	RS10035	791440105270	PA30165
791440101814	PT23387-MPG	791440102590	RS30112	791440103337	PT23523-MPG	791440104242	PT23530	791440105287	BT40032
791440101821	PT23388-MPG	791440102606	RS10021	791440103344	PT23524-MPG	791440104259	PT23533	791440105317	PA31000
791440101838	PT23389-MPG	791440102613	PT23451	791440103351	BF46041-D	791440104266	RS4634XP	791440105324	PA31002
791440101845	PT23390-MPG	791440102620	PT23452	791440103368	BF46042-D	791440104273	PA30148	791440105331	PA31010
791440101852	PT23391-MPG	791440102637	PT23453	791440103375	BF46043-D	791440104280	BK6086	791440105348	PA31001
791440101869	PT23392-MPG	791440102644	PT23454	791440103382	PA30113	791440104297	BK6087	791440105355	PA31003
791440101876	PT23393-MPG	791440102651	PT23455	791440103399	PA30114	791440104303	BF46050	791440105362	PA31011
791440101883	PT23394-MPG	791440102668	PT23456	791440103405	PA30115	791440104310	PT23534	791440105386	PA0033
791440101890	PT23395-MPG	791440102675	PT23457	791440103412	PA10022	791440104327	PT23535	791440105393	PA31004
791440101906	PT23396-MPG	791440102682	PT23458	791440103429	BT23525-MPG	791440104334	PT23536	791440105409	PA31006
791440101913	PT23397-MPG	791440102699	PT23459	791440103436	RS30116	791440104341	BF46051	791440105416	PA31012
791440101920	PT23398-MPG	791440102705	PT23460	791440103443	BF46044-D	791440104358	PA30149	791440105423	PA31005
791440101937	PT23399-MPG	791440102712	PT23461	791440103450	PA0020	791440104365	PA30150	791440105430	PA31007
791440101944	PT23400-MPG	791440102729	PT23462	791440103467	PA30117	791440104372	PA10036	791440105447	BK6138
791440101951	PT23401-MPG	791440102736	PT23463	791440103474	PT23526	791440104389	PA30151	791440105461	BT40034
791440101968	PT23402-MPG	791440102743	PT23464	791440103481	PA2361XP	791440104396	BF46052	791440105478	PA30185
791440101975	PT23403-MPG	791440102750	PT23465	791440103498	CA30103	791440104419	RS30147	791440105492	RS30187XP
791440101982	PT23404-MPG	791440102767	PT23466	791440103504	CA30102	791440104426	PA30145	791440105539	PA30188
791440101999	PT23405-MPG	791440102774	PT23467	791440103511	CA30105	791440104433	PA30146	791440105546	CV15006
791440102002	PT23406-MPG	791440102781	PT23468	791440103528	CA30104	791440104440	PA30153	791440105560	PA30189
791440102019	PT23407-MPG	791440102798	PT23469	791440103535	PT23527	791440104457	PA30154	791440105577	PA30190
791440102026	PT23408-MPG	791440102804	PT23470	791440103542	PA30118	791440104464	PA30155	791440105584	RS30191
791440102033	PT23409-MPG	791440102811	PT23471	791440103559	PA30119	791440104471	PA30156	791440105591	RS30192
791440102040	PT23410-MPG	791440102828	PT23472	791440103566	B40022-MPG	791440104488	PA30157	791440105607	BF46065-SPS
791440102057	PT23411-MPG	791440102835	PT23473	791440103573	RS30120	791440104495	PF46112	791440105621	PT23560
791440102064	PT23412-MPG	791440102842	PT23474	791440103580	RS30121	791440104501	PA10037	791440105638	PA10038
791440102071	PT23413-MPG	791440102859	PT23475	791440103597	RS5293XP	791440104532	BT23537	791440105645	PA10039
791440102088	PT23415-MPG	791440102866	PT23476	791440103603	PA0021	791440104549	PF46049	791440105652	PA10040
791440102095	PT23414-MPG	791440102873	PT23477	791440103610	PA10023	791440104556	BD40027	791440105669	PA10041
791440102101	PT23416-MPG	791440102880	PT23478	791440103627	PA10024	791440104570	BT23539	791440105676	PA10042
791440102118	PT23417-MPG	791440102897	PT23479	791440103634	PA10025	791440104587	BT23540	791440105683	PA10043
791440102125	PT23418-MPG	791440102903	PT23480	791440103641	PA10026	791440104594	PA30158	791440105690	PA0035
791440102132	PT23419-MPG	791440102910	PT23481	791440103658	PA10027	791440104600	RS30159	791440105706	BA0036
791440102149	PT23420-MPG	791440102927	PT23482	791440103665	PA10028	791440104617	RS30160	791440105713	PF46077
791440102156	PT23421-MPG	791440102934	PT23483-MPG	791440103689	PA10030	791440104624	RS30161	791440105720	PA30152
791440102163	PT23422-MPG	791440102941	PT23484-MPG	791440103696	PA10031	791440104631	RS30162	791440105737	OAS98061
791440102170	PT23423-MPG	791440102958	PT23485-MPG	791440103702	PA10032	791440104655	BF1360-O	791440105744	PA10044
791440102187	PT23424-MPG	791440102965	PT23486-MPG	791440103719	PA0023	791440104662	BF1347-O	791440105751	PA10045
791440102194	PT23425-MPG	791440102972	PT23487-MPG	791440103726	PA0024	791440104679	PA30163	791440105768	PA10046
791440102200	PT23426-MPG	791440102989	PT23488-MPG	791440103733	PA0025	791440104686	BT23542-MPG	791440105782	BT40038
791440102217	PT23427-MPG	791440102996	PT23489-MPG	791440103740	OAS98060	791440104693	CV15005	791440105799	BF46078-D
791440102224	PT23428-MPG	791440103009	PT23490-MPG	791440103757	PT23528-MPG	791440104709	PF46068	791440106758	BF46083-O
791440102231	PT23429-MPG	791440103016	PT23491-MPG	791440103764	RS30087	791440104719	PF46057	791440106789	BK6140
791440102248	PT23430-MPG	791440103023	PT23492-MPG	791440103771	RS30088	791440104761	PA30164	791440106819	PA32001
791440102255	PT23431-MPG	791440103030	PT23493-MPG	791440103801	PA30122	791440104778	BF46062	791440106826	PA32004
791440102262	PT23432-MPG	791440103047	PT23494-MPG	791440103818	PA30123	791440104785	BT23543-MPG	791440106871	BF46084
791440102279	PT23433-MPG	791440103054	PT23495-MPG	791440103825	PA30124	791440104792	PT23544-MPG	791440106918	PE17001
791440102286	PT23434-MPG	791440103061	PT23496-MPG	791440103832	PA30125	791440104822	PA30170	791440106925	PT23565-MPG
791440102293	PT23435-MPG	791440103078	PT23497-MPG	791440103849	BF46045-D	791440104846	PA30171	791440106932	PT23566-MPG
791440102309	PT23436-MPG	791440103085	PT23498-MPG	791440103894	PA10033	791440104877	RS30168	791440106949	PT23567-MPG
791440102316	PT23437-MPG	791440103092	PT23499-MPG	791440103931	PA3478XP	791440104884	RS30169	791440106956	PT23568-MPG



WARNING: These products can expose you to chemicals, including Diisononyl Phthalate, Carbon black extracts, Nickel, 1,3 Butadiene, Ethylene Oxide, Epichlorohydrin, which are known to the State of California to cause cancer, and Bisphenol-A, Ethylene Glycol, Ethylene Oxide, 1,3 Butadiene, Epichlorohydrin, which are known to the State of California to cause birth defects or other reproductive harm. For more information go to www.P65Warnings.ca.gov.

UPC TO BALDWIN (INDIVIDUAL PARTS)

UPC NUMBER	BALDWIN NUMBER	UPC NUMBER	BALDWIN NUMBER	UPC NUMBER	BALDWIN NUMBER	UPC NUMBER	BALDWIN NUMBER	UPC NUMBER	BALDWIN NUMBER
791440106963	PT23569-MPG	791440107700	PF46103	791440108493	PF46092	791440109605	BF46122	857123005333	38567C
791440106970	PT23570-MPG	791440107717	PT23595-MPG	791440108509	BT23611	791440109780	BF46147-O	857123005340	38568C
791440106987	PT23571-MPG	791440107731	B40053	791440108547	PA10061	791440109858	BK6112	857123005357	38564S
791440106994	PT23572-MPG	791440107748	B40054	791440108561	RS30237	791440110533	BK6117	791440110533	38565S
791440107007	PT23573-MPG	791440107762	BT23603-MPG	791440108578	P40061	791440110649	BK6118	857123005371	38566S
791440107014	PT23574-MPG	791440107830	PT23600	791440108608	PA30204	791770098275	BT23140-MPG	857123005388	38567S
791440107021	PT23575-MPG	791440107847	B40056	791440108615	P40062			857123005395	38568S
791440107038	PT23576-MPG	791440107878	BT23607-MPG	791440108622	PA10062			857123005418	38559C
791440107045	PT23577-MPG	791440107885	PA10057	791440108646	BK6089			857123005425	38560C
791440107052	PT23578-MPG	791440107908	RS30209	791440108653	PA30244			857123005432	38561C
791440107069	PT23579-MPG	791440107922	PA30211	791440108660	PA30243			857123005449	38562C
791440107076	PT23580-MPG	791440107939	PA30235	791440108677	BK6092			857123005456	38563C
791440107083	PT23581-MPG	791440107984	RS30216	791440108721	BF46125			857123005463	38574C
791440107090	PT23582-MPG	791440107991	RS30217	791440108820	BF46127			857123005470	38575C
791440107106	PT23583-MPG	791440108004	RS30236	791440108844	BK6057			857123005487	38576C
791440107120	PT23585	791440108066	RS30223	791440108868	PA30251			857123005494	43562C
791440107137	PT23586	791440108073	RS30224	791440108905	RS3518XP			857123005500	43564C
791440107144	PT23587	791440108080	RS30225	791440108912	PA30252			857123005517	43566C
791440107151	PT23588	791440108097	RS30226	791440108936	PA10066			857123005524	43562S
791440107168	PT23589	791440108127	BK6090	791440108943	BK6093			857123005531	43564S
791440107175	PT23590	791440108196	PA30228	791440108950	PA10067			857123005548	43566S
791440107182	BF46085	791440108202	PA30229	791440108998	BF46129			857123005555	43568C
791440107199	PT23591-MPG	791440108226	P40058	791440109001	PA10068			857123005562	43570C
791440107212	PF46086	791440108257	BF46111	791440109049	PA10070			857123005579	43572C
791440107267	CA30131	791440108288	RS30232	791440109056	PA10071			857123005586	43574C
791440107274	CA30132	791440108301	PA30233-FN	791440109063	PA10072			857123005593	43573C
791440107281	BF46087	791440108318	BF46113-D	791440109070	PA10073			857123005609	43568S
791440107298	PA10047	791440108325	BT23609-MPG	791440109124	BK6094			857123005616	43570S
791440107304	PT23592	791440108332	RS30234	791440109155	PF46130			857123005623	43572S
791440107311	PF46088	791440108356	PA10058	791440109179	PT23616-MPG			857123005630	43574S
791440107366	BF46098-O	791440108370	PA30206	791440109315	BK6083			857123005647	43573S
791440107373	BF46100-O	791440108387	PA30207	791440109322	BK6088			857123005654	38557C
791440107380	BF46099-O	791440108394	PA30208	791440109445	BK6068			857123005661	38557S
791440107458	B40050	791440108448	RS30242	791440109490	BK6069				
791440107663	OAS99047	791440108455	PA10060	791440109506	BK6082				
791440107670	OAS99048	791440108462	BF46117	791440109513	BK6085				
791440107687	P40052	791440108486	PF46119	791440109537	BF1381-O				

Stanadyne Fuel Additives

857123005005	38564P
857123005012	38565P
857123005029	38566P
857123005036	38567P
857123005043	38568P
857123005050	38559P
857123005067	38560P
857123005074	38561P
857123005081	38562P
857123005098	38563P
857123005104	38574P
857123005111	38575P
857123005128	38576P
857123005135	43562P
857123005142	43564P
857123005159	43566P
857123005166	43568P
857123005173	43570P
857123005180	43572P
857123005197	43574P
857123005203	43573P
857123005210	38557P
857123005302	38564C
857123005319	38565C
857123005326	38566C

NOTES



WARNING: These products can expose you to chemicals, including Diisononyl Phthalate, Carbon black extracts, Nickel, 1,3 Butadiene, Ethylene Oxide, Epichlorohydrin, which are known to the State of California to cause cancer, and Bisphenol-A, Ethylene Glycol, Ethylene Oxide, 1,3 Butadiene, Epichlorohydrin, which are known to the State of California to cause birth defects or other reproductive harm. For more information go to www.P65Warnings.ca.gov.

BALDWIN CASE TO I 2/5 (SHIPPING CASES)

BALDWIN CASE NUMBER	CASE QTY.	I 2/5 NUMBER	BALDWIN CASE NUMBER	CASE QTY.	I 2/5 NUMBER	BALDWIN CASE NUMBER	CASE QTY.	I 2/5 NUMBER	BALDWIN CASE NUMBER	CASE QTY.	I 2/5 NUMBER	BALDWIN CASE NUMBER	CASE QTY.	I 2/5 NUMBER
B2	12	1079144000015	PT85	12	10791440001098	B161-S	12	10791440002057	P242	12	10791440003030	BT339	12	10791440003979
B2-HPG	12	1079144000022	PT86-HD	12	10791440001104	P162	12	10791440002064	B243	12	10791440003047	BT340	12	10791440003986
B4	12	1079144000046	PT87-S	12	10791440001111	B163	12	10791440002071	B244	12	10791440003054	BT341	12	10791440003993
BT5	12	1079144000053	PT88-HD	12	10791440001128	B164	12	10791440002088	B246	12	10791440003078	BT342	12	10791440004006
B6	12	1079144000060	PT89	12	10791440001135	B166	12	10791440002101	B247	12	10791440003085	BT343	6	10791440004013
B6-HPG	12	1079144000077	PT90-10	12	10791440001142	B167	12	10791440002118	BT248	12	10791440003092	BT344-S	12	10791440004020
B7	12	1079144000084	PT90-MPG	12	10791440001159	B168	12	10791440002125	P249	12	10791440003108	BT346	12	10791440004044
B9	12	1079144000091	PT91	12	10791440001166	P170	12	10791440002149	BT251	12	10791440003115	BT347	12	10791440004051
B10-AL	6	1079144000107	PT93	12	10791440001180	P171	12	10791440002156	B252	12	10791440003122	BT348	12	10791440004068
B10-AL BOWL	6	1079144000114	PT93-MPG	12	10791440001197	P172	12	10791440002163	B253	12	10791440003139	BT349	12	10791440004075
B10-AL BSP	6	10791440065489	B95	6	10791440001210	B173-S	12	10791440002170	B255	12	10791440003153	BT350	12	10791440004082
B10-AL BSPCS	6	10791440088655	B95-MPG	6	10791440001241	P174	12	10791440002187	PT256	12	10791440003160	BT351	12	10791440004099
B10-AL CAP	6	1079144000121	B95-SS	6	107914400050393	P176	12	10791440002200	PT257	12	10791440003177	BT351-MPG	6	10791440069708
PF10	12	1079144000138	B96	6	10791440001258	P177	12	10791440002217	PT258	12	10791440003184	P352	6	10791440004105
PF10-CS	12	1079144000145	B96-MPG	6	10791440001289	B178	12	10791440002224	BT259	12	10791440003191	BT353	12	10791440004112
PT11	12	1079144000152	B96-SS	6	107914400050386	B179	12	10791440002231	BT260	12	10791440003207	BT354	12	10791440004129
PT11-HD	12	1079144000169	B97	6	10791440001296	P183	12	10791440002279	BT260-10	12	10791440003214	BT355	12	10791440004136
PT12	12	1079144000176	PT98-10	6	10791440001302	P184	12	10791440002293	BT261	12	10791440003221	P356	12	10791440004143
BF13	12	1079144000183	PT98-MPG	6	10791440001319	PT185	12	10791440002309	B262	12	10791440003238	BT357	12	10791440004150
P15	12	1079144000190	B99	6	10791440001326	P186	12	10791440002316	B263	12	10791440003245	B358	12	10791440004167
S16-1	12	1079144000206	B99-B	6	10791440001333	P187	12	10791440002323	BT264	12	10791440003252	BT359	6	10791440004174
P18	12	1079144000237	B99-MPG	6	10791440001357	PT189	12	10791440002347	PT265	12	10791440003269	B360	12	10791440004181
P18-HD	12	1079144000244	B99-SS	6	107914400050416	PT189-MPG	12	10791440002354	P266	12	10791440003276	BT361	12	10791440004198
P19	12	1079144000251	P102	12	10791440001388	P190	12	10791440002361	BT267	12	10791440003283	BT364	12	10791440004211
P20	12	1079144000268	BD103	6	10791440001395	PT191-10	6	10791440002385	PT268	12	10791440003290	BT365	12	10791440004228
V24-A2	12	1079144000312	BD103-MPG	6	107914400042671	P194	6	10791440002446	PT269	12	10791440003306	BT365-10	12	10791440004235
P25	12	1079144000336	BD103-SS	6	107914400050409	P194-HD	6	10791440002453	P271	12	10791440003320	BT366-10	12	10791440004242
P26	12	1079144000343	P104	12	10791440001401	P194-HD10	6	10791440002460	PT273	12	10791440003344	BT366-MPG	12	10791440069692
B27	12	1079144000350	B105	6	10791440001418	PF194	6	10791440002477	BT274	12	10791440003351	BT367	12	10791440004259
BD28	12	1079144000367	P106	12	10791440001425	B195	12	10791440002484	PT275	12	10791440003368	BT367-S	12	10791440004266
PT29	12	1079144000374	P106-HD	12	10791440001432	B196	6	10791440002491	PT275-10	12	10791440003375	BT368	12	10791440004273
B30	12	1079144000398	PT108	12	10791440001456	B196-MPG	6	10791440002507	P276	12	10791440003382	B369	12	10791440004280
B31	12	1079144000404	PT108-HD	12	10791440001463	P198	12	10791440002514	PT277	12	10791440003402	PT370	4	10791440004297
B33	12	1079144000428	B109	12	10791440001470	B199	12	10791440002521	B279	12	10791440003412	BT371-5	12	10791440069715
B34	12	1079144000435	BC110	12	10791440001487	B201-S	12	10791440002545	P280	12	10791440003429	BT371-10	12	10791440004303
B35-S	12	1079144000442	BT111	12	10791440001494	B202	12	10791440002552	B281	12	10791440003436	BT371-MPG	12	10791440004310
AFG37R	6	10791440000466	BT112	12	10791440001500	P203	12	10791440002569	PT283	12	10791440003467	BT372-10	12	10791440004327
B37	12	1079144000473	B113	12	10791440001517	P203-HD	12	10791440002576	PT284	12	10791440003474	BT372-MPG	12	107914400043124
AFG38D	6	10791440000480	B114	12	10791440001524	P203-HD10	12	10791440002583	PT285	6	10791440003481	PT373	12	10791440004334
B39	12	1079144000503	PT115	12	10791440001531	P204	12	10791440002590	BT287	6	10791440003498	PT374	12	10791440004341
P40	12	1079144000510	PF116	6	10791440001555	P204-HD	12	10791440002606	BT287-3	6	10791440003528	PT375	12	10791440004358
P41	12	1079144000527	PT117	6	10791440001562	P204-HD10	12	10791440002613	BT287-10	6	10791440003504	PT376	12	10791440004365
P42	12	1079144000534	PT117-25	6	10791440001579	B205	6	10791440002620	PT288-HD	12	10791440003511	PT377	12	10791440004372
B43-S	12	1079144000541	B118	12	10791440001586	P206	12	10791440002637	PT288-HD10	12	10791440003528	PT377-10	12	10791440004389
B45	12	1079144000555	B120	12	10791440001647	PT207	12	10791440002644	PT289	12	10791440003535	B378	12	10791440004396
P47	12	1079144000589	PF121	12	10791440001654	PT207-10	12	10791440002651	PT289-10	12	10791440003542	B378-10	12	10791440004402
PT48	12	1079144000596	BT124	12	10791440001685	PT207-HD	12	10791440002668	PT290	12	10791440003559	PT379 KIT	6	10791440004419
B49	6	1079144000602	P125	12	10791440001692	PT207-HD10	12	10791440002675	BT292	12	10791440003573	PT381	12	10791440004433
B50	12	1079144000619	BT126	12	10791440001708	PT208	6	10791440002682	P294	12	10791440003597	PT382	12	10791440004440
P52	12	1079144000633	P127	12	107914400052915	PT210	12	10791440002699	B295	12	10791440003603	PT383	12	10791440004457
P53	12	1079144000640	B128	12	10791440001715	B211	12	10791440002705	B296	12	10791440003610	PT385	12	10791440004464
P54	12	1079144000657	B129	12	10791440001722	PT213	12	10791440002729	PT298-10	12	10791440003627	PT385-E	12	10791440004471
B56	12	1079144000671	B131	12	10791440001746	PT214(2)	12	10791440002736	B299	12	10791440003634	PT386	12	10791440004488
P60	12	1079144000718	B132	12	10791440001753	BT215	12	10791440002743	T300-M	12	10791440003641	BT387	6	10791440004495
PT61-HD	12	1079144000725	C133-OW	7	10791440001760	BT216	12	10791440002750	B301	12	10791440003658	BT387-10	6	10791440004501
PT62	12	1079144000732	C133-W	7	10791440001777	BT217	12	10791440002767	PT302	12	10791440003665	BT388	6	10791440004518
PT63-1	12	1079144000749	B134	12	10791440001784	B218	12	10791440002774	T303-M	12	10791440003672	BT388-10	6	10791440004525
PT66-HD	12	1079144000770	PT135	12	10791440001791	B220	6	10791440002798	PT304	12	10791440003689	BT389	6	10791440004532
P67	12	1079144000787	PT137	12	10791440001814	BT221	12	10791440002804	BT305	12	107914400038056	BT389-10	6	10791440004549
P68	12	1079144000794	PT138-10	12	10791440001821	B222	12	10791440002811	B307	12	10791440003702	PT390-MPG	12	10791440004556
PT70	12	1079144000817	PT138-25	12	10791440001838	BT223	12	10791440002828	T308-M	12	10791440003719	PT391-MPG	12	10791440004563
PT71	12	1079144000831	PT139-10	12	10791440001845	PF224	12	10791440002835	B309	12	10791440003726	PT392	12	10791440004570
PT72	12	1079144000855	P140	12	10791440001852	PF225	12	10791440002859	BT310	12	107914400038469	PT393	12	10791440004587
P73	12	1079144000879	B141	12	10791440001869	PF226	12	10791440002873	PF311	12	10791440003730	PT394-5	6	107914400045160
B74	12	1079144000886	BD142	12	10791440001876	B227	12	10791440002880	PF312	12	10791440003743	PT394-15	6	10791440004594
B75	12	1079144000893	B143	12	10791440001883	B228	12	10791440002897	PF313	12	10791440003757	BT395	12	10791440004600
B76	12	1079144000909	P144	12	10791440001890	B229	12	10791440002903	PF314	12	10791440003771	PT396	12	10791440004617
B76-MPG	12	1079144000930	PT146	12	10791440001906	BD230	12	10791440002910	PF316	6	10791440003764	PT397	4	1079144000

BALDWIN CASE TO I 2/5 (SHIPPING CASES)

BALDWIN CASE NUMBER	CASE QTY.	I 2/5 NUMBER	BALDWIN CASE NUMBER	CASE QTY.	I 2/5 NUMBER	BALDWIN CASE NUMBER	CASE QTY.	I 2/5 NUMBER	BALDWIN CASE NUMBER	CASE QTY.	I 2/5 NUMBER	BALDWIN CASE NUMBER	CASE QTY.	I 2/5 NUMBER
V414-FF	4	10791440004877	PT498	12	10791440005836	BT610-MPG	6	10791440045924	PT767	6	10791440008325	BF853	12	10791440009360
F415-B	4	10791440004884	PT498-10	12	10791440005843	BT611-MPG	6	10791440045955	PT768	6	10791440008332	BF855	12	10791440009384
P415-10	4	10791440004891	F501-MD	4	10791440005881	PA612	6	10791440007083	PT772	6	10791440008370	BF856	12	10791440009391
P415-10A	4	10791440004907	PF506	12	10791440005928	PA613	6	10791440007090	PT773-MPG	6	10791440008387	PF857	12	10791440009407
P415-25	4	10791440004914	P507	12	10791440005935	BF614	12	10791440007106	BT775	6	10791440008400	BF858	12	10791440009414
P415-25A	4	10791440004921	PT508-MPG	12	10791440005942	PA615	6	10791440007113	PT776-MPG	12	10791440008417	PF859	12	10791440009421
P415-5	4	10791440004938	PT510	12	10791440005966	PA618 FOAM	6	10791440007151	PT777	12	10791440008424	PF860	12	10791440009438
P415-5A	4	10791440004945	PT512	4	10791440005973	PA621	6	10791440007182	BT778	12	10791440008431	PF861	12	10791440009445
P415-5AN	4	10791440004952	PT513	12	10791440005980	PA625	6	10791440007199	BT779	12	10791440008448	BF862	12	10791440009452
P415-GM	4	10791440004969	PT514	12	10791440005997	PA631	6	10791440007205	BF781	12	10791440008455	BF863	12	10791440009469
V415-B	4	10791440004976	PT515	4	10791440006000	PA632	6	10791440007212	BF782	12	10791440008462	PF864	12	10791440009476
V415-FF	4	10791440004983	PT516	12	10791440006017	PA633(2)	12	10791440007229	BF783	12	10791440008479	BF865	12	10791440009483
PT416	12	10791440004990	PT517	12	10791440006024	BF784	6	10791440007236	BF784	6	10791440008486	BF865-K	12	10791440009490
PT418	4	10791440005010	PT520	6	10791440006055	PA638	4	10791440007243	BF785	6	10791440008493	PF866	12	10791440009506
BT420	12	10791440005034	BT521	12	10791440006079	PA640	6	10791440007267	BF786	12	10791440008509	BF866	12	10791440009520
B421	12	10791440005041	PT522	12	10791440006086	PA642	6	10791440007281	BF788	12	10791440008523	PF869	12	10791440009537
S423	12	10791440005058	BT525	12	10791440006093	PA643	12	10791440007298	BF789	12	10791440008530	PF872	12	10791440009551
BT424	6	10791440005065	BT526	12	10791440006109	PA644	12	10791440007304	BF790	12	10791440008547	BF873	12	10791440009568
BT425	6	10791440005072	BT526-10	12	10791440006116	PA648	6	10791440007335	BF791	12	10791440008554	BF874	12	10791440009575
PT426	12	10791440005089	P528	12	10791440006130	PA649	6	10791440007342	BF791-O	12	107914400097619	BF876	12	10791440009599
BT427	12	10791440005096	P529	6	10791440006147	PA650	6	10791440007359	BF792	12	10791440008561	BF877	12	10791440009612
V429-B	4	10791440005119	PT534	6	10791440006185	PA651	4	10791440007366	BF794	12	10791440008585	BF879	12	10791440009634
V429-FF	4	10791440005126	PT535	12	10791440006192	PA652	6	10791440007373	BF795	12	10791440008592	BF880-FP	12	10791440009798
PT430-FF	6	10791440005133	BT536	12	10791440006208	PA657	6	10791440007427	BF797	12	10791440008615	BF881	12	10791440009667
PT431	12	10791440005140	P537	6	10791440006215	PA658	6	10791440007434	BF798	12	10791440008622	PF882	12	10791440009674
PT433	12	10791440005157	PT538	12	10791440006222	PA662	6	10791440007472	BF799	6	10791440008639	PF883	12	10791440009681
PT434	12	10791440005164	P540	12	10791440006246	PA669	6	10791440007519	PF802	12	10791440008677	BF884	12	10791440009698
PT434-10	12	10791440005171	BT541	12	10791440006260	PT670	12	10791440007526	BF804	12	10791440008689	BF885	12	10791440009704
PT435	12	10791440005188	PT543 KIT	6	10791440006284	PT670-E	12	10791440007533	BF805	12	10791440008707	BF886	12	10791440009711
PT436	12	10791440005195	P545	12	10791440006307	PA675	6	10791440007564	BF806	12	10791440008714	BF888	12	10791440009728
PT437	12	10791440005201	PT546	12	10791440006314	PA677	6	10791440007588	BF807	12	10791440008721	BF890	12	10791440009742
BT438	12	10791440005218	PT548	6	10791440006321	PA678	6	10791440007595	PF809	12	10791440008745	BF891	12	10791440009759
PT439	12	10791440005225	PT549	12	10791440006338	PA680	6	10791440007601	PF810	12	10791440008752	BF892	12	10791440009766
BT440	12	10791440005232	PT550-10	6	10791440006345	PT685-MPG	12	10791440007618	BF811	12	10791440008769	PF893	12	10791440009773
PT441	12	10791440005249	PT554	12	10791440006376	PA691	6	10791440007625	BF812	12	10791440008776	PF893-RV	12	10791440009780
PT442-MPG	12	10791440005256	P555	12	10791440006383	PA693	6	10791440007632	PF814	12	10791440008790	PF894	12	10791440009797
BT443	6	10791440005263	BF556-10	12	10791440006390	PA696	6	10791440007663	BF816	12	10791440008813	PF894-RV	12	10791440009803
PT445-MPG	12	10791440005270	PT558	6	10791440006413	PA697	6	10791440007670	PF816-S	12	10791440008820	BF896	12	10791440009827
P446	12	10791440005287	PT561	12	10791440006437	PA699	6	10791440007687	PF818	12	10791440008844	SF898	12	10791440009841
B447	12	10791440005294	PT562-10	12	10791440006451	C704-L	4	10791440007724	BF819	12	10791440008851	PF899	12	10791440009858
P450	12	10791440005317	PT563	12	10791440006468	P706-M	4	10791440007748	PF819-HD	12	10791440008868	BF900	12	10791440009865
S451	12	10791440005324	BT564	12	10791440006475	PT707-HD	12	10791440007762	PF820-S	12	10791440008875	PF902	12	10791440009896
BT452	12	10791440005331	PT565	6	10791440006482	PT707-HD10	12	10791440007779	PF821-S	12	10791440008882	PF902-S	12	10791440009902
P454	12	10791440005355	PT566	12	10791440006499	PT707-HD3	12	10791440007786	BF822	12	10791440008899	PT903	12	10791440009919
S455	12	10791440005362	PT567	12	10791440006505	PT708-HD	12	10791440007793	PF823	12	10791440008905	PF906	12	10791440009957
S456	12	10791440005379	PT567-10	12	10791440006512	PT714	6	10791440007809	PF823-E	12	10791440008950	PF907	12	10791440009964
PT457-MPG	6	10791440005386	PT568	12	10791440006529	PF717	12	10791440007816	PF824	12	10791440008967	F908-A	6	10791440009971
PT459	12	10791440005393	BF577	12	10791440006604	P718-5	4	10791440007830	BF825	12	10791440008981	BF909	12	10791440009988
PT461	12	10791440005409	PT578	12	10791440006611	BF719	12	10791440007847	PF826	12	10791440008998	PF910	12	10791440009995
PT462	6	10791440005416	PT579	12	10791440006628	BF720	12	10791440007854	PF827	12	10791440009001	BF912	12	10791440010021
PT463	12	10791440005423	BF582	12	10791440006673	PT721	12	10791440007861	PF828	12	10791440009025	PF913	12	10791440010038
PT466	12	10791440005454	BF583	12	10791440006680	PT722	6	10791440007878	PF829(2)	6	10791440009032	BF914	6	10791440010045
PT467-MPG	6	10791440005461	BF584	12	10791440006697	PT723	12	10791440007885	BF830	12	10791440009049	BF915	12	10791440010052
PT468-MPG	12	10791440005478	BF584-B	12	10791440006703	PT725-MPG	6	10791440007892	PF831	12	10791440009056	F916-C	12	10791440010069
BT470	12	10791440005492	BF585	12	10791440006710	PT727-DL	24	10791440007918	BF833	12	10791440009070	PF916	12	10791440010076
PT471	12	10791440005508	BF586	12	10791440006727	PT727-HD	12	10791440007905	BF833-K2	12	10791440009087	BF918-K	12	10791440010106
BT472	12	10791440005515	BF586-D	12	10791440006734	PT727-HD10	12	10791440007922	F834-F	12	10791440009094	F919-C	60	10791440010144
B474	12	10791440005522	BF587	12	10791440006741	PT728-MPG	12	10791440007939	PF834	12	10791440009100	BF920	12	10791440010199
PT475	12	10791440005539	BF587-D	12	10791440006758	PT729	4	10791440007946	BF836	12	10791440009124	PF924	12	10791440010236
P476	12	10791440005546	BF588	12	10791440006765	BT732	6	10791440007977	BF836-K3	12	10791440009131	BF925	12	10791440010243
PT477	12	10791440005553	BF591	12	10791440006871	BT735	12	10791440007991	BF836-K4	12	10791440009148	PF926	12	10791440010250
S479	12	10791440005577	BF592	12	10791440006888	PT737	12	10791440008011	BF837	12	10791440009155	BF928	12	10791440010274
PT480	12	10791440005584	BF593	12	10791440006895	PT737-10	12	10791440008028	BF838-F2	12	10791440009162	BF929	12	10791440010281
PT480-10	12	10791440005591	F594-F	12	107914400052946	V738-O	12	10791440008035	PF838	12	10791440009179	BF930	12	10791440010298
PT480-MPG	12	10791440005607	PF594	12	10791440006901	BT739	12	10791440008042	BF839	12	10791440009186	BF932	12	10791440010328
B481	12	10791440005614	BT595	12	10791440006918	C740-S	12	10791440008059	BT839-10	12	10791440009193	BF933	12	10791440010335
S485	12	10791440005652	BF596	6	10791440006925	C750-E	4	10791440008141	BF840					

BALDWIN CASE TO I 2/5 (SHIPPING CASES)

BALDWIN CASE NUMBER	QTY.	I 2/5 NUMBER	BALDWIN CASE NUMBER	QTY.	I 2/5 NUMBER	BALDWIN CASE NUMBER	QTY.	I 2/5 NUMBER	BALDWIN CASE NUMBER	QTY.	I 2/5 NUMBER	BALDWIN CASE NUMBER	QTY.	I 2/5 NUMBER
BF948-JD	12	10791440010519	BF1182	12	10791440049113	BF1282-O	12	10791440094526	BF1390-O	12	10791440082202	PA1798	6	10791440013831
F950-F	12	10791440010533	BF1184	12	10791440049120	BF1283	12	10791440063287	BF1391-O	12	10791440082257	PA1800	6	10791440013848
F950-F WO	12	10791440053004	BF1185	12	10791440049137	BF1283-O	12	10791440093512	PF1392	12	10791440086569	PA1802	6	10791440013862
PF950	12	10791440010540	BF1186	12	10791440049144	BF1283-SP	12	10791440078489	BF1392-SPS KIT	6	10791440082745	PA1805	6	10791440013886
PT951	12	10791440010557	BF1188	12	10791440049212	BF1285-SP	12	10791440064802	BF1393-SP	12	10791440082929	PA1809	4	10791440013916
PF952	12	10791440010564	BF1190	12	10791440049410	BF1286	12	10791440066059	BF1394-SP	12	10791440083049	PA1814	6	10791440013947
F953-F	12	10791440053011	BF1191	12	10791440049427	BF1287-O	12	10791440086392	BF1395-O	12	10791440090528	PA1828	6	10791440014074
BF954	12	10791440010571	BF1193	12	10791440049441	BF1288-O	12	10791440086408	BF1395-SP	12	10791440083087	PA1832	6	10791440014104
BF955	12	10791440010588	BF1194	12	10791440049458	BF1289-SP	12	10791440086859	BF1396	12	10791440083223	PA1834	6	10791440014111
BF956	12	10791440010595	BF1195	12	10791440049465	BF1290-O	12	10791440087436	BF1397-SP	12	10791440087400	PA1841	6	10791440014166
BF957	12	10791440010601	BF1199	12	10791440049526	PF1291	12	10791440062518	BF1398-O	12	10791440083285	PA1852	6	10791440014265
BF957-D	12	10791440010625	BF1201	12	10791440011448	BF1292-O	12	10791440087443	BF1399-SP	12	10791440084091	PA1857	6	10791440014296
BF958	12	10791440010632	BF1204	12	10791440045825	BF1293-SPS	12	10791440078405	BF1400	12	10791440012032	PA1858	6	10791440014302
BF959	12	10791440010649	BF1204-O	12	10791440097602	BF1294-O	12	10791440087450	B1402	12	10791440012056	PA1859	6	10791440014319
P960	12	10791440010656	BF1204-SP	12	10791440045917	BF1295-O	12	10791440087597	BD1403	6	10791440054899	PA1860	6	10791440014326
BF962	12	10791440010670	BF1205	12	10791440045818	BF1296-O	12	10791440087610	BF1405	12	10791440043486	PA1861	6	10791440014333
PF963	12	10791440010687	BF1205-SP	12	10791440045832	BF1297-O	12	10791440087627	B1406	12	10791440012087	PA1873	4	10791440014418
BF964	12	10791440010694	BF1210	12	10791440011479	BF1298-O	12	10791440088679	B1407	12	10791440012094	V1874-T	4	10791440014425
BF966	12	10791440010717	BF1211	12	10791440011486	BF1299-O	12	10791440089119	BF1410	12	10791440043555	PA1875	12	10791440014432
PF967	12	10791440010724	BF1212	12	10791440011493	BF1329	12	10791440045702	B1413	12	10791440045542	PA1888	6	10791440014562
BF968	12	10791440010731	BF1212 FOAM	12	10791440011509	BF1329-O	12	10791440085890	BF1416	12	10791440054638	PA1889	6	10791440014579
BF970	12	10791440010748	BF1213	12	10791440011523	BF1329-SP	12	10791440045641	P1418	12	10791440050133	PA1891	6	10791440014586
BF971	12	10791440010755	BF1214	12	10791440011530	BF1330-SP	12	10791440058030	P1419	12	10791440050140	PA1909	12	10791440014777
BF974-D	12	10791440010779	BF1215	12	10791440049380	BF1339-SP	12	10791440065434	B1421	12	10791440050584	PA1915	12	10791440014814
B975	12	10791440010786	BF1216	6	10791440011547	BF1345	12	10791440037899	BF1422	12	10791440050843	PA1934	4	10791440014937
BF976	12	10791440010793	BF1217	12	10791440051086	BF1345-O	12	10791440087269	B1425	12	10791440051789	PA1946	6	10791440015019
BF978	12	10791440010816	BF1218	12	10791440011554	BF1345-SP	12	10791440045801	B1428	12	10791440012124	PA1949	6	10791440015026
BF979	12	10791440010823	BF1219	12	10791440011561	BF1346	12	10791440038353	BF1429	12	10791440038216	PA1951	6	10791440015040
BF980	12	10791440010830	BF1220	12	10791440011578	BF1346-O	12	10791440088464	B1430	12	10791440043074	PA1963	6	10791440015125
PF981	12	10791440010847	BF1221	12	10791440011585	BF1346-SP	12	10791440066011	B1431	12	10791440055862	PA1969	6	10791440015149
BF984	12	10791440010861	BF1222	12	10791440045672	BF1347	12	10791440045788	BF1432	12	10791440055916	PA1973	6	10791440015170
PF986	12	10791440010878	BF1222-O	12	10791440087214	BF1347-O	6	107914400104669	P1433	12	10791440056586	PA1985	12	10791440015293
BF987	12	10791440010885	BF1222-SP	12	10791440045665	BF1348	12	10791440045900	B1434	12	10791440058474	PA2001	6	10791440015242
BF988	12	10791440010892	BF1223	12	10791440011592	BF1348-O	12	10791440088471	B1435	12	10791440058917	PA2001 FOAM	12	10791440042640
BF989	12	10791440010908	BF1223-O	12	10791440087351	BF1348-SP	12	10791440051895	B1438	12	10791440058740	PA2002	6	10791440015439
BF991	12	10791440010922	BF1223-SP	12	10791440046112	BF1349	12	10791440050621	P1440	12	10791440058993	PA2005	6	10791440015453
BF992	12	10791440010939	BF1224	12	10791440045030	BF1350-SP	12	10791440050629	BF1441	12	10791440060851	PA2006	6	10791440015460
BF995	12	10791440010953	BF1225	12	10791440011608	BF1351-SP	12	10791440066035	P1443	12	10791440060675	PA2007	6	10791440015477
P996	12	10791440010960	BF1226	12	10791440011615	BF1352-SPS	12	10791440078168	B1444	12	10791440061658	PA2008	6	10791440015484
PF997	12	10791440053028	BF1231	12	10791440043340	BF1353-SPS	12	10791440067469	B1446	12	10791440062556	PA2009	6	10791440015491
P998	12	10791440010977	BF1232	12	10791440011639	BF1354-SPS	12	10791440080642	BF1447	12	10791440064925	PA2010	6	10791440015507
P999-HD	12	10791440010991	BF1233	12	10791440011646	BF1355	6	10791440078601	P1510	4	10791440012179	PA2023	6	10791440015538
BF1008	12	10791440049878	BF1239	6	10791440042527	BF1355-O	12	10791440090467	P1511	4	10791440012186	SA2024	6	10791440015545
V1009-W	12	10791440011035	BF1240	12	10791440050324	BF1355-SP	6	10791440076416	V1520-R	4	10791440012193	SA2027	12	10791440015569
BF1010	12	10791440049885	V1240-C	8	10791440011677	BF1356	12	10791440076751	V1542-C	6	10791440012216	PA2031	6	10791440015576
V1044-O	12	10791440011066	BF1248	12	10791440050485	BF1357	6	10791440076850	V1544-T	16	10791440012223	PA2036	6	10791440015606
BF1045	12	10791440049571	BF1249	12	10791440050980	BF1358-O	12	10791440091310	V1560	4	10791440062587	PA2037	6	10791440015613
BF1046	12	10791440049588	BF1249-O	12	10791440093420	BF1358-SP	12	10791440076874	PA1600	12	10791440012230	SA2039	12	10791440015637
BF1047	12	10791440049595	BF1249-SP	12	10791440052663	BF1359-SP	12	10791440077772	PA1603	12	10791440012254	PA2041	6	10791440015644
BF1048	12	10791440049601	BF1252	12	10791440051048	BF1360	12	10791440077970	PA1627	6	10791440012250	PA2042	4	10791440015651
BF1049	12	10791440049618	BF1253	12	10791440051512	BF1360-O	6	107914400104652	PA1633	6	10791440012605	PA2044	6	10791440015668
BF1050	12	10791440049625	BF1256	12	10791440054537	BF1360-SP	12	10791440083322	PA1639	6	10791440012681	SA2047	12	10791440051505
BF1052	12	10791440050546	BF1257	12	10791440053363	BF1361	12	10791440078182	F1645-DS	12	10791440012742	PA2050	6	10791440015699
BF1056	12	10791440050829	BF1258	12	10791440047171	BF1362	12	10791440078496	V1645-C	7	10791440012759	PA2051	6	10791440015705
BF1057	12	10791440051178	BF1259	12	10791440011691	BF1363	12	10791440078618	PA1648	6	10791440012803	PA2052	6	10791440015712
BF1059	12	10791440051192	BF1261	12	10791440054872	BF1365	12	10791440078755	V1656-O	6	10791440012865	PA2053	6	10791440015729
BF1061	12	10791440051208	BF1262	6	10791440056814	BF1366-O	12	10791440085852	V1656-T	6	10791440012872	PA2061	6	10791440015774
BF1100	12	10791440047720	BF1265	12	10791440058283	BF1367	12	10791440078991	PA1657	6	10791440012889	PA2063	6	10791440015798
BF1102	12	10791440011073	BF1266	12	10791440058726	BF1370	12	10791440079011	PA1661(3)	6	10791440012896	PA2064	6	10791440015804
BF1104	12	10791440011097	BF1267	12	10791440058788	BF1371	12	10791440079035	PA1666	12	10791440012926	PA2065	6	10791440015811
BF1105	12	10791440011103	BF1268	12	10791440059020	BF1373-SP	12	10791440079196	PA1679	12	10791440013039	PA2067	6	10791440015835
BF1110	12	10791440011141	BF1269	12	10791440059297	BF1372	12	10791440079349	PA1680	6	10791440013046	PA2067 FOAM	12	10791440073439
BF1112	12	10791440057804	BF1270-SP	12	10791440059372	BF1374-SP	12	10791440079264	PA1688	12	10791440013121	PA2068	6	10791440015842
BF1123	12	10791440011189	BF1271	12	10791440059853	BF1375	12	10791440079271	PA1696	6	10791440013176	PA2068 FOAM	12	10791440067643
BF1140	12	10791440011257	BF1272-SPS	12	10791440078052	BF1376	12	10791440079301	PA1697	6	10791440013183	PA2069	6	10791440015859
BF1148	12	10791440011288	BF1273-SP	12	10791440056746									

BALDWIN CASE TO I 2/5 (SHIPPING CASES)

BALDWIN CASE NUMBER	CASE QTY.	I 2/5 NUMBER	BALDWIN CASE NUMBER	CASE QTY.	I 2/5 NUMBER	BALDWIN CASE NUMBER	CASE QTY.	I 2/5 NUMBER	BALDWIN CASE NUMBER	CASE QTY.	I 2/5 NUMBER	BALDWIN CASE NUMBER	CASE QTY.	I 2/5 NUMBER
PA20916	10791440016054	PA22336	10791440045696	PA40756	10791440047065	PA41886	10791440080277	PA43836	10791440082530
PA20926	10791440016061	PA22346	10791440046075	PA40766	10791440047072	PA41906	10791440080307	PA43846	10791440082547
PA20946	10791440016085	PA22356	10791440048888	PA40776	10791440047539	PA41916	10791440080316	PA43856	10791440082554
PA20954	10791440016092	PA22376	10791440049090	PA40786	10791440047676	PA41926	10791440080406	PA43866	10791440082561
PA20966	10791440016108	PA22406	10791440049731	PA40796	10791440047874	PA41936	10791440080413	PA43876	10791440082578
PA20996	10791440016115	PA22416	10791440049748	PA40816	10791440049533	PA41946	10791440080420	PA43886	10791440082585
PA21006	10791440016122	PA22436	10791440049762	PA40826	10791440049540	PA4195 KIT6	10791440080437	PA43906	10791440082592
PA2101A6	10791440016139	PA22446	10791440049779	PA40846	10791440050041	PA41966	10791440080444	PA43916	10791440082609
PA21026	10791440016146	PA22566	10791440017341	PA40856	10791440050300	PA41976	10791440080451	PA43926	10791440082616
PA21036	10791440016153	PA22576	10791440017358	PA40886	10791440051147	PA41986	10791440080468	PA43936	10791440082623
PA21046	10791440016160	PA22586	10791440038599	PA40896	10791440051154	PA41996	10791440080475	PA43946	10791440082630
PA21066	10791440016184	PA23064	10791440017426	PA40916	10791440051215	PA43036	10791440080482	PA43956	10791440082637
PA21076	10791440016191	PA23084	10791440017440	PA40926	10791440051406	PA43046	10791440080499	PA43976	10791440082644
PA21096	10791440016214	PA23356	10791440017754	PA40936	10791440051734	PA43056	10791440080505	PA43986	10791440082651
PA21106	10791440016221	PA23376	10791440017761	PA40946	10791440051741	PA43066	10791440080512	PA43996	10791440082658
PA21136	10791440016252	PA23476	10791440017877	PA40966	10791440052104	PA43076	10791440080529	PA44006	10791440082665
PA21146	10791440016269	PA24726	10791440019260	PA40996	10791440052304	PA43086	10791440080536	PA44016	10791440082672
PA21156	10791440016276	PA24766	10791440019307	PA41006	10791440052444	PA43096	10791440080543	PA44026	10791440082679
PA21164	10791440016283	PA24776	10791440019314	PA41026	10791440053134	PA43106	10791440080550	PA44036	10791440082686
PA21176	10791440016290	PA24836	10791440019376	PA41036	10791440054513	PA43116	10791440080557	PA44046	10791440082693
PA21216	10791440016320	PA2554 FOAM	..6	10791440038612	PA41046	10791440054636	PA43126	10791440080564	PA44056	10791440082700
PA21246	10791440016351	PA2653 FOAM	..6	10791440021317	PA41056	10791440055463	PA43136	10791440080571	PA44096	10791440082707
PA21256	10791440016368	PA279812	10791440022789	PA41066	10791440054650	PA43146	10791440080604	PA4410 KIT6	10791440082714
PA21276	10791440016382	PA2862 FOAM	..12	10791440053592	PA41076	10791440054667	SA431512	10791440080650	PA44116	10791440082721
PA21346	10791440016450	PA288412	10791440053691	PA41086	10791440055957	PA43166	10791440080657	PA44126	10791440082728
PA21356	10791440016467	HSG30794	10791440092003	PA41096	10791440054964	PA43176	10791440080664	PA44136	10791440082735
PA21366	10791440016474	HSG30804	10791440092010	PA41106	10791440055138	PA43196	10791440080752	PA44146	10791440082742
PA21386	10791440016498	PA34146	10791440054162	PA41116	10791440055987	PA43206	10791440080759	PA4416 KIT6	10791440082749
PA21396	10791440016504	PA34196	10791440052212	PA41126	10791440057422	PA43216	10791440080888	PA44176	10791440082756
PA2139 FOAM	..12	10791440038582	PA36976	10791440047867	PA41136	10791440057897	PA43226	10791440080895	PA44186	10791440082763
PA21406	10791440016511	PA37636	10791440048734	PA41146	10791440058108	PA43236	10791440081045	PA44196	10791440082770
PA21476	10791440016573	PA37736	10791440049564	PA41186	10791440059167	PA43246	10791440081069	PA44216	10791440082777
PA21486	10791440016580	PA38226	10791440054391	PA41206	10791440059082	PA43256	10791440081106	PA44226	10791440082784
PA21496	10791440016597	PA38236	10791440054407	PA41216	10791440059327	PA43276	10791440081183	PA44236	10791440082791
PA21506	10791440016603	PA38256	10791440058078	PA41236	10791440059556	PA43296	10791440081212	PA44256	10791440082798
PA21526	10791440016627	PA38346	10791440054582	PA41246	10791440059663	PA43306	10791440081373	PA44266	10791440082805
PA21536	10791440016634	PA38356	10791440054599	PA41266	10791440059846	PA43316	10791440081380	PA44276	10791440082812
PA21546	10791440016641	PA38366	10791440055046	PA41276	10791440059921	PA43326	10791440081397	PA44286	10791440082819
PA21566	10791440016665	PA38396	10791440055077	PA41286	10791440060316	PA43336	10791440081571	PA44296	10791440082826
PA21576	10791440016672	PA38406	10791440055084	PA41296	10791440060323	PA43346	10791440081578	PA44306	10791440082833
PA21586	10791440016689	PA387212	10791440055923	PA41326	10791440060446	PA43356	10791440081519	PA44316	10791440082840
SA215912	10791440016696	PA387312	10791440055930	PA41336	10791440060484	PA43366	10791440081588	PA44336	10791440082847
PA21606	10791440016702	PA38806	10791440056036	PA41346	10791440060866	PA43376	10791440081610	PA44366	10791440082854
PA21626	10791440016726	PA38906	10791440056289	PA41386	10791440061122	PA43386	10791440081793	PA44376	10791440082861
PA21636	10791440016733	PA39016	10791440057439	SA414112	10791440061191	PA43406	10791440081809	PA44346	10791440082868
PA21646	10791440016740	PA3901 FOAM	..12	10791440067667	PA41446	10791440061962	PA43416	10791440081816	PA44356	10791440082875
PA21676	10791440016771	PA39296	10791440058542	PA41466	10791440062525	PA43446	10791440081823	PA44386	10791440082882
PA21686	10791440016788	PA39316	10791440058733	PA41476	10791440062532	PA43456	10791440081830	PA44396	10791440082889
PA21696	10791440016795	PA39416	10791440059396	PA4148 KIT6	10791440062549	PA43466	10791440081847	PA4440 KIT6	10791440082896
PA21716	10791440016818	PA39536	10791440059495	PA4149 KIT6	10791440063089	PA43496	10791440081854	PA44416	10791440082903
PA21786	10791440016887	PA39576	10791440059860	PA41506	10791440063461	PA43506	10791440081861	PA44426	10791440082910
PA21816	10791440016917	PA3957 FOAM	..12	10791440073415	PA41516	10791440064341	PA43516	10791440081868	PA44436	10791440082917
PA21896	10791440016979	PA39586	10791440059945	PA41526	10791440064499	PA43526	10791440081885	PA44446	10791440082924
PA21916	10791440016993	PA39676	10791440060118	PA41546	10791440064512	PA43536	10791440081991	PA44466	10791440082931
PA21926	10791440017006	PA39706	10791440060170	PA41576	10791440065052	PA43556	10791440082011	PA44476	10791440082938
PA21936	10791440017013	PA39806	10791440060354	PA41586	10791440065250	PA43566	10791440082028	PA44486	10791440082945
PA21946	10791440017020	PA3983-FN6	10791440060620	PA41596	10791440065403	PA43576	10791440082035	PA44496	10791440082952
PA21966	10791440017044	PA39866	10791440060927	PA41606	10791440065444	PA43586	10791440082042	PA44526	10791440082959
PA22006	10791440043456	PA40056	10791440043432	PA41626	10791440065533	PA43596	10791440082059	PA44536	10791440082966
PA22016	10791440017082	PA40156	10791440038698	PA41636	10791440065885	PA43606	10791440082066	PA44546	10791440082973
PA22046	10791440017112	PA40166	10791440026558	PA41646	10791440066080	PA43616	10791440082073	PA44556	10791440082980
PA22076	10791440017143	PA40186	10791440026565	PA41666	10791440066653	PA43626	10791440082080	PA44566	10791440082987
PA22086	10791440017150	PA40236	10791440026589	PA41676	10791440066769	PA43636	10791440082219	PA4460 KIT12	10791440090108
PA22126	10791440017198	PA40286	10791440026602	PA41696	10791440067131	PA43646	10791440082226	PA44616	10791440090115
PA22146	10791440017211	PA40316	10791440026619	PA41706	10791440072609	PA43656	10791440082233	PA4462</		

BALDWIN CASE TO I 2/5 (SHIPPING CASES)

BALDWIN CASE NUMBER	CASE QTY.	I 2/5 NUMBER	BALDWIN CASE NUMBER	CASE QTY.	I 2/5 NUMBER	BALDWIN CASE NUMBER	CASE QTY.	I 2/5 NUMBER	BALDWIN CASE NUMBER	CASE QTY.	I 2/5 NUMBER	BALDWIN CASE NUMBER	CASE QTY.	I 2/5 NUMBER
PA4479	6	10791440093697	PA4872	12	10791440073361	PE5271	12	10791440091907	PA5738	6	10791440093291	B7117	12	10791440048826
PA4480	6	10791440093703	PA4873	12	10791440073378	PE5272	12	10791440094922	PA5753	6	10791440093529	B7119	12	10791440050294
PA4481	6	10791440094397	PA4874	12	10791440073385	PA5276	12	10791440094991	PA5765	6	10791440093758	B7121	12	10791440050522
PA4483	6	10791440094536	PA4878	12	10791440072630	PA5282	6	10791440095080	PA5766	6	10791440093802	B7124	12	10791440051307
PA4484	6	10791440094663	PA4879	12	10791440072647	BA5284	4	10791440095103	PA5768	6	10791440093833	B7125	12	10791440051390
PA4485	6	10791440094700	PA4883	12	10791440072685	PA5306	6	10791440077130	PA5770	6	10791440094458	B7128	12	10791440052083
PA4486	6	10791440095110	PA4885	4	10791440072708	PA5311	12	10791440077338	PA5772	6	10791440094472	W7129-C	7	10791440052526
PA4487	6	10791440095134	PA4886	12	10791440072715	PA5312 KIT	6	10791440077345	PA5773	6	10791440094489	B7130	12	10791440052601
PA4551	12	10791440061238	PA4888	6	10791440072739	PA5314	6	10791440077369	PA5774	6	10791440094502	B7131	12	10791440052618
PA4552	12	10791440061245	PA4890	6	10791440072753	PA5316	12	10791440077468	BF5800	12	10791440027197	P7132	12	10791440053127
PA4555	6	10791440061375	PA4891	12	10791440072760	PA5317	6	10791440077475	BF5801	12	10791440027180	P7134	12	10791440054322
PA4556	12	10791440061382	PA4895	12	10791440072807	PA5318	6	10791440077499	BF5810	12	10791440027203	B7135	6	10791440054380
PA4557	6	10791440061399	PA4902	12	10791440072869	PA5319	6	10791440077505	BF5812	12	10791440027210	P7136	12	10791440054605
PA4600	6	10791440063706	PA4905	12	10791440072890	PA5320	6	10791440077512	BF5813	12	10791440027227	P7137	12	10791440054612
PA4601	6	10791440063713	PA4906	6	10791440072906	PA5321	6	10791440077529	BF5813-O	12	10791440097596	P7138	12	10791440054629
PA4612	6	10791440063935	PA4907	12	10791440072913	PA5322	6	10791440077564	BF5815	12	10791440060381	B7139	12	10791440054674
PA4632	6	10791440065335	PA4908	12	10791440072920	PA5328	6	10791440077871	BF5816	12	10791440066974	BD7141	6	10791440055091
PA4633	12	10791440065342	PA4910	6	10791440072944	PA5330	12	10791440078175	6020	6	10791440027302	B7142	12	10791440055127
PA4661	12	10791440066875	PA4911	12	10791440072951	PA5333	6	10791440078441	6021	6	10791440027319	B7143	12	10791440055811
PA4662	12	10791440066851	PA4931	12	10791440073156	PA5337	6	10791440078632	P7000 KIT	6	10791440038131	B7144	12	10791440055954
PA4663	12	10791440066868	PA4932	6	10791440073163	PA5339	6	10791440078878	B7001	12	10791440048192	P7145	12	10791440056616
PA4664	12	10791440066875	PA4934	12	10791440073187	PA5341	6	10791440078915	P7003	3	10791440028484	B7151	12	10791440056845
PA4668	6	10791440066882	PA4935	12	10791440073194	PA5353	12	10791440079400	B7004	6	10791440028491	B7152	12	10791440056852
PA4669	12	10791440066899	PA4938	4	10791440073224	PA5359	6	10791440079523	B7005	6	10791440028507	BD7153	6	10791440056883
PA4681	6	10791440067360	PA4939	12	10791440073231	BA5374	4	10791440078847	P7007	4	10791440038810	BD7154	6	10791440056890
PA4682	6	10791440067421	PA4941	4	10791440073255	BA5375	4	10791440078854	B7009	12	10791440028538	B7155	6	10791440056937
PA4688	12	10791440067612	PA4957	6	10791440075228	BA5376	4	10791440078861	B7010	12	10791440028545	B7156	6	10791440057491
PA4688 FOAM	6	10791440067629	PA4975	12	10791440075990	BA5378	4	10791440085715	B7011	6	10791440028552	B7157	6	10791440057767
PA4689	12	10791440067636	PA4979	12	10791440075952	BA5379	4	10791440085722	P7012	4	10791440038827	BD7159	6	10791440057958
PA4694	12	10791440067766	PA4985	6	10791440076379	PA5393	6	10791440080222	P7013	12	10791440042565	B7161	6	10791440058122
PA4695	12	10791440067773	PA4986	6	10791440076386	PA5428	6	10791440082875	B7014	12	10791440028569	B7162	6	10791440058200
PA4696 FOAM	12	10791440067780	PA4987	6	10791440076393	PA5457	12	10791440085784	P7015	12	10791440046624	B7163	12	10791440058016
PA4698	6	10791440067803	CS5007	12	10791440026749	PA5482	6	10791440086446	P7016	12	10791440046723	B7164	12	10791440058023
PA4701	6	10791440068585	CS5008	12	10791440026756	PA5494	6	10791440086798	B7017	12	10791440046730	B7165	12	10791440058054
PA4707	6	10791440067841	CS5009	6	10791440026763	PA5495	6	10791440086804	B7018	12	10791440028576	BD7166	6	10791440058146
PA4711	4	10791440067889	CS5012	4	10791440026794	BA5566	4	10791440088662	B7019	6	10791440028583	B7167	12	10791440058443
PA4714	6	10791440067919	CTK5029	24	10791440043234	PA5580	6	10791440089768	B7020	12	10791440028590	BD7169	6	10791440058665
PA4720	12	10791440067971	CTK5029-M	24	10791440079141	BF5587-D	12	10791440076485	P7021	12	10791440046471	B7170	12	10791440058757
PA4723	2	10791440068008	CS5058	6	10791440026893	BA5592	4	10791440090009	B7022	12	10791440028606	B7171	12	10791440058764
PA4727	12	10791440068046	OTK5060	10	10791440026909	PA5519	6	10791440090207	B7023	12	10791440028613	B7172	12	10791440059648
PA4729	6	10791440068060	OTK5061	12	10791440026916	PA5620	6	10791440090214	B7024	12	10791440028620	BC7173	12	10791440059419
PA4730	6	10791440068077	OTK5062	12	10791440026923	PA5622	6	10791440090238	B7025	12	10791440028637	B7174-MPG	12	10791440061269
PA4731	6	10791440068084	OTK5063	10	10791440026930	PA5623	6	10791440090245	B7026-MPG	12	10791440048703	B7175	6	10791440058405
PA4732	12	10791440068091	BW5070	12	10791440026947	PA5624	6	10791440090252	BD7028	12	10791440037615	BD7176	6	10791440060149
PA4733	6	10791440068107	BW5071	12	10791440026954	PA5629	6	10791440090337	BD7029	12	10791440051222	B7177	12	10791440060217
PA4734	6	10791440068114	BW5072	12	10791440026961	PA5631	6	10791440090351	B7030	6	10791440040240	P7178	12	10791440060286
PA4735	12	10791440068121	BW5073	12	10791440026978	PA5632	6	10791440090399	B7031	12	10791440038858	B7179	12	10791440060293
PA4736 FOAM	12	10791440068138	BW5074	12	10791440026985	PA5633	6	10791440090474	B7033	12	10791440054230	B7180	6	10791440058559
PA4737	6	10791440068145	BW5075	12	10791440026992	PA5637	6	10791440090696	B7034	12	10791440054247	B7181	12	10791440060736
PA4738	6	10791440068152	BW5076	12	10791440027005	PA5638	6	10791440090702	P7035	12	10791440038117	B7182	6	10791440060842
PA4750	6	10791440068275	BW5082	12	10791440043104	PA5658	6	10791440091419	B7039	12	10791440037851	P7183	4	10791440061061
PA4754	6	10791440068312	BW5086	12	10791440057590	PA5660	6	10791440091433	B7042	12	10791440038872	P7185	12	10791440061474
PA4755	10	10791440068329	B5087	12	10791440058269	PA5661	6	10791440091440	B7044	12	10791440038384	BC7186 KIT	12	10791440061610
PA4756	6	10791440068336	B5088	12	10791440058276	PA5662	6	10791440091457	B7045	12	10791440043678	B7187	6	10791440061733
PA4758	12	10791440068350	B5089	12	10791440063447	PA5666	6	10791440091495	B7047	12	10791440038063	P7188	12	10791440061948
PA4760	12	10791440068374	B5090	12	10791440065670	PA5669	6	10791440091563	B7049	12	10791440044996	B7189	12	10791440060859
PA4763	12	10791440068404	B5091	12	10791440082837	PA5679	6	10791440091747	P7050	12	10791440043715	B7191	12	10791440062044
PA4764	6	10791440068411	P5092	12	10791440091549	PA5683	6	10791440091921	B7051	12	10791440037622	BC7194	12	10791440062143
PA4769	12	10791440068466	B5134	12	10791440027043	PA5689	6	10791440092188	P7052	12	10791440045719	P7196	12	10791440062396
PA4772	12	10791440068497	BW5136	12	10791440027050	PA5690	6	10791440092195	P7053	12	10791440037585	B7197	12	10791440064031
PA4773	12	10791440068503	BW5137	12	10791440027067	PA5691	6	10791440092201	P7055	12	10791440037738	P7199	12	10791440062600
PA4777	12	10791440068558	BW5138	12	10791440027074	PA5694	6	10791440092232	P7081	12	10791440043142	B7215	12	10791440062990
PA4778	12	10791440068565	BW5139	12	10791440027081	PA5698	6	10791440092324	B7082	12	10791440043289	B7216	12	10791440063102
PA4785	4	10791440068633	BW5140	12	10791440027098	PA5700	12	10791440092423	P7083	12	10791440043326	B7217	6	10791440063119
PA4793	6	10791440068718	BW5141	12	10791440027104	PA5714	6	10791440092737	B7084	12	10791440043357	B7219	12	10791440063768
PA4814	2	10791440068923	BW5142	12	10791440052588	PA5720	6	10791440092812	B7089	12	10791440045016	B7220	12	10791440063874
PA4819	12	10791440068978	BW5143	12	10791440057026	PA5721	6							

BALDWIN CASE TO I 2/5 (SHIPPING CASES)

BALDWIN CASE NUMBER	CASE QTY.	I 2/5 NUMBER	BALDWIN CASE NUMBER	CASE QTY.	I 2/5 NUMBER	BALDWIN CASE NUMBER	CASE QTY.	I 2/5 NUMBER	BALDWIN CASE NUMBER	CASE QTY.	I 2/5 NUMBER	BALDWIN CASE NUMBER	CASE QTY.	I 2/5 NUMBER
B7237	12	10791440087061	B7356	12	10791440085845	B7446	12	10791440083261	PF7554	12	10791440038254	BF7682-D	12	10791440066417
B7238	12	10791440065380	B7357	12	10791440085883	B7449	12	10791440083957	BF7557	12	10791440028866	BF7683	12	10791440059655
B7239	6	10791440065472	B7359	12	10791440085913	P7450	12	10791440083308	BF7558	12	10791440028880	B7685	12	10791440058399
B7240	12	10791440065496	B7360	12	10791440086132	B7451	12	10791440083315	BF7559	12	10791440038346	BF7686	12	10791440058504
B7241	6	10791440065687	B7361	12	10791440086187	B7452	12	10791440083360	BF7571	6	10791440041292	PF7687	12	10791440058528
BC7242	12	10791440066226	B7362	12	10791440086231	B7453	12	10791440083483	PF7572	12	10791440042534	BF7690	12	10791440058573
B7243	12	10791440066363	B7363	6	10791440086378	BC7456 KIT	12	10791440083834	BF7576	12	10791440042763	BF7691	12	10791440058863
B7245	6	10791440066776	P7364	12	10791440086385	P7454	12	10791440083582	B7577	6	10791440028903	BF7693	12	10791440058894
B7246	6	10791440067032	P7365	12	10791440086453	P7455	12	10791440083667	BF7579	12	10791440042770	BF7695	6	10791440059280
P7247	12	10791440067162	B7367	12	10791440086552	B7457	12	10791440088303	BF7580	12	10791440042787	BF7696	12	10791440059662
B7249-MPG	6	10791440067216	P7368	12	10791440086620	B7458	12	10791440088310	PF7583	12	10791440043128	BF7697	6	10791440059914
BD7250	6	10791440067384	B7369	12	10791440086866	B7459	12	10791440088327	BF7584	12	10791440043135	PF7698	12	10791440059907
BD7252	6	10791440067391	B7370	12	10791440086927	B7460	12	10791440088488	B7585	12	10791440043272	BF7699-D	12	10791440066486
P7255	12	10791440071732	P7371	12	10791440086934	B7461	12	10791440088495	BF7586	12	10791440043302	B7700	12	10791440066837
P7256	12	10791440071749	B7372	12	10791440087184	B7462	12	10791440088525	BF7587	12	10791440043331	BF7711	12	10791440060712
P7259	12	10791440071770	B7373	12	10791440087313	B7464	12	10791440088532	PF7588	12	10791440043333	BF7713	12	10791440060477
P7260	12	10791440071787	B7375	12	10791440087382	B7465	12	10791440088549	P7490	12	10791440089331	PF7715	6	10791440060491
P7261	12	10791440071794	B7376	12	10791440087399	B7466	12	10791440088668	BF7591-D	12	10791440045528	BF7717	12	10791440060514
P7262	12	10791440071800	B7377	12	10791440087405	B7467	12	10791440088709	PF7592	12	10791440045580	PF7718	12	10791440060597
P7263	12	10791440071817	B7378	12	10791440087429	B7468	12	10791440088716	BF7593	12	10791440046129	BF7719	12	10791440061085
P7264	12	10791440071824	B7379	12	10791440087481	B7469	12	10791440088723	PF7594	12	10791440046280	BF7720	12	10791440061108
P7265	12	10791440071831	P7380	12	10791440087726	B7470	12	10791440088747	BF7595	12	10791440046297	BF7721	12	10791440061139
P7269	12	10791440071879	P7381	6	10791440087764	B7472	12	10791440088815	PF7596	12	10791440046419	BF7725	12	10791440061160
B7271	12	10791440071893	B7383	12	10791440087535	B7473	12	10791440088822	PF7597	12	10791440046532	BF7726	12	10791440061405
B7273	12	10791440071916	B7384	12	10791440087542	B7474	12	10791440088839	BF7598	12	10791440047577	PF7733	12	10791440061856
B7274	12	10791440071923	B7385	12	10791440087559	B7475	12	10791440088846	B7600	12	10791440028934	PF7734	12	10791440061863
B7275	12	10791440071930	B7386	12	10791440087566	B7476	12	10791440088853	B7600-SS	12	10791440050430	PF7735	12	10791440061924
B7276	12	10791440071947	B7387	12	10791440087573	B7477	12	10791440088860	BF7602	12	10791440047669	BF7736	12	10791440062273
B7277	12	10791440071954	B7388	12	10791440088143	B7478	12	10791440088877	BF7606	12	10791440047829	BF7736-K1	12	10791440069661
B7280	12	10791440071985	B7389	12	10791440088204	B7481	12	10791440088914	BF7608	12	10791440048949	BF7742	12	10791440062655
B7281	12	10791440071992	B7390	12	10791440088235	B7482	12	10791440088921	BF7609	12	10791440050201	PF7744	12	10791440062808
B7283	12	10791440072012	B7392	12	10791440088242	B7483	12	10791440088938	BF7612	12	10791440050454	BF7745-D	12	10791440066479
B7285	12	10791440072036	B7393	12	10791440088259	P7484	12	10791440088990	BF7613	12	10791440050461	BF7746-D	12	10791440066482
B7286	12	10791440072043	BC7394	12	10791440092416	BC7485	12	10791440089058	BF7614	12	10791440050508	BF7747	12	10791440063201
B7287	12	10791440072050	B7395	12	10791440092546	B7486	12	10791440089140	P7615	12	10791440050515	PF7748	12	10791440063218
B7289	12	10791440072074	B7396	6	10791440077390	B7487	12	10791440089157	PT7617	12	10791440050614	PF7749	12	10791440063225
B7290	12	10791440072081	B7397	12	10791440077943	P7488	12	10791440089201	BF7618	12	10791440050904	BF7750	12	10791440063270
B7291	12	10791440072098	P7398	12	10791440080345	P7489	12	10791440089218	BF7619	12	10791440050966	PF7751	12	10791440062952
B7292	12	10791440072104	P7399	12	10791440080352	B7491	12	10791440089348	BF7623	6	10791440051499	BF7753	12	10791440063676
B7293	12	10791440072111	P7400	12	10791440080369	P7492	12	10791440089867	BF7624	12	10791440051666	PF7755	12	10791440065427
B7294	12	10791440072128	B7401	12	10791440080376	P7493	12	10791440089895	BF7625	12	10791440051772	BF7756	12	10791440063737
B7295	12	10791440072135	B7402	6	10791440080611	P7494	6	10791440090085	BF7626	12	10791440052038	PF7758	12	10791440063836
B7298	12	10791440074702	B7403	12	10791440080628	B7496	12	10791440090535	PF7627	6	10791440052045	BF7759	12	10791440064024
B7299	6	10791440066752	P7405	6	10791440080734	B7497	12	10791440090962	BF7628	12	10791440052229	BF7760	12	10791440063966
P7302	12	10791440074733	P7406	12	10791440080918	B7499	12	10791440091686	BF7629	12	10791440052274	PF7761	12	10791440064840
P7303	12	10791440074740	B7407	12	10791440081052	F7500	4	10791440028712	BF7631	12	10791440052328	BF7762	12	10791440064154
P7305	12	10791440075037	P7408	12	10791440081182	P7500	4	10791440028729	BF7632	12	10791440052359	BF7765	12	10791440064482
B7306	12	10791440076294	B7409	12	10791440081199	B7501	12	10791440091884	BF7633	12	10791440053110	BF7766	12	10791440065151
P7308	12	10791440076461	B7410	12	10791440081205	P7502	6	10791440091990	BF7634	12	10791440053295	PF7767	12	10791440065540
BD7309	6	10791440058948	P7411	12	10791440081229	BD7504	6	10791440092270	BF7635	6	10791440053370	BF7768	12	10791440065878
BD7310	6	10791440060682	P7413	12	10791440081274	P7505	6	10791440088297	BF7637	12	10791440086156	BF7769	12	10791440066141
B7311-MPG	12	10791440076539	P7414	12	10791440081281	B7506	12	10791440092287	BF7639	6	10791440054438	PF7770	12	10791440066165
P7312	6	10791440076546	P7415	12	10791440081366	B7507	12	10791440092409	BF7639-D	6	10791440054834	BF7771	12	10791440066271
P7313	12	10791440076577	B7416	6	10791440081410	P7508	6	10791440092584	BF7640	12	10791440056258	BF7772	12	10791440066592
B7314	6	10791440076744	P7417	12	10791440081984	BD7509	6	10791440092683	BF7644	12	10791440052748	BF7773	12	10791440066691
B7316	12	10791440076911	P7418	12	10791440081618	P7510	12	10791440093239	BF7645	12	10791440052825	BF7774	12	10791440066707
BD7317	12	10791440076966	B7419	12	10791440081786	B7511	12	10791440093260	BF7648	12	10791440053066	BF7775	12	10791440066950
B7318	12	10791440077048	B7420	12	10791440081915	P7512	12	10791440093734	BF7653	12	10791440056265	BF7776	12	10791440066967
P7319	12	10791440077086	B7422	12	10791440081922	B7513	6	10791440093741	PF7655	12	10791440057484	PF7777	12	10791440067001
B7320	12	10791440077178	P7423	12	10791440081946	P7515	12	10791440093826	BF7656	12	10791440055469	BF7778	12	10791440067018
B7322	6	10791440077321	B7424	12	10791440082097	P7517	12	10791440094434	BF7657	12	10791440055309	PF7779	12	10791440067087
B7324	6	10791440077673	P7426	12	10791440082103	BF7519	12	10791440028767	BF7658	12	10791440054902	BF7780	12	10791440067148
BD7325	6	10791440077741	P7427	12	10791440082110	BF7528	12	10791440028828	BF7659	12	10791440054919	PF7782	6	10791440067483
BC7326	12	10791440078526	B7428	12	10791440082165	BF7529	12	10791440028835	BF7661	12	10791440054933	BF7783-D	12	10791440067490
B7327	12	10791440078564	B7429	12	10791440082288	BF7531	12	10791440039889	BF7663	12	10791440054971	BF7784-D	12	10791440067506
B7328	12	10791440078656	B7430	12	10791440082271	BF7532	12	10791440046556	BF7664	12	10791440054988	BF7785-D	12	10791440067513
P7329	6	1079144007												

BALDWIN CASE TO I 2/5 (SHIPPING CASES)

BALDWIN CASE NUMBER	CASE QTY.	I 2/5 NUMBER	BALDWIN CASE NUMBER	CASE QTY.	I 2/5 NUMBER	BALDWIN CASE NUMBER	CASE QTY.	I 2/5 NUMBER	BALDWIN CASE NUMBER	CASE QTY.	I 2/5 NUMBER	BALDWIN CASE NUMBER	CASE QTY.	I 2/5 NUMBER
BF7808	12	10791440065038	BF7904-D	12	10791440077383	BF7989-D	12	10791440086286	BT8440-MPG	12	10791440059037	BT8874-MPG	6	10791440046440
BF7809	12	10791440065076	BF7905-D	12	10791440077413	BF7990	12	10791440086439	BT8443	12	10791440059501	BT8875-MPG	6	10791440046563
PF7812 KIT	12	10791440065137	BF7906-D	12	10791440077420	BF7993	12	10791440086484	BT8444	12	107914400595617	BT8876-MPG	6	10791440046772
BF7813	12	10791440065311	BF7907	12	10791440077437	PF7994	12	10791440086606	BT8445	12	10791440059785	BT8877-MPG	6	10791440055756
BF7814	12	10791440065359	BF7908	12	10791440077550	BF7995	12	10791440086613	P8448	12	10791440059884	BT8878-MPG	6	10791440055763
BF7815	12	10791440067230	BF7909	12	10791440077567	BF7996	6	10791440086675	BT8449	12	10791440060002	BT8879-MPG	6	10791440055770
PF7816	12	10791440069319	PF7910	12	10791440077581	BF7997	12	10791440086781	BT8449-10	12	10791440060019	BT8880-MPG	6	10791440056180
PF7817	12	10791440069326	BF7911	12	10791440077987	BF7998	12	10791440086828	BT8450	12	10791440060101	PT8883	12	10791440064932
PF7818	24	10791440069333	BF7912	12	10791440078137	BT8301	12	10791440029078	PT8452	12	10791440060156	PT8884-MPG	12	10791440065090
PF7819	12	10791440069340	BF7913	6	10791440078151	BT8302	12	10791440038986	BT8453	4	10791440060347	PT8885-MPG	12	10791440065168
PF7820	12	10791440069357	BF7915	12	10791440078410	BT8304	12	10791440029092	BT8457-MPG	6	10791440060750	BT8886-MPG	6	10791440065199
BF7821	12	10791440069364	PF7916	12	10791440078533	PT8305	4	10791440029108	PT8459	12	10791440060880	PT8888	12	10791440065502
PF7822	30	10791440069371	BF7917	12	10791440078557	BT8306-10	12	10791440029115	BT8460	12	10791440062398	PT8889	4	10791440065601
PF7823	12	10791440069388	BF7919	12	10791440078816	PT8306-25	12	10791440029122	PT8461	6	10791440063973	BT8890-MPG	6	10791440065694
PF7824	30	10791440069395	BF7921	12	10791440078908	BT8307-MPG	6	10791440030463	PT8462-MPG	12	10791440061412	BT8892-MPG	6	10791440065748
PF7825	12	10791440069401	BF7922	12	10791440079004	BT8308-MPG	6	10791440030470	BT8463-MPG	6	10791440061559	PT8893	6	10791440065861
PF7826	12	10791440069418	BF7923	12	10791440079059	BT8312	6	10791440029139	BT8464	6	10791440061566	BT8898	12	10791440066233
PF7828	6	10791440069425	BF7924	12	10791440079257	BT8314	12	10791440029146	BT8465	6	10791440061573	BT8899	6	10791440066240
PF7829	12	10791440069432	BF7925	12	10791440079394	BT8316-MPG	12	10791440038902	PT8468	12	10791440061436	BT8900	12	10791440066301
PF7830	12	10791440069449	BF7927	12	10791440079158	PT8318-MPG	12	10791440029153	PT8470	12	10791440061467	BT8901-MPG	6	10791440066493
PF7832	12	10791440069463	PF7928	12	10791440079530	PT8319	12	10791440043159	BT8472	12	10791440061498	BT8902	12	10791440066646
PF7833	12	10791440069470	PF7930	6	10791440079684	BT8320	6	10791440029160	BT8473	12	10791440061504	BT8903	12	10791440066660
PF7834	12	10791440069487	BF7931	12	10791440079844	BT8323	12	10791440038919	BT8474	12	10791440061511	BT8904-MPG	6	10791440066677
PF7836	12	10791440069500	BF7932	6	10791440079851	BT8328	12	10791440038087	BT8475	12	10791440061528	BT8905	12	10791440067025
BF7837	12	10791440069517	PF7934 KIT	12	10791440080130	PT8329	12	10791440042923	BT8475-MPG	6	10791440073545	BT8906	6	10791440067124
BF7838	12	10791440069524	PF7935	12	10791440080215	PT8330-MPG	6	10791440038940	BT8476	6	10791440061535	PT8907-MPG	12	10791440067155
BF7839	20	10791440069531	PF7936	12	10791440080338	BT8333	6	10791440038957	BT8476-MPG	6	10791440069685	BT8908	12	10791440067223
BF7840	12	10791440069548	BF7937	12	10791440080390	PT8334	6	10791440043722	BT8477	6	10791440061542	BT8910-MPG	6	10791440067308
BF7841	12	10791440069555	PF7938	6	10791440080635	PT8335	6	10791440043173	BT8477-MPG	6	10791440073552	BT8911-MPG	6	10791440067315
BF7842	12	10791440069562	PF7939	12	10791440080857	PT8338	12	10791440043654	PT8481	12	10791440062631	PT8912	12	10791440067407
BF7843	12	10791440069579	BF7940	12	10791440080864	PT8339	12	10791440045894	PT8484	12	10791440061894	BT8913-MPG	12	10791440069678
BF7844	12	10791440069586	BF7941	12	10791440080871	PT8341	12	10791440043166	PT8485	12	10791440062051	BT8914	12	10791440069722
BF7845	12	10791440069593	BF7942	12	10791440080901	PT8344	12	10791440033758	BT8486	12	10791440062105	BT8916	12	10791440069746
BF7847	12	10791440069616	BF7943	12	10791440081151	PT8345	12	10791440038070	BT8487	12	10791440062129	BT8917	12	10791440069753
BF7848	12	10791440069623	BF7944	12	10791440081267	BT8347	6	10791440038292	BT8488	12	10791440062136	BT8918	12	10791440069760
BF7849	12	10791440069630	BF7945	12	10791440081403	PT8350	12	10791440039350	BT8493	12	10791440062372	BT8919	12	10791440069777
BF7850	12	10791440069647	PF7946	6	10791440081496	PT8351	12	10791440041193	PT8496-MPG	12	10791440062785	BT8920	12	10791440069784
BF7851	12	10791440069654	PF7947	12	10791440081595	PT8352	12	10791440041186	BT8497-MPG	12	10791440062853	BT8922	12	10791440069807
PF7852 KIT	12	10791440072494	BF7948	6	10791440081632	PT8353	6	10791440041209	BT8499	12	10791440063003	BT8926	12	10791440069845
BF7853	12	10791440072531	BF7949-D	12	10791440081656	PT8354	12	10791440042497	BT8501-MPG	12	10791440063058	BT8927	6	10791440069852
BF7855	12	10791440074573	BF7949-DM	12	10791440083339	PT8355	12	10791440042503	BT8502	12	10791440063096	BT8928	12	10791440069869
BF7857	12	10791440074597	BF7950-D	12	10791440081663	PT8356	12	10791440043098	BT8503-MPG	6	10791440063164	BT8930	6	10791440069883
BF7859	6	10791440074610	BF7951-D	12	10791440081748	BT8357	12	10791440043203	BT8504	12	10791440063171	BT8931	6	10791440069890
BF7860	12	10791440074627	BF7952-D	12	10791440081755	PT8363	12	10791440045092	BT8505	12	10791440063161	BT8935	12	10791440069937
BF7861	12	10791440074634	BF7954-D	12	10791440081779	BT8368	6	10791440045198	PT8507-MPG	12	10791440063539	BT8937	6	10791440069951
BF7863	12	10791440074641	BF7956-D	12	10791440081939	PT8370-MPG	12	10791440047119	BT8509-MPG	12	10791440063607	PT9127	12	10791440070643
BF7864	12	10791440074658	BF7955	12	10791440081908	PT8371-MPG	6	10791440047126	BT8512	12	10791440063633	PT9131	12	10791440070681
BF7865	12	10791440074665	BF7957	12	10791440082189	PT8372	12	10791440047652	OP8750	12	10791440083537	PT9134	12	10791440070711
BF7866	12	10791440074672	BF7958	12	10791440082400	PT8375-MPG	6	10791440048147	OP8751	12	10791440083544	PT9135	12	10791440070728
BF7868	12	10791440074474	PF7959	12	10791440082417	PT8376-MPG	6	10791440048154	OP8752	12	10791440083551	PT9136	12	10791440070735
PF7869	12	10791440074481	BF7960	12	10791440082424	BT8381	6	10791440049687	OP8753	12	10791440083568	PT9142	12	10791440070797
BF7870	12	10791440074498	BF7961	12	10791440082431	BT8382	6	10791440050102	BT8801-MPG	6	10791440060552	PT9143	12	10791440070803
BF7871	12	10791440074504	BF7962	12	10791440082585	BT8384	12	10791440050331	BT8802-MPG	6	10791440029191	PT9144	12	10791440070810
PF7872	12	10791440074511	BF7963	12	10791440082592	PT8385	12	10791440050539	BT8803-MPG	6	10791440029207	PT9147	12	10791440070841
PF7873	12	10791440074528	BF7964-D	12	10791440082608	BT8386	12	10791440050591	BT8812-MPG	6	10791440029238	PT9167	12	10791440071046
PF7874	12	10791440074535	BF7965	12	10791440082752	BT8391	12	10791440050942	BT8830	6	10791440042292	PT9169	10	10791440071060
PF7875	12	10791440074542	BF7966	12	10791440082820	PT8392	12	10791440051000	BT8832	6	10791440043005	PT9174	12	10791440071114
PF7876	12	10791440074559	BF7967	12	10791440082912	BT8393	12	10791440051541	BT8833	6	10791440058160	PT9180	12	10791440071176
PF7877	12	10791440074566	BF7968	12	10791440083254	BT8398-MPG	12	10791440051907	BT8840-MPG	6	10791440038391	PT9181	12	10791440071183
PF7878	12	10791440075044	BF7968-O	12	10791440097626	BT8401-MPG	6	10791440052120	BT8841-MPG	6	10791440046914	PT9185	12	10791440071220
BF7879	12	10791440075662	BF7969	12	10791440083681	PT8403-MPG	12	10791440052199	BT8842-MPG	6	10791440051970	PT9211	12	10791440071480
BF7880	12	10791440071886	BF7970	12	10791440085869	PT8404-MPG	12	10791440052281	BT8844	6	10791440042633	PT9214	12	10791440071510
BF7881	12	10791440075921	BF7971-D	12	10791440083346	PT8407	12	10791440053073	BT8843-MPG	6	10791440052007	PT9238	12	10791440074023
PF7882	12	10791440075914	BF7971-DM	12	10791440083353	BT8409	12	10791440053196	BT8845	6	10791440042626	PT9239	12	10791440074030
BF7883	12	10791440076287	BF7972	12	10791440083759	BT8412	12	10791440055421	BT8846	6	10791440045931	PT9260	12	1

BALDWIN CASE TO I 2/5 (SHIPPING CASES)

BALDWIN CASE NUMBER	CASE QTY.	I 2/5 NUMBER	BALDWIN CASE NUMBER	CASE QTY.	I 2/5 NUMBER	BALDWIN CASE NUMBER	CASE QTY.	I 2/5 NUMBER	BALDWIN CASE NUMBER	CASE QTY.	I 2/5 NUMBER	BALDWIN CASE NUMBER	CASE QTY.	I 2/5 NUMBER
BT93566	10791440077659	B960112	10791440094564	BF987812	10791440091556	PA100406	10791440105659	PT23127-MPG12	10791440097862
BT9362-MPG6	10791440078106	P960212	10791440095004	PF98796	10791440091754	PA100416	10791440105666	PT23128-MPG12	10791440097879
BT9363-MPG6	10791440078113	P960312	10791440095011	BF988012	10791440091761	PA100426	10791440105673	PT23129-MPG12	10791440097886
BT93646	10791440078397	B960412	10791440096506	BF988112	10791440091808	PA100436	10791440105680	PT23132-MPG12	10791440097916
BT9365-MPG6	10791440078427	P960512	10791440096575	BF988212	10791440091815	PA100446	10791440105741	PT2313612	10791440097787
BT9366-MPG6	10791440078434	B960612	10791440096612	BF988312	10791440091860	PA100456	10791440105758	PT231376	10791440097824
BT9367-MPG6	10791440078458	B960712	10791440096629	BF988412	10791440091938	PA100466	10791440105765	BT23525-MPG12	10791440103426
BT9368-MPG6	10791440078502	BF980012	10791440086966	BF98856	10791440091945	PA100476	10791440107295	PT2353612	10791440104331
BT9369-MPG6	10791440078519	PF980112	10791440087009	BF988612	10791440091983	PA100576	10791440107882	BT23543-MPG6	10791440104782
BT9370-MPG6	10791440078571	BF980212	10791440087047	BF988712	10791440092207	PA100586	10791440108353	PT23544-MPG12	10791440104799
BT9371-MPG6	10791440078724	PF980312	10791440087085	BF98886	107914400922034	PA100606	10791440108452	PT235606	10791440105628
PT937412	10791440078885	PF98046	10791440087117	PF988912	10791440092058	PA100626	10791440108629	PT235926	10791440107301
PT93754	10791440078939	BF980512	10791440087146	BF989012	10791440092065	PA100666	10791440108933	BT23603-MPG6	10791440107769
PT9380-MPG12	10791440079189	BF980712	10791440087320	BF9891-D12	10791440092072	PA100676	10791440108957	BT23607-MPG6	10791440107875
BT938212	10791440079295	BF9808-D12	10791440087337	BF9892-D12	10791440092089	PA100706	10791440109046	BT2361112	10791440108506
BT9386-MPG12	10791440079486	BF989312	10791440087368	PF989312	10791440092096	PA100716	10791440109053	PA300076	10791440096803
BT93876	10791440079912	BF9810-D12	10791440087375	BF989412	10791440092102	PA100726	10791440109060	PA300116	10791440096957
BT938812	10791440079950	BF9811-SP12	10791440087412	BF9895 KIT6	10791440092300	PA100736	10791440109077	PA300126	10791440096964
BT9391-MPG6	10791440080062	BF981212	10791440087504	PF9896 KIT6	10791440092348	CV150004	10791440084039	PA3001412	10791440096988
BT9392-MPG6	10791440080116	BF981312	10791440087511	PF989712	10791440092355	CV1500112	10791440089850	PA3001612	10791440097008
BT9393-MPG6	10791440080123	PF981412	10791440087528	BF9898-O12	10791440092379	CV1500312	10791440093567	PA3001712	10791440097015
PT9394-MPG12	10791440080727	BF981512	10791440087580	PF989912	10791440092386	CV150056	10791440104690	PA3001812	10791440097022
PT9395-MPG6	10791440080765	BF981612	10791440087603	PF990012	10791440092393	PE1700112	10791440106915	PA3002212	10791440097060
PT939612	10791440080826	BF981712	10791440087634	PF9901 KIT12	10791440092430	180036	10791440047898	PA3002412	10791440097084
BT9398-MPG6	10791440081489	BF981812	10791440087641	PF990212	10791440092515	180046	10791440047904	PA3002912	10791440097138
BT9400-MPG6	10791440082127	BF981912	10791440087658	BF9903-SP12	10791440092522	180076	10791440047935	PA300306	10791440097145
BT940212	10791440082411	BF982012	10791440087665	BF990412	10791440092577	180106	10791440047966	PA3003112	10791440097152
PT940512	10791440082295	BF982112	10791440087689	BF990512	10791440092744	180156	10791440029917	PA3003412	10791440097190
BT940812	10791440082639	BF9822-D12	10791440087702	BF990612	10791440092898	180226	10791440051352	PA3003512	10791440097206
PT9412-MPG12	10791440083193	PF982312	10791440087719	PF990712	10791440092997	180246	10791440051345	PA300446	10791440097299
PT9413-MPG12	10791440083278	PF982412	10791440087733	BF991012	10791440093208	180256	10791440051338	PA300506	10791440097350
PT9414-MPG12	10791440083698	PF982512	10791440087740	PF991112	10791440093246	180276	10791440051376	PA300516	10791440097367
PT941712	10791440083940	PF982612	10791440087757	BF9912-O12	10791440093475	180296	10791440052755	PA300526	10791440097374
PT941812	10791440083971	BF9827-D12	10791440087924	BF991312	10791440093505	180326	10791440055725	PA300536	10791440097381
PT9419-MPG12	10791440084145	BF9828-D12	10791440087986	PF9914 KIT6	10791440093574	180336	10791440056203	PA300546	10791440097398
BT9421-MPG6	10791440086699	BF9830-D12	10791440088198	BF991512	10791440093581	180346	10791440056210	PA300556	10791440097404
BT94226	10791440086811	BF983112	10791440088211	BF991612	10791440093659	180356	10791440059754	PA300566	10791440097411
PT942312	10791440086880	BF983212	10791440088228	BF991712	10791440093772	180566	10791440059761	PA300726	10791440098173
PT942412	10791440086965	BF9833-D12	10791440088266	BF9918 KIT6	10791440093796	180576	10791440059778	PA300806	10791440100593
PT9425-MPG6	10791440087016	BF983412	10791440088273	PF991912	10791440094496	181046	10791440029986	PA300866	10791440100777
PT942612	10791440087030	BF9835-D12	10791440088280	BF99206	10791440094601	181556	10791440030036	PA300936	10791440100883
PT9427-MPG6	10791440087108	BF9836-D12	10791440088433	BF9921-O12	10791440094694	181716	10791440030050	PA301156	10791440103402
PT9430-MPG12	10791440087474	BF9837-D12	10791440088518	BF9922-O12	10791440094755	181986	10791440030074	PA301266	10791440103945
BT94336	10791440087979	BF983812	10791440088587	BF9923-O12	10791440094953	182366	10791440030111	PA3013812	10791440104133
PT943412	10791440088099	BF9839-D12	10791440088624	PF9924 KIT6	10791440095172	182456	10791440030128	PA3013912	10791440104140
PT9435-MPG12	10791440088818	BF984012	10791440088693	BF9925-O12	10791440095196	182646	10791440060378	PA301406	10791440104157
BT9436-MPG6	10791440089133	BF984112	10791440088730	BF9926-O12	10791440095240	182656	10791440060385	PA301416	10791440104163
BT943712	10791440089501	BF984212	10791440088808	BF992712	10791440095271	182676	10791440060453	RS301426	10791440104973
BT94396	10791440089713	BF984312	10791440088884	PF992812	10791440096636	195936	10791440030241	PA301446	10791440104171
BT94406	10791440090375	BF984412	10791440088907	PF992912	10791440096643	198286	10791440030340	PA301516	10791440104386
PT9441-MPG6	10791440090665	PF984512	10791440089003	PA100006	10791440096644	199226	10791440030449	PA301526	10791440105727
BT9442-MPG12	10791440091020	BF984612	10791440089096	PA100016	10791440096681	199966	10791440064550	PA3015312	10791440104447
PT9444-MPG6	10791440091068	PF9847-D12	10791440089102	PA100026	10791440096688	199996	10791440064581	PA301546	10791440104453
PT944612	10791440091167	BF984812	10791440089195	PA100036	10791440096810	200006	10791440064598	PA3015712	10791440104485
PT944712	10791440091174	BF984912	10791440089225	PA100046	10791440096865	200016	10791440064604	PA301746	10791440105048
PT944812	10791440091181	BF985012	10791440089232	PA100066	10791440096902	200026	10791440064611	PA301776	10791440105086
PT944912	10791440091198	BF985112	10791440089324	PA100076	10791440096926	200036	10791440065762	PA301796	10791440105123
PT9450-MPG12	10791440091204	BF985212	10791440089355	PA100086	10791440097992	200046	10791440065792	PA301856	10791440105475
PT9453-MPG4	10791440084497	BF985312	10791440089362	PA100116	10791440098944	200056	10791440067377	PA301886	10791440105536
BT945612	10791440091709	BF985412	10791440089379	PA100136	10791440100586	200086	10791440077802	PA301896	10791440105567
PT946212	10791440091822	BF985712	10791440089485	PA100146	10791440100616	200096	10791440077819	PA301906	10791440105574
PT946312	10791440091853	BF98606	10791440090115	PA100156	10791440100784	200106	10791440077826	PA3020412	10791440108605
BT946412	10791440091846	PF986112	10791440090146	PA100166	10791440100890	200116	10791440077833	PA302516	10791440108865

BALDWIN CASE TO I 2/5 (SHIPPING CASES)

BALDWIN CASE NUMBER	CASE QTY.	I 2/5 NUMBER	BALDWIN CASE NUMBER	CASE QTY.	I 2/5 NUMBER	BALDWIN CASE NUMBER	CASE QTY.	I 2/5 NUMBER	BALDWIN CASE NUMBER	CASE QTY.	I 2/5 NUMBER	BALDWIN CASE NUMBER	CASE QTY.	I 2/5 NUMBER
P40020	12	10791440103457	BF46014	12	10791440097572	BF46052	12	10791440104393	61-W	12	10791440034942	43562P	24	10857123005192
P40021	12	10791440103600	BF46015	12	10791440097589	PF46056	12	10791440104706	66	12	10791440034980	43564P	12	20857123005146
B40022-MPG	12	10791440103563	BF46016-O	12	10791440097633	PF46057	12	10791440104716	66-30	12	10791440065854	43566P	12	40857123005157
P40023	12	10791440103716	BF46017-O	12	10791440097640	BF46062	6	10791440104775	66-W	12	10791440034997	43568P	24	10857123005163
P40024	12	10791440103723	BF46018-O	12	10791440097657	BF46065-SPS	12	10791440105604	101	18	10791440035574	43570P	12	20857123005177
P40025	12	10791440103730	BF46019-O	12	10791440097664	BF46071	12	10791440105239	101-30	18	10791440001371	43572P	6	30857123005181
BD40027	6	10791440104553	BF46020-O	12	10791440097671	BF46072	12	10791440105246	101-W	18	10791440035598	38557C	24	10857123005651
BT40028	12	10791440105024	BF46021-O	12	10791440097688	PF46077	12	10791440105710	151	18	10791440035918	38559C	24	10857123005416
P40030	12	10791440105031	BF46022-O	12	10791440097695	BF46078-D	12	10791440105796	151-30	18	10791440035925	38560C	12	20857123005429
P40031-MPG	6	10791440105079	BF46023-O	12	10791440097701	BF46083-O	6	10791440106755	151-W	18	10791440035932	38561C	6	30857123005433
BT40032	12	10791440105284	BF46024-O	12	10791440097718	BF46084	12	10791440106878	201	8	10791440036465	38564C	24	10857123005309
P40033	12	10791440105383	BF46025-O	12	10791440097725	BF46085	12	10791440107189	201-30	8	10791440036472	38565C	12	20857123005313
BT40034	12	10791440105468	BF46026-O	12	10791440097732	BF46087	12	10791440107288	201-W	8	10791440036496	38566C	6	30857123005327
P40035	12	10791440105697	BF46027-O	12	10791440097749	PF46088	12	10791440107318	301	4	10791440036953	38574C	12	20857123005467
B40036	12	10791440105703	BF46028-O	12	10791440097756	PF46092	6	10791440108490	301-30	4	10791440036960	43562C	24	10857123005491
BT40038	12	10791440105789	BF46029-O	12	10791440097763	BF46098-O	6	10791440107363	301-CS	4	10791440036977	43564C	12	20857123005504
B40050	12	10791440107455	BF46030-O	12	10791440097770	BF46099-O	6	10791440107387	301-W	4	10791440036984	43566C	12	40857123005515
P40052	12	10791440107684	BF46031	12	10791440098050	BF46100-O	6	10791440107370	501	4	10791440037059	43568C	24	10857123005552
B40053	6	10791440107738	BF46032	12	10791440098104	PF46103	12	10791440107707	501-30	4	10791440037066	43570C	12	20857123005566
B40054	12	10791440107745	PF46033	12	10791440098203	BF46111	12	10791440108254	501-W	4	10791440037073	43572C	6	30857123005570
B40056	12	10791440107844	BF46034	12	10791440098975	PF46112	12	10791440104492	PKG490-BANK	12	10791440065946	38557S	24	10857123005668
P40058	12	10791440108223	BF46037	12	10791440100920	BF46113-D	12	10791440108315				38564S	24	10857123005354
P40061	12	10791440108575	BF46038-D	12	10791440100982	BF46117	6	10791440108469				38565S	12	20857123005368
BF45000	12	10791440098298	BF46039-D	12	10791440100999	BF46122	12	10791440109602				38566S	6	30857123005372
BF46000	12	10791440096704	BF46040-D	12	10791440102467	PF46119	12	10791440108483				43562S	24	10857123005521
BF46001	12	10791440096711	BF46041-D	12	10791440103358	BF46125	12	10791440108728				43564S	12	20857123005535
PF46003	12	10791440096841	BF46042-D	6	10791440103365	BF46127	12	10791440108827				43566S	12	40857123005546
PF46004	12	10791440096858	BF46043-D	6	10791440103372	BF46129	6	10791440108995	Stanadyne Fuel Additives			38557P	24	10857123005217
BF46005	12	10791440096896	BF46044-D	12	10791440103440	PF46130	12	10791440109152	38559P	24	10857123005057	38559P	24	10857123005057
BF46006	12	10791440097497	BF46045-D	12	10791440103846	BF46147-O	12	10791440109787	38560P	12	20857123005061	38560P	12	20857123005061
BF46007	12	10791440097503	PF46046	12	10791440103969	BD50000	6	10791440105093	38561P	6	30857123005075	38561P	6	30857123005075
BF46008	12	10791440097510	BF46048	12	10791440104034	OAS98000	12	10791440096960	38564P	24	10857123005002	38564P	24	10857123005002
PF46009	12	10791440097527	PF46049	12	10791440104546	OAS99035	12	10791440074788	38565P	12	20857123005016	38565P	12	20857123005016
BF46012	12	10791440097558	BF46050	12	10791440104300	G183	10	10791440002262	38566P	6	30857123005020	38566P	6	30857123005020
BF46013	12	10791440097565	BF46051	12	10791440104348	61	12	10791440034935	38574P	12	20857123005108	38574P	12	20857123005108

NOTES

I 2/5 TO BALDWIN CASE (SHIPPING CASES)

I 2/5 NUMBER	CASE QTY.	BALDWIN NUMBER	I 2/5 NUMBER	CASE QTY.	BALDWIN NUMBER	I 2/5 NUMBER	CASE QTY.	BALDWIN NUMBER	I 2/5 NUMBER	CASE QTY.	BALDWIN NUMBER	I 2/5 NUMBER	CASE QTY.	BALDWIN NUMBER
10791440042671	6	BD103-MPG	10791440001104	12	PT86-HD	10791440002125	12	B168	10791440003108	12	P249	10791440004082	12	BT350
10791440065342	12	PA4633	10791440001111	12	PT87-S	10791440002149	12	P170	10791440003115	12	BT251	10791440004099	12	BT351
10791440000015	12	B2	10791440001128	12	PT88-HD	10791440002156	12	P171	10791440003122	12	B252	10791440004105	6	P352
10791440000022	12	B2-HPG	10791440001135	12	PT89	10791440002163	12	P172	10791440003139	12	B253	10791440004112	12	BT353
10791440000046	12	B4	10791440001142	12	PT90-10	10791440002170	12	B173-S	10791440003153	12	B255	10791440004129	12	BT354
10791440000053	12	BT5	10791440001159	12	PT90-MPG	10791440002187	12	P174	10791440003160	12	PT256	10791440004136	12	BT355
10791440000060	12	B6	10791440001166	12	PT91	10791440002200	12	P176	10791440003177	12	PT257	10791440004143	12	P356
10791440000077	12	B6-HPG	10791440001180	12	PT93	10791440002217	12	P177	10791440003184	12	PT258	10791440004150	12	BT357
10791440000084	12	B7	10791440001197	12	PT93-MPG	10791440002224	12	B178	10791440003191	12	BT259	10791440004167	12	B358
10791440000091	12	B9	10791440001210	6	B95	10791440002231	12	B179	10791440003207	12	BT260	10791440004174	6	BT359
10791440000107	6	B10-AL	10791440001241	6	B95-MPG	10791440002262	10	G183	10791440003214	12	BT260-10	10791440004181	12	B360
10791440000114	6	B10-AL BOWL	10791440001258	6	B96	10791440002279	12	P183	10791440003221	12	BT261	10791440004198	12	BT361
10791440000121	6	B10-AL CAP	10791440001289	6	B96-MPG	10791440002293	12	P184	10791440003238	12	B262	10791440004211	12	BT364
10791440000138	12	PF10	10791440001296	6	B97	10791440002309	12	PT185	10791440003245	12	B263	10791440004228	12	BT365
10791440000145	12	PF10-CS	10791440001302	6	PT98-10	10791440002316	12	P186	10791440003252	12	BT264	10791440004235	12	BT365-10
10791440000152	12	PT11	10791440001319	6	PT98-MPG	10791440002323	12	P187	10791440003269	12	PT265	10791440004242	12	BT366-10
10791440000169	12	PT11-HD	10791440001326	6	B99	10791440002347	12	PT189	10791440003276	12	P266	10791440004259	12	BT367
10791440000176	12	PT12	10791440001333	6	B99-B	10791440002354	12	PT189-MPG	10791440003283	12	BT267	10791440004266	12	BT367-S
10791440000183	12	BF13	10791440001357	6	B99-MPG	10791440002361	12	P190	10791440003290	12	PT268	10791440004273	12	BT368
10791440000190	12	P15	10791440001371	18	101-30	10791440002385	6	PT191-10	10791440003306	12	PT269	10791440004280	12	B369
10791440000206	12	S16-1	10791440001388	12	P102	10791440002446	6	P194	10791440003320	12	P271	10791440004297	4	PT370
10791440000237	12	P18	10791440001395	6	BD103	10791440002453	6	P194-HD	10791440003344	12	PT273	10791440004303	12	BT371-10
10791440000244	12	P18-HD	10791440001401	12	P104	10791440002460	6	P194-HD10	10791440003351	12	BT274	10791440004310	12	BT371-MPG
10791440000251	12	P19	10791440001418	6	B105	10791440002477	6	PF194	10791440003368	12	PT275	10791440004327	12	BT372-10
10791440000268	12	P20-HD	10791440001425	12	P106	10791440002484	12	B195	10791440003375	12	PT275-10	10791440004334	12	PT373
10791440000312	12	V24-A2	10791440001432	12	P106-HD	10791440002491	6	B196	10791440003382	12	P276	10791440004341	12	PT374
10791440000336	12	P25	10791440001456	12	PT108	10791440002507	6	B196-MPG	10791440003405	12	PT277	10791440004358	12	PT375
10791440000343	12	P26	10791440001463	12	PT108-HD	10791440002514	12	P198	10791440003412	12	B279	10791440004365	12	PT376
10791440000350	12	B27	10791440001470	12	B109	10791440002521	12	B199	10791440003429	12	P280	10791440004372	12	PT377
10791440000367	12	BD28	10791440001487	12	BC110	10791440002545	12	B201-S	10791440003436	12	B281	10791440004389	12	PT377-10
10791440000374	12	PT29	10791440001494	12	BT111	10791440002552	12	B202	10791440003467	12	PT283	10791440004396	12	B378
10791440000398	12	B30	10791440001500	12	BT112	10791440002569	12	P203	10791440003474	12	PT284	10791440004402	12	B378-10
10791440000404	12	B31	10791440001517	12	B113	10791440002576	12	P203-HD	10791440003481	6	PT285	10791440004419	6	PT379 KIT
10791440000428	12	B33	10791440001524	12	B114	10791440002583	12	P203-HD10	10791440003498	6	BT287	10791440004433	12	PT381
10791440000435	12	B34	10791440001531	12	PT115	10791440002590	12	P204	10791440003504	6	BT287-10	10791440004440	12	PT382
10791440000442	12	B35-S	10791440001556	6	PF116	10791440002606	12	P204-HD	10791440003511	12	PT288-HD	10791440004457	12	PT383
10791440000466	6	AFG37R	10791440001562	6	PT117	10791440002613	12	P204-HD10	10791440003528	12	PT288-HD10	10791440004464	12	PT385
10791440000473	12	B37	10791440001579	6	PT117-25	10791440002620	6	B205	10791440003535	12	PT289	10791440004471	12	PT385-E
10791440000480	6	AFG38D	10791440001586	12	B118	10791440002637	12	P206	10791440003542	12	PT289-10	10791440004488	12	PT386
10791440000503	12	B39	10791440001647	12	B120	10791440002644	12	PT207	10791440003559	12	PT290	10791440004495	6	BT387
10791440000510	12	P40	10791440001654	12	PF121	10791440002651	12	PT207-10	10791440003573	12	BT292	10791440004501	6	BT387-10
10791440000527	12	P41	10791440001685	12	BT124	10791440002668	12	PT207-HD	10791440003597	12	P294	10791440004518	6	BT388
10791440000534	12	P42	10791440001692	12	P125	10791440002675	12	PT207-HD10	10791440003603	12	B295	10791440004525	6	BT388-10
10791440000541	12	B43-S	10791440001708	12	BT126	10791440002682	6	PT208	10791440003610	12	B296	10791440004532	6	BT389
10791440000565	12	B45	10791440001715	12	B128	10791440002699	12	PT210	10791440003627	12	PT298-10	10791440004549	6	BT389-10
10791440000589	12	P47	10791440001722	12	B129	10791440002705	12	B211	10791440003634	12	B299	10791440004556	12	PT390-MPG
10791440000596	12	PT48	10791440001746	12	B131	10791440002729	12	PT213	10791440003641	12	T300-M	10791440004563	12	PT391-MPG
10791440000602	6	B49	10791440001753	12	B132	10791440002736	12	PT214(2)	10791440003658	12	B301	10791440004570	12	PT392
10791440000619	12	B50	10791440001760	7	C133-OW	10791440002743	12	BT215	10791440003665	12	PT302	10791440004587	12	PT393
10791440000633	12	P52	10791440001777	7	C133-W	10791440002750	12	BT216	10791440003672	12	T303-M	10791440004594	6	PT394-15
10791440000640	12	P53	10791440001784	12	B134	10791440002767	12	BT217	10791440003689	12	PT304	10791440004600	12	BT395
10791440000657	12	P54	10791440001791	12	PT135	10791440002774	12	B218	10791440003702	12	B307	10791440004617	12	PT396
10791440000671	12	B56	10791440001814	12	PT137	10791440002798	6	B220	10791440003719	12	T308-M	10791440004624	4	PT397
10791440000718	12	P60	10791440001821	12	PT138-10	10791440002804	12	BT221	10791440003726	12	B309	10791440004631	12	BT398
10791440000725	12	PT61-HD	10791440001838	12	PT138-25	10791440002811	12	B222	10791440003733	12	PF311	10791440004648	6	PT400
10791440000732	12	PT62	10791440001845	12	PT139-10	10791440002828	12	BT223	10791440003740	12	PF312	10791440004655	6	PT401-MPG
10791440000749	12	PT63-1	10791440001852	12	P140	10791440002835	12	PF224	10791440003757	12	PF313	10791440004662	12	BT402
10791440000770	12	PT66-HD	10791440001869	12	B141	10791440002859	12	PF225	10791440003764	12	PF314	10791440004679	12	B403
10791440000787	12	P67	10791440001876	12	BD142	10791440002873	12	PF226	10791440003771	6	PF316	10791440004686	6	B404
10791440000794	12	P68	10791440001883	12	B143	10791440002880	12	B227	10791440003856	6	BD324	10791440004693	12	JC405
10791440000817	12	PT70	10791440001890	12	P144	10791440002897	12	B228	10791440003863	12	B326	10791440004709	12	CU406
10791440000831	12	PT71	10791440001906	12	PT146	10791440002903	12	B229	10791440003887	12	B329	10791440004716	6	DF408
10791440000855	12	PT72	10791440001920	12	P148	10791440002910	12	BT230	10791440003894	12	BF330	10791440004846	12	TC413-CPES
10791440000879	12	P73	10791440001944	12	P150	10791440002927	12	PF231	10791440003900	12	PF332	10791440004860	4	V414-B
10791440000886	12	B74	10791440001951	12	PT151	10791440002934	12	B233	10791440003917	6	B333	10791440004877	4	V414-FF
10791440000893	12	B75	10791440001968	12	PT152	10791440002958	6	BT234	10791440003924	12	BT334	10791440004884	4	F415-B
10791440000909	12	B76	10791440001975	12	PT153	10791440002965	12	P235	10791440003948	12	B336	10791440004891	4	P415-10
10791440000930	12	B76-MPG	10791440001982	12	PT154	1079144000297								

I 2/5 TO BALDWIN CASE (SHIPPING CASES)

I 2/5 NUMBER	CASE QTY.	BALDWIN NUMBER	I 2/5 NUMBER	CASE QTY.	BALDWIN NUMBER	I 2/5 NUMBER	CASE QTY.	BALDWIN NUMBER	I 2/5 NUMBER	CASE QTY.	BALDWIN NUMBER	I 2/5 NUMBER	CASE QTY.	BALDWIN NUMBER
10791440005041	12	B421	10791440006109	12	BT526	10791440007366	4	PA651	10791440008592	12	BF795	10791440009674	12	PF882
10791440005058	12	S423	10791440006116	12	BT526-10	10791440007373	6	PA652	10791440008615	12	BF797	10791440009681	12	PF883
10791440005065	6	BT424	10791440006130	12	P528	10791440007427	6	PA657	10791440008622	12	BF798	10791440009688	12	BF884
10791440005072	6	BT425	10791440006147	6	P529	10791440007434	6	PA658	10791440008639	6	BF799	10791440009694	12	BF885
10791440005089	12	PT426	10791440006185	6	PT534	10791440007472	6	PA662	10791440008677	12	PF802	10791440009711	12	BF886
10791440005096	12	BT427	10791440006192	12	PT535	10791440007519	6	PA669	10791440008691	12	PF804	10791440009728	12	BF888
10791440005119	4	V429-B	10791440006208	12	BT536	10791440007526	12	PT670	10791440008707	12	BF805	10791440009742	12	BF890
10791440005126	4	V429-FF	10791440006215	6	P537	10791440007533	12	PT670-E	10791440008714	12	BF806	10791440009759	12	BF891
10791440005133	6	PT430-FF	10791440006222	12	PT538	10791440007564	6	PA675	10791440008721	12	PF807	10791440009766	12	BF892
10791440005140	12	PT431	10791440006246	12	P540	10791440007588	6	PA677	10791440008745	12	PF809	10791440009773	12	PF893
10791440005157	12	PT433	10791440006260	12	BT541	10791440007595	6	PA678	10791440008752	12	PF810	10791440009780	12	PF893-RV
10791440005164	12	PT434	10791440006284	6	PT543 KIT	10791440007601	6	PA680	10791440008769	12	PF811	10791440009797	12	PF894
10791440005171	12	PT434-10	10791440006307	12	P545	10791440007618	12	PT685-MPG	10791440008776	12	BF812	10791440009810	12	PF894-RV
10791440005188	12	PT435	10791440006314	12	PT546	10791440007625	6	PA691	10791440008790	12	PF814	10791440009827	12	BF896
10791440005195	12	PT436	10791440006321	6	PT548	10791440007632	6	PA693	10791440008813	12	PF816	10791440009844	12	SF898
10791440005201	12	PT437	10791440006338	12	PT549	10791440007663	6	PA696	10791440008820	12	PF816-S	10791440009858	12	PF899
10791440005218	12	BT438	10791440006345	6	PT550-10	10791440007670	6	PA697	10791440008844	12	PF818	10791440009865	12	BF900
10791440005225	12	PT439	10791440006376	12	PT554	10791440007687	6	PA699	10791440008851	12	PF819	10791440009896	12	PF902
10791440005232	12	BT440	10791440006383	12	P555	10791440007724	4	C704-L	10791440008868	12	PF819-HD	10791440009902	12	PF902-S
10791440005249	12	PT441	10791440006390	12	BT556-10	10791440007748	4	P706-M	10791440008875	12	PF820-S	10791440009919	12	PT903
10791440005256	12	PT442-MPG	10791440006413	6	PT558	10791440007762	12	PT707-HD	10791440008882	12	PF821-S	10791440009957	12	PF906
10791440005263	6	BT443	10791440006437	12	PT561	10791440007779	12	PT707-HD10	10791440008899	12	PF822	10791440009964	12	PF907
10791440005270	12	PT445-MPG	10791440006451	12	PT562-10	10791440007786	12	PT707-HD3	10791440008905	12	PF823	10791440009971	6	F908-A
10791440005287	12	P446	10791440006468	12	PT563	10791440007793	12	PT708-HD	10791440008950	12	PF823-E	10791440009988	12	BF909
10791440005294	12	B447	10791440006475	12	BT564	10791440007809	6	PT714	10791440008967	12	PF824	10791440009995	12	PF910
10791440005317	12	P450	10791440006482	6	PT565	10791440007816	12	PF717	10791440008981	12	BF825	10791440010021	12	BF912
10791440005324	12	S451	10791440006499	12	PT566	10791440007830	4	P718-S	10791440008988	12	PF826	10791440010038	12	PF913
10791440005331	12	BT452	10791440006505	12	PT567	10791440007847	12	BF719	10791440009001	12	PF827	10791440010045	6	BF914
10791440005355	12	P454	10791440006512	12	PT567-10	10791440007854	12	BF720	10791440009025	12	PF828	10791440010052	12	BF915
10791440005362	12	S455	10791440006529	12	PT568	10791440007861	12	PT721	10791440009032	6	PF829(2)	10791440010069	12	F916-C
10791440005379	12	S456	10791440006604	12	BF577	10791440007878	6	PT722	10791440009049	12	PF830	10791440010076	12	PF916
10791440005386	6	PT457-MPG	10791440006611	12	PT578	10791440007885	12	P723	10791440009056	12	PF831	10791440010106	12	BF918-K
10791440005393	12	PT459	10791440006628	12	PT579	10791440007892	6	PT725-MPG	10791440009070	12	BF833	10791440010144	60	F919-C
10791440005409	12	PT461	10791440006673	12	BF582	10791440007908	24	PT727-DL	10791440009087	12	BF833-K3	10791440010199	12	BF920
10791440005416	6	PT462	10791440006680	12	BF583	10791440007915	12	PT727-HD	10791440009094	12	F834-F	10791440010236	12	PF924
10791440005423	12	PT463	10791440006697	12	BF584	10791440007922	12	PT727-HD10	10791440009100	12	PF834	10791440010243	12	BF925
10791440005454	12	PT466	10791440006703	12	BF584-B	10791440007939	12	PT728-MPG	10791440009124	12	BF836	10791440010250	12	PF926
10791440005461	6	PT467-MPG	10791440006710	12	BF585	10791440007946	4	PT729	10791440009131	12	BF836-K3	10791440010274	12	BF928
10791440005478	12	PT468-MPG	10791440006727	12	BF586	10791440007977	6	BT732	10791440009148	12	BF836-K4	10791440010281	12	BF929
10791440005492	12	BT470	10791440006734	12	BF586-D	10791440007991	12	BT735	10791440009155	12	BF837	10791440010298	12	BF930
10791440005508	12	PT471	10791440006741	12	BF587	10791440008011	12	PT737	10791440009162	12	BF838-F2	10791440010328	12	BF932
10791440005515	12	BT472	10791440006758	12	BF587-D	10791440008028	12	PT737-10	10791440009179	12	PF838	10791440010335	12	BF933
10791440005522	12	B474	10791440006765	12	BF588	10791440008035	12	V738-O	10791440009186	12	BT839	10791440010359	12	PF935
10791440005539	12	PT475	10791440006871	12	BF591	10791440008042	12	BT739	10791440009193	12	BT839-10	10791440010366	12	PF936
10791440005546	12	P476	10791440006888	12	BF592	10791440008059	12	C740-S	10791440009209	12	BF840	10791440010373	12	PF937
10791440005553	12	PT477	10791440006895	12	BF593	10791440008141	4	C750-E	10791440009216	12	BF840-K1	10791440010380	12	BF938
10791440005577	12	S479	10791440006901	12	PF594	10791440008158	4	C750-L	10791440009230	12	VT842-O	10791440010397	12	BF939
10791440005584	12	PT480	10791440006918	12	BT595	10791440008172	6	PT751	10791440009247	12	BF843	10791440010403	12	BF940
10791440005591	12	PT480-10	10791440006925	6	BF596	10791440008189	6	PT752	10791440009254	12	F844-A	10791440010410	12	BF941
10791440005607	12	PT480-MPG	10791440006932	12	BF597	10791440008219	6	PT757	10791440009261	12	F845-A	10791440010427	12	PF942
10791440005614	12	B481	10791440006949	12	PF598	10791440008226	6	PT757-10	10791440009278	12	PF845	10791440010434	12	PF943
10791440005652	12	S485	10791440006956	12	PF598-10	10791440008240	12	PT760-10	10791440009285	12	PF846	10791440010458	12	PF945
10791440005669	6	BT486	10791440006963	12	PF598-30	10791440008257	12	PT760-25	10791440009292	12	PF847	10791440010465	12	PF946
10791440005676	12	PT487	10791440006970	12	PF599	10791440008264	12	PT761	10791440009315	12	PT849	10791440010472	12	PF947
10791440005690	12	B488	10791440006987	12	PF599-10	10791440008282	6	PT763	10791440009322	12	PT849-10	10791440010489	12	BF948
10791440005706	12	S489	10791440006994	12	PF599-30	10791440008295	12	PT764	10791440009353	12	V852-O	10791440010519	12	BF948-JD
10791440005751	12	PT492	10791440007007	6	PA602	10791440008301	12	PT765	10791440009360	12	BF853	10791440010533	12	F950-F
10791440005768	6	PT493	10791440007014	12	PA604	10791440008318	6	PT766	10791440009384	12	BF855	10791440010540	12	PF950
10791440005775	12	B494	10791440007021	12	B605	10791440008325	6	PT767	10791440009391	12	BF856	10791440010557	12	PT951
10791440005782	6	B495	10791440007045	6	PA607	10791440008332	6	PT768	10791440009407	12	PF857	10791440010564	12	PF952
10791440005812	12	P496	10791440007083	6	PA612	10791440008370	6	PT772	10791440009414	12	BF858	10791440010571	12	BF954
10791440005829	12	P497	10791440007090	6	PA613	10791440008387	6	PT773-MPG	10791440009421	12	PF859	10791440010588	12	BF955
10791440005836	12	PT498	10791440007106	12	BF614	10791440008400	6	BT775	10791440009438	12	PF860	10791440010595	12	BF956
10791440005843	12	PT498-10	10791440007113	6	PA615	10791440008417	12	PT776-MPG	10791440009445	12	PF861	10791440010601	12	BF957
10791440005881	4	F501-MD	10791440007151	6	PA618 FOAM	10791440008424	12	PT777	10791440009452	12	BF862	10791440010625	12	BF957-D
10791440005928	12	PF506	10791440007182	6	PA621	10791440008431	12	BT778	10791440009469	12	BF863	10791440010632	12	BF958
10791440005935	12	P507	10791440007199	6	PA625	10791440008448	12	BT779	1079144000					

I 2/5 TO BALDWIN CASE (SHIPPING CASES)

UPC NUMBER	CASE QTY.	BALDWIN NUMBER	UPC NUMBER	CASE QTY.	BALDWIN NUMBER	UPC NUMBER	CASE QTY.	BALDWIN NUMBER	UPC NUMBER	CASE QTY.	BALDWIN NUMBER	UPC NUMBER	CASE QTY.	BALDWIN NUMBER
10791440010816	12	BF978	10791440013251	6	PA1701 FOAM	10791440015903	6	PA2074	10791440017334	6	PA2226	10791440029078	12	BT8301
10791440010823	12	BF979	10791440013282	6	PA1702 FOAM	10791440015910	6	PA2075	10791440017341	6	PA2256	10791440029092	12	BT8304
10791440010830	12	BF980	10791440013312	12	PA1704	10791440015927	6	PA2076	10791440017358	6	PA2257	10791440029108	4	PT8305
10791440010847	12	PF981	10791440013374	6	PA1712	10791440015934	6	PA2077	10791440017426	4	PA2306	10791440029115	12	PT8306-10
10791440010861	12	BF984	10791440013398	6	PA1718	10791440015958	6	PA2079	10791440017440	4	PA2308	10791440029122	12	PT8306-25
10791440010878	12	PF986	10791440013404	6	PA1719	10791440015965	6	PA2081	10791440017754	6	PA2335	10791440029139	6	BT8312
10791440010885	12	PF987	10791440013411	6	PA1721	10791440015989	6	PA2083	10791440017761	6	PA2337	10791440029146	12	BT8314
10791440010892	12	BF988	10791440013442	6	PA1735	10791440015996	12	SA2084	10791440017877	6	PA2347	10791440029153	12	PT8318-MPG
10791440010908	12	BF989	10791440013466	12	PA1748	10791440016009	12	SA2085	10791440019260	6	PA2472	10791440029160	6	BT8320
10791440010922	12	BF991	10791440013534	12	PA1757	10791440016054	6	PA2091	10791440019307	6	PA2476	10791440029191	6	BT8802-MPG
10791440010939	12	BF992	10791440013541	6	PA1758	10791440016061	6	PA2092	10791440019314	6	PA2477	10791440029207	6	BT8803-MPG
10791440010953	12	BF995	10791440013558	12	PA1763	10791440016085	6	PA2094	10791440019376	6	PA2483	10791440029238	6	BT8812-MPG
10791440010960	12	P996	10791440013572	12	PA1765 FOAM	10791440016092	4	PA2095	10791440021317	6	PA2653 FOAM	10791440029297	6	BT8815
10791440010977	12	P998	10791440013756	6	PA1786	10791440016108	6	PA2096	10791440022789	12	PA2798	10791440029986	6	18104
10791440010991	12	P999-HD	10791440013831	6	PA1798	10791440016115	6	PA2099	10791440026558	6	PA4016	10791440030036	6	18155
10791440011035	12	V1009-W	10791440013848	6	PA1800	10791440016122	6	PA2100	10791440026565	6	PA4018	10791440030050	6	18171
10791440011066	12	V1044-O	10791440013862	6	PA1802	10791440016139	6	PA2101A	10791440026589	6	PA4023	10791440030074	6	18198
10791440011073	12	BF1102	10791440013886	6	PA1805	10791440016146	6	PA2102	10791440026602	6	PA4028	10791440030111	6	18236
10791440011097	12	BF1104	10791440013916	4	PA1809	10791440016153	6	PA2103	10791440026619	6	PA4031	10791440030128	6	18245
10791440011103	12	BF1105	10791440013947	6	PA1814	10791440016160	6	PA2104	10791440026657	6	PA4050	10791440030241	6	19593
10791440011141	12	BF1110	10791440014074	6	PA1828	10791440016184	6	PA2106	10791440026688	6	PA4060	10791440030340	6	19828
10791440011189	12	BF1123	10791440014104	6	PA1832	10791440016191	6	PA2107	10791440026749	12	CS5007	10791440030449	6	19992
10791440011257	12	BF1140	10791440014111	6	PA1834	10791440016214	6	PA2109	10791440026756	12	CS5008	10791440030463	6	BT8307-MPG
10791440011288	12	BF1148	10791440014165	6	PA1841	10791440016221	6	PA2110	10791440026763	6	CS5009	10791440030475	6	BT8308-MPG
10791440011295	12	BF1150	10791440014266	6	PA1852	10791440016252	6	PA2113	10791440026794	4	CSC5012	10791440030930	12	61
10791440011349	12	BF1160	10791440014296	6	PA1857	10791440016269	6	PA2114	10791440026893	6	CS5058	10791440034942	12	61-W
10791440011363	12	BF1163	10791440014302	6	PA1858	10791440016276	6	PA2115	10791440026909	10	OTK5060	10791440034980	12	66
10791440011387	12	BF1166	10791440014319	6	PA1859	10791440016283	4	PA2116	10791440026916	12	OTK5061	10791440034997	12	66-W
10791440011424	12	BF1170	10791440014326	6	PA1860	10791440016290	6	PA2117	10791440026923	12	OTK5062	10791440035574	18	101
10791440011431	12	BF1171	10791440014333	6	PA1861	10791440016320	6	PA2121	10791440026930	10	OTK5063	10791440035598	18	101-W
10791440011448	12	BF1201	10791440014418	4	PA1873	10791440016351	6	PA2124	10791440026947	12	BW5070	10791440035918	18	151
10791440011479	12	BF1210	10791440014425	4	V1874-T	10791440016368	6	PA2125	10791440026954	12	BW5071	10791440035925	18	151-30
10791440011486	12	BF1211	10791440014432	12	PA1875	10791440016382	6	PA2127	10791440026961	12	BW5072	10791440035932	18	151-W
10791440011493	12	BF1212	10791440014562	6	PA1888	10791440016450	6	PA2134	10791440026978	12	BW5073	10791440036465	8	201
10791440011509	12	BF1212 FOAM	10791440014579	6	PA1889	10791440016467	6	PA2135	10791440026985	12	BW5074	10791440036472	8	201-30
10791440011523	12	BF1213	10791440014586	6	PA1891	10791440016474	6	PA2136	10791440026992	12	BW5075	10791440036496	8	201-W
10791440011530	12	BF1214	10791440014777	12	PA1909	10791440016498	6	PA2138	10791440027005	12	BW5076	10791440036953	4	301
10791440011547	6	BF1216	10791440014814	12	PA1915	10791440016504	6	PA2139	10791440027043	12	B5134	10791440036960	4	301-30
10791440011554	12	BF1218	10791440014937	4	PA1934	10791440016511	6	PA2140	10791440027050	12	BW5136	10791440036977	4	301-CS
10791440011561	12	BF1219	10791440015019	6	PA1946	10791440016573	6	PA2147	10791440027067	12	BW5137	10791440036984	4	301-W
10791440011578	12	BF1220	10791440015026	6	PA1949	10791440016580	6	PA2148	10791440027074	12	BW5138	10791440037059	4	501
10791440011585	12	BF1221	10791440015040	6	PA1951	10791440016597	6	PA2149	10791440027081	12	BW5139	10791440037066	4	501-30
10791440011592	12	BF1223	10791440015125	6	PA1963	10791440016603	6	PA2150	10791440027098	12	BW5140	10791440037073	4	501-W
10791440011608	12	BF1225	10791440015149	6	PA1969	10791440016627	6	PA2152	10791440027104	12	BW5141	10791440037578	12	PT8344
10791440011615	12	BF1226	10791440015170	6	PA1973	10791440016634	6	PA2153	10791440027128	12	B5176	10791440037585	12	PT7053
10791440011639	12	BF1232	10791440015293	12	PA1985	10791440016641	6	PA2154	10791440027135	12	BW5172	10791440037615	12	BD7028
10791440011646	12	BF1233	10791440015422	6	PA2001	10791440016665	6	PA2156	10791440027142	12	BW5178	10791440037622	12	B7051
10791440011677	8	V1240-C	10791440015439	6	PA2002	10791440016672	6	PA2157	10791440027159	12	BW5179	10791440037639	12	PF7549
10791440011691	12	BF1259	10791440015453	6	PA2005	10791440016689	6	PA2158	10791440027180	12	BF5801	10791440037684	12	PF7550
10791440011707	12	BF1276	10791440015460	6	PA2006	10791440016696	12	SA2159	10791440027197	12	BF5800	10791440037691	12	PF7551
10791440011714	12	BF1280	10791440015477	6	PA2007	10791440016702	6	PA2160	10791440027203	12	BF5810	10791440037738	12	PT7055
10791440012032	12	B1400	10791440015484	6	PA2008	10791440016726	6	PA2162	10791440027210	12	BF5812	10791440037745	12	BF7552
10791440012056	12	B1402	10791440015491	6	PA2009	10791440016733	6	PA2163	10791440027227	12	BF5813	10791440037851	12	B7039
10791440012087	12	B1406	10791440015507	6	PA2010	10791440016740	6	PA2164	10791440027302	6	6020	10791440037882	12	BF7546
10791440012094	12	B1407	10791440015538	6	PA2023	10791440016771	6	PA2167	10791440027319	6	6021	10791440037899	12	BF1345
10791440012124	12	B1428	10791440015545	6	PA2024	10791440016788	6	PA2168	10791440028484	3	PT003	10791440037967	12	BF7544
10791440012179	4	P1510	10791440015569	12	SA2027	10791440016795	6	PA2169	10791440028491	6	B7004	10791440037981	12	BF7541
10791440012186	4	P1511	10791440015576	6	PA2031	10791440016818	6	PA2171	10791440028507	6	B7005	10791440037998	12	BF800-FP
10791440012193	4	V1520-R	10791440015606	6	PA2036	10791440016887	6	PA2178	10791440028538	12	B7009	10791440038056	12	BT305
10791440012216	6	V1542-C	10791440015613	6	PA2037	10791440016917	6	PA2181	10791440028545	12	B7010	10791440038063	12	B7047
10791440012223	16	V1544-T	10791440015637	12	SA2039	10791440016979	6	PA2189	10791440028552	6	B7011	10791440038070	12	PT8345
10791440012230	12	PA1600	10791440015644	6	PA2041	10791440016993	6	PA2191	10791440028569	12	B7014	10791440038087	12	BT8328
10791440012254	12	PA1603	10791440015651	4	PA2042	10791440017006	6	PA2192	10791440028576	12	B7018	10791440038117	12	PT7035
10791440012520	6	PA1627	10791440015668	6	PA2044	10791440017013	6	PA2193	10791440028583	6	B7019	10791440038124	12	BT372-MPG
10791440012605	6	PA1633	10791440015699	6	PA2050	10791440017020	6	PA2194	10791440028590	12	B7020	10791440038131	6	PT7000 KIT
10791440012681	6	PA1639	10791440015705	6	PA2051	10791440017044	6	PA2196	10791440028606	12	B7022	10791440038216	12	B1429
10791440012742	12	F1645-DS	10791440											

I 2/5 TO BALDWIN CASE (SHIPPING CASES)

I 2/5 NUMBER	CASE QTY.	BALDWIN NUMBER	I 2/5 NUMBER	CASE QTY.	BALDWIN NUMBER	I 2/5 NUMBER	CASE QTY.	BALDWIN NUMBER	I 2/5 NUMBER	CASE QTY.	BALDWIN NUMBER	I 2/5 NUMBER	CASE QTY.	BALDWIN NUMBER
10791440038612	6	PA2554 FOAM	10791440045214	12	B7091	10791440048772	6	BT8876-MPG	10791440050980	12	BF1249	10791440054391	6	PA3822
10791440038698	6	PA4015	10791440045245	12	BF7535	10791440048826	12	B7117	10791440051000	12	PT8392	10791440054407	6	PA3823
10791440038810	4	P7007	10791440045481	6	PA2232	10791440048888	6	PA2235	10791440051048	12	BF1252	10791440054421	12	BT8412
10791440038827	4	P7012	10791440045498	6	BT8368	10791440048895	12	BF1174	10791440051086	12	BF1217	10791440054438	6	BF7639
10791440038858	12	B7031	10791440045528	12	BF7591-D	10791440048949	12	BF7608	10791440051147	6	PA4088	10791440054469	12	BF7656
10791440038872	12	B7042	10791440045542	12	B1413	10791440048956	6	PA4042	10791440051154	6	PA4089	10791440054513	6	PA4103
10791440038889	12	BF7531	10791440045559	12	P7092	10791440048963	6	PA4043	10791440051178	12	BF1057	10791440054537	12	BF1256
10791440038896	12	BT8302	10791440045566	12	P7093	10791440049021	12	BF1177	10791440051192	12	BF1059	10791440054575	12	PF7678
10791440038902	12	BT8316-MPG	10791440045580	12	PF7592	10791440049038	12	BF1178	10791440051208	12	BF1061	10791440054582	6	PA3834
10791440038919	12	BT8323	10791440045641	12	BF1329-SP	10791440049045	12	BF1179	10791440051215	6	PA4091	10791440054599	6	PA3835
10791440038940	6	PT8330-MPG	10791440045665	12	BF1222-SP	10791440049083	12	BF1181	10791440051222	12	BD7029	10791440054605	12	PT7136
10791440038957	6	BT8333	10791440045672	12	BF1222	10791440049090	12	PA2237	10791440051307	12	B7124	10791440054612	12	PT7137
10791440038964	6	BT8850-MPG	10791440045696	6	PA2233	10791440049113	12	BF1182	10791440051338	6	18025	10791440054629	12	PT7138
10791440038988	6	BT8861	10791440045702	12	BF1329	10791440049120	12	BF1184	10791440051345	6	18024	10791440054636	6	PA4104
10791440039329	6	BT8851-MPG	10791440045719	12	P7052	10791440049137	12	BF1185	10791440051352	6	18022	10791440054643	6	PA4105
1079144004190	12	PT8350	10791440045788	12	BF1347	10791440049144	12	BF1186	10791440051376	6	18027	10791440054650	6	PA4106
10791440040240	6	B7030	10791440045801	12	BF1345-SP	10791440049212	12	BF1188	10791440051390	12	B7125	10791440054667	6	PA4107
10791440041186	12	PT8352	10791440045818	12	BF1205	10791440049229	6	PA4044	10791440051406	6	PA4092	10791440054674	12	B7139
10791440041193	12	PT8351	10791440045825	12	BF1204	10791440049236	6	PA4045	10791440051451	12	BT8393	10791440054698	12	PA3835
10791440041209	6	PT8353	10791440045832	12	BF1205-SP	10791440049243	6	PA4046	10791440051499	6	BF7623	10791440054834	6	BF7639-D
10791440041292	6	BF7571	10791440045894	12	PT8339	10791440049342	6	PA4048	10791440051505	12	SA2047	10791440054872	12	BF1261
10791440041490	12	BF1173	10791440045900	12	BF1348	10791440049380	12	BF1215	10791440051512	12	BF1253	10791440054896	6	BD1403
10791440041537	12	BF7534	10791440045917	12	BF1204-SP	10791440049403	6	PA4049	10791440051659	6	BT8848-MPG	10791440054902	12	BF7658
10791440042497	12	PT8354	10791440045924	6	BT610-MPG	10791440049410	12	BF1190	10791440051666	12	BF7624	10791440054919	12	BF7659
10791440042503	12	PT8355	10791440045931	6	BT8846	10791440049427	12	BF1191	10791440051734	6	PA4093	10791440054933	12	BF7661
10791440042527	6	BF1239	10791440045948	6	BT8852-MPG	10791440049441	12	BF1193	10791440051741	6	PA4094	10791440054957	6	PA4108
10791440042534	12	PF7572	10791440045955	6	BT611-MPG	10791440049458	12	BF1194	10791440051772	12	BF7625	10791440054964	6	PA4109
10791440042565	12	P7013	10791440046068	12	BD7095	10791440049465	12	BF1195	10791440051789	12	B1425	10791440054971	12	BF7663
10791440042626	6	BT8845	10791440046075	6	PA2234	10791440049526	12	BF1199	10791440051895	12	BF1348-SP	10791440054988	12	BF7664
10791440042633	6	BT8844	10791440046112	12	BF1223-SP	10791440049533	6	PA4081	10791440051901	12	BT8399-MPG	10791440055039	12	BF7657
10791440042640	12	PA2001 FOAM	10791440046129	12	BF7593	10791440049540	6	PA4082	10791440051970	6	BT8842-MPG	10791440055046	6	PA3836
10791440042763	12	BF7576	10791440046280	12	PF7594	10791440049564	6	PA3773	10791440052007	6	BT8843-MPG	10791440055053	12	BF7666
10791440042770	12	BF7579	10791440046297	12	PF7595	10791440049571	12	BF1045	10791440052014	6	PA4096	10791440055077	6	PA3839
10791440042787	12	BF7580	10791440046419	12	PF7596	10791440049588	12	BF1046	10791440052038	12	BF7626	10791440055084	6	PA3840
10791440042923	12	PT8329	10791440046426	6	BT8870-MPG	10791440049595	12	BF1047	10791440052045	6	PF7627	10791440055091	6	BD7141
10791440042992	6	BT8830	10791440046440	6	BT8874-MPG	10791440049601	12	BF1048	10791440052083	12	BF7128	10791440055107	6	BT8416
10791440043005	6	BT8832	10791440046464	6	BT606-MPG	10791440049618	12	BF1049	10791440052120	6	BT8401-MPG	10791440055114	12	BF7667
10791440043074	12	B1430	10791440046471	12	P7021	10791440049625	12	BF1050	10791440052199	12	PT8403-MPG	10791440055121	12	BF7142
10791440043098	12	PT8356	10791440046518	6	BT8873	10791440049687	12	BT8381	10791440052212	6	PA3419	10791440055138	6	PA4110
10791440043104	12	BW5082	10791440046532	12	PF7597	10791440049731	6	PA2240	10791440052229	12	BF7628	10791440055175	6	18032
10791440043128	12	PF7583	10791440046556	12	BF7532	10791440049748	6	PA2241	10791440052274	12	BF7629	10791440055191	6	BT8849-MPG
10791440043135	12	BF7584	10791440046563	6	BT8875-MPG	10791440049762	6	PA2243	10791440052281	12	PT8404-MPG	10791440055198	6	BT8855-MPG
10791440043142	12	P7081	10791440046624	12	P7015	10791440049779	12	PA2244	10791440052304	6	PA4099	10791440055199	6	BT8877-MPG
10791440043159	12	PT8319	10791440046723	12	P7016	10791440049878	12	BF1008	10791440052328	12	BF7631	10791440055263	6	BT8878-MPG
10791440043166	12	PT8341	10791440046730	12	P7017	10791440049885	12	BF1010	10791440052359	12	BF7632	10791440055270	6	BT8879-MPG
10791440043173	6	PT8335	10791440046914	6	BT8841-MPG	10791440050004	12	PA4084	10791440052441	6	PA4100	10791440055287	12	B7143
10791440043203	12	BT8357	10791440047027	12	B7099	10791440050102	6	BT8382	10791440052526	7	V7129-C	10791440055292	12	B1431
10791440043234	24	CTK5029	10791440047065	6	PA4075	10791440050133	12	P1418	10791440052588	12	BW5142	10791440055299	12	BT8417
10791440043272	12	B7585	10791440047072	6	PA4076	10791440050140	12	P1419	10791440052601	12	B7130	10791440055386	12	BT8415
10791440043289	12	B7082	10791440047119	12	PT8370-MPG	10791440050201	12	BF7609	10791440052618	12	BF7131	10791440055393	12	BT8413
10791440043302	12	BF7586	10791440047126	6	PT8371-MPG	10791440050263	12	BF1172	10791440052625	12	BF7645	10791440055396	12	B1432
10791440043319	12	BF7587	10791440047171	12	BF1258	10791440050294	12	B7119	10791440052663	12	BF1249-SP	10791440055419	12	PA3872
10791440043326	12	P7083	10791440047515	12	BD325	10791440050300	6	PA4085	10791440052748	12	BF7644	10791440055436	12	PA3873
10791440043333	12	PF7588	10791440047539	6	PA4077	10791440050324	12	BF1240	10791440052755	6	18029	10791440055443	12	BF7670
10791440043340	12	BF1231	10791440047553	12	P7103	10791440050331	12	BT8384	10791440052915	12	P127	10791440055459	12	BF7144
10791440043357	12	P7084	10791440047577	12	BF7598	10791440050348	6	B495-SS	10791440052946	12	F594-F	10791440055476	6	PA3880
10791440043432	6	PA4005	10791440047584	12	P7104	10791440050386	6	B96-SS	10791440053004	12	F950-F WO	10791440055483	6	PA4111
10791440043449	12	B1405	10791440047591	6	BD7105	10791440050393	12	B95-SS	10791440053011	12	F953-F	10791440055511	6	BT8418
10791440043456	6	PA2200	10791440047607	12	P7106	10791440050409	6	BD103-SS	10791440053028	12	PF997	10791440055518	6	BT8880-MPG
10791440043463	6	PA2227	10791440047614	12	P7107	10791440050416	6	B99-SS	10791440053066	12	BF7648	10791440055519	12	PT8419
10791440043487	6	PA2229	10791440047652	12	PT8372	10791440050423	12	B76-SS	10791440053073	12	PT8407	10791440055620	6	18033
10791440043494	6	PA2230	10791440047669	12	BF7602	10791440050430	12	B7600-SS	10791440053110	12	BF7633	10791440055621	6	18034
10791440043555	12	B1410	10791440047676	6	PA4078	10791440050454	12	BF7612	10791440053127	12	P7132	10791440055628	12	BF7640
10791440043623	6	PA4069	10791440047720	12	BF1100	10791440050461	12	BF7613	10791440053134	6	PA4102	10791440055635	12	BF7653
10791440043630	6	PA4070	10791440047829	12	BF7606	10791440050485	12	BF1248	10791440053196	12	BT8409	10791440055639	6	PA3890
10791440043647	6	PA4071	10791440047843	12	B7113	10791440050508	12	BF7614						

I 2/5 TO BALDWIN CASE (SHIPPING CASES)

I 2/5 NUMBER	CASE BALDWIN QTY. NUMBER	I 2/5 NUMBER	CASE BALDWIN QTY. NUMBER	I 2/5 NUMBER	CASE BALDWIN QTY. NUMBER	I 2/5 NUMBER	CASE BALDWIN QTY. NUMBER	I 2/5 NUMBER	CASE BALDWIN QTY. NUMBER
10791440057422	6.....PA4112	10791440059785	12.....BT8445	10791440061894	12.....PT8484	10791440064628	12.....B7227	10791440066462	12.....BF7746-D
10791440057439	6.....PA3901	10791440059846	6.....PA4126	10791440061924	12.....PF7735	10791440064642	12.....BC7228	10791440066479	12.....BF7745-D
10791440057484	12.....PF7655	10791440059853	12.....BF1271	10791440061948	12.....P7188	10791440064680	6.....B7229	10791440066486	12.....BF7699-D
10791440057491	12.....B7156	10791440059860	6.....PA3957	10791440061962	6.....PA4144	10791440064765	12.....PF7799	10791440066493	6.....BT8901-MPG
10791440057507	12.....BF7668	10791440059884	12.....P8448	10791440062044	12.....B7191	10791440064772	12.....BF7800	10791440066585	6.....PA4701
10791440057521	6.....BT8422-MPG	10791440059907	12.....PF7698	10791440062051	12.....PT8485	10791440064789	12.....BF7801	10791440066592	12.....BF7772
10791440057590	12.....BW5086	10791440059914	6.....BF7697	10791440062105	12.....BT8486	10791440064796	12.....BF7802	10791440066646	12.....BT8902
10791440057767	6.....B7157	10791440059921	6.....PA4127	10791440062129	12.....PT8487	10791440064802	12.....BF1285-SP	10791440066653	6.....PA4166
10791440057804	12.....BF1112	10791440059945	6.....PA3958	10791440062136	12.....BT8488	10791440064833	12.....BT8512	10791440066660	12.....BT8903
10791440057897	6.....PA4113	10791440060002	12.....BT8449	10791440062143	12.....BC7194	10791440064840	12.....PF7761	10791440066677	6.....BT8904-MPG
10791440057903	12.....BF1282	10791440060019	12.....BT8449-10	10791440062273	12.....BF7736	10791440064857	6.....P7230	10791440066691	12.....BF7773
10791440057934	6.....BT8426-MPG	10791440060033	12.....BF5815	10791440062372	12.....BT8493	10791440064888	12.....B7231	10791440066707	12.....BF7774
10791440057958	6.....BD7159	10791440060057	12.....BW5250	10791440062396	12.....P7196	10791440064925	12.....B1447	10791440066752	6.....B7299
10791440058009	6.....B7162	10791440060101	12.....BT8450	10791440062471	6.....B495-MPG	10791440064932	12.....PT8883	10791440066769	6.....PA4167
10791440058016	12.....B7163	10791440060118	6.....PA3967	10791440062518	12.....PF1291	10791440064949	12.....P7232	10791440066776	6.....B7245
10791440058023	12.....B7164	10791440060149	6.....BD7176	10791440062525	6.....PA4146	10791440064970	12.....BF7803	10791440066837	12.....B7700
10791440058030	12.....BF1330-SP	10791440060156	12.....PT8452	10791440062532	6.....PA4147	10791440064987	12.....BF7804	10791440066844	12.....PA4661
10791440058054	12.....B7165	10791440060170	6.....PA3970	10791440062549	6.....PA4148	10791440064994	12.....BF7805	10791440066851	12.....PA4662
10791440058078	6.....PA3925	10791440060217	12.....B7177	10791440062556	12.....B1446	10791440065007	12.....BF7806	10791440066868	12.....PA4663
10791440058108	6.....PA4114	10791440060286	12.....P7178	10791440062587	4.....V1560	10791440065014	12.....P7233	10791440066875	12.....PA4664
10791440058122	6.....B7161	10791440060293	12.....B7179	10791440062600	12.....P7199	10791440065021	12.....BF7807	10791440066882	6.....PA4668
10791440058146	6.....BD7166	10791440060316	6.....PA4128	10791440062631	12.....PT8489	10791440065038	12.....BF7808	10791440066899	12.....PA4669
10791440058160	6.....BT8833	10791440060323	6.....PA4129	10791440062655	12.....BF7742	10791440065052	6.....PA4157	10791440066929	12.....B5145
10791440058238	6.....BT287-3	10791440060347	4.....PT8453	10791440062785	12.....PT8496-MPG	10791440065069	12.....BF1350-SP	10791440066950	12.....BF7775
10791440058245	12.....BT8428-MPG	10791440060354	6.....PA3980	10791440062808	12.....PF7744	10791440065076	12.....BF7809	10791440066967	12.....BF7776
10791440058269	12.....B5087	10791440060378	6.....18264	10791440062853	12.....BT8497-MPG	10791440065083	12.....P7235	10791440066974	12.....BF5816
10791440058276	12.....B5088	10791440060385	6.....18265	10791440062938	12.....BT8460	10791440065090	12.....PT8884-MPG	10791440067001	12.....PF7777
10791440058283	12.....BF1265	10791440060446	6.....PA4132	10791440062952	12.....PF7751	10791440065137	12.....PF7812 KIT	10791440067018	12.....BF7778
10791440058313	12.....BT8429	10791440060453	6.....18267	10791440062990	12.....B7215	10791440065151	12.....BF7766	10791440067025	12.....BT8905
10791440058399	12.....B7685	10791440060477	12.....BF7713	10791440063003	12.....BT8499	10791440065168	12.....PT8885-MPG	10791440067032	6.....B7246
10791440058405	6.....B7175	10791440060484	6.....PA4133	10791440063058	12.....BT8501-MPG	10791440065199	6.....BT8886-MPG	10791440067087	12.....PF7779
10791440058443	12.....B7167	10791440060491	6.....PF7715	10791440063089	6.....PA4149 KIT	10791440065250	6.....PA4158	10791440067124	6.....BT8906
10791440058474	12.....B1434	10791440060514	12.....BF7717	10791440063096	12.....BT8502	10791440065311	12.....BF7813	10791440067131	6.....PA4169
10791440058504	12.....BF7686	10791440060552	6.....BT8801-MPG	10791440063102	12.....B7216	10791440065335	6.....PA4632	10791440067148	12.....BF7780
10791440058528	12.....PF7687	10791440060620	6.....PA3983-FN	10791440063119	6.....B7217	10791440065359	12.....BF7814	10791440067155	12.....PT8907-MPG
10791440058542	6.....PA3929	10791440060644	12.....PF7718	10791440063164	6.....BT8503-MPG	10791440065380	12.....B7238	10791440067162	12.....P7247
10791440058559	6.....B7180	10791440060651	12.....B1441	10791440063171	12.....BT8504	10791440065403	6.....PA4159	10791440067216	6.....B7249-MPG
10791440058566	6.....BT8432-MPG	10791440060675	12.....P1443	10791440063201	12.....BF7747	10791440065427	12.....PF7755	10791440067223	12.....BT8908
10791440058573	12.....BF7690	10791440060682	6.....BD7310	10791440063218	12.....PF7748	10791440065434	12.....BF1339-SP	10791440067230	12.....BF7815
10791440058665	6.....BD7169	10791440060712	12.....BF7711	10791440063225	12.....PF7749	10791440065441	6.....PA4160	10791440067308	6.....BT8910-MPG
10791440058726	12.....BF1266	10791440060736	12.....B7181	10791440063270	12.....BF7750	10791440065472	6.....B7239	10791440067315	6.....BT8911-MPG
10791440058733	6.....PA3931	10791440060750	6.....BT8457-MPG	10791440063287	12.....BF1283	10791440065489	6.....B10-AL BSP	10791440067360	6.....PA4681
10791440058740	12.....B1438	10791440060842	6.....B7182	10791440063294	12.....BF1281	10791440065496	12.....B7240	10791440067377	6.....20005
10791440058757	12.....B7170	10791440060859	12.....B7189	10791440063347	12.....B5089	10791440065502	12.....PT8888	10791440067384	6.....BD7250
10791440058764	12.....B7171	10791440060866	6.....PA4134	10791440063461	6.....PA4150	10791440065533	6.....PA4162	10791440067391	6.....BD7252
10791440058788	12.....BF1267	10791440060880	12.....PT8459	10791440063539	12.....PT8507-MPG	10791440065540	12.....PF7767	10791440067407	12.....PT8912
10791440058818	6.....BT8437	10791440060927	6.....PA3986	10791440063607	12.....BT8509-MPG	10791440065601	4.....PT8889	10791440067421	6.....PA4682
10791440058863	12.....BF7691	10791440061061	4.....P7183	10791440063614	12.....BT8505	10791440065670	12.....B5090	10791440067469	12.....BF1353-SPS
10791440058894	12.....BF7693	10791440061085	12.....BF7719	10791440063676	12.....BF7753	10791440065687	6.....B7241	10791440067483	6.....PF7782
10791440058917	12.....B1435	10791440061108	12.....BF7720	10791440063706	6.....PA4600	10791440065694	6.....BT8890-MPG	10791440067490	12.....BF7783-D
10791440058948	6.....BD7309	10791440061122	6.....PA4138	10791440063713	6.....PA4601	10791440065748	6.....BT8892-MPG	10791440067506	12.....BF7784-D
10791440058993	12.....P1440	10791440061139	12.....BF7721	10791440063737	12.....BF7756	10791440065762	6.....20003	10791440067513	12.....BF7785-D
10791440059020	12.....BF1268	10791440061160	12.....BF7725	10791440063768	12.....B7219	10791440065793	6.....20004	10791440067537	12.....BF7786-D
10791440059037	12.....BT8440-MPG	10791440061191	12.....SA4141	10791440063782	12.....BF1275	10791440065854	12.....66-30	10791440067544	12.....PA4852
10791440059068	6.....BT8439-MPG	10791440061238	12.....PA4551	10791440063836	12.....PF7758	10791440065861	12.....PT8893	10791440067551	12.....PA4852 FOAM
10791440059082	6.....PA4120	10791440061245	12.....PA4552	10791440063874	12.....B7220	10791440065878	12.....BF7768	10791440067568	12.....PA4853
10791440059167	6.....PA4118	10791440061269	12.....B7174-MPG	10791440063904	12.....B7221	10791440065885	6.....PA4163	10791440067575	6.....PA4854
10791440059280	6.....BF7695	10791440061375	6.....PA4555	10791440063911	12.....B7222	10791440065946	12.....PKG490-BANK	10791440067599	12.....PA4855
10791440059297	12.....BF1269	10791440061382	12.....PA4556	10791440063935	6.....PA4612	10791440066011	12.....BF1346-BSP	10791440067612	12.....PA4688
10791440059327	6.....PA4121	10791440061399	6.....PA4557	10791440063966	12.....BF7760	10791440066035	12.....BF1351-SP	10791440067629	6.....PA4688 FOAM
10791440059334	6.....BF1277-SPS	10791440061405	12.....BF7726	10791440063973	6.....PT8461	10791440066059	12.....BF1286	10791440067636	12.....PA4689
10791440059372	12.....BF1270-SP	10791440061412	12.....PT8462-MPG	10791440064024	12.....PF7759	10791440066080	6.....PA4164	10791440067643	12.....PA2068 FOAM
10791440059396	6.....PA3941	10791440061436	12.....PT8468	10791440064031	12.....B7197	10791440066141	12.....BF7769	10791440067650	12.....PA2223 FOAM
10791440059419	12.....BC7173	10791440061467	12.....PT8470	10791440064062	12.....B5144	10791440066165	12.....PF7770	10791440067667	12.....PA3901 FOAM
10791440059495	6.....PA3953	10791440061474	12.....P7185	10791440064079	12.....BF1278	10791440066226	12.....BC7242	10791440067766	12.....PA4694
10791440059501	12.....BT8443	10791440061498	12.....BT8472	10791440064086	12.....BF1279	10791440066233	12.....BT8898	10791440067773	12.....PA4695
10791440059556	6.....PA4123	10791440061504	12.....BT8473	10791440064154	12.....BF7762	10791440066240	6.....BT8899	10791440067800	12.....PA4696 FOAM
10791440059563	6.....PA4124	10791440061511	12.....BT8474	10791440064161	12.....B7223	10791440066271	12.....BF7771	10791440067803	6.....PA4698
10791440059570	6.....BT8856-MPG	10791440061528	12.....BT8475	10791440064314	6.....PA4151	10791440066295	12.....BW5182	10791440067841	6.....PA4707
10791440059617	12.....BT8444	10791440061535	6.....BT8476	10791440064437	6.....B7224	10791440066301	12.....BT8900	10791440067889	4.....PA4711
10791440059631	6.....BT8847	10791440061542	6.....BT8477	10791440064475	12.....B7225	10791440066363	12.....B7243	10791440067919	6.....PA4714
10791440059648	12.....B7172	10791440061559	6.....BT8463-MPG	10791440064482	12.....BF7765	10791440066387	12.....BF7681-D	10791440067971	12.....PA4720
10791440059655	12.....BF7683	10791440061566	6.....BT8464	10791440064499	6.....PA4152	10791440066394	12.....BF7679-D	10791440068008	2.....PA4723
10791440059662	12.....BF7696	1							

I 2/5 TO BALDWIN CASE (SHIPPING CASES)

I 2/5 NUMBER	CASE QTY.	BALDWIN NUMBER	I 2/5 NUMBER	CASE QTY.	BALDWIN NUMBER	I 2/5 NUMBER	CASE QTY.	BALDWIN NUMBER	I 2/5 NUMBER	CASE QTY.	BALDWIN NUMBER	I 2/5 NUMBER	CASE QTY.	BALDWIN NUMBER
10791440068114	6	PA4734	10791440069890	6	BT8931	10791440073385	12	PA4874	10791440076911	12	BT7316	10791440078670	6	PA4179
10791440068121	12	PA4735	10791440069937	12	BT8935	10791440073415	12	PA3957 FOAM	10791440076966	12	BD7317	10791440078687	6	PA4180
10791440068138	12	PA4736 FOAM	10791440069951	6	BT8937	10791440073422	12	PA2069 FOAM	10791440077024	6	PF7894	10791440078694	6	PA4181
10791440068145	6	PA4737	10791440070643	12	PT9127	10791440073439	12	PA2067 FOAM	10791440077031	6	PF7895	10791440078700	6	PA4182
10791440068152	6	PA4738	10791440070681	12	PT9131	10791440073545	6	BT8475-MPG	10791440077048	12	BT318	10791440078717	6	PA4183
10791440068275	6	PA4750	10791440070711	12	PT9134	10791440073552	6	BT8477-MPG	10791440077086	12	PT9319	10791440078724	6	BT9371-MPG
10791440068312	6	PA4754	10791440070728	12	PT9135	10791440073583	12	BT9321	10791440077093	12	PF7896	10791440078755	12	BF1365
10791440068329	10	PA4755	10791440070735	12	PT9136	10791440073613	6	BT9324	10791440077130	6	PA5306	10791440078816	12	BF7919
10791440068336	6	PA4756	10791440070797	12	PT9142	10791440074023	12	PT9328	10791440077154	12	BF7898-D	10791440078847	4	BA5374
10791440068350	12	PA4758	10791440070803	12	PT9143	10791440074030	12	PT9239	10791440077178	12	BT320	10791440078854	4	BA5375
10791440068374	12	PA4760	10791440070810	12	PT9144	10791440074245	12	PT9260	10791440077192	6	PA4174	10791440078861	4	BA5376
10791440068404	12	PA4763	10791440070841	12	PT9147	10791440074474	12	BF7868	10791440077321	6	BT322	10791440078878	6	PA5339
10791440068411	6	PA4764	10791440071046	12	PT9167	10791440074481	12	PF7869	10791440077338	12	PA5311	10791440078885	12	PT9374
10791440068466	12	PA4769	10791440071060	10	PT9169	10791440074498	12	BF7870	10791440077345	6	PA5312 KIT	10791440078908	12	BF7921
10791440068497	12	PA4772	10791440071114	12	PT9174	10791440074504	12	BF7871	10791440077369	6	PA5314	10791440078915	6	PA5341
10791440068503	12	PA4773	10791440071176	12	PT9180	10791440074511	12	PF7872	10791440077376	12	BF7903	10791440078939	4	PT9375
10791440068558	12	PA4777	10791440071183	12	PT9181	10791440074528	12	PF7873	10791440077383	12	BF7904-D	10791440078960	6	PT9329
10791440068565	12	PA4778	10791440071220	12	PT9185	10791440074535	12	PF7874	10791440077390	6	BT396	10791440078991	12	BF1367
10791440068633	4	PA4785	10791440071480	12	PT9211	10791440074542	12	PF7875	10791440077406	6	BT9353-MPG	10791440079004	12	BF7922
10791440068718	6	PA4793	10791440071510	12	PT9214	10791440074559	12	PF7876	10791440077413	12	BF7905-D	10791440079011	12	BF1370
10791440068923	2	PA4814	10791440071732	12	PT255	10791440074566	12	PF7877	10791440077420	12	BF7906-D	10791440079028	12	BW5183
10791440068978	12	PA4819	10791440071749	12	PT256	10791440074573	12	BF7855	10791440077437	12	BF7907	10791440079035	12	BF1371
10791440068985	12	PA4820	10791440071770	12	PT259	10791440074597	12	BF7857	10791440077468	12	PA5316	10791440079059	12	BF7923
10791440069012	6	PA4823	10791440071787	12	PT260	10791440074610	6	BF7859	10791440077475	6	PA5317	10791440079066	6	PT9330
10791440069029	12	PA4824	10791440071794	12	PT261	10791440074627	12	BF7860	10791440077482	12	PT9354-MPG	10791440079097	6	PA4184
10791440069074	6	PA4829	10791440071800	12	PT262	10791440074634	12	BF7861	10791440077499	6	PA5318	10791440079141	24	CTK5029-M
10791440069081	12	PA4830	10791440071817	12	PT263	10791440074641	12	BF7863	10791440077505	6	PA5319	10791440079158	12	BF7927
10791440069258	2	PA4848	10791440071824	12	PT264	10791440074658	12	BF7864	10791440077512	6	PA5320	10791440079189	12	PT9380-MPG
10791440069296	12	PF7787	10791440071831	12	PT265	10791440074665	12	BF7865	10791440077529	6	PA5321	10791440079196	12	BF1373-SP
10791440069302	12	PF7788	10791440071879	12	PT269	10791440074672	12	BF7866	10791440077550	12	BF7908	10791440079257	12	BF7924
10791440069319	12	PF7816	10791440071886	12	BF7880	10791440074702	12	BT298	10791440077567	12	BF7909	10791440079264	12	BF1374-SP
10791440069326	12	PF7817	10791440071893	12	BT271	10791440074733	12	PT302	10791440077581	12	PF7910	10791440079271	12	BF1375
10791440069333	24	PF7818	10791440071916	12	BT273	10791440074740	12	PT303	10791440077659	6	BT3956	10791440079295	12	BT9382
10791440069340	12	PF7819	10791440071923	12	BT274	10791440074788	12	OAS99035	10791440077673	6	BT3956	10791440079301	12	BF1376
10791440069357	12	PF7820	10791440071930	12	BT275	10791440075006	12	BT9318	10791440077697	12	PF7977	10791440079349	12	BF1372
10791440069364	12	BF7821	10791440071947	12	BT276	10791440075037	12	PT305	10791440077741	6	BD7325	10791440079356	12	BF1377
10791440069371	30	PF7822	10791440071954	12	BT277	10791440075044	12	PF7878	10791440077772	12	BF1359-SP	10791440079363	6	PA4185
10791440069388	12	PF7823	10791440071985	12	BT280	10791440075228	6	PA4957	10791440077802	6	20008	10791440079394	12	BF7925
10791440069395	30	PF7824	10791440071992	12	BT281	10791440075242	12	PT9329	10791440077819	6	20009	10791440079400	12	PA5353
10791440069401	12	PF7825	10791440072012	12	BT283	10791440075662	12	BF7879	10791440077826	6	20010	10791440079486	12	PT9386-MPG
10791440069418	12	PF7826	10791440072036	12	BT285	10791440075914	12	PF7882	10791440077833	6	20011	10791440079509	12	BF1378-SPS
10791440069425	6	PF7828	10791440072043	12	BT286	10791440075921	12	BF7881	10791440077857	6	20012	10791440079523	6	PA5359
10791440069432	12	PF7829	10791440072050	12	BT287	10791440075952	12	PA4979	10791440077864	6	PA5327	10791440079530	12	PF7928
10791440069449	12	PF7830	10791440072074	12	BT289	10791440075990	12	PA4975	10791440077871	6	PA5328	107914400795615	12	BF1379
10791440069463	12	PF7832	10791440072081	12	BT290	10791440076119	12	PT9337-MPG	10791440077970	12	BF1360	10791440079622	12	BF1380
10791440069470	12	PF7833	10791440072098	12	BT291	10791440076263	12	BT7349	10791440077987	12	BF7911	10791440079639	12	BF1381
10791440069487	12	PF7834	10791440072104	12	BT292	10791440076287	12	BF7883	10791440077994	6	PA4175	10791440079646	12	PA4187
10791440069500	12	PF7836	10791440072111	12	BT293	10791440076294	12	BT306	10791440078007	6	PA4176	10791440079653	12	BF1382-SP
10791440069517	12	BF7837	10791440072128	12	BT294	10791440076379	12	PA4985	10791440078045	12	BF1293-SPS	10791440079684	6	PT9390
10791440069524	12	BF7838	10791440072135	12	BT295	10791440076386	6	PA4986	10791440078052	12	BF1272-SPS	10791440079697	12	BT3333
10791440069531	20	BF7839	10791440072494	12	PF7852 KIT	10791440076393	6	PA4987	10791440078069	6	20013	10791440079844	12	BF7931
10791440069548	12	BF7840	10791440072500	6	PA4857	10791440076416	6	BF1355-SP	10791440078106	6	BT9362-MPG	10791440079851	6	BF7932
10791440069555	12	BF7841	10791440072531	12	BF7853	10791440076430	12	PF7886	10791440078113	6	BT9363-MPG	10791440079912	6	BT9387
10791440069562	12	BF7842	10791440072609	6	PA4170	10791440076461	12	PT308	10791440078120	6	PA4177	10791440079943	12	BT397
10791440069579	12	BF7843	10791440072630	12	PA4878	10791440076485	12	BF5587-D	10791440078137	12	BF7912	10791440079950	12	BT9388
10791440069586	12	BF7844	10791440072647	12	PA4879	10791440076539	12	BT311-MPG	10791440078151	6	BF7913	10791440080048	6	BT335-MPG
10791440069593	12	BF7845	10791440072685	12	PA4883	10791440076546	6	PT312	10791440078168	12	BF1352-SPS	10791440080055	12	BT334
10791440069616	12	BF7847	10791440072708	4	PA4885	10791440076577	12	PT313	10791440078175	12	PA5330	10791440080062	6	BT9391-MPG
10791440069623	12	BF7848	10791440072715	12	PA4886	10791440076584	12	PT9342-MPG	10791440078182	12	BF1361	10791440080109	12	PT9336 KIT
10791440069630	12	BF7849	10791440072739	6	PA4888	10791440076607	12	PF7889	10791440078397	6	BT9364	10791440080116	6	BT9392-MPG
10791440069647	12	BF7850	10791440072753	6	PA4890	10791440076614	12	PF7889-10	10791440078410	12	BF7915	10791440080123	6	BT9393-MPG
10791440069654	12	BF7851	10791440072760	12	PA4891	10791440076621	12	PF7889-30	10791440078427	6	BT9365-MPG	10791440080130	12	PF7934 KIT
10791440069661	12	BF7736-K1	10791440072807	12	PA4895	10791440076638	12	PF7890	10791440078434	6	BT9366-MPG	10791440080215	12	PF7935
10791440069678	12	BT8913-MPG	10791440072869	12	PA4902	10791440076645	12	PF7890-10	10791440078441	6	PA5333	10791440080222	6	PA5393
10791440069685	6	BT8476-MPG	10791440072890	12	PA4905	10791440076652	12	PF7890-30	10791440078458	6	BT9367-MPG	10791440080246	12	BF1384-SP
10791440069692	12	BT366-MPG	1079											

I 2/5 TO BALDWIN CASE (SHIPPING CASES)

I 2/5 NUMBER	CASE QTY.	BALDWIN NUMBER	I 2/5 NUMBER	CASE QTY.	BALDWIN NUMBER	I 2/5 NUMBER	CASE QTY.	BALDWIN NUMBER	I 2/5 NUMBER	CASE QTY.	BALDWIN NUMBER	I 2/5 NUMBER	CASE QTY.	BALDWIN NUMBER
10791440080437	6	PA4195 KIT	10791440081755	12	BF7952-D	10791440082752	12	BF7965	10791440085692	12	BF7976	10791440087238	6	PA4431
10791440080444	6	PA4196	10791440081779	12	BF7954-D	10791440082769	6	PA4391	10791440085708	6	BD7353	10791440087269	12	BF1345-O
10791440080451	6	PA4197	10791440081786	12	BF7419	10791440082783	6	PA4392	10791440085715	4	BA5378	10791440087313	12	BF7373
10791440080468	6	PA4198	10791440081793	6	PA4338	10791440082790	6	PA4393	10791440085722	4	BA5379	10791440087320	12	BF9807
10791440080475	6	PA4199	10791440081809	6	PA4340	10791440082813	12	B7440	10791440085760	12	PF7978	10791440087337	12	BF9808-D
10791440080482	6	PA4303	10791440081816	6	PA4341	10791440082820	12	BF7966	10791440085784	12	PA5457	10791440087351	12	BF1223-O
10791440080499	6	PA4304	10791440081823	6	PA4344	10791440082837	12	B5091	10791440085791	6	BD7355	10791440087368	12	BF9809-D
10791440080505	6	PA4305	10791440081830	6	PA4345	10791440082851	12	B7441	10791440085814	6	BT9558-MPG	10791440087375	12	BF9810-D
10791440080512	6	PA4306	10791440081847	6	PA4348	10791440082868	6	PA4394	10791440085845	12	B7356	10791440087382	12	B7375
10791440080529	6	PA4307	10791440081854	6	PA4349	10791440082875	6	PA5428	10791440085852	12	BF1366-O	10791440087399	12	B7376
10791440080536	6	PA4308	10791440081861	6	PA4350	10791440082882	6	PA4395	10791440085869	12	BF7970	10791440087405	12	B7377
10791440080543	6	PA4309	10791440081878	6	PA4351	10791440082912	12	BF7967	10791440085876	12	BF7979	10791440087412	12	BF9811-SP
10791440080550	12	SA4315	10791440081885	6	PA4352	10791440082929	12	BF1393-SP	10791440085883	12	B7357	10791440087429	12	B7378
10791440080567	6	PA4310	10791440081908	12	BF7955	10791440082981	6	PA4397	10791440085890	12	BF1329-O	10791440087436	12	BF1290-O
10791440080574	6	PA4311	10791440081915	12	B7420	10791440082998	6	PA4398	10791440085913	12	B7359	10791440087443	12	BF1292-O
10791440080581	6	PA4312	10791440081922	12	B7422	10791440083001	6	PA4399	10791440085982	6	PA4422	10791440087450	12	BF1294-O
10791440080598	6	PA4313	10791440081939	12	BF7956-D	10791440083018	6	PA4400	10791440085999	6	PA4423	10791440087474	12	PT9430-MPG
10791440080604	6	PA4314	10791440081946	12	P7423	10791440083025	12	P7442	10791440086002	12	BF7981	10791440087481	12	B7379
10791440080611	6	B7402	10791440081984	12	P7417	10791440083049	12	BF1394-SP	10791440086064	6	BT9560-MPG	10791440087504	12	BF9812
10791440080628	12	B7403	10791440081991	6	PA4353	10791440083087	12	BF1395-SP	10791440086071	12	PF7983	10791440087511	12	BF9813
10791440080635	6	PF7938	10791440082011	6	PA4355	10791440083094	6	PA4401	10791440086088	12	PF7984	10791440087528	12	PF9814
10791440080642	12	BF1354-SPS	10791440082028	6	PA4356	10791440083100	6	PA4402	10791440086101	12	BF7985	10791440087535	12	B7383
10791440080659	6	PA4316	10791440082035	6	PA4357	10791440083131	6	PA4403	10791440086132	12	B7360	10791440087542	12	B7384
10791440080666	6	PA4317	10791440082042	6	PA4358	10791440083148	6	PA4404	10791440086156	12	BF7637	10791440087559	12	B7385
10791440080727	12	PT9394-MPG	10791440082059	6	PA4359	10791440083155	6	PA4405	10791440086187	12	B7361	10791440087566	12	B7386
10791440080734	6	P7405	10791440082066	6	PA4360	10791440083193	12	PT9412-MPG	10791440086194	12	BT9561	10791440087573	12	B7387
10791440080758	6	PA4319	10791440082073	6	PA4361	10791440083209	12	B7443	10791440086200	12	PF7986	10791440087580	12	BF9815
10791440080765	6	PT9395-MPG	10791440082080	6	PA4362	10791440083216	12	B7444	10791440086217	12	PF7982	10791440087597	12	BF1295-O
10791440080772	6	PA4320	10791440082097	12	B7424	10791440083223	12	BF1396	10791440086231	12	B7362	10791440087603	12	BF9816
10791440080826	12	PT9396	10791440082103	12	P7426	10791440083230	12	B7445	10791440086248	12	BF7987	10791440087610	12	BF1296-O
10791440080840	12	BF1355-SPS	10791440082110	12	P7427	10791440083247	6	PA4409	10791440086262	12	BF7988	10791440087627	12	BF1297-O
10791440080857	12	PF7939	10791440082127	6	BT9400-MPG	10791440083254	12	BF7968	10791440086286	12	BF7989-D	10791440087634	12	BF9817
10791440080864	12	BF7940	10791440082141	12	BT9402	10791440083261	12	B7446	10791440086378	6	B7363	10791440087641	12	BF9818
10791440080871	12	BF7941	10791440082165	12	B7428	10791440083278	12	PT9413-MPG	10791440086385	12	B7364	10791440087658	12	BF9819
10791440080888	6	PA4321	10791440082189	12	BF7957	10791440083285	12	BF1398-O	10791440086392	12	BF1287-O	10791440087665	12	BF9820
10791440080895	6	PA4322	10791440082202	12	BF1390-O	10791440083308	12	P7450	10791440086408	12	BF1288-O	10791440087672	6	PA4433
10791440080901	12	BF7942	10791440082219	6	PA4363	10791440083315	12	B7451	10791440086415	6	PA4425	10791440087689	12	BF9821
10791440080918	12	P7406	10791440082226	6	PA4364	10791440083322	12	BF1360-SP	10791440086422	6	PA4426	10791440087702	12	BF9822-D
10791440081045	6	PA4323	10791440082233	6	PA4365	10791440083339	12	BF7949-DM	10791440086439	12	BF7990	10791440087719	12	PF9823
10791440081052	12	B7407	10791440082257	12	BF1391-O	10791440083346	12	BF7971-D	10791440086446	6	PA5482	10791440087726	12	PF7380
10791440081069	6	PA4324	10791440082264	6	PA4366	10791440083353	12	BF7971-DM	10791440086453	12	P7365	10791440087733	12	PF9824
10791440081083	6	PA4327	10791440082271	12	B7430	10791440083360	12	B7452	10791440086484	12	BF7993	10791440087740	12	PF9825
10791440081106	6	PA4325	10791440082288	12	B7429	10791440083483	12	B7453	10791440086552	12	B7367	10791440087757	12	PF9826
10791440081151	12	BF7943	10791440082295	12	PT9405	10791440083513	6	PA4410 KIT	10791440086569	12	PF1392	10791440087764	6	P7381
10791440081182	12	P7408	10791440082301	12	B7431	10791440083537	12	OP8750	10791440086590	6	PA4427	10791440087924	12	BF9827-D
10791440081199	12	B7409	10791440082318	12	B7432	10791440083544	12	OP8751	10791440086606	12	PF7994	10791440087962	6	PA4434
10791440081205	12	B7410	10791440082325	12	B7433	10791440083551	12	OP8752	10791440086613	12	BF7995	10791440087979	6	BF9433
10791440081212	6	PA4329	10791440082332	6	PA4367	10791440083568	12	OP8753	10791440086620	12	P7368	10791440087986	12	BF9828-D
10791440081229	12	P7411	10791440082349	6	PA4368	10791440083575	6	PA4411	10791440086675	6	BF7996	10791440088099	12	PT9434
10791440081250	12	BF1366-O	10791440082363	6	PA4370	10791440083582	12	P7454	10791440086682	6	PA4428	10791440088105	6	PA4435
10791440081267	12	BF7944	10791440082370	6	PA4371	10791440083599	6	PA4412	10791440086699	6	BT9421-MPG	10791440088143	12	B7388
10791440081274	12	P7413	10791440082387	6	PA4372	10791440083605	6	PA4413	10791440086705	6	20021	10791440088167	6	PA4436
10791440081281	12	P7414	10791440082394	6	PA4373	10791440083612	6	PA4414	10791440086729	6	20023	10791440088174	6	PA4437
10791440081342	12	BF1387-O	10791440082400	12	BF7958	10791440083667	12	P7455	10791440086781	12	BF7997	10791440088181	12	PT9435-MPG
10791440081359	12	BF1388-O	10791440082417	12	BF7959	10791440083674	6	PA4416 KIT	10791440086798	6	PA5494	10791440088198	12	BF9830-D
10791440081366	12	P7415	10791440082424	12	BF7960	10791440083681	12	BF7969	10791440086804	6	PA5495	10791440088204	12	B7389
10791440081373	6	PA4330	10791440082431	12	BF7961	10791440083698	12	PT9414-MPG	10791440086811	6	BT9422	10791440088211	12	BF9831
10791440081380	6	PA4331	10791440082448	12	B7434	10791440083759	12	BF7972	10791440086828	12	BF7998	10791440088228	12	BF9832
10791440081397	6	PA4332	10791440082455	6	PA4374	10791440083766	12	P7438	10791440086859	12	BF1289-SP	10791440088235	12	B7390
10791440081403	12	BF7945	10791440082479	6	PA4375	10791440083773	6	PA4417	10791440086866	12	B7369	10791440088242	12	B7392
10791440081410	6	B7416	10791440082486	6	PA4376	10791440083834	12	BC7456 KIT	10791440086880	12	PT9423	10791440088259	12	B7393
10791440081489	6	BT9398-MPG	10791440082493	6	PA4377	10791440083865	6	PA4418	10791440086927	12	B7430	10791440088266	12	BF9833-D
10791440081496	6	PF7946	10791440082509	6	PA4380	10791440083872	6	PA4419	10791440086934	12	P7371	10791440088273	12	BF9834
10791440081502	6	PA4334	10791440082516	6	PA4381	10791440083940	12	PT9417	10791440086965	12	PT9424	10791440088280	12	BF9835-D
10791440081519	6	PA4335	10791440082523	6	PA4382	10791440083957	12	B7449	10791440086996	12	BF9800	10791440088297	6	P7505
10791440081564	12	BF1389-O	10791440082530	6	PA4383	10791440083971	12	PT9418	10791440087009	12				

I 2/5 TO BALDWIN CASE (SHIPPING CASES)

I 2/5 NUMBER	CASE QTY.	BALDWIN NUMBER	I 2/5 NUMBER	CASE QTY.	BALDWIN NUMBER	I 2/5 NUMBER	CASE QTY.	BALDWIN NUMBER	I 2/5 NUMBER	CASE QTY.	BALDWIN NUMBER	I 2/5 NUMBER	CASE QTY.	BALDWIN NUMBER
10791440088587	12	PF9838	10791440090245	6	PA5623	10791440092096	12	BF9893	10791440093826	12	P7515	10791440097497	12	BF46006
10791440088624	12	BF9839-D	10791440090252	6	PA5624	10791440092012	12	BF9894	10791440093833	6	PA5768	10791440097503	12	BF46007
10791440088655	6	B10-AL BSPCS	10791440090269	6	BF9864	10791440092188	6	PA5689	10791440094380	6	PT9532	10791440097510	12	BF46008
10791440088662	4	BA5566	10791440090283	12	PF9865	10791440092195	6	PA5690	10791440094397	6	PA4481	10791440097527	12	PF46009
10791440088679	12	BF1298-O	10791440090306	6	PA4464	10791440092201	6	PA5691	10791440094434	12	P7517	10791440097558	12	BF46012
10791440088686	12	B7466	10791440090337	6	PA5629	10791440092232	6	PA5694	10791440094441	12	P9600	10791440097565	12	BF46013
10791440088693	12	BF9840	10791440090351	6	PA5631	10791440092270	6	BD7504	10791440094458	6	PA5770	10791440097572	12	BF46014
10791440088709	12	B7467	10791440090375	6	BT9440	10791440092287	12	B7506	10791440094472	6	PA5772	10791440097589	12	BF46015
10791440088716	12	B7468	10791440090382	12	BF9866-O	10791440092294	6	PA4470	10791440094489	6	PA5773	10791440097596	12	BF5813-O
10791440088723	12	B7469	10791440090399	6	PA5632	10791440092300	6	BF9895 KIT	10791440094496	12	PF9919	10791440097602	12	BF1204-O
10791440088730	12	BF9841	10791440090429	6	PA4465	10791440092317	6	PA4471	10791440094502	6	PA5774	10791440097619	12	BF791-O
10791440088747	12	B7470	10791440090443	12	BF9867-O	10791440092324	6	PA5698	10791440094526	12	BF1282-O	10791440097626	12	BF7968-O
10791440088808	12	BF9842	10791440090467	12	BF1355-O	10791440092348	6	PF9896 KIT	10791440094536	6	PA4483	10791440097633	12	BF46016
10791440088815	12	B7472	10791440090474	6	PA5633	10791440092355	12	PF9897	10791440094564	12	B9601	10791440097640	12	BF46017-O
10791440088822	12	B7473	10791440090504	12	PF9868	10791440092379	12	BF9898-O	10791440094601	6	BF9920	10791440097657	12	BF46018-O
10791440088839	12	B7474	10791440090528	12	BF1395-O	10791440092386	12	PF9899	10791440094663	6	PA4484	10791440097664	12	BF46019-O
10791440088846	12	B7475	10791440090535	12	B7496	10791440092393	12	PF9900	10791440094694	12	BF9921-O	10791440097671	12	BF46020-O
10791440088853	12	B7476	10791440090641	12	BF9869	10791440092409	6	B7507	10791440094700	6	PA4485	10791440097688	12	BF46021-O
10791440088860	12	B7477	10791440090665	6	PT9441-MPG	10791440092416	12	BC7394	10791440094755	12	BF9922-O	10791440097695	12	BF46022-O
10791440088877	12	B7478	10791440090689	12	PF9870	10791440092423	12	PA5700	10791440094922	12	PE5272	10791440097701	12	BF46023-O
10791440088884	12	BF9843	10791440090696	6	PA5637	10791440092430	12	PF9901 KIT	10791440094953	12	BF9923-O	10791440097718	12	BF46024-O
10791440088907	12	BF9844	10791440090702	6	PA5638	10791440092447	6	PA4473	10791440094991	12	PA5276	10791440097725	12	BF46025-O
10791440088914	12	B7481	10791440090795	12	BF9871-O	10791440092515	12	PF9902	10791440095004	12	P9602	10791440097732	12	BF46026-O
10791440088921	12	B7482	10791440090955	12	PF9872	10791440092522	12	BF9903-BP	10791440095011	12	P9603	10791440097749	12	BF46027-O
10791440088938	12	B7483	10791440090962	12	B7497	10791440092546	12	BF9904	10791440095028	12	PT9537-MPG	10791440097756	12	BF46028-O
10791440088950	12	P7484	10791440090993	12	PF9873	10791440092577	12	BF9904	10791440095080	6	PA5282	10791440097763	12	BF46029-O
10791440089003	12	PF9845	10791440091013	6	PA4466	10791440092584	6	PT9508	10791440095103	4	BA5284	10791440097770	12	BF46030-O
10791440089058	12	BC7485	10791440091020	12	BT9442-MPG	10791440092669	12	PF9469	10791440095110	6	PA4486	10791440097787	12	PT23136
10791440089096	12	BF9846	10791440091037	12	BF9874-DM	10791440092683	6	BD7509	10791440095127	12	BF1278-O	10791440097800	12	PT23122
10791440089102	12	BF9847-D	10791440091044	12	BF9875-DM	10791440092737	6	PA5714	10791440095134	6	PA4487	10791440097817	12	PT23123
10791440089119	12	BF1299-O	10791440091068	6	PT9444-MPG	10791440092744	12	BF9905	10791440095172	6	PF9924 KIT	10791440097824	6	PT23137
10791440089133	6	BT9436-MPG	10791440091075	12	BF9876	10791440092805	12	BT9471	10791440095196	12	BF9925-O	10791440097831	12	PT23124
10791440089140	12	B7486	10791440091167	12	PT9446	10791440092812	6	PA5720	10791440095240	12	BF9926-O	10791440097848	12	PT23125-MPG
10791440089157	12	B7487	10791440091174	12	PT9447	10791440092829	6	PA5721	10791440095271	12	BF9927	10791440097855	12	PT23126-MPG
10791440089164	6	PA4439	10791440091181	12	PT9448	10791440092836	6	PA5722	10791440095506	12	B9604	10791440097862	12	BF46031-O
10791440089171	6	PA4440 KIT	10791440091198	12	PT9449	10791440092843	6	PA5723	10791440095657	12	P9605	10791440097879	12	PT23128-MPG
10791440089188	6	PA4441	10791440091204	12	PT9450-MPG	10791440092850	12	PA4475	10791440095612	12	B9606	10791440097886	12	PT23129-MPG
10791440089195	12	BF9848	10791440091259	6	PA4467	10791440092867	6	PA5724	10791440095629	12	B9607	10791440097916	12	PT23132-MPG
10791440089201	12	P7488	10791440091310	12	BF1358-O	10791440092874	6	PA5724 FOAM	10791440095636	12	PF9928	10791440097954	12	P40002
10791440089218	12	P7489	10791440091389	12	BF9877	10791440092881	6	PA5725	10791440095643	12	PF9929	10791440097961	12	B40006
10791440089225	12	BF9849	10791440091419	6	PA5658	10791440092898	12	BF9906	10791440095644	6	PA10000	10791440097968	12	CA0005
10791440089232	12	BF9850	10791440091433	6	PA5660	10791440092911	6	PA5727	10791440095681	6	PA10001	10791440097992	6	PA10008
10791440089294	6	PA4442	10791440091440	6	PA5661	10791440092928	6	PA5728	10791440095698	12	PA10002	10791440098029	12	BC40007
10791440089300	6	PA4443	10791440091457	6	PA5662	10791440092935	6	PA5728 FOAM	10791440095704	12	BF46000	10791440098050	12	BF46031
10791440089317	6	PA4444	10791440091495	6	PA5666	10791440092959	6	PA5729	10791440095671	12	BF46001	10791440098074	6	P40008
10791440089324	12	BF9851	10791440091525	6	PA4468	10791440092980	6	PA5732	10791440095678	12	B40000	10791440098081	6	BC40009
10791440089331	12	P7490	10791440091532	6	PA4469	10791440092997	12	PF9907	10791440095735	12	PA0001	10791440098098	12	PA0010
10791440089348	12	B7491	10791440091549	12	P5092	10791440093154	6	PA5733	10791440095803	6	PA30007	10791440098104	12	BF46032
10791440089355	12	BF9852	10791440091556	12	BF9878	10791440093208	12	BF9910	10791440095810	12	PA10003	10791440098173	6	PA30072
10791440089362	12	BF9853	10791440091563	6	PA5669	10791440093239	12	P7510	10791440095841	12	PF46003	10791440098203	12	PF46033
10791440089379	12	BF9854	10791440091686	12	B7499	10791440093246	12	PF9911	10791440095858	12	PF46004	10791440098234	12	P40011
10791440089423	6	PA4446	10791440091709	12	BT9456	10791440093260	12	B7511	10791440095865	12	PA10004	10791440098241	12	PA0012
10791440089430	6	PA4447	10791440091747	6	PA5679	10791440093277	6	PA5737 KIT	10791440095886	12	BF46005	10791440098298	12	BF45000
10791440089447	6	PA4448	10791440091754	6	PF9879	10791440093284	6	PT9473	10791440095902	6	PA10006	10791440098326	12	P40014
10791440089485	12	BF9857	10791440091761	12	BF9880	10791440093291	12	PA5738	10791440095919	12	P40003	10791440098343	6	PA10011
10791440089713	6	BF9839	10791440091808	12	BF9881	10791440093420	12	BF1249-O	10791440095926	6	PA10007	10791440098375	12	BF46034
10791440089751	6	PA4449	10791440091815	12	BF9882	10791440093444	12	PT9474	10791440095957	6	PA30011	10791440100586	6	PA10013
10791440089768	6	PA5580	10791440091822	12	PT9462	10791440093468	12	S9475	10791440095960	12	OAS9800	10791440100593	6	PA30080
10791440089850	12	CV15001	10791440091846	12	BT9464	10791440093475	12	BF9912-O	10791440095964	6	PA30012	10791440100616	6	PA10014
10791440089867	12	P7492	10791440091853	12	PT9463	10791440093482	6	PT9476-MPG	10791440095988	12	PA30014	10791440100760	12	BT40015
10791440089904	6	PA4452	10791440091860	12	BF9883	10791440093499	12	BF1281-O	10791440097008	12	PA30016	10791440100777	6	PA30086
10791440089911	6	PA4453	10791440091884	12	B7503	10791440093505	12	BF9913	10791440097015	12	PA30017	10791440100784	6	PA10015
10791440089942	6	PA4454	10791440091891	12	PE5270	10791440093512	12	BF1283-O	10791440097022	12	PA30018	10791440100845	6	20025
10791440089959	12	P7493	10791440091907	12	PE5271	10791440093529	6	PA5753	10791440097060	12	PA30022	10791440100883	6	PA30093
10791440089966	6	PA4455	10791440091914	12	BT9465	10791440093567	12	CV15003	10791440097084	12	PA30024	10791440100890	6	PA10016
1079144														

BALDWIN WEIGHTS AND VOLUMES

BALDWIN NUMBER	CASE QTY.	WEIGHT (ea.) lbs.	WEIGHT (ea.) kgs.	Volume (ea.) ft ³	Volume (ea.) m ³	BALDWIN NUMBER	CASE QTY.	WEIGHT (ea.) lbs.	WEIGHT (ea.) kgs.	Volume (ea.) ft ³	Volume (ea.) m ³	BALDWIN NUMBER	CASE QTY.	WEIGHT (ea.) lbs.	WEIGHT (ea.) kgs.	Volume (ea.) ft ³	Volume (ea.) m ³
B2	12	1.213	0.550	0.061	0.002	P82	12	0.725	0.329	0.079	0.002	P140	12	0.317	0.144	0.033	0.001
B2-HPG	12	1.162	0.527	0.050	0.001	PT82-HD	12	0.950	0.431	0.105	0.003	B141	12	1.046	0.474	0.050	0.001
B4	12	0.954	0.433	0.044	0.001	PT82-HD10	12	0.958	0.435	0.108	0.003	BD142	12	2.100	0.953	0.070	0.002
BT5	12	1.304	0.591	0.049	0.001	PT83	6	2.383	1.081	0.279	0.008	B143	12	0.760	0.345	0.040	0.001
B6	12	1.221	0.554	0.061	0.002	PT83-MPG	6	3.200	1.452	0.273	0.008	P144	12	0.337	0.153	0.040	0.001
B6-HPG	12	1.108	0.503	0.052	0.001	P84-2	12	0.558	0.253	0.040	0.001	PT146	12	1.304	0.591	0.189	0.005
B7	12	1.600	0.726	0.082	0.002	PT85	12	0.763	0.346	0.079	0.002	P148	12	0.279	0.127	0.033	0.001
B9	12	1.142	0.518	0.061	0.002	PT86-HD	12	1.204	0.546	0.189	0.005	P150	12	0.475	0.215	0.046	0.001
B10-AL	6	2.525	1.145	0.154	0.004	PT87-S	12	1.146	0.520	0.088	0.002	PT151	12	0.612	0.278	0.051	0.001
B10-AL BOWL	6	0.658	0.298	0.144	0.004	PT88-HD	12	1.283	0.582	0.190	0.005	PT152	12	1.088	0.494	0.106	0.003
B10-AL BSP	6	2.483	1.126	0.156	0.004	PT89	12	1.175	0.533	0.129	0.004	PT153	12	0.779	0.353	0.080	0.002
B10-AL BSPCS	6	2.530	1.148	0.160	0.005	PT90-10	12	1.700	0.771	0.186	0.005	PT154	12	0.971	0.440	0.105	0.003
B10-AL CAP	6	1.625	0.737	0.043	0.001	PT90-MPG	12	2.175	0.987	0.187	0.005	PF155	12	1.142	0.518	0.134	0.004
PF10	12	0.392	0.178	0.037	0.001	PT91	12	1.838	0.834	0.130	0.004	B156	12	0.963	0.437	0.045	0.001
PF10-CS	12	0.408	0.185	0.037	0.001	PT93	12	0.958	0.435	0.099	0.003	B157	12	1.779	0.807	0.087	0.002
PT11	12	0.917	0.416	0.089	0.003	PT93-MPG	12	1.192	0.541	0.109	0.003	B159	12	0.708	0.321	0.037	0.001
PT11-HD	12	1.079	0.489	0.090	0.003	B95	6	2.792	1.266	0.142	0.004	B160	12	0.658	0.298	0.032	0.001
PT12	12	0.575	0.261	0.061	0.002	B95-MPG	6	3.008	1.364	0.143	0.004	B161-S	12	0.700	0.318	0.032	0.001
BF13	12	0.950	0.431	0.043	0.001	B95-SS	6	2.767	1.255	0.143	0.004	P162	12	0.529	0.240	0.063	0.002
P15	12	0.492	0.223	0.051	0.001	B96	6	2.942	1.334	0.163	0.005	B163	12	1.042	0.473	0.051	0.001
S16-1	12	0.563	0.255	0.063	0.002	B96-MPG	6	3.317	1.505	0.163	0.005	B164	12	1.400	0.635	0.062	0.002
P18	12	0.571	0.259	0.065	0.002	B96-SS	6	2.992	1.357	0.160	0.005	B166	12	1.021	0.463	0.049	0.001
P18-HD	12	0.717	0.325	0.065	0.002	B97	6	2.658	1.206	0.148	0.004	B167	12	1.279	0.580	0.068	0.002
P19	12	0.783	0.355	0.081	0.002	PT98-10	6	3.083	1.398	0.327	0.009	B168	12	0.796	0.361	0.047	0.001
P20-HD	12	1.188	0.539	0.133	0.004	PT98-MPG	6	3.567	1.618	0.328	0.009	P170	12	0.438	0.199	0.049	0.001
V24-A2	12	2.129	0.966	0.304	0.009	B99	6	4.183	1.897	0.236	0.007	P171	12	0.396	0.180	0.032	0.001
P25	12	0.754	0.342	0.080	0.002	B99-B	6	4.492	2.038	0.269	0.008	PT172	12	0.392	0.178	0.034	0.001
P26	12	0.808	0.367	0.078	0.002	B99-MPG	6	4.542	2.060	0.225	0.006	B173-S	12	0.954	0.433	0.052	0.001
B27	12	1.092	0.495	0.051	0.001	B99-SS	6	4.333	1.965	0.225	0.006	P174	12	0.458	0.208	0.048	0.001
BD28	12	1.304	0.591	0.057	0.002	P102	12	1.167	0.529	0.100	0.003	PT176	12	0.321	0.146	0.034	0.001
PT29	12	0.425	0.193	0.048	0.001	BD103	6	3.533	1.603	0.165	0.005	PT177	12	0.442	0.200	0.047	0.001
AFG30	1	0.300	0.136	0.020	0.001	BD103-MPG	6	3.667	1.663	0.164	0.005	B178	12	0.725	0.329	0.036	0.001
B30	12	0.754	0.342	0.037	0.001	BD103-SS	6	3.558	1.614	0.168	0.005	B179	12	0.621	0.282	0.028	0.001
B31	12	0.642	0.291	0.031	0.001	P104	12	0.675	0.306	0.065	0.002	PT181 KIT	1	1.750	0.794	0.239	0.007
B33	12	0.529	0.240	0.028	0.001	B105	6	2.092	0.949	0.094	0.003	P183	12	0.267	0.121	0.040	0.001
B34	12	1.046	0.474	0.049	0.001	P106	12	0.150	0.068	0.016	**	P184	12	0.617	0.280	0.055	0.002
B35-S	12	0.717	0.325	0.035	0.001	P106-HD	12	0.250	0.113	0.016	**	PT185	12	0.658	0.298	0.097	0.003
AFG37R	6	0.450	0.204	0.040	0.001	PT108	12	0.383	0.174	0.038	0.001	P186	12	0.358	0.162	0.041	0.001
B37	12	0.563	0.255	0.032	0.001	PT108-HD	12	0.475	0.215	0.037	0.001	P187	12	0.296	0.134	0.032	0.001
AFG38D	6	0.208	0.094	0.030	0.001	B109	12	1.271	0.577	0.060	0.002	PT189	12	1.192	0.541	0.099	0.003
B39	12	1.033	0.469	0.049	0.001	BC110	12	0.883	0.401	0.062	0.002	PT189-MPG	12	1.275	0.578	0.114	0.003
P40	12	0.658	0.298	0.051	0.001	BT111	12	1.167	0.529	0.061	0.002	P190	12	0.463	0.210	0.050	0.001
P41	12	0.817	0.371	0.080	0.002	BT112	12	1.175	0.533	0.061	0.002	PT191	1	1.750	0.794	0.211	0.006
P42	12	1.033	0.469	0.137	0.004	B113	12	0.712	0.323	0.036	0.001	PT191-10	6	2.117	0.960	0.255	0.007
B43-S	12	0.625	0.284	0.028	0.001	B114	12	1.208	0.548	0.061	0.002	PT191-5	1	1.800	0.816	0.208	0.006
B45	12	2.250	1.021	0.107	0.003	PT115	12	1.125	0.510	0.134	0.004	PT193	1	2.150	0.975	0.204	0.006
P47	12	0.904	0.410	0.079	0.002	P116	1	2.600	1.179	0.233	0.007	PT193 KIT	1	2.400	1.089	0.296	0.008
PT48	12	0.438	0.199	0.034	0.001	PF116	6	2.333	1.058	0.279	0.008	PT193-3	1	2.250	1.021	0.216	0.006
B49	6	2.825	1.281	0.161	0.005	PT117	6	3.267	1.482	0.458	0.013	P194	6	2.025	0.919	0.258	0.007
B50	12	1.167	0.529	0.052	0.001	PT117-25	6	3.325	1.508	0.465	0.013	P194-HD	6	2.292	1.040	0.255	0.007
P52	12	1.121	0.508	0.132	0.004	B118	12	1.196	0.543	0.061	0.002	P194-HD10	6	2.375	1.077	0.255	0.007
P53	12	0.837	0.380	0.081	0.002	PT119	1	2.950	1.338	0.395	0.011	PF194	6	2.100	0.953	0.258	0.007
P54	12	0.987	0.448	0.079	0.002	PT119-5	1	2.950	1.338	0.407	0.012	B195	12	0.650	0.295	0.027	0.001
B56	12	0.746	0.338	0.036	0.001	PT119-HD	1	3.500	1.588	0.395	0.011	B196	6	2.758	1.251	0.144	0.004
P60	12	0.725	0.329	0.066	0.002	PT119-HD5	1	3.550	1.610	0.403	0.011	P198	12	0.708	0.321	0.079	0.002
PT61-HD	12	0.754	0.342	0.080	0.002	B120	12	1.008	0.457	0.050	0.001	B199	12	0.788	0.357	0.038	0.001
PT62	12	0.525	0.238	0.040	0.001	PF121	12	0.525	0.238	0.047	0.001	B201-S	12	1.475	0.669	0.056	0.002
PT63-1	12	0.633	0.287	0.081	0.002	PT122-5	1	4.400	1.996	0.464	0.013	B202	12	1.175	0.533	0.060	0.002
PT66-HD	12	0.771	0.350	0.063	0.002	BT124	12	1.883	0.854	0.087	0.002	P203	12	0.821	0.372	0.080	0.002
P67	12	0.742	0.337	0.061	0.002	P125	12	0.450	0.204	0.046	0.001	P203-HD	12	0.958	0.435	0.082	0.002
P68	12	0.871	0.395	0.082	0.002	BT126	12	1.388	0.630	0.079	0.002	P203-HD10	12	0.971	0.440	0.083	0.002
PT70	12	0.671	0.304	0.066	0.002	P127	12	0.788	0.357	0.082	0.002	P204	12	0.983	0.446	0.107	0.003
PT71	12	0.530	0.240	0.056	0.002	B128	12	1.971	0.894	0.086	0.002	P204-HD	12	1.179	0.535	0.107	0.003
PT72	12	0.712	0.323	0.081	0.002	B129	12	1.787	0.811	0.088	0.002	P204-HD10	12	1.167	0.529	0.107	0.003
P73	12	0.529	0.240	0.040	0.001	B131	12	0.708	0.321	0.028	0.001	B205	6	2.392	1.085	0.121	0.003
B74	12	1.033	0.469	0.048	0.001	B132	12	0.975	0.442	0.051	0.001	P206	12	0.700	0.318	0.081	0.002
B75	12	1.612	0.731	0.070	0.002	C133-OW	7	2.714	1.231	0.390	0.011	PT207	12	0.908	0.412	0.107	0.003
B76	12	2.375	1.077	0.120	0.003	C133-W	7	2.679	1.215	0.388	0.011	PT207-10	12	0.896	0.406	0.108	0.003
B76-MPG	12	2.650	1.202	0.120	0.003	B134	12	1.621	0.735	0.069	0.002	PT207-HD	12	1.142	0.518	0.106	0.003
B76-SS	12	2.492	1.130	0.122	0.003	PT135	12	0.329	0.149	0.033	0.001	PT207-HD10	12	1.138	0.516	0.107	0.003

BALDWIN WEIGHTS AND VOLUMES

BALDWIN NUMBER	CASE QTY.	WEIGHT (ea.) lbs.	WEIGHT (ea.) kgs.	Volume (ea.) ft ³	Volume (ea.) m ³	BALDWIN NUMBER	CASE QTY.	WEIGHT (ea.) lbs.	WEIGHT (ea.) kgs.	Volume (ea.) ft ³	Volume (ea.) m ³	BALDWIN NUMBER	CASE QTY.	WEIGHT (ea.) lbs.	WEIGHT (ea.) kgs.	Volume (ea.) ft ³	Volume (ea.) m ³
PT213	12	1.008	0.457	0.133	0.004	PT289-10	12	0.475	0.215	0.063	0.002	BT371-MPG	12	1.404	0.637	0.060	0.002
PT214(2)	12	0.563	0.255	0.103	0.003	PT290	12	0.471	0.214	0.062	0.002	BT372-10	12	1.804	0.818	0.096	0.003
BT215	12	0.717	0.325	0.035	0.001	BT292	12	1.125	0.510	0.053	0.001	BT372-MPG	12	1.917	0.870	0.096	0.003
BT216	12	1.183	0.537	0.052	0.001	P294	12	1.867	0.847	0.158	0.004	PT373	12	1.225	0.556	0.105	0.003
BT217	12	1.342	0.609	0.068	0.002	B295	12	0.837	0.380	0.048	0.001	PT374	12	0.612	0.278	0.064	0.002
B218	12	2.508	1.138	0.122	0.003	B296	12	0.904	0.410	0.045	0.001	PT375	12	0.950	0.431	0.099	0.003
B220	6	2.658	1.206	0.145	0.004	PT298-10	12	1.075	0.488	0.119	0.003	PT376	12	1.433	0.650	0.135	0.004
BT221	12	1.996	0.905	0.080	0.002	B299	12	1.379	0.626	0.067	0.002	PT377	12	0.646	0.293	0.047	0.001
B222	12	1.475	0.669	0.057	0.002	T300-M	12	0.729	0.331	0.053	0.001	PT377-10	12	0.646	0.293	0.048	0.001
BT223	12	0.700	0.318	0.029	0.001	B301	12	0.625	0.284	0.031	0.001	B378	12	1.554	0.705	0.084	0.002
PF224	12	0.179	0.081	0.020	0.001	PT302	12	1.267	0.575	0.074	0.002	B378-10	12	1.521	0.690	0.083	0.002
PF225	12	0.904	0.410	0.107	0.003	T303-M	12	1.204	0.546	0.071	0.002	PT379 KIT	6	1.383	0.627	0.157	0.004
PF226	12	0.546	0.248	0.065	0.002	PT304	12	1.333	0.605	0.095	0.003	PT380 KIT	1	2.350	1.066	0.234	0.007
B227	12	0.625	0.284	0.028	0.001	BT305	12	1.379	0.626	0.065	0.002	PT381	12	1.821	0.826	0.134	0.004
B228	12	0.667	0.303	0.028	0.001	B307	12	0.633	0.287	0.032	0.001	PT382	12	0.471	0.214	0.035	0.001
B229	12	1.004	0.455	0.043	0.001	T308-M	12	0.725	0.329	0.054	0.002	PT383	12	1.088	0.494	0.132	0.004
BT230	12	1.088	0.494	0.051	0.001	B309	12	1.754	0.796	0.086	0.002	PT385	12	1.517	0.688	0.134	0.004
PF231	12	0.429	0.195	0.056	0.002	BT310	12	0.663	0.301	0.032	0.001	PT385-E	12	1.546	0.701	0.132	0.004
BD232	12	2.196	0.996	0.078	0.002	PF311	12	0.354	0.161	0.033	0.001	PT386	12	1.354	0.614	0.237	0.007
B233	12	1.083	0.491	0.050	0.001	PF312	12	1.071	0.486	0.100	0.003	BT387	6	2.592	1.176	0.124	0.004
BT234	6	2.262	1.026	0.095	0.003	PF313	12	0.325	0.147	0.034	0.001	BT387-10	6	2.625	1.191	0.125	0.004
P235	12	0.725	0.329	0.100	0.003	PF314	12	0.250	0.113	0.034	0.001	BT388	6	3.300	1.497	0.264	0.007
B236	12	1.479	0.671	0.074	0.002	PF316	6	2.617	1.187	0.277	0.008	BT388-10	6	3.325	1.508	0.265	0.007
BT237	12	1.350	0.612	0.066	0.002	PT317-MPG	1	1.550	0.703	0.096	0.003	BT389	6	3.342	1.516	0.263	0.007
BT238	12	1.787	0.811	0.088	0.002	PT318-MPG	1	1.650	0.748	0.090	0.003	BT389-10	6	3.392	1.539	0.262	0.007
B239	6	4.208	1.909	0.225	0.006	PT319-MPG	1	3.550	1.610	0.366	0.010	PT390-MPG	12	1.796	0.815	0.135	0.004
P240	12	0.342	0.155	0.034	0.001	PT320-MPG	1	2.950	1.338	0.226	0.006	PT391-MPG	12	1.675	0.760	0.137	0.004
BT241	12	1.108	0.503	0.051	0.001	BD324	6	3.100	1.406	0.140	0.004	PT392	12	1.096	0.497	0.131	0.004
P242	12	1.492	0.677	0.115	0.003	BD325	12	2.946	1.336	0.115	0.003	PT393	12	1.858	0.843	0.190	0.005
B243	12	0.767	0.348	0.037	0.001	B326	12	1.783	0.809	0.086	0.002	PT394-5	6	2.508	1.138	0.266	0.008
B244	12	1.125	0.510	0.052	0.001	B329	6	1.025	0.465	0.049	0.001	PT394-15	6	2.600	1.179	0.262	0.007
B246	12	1.154	0.523	0.075	0.002	BF330	12	0.862	0.391	0.042	0.001	BT395	12	1.083	0.491	0.047	0.001
B247	12	0.750	0.340	0.036	0.001	PF332	12	0.604	0.274	0.065	0.002	PT396	12	0.417	0.189	0.034	0.001
BT248	12	1.183	0.537	0.052	0.001	B333	6	3.250	1.474	0.164	0.005	PT397	4	3.025	1.372	0.378	0.011
P249	12	1.471	0.667	0.120	0.003	BT334	12	1.217	0.552	0.060	0.002	BT398	12	2.308	1.047	0.107	0.003
BT251	12	1.296	0.588	0.066	0.002	B336	12	1.188	0.539	0.062	0.002	PT400	6	1.983	0.899	0.205	0.006
B252	12	1.425	0.646	0.053	0.001	B337	12	1.625	0.737	0.072	0.002	PT401-MPG	6	1.517	0.688	0.155	0.004
B253	12	1.450	0.658	0.049	0.001	BT338	12	1.042	0.473	0.046	0.001	BT402	12	2.333	1.058	0.108	0.003
P254	1	0.650	0.295	0.114	0.003	BT339	12	1.208	0.548	0.066	0.002	B403	12	1.563	0.709	0.099	0.002
B255	12	1.396	0.633	0.049	0.001	BT340	12	2.583	1.172	0.126	0.004	B404	6	2.083	0.945	0.093	0.003
PT256	12	0.150	0.068	0.036	0.001	BT341	12	1.029	0.467	0.041	0.001	JC405	12	0.767	0.348	0.070	0.002
PT257	12	0.183	0.083	0.035	0.001	BT342	12	1.458	0.661	0.077	0.002	CU406	12	0.775	0.352	0.072	0.002
PT258	12	0.350	0.159	0.030	0.001	BT343	6	3.175	1.440	0.143	0.004	DF408	6	2.175	0.987	0.236	0.007
BT259	12	1.213	0.550	0.060	0.002	BT344-S	12	1.371	0.622	0.041	0.001	TC413-CPE5	12	1.404	0.637	0.122	0.003
BT260	12	1.063	0.482	0.052	0.001	BT345 KIT	1	6.250	2.835	0.546	0.015	V414-B	4	3.313	1.503	0.541	0.015
BT260-10	12	1.112	0.504	0.051	0.001	BT346	12	0.950	0.431	0.050	0.001	V414-FF	4	2.963	1.344	0.535	0.015
BT261	12	1.313	0.596	0.068	0.002	BT347	12	1.821	0.826	0.086	0.002	F415-B	4	3.338	1.514	0.546	0.015
B262	12	1.546	0.701	0.084	0.002	BT348	12	1.575	0.714	0.073	0.002	P415-10	4	4.725	2.143	0.546	0.015
B263	12	2.108	0.956	0.107	0.003	BT349	12	2.063	0.936	0.109	0.003	P415-10A	4	4.288	1.945	0.546	0.015
BT264	12	1.075	0.488	0.049	0.001	BT350	12	1.775	0.805	0.089	0.003	P415-25	4	4.313	1.956	0.539	0.015
PT265	12	0.675	0.306	0.061	0.002	BT351	12	2.625	1.191	0.115	0.003	P415-25A	4	4.013	1.820	0.532	0.015
P266	12	0.558	0.253	0.055	0.002	BT351-MPG	6	2.967	1.346	0.148	0.004	P415-5	4	4.438	2.013	0.534	0.015
BT267	12	1.496	0.679	0.070	0.002	P352	6	1.475	0.669	0.201	0.006	P415-5A	4	4.163	1.888	0.547	0.015
PT268	12	1.033	0.469	0.132	0.004	BT353	12	0.854	0.387	0.047	0.001	P415-5AN	4	4.113	1.866	0.538	0.015
PT269	12	0.558	0.253	0.055	0.002	BT354	12	1.117	0.507	0.052	0.001	P415-GM	4	3.787	1.718	0.585	0.017
P271	12	0.392	0.178	0.033	0.001	BT355	12	1.504	0.682	0.072	0.002	V415-B	4	3.475	1.576	0.516	0.015
PT273	12	0.538	0.244	0.047	0.001	P356	12	0.579	0.263	0.080	0.002	V415-FF	4	3.063	1.389	0.539	0.015
BT274	12	1.204	0.546	0.062	0.002	BT357	12	0.950	0.431	0.051	0.001	PT416	12	0.404	0.183	0.034	0.001
PT275	12	1.213	0.550	0.134	0.004	B358	12	1.071	0.486	0.048	0.001	PT418	4	6.025	2.733	0.736	0.021
PT275-10	12	1.150	0.522	0.134	0.004	BT359	6	3.200	1.452	0.145	0.004	BT420	12	1.338	0.607	0.041	0.001
P276	12	1.029	0.467	0.108	0.003	B360	12	1.104	0.501	0.051	0.001	B421	12	0.638	0.289	0.032	0.001
PT277	12	0.871	0.395	0.099	0.003	BT361	12	1.042	0.473	0.052	0.001	S423	12	0.067	0.030	0.011	**
B279	12	1.296	0.588	0.060	0.002	BT364	12	1.175	0.533	0.052	0.001	BT424	6	2.550	1.157	0.129	0.004
P280	12	0.400	0.181	0.049	0.001	BT365	12	1.275	0.578	0.068	0.002	BT425	6	2.725	1.236	0.178	0.005
B281	12	1.142	0.518	0.051	0.001	BT365-10	12	1.362	0.618	0.080	0.002	PT426	12	1.287	0.584	0.107	0.003
PT283	12	0.217	0.098	0.036	0.001	BT366-10	12	1.112	0.504	0.052	0.001	BT427	12	1.046	0.474	0.054	0.002
PT284	12	0.238	0.108	0.037	0.001	BT366-MPG	12	1.863	0.845	0.059	0.002	V429-B	4	4.750	2.155	0.914	0.026
PT285	6	1.833	0.831	0.275	0.008	BT367	12	0.958	0.435	0.043	0.001	V429-FF	4	4.387	1.990	0.777	0.022
BT287	6	2.558	1.160	0.124	0.004	BT367-S	12	0.896	0.406	0.051	0.001	PT430-FF	6	2.417	1.096	0.259	0.007
BT287-3	6	2.608	1.183</														

BALDWIN WEIGHTS AND VOLUMES

BALDWIN NUMBER	CASE QTY.	WEIGHT (ea.) lbs.	WEIGHT (ea.) kgs.	Volume (ea.) ft ³	Volume (ea.) m ³	BALDWIN NUMBER	CASE QTY.	WEIGHT (ea.) lbs.	WEIGHT (ea.) kgs.	Volume (ea.) ft ³	Volume (ea.) m ³	BALDWIN NUMBER	CASE QTY.	WEIGHT (ea.) lbs.	WEIGHT (ea.) kgs.	Volume (ea.) ft ³	Volume (ea.) m ³
PT436	12	1.525	0.692	0.134	0.004	BT521	12	1.921	0.871	0.088	0.002	PA613	6	1.417	0.643	0.281	0.008
PT437	12	0.858	0.389	0.083	0.002	PT522	12	0.608	0.276	0.100	0.003	BF614	12	2.017	0.915	0.098	0.003
BT438	12	1.421	0.645	0.057	0.002	BT525	12	1.608	0.729	0.096	0.003	PA615	6	1.350	0.612	0.247	0.007
PT439	12	0.587	0.266	0.062	0.002	BT526	12	1.167	0.529	0.050	0.001	PA616	1	4.500	2.041	0.891	0.025
BT440	12	1.733	0.786	0.086	0.002	BT526-10	12	1.208	0.548	0.050	0.001	PA617	1	3.450	1.565	0.574	0.016
PT441	12	0.983	0.446	0.054	0.002	PT527	1	5.100	2.313	0.853	0.024	PA618	1	5.450	2.472	0.884	0.025
PT442-MPG	12	2.375	1.077	0.139	0.004	P528	12	1.013	0.459	0.097	0.003	PA618 FOAM	6	0.242	0.110	0.153	0.004
BT443	6	2.333	1.058	0.126	0.004	P529	6	2.625	1.191	0.326	0.009	PA618-S	1	5.150	2.336	0.869	0.025
PT445-MPG	12	0.829	0.376	0.062	0.002	PT534	6	0.892	0.405	0.165	0.005	PA621	6	1.067	0.484	0.234	0.007
P446	12	0.346	0.157	0.034	0.001	PT535	12	0.779	0.353	0.063	0.002	PA625	6	1.717	0.779	0.342	0.010
B447	12	1.375	0.624	0.059	0.002	BT536	12	1.029	0.467	0.052	0.001	PA631	6	3.908	1.773	0.959	0.027
P450	12	0.150	0.068	0.008	0.000	P537	6	3.292	1.493	0.454	0.013	PA632	6	2.490	1.129	0.366	0.010
S451	12	0.050	0.023	0.008	0.000	PT538	12	1.529	0.694	0.189	0.005	PA633(2)	12	0.808	0.367	0.052	0.001
BT452	12	1.196	0.543	0.062	0.002	PT539	1	1.950	0.885	0.225	0.006	PA634	6	0.700	0.318	0.102	0.003
P454	12	0.340	0.154	0.020	0.001	P540	12	0.100	0.045	0.016	0.000	PA638	4	2.000	0.907	0.502	0.014
S455	12	0.067	0.030	0.011	0.000	BT541	12	1.112	0.504	0.016	0.001	PA639	1	5.200	2.359	0.780	0.022
S456	12	0.192	0.087	0.034	0.001	PT543 KIT	6	1.642	0.745	0.222	0.006	PA640	6	0.625	0.284	0.106	0.003
PT457-MPG	6	2.917	1.323	0.262	0.007	P545	12	0.755	0.342	0.059	0.002	PA641	1	2.100	0.953	0.288	0.008
PT459	12	0.162	0.073	0.011	0.000	PT546	12	0.542	0.246	0.048	0.001	PA642	6	1.217	0.552	0.250	0.007
PT461	12	0.238	0.108	0.033	0.001	PT548	6	0.400	0.181	0.034	0.001	PA643	12	0.346	0.157	0.081	0.002
PT462	6	2.225	1.009	0.279	0.008	PT549	12	0.600	0.272	0.056	0.002	PA644	12	0.367	0.166	0.082	0.002
PT463	12	0.380	0.172	0.021	0.001	PT550-10	6	2.284	1.036	0.250	0.007	PA645	1	7.850	3.561	1.230	0.035
PT466	12	1.504	0.682	0.132	0.004	PT551-10	1	3.050	1.383	0.327	0.009	PA648	6	1.042	0.473	0.233	0.007
PT467-MPG	6	1.575	0.714	0.118	0.003	PT554	12	1.642	0.745	0.233	0.007	PA649	6	0.583	0.264	0.104	0.003
PT468-MPG	12	1.167	0.529	0.089	0.003	P555	12	1.600	0.726	0.186	0.005	PA650	6	0.983	0.446	0.214	0.006
PT469	1	2.200	0.998	0.233	0.007	BT556-10	12	2.471	1.121	0.120	0.003	PA651	4	2.125	0.964	0.518	0.015
BT470	12	1.838	0.834	0.086	0.002	PT558	6	0.867	0.393	0.104	0.003	PA652	6	0.892	0.405	0.148	0.004
PT471	12	0.883	0.401	0.191	0.005	PT560 KIT	1	2.550	1.157	0.221	0.006	PA653	1	1.200	0.544	0.223	0.006
BT472	12	2.563	1.163	0.108	0.003	PT561	12	1.542	0.699	0.137	0.004	PA654	1	3.992	1.811	0.589	0.017
B474	12	0.675	0.306	0.031	0.001	PT562-10	12	0.658	0.298	0.066	0.002	PA655	1	2.650	1.202	0.372	0.011
PT475	12	1.317	0.597	0.136	0.004	PT563	12	1.696	0.724	0.189	0.005	PA656	1	4.100	1.860	0.554	0.016
P476	12	0.833	0.378	0.102	0.003	BT564	12	1.454	0.660	0.070	0.002	PA657	6	1.008	0.457	0.194	0.005
PT477	12	0.342	0.155	0.037	0.001	PT565	6	0.842	0.382	0.159	0.004	PA658	6	0.925	0.420	0.155	0.004
S479	12	0.233	0.106	0.049	0.001	PT566	12	1.379	0.626	0.189	0.005	PA662	6	2.050	0.930	0.196	0.006
PT480	12	0.629	0.285	0.049	0.001	PT567	12	0.942	0.427	0.101	0.003	PA666	1	7.400	3.357	1.519	0.043
PT480-10	12	0.629	0.285	0.047	0.001	PT567-10	12	0.892	0.405	0.099	0.003	PA669	6	1.333	0.605	0.114	0.003
PT480-MPG	12	0.763	0.346	0.048	0.001	PT568	12	2.137	0.969	0.187	0.005	PT670	12	0.929	0.421	0.108	0.003
B481	12	1.338	0.607	0.063	0.002	PT571	1	1.800	0.816	0.177	0.005	PT670-E	12	0.888	0.403	0.109	0.003
PT483	1	4.100	1.860	0.472	0.013	PT573	1	1.900	0.862	0.191	0.005	PA671	1	4.200	1.905	0.652	0.018
S485	12	0.010	0.005	0.016	0.000	BF577	12	1.488	0.675	0.083	0.002	PA671-1	1	3.550	1.610	0.661	0.019
BT486	6	2.667	1.210	0.148	0.004	PT578	12	1.033	0.469	0.133	0.004	PA675	6	0.450	0.204	0.081	0.002
PT487	12	1.208	0.548	0.098	0.003	PT579	12	1.071	0.486	0.189	0.005	PT676	1	1.450	0.658	0.106	0.003
B488	12	0.954	0.433	0.048	0.001	BF582	12	1.221	0.554	0.060	0.002	PA677	6	0.317	0.144	0.034	0.001
S489	12	0.296	0.134	0.047	0.001	BF583	12	1.138	0.516	0.054	0.002	PA678	6	0.592	0.269	0.100	0.003
PT490	1	3.200	1.452	0.318	0.009	BF584	12	2.383	1.081	0.124	0.004	PT679	1	0.800	0.363	0.067	0.002
PT491	1	5.700	2.586	0.474	0.013	BF584-B	12	2.558	1.160	0.128	0.004	PA680	6	1.092	0.495	0.204	0.006
PT491-10	1	5.050	2.291	0.472	0.013	BF585	12	1.071	0.486	0.052	0.001	PT682	1	2.100	0.953	0.234	0.007
PT492	12	0.329	0.149	0.037	0.001	BF586	12	0.904	0.410	0.046	0.001	PT683	1	2.950	1.338	0.174	0.005
PT493	6	2.983	1.353	0.377	0.011	BF586-D	12	0.925	0.420	0.046	0.001	PT685-MPG	12	1.146	0.520	0.291	0.003
B494	12	1.463	0.664	0.054	0.002	BF587	12	0.933	0.423	0.046	0.001	PA691	6	1.075	0.488	0.094	0.006
B495	6	2.817	1.278	0.147	0.004	BF587-D	12	0.962	0.436	0.046	0.001	PT691	1	0.500	0.227	0.072	0.002
B495-MPG	6	3.008	1.364	0.144	0.004	BF588	12	1.904	0.864	0.086	0.002	PA693	6	2.034	0.923	0.591	0.017
B495-SS	6	2.800	1.270	0.143	0.004	BF591	12	1.458	0.661	0.081	0.002	PT694	1	3.000	1.361	0.231	0.007
P496	12	0.342	0.155	0.034	0.001	BF592	12	0.983	0.446	0.045	0.001	PA696	6	0.742	0.337	0.105	0.003
P497	12	0.413	0.187	0.048	0.001	BF593	12	0.983	0.446	0.042	0.001	PA697	6	0.558	0.253	0.052	0.001
PT498	12	1.058	0.480	0.105	0.003	F594-F	12	1.104	0.501	0.106	0.003	PA699	6	0.858	0.389	0.120	0.003
PT498-10	12	1.071	0.486	0.107	0.003	PF594	12	0.942	0.427	0.107	0.003	C704-L	4	4.575	2.075	0.388	0.011
PT499-5	1	2.650	1.202	0.289	0.008	BT595	12	1.237	0.561	0.066	0.002	PT706-M	4	3.675	1.667	0.583	0.016
F501-MD	4	1.575	0.714	0.152	0.004	BF596	6	2.808	1.274	0.164	0.005	PT707-HD	12	1.321	0.599	0.100	0.003
PT503	1	3.250	1.474	0.486	0.014	BF597	12	1.425	0.646	0.099	0.003	PT707-HD10	12	1.354	0.614	0.101	0.003
PF506	12	0.296	0.134	0.034	0.001	PF598	12	0.371	0.168	0.039	0.001	PT707-HD3	12	1.350	0.612	0.101	0.003
P507	12	1.188	0.539	0.187	0.005	PF598-10	12	0.350	0.159	0.040	0.001	PT708-HD	12	1.313	0.596	0.100	0.003
PT508-MPG	12	1.321	0.599	0.097	0.003	PF598-30	12	0.392	0.178	0.040	0.001	PT714	6	3.142	1.425	0.372	0.011
PT509-MPG KIT	1	3.450	1.565	0.236	0.007	PF599	12	0.100	0.045	0.016	0.000	PT716	1	1.650	0.748	0.137	0.004
PT510	12	1.442	0.654	0.135	0.004	PF599-10	12	0.162	0.073	0.021	0.001	PF717	12	0.196	0.089	0.020	0.001
PT512	4	1.787	0.811	0.280	0.008	PF599-30	12	0.050	0.023	0.014	0.000	PT718-5	4	4.025	1.826	0.532	0.015
PT513	12	0.387	0.176	0.055	0.002	PA602	6	1.312	0.595	0.258	0.007	BF719	12	1.088	0.494	0.045	0.001
PT514	12	1.108	0.503	0.131	0.004	PA604	6	1.508	0.684	0.238	0.007	BF720	12	0.979	0.444	0.042	0.001
PT515	4	3.787	1.718	0.599	0.017	B605	12	1.742	0.790	0.070	0.002	PT721	12	1.013	0.459	0.134	0.004
PT516	12	1.167	0.529	0.100	0.												

BALDWIN WEIGHTS AND VOLUMES

BALDWIN NUMBER	CASE QTY.	WEIGHT (ea.) lbs.	WEIGHT (ea.) kgs.	Volume (ea.) ft ³	Volume (ea.) m ³	BALDWIN NUMBER	CASE QTY.	WEIGHT (ea.) lbs.	WEIGHT (ea.) kgs.	Volume (ea.) ft ³	Volume (ea.) m ³	BALDWIN NUMBER	CASE QTY.	WEIGHT (ea.) lbs.	WEIGHT (ea.) kgs.	Volume (ea.) ft ³	Volume (ea.) m ³
PT727-HD10	12	0.612	0.278	0.048	0.001	PF826	12	0.742	0.337	0.082	0.002	PT903	12	0.467	0.212	0.042	0.001
PT728-MPG	12	0.513	0.233	0.050	0.001	PF827	12	0.158	0.072	0.024	0.001	PF906	12	0.358	0.162	0.034	0.001
PT729	4	4.438	2.013	0.547	0.015	PF828	12	0.408	0.185	0.047	0.001	PF907	12	0.533	0.242	0.063	0.002
BT732	6	2.375	1.077	0.090	0.003	PF829(2)	6	1.550	0.703	0.195	0.006	F908-A	6	2.033	0.922	0.254	0.007
BT735	12	1.975	0.896	0.075	0.002	BF830	12	0.633	0.287	0.059	0.002	BF909	12	1.700	0.771	0.048	0.001
PT737	12	1.121	0.508	0.101	0.003	PF831	12	0.421	0.191	0.049	0.001	PF910	12	0.508	0.230	0.062	0.002
PT737-10	12	1.133	0.514	0.099	0.003	BF833	12	0.204	0.093	0.020	0.001	BF912	12	1.525	0.692	0.043	0.001
V738-O	12	0.667	0.303	0.087	0.002	BF833-K2	12	0.250	0.113	0.020	0.001	PF913	12	0.308	0.140	0.034	0.001
BT739	12	2.229	1.011	0.096	0.003	F834-F	12	0.379	0.172	0.027	0.001	BF914	6	2.192	0.994	0.142	0.004
C740-S	12	0.462	0.210	0.063	0.002	PF834	12	0.337	0.153	0.034	0.001	BF915	12	1.350	0.612	0.070	0.002
C750-E	4	6.138	2.784	0.678	0.019	BF836	12	0.204	0.093	0.020	0.001	F916-C	12	0.396	0.180	0.062	0.002
C750-L	4	7.913	3.589	0.653	0.018	BF836-K3	12	0.258	0.117	0.020	0.001	PF916	12	0.492	0.223	0.047	0.001
C750-L SINGLE	1	8.150	3.697	0.704	0.020	BF836-K4	12	0.100	0.045	0.016	**	BF918-K	12	0.250	0.113	0.016	**
PT751	6	2.233	1.013	0.248	0.007	BF837	12	0.100	0.045	0.016	**	F919-C	60	0.283	0.128	0.025	0.001
PT752	6	2.700	1.225	0.375	0.011	BF838-F2	12	0.513	0.233	0.040	0.001	BF920	12	0.183	0.083	0.018	0.001
PT753	1	8.250	3.742	1.288	0.036	PF838	12	0.462	0.210	0.040	0.001	PF924	12	0.529	0.240	0.066	0.002
PT757	6	2.242	1.017	0.263	0.007	BT839	12	1.092	0.495	0.053	0.001	BF925	12	0.563	0.255	0.036	0.001
PT757-10	6	2.383	1.081	0.265	0.007	BT839-10	12	1.104	0.501	0.051	0.001	PF926	12	0.425	0.193	0.066	0.002
PT760-10	12	1.446	0.656	0.133	0.004	BF840	12	0.200	0.091	0.016	**	BF928	12	0.125	0.057	0.022	0.001
PT760-25	12	1.417	0.643	0.134	0.004	BF840-K1	12	0.250	0.113	0.016	**	BF929	12	0.558	0.253	0.065	0.002
PT761	12	1.429	0.648	0.135	0.004	VT842-O	12	0.558	0.253	0.070	0.002	BF930	12	0.254	0.115	0.023	0.001
PT763	6	3.067	1.391	0.384	0.011	BF843	12	0.275	0.125	0.020	0.001	BF932	12	0.121	0.055	0.022	0.001
PT764	12	1.104	0.501	0.083	0.002	F844-A	12	1.063	0.482	0.124	0.004	BF933	12	0.100	0.045	0.016	**
PT765	12	1.171	0.531	0.081	0.002	F845-A	12	0.554	0.251	0.059	0.002	PF935	12	0.208	0.094	0.022	0.001
PT766	6	2.608	1.183	0.467	0.013	PF845	12	0.542	0.246	0.061	0.002	PF936	12	0.542	0.246	0.034	0.001
PT767	6	3.058	1.387	0.378	0.011	PF846	12	1.329	0.603	0.132	0.004	PF937	12	0.125	0.057	0.014	**
PT768	6	3.009	1.365	0.371	0.010	PF847	12	0.166	0.075	0.013	**	BF938	12	0.946	0.429	0.042	0.001
PT772	6	2.442	1.108	0.371	0.010	PT849	12	0.450	0.204	0.033	0.001	BF939	12	0.975	0.442	0.043	0.001
PT773-MPG	6	3.892	1.765	0.244	0.007	PT849-10	12	0.471	0.214	0.034	0.001	BF940	12	0.604	0.274	0.028	0.001
BT774	1	5.400	2.449	0.210	0.006	V852-O	12	0.992	0.450	0.125	0.004	BF941	12	0.875	0.397	0.042	0.001
BT775	6	4.317	1.958	0.205	0.006	BF853	12	0.375	0.170	0.021	0.001	PF942	12	0.529	0.240	0.062	0.002
PT776-MPG	12	2.246	1.019	0.135	0.004	BF855	12	0.558	0.253	0.029	0.001	PF943	12	0.383	0.174	0.038	0.001
PT777	12	1.508	0.684	0.130	0.004	BF856	12	0.950	0.431	0.035	0.001	PF945	12	0.288	0.131	0.033	0.001
BT778	12	1.663	0.754	0.084	0.002	PF857	12	0.071	0.032	0.011	**	PF946	12	0.379	0.172	0.034	0.001
BT779	12	1.175	0.533	0.047	0.001	BF858	12	0.367	0.166	0.037	0.001	PF947	12	0.367	0.166	0.034	0.001
BF781	12	1.317	0.597	0.079	0.002	PF859	12	0.088	0.040	0.011	**	BF948	12	0.950	0.431	0.043	0.001
BF782	12	0.692	0.314	0.033	0.001	PF860	12	0.288	0.131	0.033	0.001	BF948-JD	12	1.067	0.484	0.061	0.002
BF783	12	1.688	0.766	0.087	0.002	PF861	12	0.308	0.140	0.033	0.001	PF949	1	3.600	1.633	0.407	0.012
BF784	6	2.692	1.221	0.139	0.004	BF862	12	1.092	0.495	0.061	0.002	F950-F	12	0.646	0.293	0.056	0.002
BF785	6	2.625	1.191	0.139	0.004	BF863	12	1.104	0.501	0.060	0.002	F950-F WO	12	0.550	0.249	0.055	0.002
BF786	12	1.563	0.709	0.058	0.002	PF864	12	0.030	0.014	0.124	0.004	PF950	12	0.467	0.212	0.056	0.002
BF788	12	0.917	0.416	0.032	0.001	BF865	12	0.213	0.097	0.020	0.001	PT951	12	0.442	0.200	0.039	0.001
BF789	12	0.950	0.431	0.044	0.001	BF865-K	12	0.275	0.125	0.021	0.001	PF952	12	1.429	0.648	0.121	0.003
BF790	12	0.688	0.312	0.029	0.001	PF866	12	0.292	0.132	0.034	0.001	F953-F	12	0.313	0.142	0.037	0.001
BF791	12	1.063	0.482	0.044	0.001	BF868	12	0.367	0.166	0.038	0.001	BF954	12	0.720	0.327	0.028	0.001
BF791-O	12	1.095	0.497	0.051	0.001	PF869	12	1.279	0.580	0.237	0.007	BF955	12	1.096	0.497	0.052	0.001
BF792	12	1.092	0.495	0.046	0.001	PF872	12	0.088	0.040	0.015	**	BF956	12	1.150	0.522	0.051	0.001
BF794	12	0.383	0.174	0.038	0.001	BF873	12	0.175	0.079	0.045	0.001	BF957	12	1.063	0.482	0.055	0.002
BF795	12	0.488	0.221	0.076	0.002	BF874	12	0.621	0.282	0.040	0.001	BF957-D	12	1.075	0.488	0.052	0.001
BF797	12	1.071	0.486	0.052	0.001	BF876	12	1.813	0.822	0.086	0.002	BF958	12	1.475	0.669	0.077	0.002
BF798	12	1.321	0.599	0.064	0.002	BF877	12	1.858	0.843	0.087	0.002	BF959	12	1.075	0.488	0.049	0.001
BF799	6	4.258	1.931	0.247	0.007	BF879	12	0.154	0.070	0.019	0.001	P960	12	0.404	0.183	0.051	0.001
PF802	12	0.375	0.170	0.034	0.001	BF880-FP	12	2.121	0.962	0.095	0.003	PF962	12	1.171	0.531	0.062	0.002
PF804	12	0.621	0.282	0.064	0.002	BF881	12	0.150	0.068	0.023	0.001	PF963	12	0.629	0.285	0.063	0.002
BF805	12	0.001	**	0.011	**	PF882	12	0.396	0.180	0.061	0.002	BF964	12	0.321	0.146	0.038	0.001
BF806	12	0.871	0.395	0.031	0.001	PF883	12	0.417	0.189	0.048	0.001	BF966	12	0.483	0.219	0.046	0.001
PF807	12	0.350	0.159	0.034	0.001	BF884	12	0.696	0.316	0.047	0.001	PF967	12	0.492	0.223	0.046	0.001
PF809	12	0.742	0.337	0.082	0.002	BF885	12	0.788	0.357	0.064	0.002	BF968	12	1.209	0.548	0.055	0.002
PF810	12	0.563	0.255	0.063	0.002	BF886	12	0.321	0.146	0.037	0.001	BF970	12	1.217	0.552	0.066	0.002
PF811	12	1.692	0.767	0.188	0.005	BF888	12	1.625	0.737	0.084	0.002	BF971	12	1.263	0.573	0.069	0.002
BF812	12	0.733	0.332	0.054	0.002	BF890	12	0.629	0.285	0.047	0.001	BF974-D	12	1.367	0.620	0.075	0.002
PF814	12	0.508	0.230	0.045	0.001	BF891	12	1.175	0.533	0.063	0.002	B975	12	1.292	0.586	0.067	0.002
PF816	12	0.275	0.125	0.034	0.001	BF892	12	1.542	0.699	0.084	0.002	BF976	12	2.463	1.117	0.123	0.003
PF816-S	12	0.233	0.106	0.033	0.001	PF893	12	0.071	0.032	0.023	0.001	BF978	12	1.550	0.703	0.084	0.002
PF818	12	0.200	0.091	0.015	**	PF893-RV	12	0.001	**	0.015	**	BF979	12	1.554	0.705	0.084	0.002
PF819	12	0.725	0.329	0.081	0.002	PF894	12	0.001	**	0.015	**	BF980	12	1.529	0.694	0.076	0.002
PF819-HD	12	0.875	0.397	0.082	0.002	PF894-RV	12	0.006	0.003	0.015	**	PF981	12	0.146	0.066	0.015	**
PF820-S	12	0.308	0.140	0.033	0.001	BF896	12	1.133	0.514	0.055	0.002	BF984	12	1.142	0.518	0.060	0.002
PF821-S	12	0.712	0.323	0.062	0.002	BF897 KIT	1	2.400	1.089	0.234	0.007	PF986	12	0.262	0.119	0.020	0.001
PF822	12	0.733	0.332	0.079	0.002	SF898	12	0.030	0.0								

BALDWIN WEIGHTS AND VOLUMES

BALDWIN NUMBER	CASE QTY.	WEIGHT (ea.) lbs.	WEIGHT (ea.) kgs.	Volume (ea.) ft ³	Volume (ea.) m ³	BALDWIN NUMBER	CASE QTY.	WEIGHT (ea.) lbs.	WEIGHT (ea.) kgs.	Volume (ea.) ft ³	Volume (ea.) m ³	BALDWIN NUMBER	CASE QTY.	WEIGHT (ea.) lbs.	WEIGHT (ea.) kgs.	Volume (ea.) ft ³	Volume (ea.) m ³
BF995	12	0.129	0.059	0.027	0.001	BF1222	12	1.704	0.773	0.076	0.002	BF1307	1	0.500	0.227	0.042	0.001
P996	12	2.279	1.034	0.234	0.007	BF1222-O	12	1.708	0.775	0.062	0.002	OB1308	1	1.900	0.862	0.111	0.003
PF997	12	0.167	0.076	0.020	0.001	BF1222-SP	12	1.854	0.841	0.073	0.002	BF1309	1	2.800	1.270	0.092	0.003
P998	12	1.233	0.559	0.191	0.005	BF1223	12	1.950	0.885	0.086	0.002	BF1310	1	2.500	1.134	0.097	0.003
P999-HD	12	1.592	0.722	0.186	0.005	BF1223-O	12	1.846	0.837	0.081	0.002	BF1311	1	0.798	0.362	0.053	0.001
BF1008	12	0.550	0.249	0.062	0.002	BF1223-SP	12	2.092	0.949	0.087	0.002	OB1313	1	2.000	0.907	0.091	0.003
V1009-W	12	2.000	0.907	0.173	0.005	BF1224	12	1.838	0.834	0.069	0.002	OB1314	1	1.900	0.862	0.093	0.003
BF1010	12	0.604	0.274	0.063	0.002	BF1225	12	1.375	0.624	0.075	0.002	OB1315	1	1.950	0.885	0.091	0.003
V1044-O	12	1.067	0.484	0.127	0.004	BF1226	12	1.025	0.465	0.039	0.001	OB1316	1	2.000	0.907	0.095	0.003
BF1045	12	0.529	0.240	0.061	0.002	BF1231	12	1.992	0.904	0.088	0.002	OB1317	1	0.850	0.386	0.027	0.001
BF1046	12	0.337	0.153	0.046	0.001	BF1232	12	1.029	0.467	0.035	0.001	OB1318	1	0.800	0.363	0.030	0.001
BF1047	12	0.800	0.363	0.100	0.003	BF1233	12	1.179	0.535	0.043	0.001	OB1319	1	0.700	0.318	0.027	0.001
BF1048	12	0.746	0.338	0.062	0.002	BF1239	6	3.500	1.588	0.264	0.007	OB1320	1	0.700	0.318	0.027	0.001
BF1049	12	0.329	0.149	0.037	0.001	BF1240	12	1.862	0.845	0.088	0.002	VG1325	1	0.250	0.113	0.029	0.001
BF1050	12	0.788	0.357	0.059	0.002	V1240-C	8	1.581	0.717	0.167	0.005	PG1326	1	0.200	0.091	0.030	0.001
BF1052	12	0.217	0.098	0.037	0.001	BF1248	12	1.183	0.537	0.063	0.002	BF1329	12	2.046	0.928	0.110	0.003
BF1053	1	1.050	0.476	0.819	0.023	BF1249	12	1.558	0.707	0.085	0.002	BF1329-SP	12	2.196	0.996	0.111	0.003
BF1054	1	0.850	0.386	0.268	0.008	BF1249-O	12	1.442	0.654	0.083	0.002	BF1330-SP	12	2.233	1.013	0.109	0.003
BF1056	12	0.646	0.293	0.032	0.001	BF1249-SP	12	1.813	0.822	0.088	0.002	BF1339-SP	12	2.167	0.983	0.108	0.003
BF1057	12	0.400	0.181	0.037	0.001	BF1252	12	1.329	0.603	0.075	0.002	BF1345	12	1.875	0.851	0.088	0.002
BF1059	12	0.433	0.196	0.037	0.001	BF1253	12	1.237	0.561	0.054	0.002	BF1345-O	12	1.870	0.848	0.080	0.002
BF1061	12	0.504	0.229	0.038	0.001	BF1256	12	2.358	1.070	0.121	0.003	BF1345-SP	12	2.033	0.922	0.087	0.002
BF1100	12	0.579	0.263	0.038	0.001	BF1257	12	0.850	0.386	0.031	0.001	BF1346	12	1.963	0.890	0.103	0.003
BF1102	12	1.321	0.599	0.067	0.002	BF1258	12	1.513	0.686	0.075	0.002	BF1346-O	12	1.975	0.896	0.092	0.003
BF1104	12	0.333	0.151	0.037	0.001	BF1259	12	1.667	0.756	0.098	0.003	BF1346-SP	12	2.258	1.024	0.107	0.003
BF1105	12	0.504	0.229	0.047	0.001	BF1261	12	0.833	0.378	0.032	0.001	BF1347	12	2.063	0.936	0.111	0.003
BF1110	12	0.754	0.342	0.032	0.001	BF1262	6	3.183	1.444	0.183	0.005	BF1347-O	6	1.567	0.711	0.087	0.002
BF1112	12	0.517	0.235	0.042	0.001	BF1265	12	2.504	1.136	0.141	0.004	BF1348	12	1.942	0.881	0.088	0.002
BF1123	12	0.308	0.140	0.032	0.001	BF1266	12	1.363	0.618	0.069	0.002	BF1348-O	12	1.783	0.809	0.079	0.002
BF1140	12	0.146	0.066	0.022	0.001	BF1267	12	0.671	0.304	0.028	0.001	BF1348-SP	12	2.096	0.951	0.088	0.002
BF1148	12	0.600	0.272	0.038	0.001	BF1268	12	1.333	0.605	0.077	0.002	BF1349	12	2.079	0.943	0.111	0.003
BF1150	12	0.146	0.066	0.022	0.001	BF1269	12	0.958	0.435	0.033	0.001	BF1350-SP	12	1.754	0.796	0.079	0.002
BF1160	12	0.175	0.079	0.042	0.001	BF1270-SP	12	1.675	0.760	0.064	0.002	BF1352-SP	12	1.929	0.875	0.074	0.002
BF1163	12	0.433	0.196	0.038	0.001	BF1271	12	1.296	0.588	0.057	0.002	BF1353-SPS	12	2.917	1.323	0.137	0.004
BF1166	12	0.521	0.236	0.060	0.002	BF1272-SPS	12	1.942	0.881	0.094	0.003	BF1354-SPS	12	2.858	1.296	0.137	0.004
BF1170	12	0.383	0.174	0.047	0.001	BF1273-SP	12	2.017	0.915	0.090	0.003	BF1355	6	2.550	1.157	0.139	0.004
BF1171	12	0.354	0.161	0.037	0.001	BF1274-SP	6	3.400	1.542	0.169	0.005	BF1355-O	12	2.325	1.055	0.121	0.003
BF1172	12	0.608	0.276	0.083	0.002	BF1274-SPS	6	3.525	1.599	0.168	0.005	BF1355-SP	6	2.725	1.236	0.144	0.004
BF1173	12	0.225	0.102	0.038	0.001	BF1275	12	1.037	0.470	0.040	0.001	BF1356	12	1.475	0.669	0.075	0.002
BF1174	12	0.433	0.196	0.058	0.002	BF1276	12	1.046	0.474	0.047	0.001	BF1357	6	3.200	1.452	0.183	0.005
BF1177	12	0.958	0.435	0.065	0.002	BF1277-SP	6	3.392	1.539	0.168	0.005	BF1358-O	12	2.475	1.123	0.123	0.003
BF1178	12	0.146	0.066	0.022	0.001	BF1277-SPS	6	3.417	1.550	0.168	0.005	BF1358-SP	12	2.854	1.295	0.140	0.004
BF1179	12	0.563	0.255	0.039	0.001	BF1278	12	1.346	0.611	0.065	0.002	BF1359-SP	12	2.787	1.264	0.140	0.004
BF1181	12	0.346	0.157	0.046	0.001	BF1278-O	12	1.213	0.550	0.057	0.002	BF1360	12	2.075	0.941	0.108	0.003
BF1182	12	0.538	0.244	0.062	0.002	BF1279	12	1.508	0.684	0.077	0.002	BF1360-O	6	1.590	0.721	0.079	0.002
BF1184	12	0.363	0.165	0.038	0.001	BF1280	12	1.342	0.609	0.070	0.002	BF1360-SP	12	2.313	1.049	0.109	0.003
BF1185	12	0.340	0.154	0.050	0.001	BF1281	12	2.517	1.142	0.139	0.004	BF1361	12	1.054	0.478	0.046	0.001
BF1186	12	0.483	0.219	0.063	0.002	BF1281-O	12	2.450	1.111	0.129	0.004	BF1362	12	1.917	0.870	0.087	0.002
BF1188	12	0.842	0.382	0.060	0.002	BF1282	12	1.321	0.599	0.065	0.002	BF1363	12	2.742	1.244	0.137	0.004
BF1190	12	0.567	0.257	0.046	0.001	BF1282-O	12	1.230	0.558	0.061	0.002	BF1365	12	1.646	0.747	0.076	0.002
BF1191	12	0.775	0.352	0.061	0.002	BF1283	12	2.617	1.187	0.141	0.004	BF1366-O	12	1.338	0.607	0.065	0.002
BF1193	12	0.642	0.291	0.037	0.001	BF1283-O	12	2.408	1.092	0.123	0.003	BF1367	12	1.079	0.489	0.046	0.001
BF1194	12	0.542	0.246	0.074	0.002	BF1283-SP	12	2.908	1.319	0.143	0.004	OB1368	1	3.650	1.656	0.142	0.004
BF1195	12	0.688	0.312	0.047	0.001	BF1285-SP	12	3.033	1.376	0.139	0.004	OB1369	1	2.100	0.953	0.140	0.004
BF1199	12	0.454	0.206	0.060	0.002	BF1286	12	2.192	0.994	0.106	0.003	BF1370	12	1.917	0.870	0.089	0.003
BF1201	12	0.563	0.255	0.065	0.002	BF1287-O	12	3.125	1.418	0.179	0.005	BF1371	12	1.383	0.627	0.076	0.002
BF1204	12	1.354	0.614	0.069	0.002	BF1288-O	12	2.975	1.349	0.180	0.005	BF1373-SP	12	2.321	1.053	0.108	0.003
BF1204-O	12	1.237	0.561	0.099	0.003	BF1289-SP	12	1.992	0.904	0.081	0.002	BF1372	12	1.200	0.544	0.046	0.001
BF1204-SP	12	1.621	0.735	0.063	0.002	BF1290-O	12	2.200	0.998	0.094	0.003	BF1374-SP	12	2.517	1.142	0.120	0.003
BF1205	12	1.346	0.611	0.066	0.002	PF1291	12	1.392	0.631	0.133	0.004	BF1375	12	2.412	1.094	0.126	0.004
BF1205-SP	12	1.596	0.724	0.066	0.002	BF1292-O	12	2.021	0.917	0.091	0.003	BF1376	12	1.263	0.573	0.079	0.002
BF1210	12	2.871	1.302	0.138	0.004	BF1293-SPS	12	2.092	0.949	0.091	0.003	BF1377	12	2.392	1.085	0.121	0.003
BF1211	12	2.367	1.074	0.108	0.003	BF1294-O	12	2.096	0.951	0.109	0.003	BF1378-SPS	12	2.250	1.021	0.091	0.003
BF1212	12	1.438	0.652	0.077	0.002	BF1295-O	12	1.771	0.803	0.077	0.002	BF1379	12	1.238	0.562	0.038	0.001
BF1212 FOAM	12	0.246	0.112	0.102	0.003	BF1296-O	12	2.292	1.040	0.093	0.003	BF1380	12	1.225	0.556	0.037	0.001
BF1213	12	1.396	0.633	0.077	0.002	BF1297-O	12	2.692	1.221	0.135	0.004	BF1381	12	1.225	0.556	0.039	0.001
BF1214	12	1.329	0.603	0.077	0.002	BF1298-O	12	1.967	0.892	0.089	0.003	BF1381-O	12	0.583	0.264	0.028	0.001
BF1215	12	0.954	0.433	0.064	0.002	BF1299-O	12	2.208	1.002	0							

BALDWIN WEIGHTS AND VOLUMES

BALDWIN NUMBER	CASE QTY.	WEIGHT (ea.) lbs.	WEIGHT (ea.) kgs.	Volume (ea.) ft ³	Volume (ea.) m ³	BALDWIN NUMBER	CASE QTY.	WEIGHT (ea.) lbs.	WEIGHT (ea.) kgs.	Volume (ea.) ft ³	Volume (ea.) m ³	BALDWIN NUMBER	CASE QTY.	WEIGHT (ea.) lbs.	WEIGHT (ea.) kgs.	Volume (ea.) ft ³	Volume (ea.) m ³
BF1389-O	12	1.579	0.716	0.061	0.002	LL1614	1	3.800	1.724	0.520	0.015	PA1686	1	3.750	1.701	0.650	0.018
BF1390-O	12	1.950	0.885	0.094	0.003	PA1614	1	3.300	1.497	0.527	0.015	PA1687	1	10.600	4.808	2.156	0.061
BF1391-O	12	2.379	1.079	0.131	0.004	LL1615	1	5.050	2.291	0.745	0.021	PA1688	12	0.413	0.187	0.065	0.002
PF1392	12	0.567	0.257	0.071	0.002	PA1615	1	4.700	2.132	0.737	0.021	PA1689	1	2.000	0.907	0.368	0.010
BF1392-SPS KIT	6	1.392	0.631	0.164	0.005	PA1615XP	1	5.100	2.313	0.766	0.022	LL1690-FN	1	1.350	0.612	0.209	0.006
BF1393-SP	12	1.896	0.860	0.089	0.003	PA1618	1	3.200	1.452	0.399	0.011	PA1690-FN	1	1.400	0.635	0.207	0.006
BF1394-SP	12	2.058	0.934	0.091	0.003	PA1619	1	3.500	1.588	0.404	0.011	PA1692	1	2.800	1.270	0.479	0.014
BF1395-O	12	2.371	1.075	0.123	0.003	PA1620	1	4.350	1.973	0.652	0.018	PA1696	6	0.575	0.261	0.115	0.003
BF1395-SP	12	2.940	1.334	0.146	0.004	PA1620-S	1	4.350	1.973	0.656	0.019	PA1697	6	0.442	0.200	0.059	0.002
BF1396	12	1.290	0.585	0.043	0.001	LL1621-2	1	5.300	2.404	0.661	0.019	PA1698	1	1.600	0.726	0.215	0.006
BF1397-SP	12	2.629	1.193	0.124	0.004	PA1621	1	4.100	1.860	0.662	0.019	PA1699-FN	1	3.100	1.406	0.617	0.017
BF1398-O	12	1.430	0.649	0.067	0.002	PA1621-2	1	4.650	2.109	0.661	0.019	PA1700	1	3.500	1.588	0.554	0.016
BF1399-SP	12	2.296	1.041	0.101	0.003	PA1621-S	1	4.250	1.928	0.652	0.018	PA1701	1	4.850	2.200	0.876	0.025
B1400	12	0.513	0.233	0.028	0.001	PA1625	1	5.800	2.631	0.916	0.026	PA1701 ELE	1	4.050	1.837	0.884	0.025
B1402	12	0.563	0.255	0.027	0.001	LL1626-2	1	7.100	3.221	0.987	0.028	PA1701 FOAM	6	0.292	0.132	0.230	0.007
BD1403	6	3.450	1.565	0.151	0.004	PA1626	1	5.450	2.472	0.987	0.028	PA1702	1	8.100	3.674	1.622	0.046
B1405	12	0.679	0.308	0.027	0.001	PA1626-2	1	6.300	2.858	1.091	0.031	PA1702 FOAM	6	0.408	0.185	0.268	0.008
B1406	12	0.546	0.248	0.033	0.001	PA1627	6	0.542	0.246	0.106	0.003	PA1703	1	4.900	2.223	0.878	0.025
B1407	12	0.725	0.329	0.032	0.001	PA1629-S	1	8.250	3.742	1.527	0.043	PA1704	12	0.179	0.081	0.012	**
B1410	12	0.629	0.285	0.032	0.001	LL1630-2	1	9.550	4.332	1.920	0.054	PA1705-2	1	5.400	2.449	1.082	0.031
B1413	12	0.663	0.301	0.033	0.001	PA1630	1	8.200	3.720	1.920	0.054	PA1706	1	9.400	4.264	1.920	0.054
B1416	12	0.779	0.353	0.036	0.001	PA1630-2	1	9.350	4.241	1.913	0.054	PA1706XP	1	9.700	4.400	1.940	0.055
P1418	12	0.467	0.212	0.047	0.001	PA1631-S	1	10.050	4.559	2.352	0.067	PA1707-FN	1	2.300	1.043	0.395	0.011
P1419	12	0.283	0.128	0.049	0.001	PA1632	1	12.400	5.625	2.854	0.081	PA1709	1	3.250	1.474	0.434	0.012
B1421	12	0.679	0.308	0.027	0.001	PA1633	6	1.125	0.510	0.156	0.004	PA1710	1	2.650	1.202	0.321	0.009
B1422	12	0.671	0.304	0.026	0.001	LL1634	1	7.150	3.243	1.163	0.033	PA1712	6	0.442	0.200	0.039	0.001
B1425	12	0.679	0.308	0.027	0.001	PA1634	1	5.260	2.386	1.152	0.033	PA1718	6	0.850	0.386	0.124	0.004
B1428	12	1.250	0.567	0.059	0.002	PA1634XP	1	5.260	2.386	1.076	0.030	PA1719	6	1.275	0.578	0.193	0.005
B1429	12	1.150	0.522	0.040	0.001	PA1635	1	1.600	0.726	0.289	0.008	PA1721	6	1.258	0.571	0.151	0.004
B1430	12	0.712	0.323	0.037	0.001	LL1636-FN	1	4.200	1.905	0.791	0.022	PA1726	1	2.800	1.270	0.447	0.013
B1431	12	0.587	0.266	0.035	0.001	PA1636-FN	1	3.900	1.769	0.784	0.022	PA1735	6	1.408	0.639	0.247	0.007
B1432	12	0.704	0.319	0.034	0.001	LL1637-FN	1	7.550	3.425	1.674	0.047	PA1748	12	0.463	0.210	0.082	0.002
P1433	12	0.142	0.064	0.019	0.001	PA1637-FN	1	7.000	3.175	1.668	0.047	PA1749-FN	1	4.250	1.928	0.876	0.025
B1434	12	1.033	0.469	0.051	0.001	PA1639	6	0.575	0.261	0.092	0.003	PA1750-FN	1	4.700	2.132	0.925	0.026
B1435	12	0.958	0.435	0.035	0.001	PA1641	1	6.100	2.767	1.127	0.032	PA1752-FN	1	1.950	0.885	0.349	0.010
B1438	12	1.004	0.455	0.051	0.001	LL1642-2	1	8.050	3.651	1.323	0.037	PA1753-FN	1	2.600	1.179	0.529	0.015
P1440	12	0.179	0.081	0.034	0.001	PA1642-2	1	7.350	3.334	1.314	0.037	PA1754	1	4.200	1.905	0.683	0.019
B1441	12	1.379	0.626	0.060	0.002	PA1643	1	8.350	3.788	1.920	0.054	PA1755-FN	1	4.300	1.950	0.976	0.028
P1443	12	0.233	0.106	0.048	0.001	PA1644	1	1.050	0.476	0.129	0.004	PA1757	12	0.338	0.153	0.038	0.001
B1444	12	0.608	0.276	0.028	0.001	F1645-DS	12	1.963	0.890	0.229	0.006	PA1758	6	2.125	0.964	0.531	0.015
B1446	12	1.171	0.531	0.047	0.001	V1645-C	7	1.630	0.739	0.211	0.006	PA1763	12	0.167	0.076	0.021	0.001
B1447	12	0.708	0.321	0.028	0.001	LL1646-FN	1	4.950	2.245	0.916	0.026	PA1765	1	8.400	3.810	1.003	0.028
P1510	4	4.525	2.053	0.809	0.023	PA1646	1	4.550	2.064	0.784	0.022	PA1765 FOAM	12	0.288	0.131	0.257	0.007
P1511	4	4.938	2.240	0.916	0.026	PA1646-FN	1	4.500	2.041	0.916	0.026	PA1768	1	8.450	3.833	1.477	0.042
V1520-R	4	5.038	2.285	0.908	0.026	PA1647	1	2.950	1.338	0.487	0.014	PA1769	1	2.700	1.225	0.520	0.015
V1542-C	6	1.350	0.612	0.219	0.006	PA1648	6	0.883	0.401	0.113	0.003	PA1771	1	1.400	0.635	0.220	0.006
V1544-T	16	1.275	0.578	0.163	0.005	LL1649	1	11.250	5.103	2.153	0.061	PA1772	1	2.100	0.953	0.303	0.009
V1560	4	5.012	2.273	0.908	0.026	PA1649	1	10.300	4.672	2.156	0.061	PA1773	1	2.700	1.225	0.417	0.012
P1561	1	7.950	3.606	0.496	0.014	PA1650-FN	1	5.250	2.381	1.226	0.035	PA1774	1	3.550	1.610	0.493	0.014
P1562	1	14.750	6.691	0.906	0.026	PA1653	1	1.500	0.680	0.261	0.007	PA1775	1	3.600	1.633	0.537	0.015
P1563	1	2.500	1.134	0.178	0.005	V1656-O	6	1.667	0.756	0.218	0.006	PA1776	1	4.850	2.200	0.612	0.017
P1565	1	0.450	0.204	0.050	0.001	V1656-T	6	1.825	0.828	0.221	0.006	PA1777	1	4.950	2.245	0.713	0.020
P1566	1	0.450	0.204	0.044	0.001	PA1657	6	1.267	0.575	0.243	0.007	PA1778	1	5.600	2.540	0.752	0.021
P1567	1	6.100	2.767	0.477	0.013	PA1661(3)	6	0.942	0.427	0.139	0.004	PA1779	1	6.500	2.948	0.899	0.025
P1568	1	11.250	5.103	0.726	0.021	PA1663	1	6.350	2.880	1.050	0.030	PA1780	1	6.300	2.858	0.910	0.026
P1575	1	0.800	0.363	0.050	0.001	PA1664	1	2.100	0.953	0.284	0.008	PA1781	1	8.800	3.992	1.145	0.032
P1576	1	2.700	1.225	0.190	0.005	PA1666	12	0.338	0.153	0.039	0.001	PA1782	1	11.150	5.058	1.441	0.041
P1577	1	1.300	0.590	0.095	0.003	LL1667-FN	1	2.150	0.975	0.349	0.010	PA1783	1	12.850	5.829	1.631	0.046
P1578	1	2.850	1.293	0.201	0.006	PA1667-FN	1	2.050	0.930	0.349	0.010	PA1784	1	17.300	7.847	2.143	0.061
PF1584	1	12.650	5.738	0.987	0.028	LL1669	1	8.350	3.788	1.408	0.040	PA1786	6	2.108	0.956	0.525	0.015
PF1585	1	2.100	0.953	0.164	0.005	PA1669	1	7.950	3.606	1.408	0.040	PA1787	1	2.050	0.930	0.282	0.008
PF1587	1	1.100	0.499	0.057	0.002	PA1670	1	4.900	2.223	0.910	0.026	PA1788	1	3.950	1.792	0.557	0.016
PF1589	1	4.100	1.860	0.205	0.006	PA1673	1	4.050	1.837	0.520	0.015	PA1789	1	5.450	2.472	0.756	0.021
PA1600	12	0.050	0.023	0.012	**	PA1674	1	2.500	1.134	0.352	0.010	PA1790	1	7.200	3.266	1.315	0.037
PA1602	1	2.000	0.907	0.288	0.008	PA1675	1	4.600	2.087	0.839	0.024	PA1794-FN	1	2.800	1.270	0.554	0.016
PA1603	12	0.279	0.127	0.039	0.001	LL1676-FN	1	9.250	4.196	2.476	0.070	PA1795	1	3.250	1.474	0.779	0.022
PA1606	1	3.250	1.474	0.652	0.018	PA1676-FN	1	8.400	3.810	2.476	0.070	PA1797	1	5.400	2.449	1.560	0.044
PA1607	1	4.200	1.905	0.869	0.025	PA1679	12	0.467	0.212	0.051	0.001	PA1798	6	2.642	1.198	0.753	0.021
LL1608	1	2.550	1.157	0.284	0.008	PA1680	6	1.033	0.4								

BALDWIN WEIGHTS AND VOLUMES

BALDWIN NUMBER	CASE QTY.	WEIGHT (ea.) lbs.	WEIGHT (ea.) kgs.	Volume (ea.) ft ³	Volume (ea.) m ³	BALDWIN NUMBER	CASE QTY.	WEIGHT (ea.) lbs.	WEIGHT (ea.) kgs.	Volume (ea.) ft ³	Volume (ea.) m ³	BALDWIN NUMBER	CASE QTY.	WEIGHT (ea.) lbs.	WEIGHT (ea.) kgs.	Volume (ea.) ft ³	Volume (ea.) m ³
PA1814	6	0.775	0.352	0.117	0.003	PA1900	1	3.250	1.474	0.487	0.014	PA2037	6	1.158	0.525	0.192	0.005
PA1815	1	12.700	5.761	2.854	0.081	PA1901	1	1.300	0.590	0.233	0.007	PA2038	1	0.800	0.363	0.081	0.002
PA1816	1	8.550	3.878	1.432	0.041	LL1902-FN	1	4.850	2.200	1.133	0.032	SA2039	12	0.137	0.062	0.038	0.001
PA1817	1	3.350	1.520	0.661	0.019	PA1902-FN	1	4.650	2.109	1.048	0.030	PA2041	6	0.950	0.431	0.218	0.006
PA1818	1	10.200	4.627	1.920	0.054	PA1904	1	3.400	1.542	0.617	0.017	PA2042	4	2.625	1.191	0.553	0.016
PA1819	1	4.100	1.860	1.163	0.033	PA1905	1	4.400	1.996	0.856	0.024	PA2044	6	0.908	0.412	0.159	0.004
PA1821	1	1.350	0.612	0.173	0.005	PA1906	1	2.050	0.930	0.333	0.009	SA2047	12	0.167	0.076	0.037	0.001
PA1822-FN	1	3.250	1.474	0.617	0.017	PA1907-FN	1	1.350	0.612	0.196	0.006	PA2050	6	0.642	0.291	0.120	0.003
PA1823	1	8.150	3.697	1.482	0.042	PA1909	12	0.213	0.097	0.039	0.001	PA2051	6	1.542	0.699	0.353	0.010
PA1824	1	6.100	2.767	1.045	0.030	PA1911	1	1.850	0.839	0.484	0.014	PA2052	6	1.592	0.722	0.356	0.010
PA1825	1	3.100	1.406	0.853	0.024	PA1912	1	2.050	0.930	0.462	0.013	PA2053	6	0.717	0.325	0.103	0.003
PA1826	1	2.850	1.293	0.650	0.018	PA1913	1	5.250	2.381	0.884	0.025	PA2061	6	2.750	1.247	0.732	0.021
PA1827	1	5.500	2.495	0.956	0.027	PA1915	12	0.213	0.097	0.034	0.001	PA2063	6	0.908	0.412	0.222	0.006
PA1828	6	1.792	0.813	0.294	0.008	PA1916	1	2.550	1.157	0.432	0.012	PA2064	6	0.850	0.386	0.157	0.004
PA1830-FN	1	1.900	0.862	0.347	0.010	PA1919-FN	1	3.750	1.701	0.791	0.022	PA2065	6	2.225	1.009	0.529	0.015
PA1831	1	3.700	1.678	0.429	0.012	PA1920	1	7.350	3.334	1.315	0.037	PA2067	6	0.658	0.298	0.103	0.003
PA1832	6	0.692	0.314	0.102	0.003	PA1921	1	1.000	0.454	0.092	0.003	PA2067 FOAM	12	0.020	0.009	0.016	**
PA1834	6	0.333	0.151	0.051	0.001	PA1922	1	4.150	1.882	0.652	0.018	PA2068	6	0.725	0.329	0.156	0.004
PA1836	1	1.800	0.816	0.294	0.008	PA1922-FN	1	4.250	1.928	0.750	0.021	PA2068 FOAM	12	0.020	0.009	0.016	**
PA1837-FN	1	4.500	2.041	1.308	0.037	PA1926	1	3.100	1.406	0.480	0.014	PA2069	6	0.750	0.340	0.117	0.003
PA1840	1	4.450	2.019	0.554	0.016	PA1932	1	4.750	2.155	0.736	0.021	PA2069 FOAM	12	0.001	**	0.016	**
PA1841	6	1.517	0.688	0.342	0.010	PA1934	4	2.638	1.197	0.647	0.018	PA2070	6	0.383	0.174	0.036	0.001
PA1845	1	5.900	2.676	0.942	0.027	PA1936	1	14.300	6.486	2.870	0.081	PA2071	6	0.533	0.242	0.106	0.003
LL1846	1	10.600	4.808	1.811	0.051	PA1937	1	4.600	2.087	0.935	0.026	PA2072	6	0.750	0.340	0.103	0.003
PA1846	1	9.200	4.173	1.811	0.051	PA1940	1	3.500	1.588	0.456	0.013	PA2073	6	2.442	1.108	0.532	0.015
PA1846XP	1	7.900	3.583	1.922	0.054	PA1941-FN	1	5.400	2.449	1.163	0.033	PA2074	6	1.292	0.586	0.264	0.007
PA1847-FN	1	9.950	4.513	3.137	0.089	PA1945	1	2.000	0.907	0.235	0.007	PA2075	6	2.067	0.938	0.265	0.007
PA1848	1	4.100	1.860	0.728	0.021	PA1946	6	0.667	0.303	0.110	0.003	PA2076	6	1.375	0.624	0.353	0.010
PA1849	1	3.150	1.429	0.487	0.014	PA1949	6	2.125	0.964	0.435	0.012	PA2077	6	0.983	0.446	0.246	0.007
PA1850-FN	1	3.400	1.542	0.853	0.024	PA1951	6	0.967	0.439	0.113	0.003	PA2079	6	3.325	1.055	0.527	0.015
PA1851	1	3.500	1.588	0.535	0.015	PA1952	1	14.050	6.373	2.426	0.069	PA2081	6	1.858	0.843	0.358	0.010
PA1852	6	1.033	0.469	0.202	0.006	PA1953	1	12.600	5.715	2.022	0.057	PA2083	6	0.592	0.269	0.112	0.003
PA1857	6	0.975	0.442	0.146	0.004	PA1956-FN	1	6.300	2.858	1.538	0.044	SA2084	12	0.121	0.055	0.038	0.001
PA1858	6	0.558	0.253	0.080	0.002	PA1957	1	2.150	0.975	0.444	0.013	SA2085	12	0.179	0.081	0.038	0.001
PA1859	6	0.408	0.185	0.053	0.001	PA1960	1	3.600	1.633	0.461	0.013	PA2091	6	2.550	1.157	0.524	0.015
PA1860	6	1.683	0.763	0.440	0.012	PA1961	1	4.050	1.837	0.462	0.013	PA2092	6	2.392	1.085	0.533	0.015
PA1861	6	2.175	0.987	0.267	0.008	PA1963	6	1.633	0.741	0.230	0.007	PA2093	1	1.950	0.885	0.780	0.022
PA1863	1	8.000	3.629	1.521	0.043	PA1967	1	1.500	0.680	0.233	0.007	PA2094	6	2.450	1.111	0.613	0.017
PA1864-FN	1	7.850	3.561	2.156	0.061	PA1969	6	0.725	0.329	0.137	0.004	PA2095	4	1.638	0.743	0.320	0.009
PA1865-FN	1	0.800	0.363	0.093	0.003	PA1972	1	4.050	1.837	0.456	0.013	PA2096	6	0.625	0.284	0.106	0.003
PA1866	1	3.900	1.769	0.652	0.018	PA1973	6	0.933	0.423	0.103	0.003	PA2099	6	1.158	0.525	0.137	0.004
PA1867	1	4.300	1.950	0.667	0.019	PA1975	1	12.000	5.443	2.703	0.076	PA2100	6	1.392	0.631	0.305	0.009
PA1868	1	2.250	1.021	0.344	0.010	PA1976	1	5.050	2.291	1.071	0.030	PA2101A	6	0.550	0.249	0.113	0.003
PA1873	4	1.700	0.771	0.386	0.011	PA1977-FN	1	6.550	2.971	1.432	0.041	PA2102	6	1.350	0.612	0.325	0.009
V1874-T	4	3.475	1.576	0.540	0.015	PA1978-FN	1	7.600	3.447	1.920	0.054	PA2103	6	0.475	0.215	0.069	0.002
PA1875	12	0.375	0.170	0.060	0.002	PA1979-FN	1	7.850	3.561	2.178	0.062	PA2104	6	0.483	0.219	0.061	0.002
PA1877	1	7.500	3.402	1.325	0.037	PA1980-FN	1	7.400	3.357	1.719	0.049	PA2106	6	1.117	0.507	0.239	0.007
PA1880	1	3.700	1.678	0.853	0.024	PA1981	1	1.850	0.839	0.346	0.010	PA2107	6	1.025	0.465	0.196	0.006
PA1881	1	6.500	2.948	1.174	0.033	PA1982	1	1.650	0.748	0.235	0.007	PA2109	6	0.983	0.446	0.236	0.007
PA1882	1	2.500	1.134	0.328	0.009	PA1985	12	0.346	0.157	0.034	0.001	PA2110	6	2.325	1.055	0.432	0.012
PA1883-FN	1	2.400	1.089	0.493	0.014	PA1986	1	4.150	1.882	0.554	0.016	PA2113	6	1.092	0.495	0.239	0.007
LL1884	1	5.400	2.449	0.842	0.024	PA1986-K	1	8.300	3.765	1.050	0.030	PA2114	6	1.075	0.488	0.154	0.004
PA1884	1	5.100	2.313	0.839	0.024	PA1987	1	3.950	1.792	0.569	0.016	PA2115	6	2.808	1.274	0.666	0.019
PA1884XP	1	5.600	2.540	0.868	0.025	PA1989-FN	1	4.200	1.905	1.164	0.033	PA2116	4	3.100	1.406	0.667	0.019
LL1885	1	8.100	3.674	1.409	0.040	LL1992	1	9.150	4.150	1.622	0.046	PA2117	6	1.400	0.635	0.237	0.007
PA1885	1	7.400	3.357	1.408	0.040	PA1992-FN	1	9.350	4.241	3.136	0.089	PA2121	6	0.175	0.488	0.124	0.004
PA1885XP	1	8.200	3.720	1.442	0.041	PA1995	1	8.550	3.878	1.138	0.032	PA2124	6	1.792	0.813	0.353	0.010
LL1886	1	9.450	4.287	1.622	0.046	PA1996	1	1.950	0.885	0.225	0.006	PA2125	6	1.250	0.567	0.210	0.006
PA1886	1	8.300	3.765	1.622	0.046	PA1997	1	5.800	2.631	0.900	0.025	PA2127	6	0.592	0.269	0.095	0.003
PA1886XP	1	8.300	3.765	1.623	0.046	PA1998	1	1.450	0.658	0.316	0.009	PA2134	6	0.992	0.450	0.158	0.004
PA1888	6	1.833	0.831	0.437	0.012	PA2001	6	1.025	0.465	0.154	0.004	PA2135	6	0.583	0.264	0.100	0.003
PA1889	6	1.625	0.737	0.212	0.006	PA2001 FOAM	12	0.067	0.030	0.041	0.001	PA2136	6	1.108	0.503	0.258	0.007
PA1891	6	1.167	0.529	0.205	0.006	PA2002	6	1.967	0.892	0.542	0.015	PA2138	6	0.583	0.264	0.135	0.004
PA1892-FN	1	5.900	2.676	1.432	0.041	PA2005	6	1.492	0.677	0.267	0.008	PA2139	6	0.992	0.450	0.152	0.004
PA1893	1	3.100	1.406	0.856	0.024	PA2006	6	1.308	0.593	0.266	0.008	PA2139 FOAM	12	0.067	0.030	0.042	0.001
LL1894	1	12.000	5.443	2.232	0.063	PA2007	6	1.458	0.661	0.269	0.008	PA2140	6	0.908	0.412	0.149	0.004
PA1894	1	10.800	4.899	2.232	0.063	PA2008	6	1.792	0.813	0.357	0.010	PA2147	6	1.850	0.839	0.241	0.007
PA1894XP	1	11.500	5.216	2.292	0.065	PA2009	6	1.667	0.756	0.529	0.015	PA2148	6	2.392	1.085	0.749	0.021
LL1895	1	6.450	2.926	1.214	0.034	PA2010	6	1.758	0.797	0.531	0.015	PA2149	6	1.			

BALDWIN WEIGHTS AND VOLUMES

BALDWIN NUMBER	CASE QTY.	WEIGHT (ea.) lbs.	WEIGHT (ea.) kgs.	Volume (ea.) ft ³	Volume (ea.) m ³	BALDWIN NUMBER	CASE QTY.	WEIGHT (ea.) lbs.	WEIGHT (ea.) kgs.	Volume (ea.) ft ³	Volume (ea.) m ³	BALDWIN NUMBER	CASE QTY.	WEIGHT (ea.) lbs.	WEIGHT (ea.) kgs.	Volume (ea.) ft ³	Volume (ea.) m ³
PA2158	6	0.867	0.393	0.153	0.004	PA2320-FN	1	2.950	1.338	0.617	0.017	PA2390	1	25.500	11.567	4.817	0.136
SA2159	12	0.154	0.070	0.038	0.001	PA2321	1	0.900	0.408	0.142	0.004	PA2391	1	2.250	1.021	0.321	0.009
PA2160	6	0.592	0.269	0.072	0.002	PA2322	1	2.250	1.021	0.288	0.008	PA2392	1	3.150	1.429	0.486	0.014
PA2162	6	0.867	0.393	0.153	0.004	PA2323	1	1.250	0.567	0.135	0.004	LL2393	1	15.150	6.872	4.491	0.127
PA2163	6	0.967	0.439	0.125	0.004	LL2326	1	9.500	4.309	2.292	0.065	PA2393	1	14.550	6.600	4.559	0.129
PA2164	6	0.867	0.393	0.116	0.003	PA2326	1	8.250	3.742	2.260	0.064	PA2394	1	17.500	7.938	3.755	0.106
PA2167	6	1.692	0.767	0.194	0.005	PA2326XP	1	9.100	4.128	2.276	0.064	PA2395	1	20.900	9.480	3.908	0.111
PA2168	6	1.017	0.461	0.107	0.003	PA2328	1	3.550	1.610	1.050	0.030	PA2396	1	10.200	4.627	2.702	0.076
PA2169	6	0.933	0.423	0.100	0.003	PA2329	1	4.450	2.019	0.509	0.014	PA2397	1	3.550	1.610	0.859	0.024
PA2171	6	0.775	0.352	0.192	0.005	LL2330	1	8.450	3.833	1.606	0.045	PA2398	1	10.650	4.831	2.184	0.062
PA2178	6	1.283	0.582	0.169	0.005	PA2330	1	7.450	3.379	1.618	0.046	PA2399	1	14.600	6.623	1.630	0.046
PA2181	6	0.675	0.306	0.107	0.003	PA2331	1	1.750	0.794	0.233	0.007	PA2401	1	3.950	1.792	0.767	0.022
PA2182	1	1.150	0.522	0.174	0.005	PA2332	1	1.050	0.476	0.189	0.005	PA2402	1	1.750	0.794	0.328	0.009
PA2183	1	3.500	1.588	0.520	0.015	LL2333	1	16.450	7.462	3.136	0.089	PA2403	1	7.000	3.175	1.126	0.032
PA2189	6	0.983	0.446	0.122	0.003	PA2333	1	13.100	5.942	3.136	0.089	PA2404	1	1.800	0.816	0.219	0.006
PA2191	6	0.958	0.435	0.142	0.004	PA2335	6	0.583	0.264	0.087	0.002	PA2405	1	4.400	1.996	0.615	0.017
PA2192	6	2.058	0.934	0.351	0.010	PA2337	6	3.217	1.459	0.527	0.015	PA2406	1	10.450	4.740	1.630	0.046
PA2193	6	0.742	0.337	0.140	0.004	PA2338-FN	1	4.750	2.155	1.052	0.030	PA2407	1	3.950	1.792	0.446	0.013
PA2194	6	1.500	0.680	0.311	0.009	PA2339	1	5.700	2.586	1.019	0.029	PA2408	1	4.100	1.860	0.437	0.012
PA2196	6	1.133	0.514	0.137	0.004	PA2340	1	1.650	0.748	0.219	0.006	PA2409	1	9.000	4.082	1.820	0.052
PA2200	6	0.767	0.348	0.097	0.003	PA2341	1	3.700	1.678	0.650	0.018	PA2410	1	3.700	1.678	0.853	0.024
PA2201	6	0.625	0.284	0.130	0.004	PA2342	1	1.300	0.590	0.170	0.005	PA2411	1	3.800	1.724	0.352	0.010
PA2204	6	0.590	0.268	0.090	0.003	PA2343	1	8.500	3.856	1.126	0.032	PA2412	1	5.150	2.336	0.780	0.022
PA2207	6	0.558	0.253	0.114	0.003	LL2344-FN	1	1.800	0.816	0.310	0.009	PA2413	1	0.950	0.431	0.180	0.005
PA2208	6	0.658	0.298	0.151	0.004	PA2344-FN	1	1.700	0.771	0.317	0.009	PA2414	1	7.500	3.402	1.315	0.037
PA2212	6	0.833	0.378	0.131	0.004	PA2345	1	9.000	4.082	2.013	0.057	PA2415	1	2.900	1.315	0.512	0.014
PA2214	6	0.892	0.405	0.127	0.004	PA2346	1	3.450	1.565	0.836	0.024	PA2417-FN	1	9.050	4.105	1.668	0.047
PA2215	1	1.100	0.499	0.212	0.006	PA2347	6	0.892	0.405	0.100	0.003	LL2418-FN	1	3.500	1.588	0.662	0.019
PA2216	6	0.558	0.253	0.152	0.004	PA2349-FN	1	8.750	3.969	1.719	0.049	PA2418-FN	1	3.150	1.429	0.654	0.019
PA2218	6	0.950	0.431	0.082	0.002	PA2350	1	11.250	5.103	1.396	0.040	PA2419	1	0.900	0.408	0.277	0.008
PA2221	6	0.700	0.318	0.127	0.004	PA2351	1	3.450	1.565	0.512	0.014	PA2420	1	2.800	1.293	0.436	0.012
PA2222	6	0.217	0.098	0.038	0.001	PA2352	1	3.950	1.792	0.392	0.011	PA2421	1	4.850	2.200	0.745	0.021
PA2223	6	0.517	0.235	0.075	0.002	PA2353	1	3.800	1.724	0.407	0.012	PA2422	1	2.350	1.066	0.292	0.008
PA2223 FOAM	12	0.020	0.009	0.017	**	PA2354	1	2.750	1.247	0.455	0.013	PA2423	1	3.300	1.497	0.395	0.011
PA2224	6	0.425	0.193	0.056	0.002	PA2355	1	3.050	1.383	0.419	0.012	LL2425	1	7.250	3.289	1.214	0.034
PA2225	6	0.292	0.132	0.040	0.001	PA2357	1	12.700	5.761	2.870	0.081	PA2425	1	6.850	3.107	1.214	0.034
PA2226	6	0.625	0.284	0.093	0.003	LL2358	1	7.450	3.379	1.163	0.033	LL2426-FN	1	4.250	1.928	0.949	0.027
PA2229	6	0.567	0.257	0.128	0.004	PA2358	1	7.000	3.175	1.163	0.033	PA2426-FN	1	3.900	1.769	0.949	0.027
PA2230	6	0.717	0.325	0.140	0.004	PA2359	1	4.150	1.882	1.163	0.033	PA2427	1	1.500	0.680	0.294	0.008
PA2231	6	0.650	0.295	0.089	0.003	LL2360-FN	1	2.650	1.202	0.469	0.013	PA2428	1	11.500	5.216	1.811	0.051
PA2232	6	1.470	0.667	0.213	0.006	PA2360-FN	1	2.500	1.134	0.468	0.013	PA2429	1	10.550	4.785	1.622	0.046
PA2233	6	3.058	1.387	0.568	0.016	LL2361	1	12.100	5.489	2.590	0.073	PA2430	1	8.050	3.651	1.540	0.044
PA2234	6	1.175	0.533	0.162	0.005	PA2361	1	10.600	4.808	2.590	0.073	PA2431	1	3.650	1.656	0.626	0.018
PA2235	6	1.100	0.499	0.219	0.006	PA2361XP	1	10.850	4.922	2.561	0.072	PA2432	1	1.150	0.522	0.175	0.005
PA2237	6	0.758	0.344	0.105	0.003	PA2362	1	4.200	1.905	0.824	0.023	PA2433	1	5.250	2.381	1.622	0.046
PA2240	6	0.792	0.359	0.304	0.009	LL2363	1	27.950	12.678	4.960	0.140	PA2434	1	6.000	2.722	1.214	0.034
PA2241	6	1.250	0.567	0.193	0.005	PA2363	1	24.460	11.095	4.960	0.140	PA2435	1	2.400	1.089	0.421	0.012
PA2243	6	0.850	0.386	0.106	0.003	PA2363XP	1	25.750	11.680	5.160	0.146	PA2436	1	3.900	1.769	0.473	0.013
PA2244	6	1.033	0.469	0.216	0.006	PA2364	1	8.050	3.651	1.937	0.055	PA2437	1	10.000	4.536	2.332	0.063
PA2256	6	0.408	0.185	0.025	0.001	PA2367	1	6.450	2.926	1.269	0.036	PA2438	1	6.050	2.744	0.990	0.028
PA2257	6	0.808	0.367	0.093	0.003	PA2368	1	2.100	0.953	0.407	0.012	LL2439	1	9.950	4.513	1.600	0.045
PA2258	6	0.317	0.144	0.062	0.002	PA2369	1	4.300	1.950	0.615	0.017	PA2439	1	9.000	4.082	1.593	0.045
PA2260	1	1.750	0.794	0.321	0.009	PA2370	1	1.150	0.522	0.146	0.004	PA2440	1	4.100	1.860	0.484	0.014
PA2300	1	7.000	3.175	1.408	0.040	PA2371	1	5.900	2.676	0.869	0.025	PA2441	1	7.700	3.493	1.552	0.044
PA2301	1	2.400	1.089	0.395	0.011	PA2372	1	1.950	0.885	0.344	0.010	PA2442	1	7.350	3.334	1.473	0.042
PA2302-FN	1	3.700	1.678	0.839	0.024	PA2374	1	6.850	3.107	0.942	0.027	PA2443	1	2.150	0.975	0.342	0.010
PA2303	1	1.600	0.726	0.247	0.007	PA2375	1	11.600	5.262	1.457	0.041	PA2444	1	15.520	7.040	1.994	0.056
PA2304-FN	1	4.300	1.950	0.869	0.025	PA2376	1	8.650	3.924	2.007	0.057	PA2445	1	9.150	4.150	1.432	0.041
PA2305	1	1.200	0.544	0.247	0.007	PA2377	1	8.000	3.629	1.540	0.044	PA2446	1	2.300	1.043	0.434	0.012
PA2306	4	1.412	0.640	0.201	0.006	PA2378	1	2.450	1.111	0.527	0.015	LL2447-FN	1	10.500	4.763	2.476	0.070
PA2307	1	3.500	1.588	0.617	0.017	PA2379	1	5.000	2.268	0.780	0.022	PA2447-FN	1	9.750	4.423	2.476	0.070
PA2308	4	1.838	0.834	0.324	0.009	PA2379-K	1	6.850	3.107	0.987	0.028	PA2448	1	3.400	1.542	0.417	0.012
PA2310	1	4.000	1.814	0.767	0.022	PA2380-FN	1	2.300	1.043	0.486	0.014	PA2450	1	6.000	2.722	0.658	0.019
LL2312	1	9.350	4.241	1.614	0.046	PA2381	1	0.800	0.363	0.146	0.004	PA2451	1	5.550	2.517	0.962	0.027
PA2312	1	8.800	3.992	1.614	0.046	PA2382	1	7.400	3.357	1.473	0.042	PA2452	1	2.100	0.953	0.429	0.012
PA2313	1	8.150	3.697	2.017	0.057	PA2383	1	2.100	0.953	0.320	0.009	LL2453	1	25.700	11.658	4.960	0.140
PA2314	1	3.350	1.520	0.460	0.013	LL2384	1	8.600	3.901	1.521	0.043	PA2453	1	25.000	11.340	4.960	0.140
PA2315	1	7.650	3.470	1.492	0.042	PA2384	1	7.750	3.515	1.553	0.044	PA2453XP	1	25.350	11.499	5.085	0.144
PA2316	1	9.100	4.128	1.508	0.043	PA2384XP	1	8.150	3.697	1.520	0.043	PA2454</					

BALDWIN WEIGHTS AND VOLUMES

BALDWIN NUMBER	CASE QTY.	WEIGHT (ea.) lbs.	WEIGHT (ea.) kgs.	Volume (ea.) ft ³	Volume (ea.) m ³	BALDWIN NUMBER	CASE QTY.	WEIGHT (ea.) lbs.	WEIGHT (ea.) kgs.	Volume (ea.) ft ³	Volume (ea.) m ³	BALDWIN NUMBER	CASE QTY.	WEIGHT (ea.) lbs.	WEIGHT (ea.) kgs.	Volume (ea.) ft ³	Volume (ea.) m ³
LL2458	1	21.450	9.730	3.406	0.096	PA2529	1	6.650	3.016	1.275	0.036	PA2605	1	2.700	1.225	0.456	0.013
PA2458	1	18.150	8.233	3.406	0.096	PA2530	1	2.150	0.975	0.353	0.010	PA2606	1	5.200	2.359	1.163	0.033
PA2459	1	6.200	2.812	1.214	0.034	PA2531	1	6.400	2.903	1.288	0.036	PA2607	1	2.100	0.953	0.368	0.010
PA2460	1	2.300	1.043	0.395	0.011	PA2532	1	8.100	3.674	1.473	0.042	LL2608	1	14.950	6.781	2.870	0.081
PA2461	1	8.750	3.969	1.540	0.044	PA2533	1	10.650	4.831	2.156	0.061	PA2608	1	13.050	5.919	2.885	0.082
PA2462	1	2.750	1.247	0.532	0.015	PA2534	1	2.900	1.315	0.373	0.011	LL2609	1	9.650	4.377	2.129	0.060
PA2463	1	3.650	1.656	0.421	0.012	PA2535	1	0.750	0.340	0.192	0.005	PA2609	1	8.500	3.856	2.129	0.060
PA2464	1	5.350	2.427	0.602	0.017	PA2536	1	1.450	0.658	0.211	0.006	PA2610	1	4.800	2.177	0.771	0.022
PA2465	1	5.350	2.427	0.780	0.022	PA2538	1	7.150	3.243	1.214	0.034	PA2611	1	8.250	3.742	1.408	0.040
PA2466	1	6.300	2.858	1.045	0.030	PA2539	1	2.400	1.089	0.395	0.011	PA2612	1	9.350	4.241	1.682	0.048
PA2467	1	2.450	1.111	0.436	0.012	PA2540	1	4.500	2.041	0.949	0.027	PA2613	1	1.650	0.748	0.212	0.006
PA2468	1	13.350	6.056	2.232	0.063	PA2541-FN	1	2.450	1.111	0.461	0.013	PA2614	1	12.400	5.625	2.522	0.071
PA2469	1	1.500	0.680	0.301	0.009	PA2542	1	3.700	1.678	0.683	0.019	PA2615	1	3.800	1.724	0.824	0.023
PA2472	6	2.917	1.323	0.741	0.021	PA2544	1	14.800	6.713	2.854	0.081	PA2616	1	6.550	2.971	1.163	0.033
PA2473	1	6.000	2.722	0.987	0.028	PA2545	1	2.000	0.907	0.335	0.009	PA2616XP	1	6.550	2.971	1.076	0.030
PA2474	1	5.350	2.427	0.949	0.027	PA2546	1	6.250	2.835	0.945	0.027	PA2617	1	4.700	2.132	0.595	0.017
PA2475	1	7.550	3.425	1.244	0.035	PA2547	1	1.450	0.658	0.238	0.007	LL2618	1	13.600	6.169	2.424	0.069
PA2476	6	0.375	0.170	0.060	0.002	PA2548	1	6.100	2.767	0.987	0.028	PA2618	1	13.050	5.919	2.424	0.069
PA2477	6	0.683	0.310	0.101	0.003	PA2549	1	6.800	3.084	1.315	0.037	PA2619	1	4.450	2.019	0.455	0.013
PA2478	1	11.950	5.421	3.136	0.089	PA2550	1	5.200	2.359	0.796	0.023	PA2620	1	6.400	2.903	1.244	0.035
PA2479	1	2.150	0.975	0.229	0.006	PA2551	1	4.100	1.860	0.650	0.018	PA2621	1	2.600	1.179	0.479	0.014
PA2480	1	4.500	2.041	0.949	0.027	PA2552	1	5.500	2.495	0.990	0.028	PA2622	1	0.850	0.386	0.134	0.004
PA2481	1	3.300	1.497	0.749	0.021	PA2553	1	4.450	2.019	0.695	0.020	PA2623	1	5.850	2.654	1.288	0.036
LL2482	1	7.500	3.402	1.288	0.036	PA2554	1	7.350	3.334	0.845	0.024	PA2624	1	10.100	4.581	2.156	0.061
PA2482	1	6.900	3.130	1.288	0.036	PA2554 FOAM	6	0.258	0.117	0.148	0.004	PA2625	1	4.050	1.837	0.796	0.023
PA2483	6	3.430	1.556	0.739	0.021	PA2555	1	5.200	2.359	0.869	0.025	PA2626	1	2.750	1.247	0.303	0.009
PA2484	1	4.950	2.245	0.853	0.024	PA2556	1	6.300	2.858	1.214	0.034	PA2627	1	4.800	2.177	0.869	0.025
PA2485	1	6.300	2.858	0.574	0.016	LL2557	1	5.450	2.472	0.791	0.022	PA2628	1	9.650	4.377	2.077	0.059
PA2486	1	2.050	0.930	0.296	0.008	PA2557	1	5.000	2.268	0.784	0.022	PA2629	1	14.050	6.373	3.755	0.106
PA2487	1	0.600	0.272	0.162	0.005	PA2558	1	3.400	1.542	0.652	0.018	PA2630	1	3.650	1.656	0.867	0.025
PA2488-FN	1	2.200	0.998	0.344	0.010	LL2559	1	18.600	8.437	3.362	0.095	PA2631	1	12.200	5.534	2.532	0.072
PA2489	1	0.650	0.295	0.087	0.002	PA2559	1	15.700	7.122	3.362	0.095	PA2632	1	13.200	5.988	2.956	0.084
PA2490	1	11.900	5.398	2.523	0.071	LL2562	1	15.550	7.053	3.362	0.095	PA2633-FN	1	3.600	1.633	0.839	0.024
PA2491	1	3.850	1.746	0.827	0.023	PA2562	1	13.750	6.237	3.362	0.095	PA2634	1	1.300	0.590	0.227	0.006
LL2493	1	11.200	5.080	2.092	0.059	PA2562XP	1	15.500	7.031	3.372	0.095	PA2635-FN	1	3.950	1.792	0.796	0.023
PA2493	1	10.200	4.627	2.092	0.059	PA2563	1	6.050	2.744	1.614	0.046	PA2636	1	1.350	0.612	0.262	0.007
PA2494	1	8.700	3.946	1.600	0.045	PA2564	1	15.700	7.122	2.059	0.058	PA2637	1	3.150	1.429	0.456	0.013
PA2495	1	5.050	2.291	0.920	0.026	PA2566	1	5.000	2.268	0.780	0.022	PA2638	1	4.650	2.109	0.438	0.012
PA2496	1	2.200	0.998	0.235	0.007	PA2567	1	5.600	2.540	0.910	0.026	PA2640	1	9.150	4.150	2.022	0.057
PA2497	1	1.950	0.885	0.235	0.007	PA2568	1	2.100	0.953	0.349	0.010	PA2641	1	5.750	2.608	0.949	0.027
PA2498	1	5.800	2.631	0.486	0.014	PA2569	1	6.200	2.812	1.624	0.046	LL2642	1	10.350	4.695	1.423	0.040
PA2499	1	1.750	0.794	0.175	0.005	PA2570	1	0.950	0.431	0.140	0.004	PA2642	1	9.500	4.309	1.432	0.041
PA2500	1	6.800	3.084	1.382	0.039	PA2571	1	9.400	4.264	2.232	0.063	PA2643	1	9.350	4.241	1.622	0.046
PA2502	1	3.100	1.406	0.433	0.012	PA2572	1	3.450	1.565	0.451	0.013	PA2644	1	1.000	0.454	0.182	0.005
LL2503	1	9.500	4.309	2.092	0.059	PA2573	1	10.750	4.876	2.748	0.078	PA2645	1	4.200	1.905	0.760	0.022
PA2503	1	8.800	3.992	2.092	0.059	PA2573XP	1	12.050	5.466	2.710	0.077	PA2646	1	1.600	0.726	0.233	0.007
PA2504	1	4.450	2.019	0.765	0.022	PA2574	1	4.900	2.223	1.244	0.035	PA2647	1	6.000	2.722	1.173	0.033
LL2507	1	25.150	11.408	4.146	0.117	LL2575	1	3.050	1.383	0.296	0.008	PA2648	1	14.100	6.396	2.843	0.080
PA2507	1	23.450	10.637	4.146	0.117	PA2575	1	3.000	1.361	0.288	0.008	PA2649	1	6.700	3.039	1.678	0.047
PA2508	1	6.450	2.926	1.674	0.047	PA2576	1	2.200	0.998	0.241	0.007	PA2650	1	17.650	8.006	2.250	0.064
PA2509	1	7.650	3.470	1.482	0.042	PA2577	1	6.900	3.130	1.408	0.040	PA2651	1	4.350	1.973	0.693	0.020
PA2510	1	2.550	1.157	0.427	0.012	PA2578	1	2.500	1.134	0.466	0.013	PA2652	1	1.250	0.567	0.183	0.005
PA2511	1	4.100	1.860	0.617	0.017	PA2579	1	3.050	1.383	0.623	0.018	PA2653	1	12.520	5.679	2.564	0.073
PA2512	1	1.400	0.635	0.241	0.007	PA2580	1	13.650	6.192	2.532	0.072	PA2653 FOAM	6	0.350	0.159	0.424	0.012
PA2513	1	2.050	0.930	0.333	0.009	PA2581	1	4.900	2.223	0.693	0.020	PA2654	1	9.650	4.377	2.022	0.057
PA2514	1	0.700	0.318	0.080	0.002	LL2582	1	9.250	4.196	1.623	0.046	PA2655	1	3.300	1.497	0.683	0.019
PA2515	1	13.950	6.328	2.555	0.072	PA2582	1	7.900	3.583	1.552	0.044	PA2656	1	5.250	2.381	0.780	0.022
PA2516	1	17.150	7.779	3.201	0.091	PA2583	1	3.050	1.383	0.540	0.015	PA2657-FN	1	2.200	0.998	0.352	0.010
PA2517	1	12.800	5.806	2.476	0.070	PA2585	1	4.500	2.041	0.688	0.019	PA2658	1	9.250	4.196	2.092	0.059
LL2518	1	11.150	5.058	2.022	0.057	PA2586	1	1.850	0.839	0.245	0.007	PA2659	1	5.550	2.517	0.827	0.023
PA2518	1	9.900	4.491	2.178	0.062	PA2587	1	2.500	1.134	0.460	0.013	PA2660	1	8.850	4.014	2.077	0.059
PA2518XP	1	9.450	4.287	2.151	0.061	PA2588	1	0.850	0.386	0.090	0.003	LL2661	1	7.100	3.221	1.679	0.048
PA2519	1	4.000	1.814	0.853	0.024	PA2589-FN	1	2.100	0.953	0.355	0.010	PA2661	1	6.100	2.767	1.640	0.046
PA2520	1	5.650	2.563	0.869	0.025	PA2591	1	7.700	3.493	1.473	0.042	PA2662	1	1.900	0.862	0.229	0.006
LL2521	1	7.450	3.379	1.214	0.034	PA2592	1	2.100	0.953	0.288	0.008	PA2663-FN	1	11.750	5.330	3.136	0.089
PA2521	1	7.050	3.198	1.219	0.034	PA2593	1	9.150	4.150	1.412	0.040	PA2664	1	5.350	2.427	1.071	0.030
PA2522	1	2.350	1.066	0.395	0.011	PA2595	1	13.650	6.192	3.136	0.089	PA2665	1	1.950	0.885	0.349	0.010
PA2523	1	4.350	1.973	0.853	0.024	PA2596	1	4.650	2.109	0.987	0.028	PA2666	1	3.250	1.474	0.486	0.014
PA2524-FN	1	4.250	1.928	0.949	0.027	PA2598	1	4.750	2.155	0.745	0.021	LL2667	1				

BALDWIN WEIGHTS AND VOLUMES

BALDWIN NUMBER	CASE QTY.	WEIGHT (ea.) lbs.	WEIGHT (ea.) kgs.	Volume (ea.) ft ³	Volume (ea.) m ³	BALDWIN NUMBER	CASE QTY.	WEIGHT (ea.) lbs.	WEIGHT (ea.) kgs.	Volume (ea.) ft ³	Volume (ea.) m ³	BALDWIN NUMBER	CASE QTY.	WEIGHT (ea.) lbs.	WEIGHT (ea.) kgs.	Volume (ea.) ft ³	Volume (ea.) m ³
PA2673	1	6.050	2.744	1.045	0.030	PA2752	1	3.150	1.429	0.363	0.010	PA2843	1	5.200	2.359	0.777	0.022
PA2674	1	2.350	1.066	0.421	0.012	PA2753	1	3.600	1.633	0.429	0.012	PA2844	1	3.400	1.542	0.396	0.011
PA2675	1	12.250	5.557	2.703	0.076	PA2754	1	3.050	1.383	0.518	0.015	PA2845	1	2.950	1.338	0.410	0.012
LL2676	1	10.400	4.717	2.022	0.057	PA2755	1	7.900	3.583	1.471	0.042	PA2846-FN	1	2.100	0.953	0.347	0.010
PA2676	1	9.050	4.105	2.022	0.057	PA2756	1	3.800	1.724	0.650	0.018	PA2847	1	7.500	3.402	1.473	0.042
PA2676XP	1	9.050	4.105	2.023	0.057	PA2757	1	9.600	4.355	1.614	0.046	PA2848	1	9.100	4.128	1.719	0.049
PA2677	1	5.950	2.699	1.214	0.034	PA2759	1	3.650	1.656	0.607	0.017	PA2849	1	16.850	7.643	4.599	0.130
PA2678	1	0.750	0.340	0.068	0.002	PA2761	1	5.150	2.336	0.963	0.027	PA2851	1	7.150	3.243	1.540	0.044
PA2679	1	18.500	8.392	3.755	0.106	PA2763	1	1.750	0.794	0.402	0.011	PA2852	1	7.950	3.606	1.811	0.051
PA2680	1	11.900	5.398	2.559	0.072	PA2767	1	2.400	1.089	0.317	0.009	PA2853	1	2.850	1.293	0.533	0.015
PA2684-FN	1	2.750	1.247	0.512	0.014	PA2771	1	10.550	4.785	1.113	0.031	PA2854	1	10.700	4.854	1.985	0.056
LL2685	1	11.500	5.216	2.027	0.057	PA2772	1	2.700	1.225	0.354	0.010	PA2855	1	12.500	5.670	2.774	0.079
PA2687	1	2.050	0.930	0.351	0.010	PA2773	1	2.800	1.270	0.650	0.018	PA2856	1	5.100	2.313	0.862	0.024
LL2688	1	5.900	2.676	1.045	0.030	PA2774	1	11.300	5.126	1.920	0.054	PA2857	1	13.000	5.897	2.879	0.081
PA2688	1	5.750	2.608	1.045	0.030	PA2775	1	3.000	1.361	0.650	0.018	PA2858	1	1.850	0.839	0.179	0.005
PA2689	1	0.900	0.408	0.128	0.004	PA2776	1	9.300	4.218	1.830	0.052	PA2859-FN	1	4.650	2.109	1.163	0.033
PA2690	1	10.450	4.740	1.450	0.041	PA2777	1	6.350	2.880	1.052	0.030	PA2860-FN	1	1.750	0.794	0.236	0.007
PA2691	1	12.550	5.693	2.048	0.058	PA2778-FN	1	1.100	0.499	0.151	0.004	PA2861	1	0.500	0.227	0.051	0.001
PA2692	1	5.950	2.699	0.996	0.028	LL2779	1	5.000	2.268	0.773	0.022	PA2862	1	0.550	0.249	0.065	0.002
PA2693	1	7.400	3.357	0.862	0.024	PA2779	1	4.650	2.109	0.776	0.022	PA2862 FOAM	12	0.020	0.009	0.022	0.001
PA2694	1	13.150	5.965	2.452	0.069	PA2781	1	12.750	5.783	2.423	0.069	RS2863	1	3.800	1.724	0.750	0.021
PA2696	1	8.800	3.992	1.426	0.040	PA2782	1	6.850	3.107	1.674	0.047	RS2863XP	1	3.750	1.701	0.750	0.021
PA2698	1	13.800	6.260	2.523	0.071	PA2783	1	4.450	2.019	0.901	0.025	PA2865	1	5.600	2.540	0.869	0.025
PA2699	1	3.750	1.701	0.447	0.013	PA2784	1	6.250	2.835	1.477	0.042	PA2866	1	6.100	2.767	0.942	0.027
PA2700	1	0.750	0.340	0.135	0.004	PA2785	1	5.400	2.449	1.293	0.037	PA2867-FN	1	10.700	4.854	2.484	0.070
PA2701	1	1.850	0.839	0.247	0.007	PA2786	1	8.400	3.810	1.540	0.044	PA2869	1	3.700	1.678	0.520	0.015
PA2702	1	0.700	0.318	0.111	0.003	PA2787	1	3.200	1.452	0.824	0.023	PA2870-FN	1	7.900	3.583	1.939	0.055
PA2703	1	7.650	3.470	1.678	0.047	PA2788	1	4.500	2.041	0.949	0.027	PA2871	1	2.650	1.202	0.486	0.014
PA2704	1	9.300	4.218	2.023	0.057	PA2789	1	8.300	3.765	1.126	0.032	PA2874	1	19.050	8.641	2.651	0.075
PA2705	1	8.850	4.014	1.950	0.055	PA2790-FN	1	2.750	1.247	0.456	0.013	PA2875	1	17.250	7.825	2.561	0.072
PA2706	1	1.650	0.748	0.345	0.010	PA2791	1	0.800	0.363	0.158	0.004	PA2876	1	14.000	6.350	1.785	0.051
PA2707	1	7.800	3.538	1.550	0.044	PA2792	1	1.750	0.794	0.233	0.007	PA2877-FN	1	2.950	1.338	0.518	0.015
PA2708	1	3.900	1.769	0.841	0.024	PA2793	1	4.550	2.064	0.693	0.020	PA2878	1	2.250	1.021	0.656	0.019
PA2709	1	3.850	1.746	0.654	0.019	PA2794	1	1.600	0.726	0.227	0.006	PA2880	1	4.600	2.087	0.695	0.020
PA2710	1	2.200	0.998	0.323	0.009	PA2796	1	14.000	6.350	3.031	0.086	PA2881	1	2.250	1.021	0.468	0.013
PA2711	1	1.050	0.476	0.180	0.005	PA2797	1	10.050	4.559	1.803	0.051	PA2883	1	3.800	1.724	0.805	0.023
PA2712	1	3.150	1.429	0.518	0.015	PA2798	12	0.525	0.238	0.033	0.001	PA2884	12	1.963	0.890	0.205	0.006
PA2713	1	10.150	4.604	2.436	0.069	PA2799	1	14.150	6.418	2.781	0.079	PA2885	1	1.600	0.726	0.184	0.005
PA2714	1	4.050	1.837	0.827	0.023	PA2800-FN	1	2.950	1.338	0.683	0.019	PA2887-FN	1	4.550	2.064	1.245	0.035
PA2715	1	7.400	3.357	1.678	0.047	PA2801	1	11.950	5.421	3.131	0.089	PA2888	1	2.650	1.202	0.320	0.009
PA2716	1	2.300	1.043	0.359	0.010	PA2803	1	3.250	1.474	0.347	0.010	PA2889	1	0.250	0.113	0.056	0.002
PA2717	1	0.800	0.363	0.100	0.003	PA2804	1	3.350	1.520	0.349	0.010	PA2890	1	1.150	0.522	0.149	0.004
PA2718	1	9.000	4.082	2.096	0.059	PA2805	1	4.700	2.132	0.520	0.015	PA2891	1	4.750	2.155	0.724	0.020
PA2719	1	2.750	1.247	0.522	0.015	PA2806	1	5.600	2.540	0.969	0.027	PA2895	1	2.500	1.134	0.444	0.013
PA2721	1	13.800	6.260	2.258	0.064	PA2807	1	1.250	0.567	0.267	0.008	PA2896	1	1.400	0.635	0.214	0.006
PA2722	1	19.200	8.709	2.781	0.079	PA2812	1	9.500	4.309	1.432	0.041	PA2897	1	4.200	1.905	0.767	0.022
PA2723	1	20.150	9.140	3.591	0.102	PA2813	1	7.850	3.561	1.550	0.044	PA2899	1	3.350	1.520	0.910	0.026
PA2724	1	22.200	10.070	2.955	0.084	PA2814	1	2.050	0.930	0.385	0.011	PA2900	1	11.250	5.103	2.781	0.079
PA2725	1	1.800	0.816	0.225	0.006	PA2815	1	3.400	1.542	0.708	0.020	PA2902	1	11.600	5.262	2.532	0.072
PA2726	1	5.200	2.359	0.838	0.024	PA2816	1	4.450	2.019	0.520	0.015	PA2903	1	4.250	1.928	0.849	0.024
PA2727	1	2.500	1.134	0.330	0.009	PA2817	1	1.750	0.794	0.427	0.012	PA2904	1	2.050	0.930	0.288	0.008
PA2728	1	0.950	0.431	0.180	0.005	PA2818	1	3.500	1.588	0.769	0.022	PA2905	1	2.500	1.134	0.352	0.010
PA2729	1	12.150	5.511	2.532	0.072	PA2819	1	7.100	3.221	0.963	0.027	PA2906	1	1.350	0.612	0.297	0.008
PA2730	1	1.900	0.862	0.219	0.006	PA2820	1	4.800	2.177	0.978	0.028	PA2909	1	3.600	1.633	0.520	0.015
PA2731	1	27.150	12.315	4.196	0.119	PA2821	1	7.800	3.538	1.846	0.052	PA2912	1	1.450	0.658	0.166	0.005
PA2732	1	8.650	3.924	2.168	0.061	PA2822	1	1.250	0.567	0.256	0.007	PA2913	1	2.350	1.066	0.333	0.009
PA2733	1	4.550	2.064	0.925	0.026	PA2823	1	2.200	0.998	0.225	0.006	PA2914	1	12.700	5.761	2.532	0.072
PA2734	1	15.350	6.963	3.755	0.106	PA2824	1	2.900	1.315	0.288	0.008	PA2915	1	5.400	2.449	0.824	0.023
PA2735	1	3.600	1.633	0.743	0.021	PA2825	1	3.000	1.361	0.404	0.011	PA2932	1	2.250	1.021	0.324	0.009
PA2736	1	1.550	0.703	0.250	0.007	PA2826	1	2.850	1.293	0.445	0.013	PA2933	1	0.010	0.005	0.005	**
PA2737	1	2.350	1.066	0.321	0.009	PA2827	1	3.600	1.633	0.414	0.012	PA2935	1	4.450	2.019	0.501	0.014
PA2738	1	2.950	1.338	0.512	0.014	PA2828	1	3.500	1.588	0.410	0.012	PA2936	1	2.250	1.021	0.420	0.012
PA2739	1	2.600	1.179	0.421	0.012	PA2829	1	4.750	2.155	0.520	0.015	PA2938	1	3.000	1.361	0.745	0.021
PA2740	1	2.100	0.953	0.331	0.009	PA2830	1	5.600	2.540	0.630	0.018	PA2942	1	7.850	3.561	1.154	0.033
PA2742	1	7.050	3.198	1.473	0.042	PA2831	1	9.400	4.264	1.477	0.042	PA2944-FN	1	1.350	0.612	0.237	0.007
PA2743	1	2.100	0.953	0.387	0.011	PA2832	1	0.600	0.272	0.090	0.003	LL2945	1	8.350	3.788	1.676	0.047
PA2744	1	14.700	6.668	2.870	0.081	PA2833	1	10.100	4.581	1.622	0.046	PA2945	1	7.200	3.266	1.702	0.048
PA2745	1	4.600	2.087	0.938	0.027	PA2834	1	3.300	1.497	0.693	0.020	PA2946	1	3.100	1.406	0.460	0.013
PA2746	1	15.550	7.053	3.760	0.106	PA2835	1	1.300	0.590	0.200	0.006	PA2947	1				

BALDWIN WEIGHTS AND VOLUMES

BALDWIN NUMBER	CASE QTY.	WEIGHT (ea.) lbs.	WEIGHT (ea.) kgs.	Volume (ea.) ft ³	Volume (ea.) m ³	BALDWIN NUMBER	CASE QTY.	WEIGHT (ea.) lbs.	WEIGHT (ea.) kgs.	Volume (ea.) ft ³	Volume (ea.) m ³	BALDWIN NUMBER	CASE QTY.	WEIGHT (ea.) lbs.	WEIGHT (ea.) kgs.	Volume (ea.) ft ³	Volume (ea.) m ³
PA2953	1	6.100	2.767	0.949	0.027	PA3478	1	6.650	3.016	1.383	0.039	PA3555	1	6.450	2.926	0.734	0.021
PA2954-FN	1	4.250	1.928	0.813	0.023	PA3478XP	1	5.700	2.586	1.367	0.039	PA3556	1	11.950	5.421	1.276	0.036
PA2955	1	16.100	7.303	2.202	0.062	PA3479	1	4.650	2.109	0.869	0.025	PA3557-FN	1	1.350	0.612	0.245	0.007
PA2956-FN	1	13.250	6.010	3.136	0.089	PA3480	1	3.400	1.542	0.658	0.019	PA3558	1	8.050	3.651	1.639	0.046
PA2957	1	3.750	1.701	0.856	0.024	PA3481	1	2.350	1.066	0.299	0.008	PA3559	1	10.850	4.922	2.022	0.057
PA2958	1	1.850	0.839	0.517	0.015	PA3482	1	1.500	0.680	0.153	0.004	PA3560	1	14.100	6.396	3.406	0.096
PA2959-FN	1	12.050	5.466	3.136	0.089	PA3483	1	5.300	2.404	0.538	0.015	PA3562	1	6.100	2.767	0.827	0.023
PA2960	1	3.400	1.542	0.692	0.020	PA3484	1	13.800	6.260	2.532	0.072	PA3563	1	14.100	6.396	2.782	0.079
PA2961-FN	1	4.600	2.087	0.877	0.025	PA3486	1	11.400	5.171	1.950	0.055	PA3565	1	0.400	0.181	0.051	0.001
PA2962	1	11.700	5.307	2.380	0.067	PA3487	1	3.800	1.724	0.617	0.017	PA3566	1	2.900	1.315	0.617	0.017
PA2963	1	9.200	4.173	1.614	0.046	PA3491	1	4.350	1.973	0.694	0.020	PA3568	1	22.400	10.161	6.272	0.177
PA2964	1	4.300	1.950	0.836	0.024	PA3492	1	1.100	0.499	0.221	0.006	PA3569	1	16.400	7.439	3.760	0.106
PA2967	1	3.300	1.497	0.856	0.024	PA3493	1	13.700	6.214	1.453	0.041	PA3572	1	7.850	3.561	1.244	0.035
PA2968-FN	1	3.350	1.520	0.555	0.016	PA3494	1	1.950	0.885	0.612	0.017	PA3573	1	11.700	5.307	2.232	0.063
PA2970	1	3.550	1.610	0.572	0.016	PA3495	1	1.900	0.862	0.237	0.007	PA3576	1	17.500	7.938	5.730	0.162
PA2971	1	5.750	2.608	1.335	0.038	PA3496	1	17.450	7.915	4.529	0.128	PA3578	1	2.150	0.975	0.342	0.010
PA2973	1	14.000	6.350	2.782	0.079	PA3497	1	13.650	6.192	3.354	0.095	PA3579	1	13.050	5.919	2.532	0.072
PA2976-FN	1	2.350	1.066	0.512	0.014	PA3498	1	6.450	2.926	1.698	0.048	PA3580	1	17.150	7.779	4.227	0.120
PA2977-FN	1	4.000	1.814	0.750	0.021	PA3499	1	9.350	4.241	2.023	0.057	PA3581	1	6.100	2.767	1.288	0.036
PA2978	1	0.950	0.431	0.158	0.004	RS3501	1	1.250	0.567	0.229	0.006	PA3584	1	17.950	8.142	4.599	0.130
PA2980	1	2.400	1.089	0.597	0.017	RS3502	1	3.800	1.724	0.741	0.021	PA3587	1	16.000	7.258	3.419	0.097
PA2981	1	10.400	4.717	2.022	0.057	RS3503	1	1.250	0.567	0.231	0.007	PA3588	1	14.600	6.623	3.549	0.100
PA2982	1	9.600	4.355	1.964	0.056	RS3504	1	5.400	2.449	1.180	0.033	PA3595	1	18.250	8.278	3.817	0.108
PA2984	1	1.200	0.544	0.313	0.009	RS3504XP	1	5.400	2.449	1.180	0.033	PA3597	1	6.550	2.971	0.869	0.025
PA2988	1	17.300	7.847	4.111	0.116	RS3505	1	1.400	0.635	0.413	0.012	PA3598	1	8.050	3.651	1.315	0.037
PA2989	1	14.700	6.668	4.285	0.121	RS3506	1	6.450	2.926	1.426	0.040	PA3600	1	6.150	2.790	1.045	0.030
HSG3077	1	1.850	0.839	0.347	0.010	RS3506XP	1	6.400	2.903	1.426	0.040	PA3601	1	0.650	0.295	0.127	0.004
HSG3078	1	1.900	0.862	0.352	0.010	RS3507	1	2.000	0.907	0.421	0.012	PA3602	1	9.800	4.445	2.156	0.061
HSG3079	1	5.300	2.404	0.800	0.023	RS3508	1	5.500	2.495	1.192	0.034	PA3604	1	8.150	3.697	1.920	0.054
HSG3080	1	5.250	2.381	0.818	0.023	RS3508XP	1	5.300	2.404	1.192	0.034	PA3605	1	5.500	2.495	0.949	0.027
AB3349	1	0.850	0.386	0.047	0.001	RS3509	1	2.400	1.089	0.486	0.014	PA3606	1	14.500	6.577	2.600	0.074
PA3404	1	11.600	5.262	2.794	0.079	RS3510	1	6.800	3.084	1.639	0.046	PA3607-FN	1	2.900	1.315	0.512	0.014
PA3405	1	3.400	1.542	0.607	0.017	RS3510XP	1	7.000	3.175	1.614	0.046	PA3608-FN	1	3.250	1.474	0.512	0.014
PA3406-FN	1	2.400	1.089	0.361	0.010	RS3511	1	3.200	1.452	0.856	0.024	PA3609	1	5.250	2.381	0.856	0.024
PA3408	1	11.350	5.148	2.783	0.079	RS3512	1	7.300	3.311	1.629	0.046	PA3610	1	1.500	0.680	0.323	0.009
PA3411-FN	1	2.400	1.089	0.429	0.012	RS3513	1	2.750	1.247	0.739	0.021	PA3611	1	20.900	9.480	5.623	0.159
PA3412	1	0.350	0.159	0.065	0.002	RS3514	1	8.650	3.924	1.927	0.055	PA3612	1	1.350	0.612	0.201	0.006
PA3414	6	0.775	0.352	0.125	0.004	RS3514XP	1	8.750	3.969	1.887	0.053	PA3613	1	1.450	0.658	0.120	0.003
PA3415	1	4.300	1.950	0.741	0.021	RS3515	1	3.050	1.383	0.867	0.025	PA3614	1	16.100	7.303	3.614	0.102
PA3416	1	1.500	0.680	0.322	0.009	RS3516	1	5.950	2.699	1.343	0.038	PA3627	1	3.950	1.792	0.535	0.015
PA3417	1	1.700	0.771	0.337	0.010	RS3517	1	5.300	2.404	1.250	0.035	PA3628	1	0.900	0.408	0.174	0.005
PA3419	6	0.475	0.215	0.078	0.002	RS3517XP	1	5.200	2.359	1.233	0.035	PA3629	1	5.050	2.291	0.949	0.027
PA3420	1	2.950	1.338	0.402	0.011	RS3518	1	7.300	3.311	1.615	0.046	PA3630-FN	1	4.850	2.200	1.232	0.035
PA3421	1	4.750	2.155	0.537	0.015	RS3518XP	1	7.400	3.357	1.628	0.046	PA3631	1	1.750	0.794	0.288	0.008
PA3430	1	1.550	0.703	0.328	0.009	RS3519	1	2.400	1.089	0.456	0.013	PA3632	1	0.600	0.272	0.105	0.003
PA3435-FN	1	2.000	0.907	0.324	0.009	RS3520	1	4.300	1.950	0.964	0.027	PA3633	1	34.200	15.513	7.671	0.217
PA3438	1	3.600	1.633	0.467	0.013	RS3521	1	1.600	0.726	0.307	0.009	PA3633 FOAM	1	1.200	0.544	1.047	0.030
PA3439-FN	1	4.350	1.973	0.949	0.027	RS3528	1	1.950	0.885	0.402	0.011	PA3636	1	2.750	1.247	0.330	0.009
PA3440	1	2.400	1.089	0.274	0.008	RS3529	1	0.650	0.295	0.125	0.004	PA3637	1	24.700	11.204	4.960	0.140
PA3442	1	3.200	1.452	0.369	0.010	RS3530	1	9.150	4.150	2.182	0.062	PA3638	1	15.500	7.031	4.526	0.128
PA3446	1	3.800	1.724	0.779	0.022	RS3530XP	1	9.250	4.196	2.182	0.062	PA3640	1	8.250	3.742	1.516	0.043
PA3447	1	2.600	1.179	0.486	0.014	RS3531	1	2.900	1.315	0.853	0.024	PA3643	1	0.550	0.249	0.094	0.003
PA3448	1	4.450	2.019	0.768	0.022	RS3532	1	4.700	2.132	0.947	0.027	PA3644	1	8.750	3.969	1.903	0.054
PA3449	1	6.150	2.790	1.299	0.037	RS3533	1	1.700	0.771	0.344	0.010	PA3645	1	4.850	2.200	0.736	0.021
PA3452	1	9.050	4.105	1.785	0.051	RS3534	1	13.550	6.146	2.847	0.081	PA3650	1	2.400	1.089	0.359	0.010
PA3453	1	9.050	4.105	1.634	0.046	RS3535	1	1.550	0.703	0.293	0.008	PA3651-FN	1	2.050	0.930	0.234	0.007
PA3457	1	1.350	0.612	0.155	0.004	RS3536	1	2.050	0.930	0.402	0.011	PA3652	1	9.150	4.150	2.163	0.061
PA3458	1	13.100	5.942	2.782	0.079	RS3537	1	0.650	0.295	0.127	0.004	PA3653	1	3.400	1.542	0.441	0.012
PA3460	1	4.850	2.200	0.856	0.024	RS3538	1	3.850	1.746	0.833	0.024	PA3654	1	1.300	0.590	0.212	0.006
PA3461	1	15.200	6.895	3.407	0.096	RS3539	1	8.350	3.788	1.974	0.056	PA3655	1	6.600	2.994	1.062	0.030
PA3463	1	16.800	7.620	3.395	0.096	RS3539XP	1	8.250	3.742	1.990	0.056	PA3656	1	2.600	1.179	0.460	0.013
PA3464	1	11.150	5.058	2.532	0.072	RS3540	1	3.600	1.633	0.796	0.023	PA3657	1	1.850	0.839	0.333	0.009
PA3466-FN	1	2.800	1.270	0.512	0.014	RS3541	1	0.900	0.408	0.236	0.007	PA3658	1	2.600	1.179	0.289	0.008
PA3467	1	4.700	2.132	0.856	0.024	RS3542	1	1.750	0.794	0.298	0.008	PA3660-FN	1	3.400	1.542	0.661	0.019
PA3469	1	5.650	2.563	0.910	0.026	RS3543	1	0.500	0.227	0.125	0.004	PA3664-FN	1	1.150	0.522	0.211	0.006
PA3470	1	2.350	1.066	0.421	0.012	RS3544	1	2.450	1.111	0.398	0.011	PA3667-FN	1	2.150	0.975	0.348	0.010
PA3471	1	2.100	0.953	0.349	0.010	RS3545	1	0.600	0.272	0.129	0.004	PA3668	1	3.850	1.746	0.853	0.024
PA3472	1	0.800	0.363	0.096	0.003	RS3547	1	0.300	0.136	0.051	0.001	PA3669-FN	1	4.300	1.950	0.862	0.024
PA3472-FN	1	0.800	0.363	0.127	0.004	RS3548	1	5.950	2.699								

BALDWIN WEIGHTS AND VOLUMES

BALDWIN NUMBER	CASE QTY.	WEIGHT (ea.) lbs.	WEIGHT (ea.) kgs.	Volume (ea.) ft ³	Volume (ea.) m ³	BALDWIN NUMBER	CASE QTY.	WEIGHT (ea.) lbs.	WEIGHT (ea.) kgs.	Volume (ea.) ft ³	Volume (ea.) m ³	BALDWIN NUMBER	CASE QTY.	WEIGHT (ea.) lbs.	WEIGHT (ea.) kgs.	Volume (ea.) ft ³	Volume (ea.) m ³
PA3679	1	0.800	0.363	0.072	0.002	PA3761-FN	1	2.200	0.998	0.346	0.010	PA3850	1	6.650	3.016	1.192	0.034
PA3680	1	0.400	0.181	0.227	0.006	PA3763	6	1.400	0.635	0.242	0.007	PA3851	1	1.750	0.794	0.213	0.006
PA3681	1	3.750	1.701	0.535	0.015	RS3764	1	9.550	4.332	2.418	0.068	PA3852-FN	1	3.450	1.565	0.717	0.020
PA3682	1	0.700	0.318	0.112	0.003	PA3765	1	12.150	5.511	2.365	0.067	PA3853-FN	1	3.000	1.361	0.622	0.018
PA3683	1	1.050	0.476	0.178	0.005	PA3766	1	8.250	3.742	1.326	0.038	PA3854-FN	1	5.350	2.427	1.408	0.040
PA3684	1	0.750	0.340	0.094	0.003	PA3767	1	11.500	5.216	2.300	0.065	PA3856	1	1.700	0.771	0.321	0.009
PA3685	1	0.900	0.408	0.128	0.004	PA3768	1	15.450	7.008	2.783	0.079	PA3855-FN	1	7.700	3.493	1.622	0.046
PA3686	1	0.900	0.408	0.125	0.004	PA3772	1	14.550	6.600	3.406	0.096	PA3857	1	2.550	1.157	0.684	0.019
PA3687	1	0.650	0.295	0.174	0.005	PA3773	6	0.867	0.393	0.201	0.006	PA3859	1	3.550	1.610	0.547	0.015
PA3688	1	10.050	4.559	1.820	0.052	PA3774	1	2.350	1.066	0.407	0.012	PA3860	1	7.950	3.606	1.890	0.053
PA3689	1	2.650	1.202	0.469	0.013	PA3775	1	6.450	2.926	1.048	0.030	PA3861	1	4.150	1.882	1.001	0.028
PA3690	1	4.200	1.905	0.709	0.020	PA3777	1	1.050	0.476	0.231	0.007	PA3862-FN	1	6.800	3.084	1.422	0.040
PA3691	1	7.150	3.243	1.678	0.047	PA3778	1	2.000	0.907	0.328	0.009	PA3863	1	1.550	0.703	0.288	0.008
PA3697	6	1.783	0.809	0.234	0.007	PA3779-FN	1	3.400	1.542	0.700	0.020	PA3864	1	5.850	2.654	1.163	0.033
PA3698	1	3.350	1.520	0.486	0.014	PA3780	1	10.250	4.649	1.811	0.051	PA3865	1	3.600	1.633	0.951	0.027
PA3699	1	8.250	3.742	1.421	0.040	PA3781	1	2.100	0.953	0.240	0.007	PA3867	1	3.500	1.588	0.591	0.017
RS3700	1	9.750	4.423	2.426	0.069	PA3782	1	2.250	1.021	0.371	0.010	PA3868	1	3.500	1.588	0.781	0.022
RS3700XP	1	10.000	4.536	2.324	0.066	PA3783	1	1.550	0.703	0.199	0.006	PA3869	1	3.250	1.474	0.616	0.017
RS3701	1	4.150	1.882	1.056	0.030	PA3785-FN	1	1.750	0.794	0.325	0.009	RS3870	1	8.650	3.924	2.038	0.058
RS3703	1	0.500	0.227	0.125	0.004	PA3786-FN	1	10.300	4.672	3.136	0.089	RS3871	1	3.000	1.361	0.681	0.019
RS3704	1	0.900	0.408	0.122	0.003	PA3787	1	4.600	2.087	1.141	0.032	PA3872	12	1.470	0.667	0.631	0.018
RS3705	1	0.350	0.159	0.051	0.001	PA3790	1	3.400	1.542	0.572	0.016	PA3873	12	1.121	0.508	0.525	0.015
RS3706	1	2.100	0.953	0.538	0.015	PA3791-FN	1	2.250	1.021	0.352	0.010	PA3874	1	5.000	2.268	0.758	0.021
RS3707	1	1.900	0.862	0.340	0.010	PA3792	1	1.100	0.499	0.123	0.003	PA3875-FN	1	2.450	1.111	1.422	0.012
RS3708	1	2.200	0.998	0.421	0.012	PA3793	1	2.850	1.293	0.496	0.014	PA3876	1	11.950	5.421	2.489	0.070
RS3709	1	0.750	0.340	0.316	0.009	PA3794	1	10.000	4.536	1.682	0.048	PA3877	1	3.250	1.474	0.457	0.013
RS3710	1	5.050	2.291	1.299	0.037	PA3795	1	1.050	0.476	0.127	0.004	PA3878	1	2.900	1.315	0.395	0.011
RS3711	1	2.100	0.953	0.450	0.013	PA3796	1	5.000	2.268	0.750	0.021	PA3879-FN	1	3.000	1.361	0.484	0.014
RS3712	1	8.450	3.833	1.995	0.056	PA3797	1	1.450	0.658	0.299	0.008	PA3880	6	0.725	0.329	0.107	0.003
RS3713	1	3.600	1.633	0.949	0.027	PA3798	1	2.350	1.066	0.215	0.006	PA3881	1	2.600	1.179	0.427	0.012
RS3714	1	8.750	3.969	2.022	0.057	PA3800	1	14.850	6.736	2.153	0.061	RS3882	1	3.200	1.452	0.693	0.020
RS3715	1	0.600	0.272	0.092	0.003	PA3801-FN	1	2.000	0.907	0.352	0.010	RS3882XP	1	2.950	1.338	0.637	0.018
RS3716	1	0.900	0.408	0.134	0.004	PA3802	1	2.700	1.225	0.210	0.006	RS3883	1	0.950	0.431	0.173	0.005
RS3717	1	2.100	0.953	0.532	0.015	PA3803	1	2.850	1.293	0.433	0.012	RS3884	1	4.100	1.860	0.848	0.024
RS3718	1	9.150	4.150	1.950	0.055	PA3804	1	1.450	0.658	0.226	0.006	RS3885	1	1.300	0.590	0.219	0.006
RS3719	1	2.800	1.270	0.838	0.024	PA3805-FN	1	1.800	0.816	0.312	0.009	PA3886	1	1.550	0.703	0.289	0.008
RS3720	1	8.700	3.946	2.321	0.066	PA3806	1	16.900	7.666	3.406	0.096	PA3887	1	12.300	5.579	2.532	0.072
RS3721	1	4.150	1.882	1.071	0.030	PA3807	1	5.000	2.268	0.652	0.018	RS3888	1	8.250	3.742	1.937	0.055
RS3722	1	1.850	0.839	0.421	0.012	PA3808-FN	1	6.250	2.835	1.473	0.042	PA3889	1	4.550	2.064	1.280	0.036
RS3724	1	7.850	3.561	1.677	0.047	PA3809	1	2.000	0.907	0.339	0.010	PA3890	6	2.233	1.013	0.381	0.011
RS3726	1	9.000	4.082	2.022	0.057	PA3810	1	6.000	2.722	1.785	0.051	PA3891	1	12.700	5.761	2.022	0.057
RS3727	1	7.650	3.470	1.859	0.053	PA3811-FN	1	1.250	0.567	0.223	0.006	PA3892	1	11.800	5.352	2.184	0.062
RS3728	1	9.200	4.173	2.355	0.067	PA3812	1	0.300	0.136	0.059	0.002	PA3893	1	3.900	1.769	0.853	0.024
RS3729	1	3.300	1.497	0.824	0.023	PA3814	1	13.000	5.897	1.373	0.039	PA3894	1	2.800	1.270	0.527	0.015
RS3730	1	7.250	3.289	1.909	0.054	PA3815	1	12.500	5.670	1.403	0.040	PA3895-FN	1	0.700	0.318	0.090	0.003
RS3731	1	4.250	1.928	1.076	0.030	PA3816	1	2.150	0.975	0.358	0.010	PA3896	1	3.050	1.383	0.532	0.015
RS3732	1	1.800	0.816	0.339	0.010	PA3817	1	0.700	0.318	0.135	0.004	PA3897	1	2.300	1.043	0.392	0.011
RS3733	1	3.850	1.746	0.868	0.025	PA3818-FN	1	1.800	0.816	0.333	0.009	PA3898	1	5.850	2.654	1.280	0.036
RS3734	1	4.050	1.837	0.882	0.025	PA3819	1	0.300	0.136	0.085	0.002	PA3899	1	2.600	1.179	0.819	0.023
RS3734XP	1	4.100	1.860	0.858	0.024	PA3820-FN	1	1.700	0.771	0.298	0.008	PA3900	1	1.900	0.862	0.381	0.011
RS3735	1	4.000	1.814	0.512	0.014	PA3821	1	1.550	0.703	0.246	0.007	PA3901	6	0.767	0.348	0.125	0.004
RS3736	1	4.150	1.882	0.781	0.022	PA3822	6	1.192	0.541	0.171	0.005	PA3901 FOAM	12	0.083	0.038	0.029	0.001
RS3737	1	1.450	0.658	0.300	0.008	PA3823	6	1.483	0.673	0.248	0.007	PA3902	1	5.700	2.586	1.315	0.037
RS3738	1	9.400	4.264	2.232	0.063	PA3824	1	3.250	1.474	0.455	0.013	PA3903	1	1.800	0.816	0.372	0.011
RS3739	1	3.700	1.678	0.856	0.024	PA3825	6	0.842	0.382	0.135	0.004	PA3904	1	14.950	6.781	3.664	0.104
RS3740	1	8.250	3.742	1.997	0.057	RS3826	1	9.450	4.287	2.410	0.068	PA3905	1	10.650	4.831	3.448	0.098
RS3741	1	2.700	1.225	0.858	0.024	RS3827	1	3.400	1.542	0.838	0.024	PA3906	1	6.100	2.767	1.045	0.030
RS3743	1	6.900	3.130	1.678	0.047	PA3828	1	1.600	0.726	0.207	0.006	PA3907	1	10.700	4.854	1.676	0.047
RS3744	1	7.650	3.470	1.609	0.046	PA3829	1	1.800	0.816	0.209	0.006	PA3908	1	1.900	0.862	0.284	0.008
RS3744XP	1	7.700	3.493	1.609	0.046	PA3832	1	3.150	1.429	0.617	0.017	PA3909	1	0.800	0.363	0.095	0.003
RS3745	1	2.300	1.043	0.532	0.015	PA3833	1	1.850	0.839	0.282	0.008	PA3910-FN	1	3.350	1.520	0.554	0.016
RS3746	1	2.350	1.066	0.398	0.011	PA3834	6	2.000	0.901	0.083	0.002	PA3911	1	0.800	0.363	0.152	0.004
RS3747	1	0.550	0.249	0.121	0.003	PA3835	6	0.183	0.083	0.081	0.002	PA3914	1	7.650	3.470	1.299	0.037
RS3749	1	9.400	4.264	2.245	0.064	PA3836	6	1.283	0.582	0.285	0.008	PA3915	1	2.450	1.111	0.401	0.011
RS3750	1	5.650	2.563	1.223	0.035	PA3837	1	1.800	0.816	0.299	0.008	PA3916	1	10.600	4.808	2.022	0.057
PA3752	1	4.000	1.814	0.607	0.017	PA3838	1	12.200	5.534	2.274	0.064	PA3917	1	0.700	0.318	0.116	0.003
PA3753	1	2.250	1.021	0.292	0.008	PA3839	6	0.675	0.306	0.125	0.004	PA3918	1	6.650	3.016	1.074	0.030
PA3754	1	13.650	6.192	2.129	0.060	PA3840	6	0.442	0.200	0.072	0.002	PA3919	1	2.100	0.953	0.404	0.011
PA3755	1	3.750	1.701	0.630	0.018	PA3842	1	2.050	0.930	0.413	0.012	RS3920					

BALDWIN WEIGHTS AND VOLUMES

BALDWIN NUMBER	CASE QTY.	WEIGHT (ea.) lbs.	WEIGHT (ea.) kgs.	Volume (ea.) ft ³	Volume (ea.) m ³	BALDWIN NUMBER	CASE QTY.	WEIGHT (ea.) lbs.	WEIGHT (ea.) kgs.	Volume (ea.) ft ³	Volume (ea.) m ³	BALDWIN NUMBER	CASE QTY.	WEIGHT (ea.) lbs.	WEIGHT (ea.) kgs.	Volume (ea.) ft ³	Volume (ea.) m ³
RS3926	1	11.100	5.035	2.701	0.076	PA4041	1	1.600	0.726	0.200	0.006	PA4158	6	0.433	0.196	0.066	0.002
RS3927	1	3.300	1.497	0.830	0.023	PA4042	6	1.240	0.562	0.163	0.005	PA4159	6	0.817	0.371	0.216	0.006
PA3928	1	4.500	2.041	0.652	0.018	PA4043	6	0.492	0.223	0.073	0.002	PA4160	6	0.683	0.310	0.123	0.003
PA3929	6	0.692	0.314	0.104	0.003	PA4044	6	0.658	0.298	0.089	0.003	RS4161	1	1.200	0.544	0.201	0.006
RS3930	1	0.200	0.091	0.020	0.001	PA4045	6	0.667	0.303	0.132	0.004	PA4162	6	1.467	0.665	0.228	0.006
PA3931	6	0.275	0.125	0.108	0.003	PA4046	6	0.983	0.446	0.126	0.004	PA4163	6	0.983	0.446	0.133	0.004
PA3932	1	18.650	8.460	4.489	0.127	PA4048	6	0.725	0.329	0.199	0.006	PA4164	6	1.200	0.544	0.218	0.006
PA3933	1	11.200	5.080	3.240	0.092	PA4049	6	0.758	0.344	0.087	0.002	PA4165	1	1.300	0.590	0.193	0.005
RS3934	1	3.850	1.746	0.853	0.024	PA4050	6	0.775	0.352	0.081	0.002	PA4166	6	0.833	0.378	0.115	0.003
RS3935	1	1.300	0.590	0.317	0.009	PA4060	6	0.917	0.416	0.127	0.004	PA4167	6	0.700	0.318	0.107	0.003
RS3936	1	6.900	3.130	1.805	0.051	PA4069	6	0.942	0.427	0.196	0.006	PA4168	1	0.550	0.249	0.271	0.008
PA3937	1	2.100	0.953	0.263	0.007	PA4070	6	1.533	0.695	0.445	0.013	PA4169	6	0.808	0.367	0.210	0.006
PA3938	1	9.150	4.150	1.616	0.046	PA4071	6	0.925	0.420	0.407	0.012	PA4170	6	1.042	0.473	0.244	0.007
PA3939	1	1.250	0.567	0.179	0.005	PA4072	6	2.350	1.066	0.439	0.012	PA4171	1	1.550	0.703	0.314	0.009
RS3940	1	1.750	0.794	0.333	0.009	PA4073	6	1.400	0.635	0.298	0.008	PA4172	6	1.183	0.537	0.210	0.006
PA3941	6	0.775	0.352	0.123	0.003	PA4075	6	1.067	0.484	0.404	0.011	PA4173	1	1.000	0.454	0.235	0.007
RS3942	1	1.300	0.590	0.211	0.006	PA4077	6	1.117	0.507	0.238	0.007	PA4174	6	0.875	0.397	0.218	0.006
RS3943	1	0.400	0.181	0.090	0.003	PA4078	6	1.117	0.507	0.170	0.005	PA4175	6	0.725	0.329	0.130	0.004
PA3944	1	3.900	1.769	0.848	0.024	PA4079	6	0.992	0.450	0.126	0.004	PA4176	6	0.675	0.306	0.129	0.004
PA3945	1	2.500	1.134	0.370	0.010	PA4081	6	1.033	0.469	0.124	0.004	PA4177	6	0.833	0.378	0.112	0.003
PA3946	1	6.700	3.039	1.288	0.036	PA4082	6	1.158	0.525	0.157	0.004	PA4178	6	0.925	0.420	0.134	0.004
PA3947	1	2.650	1.202	0.321	0.009	PA4084	6	0.717	0.325	0.075	0.002	PA4179	6	0.933	0.423	0.143	0.004
PA3948	1	6.500	2.948	1.622	0.046	PA4085	6	0.650	0.295	0.144	0.004	PA4180	6	0.625	0.284	0.172	0.005
PA3949	1	1.850	0.839	0.367	0.010	PA4088	6	0.733	0.332	0.275	0.008	PA4181	6	0.508	0.230	0.122	0.003
PA3950	1	0.650	0.295	0.097	0.003	PA4089	6	0.842	0.382	0.260	0.007	PA4182	6	0.908	0.412	0.153	0.004
PA3951	1	9.050	4.105	2.103	0.060	PA4091	6	0.867	0.393	0.198	0.006	PA4183	6	0.800	0.363	0.134	0.004
RS3952	1	8.500	3.856	1.938	0.055	PA4092	6	0.708	0.321	0.151	0.004	PA4184	6	0.750	0.340	0.114	0.003
PA3953	6	0.500	0.227	0.083	0.002	PA4093	6	1.925	0.873	0.243	0.007	PA4185	6	0.933	0.423	0.153	0.004
RS3954	1	1.100	0.499	0.175	0.005	PA4094	6	0.125	0.057	0.035	0.001	PA4187	12	0.010	0.005	0.008	**
PA3956	1	2.600	1.179	0.775	0.022	PA4096	6	0.642	0.291	0.271	0.008	PA4188	6	0.433	0.196	0.156	0.004
PA3957	6	0.550	0.249	0.071	0.002	PA4099	6	0.567	0.257	0.094	0.003	RS4189	1	0.850	0.386	0.212	0.006
PA3957 FOAM	12	0.020	0.009	0.017	**	PA4100	6	0.533	0.242	0.066	0.002	PA4190	6	1.025	0.465	0.169	0.005
PA3958	6	0.500	0.227	0.137	0.004	PA4102	6	0.867	0.393	0.122	0.003	PA4191	6	1.033	0.469	0.168	0.005
PA3959	1	0.500	0.227	0.065	0.002	PA4103	6	0.975	0.442	0.095	0.003	PA4192	6	0.742	0.337	0.163	0.005
PA3961	1	2.350	1.066	0.407	0.012	PA4104	6	0.867	0.393	0.131	0.004	PA4193	6	1.150	0.522	0.168	0.005
BA3964(4)	1	14.650	6.645	4.370	0.124	PA4105	6	0.825	0.374	0.153	0.004	PA4194	6	0.450	0.204	0.157	0.004
BA3965(4)	1	23.180	10.514	8.233	0.233	PA4106	6	1.308	0.593	0.223	0.006	PA4195 KIT	6	0.633	0.287	0.155	0.004
PA3966	1	2.150	0.975	0.512	0.014	PA4107	6	0.883	0.401	0.122	0.003	PA4196	6	0.525	0.238	0.158	0.004
PA3967	6	1.208	0.548	0.242	0.007	PA4108	6	0.950	0.431	0.113	0.003	PA4197	6	0.683	0.310	0.085	0.002
PA3969	1	1.850	0.839	0.231	0.007	PA4109	6	0.600	0.272	0.086	0.002	PA4198	6	0.617	0.280	0.157	0.004
PA3970	6	1.308	0.593	0.232	0.007	PA4110	6	1.558	0.707	0.256	0.007	PA4199	6	0.508	0.230	0.154	0.004
RS3971	1	3.300	1.497	0.650	0.018	PA4111	6	1.158	0.525	0.240	0.007	PA4303	6	1.033	0.469	0.175	0.005
PA3972	1	2.200	0.998	0.319	0.009	PA4112	6	0.475	0.215	0.133	0.004	PA4304	6	0.892	0.405	0.271	0.008
PA3973	1	0.800	0.363	0.093	0.003	PA4113	6	1.625	0.737	0.216	0.006	PA4305	6	0.517	0.235	0.130	0.004
RS3974	1	6.200	2.812	1.277	0.036	PA4114	6	0.725	0.329	0.129	0.004	PA4306	6	1.042	0.473	0.173	0.005
RS3975	1	2.450	1.111	0.838	0.024	PA4118	1	1.050	0.476	0.200	0.006	PA4307	6	0.783	0.355	0.170	0.005
PA3978	1	11.300	5.126	1.622	0.046	PA4120	6	1.017	0.461	0.162	0.005	PA4308	6	0.783	0.355	0.238	0.007
PA3979	1	2.300	1.043	0.425	0.012	PA4121	6	0.775	0.352	0.133	0.004	PA4309	6	0.942	0.427	0.123	0.003
PA3980	6	0.742	0.337	0.184	0.005	PA4123	6	0.700	0.318	0.094	0.003	PA4310	6	1.267	0.575	0.226	0.006
PA3983-FN	6	0.633	0.287	0.103	0.003	PA4124	6	0.767	0.348	0.110	0.003	PA4311	6	0.642	0.291	0.105	0.003
PA3984	1	3.100	1.406	0.617	0.017	PA4126	6	0.975	0.442	0.169	0.005	PA4312	6	0.767	0.348	0.122	0.003
PA3985	1	0.900	0.408	0.143	0.004	PA4127	6	1.617	0.733	0.207	0.006	PA4313	6	0.667	0.303	0.105	0.003
PA3986	6	0.333	0.151	0.093	0.003	PA4128	6	0.817	0.371	0.104	0.003	PA4314	6	0.590	0.268	0.140	0.004
PA3987	1	15.600	7.076	2.293	0.065	PA4129	6	1.267	0.575	0.223	0.006	SA4315	12	0.137	0.062	0.039	0.001
RS3988	1	1.600	0.726	0.321	0.009	RS4130	1	0.900	0.408	0.210	0.006	PA4316	6	1.067	0.484	0.167	0.005
PA3989-FN	1	3.100	1.406	0.518	0.015	RS4131	1	1.800	0.816	0.298	0.008	PA4317	6	0.542	0.246	0.235	0.007
RS3990	1	0.750	0.340	0.176	0.005	PA4132	6	0.842	0.382	0.101	0.003	PA4318	1	2.150	0.975	0.402	0.011
RS3991	1	0.300	0.136	0.072	0.002	PA4133	6	0.725	0.329	0.236	0.007	PA4319	6	0.530	0.240	0.800	0.023
RS3992	1	3.150	1.429	0.654	0.019	PA4134	6	1.560	0.708	0.204	0.006	PA4320	6	0.817	0.371	0.084	0.002
RS3993	1	0.850	0.386	0.319	0.009	PA4138	6	0.617	0.280	0.085	0.002	PA4321	6	0.700	0.318	0.116	0.003
RS3994	1	3.950	1.792	0.867	0.025	SA4141	12	0.267	0.121	0.037	0.001	PA4322	6	1.775	0.805	0.233	0.007
RS3995	1	1.000	0.454	0.326	0.009	PA4144	6	1.042	0.473	0.131	0.004	PA4323	6	1.200	0.544	0.210	0.006
RS3996	1	6.000	2.722	1.614	0.046	PA4145	1	6.000	2.722	0.760	0.022	PA4324	6	1.775	0.805	0.604	0.017
RS3997	1	1.550	0.703	0.786	0.022	PA4146	6	0.758	0.344	0.109	0.003	PA4325	6	0.792	0.359	0.104	0.003
RS3998	1	8.600	3.901	2.430	0.069	PA4147	6	0.975	0.442	0.132	0.004	PA4327	6	0.342	0.155	0.062	0.002
RS3998XP	1	8.650	3.924	2.430	0.069	PA4148	6	1.550	0.703	0.245	0.007	PA4328	1	1.750	0.794	0.267	0.008
RS3999	1	2.300	1.043	1.285	0.036	PA4149 KIT	6	0.658	0.298	0.131	0.004	PA4329	6	0.667	0.303	0.152	0.004
PA4005	6	2.933	1.330	0.752	0.021	PA4150	6	0.717	0.325	0.121	0.003	PA4330	6	0.758	0.344	0.265	0.007
PA4015	6	0.925	0.420	0.104	0.003	PA4151	6	1.158	0.525	0.211	0.006	PA4331	6	1.050	0.476	0.271	0.008
PA4016</																	

BALDWIN WEIGHTS AND VOLUMES

BALDWIN NUMBER	CASE QTY.	WEIGHT (ea.) lbs.	WEIGHT (ea.) kgs.	Volume (ea.) ft ³	Volume (ea.) m ³	BALDWIN NUMBER	CASE QTY.	WEIGHT (ea.) lbs.	WEIGHT (ea.) kgs.	Volume (ea.) ft ³	Volume (ea.) m ³	BALDWIN NUMBER	CASE QTY.	WEIGHT (ea.) lbs.	WEIGHT (ea.) kgs.	Volume (ea.) ft ³	Volume (ea.) m ³
PA4337	6	0.680	0.308	0.130	0.004	PA4428	6	1.017	0.461	0.187	0.005	PA4567	1	1.800	0.816	0.299	0.008
PA4338	6	0.942	0.427	0.160	0.005	PA4429	6	1.130	0.513	0.220	0.006	PA4570	1	0.550	0.249	0.225	0.006
PA4340	6	1.117	0.507	0.511	0.014	PA4430	6	0.792	0.359	0.155	0.004	PA4571	1	15.000	6.804	3.136	0.089
PA4341	6	1.067	0.484	0.216	0.006	PA4431	6	1.008	0.457	0.173	0.005	RS4572	1	8.200	3.720	2.355	0.067
PA4344	6	0.933	0.423	0.155	0.004	PA4433	6	1.600	0.726	0.315	0.009	PA4573	1	10.650	4.831	2.022	0.057
PA4345	6	0.900	0.408	0.130	0.004	PA4436	6	0.942	0.427	0.152	0.004	PA4574	1	3.500	1.588	0.683	0.019
PA4348	6	0.925	0.420	0.133	0.004	PA4437	6	0.708	0.321	0.150	0.004	RS4576	1	6.600	2.994	1.539	0.044
PA4349	6	1.450	0.658	0.234	0.007	PA4434	6	1.258	0.571	0.267	0.008	RS4577	1	2.250	1.021	0.538	0.015
PA4350	6	0.858	0.389	0.223	0.006	PA4435	6	1.350	0.612	0.219	0.006	RS4578	1	1.950	0.885	0.303	0.009
PA4351	6	1.167	0.529	0.139	0.004	PA4438	6	1.017	0.461	0.173	0.005	RS4579	1	9.550	4.332	2.700	0.076
PA4352	6	0.575	0.261	0.155	0.004	PA4439	6	1.308	0.593	0.296	0.008	RS4580	1	4.450	2.019	1.255	0.036
PA4353	6	1.000	0.454	0.130	0.004	PA4440 KIT	6	1.167	0.529	0.197	0.006	PA4581	1	5.400	2.449	0.856	0.024
PA4355	6	1.208	0.548	0.169	0.005	PA4441	6	0.842	0.382	0.157	0.004	PA4582	1	3.050	1.383	0.683	0.019
PA4356	6	0.917	0.416	0.220	0.006	PA4442	6	0.433	0.196	0.078	0.002	PA4583-FN	1	2.200	0.998	0.407	0.012
PA4357	6	0.792	0.359	0.099	0.003	PA4443	6	0.433	0.196	0.086	0.002	PA4585	1	9.900	4.491	1.937	0.055
PA4358	6	1.225	0.556	0.168	0.005	PA4444	6	0.700	0.318	0.269	0.008	PA4592	1	2.000	0.907	0.294	0.008
PA4359	6	1.167	0.529	0.246	0.007	RS4445	1	0.950	0.431	0.290	0.008	PA4593	1	3.300	1.497	0.512	0.014
PA4360	6	1.067	0.484	0.138	0.004	PA4446	6	0.558	0.253	0.115	0.003	PA4594	1	1.150	0.522	0.178	0.005
PA4361	6	0.725	0.329	0.124	0.004	PA4447	6	0.883	0.401	0.155	0.004	RS4595	1	1.600	0.726	0.321	0.009
PA4362	6	0.683	0.310	0.115	0.003	PA4448	6	0.733	0.332	0.169	0.005	RS4597	1	2.050	0.930	0.341	0.010
PA4363	6	0.525	0.238	0.127	0.004	PA4449	6	1.000	0.454	0.168	0.005	RS4598	1	2.600	1.179	0.468	0.013
PA4364	6	1.000	0.454	0.154	0.004	RS4450	1	0.950	0.431	0.293	0.008	RS4599	1	0.800	0.363	0.177	0.005
PA4365	6	0.283	0.128	0.129	0.004	PA4451	1	0.942	0.427	0.170	0.005	PA4600	6	1.942	0.881	0.386	0.011
PA4366	6	0.650	0.295	0.097	0.003	PA4452	6	0.875	0.397	0.133	0.004	PA4601	6	1.983	0.899	0.430	0.012
PA4367	6	1.125	0.510	0.203	0.006	PA4453	6	0.975	0.442	0.131	0.004	PA4602	1	3.500	1.588	0.693	0.020
PA4368	6	1.083	0.491	0.126	0.004	PA4454	6	1.117	0.507	0.238	0.007	PA4603	1	1.100	0.499	0.156	0.004
PA4370	6	0.458	0.208	0.130	0.004	PA4455	6	0.658	0.298	0.133	0.004	PA4604-FN	1	1.450	0.658	0.233	0.007
PA4371	6	0.417	0.189	0.148	0.004	PA4456	6	1.142	0.518	0.220	0.006	PA4605	1	9.200	4.173	1.668	0.047
PA4372	6	0.258	0.117	0.051	0.001	PA4458	1	2.050	0.930	0.395	0.011	PA4606	1	17.550	7.961	3.770	0.107
PA4373	6	0.508	0.230	0.079	0.002	PA4460 KIT	12	0.179	0.081	0.048	0.001	PA4607	1	2.950	1.338	0.447	0.013
PA4374	6	1.108	0.503	0.240	0.007	PA4461	6	0.341	0.155	0.078	0.002	PA4608	1	2.250	1.021	0.265	0.007
PA4375	6	1.117	0.507	0.160	0.005	PA4462	6	0.542	0.246	0.137	0.004	PA4610 KIT	1	7.900	3.583	1.552	0.044
PA4376	6	0.675	0.306	0.125	0.004	PA4463	6	1.067	0.484	0.222	0.006	PA4611	1	2.150	0.975	0.346	0.010
PA4377	6	1.350	0.612	0.183	0.005	PA4464	6	1.200	0.544	0.227	0.006	PA4612	6	0.733	0.332	0.222	0.006
PA4380	6	1.042	0.473	0.170	0.005	PA4465	6	0.992	0.450	0.239	0.007	RS4613	1	10.050	4.559	2.348	0.066
PA4381	6	0.758	0.344	0.125	0.004	PA4466	6	1.533	0.695	0.265	0.007	PA4614	1	2.150	0.975	0.276	0.008
PA4382	6	1.042	0.473	0.125	0.004	PA4467	6	1.142	0.518	0.245	0.007	PA4615	1	2.600	1.179	0.255	0.007
PA4383	6	1.008	0.457	0.176	0.005	PA4468	6	1.250	0.567	0.141	0.004	RS4616	1	10.700	4.854	2.573	0.073
PA4384	6	1.050	0.476	0.220	0.006	PA4469	6	0.500	0.227	0.074	0.002	RS4617	1	3.900	1.769	1.263	0.036
PA4385	6	0.675	0.306	0.129	0.004	PA4470	6	0.658	0.298	0.097	0.003	RS4618	1	9.200	4.173	1.937	0.055
PA4386	6	0.767	0.348	0.108	0.003	PA4471	6	0.950	0.431	0.151	0.004	PA4619	1	1.000	0.454	0.156	0.004
PA4387	6	0.933	0.423	0.115	0.003	PA4472	6	1.925	0.873	0.507	0.014	RS4620	1	5.050	2.291	1.288	0.036
PA4388	6	0.700	0.318	0.206	0.006	PA4473	6	0.600	0.272	0.132	0.004	RS4621	1	2.100	0.953	0.474	0.013
PA4389	1	0.800	0.363	0.238	0.007	PA4474	6	0.483	0.219	0.102	0.003	RS4622	1	7.350	3.334	1.466	0.041
PA4390	6	1.633	0.741	0.242	0.007	PA4475	6	0.442	0.200	0.093	0.003	RS4623	1	1.800	0.816	0.533	0.015
PA4391	6	0.458	0.208	0.156	0.004	PA4476	6	1.050	0.476	0.131	0.004	PA4624	1	5.650	2.563	0.942	0.027
PA4392	6	0.350	0.159	0.155	0.004	PA4477	6	1.058	0.480	0.135	0.004	PA4625	1	2.050	0.930	0.395	0.011
PA4393	6	0.500	0.227	0.156	0.004	PA4478	6	1.233	0.559	0.170	0.005	PA4626	1	5.400	2.449	1.070	0.030
PA4394	6	0.442	0.200	0.075	0.002	PA4479	6	0.725	0.329	0.115	0.003	PA4627	1	3.250	1.474	0.693	0.020
PA4397	6	1.083	0.491	0.172	0.005	PA4480	6	0.917	0.416	0.134	0.004	PA4628	1	1.350	0.612	0.241	0.007
PA4398	6	0.525	0.238	0.169	0.005	PA4481	6	1.000	0.454	0.138	0.004	RS4629	1	5.200	2.359	1.753	0.050
PA4399	6	0.717	0.325	0.134	0.004	PA4483	6	0.833	0.378	0.110	0.003	PA4630	1	18.200	8.256	2.242	0.063
PA4400	6	0.683	0.310	0.118	0.003	PA4484	6	0.650	0.295	0.111	0.003	PA4631-FN	1	3.050	1.383	0.617	0.017
PA4401	6	0.908	0.412	0.134	0.004	PA4485	6	1.100	0.499	0.185	0.005	PA4632	6	0.742	0.337	0.084	0.002
PA4402	6	1.292	0.586	0.233	0.007	PA4486	6	0.525	0.238	0.124	0.004	PA4633	12	0.150	0.068	0.012	**
PA4403	6	0.550	0.249	0.125	0.004	PA4487	6	1.100	0.499	0.185	0.005	RS4634	1	6.450	2.926	1.812	0.051
PA4404	6	0.492	0.223	0.148	0.004	PA4488	1	0.500	0.227	0.140	0.004	RS4634XP	1	6.450	2.926	1.805	0.051
PA4405	6	0.458	0.208	0.105	0.003	PA4489	1	0.350	0.159	0.116	0.003	PA4635	1	2.350	1.066	0.400	0.011
PA4409	6	0.909	0.412	0.240	0.007	PA4548	1	0.750	0.340	0.112	0.003	RS4636	1	5.900	2.676	1.214	0.034
PA4410 KIT	6	0.458	0.208	0.096	0.003	RS4549	1	2.600	1.179	0.681	0.019	RS4637	1	2.000	0.907	0.743	0.021
PA4411	6	0.367	0.166	0.136	0.004	PA4551	12	0.413	0.187	0.056	0.002	RS4638	1	8.650	3.924	2.048	0.058
PA4412	6	1.233	0.559	0.208	0.006	PA4552	12	0.513	0.233	0.057	0.002	RS4639	1	3.100	1.406	0.684	0.019
PA4413	6	1.233	0.559	0.167	0.005	PA4553	1	0.700	0.318	0.165	0.005	PA4640-FN	1	3.550	1.610	0.767	0.022
PA4414	6	0.925	0.420	0.165	0.005	PA4554	1	1.750	0.794	0.273	0.008	PA4641	1	2.700	1.225	0.306	0.009
PA4416 KIT	6	0.683	0.310	0.216	0.006	PA4555	6	0.308	0.140	0.024	0.001	RS4642	1	8.600	3.901	2.123	0.060
PA4417	6	1.042	0.473	0.109	0.003	PA4556	12	0.262	0.119	0.036	0.001	RS4643	1	2.600	1.179	1.244	0.035
PA4418	6	1.617	0.733	0.229	0.006	PA4557	6	0.333	0.151	0.064	0.002	PA4644	1	2.750	1.247	0.486	0.014
PA4419	6	0.617	0.280	0.129	0.004	PA4559	1	0.850	0.386	0.605	0.017	PA4645-FN	1	1.500	0.680	0.229	0.006
PA4421	6	0.866	0.393	0.148	0.004	PA4560	1	2.200	0.998	0.692	0.020	RS4646	1	6.950	3.153	1.762	0.050

BALDWIN WEIGHTS AND VOLUMES

BALDWIN NUMBER	CASE QTY.	WEIGHT (ea.) lbs.	WEIGHT (ea.) kgs.	Volume (ea.) ft ³	Volume (ea.) m ³	BALDWIN NUMBER	CASE QTY.	WEIGHT (ea.) lbs.	WEIGHT (ea.) kgs.	Volume (ea.) ft ³	Volume (ea.) m ³	BALDWIN NUMBER	CASE QTY.	WEIGHT (ea.) lbs.	WEIGHT (ea.) kgs.	Volume (ea.) ft ³	Volume (ea.) m ³
PA4652	1	1.750	0.794	0.211	0.006	PA4758	12	0.254	0.115	0.051	0.001	PA4893	1	0.917	0.416	0.189	0.005
PA4653	1	17.050	7.734	1.885	0.053	PA4760	12	0.429	0.195	0.064	0.002	PA4895	12	0.304	0.138	0.037	0.001
PA4654 KIT	1	5.000	2.268	0.406	0.011	PA4763	12	0.417	0.189	0.076	0.002	PA4896	1	0.300	0.136	0.050	0.001
PA4655	1	7.050	3.198	0.917	0.026	PA4764	6	0.525	0.238	0.074	0.002	PA4897	1	0.900	0.408	0.210	0.006
PA4656	1	4.500	2.041	0.662	0.019	PA4766	1	1.150	0.522	0.195	0.006	PA4900	1	0.200	0.091	0.042	0.001
PA4657	1	19.950	9.049	3.584	0.101	PA4769	12	0.358	0.162	0.062	0.002	PA4902	12	0.421	0.191	0.059	0.002
PA4658	1	0.450	0.204	0.051	0.001	PA4772	12	0.780	0.354	0.080	0.002	PA4903	1	1.300	0.590	0.176	0.005
PA4659	1	1.000	0.454	0.240	0.007	PA4773	12	0.530	0.240	0.070	0.002	PA4905	12	0.129	0.059	0.029	0.001
PA4660	1	10.050	4.559	2.168	0.061	RS4775	1	5.450	2.472	0.935	0.026	PA4906	6	0.200	0.091	0.028	0.001
PA4661	12	1.183	0.537	0.442	0.013	PA4777	12	0.001	**	0.007	**	PA4907	12	0.533	0.242	0.078	0.002
PA4662	12	1.125	0.510	0.441	0.012	PA4778	12	0.254	0.115	0.029	0.001	PA4908	12	0.188	0.085	0.062	0.002
PA4663	12	0.892	0.405	0.327	0.009	PA4781	1	1.300	0.590	0.307	0.009	PA4910	6	0.833	0.378	0.075	0.002
PA4664	12	1.100	0.499	0.470	0.013	PA4785	4	0.925	0.420	0.195	0.006	PA4911	12	0.020	0.009	0.016	**
PA4665-FN	1	0.850	0.386	0.130	0.004	PA4790	1	1.500	0.680	0.302	0.009	PA4912	1	0.800	0.363	0.111	0.003
PA4666	1	0.350	0.159	0.047	0.001	PA4793	6	1.025	0.465	0.259	0.007	PA4918	1	1.600	0.726	0.312	0.009
PA4668	6	2.250	1.021	1.384	0.039	RS4794	1	5.250	2.381	1.037	0.029	PA4919	1	0.700	0.318	0.161	0.005
PA4669	12	0.650	0.295	0.265	0.007	PA4795	1	1.150	0.522	0.292	0.008	PA4925	1	5.550	2.517	0.962	0.027
RS4672	1	4.150	1.882	0.879	0.025	PA4801	1	2.750	1.247	0.220	0.006	PA4928	1	0.400	0.181	0.158	0.004
RS4673	1	1.500	0.680	0.269	0.008	PA4802	1	0.950	0.431	0.179	0.005	PA4929	1	10.750	4.876	2.204	0.062
PA4674-FN	1	2.750	1.247	0.525	0.015	RS4803	1	0.950	0.431	0.140	0.004	PA4930	1	0.800	0.363	0.113	0.003
RS4676	1	4.800	2.177	1.094	0.031	RS4804	1	0.550	0.249	0.090	0.003	PA4931	12	0.020	0.009	0.043	0.001
RS4677	1	1.800	0.816	0.348	0.010	RS4806	1	3.350	1.520	0.781	0.022	PA4932	6	0.650	0.295	0.125	0.004
RS4678	1	2.400	1.089	0.395	0.011	RS4807	1	3.050	1.383	0.633	0.018	PA4934	12	0.554	0.251	0.081	0.002
RS4679	1	0.600	0.272	0.128	0.004	PA4809	1	2.050	0.930	0.444	0.013	PA4935	12	0.413	0.187	0.063	0.002
RS4680	1	2.000	0.907	0.392	0.011	PA4810	1	0.900	0.408	0.158	0.004	PA4938	4	0.863	0.391	0.220	0.006
PA4681	6	0.525	0.238	0.130	0.004	PA4813	1	1.050	0.476	0.158	0.004	PA4939	12	0.321	0.146	0.052	0.001
PA4682	6	0.375	0.170	0.087	0.002	PA4814	2	0.525	0.238	0.161	0.005	PA4941	4	0.288	0.131	0.061	0.002
PA4683	1	4.250	1.928	0.870	0.025	PA4819	12	0.496	0.225	0.064	0.002	PA4942	1	6.950	3.153	1.206	0.034
PA4688	12	0.279	0.127	0.037	0.001	PA4820	12	0.400	0.181	0.045	0.001	PA4945	1	0.800	0.363	0.445	0.013
PA4688 FOAM	6	0.010	0.005	0.014	**	PA4823	6	0.450	0.204	0.075	0.002	PA4947	1	5.250	2.381	1.426	0.040
PA4689	12	0.750	0.340	0.063	0.002	PA4824	12	0.387	0.176	0.029	0.001	PA4954	1	0.550	0.249	0.109	0.003
PA4692	1	0.950	0.431	0.150	0.004	PA4825	1	2.550	1.157	0.465	0.013	PA4955	1	0.850	0.386	0.433	0.012
PA4693	1	1.450	0.658	0.303	0.009	PA4827	1	0.650	0.295	0.150	0.004	PA4956	1	0.400	0.181	0.118	0.003
PA4694	12	0.910	0.413	0.080	0.002	PA4829	6	0.400	0.181	0.076	0.002	PA4957	6	0.733	0.332	0.141	0.004
PA4695	12	0.529	0.240	0.071	0.002	PA4830	12	0.408	0.185	0.051	0.001	RS4959	1	7.800	3.538	1.602	0.045
PA4696 FOAM	12	0.010	0.005	0.024	0.001	PA4832	1	2.900	1.315	0.734	0.021	PA4960-FN	1	4.650	2.109	0.865	0.024
PA4697-FN	1	2.900	1.315	0.673	0.019	PA4833-FN	1	0.950	0.431	0.174	0.005	PA4961	1	1.000	0.454	0.227	0.006
PA4698	6	0.400	0.181	0.025	0.001	PA4834-FN	1	1.050	0.476	0.133	0.004	RS4962	1	0.450	0.204	0.127	0.004
CA4700	1	5.400	2.449	1.047	0.030	PA4848	2	0.750	0.340	0.243	0.007	RS4963	1	7.550	3.425	1.164	0.005
PA4701	6	0.608	0.276	0.134	0.004	PA4849	1	2.350	1.066	0.740	0.021	RS4966	1	8.550	3.878	1.808	0.051
CA4702	1	2.900	1.315	0.314	0.009	PA4852	12	0.275	0.125	0.039	0.001	RS4967	1	9.700	4.400	2.251	0.064
CA4703	1	3.600	1.633	0.477	0.013	PA4852 FOAM	12	0.400	0.181	0.130	0.004	RS4968	1	5.350	2.427	0.945	0.027
PA4704	1	0.700	0.318	0.099	0.003	PA4853	12	0.125	0.057	0.029	0.001	RS4969	1	6.450	2.926	1.062	0.030
PA4705	1	0.300	0.136	0.020	0.001	PA4854	6	0.150	0.068	0.029	0.001	RS4970	1	5.350	2.427	0.792	0.022
PA4706	1	1.350	0.612	0.123	0.003	PA4855	12	0.100	0.045	0.024	0.001	RS4971	1	8.100	3.674	1.587	0.045
PA4707	1	1.300	0.590	0.237	0.007	PA4857	6	0.417	0.189	0.112	0.003	RS4972	1	4.850	2.200	0.779	0.022
PA4708	1	0.400	0.181	0.047	0.001	PA4858	1	1.500	0.680	0.372	0.011	PA4973	1	4.950	2.245	0.740	0.021
PA4709	1	3.600	1.633	0.783	0.022	RS4859	1	4.350	1.973	0.860	0.024	PA4975	12	0.500	0.227	0.212	0.006
PA4711	4	1.537	0.697	0.589	0.017	PA4860	1	17.350	7.870	1.885	0.053	PA4977-FN	1	6.650	3.016	1.672	0.047
PA4713	1	0.900	0.408	0.151	0.004	RS4861	1	5.800	2.631	1.192	0.034	PA4978	1	0.050	0.023	0.018	0.001
PA4714	6	0.950	0.431	0.122	0.003	RS4862	1	7.300	3.311	1.640	0.046	PA4979	12	0.508	0.230	0.125	0.004
PA4715	1	1.450	0.658	0.200	0.006	RS4863	1	2.650	1.202	1.318	0.037	PA4983	1	2.400	1.089	0.538	0.015
PA4716	1	1.400	0.635	0.146	0.004	RS4864	1	4.050	1.837	0.820	0.023	PA4984-FN	1	6.250	2.835	1.277	0.036
PA4720	12	0.479	0.217	0.082	0.002	PA4865-FN	1	2.250	1.021	0.616	0.017	PA4985	6	0.367	0.166	0.093	0.003
PA4723	2	2.200	0.998	0.768	0.022	PA4866	1	1.750	0.794	0.186	0.005	PA4986	6	0.442	0.200	0.082	0.002
PA4727	12	0.296	0.134	0.044	0.001	PA4867	1	0.500	0.227	0.063	0.002	PA4987	6	0.408	0.185	0.059	0.002
PA4729	6	1.625	0.737	0.122	0.003	PA4870-FN	1	2.400	1.089	0.475	0.013	RS4988	1	9.600	4.355	2.288	0.065
PA4730	6	0.433	0.196	0.075	0.002	PA4871	1	1.250	0.567	0.240	0.007	RS4989	1	13.450	6.101	3.115	0.088
PA4731	6	0.200	0.091	0.014	**	PA4872	12	0.333	0.151	0.030	0.001	PA4991	1	2.400	1.089	0.366	0.010
PA4732	12	0.363	0.165	0.061	0.002	PA4873	12	0.321	0.146	0.050	0.001	RS4992	1	4.450	2.019	0.915	0.026
PA4733	6	0.533	0.242	0.074	0.002	PA4874	12	1.109	0.503	0.713	0.020	RS4993	1	8.450	3.833	1.966	0.056
PA4734	6	0.100	0.045	0.027	0.001	PA4876	1	2.400	1.089	0.440	0.012	RS4994	1	2.250	1.021	0.403	0.011
PA4735	12	0.001	**	0.007	**	PA4877	1	1.550	0.703	0.266	0.008	RS4995	1	0.600	0.272	0.124	0.004
PA4736 FOAM	12	0.020	0.009	0.017	**	PA4878	12	0.267	0.121	0.037	0.001	CA4996	1	1.300	0.590	0.282	0.008
PA4737	6	0.942	0.427	0.075	0.002	PA4879	12	0.010	0.005	0.002	**	PA4997	6	0.617	0.280	0.080	0.002
PA4738	6	0.001	**	0.018	0.001	PA4881	1	0.600	0.272	0.078	0.002	CA4999	1	5.850	2.654	0.814	0.023
PA4740	1	0.400	0.181	0.111	0.003	PA4883	12	0.300	0.136	0.000	**	CFB5000	1	1.600	0.726	0.090	0.003
PA4741	1	5.650	2.563	1.179	0.033	PA4885	4	0.100	0.045	0.028	0.001	CS5007	12	1.308	0.593	0.035	0.001
PA4743	1	1.150	0.522	0.406	0.011	PA4886	12	0.638	0.289	0.075	0.002	CS5008	12	1.200	0.544	0.037	

BALDWIN WEIGHTS AND VOLUMES

BALDWIN NUMBER	CASE QTY.	WEIGHT (ea.) lbs.	WEIGHT (ea.) kgs.	Volume (ea.) ft ³	Volume (ea.) m ³	BALDWIN NUMBER	CASE QTY.	WEIGHT (ea.) lbs.	WEIGHT (ea.) kgs.	Volume (ea.) ft ³	Volume (ea.) m ³	BALDWIN NUMBER	CASE QTY.	WEIGHT (ea.) lbs.	WEIGHT (ea.) kgs.	Volume (ea.) ft ³	Volume (ea.) m ³
CTK5028	1	0.500	0.227	0.033	0.001	PA5303	1	18.000	8.165	3.876	0.110	RS5392	1	2.050	0.930	0.436	0.012
CTK5029	24	0.190	0.086	0.023	0.001	RS5304	1	0.850	0.386	0.314	0.009	PA5393	6	0.125	0.057	0.033	0.001
CTK5029-M	24	0.180	0.082	0.026	0.001	RS5305	1	2.100	0.953	0.349	0.010	RS5395-FN	1	2.650	1.202	0.615	0.017
CTK5029-1	1	0.001	**	0.001	**	PA5306	6	0.850	0.386	0.128	0.004	PA5396	1	0.700	0.318	0.258	0.007
CTK5029-4	1	0.001	**	0.010	**	PA5310	1	0.600	0.272	0.097	0.003	RS5397	1	5.950	2.699	1.174	0.033
CS5055	1	560.750	254.356	10.778	0.305	PA5311	12	0.383	0.174	0.058	0.002	RS5398	1	1.900	0.862	0.387	0.011
CS5057	1	51.280	23.261	1.338	0.038	PA5312 KIT	6	1.283	0.582	0.199	0.006	PA5399	1	0.700	0.318	0.163	0.005
CS5058	6	5.050	2.291	0.149	0.004	RS5313	1	2.900	1.315	0.693	0.020	PA5400	1	0.750	0.340	0.161	0.005
OTK5060	10	0.050	0.023	0.023	0.001	PA5314	6	0.750	0.340	0.127	0.004	PA5401	1	0.400	0.181	0.095	0.003
OTK5061	12	0.020	0.009	0.008	**	PA5315	1	2.900	1.315	0.396	0.011	PA5403	1	0.350	0.159	0.072	0.002
OTK5063	10	0.020	0.009	0.011	**	PA5316	12	0.096	0.044	0.013	**	PA5404	1	0.750	0.340	0.223	0.006
BW5070	12	0.979	0.444	0.041	0.001	PA5317	6	0.658	0.298	0.165	0.005	PA5405	1	0.200	0.091	0.044	0.001
BW5071	12	1.096	0.497	0.042	0.001	PA5318	6	0.742	0.337	0.141	0.004	PA5406-FN	1	2.750	1.247	0.588	0.017
BW5072	12	1.133	0.514	0.041	0.001	PA5319	6	0.733	0.332	0.110	0.003	PA5407	1	1.550	0.703	0.356	0.010
BW5073	12	1.292	0.586	0.050	0.001	PA5320	6	0.558	0.253	0.122	0.003	RS5408	1	3.250	1.474	0.518	0.015
BW5074	12	1.454	0.660	0.053	0.001	PA5321	6	0.517	0.235	0.128	0.004	RS5409	1	5.250	2.381	0.962	0.027
BW5075	12	1.521	0.690	0.049	0.001	PA5323	1	15.500	7.031	3.985	0.113	PA5410-FN	1	1.400	0.635	0.229	0.006
BW5076	12	2.075	0.941	0.066	0.002	PA5324-FN	1	0.850	0.386	0.128	0.004	RS5411	1	5.300	2.404	1.140	0.032
BW5082	12	1.217	0.552	0.048	0.001	RS5325	1	1.100	0.499	0.176	0.005	PA5412	1	2.400	1.089	0.527	0.015
BW5086	12	1.500	0.680	0.059	0.002	PA5326	1	2.300	1.043	0.231	0.007	RS5413	1	8.500	3.856	2.016	0.057
B5087	12	1.204	0.546	0.062	0.002	PA5327	6	0.383	0.174	0.045	0.001	RS5414	1	11.350	5.148	2.426	0.069
B5088	12	1.025	0.465	0.041	0.001	PA5328	6	0.900	0.408	0.102	0.003	RS5415	1	3.400	1.542	0.838	0.024
B5089	12	0.967	0.439	0.041	0.001	RS5329	1	1.950	0.885	0.667	0.019	CA5416	1	2.900	1.315	0.386	0.011
B5090	12	1.263	0.573	0.051	0.001	PA5330	12	0.160	0.073	0.083	0.002	CA5417	1	4.200	1.905	0.675	0.019
B5091	12	1.096	0.497	0.051	0.001	PA5331	1	1.950	0.885	0.385	0.011	PA5418	1	0.850	0.386	0.183	0.005
P5092	10	0.535	0.243	0.058	0.002	RS5332	1	8.400	3.810	2.023	0.057	CA5419	1	8.100	3.674	1.177	0.033
B5134	12	1.150	0.522	0.050	0.001	PA5333	6	0.425	0.193	0.064	0.002	CA5420	1	6.050	2.744	1.081	0.031
BW5136	12	1.046	0.474	0.042	0.001	RS5334	1	3.150	1.429	0.638	0.018	CA5421	1	4.950	2.245	0.835	0.024
BW5137	12	1.071	0.486	0.042	0.001	RS5335	1	0.800	0.363	0.315	0.009	RS5422	1	3.200	1.452	0.616	0.017
BW5138	12	1.150	0.522	0.049	0.001	PA5336	1	0.850	0.386	0.532	0.015	PA5423-FN	1	2.050	0.930	0.326	0.009
BW5139	12	1.325	0.601	0.049	0.001	PA5337	6	0.483	0.219	0.080	0.002	RS5424	1	3.600	1.633	0.839	0.024
BW5140	12	1.558	0.707	0.065	0.002	PA5338-FN	1	2.400	1.089	0.495	0.014	PA5425	1	10.850	4.922	2.588	0.073
BW5141	12	1.196	0.543	0.050	0.001	PA5339	6	0.733	0.332	0.169	0.005	PA5426	1	8.980	4.073	1.216	0.034
BW5142	12	1.292	0.586	0.051	0.001	PA5340	1	0.700	0.318	0.425	0.012	PA5428	6	1.742	0.790	0.297	0.008
BW5143	12	1.475	0.669	0.050	0.001	PA5341	6	0.542	0.246	0.131	0.004	RS5429	1	7.050	3.198	1.595	0.045
B5144	12	0.712	0.323	0.051	0.001	RS5342	1	8.500	3.856	1.779	0.050	RS5430	1	2.850	1.293	1.163	0.033
B5145	12	1.071	0.486	0.041	0.001	RS5343	1	9.500	4.309	2.284	0.065	RS5431	1	3.650	1.656	0.773	0.022
B5176	12	1.146	0.520	0.049	0.001	RS5344	1	5.250	2.381	1.215	0.034	RS5432	1	6.050	2.744	1.626	0.046
B5177	12	1.558	0.707	0.069	0.002	RS5345	1	0.980	0.445	0.312	0.009	RS5433	1	4.550	2.064	0.929	0.026
BW5178	12	1.279	0.580	0.052	0.001	RS5347	1	1.150	0.522	0.475	0.013	RS5434	1	3.450	1.565	0.746	0.021
BW5179	12	1.883	0.854	0.070	0.002	RS5348	1	4.600	2.087	1.173	0.033	RS5435	1	4.250	1.928	0.947	0.027
BW5182	12	1.254	0.569	0.046	0.001	PA5350	1	0.020	0.009	0.067	0.002	PA5436	1	1.600	0.726	0.578	0.016
BW5183	12	1.330	0.603	0.050	0.001	RS5351	1	2.800	1.270	0.691	0.020	PA5437	1	0.500	0.227	0.042	0.001
BW5200	12	1.892	0.858	0.049	0.001	CA5352	1	3.050	1.383	0.399	0.011	RS5438	1	4.500	2.041	0.752	0.021
BW5201	12	1.883	0.854	0.051	0.001	PA5353	12	0.262	0.119	0.051	0.001	RS5440	1	6.850	3.107	1.175	0.033
BW5250	12	1.890	0.857	0.049	0.001	RS5354	1	5.900	2.676	1.289	0.036	RS5441	1	5.250	2.381	1.693	0.048
PE5270	12	0.333	0.151	0.033	0.001	RS5355	1	2.050	0.930	0.493	0.014	RS5442	1	3.700	1.678	0.779	0.022
PE5271	12	0.404	0.183	0.051	0.001	RS5356	1	8.150	3.697	1.887	0.053	RS5443	1	1.250	0.567	0.236	0.007
PE5272	12	0.446	0.202	0.027	0.001	PA5357	1	5.850	2.654	1.622	0.046	PA5444-FN	1	1.350	0.612	0.228	0.006
RS5273	1	0.600	0.272	0.089	0.003	RS5358	1	8.300	3.765	1.597	0.045	PA5445	1	13.400	6.078	1.586	0.045
PA5274	1	9.920	4.500	1.740	0.049	PA5359	6	0.400	0.181	0.099	0.003	PA5446	1	3.900	1.769	0.901	0.025
PA5275	1	3.200	1.452	0.681	0.019	RS5360	1	7.000	3.175	1.301	0.037	RS5447	1	5.000	2.268	1.086	0.031
PA5276	12	0.080	0.036	0.009	**	RS5361	1	1.800	0.816	0.448	0.013	RS5448	1	1.000	0.454	0.272	0.008
CA5278	1	2.550	1.157	0.389	0.011	PA5363	1	1.450	0.658	0.136	0.004	RS5449	1	0.850	0.386	0.137	0.004
PA5281	1	4.250	1.928	0.502	0.014	PA5364	1	12.100	5.489	2.177	0.062	CA5450	1	1.750	0.794	0.257	0.007
PA5282	6	0.850	0.386	0.116	0.003	PA5365	1	3.650	1.656	0.787	0.022	PA5451	1	0.550	0.249	0.088	0.002
PA5283	1	3.550	1.610	0.329	0.009	CA5366	1	3.858	1.750	0.526	0.015	RS5452	1	5.700	2.586	1.438	0.041
BA5284	4	5.687	2.580	0.203	0.006	CA5368	1	7.250	3.289	1.221	0.035	RS5453	1	1.350	0.612	0.403	0.011
RS5285	1	1.800	0.816	0.346	0.010	CA5369	1	3.300	1.497	0.494	0.014	PA5454	1	11.400	5.171	1.301	0.037
RS5287XP	1	13.100	5.942	2.942	0.083	CA5370	1	2.850	1.293	0.335	0.009	RS5455	1	5.450	2.472	1.392	0.039
RS5288XP	1	9.350	4.241	2.287	0.065	BA5371	1	6.200	2.812	0.129	0.004	RS5456	1	2.550	1.157	0.611	0.017
PA5289	1	2.900	1.315	0.516	0.015	BA5372	1	8.900	4.037	0.230	0.007	PA5457	12	1.479	0.671	0.554	0.016
PA5290	1	0.400	0.181	0.074	0.002	BA5373	1	15.750	7.144	0.533	0.015	RS5458	1	5.800	2.631	1.278	0.036
RS5291	1	6.100	2.767	1.458	0.041	BA5374	4	6.160	2.794	0.175	0.005	RS5459	1	12.600	5.715	2.835	0.080
RS5292	1	2.400	1.089	0.638	0.018	BA5375	4	6.150	2.790	0.240	0.007	RS5460	1	4.650	2.109	1.320	0.037
RS5293	1	24.400	11.068	6.233	0.176	BA5376	4	5.530	2.508	0.137	0.004	RS5461	1	5.350	2.427	1.312	0.037
RS5293XP	1	27.150	12.315	6.368	0.180	BA5377	1	9.200	4.173	0.220	0.006	RS5462	1	2.200	0.998	0.692	0.020
RS5294	1	7.850	3.561	2.344	0.066	BA5378	4	5.850	2.654	0.179	0.005	PA5463	1	17.400	7.893	4.616	0.131
PA5297	1	4.250	1.928	0.589	0.017	BA5379	4	5.888	2.671	0.161	0.005	PA5464	1	3.400	1.5		

BALDWIN WEIGHTS AND VOLUMES

BALDWIN NUMBER	CASE QTY.	WEIGHT (ea.) lbs.	WEIGHT (ea.) kgs.	Volume (ea.) ft ³	Volume (ea.) m ³	BALDWIN NUMBER	CASE QTY.	WEIGHT (ea.) lbs.	WEIGHT (ea.) kgs.	Volume (ea.) ft ³	Volume (ea.) m ³	BALDWIN NUMBER	CASE QTY.	WEIGHT (ea.) lbs.	WEIGHT (ea.) kgs.	Volume (ea.) ft ³	Volume (ea.) m ³
RS5471	1	2.178	0.988	0.759	0.021	RS5550	1	0.800	0.363	0.172	0.005	PA5650	1	0.500	0.227	0.064	0.002
RS5472	1	10.800	4.899	2.620	0.074	PA5551	1	13.750	6.237	2.668	0.076	PA5651	1	0.300	0.136	0.048	0.001
PA5473	1	4.350	1.973	0.634	0.018	PA5552	1	13.300	6.033	2.788	0.079	PA5652	1	1.100	0.499	0.233	0.007
PA5474	1	0.900	0.408	0.207	0.006	PA5553	1	4.900	2.223	1.123	0.032	PA5653	1	3.100	1.406	0.341	0.010
PA5475	1	0.400	0.181	0.132	0.004	PA5554	1	1.800	0.816	0.220	0.006	PA5654	1	2.400	1.089	0.216	0.006
PA5476	1	1.000	0.454	0.158	0.004	PA5555	1	1.950	0.885	0.269	0.008	PA5655	1	2.600	1.179	0.263	0.007
PA5477	1	1.400	0.635	0.260	0.007	PA5556	1	4.800	2.177	0.953	0.027	PA5656	1	1.250	0.567	0.247	0.007
RS5478-FN	1	3.600	1.633	1.018	0.029	PA5557	1	1.800	0.816	0.331	0.009	PA5657	1	5.150	2.336	0.541	0.015
RS5479	1	0.750	0.340	0.220	0.006	RS5558	1	4.350	1.973	1.035	0.029	PA5658	6	0.500	0.227	0.104	0.003
PA5480	1	16.050	7.280	3.418	0.097	RS5559	1	1.750	0.794	0.439	0.012	PA5659	1	1.550	0.703	1.441	0.041
PA5481	1	5.500	2.495	1.630	0.046	PA5560	1	1.700	0.771	0.301	0.009	PA5660	6	0.667	0.303	0.147	0.004
PA5482	6	1.317	0.597	0.205	0.006	PA5561	1	11.010	4.994	2.057	0.058	PA5661	6	0.342	0.155	0.047	0.001
RS5483	1	6.100	2.767	1.247	0.035	PA5562	1	4.200	1.905	1.027	0.029	PA5662	6	0.200	0.091	0.063	0.002
RS5484	1	7.800	3.538	1.662	0.047	PA5563	1	1.300	0.590	0.163	0.005	PA5663	1	1.550	0.703	0.119	0.003
PA5485-FN	1	5.050	2.291	1.089	0.031	PA5564	1	8.900	4.037	1.637	0.046	PA5664	1	1.150	0.522	0.208	0.006
PA5486	1	1.900	0.862	0.469	0.013	PA5565	1	3.200	1.452	0.608	0.017	PA5665	1	1.850	0.839	0.456	0.013
PA5487	1	9.050	4.105	1.859	0.053	BA5566	4	5.750	2.608	0.162	0.005	PA5666	6	0.783	0.355	0.121	0.003
RS5488	1	6.700	3.039	1.659	0.047	PA5567	1	1.279	0.580	0.221	0.006	PA5667	1	0.900	0.408	0.157	0.004
RS5489	1	4.200	1.905	0.855	0.024	PA5568	1	13.900	6.305	3.060	0.087	PA5668	1	3.300	1.497	0.329	0.009
RS5490	1	0.750	0.340	0.241	0.007	PA5569	1	4.190	1.901	0.991	0.028	PA5669	6	0.942	0.427	0.125	0.004
PA5491	1	4.350	1.973	0.668	0.019	PA5570	1	2.500	1.134	0.358	0.010	RS5670	1	1.450	0.658	0.304	0.009
PA5492	1	0.750	0.340	0.118	0.003	PA5571	1	2.250	1.021	0.355	0.010	RS5671	1	8.200	3.720	1.874	0.053
PA5493	1	0.350	0.159	0.118	0.003	PA5572	1	0.950	0.431	0.178	0.005	RS5673	1	3.600	1.633	0.855	0.024
PA5494	6	0.217	0.098	0.045	0.001	PA5573	1	13.020	5.906	3.223	0.091	PA5674	1	15.850	7.190	2.773	0.078
PA5495	6	0.280	0.127	0.138	0.004	PA5574	1	7.130	3.234	1.093	0.031	RS5675	1	6.950	3.153	1.473	0.042
PA5496	1	6.350	2.880	0.999	0.028	PA5575	1	3.000	1.361	0.555	0.016	RS5676	1	1.000	0.454	0.422	0.012
PA5497	1	2.440	1.107	0.395	0.011	PA5577	1	9.160	4.155	1.930	0.055	PA5678	1	0.001	**	0.064	0.002
PA5498	1	9.350	4.241	1.565	0.044	PA5578	1	3.160	1.433	0.698	0.020	PA5679	6	0.483	0.219	0.106	0.003
PA5499	1	3.750	1.701	0.543	0.015	PA5579	1	0.820	0.372	0.097	0.003	PA5680	1	0.800	0.363	0.133	0.004
CA5500	1	10.700	4.854	1.639	0.046	PA5580	6	0.567	0.257	0.147	0.004	PA5681	1	3.000	1.361	0.317	0.009
PA5503	1	5.350	2.427	0.715	0.020	PA5581	1	1.450	0.658	0.202	0.006	PA5682	1	1.350	0.612	0.235	0.007
PA5504	1	1.950	0.885	0.266	0.008	PA5583	1	1.150	0.522	0.386	0.011	PA5683	6	0.417	0.189	0.078	0.002
PA5505	1	8.250	3.742	1.905	0.054	PA5584	1	0.800	0.363	0.203	0.006	RS5684	1	0.650	0.295	0.176	0.005
RS5506	1	6.050	2.744	1.545	0.044	PA5585	1	0.050	0.023	0.065	0.002	RS5685	1	2.900	1.315	0.382	0.011
RS5507	1	9.900	4.491	1.640	0.046	PA5586	1	0.150	0.068	0.112	0.003	PA5686	1	2.850	1.293	0.213	0.006
RS5508	1	7.300	3.311	1.533	0.043	BF5587-D	12	1.154	0.523	0.060	0.002	PA5687	1	11.200	5.080	1.810	0.051
RS5509	1	9.000	4.082	2.070	0.059	PA5588	1	7.390	3.352	1.730	0.049	PA5688	1	4.300	1.950	0.738	0.021
RS5510	1	2.750	1.247	0.702	0.020	PA5589	1	1.250	0.567	0.620	0.018	PA5689	6	1.708	0.775	0.408	0.012
PA5511	1	0.500	0.227	0.173	0.005	RS5591XP	1	2.150	0.975	0.419	0.012	PA5690	6	0.350	0.159	0.121	0.003
PA5512	1	0.450	0.204	0.112	0.003	BA5592	4	5.750	2.608	0.161	0.005	PA5691	6	0.250	0.113	0.095	0.003
CA5514	1	3.900	1.769	0.617	0.017	RS5593XP	1	3.850	1.746	0.755	0.021	RS5692	1	4.850	2.200	1.133	0.032
PA5515	1	1.050	0.476	0.277	0.008	PA5594	1	0.250	0.113	0.118	0.003	RS5693	1	5.450	2.472	1.309	0.037
PA5516	1	0.450	0.204	0.165	0.005	PA5596	1	0.200	0.091	0.116	0.003	PA5694	6	0.275	0.125	0.099	0.003
RS5517	1	2.450	1.111	0.404	0.011	PA5597	1	0.400	0.181	0.112	0.003	PA5695	1	0.850	0.386	0.134	0.004
PA5518	1	2.000	0.907	0.318	0.009	PA5598	1	0.200	0.091	0.110	0.003	PA5696	1	1.350	0.612	0.233	0.007
PA5519	1	3.200	1.452	0.539	0.015	PA5599	1	0.300	0.136	0.118	0.003	PA5697	1	0.650	0.295	0.116	0.003
PA5521	1	3.200	1.452	0.698	0.020	PA5618	1	0.550	0.249	0.115	0.003	PA5698	6	0.392	0.178	0.052	0.001
PA5522	1	2.000	0.907	0.670	0.019	PA5619	6	0.775	0.352	0.119	0.003	PA5699	1	15.500	7.031	3.541	0.100
PA5523	1	1.000	0.454	0.230	0.007	PA5620	6	0.358	0.162	0.102	0.003	PA5700	12	0.646	0.293	0.035	0.001
PA5524	1	6.400	2.903	1.265	0.036	PA5621	1	1.200	0.544	0.238	0.007	PA5701	1	10.957	4.970	1.828	0.052
PA5525	1	1.900	0.862	0.426	0.012	PA5622	6	0.375	0.170	0.104	0.003	PA5702	1	3.329	1.510	0.501	0.014
PA5526	1	3.900	1.769	0.711	0.020	PA5623	6	1.267	0.575	0.224	0.006	PA5704	1	10.050	4.559	2.025	0.057
PA5527	1	1.200	0.544	0.215	0.006	PA5624	6	0.250	0.113	0.089	0.003	PA5705	1	3.417	1.550	0.698	0.020
PA5528	1	6.300	2.858	1.319	0.037	PA5625	1	0.500	0.227	0.060	0.002	RS5707	1	7.100	3.221	1.611	0.046
PA5529	1	2.450	1.111	0.404	0.011	PA5626	1	1.750	0.794	0.309	0.009	RS5708	1	2.600	1.179	0.771	0.022
PA5530	1	2.000	0.907	0.850	0.024	RS5627	1	5.450	2.472	1.363	0.039	PA5710	1	1.650	0.748	0.122	0.003
PA5531	1	1.000	0.454	0.230	0.007	RS5628	1	1.450	0.658	0.630	0.018	PA5711	1	3.750	1.701	0.391	0.011
PA5532	1	0.700	0.318	0.324	0.009	PA5629	6	0.542	0.246	0.136	0.004	PA5712	1	2.100	0.953	0.173	0.005
PA5533	1	0.750	0.340	0.321	0.009	PA5630	1	0.150	0.068	0.050	0.001	PA5713	1	0.010	0.005	0.070	0.002
RS5534	1	6.850	3.107	1.724	0.049	PA5631	6	0.750	0.340	0.153	0.004	PA5714	6	0.050	0.023	0.069	0.002
RS5535	1	5.050	2.291	0.919	0.026	PA5632	6	1.192	0.541	0.177	0.005	PA5715	1	0.100	0.045	0.020	0.001
RS5536	1	3.600	1.633	0.768	0.022	PA5633	6	0.717	0.325	0.083	0.002	PA5716	1	0.001	**	0.022	0.001
RS5537	1	5.450	2.472	1.019	0.029	PA5636	1	4.250	1.928	0.489	0.014	PA5717	1	0.001	**	0.037	0.001
RS5538	1	6.000	2.722	1.486	0.042	PA5637	6	0.500	0.227	0.106	0.003	PA5718 KIT	1	0.050	0.023	0.037	0.001
RS5539	1	2.150	0.975	0.646	0.018	PA5638	6	0.242	0.110	0.065	0.002	PA5719	1	0.001	**	0.010	0.000
RS5540	1	7.400	3.357	1.686	0.048	RS5641	1	2.350	1.066	0.463	0.013	PA5720	6	0.858	0.389	0.165	0.005
RS5541	1	2.300	1.043	0.696	0.020	PA5642	1	0.307	0.139	0.750	0.021	PA5721	6	0.067	0.030	0.021	0.001
RS5543	1	1.700	0.771	0.303	0.009	PA5643	1	0.200	0.091	0.097	0.003	PA5722	6	0.392	0.178	0.081	0.002
RS5544	1	0.500	0.227	0.129	0.004	PA5644	1	0.450	0.204	0.169	0.005	PA5723	6	0.208	0.094	0.042	0.001
PA5545	1	0.															

BALDWIN WEIGHTS AND VOLUMES

BALDWIN NUMBER	CASE QTY.	WEIGHT (ea.) lbs.	WEIGHT (ea.) kgs.	Volume (ea.) ft ³	Volume (ea.) m ³	BALDWIN NUMBER	CASE QTY.	WEIGHT (ea.) lbs.	WEIGHT (ea.) kgs.	Volume (ea.) ft ³	Volume (ea.) m ³	BALDWIN NUMBER	CASE QTY.	WEIGHT (ea.) lbs.	WEIGHT (ea.) kgs.	Volume (ea.) ft ³	Volume (ea.) m ³
PA5728	6	0.658	0.298	0.073	0.002	BF5813-O	12	1.375	0.624	0.080	0.002	BK6140	1	9.700	4.400	0.752	0.021
PA5728 FOAM	6	0.067	0.030	0.031	0.001	BF5815	12	1.325	0.601	0.067	0.002	BK6161	1	2.450	1.111	0.454	0.013
PA5729	6	0.550	0.249	0.121	0.003	BF5816	12	1.357	0.616	0.065	0.002	BK6167	1	5.650	2.563	0.452	0.013
RS5730	1	8.500	3.856	1.967	0.056	6020	6	1.342	0.609	0.140	0.004	BK6181	1	4.200	1.905	0.464	0.013
RS5731	1	2.400	1.089	0.585	0.017	6021	6	0.508	0.230	0.059	0.002	BK6183	1	8.550	3.878	0.750	0.021
PA5732	6	0.117	0.053	0.045	0.001	BK6022	1	7.850	3.561	0.520	0.015	BK6184	1	6.600	2.994	0.598	0.017
PA5733	6	0.483	0.219	0.079	0.002	BK6023	1	8.950	4.060	0.839	0.024	BK6185	1	12.050	5.466	0.760	0.022
PA5734	1	1.200	0.544	0.154	0.004	BK6024	1	5.500	2.495	0.423	0.012	BK6186	1	7.350	3.334	0.520	0.015
PA5735	1	10.450	4.740	1.459	0.041	BK6025	1	7.050	3.198	0.473	0.013	BK6187	1	9.550	4.332	0.745	0.021
PA5736	1	2.600	1.179	0.257	0.007	BK6026	1	3.850	1.746	0.747	0.021	BK6189	1	8.150	3.697	0.736	0.021
PA5737 KIT	6	0.967	0.439	0.276	0.008	BK6027	1	10.450	4.740	0.831	0.024	BK6195	1	6.600	2.994	0.423	0.012
PA5738	6	0.667	0.303	0.053	0.001	BK6028	1	18.690	8.478	1.167	0.033	BK6196	1	7.900	3.583	0.736	0.021
PA5739	1	1.500	0.680	0.087	0.002	BK6029	1	10.650	4.831	0.773	0.022	BK6215	1	8.750	3.969	0.736	0.021
PA5740	1	1.900	0.862	0.129	0.004	BK6030	1	4.500	2.041	0.457	0.013	BK6287	1	4.300	1.950	0.423	0.012
RS5741	1	2.200	0.998	0.369	0.010	BK6031	1	5.550	2.517	0.558	0.016	BK6299	1	9.700	4.400	0.735	0.021
RS5742	1	0.650	0.295	0.230	0.007	BK6032	1	7.700	3.493	0.559	0.016	BK6341	1	6.100	2.767	0.545	0.015
RS5743	1	21.400	9.707	5.055	0.143	BK6033	1	3.350	1.520	0.607	0.017	BK6375	1	6.750	3.062	0.520	0.015
RS5743XP	1	24.100	10.932	5.558	0.157	BK6034	1	8.750	3.969	0.783	0.022	BK6376	1	5.700	2.586	0.423	0.012
RS5744	1	6.550	2.971	1.675	0.047	BK6035	1	5.350	2.427	0.453	0.013	BK6380	1	6.600	2.994	0.429	0.012
RS5745	1	2.500	1.134	0.419	0.012	BK6041	1	6.400	2.903	0.465	0.013	BK6426	1	9.950	4.513	0.720	0.020
RS5746	1	0.800	0.363	0.311	0.009	BK6043	1	7.550	3.425	0.580	0.016	BK6429	1	7.650	3.470	0.520	0.015
RS5747	1	1.800	0.816	0.302	0.009	BK6044	1	12.750	5.783	0.810	0.023	BK6438	1	7.300	3.311	0.766	0.022
RS5748	1	0.700	0.318	0.233	0.007	BK6045	1	6.950	3.153	0.449	0.013	BK6440	1	7.900	3.583	0.530	0.015
RS5749	1	3.350	1.520	0.638	0.018	BK6046	1	7.250	3.289	0.474	0.013	BK6444	1	7.700	3.493	0.581	0.016
RS5750	1	1.500	0.680	0.396	0.011	BK6047	1	6.150	2.790	0.553	0.015	BK6451	1	6.900	3.130	0.520	0.015
PA5751	1	8.200	3.720	1.825	0.052	BK6048	1	6.950	3.153	0.453	0.013	BK6452	1	7.300	3.311	0.736	0.021
PA5752	1	2.000	0.907	0.292	0.008	BK6049	1	5.650	2.563	0.468	0.013	BK6457	1	12.750	5.783	0.770	0.022
PA5753	6	0.500	0.227	0.107	0.003	BK6050	1	21.850	9.911	1.683	0.048	BK6463	1	9.700	4.400	0.736	0.021
RS5754	1	10.750	4.876	2.845	0.081	BK6051	1	11.500	5.216	0.789	0.022	BK6464	1	7.500	3.402	0.735	0.021
PA5755	1	3.150	1.429	0.249	0.007	BK6052	1	20.900	9.480	1.160	0.033	BK6467	1	6.000	2.722	0.435	0.012
RS5756	1	6.650	3.016	1.694	0.048	BK6053	1	10.300	4.672	0.775	0.022	BK6561	1	9.650	4.377	0.520	0.015
PA5757	1	3.000	1.361	0.218	0.006	BK6054	1	10.600	4.808	0.783	0.022	BK6562	1	8.600	3.901	0.554	0.016
RS5758	1	5.250	2.381	0.988	0.028	BK6055	1	8.600	3.901	0.728	0.021	BK6579	1	9.550	4.332	0.520	0.015
RS5759	1	1.750	0.794	0.414	0.012	BK6056	1	7.880	3.574	0.553	0.016	BK6583	1	6.700	3.039	0.520	0.015
RS5761	1	2.350	1.066	0.362	0.010	BK6057	1	12.850	5.829	0.764	0.022	BK6595	1	8.000	3.629	0.521	0.015
PA5762	1	7.250	3.289	1.949	0.055	BK6058	1	10.400	4.717	0.830	0.023	BK6600	1	7.550	3.425	0.520	0.015
PA5763	1	3.800	1.724	0.392	0.011	BK6059	1	9.850	4.468	0.817	0.023	BK6601	1	6.400	2.903	0.429	0.012
PA5764	1	0.900	0.408	0.120	0.003	BK6060	1	12.700	5.761	1.040	0.029	BK6610	1	6.600	2.994	0.429	0.012
PA5765	6	0.617	0.280	0.106	0.003	BK6061	1	6.650	3.016	0.539	0.015	BK6613	1	10.850	4.922	0.759	0.021
PA5766	6	1.558	0.707	0.170	0.005	BK6062	1	10.550	4.785	0.792	0.022	BK6619	1	7.750	3.515	0.551	0.016
RS5767	1	4.550	2.064	1.116	0.032	BK6063	1	7.550	3.425	0.745	0.021	BK6634	1	7.650	3.470	0.423	0.012
PA5768	6	0.433	0.196	0.081	0.002	BK6064	1	10.650	4.831	0.758	0.021	BK6649	1	7.700	3.493	0.855	0.024
PA5770	6	0.933	0.423	0.165	0.005	BK6065	1	3.300	1.497	0.367	0.010	BK6650	1	10.270	4.658	0.521	0.015
PA5771	1	4.050	1.837	0.274	0.008	BK6066	1	0.350	0.159	0.197	0.006	BK6652	1	5.400	2.449	0.611	0.017
PA5772	6	0.733	0.332	0.111	0.003	BK6067	1	2.800	1.270	0.447	0.013	BK6653	1	11.700	5.307	0.854	0.024
PA5773	6	0.067	0.030	0.036	0.001	BK6068	1	11.100	5.035	0.752	0.021	BK6654	1	12.950	5.874	0.824	0.023
PA5774	6	0.700	0.318	0.114	0.003	BK6069	1	12.350	5.602	0.747	0.021	BK6656	1	13.000	5.897	0.849	0.024
RS5776	1	10.800	4.899	2.225	0.063	BK6070	1	9.650	4.377	0.539	0.015	BK6657	1	12.200	5.534	0.749	0.021
PA5777	1	1.450	0.658	0.262	0.007	BK6071	1	8.050	3.651	0.541	0.015	BK6658	1	11.250	5.103	0.846	0.024
PA5778	1	0.350	0.159	0.118	0.003	BK6072	1	11.800	5.352	0.784	0.022	BK6659	1	11.000	4.990	0.749	0.021
PA5779	1	0.350	0.159	0.156	0.004	BK6073	1	12.500	5.670	0.774	0.022	BK6661	1	1.300	0.590	0.309	0.009
PA5780	1	2.700	1.225	0.225	0.006	BK6074	1	8.400	3.810	0.535	0.015	BK6662	1	10.700	4.854	0.739	0.021
PA5781	1	2.400	1.089	0.209	0.006	BK6075	1	11.500	5.216	0.790	0.022	BK6663	1	10.150	4.604	0.520	0.015
RS5782	1	2.900	1.315	0.642	0.018	BK6076	1	8.150	3.697	0.766	0.022	BK6665	1	10.400	4.717	0.520	0.015
RS5783	1	0.850	0.386	0.305	0.009	BK6077	1	6.800	3.084	0.568	0.016	BK6666	1	11.400	5.171	0.753	0.021
RS5784	1	2.250	1.021	0.395	0.011	BK6078	1	6.150	2.790	0.758	0.021	BK6670	1	11.050	5.012	0.760	0.022
PA5785	1	3.850	1.746	0.533	0.015	BK6079	1	5.100	2.313	0.453	0.013	BK6675	1	2.250	1.021	0.640	0.018
PA5786	1	1.400	0.635	0.257	0.007	BK6080	1	5.950	2.699	0.446	0.013	BK6676	1	3.650	1.656	0.779	0.022
PA5787	1	3.900	1.769	0.536	0.015	BK6081	1	9.800	4.445	0.752	0.021	BK6683	1	9.200	4.173	0.520	0.015
CA5788	1	5.430	2.463	1.036	0.029	BK6082	1	9.750	4.423	0.536	0.015	BK6685	1	4.400	1.996	0.395	0.011
CA5789	1	7.600	3.447	1.530	0.043	BK6083	1	10.850	4.922	0.775	0.022	BK6686	1	7.800	3.538	0.750	0.021
CA5790	1	5.300	2.404	0.903	0.026	BK6085	1	9.500	4.309	0.724	0.020	BK6691	1	12.350	5.602	0.749	0.021
CA5791	1	5.900	2.676	1.109	0.031	BK6086	1	9.550	4.332	0.748	0.021	BK6693	1	11.100	5.035	0.749	0.021
PA5792	1	1.350	0.612	0.246	0.007	BK6087	1	2.850	1.293	0.439	0.012	BK6694	1	11.850	5.375	0.749	0.021
CA5793	1	2.650	1.202	0.548	0.016	BK6088	1	4.950	2.245	0.730	0.021	BK6696	1	10.600	4.808	0.749	0.021
PA5796	1	1.550	0.703	0.430	0.012	BK6089	1	6.150	2.790	1.541	0.044	BK6700	1	10.250	4.649	0.760	0.022
PA5797	1	0.400	0.181	0.158	0.004	BK6090	1	11.600	5.262	0.779	0.022	BK6702	1	9.450	4.287	0.530	0.015
PA5798	1	0.300	0.136	0.096	0.003	BK6092	1	9.650	4.377	0.743	0.021	BK6704	1	11.950	5.421	0.749	0.021
PA5799	1	16.100	7.303	3.733	0.106	BK6093	1	12.750	5.783	0.775	0.022	BK6705	1	10.500			

BALDWIN WEIGHTS AND VOLUMES

BALDWIN NUMBER	CASE QTY.	WEIGHT (ea.) lbs.	WEIGHT (ea.) kgs.	Volume (ea.) ft ³	Volume (ea.) m ³	BALDWIN NUMBER	CASE QTY.	WEIGHT (ea.) lbs.	WEIGHT (ea.) kgs.	Volume (ea.) ft ³	Volume (ea.) m ³	BALDWIN NUMBER	CASE QTY.	WEIGHT (ea.) lbs.	WEIGHT (ea.) kgs.	Volume (ea.) ft ³	Volume (ea.) m ³
BK6764	1	6.700	3.039	0.551	0.016	B7051	12	1.787	0.811	0.070	0.002	B7175	6	4.392	1.992	0.223	0.006
BK6780	1	15.300	6.940	2.532	0.072	P7052	12	1.204	0.546	0.127	0.004	BD7176	6	4.867	2.208	0.167	0.005
BK6799	1	2.800	1.270	0.229	0.006	P7053	12	0.983	0.446	0.119	0.003	B7177	12	1.221	0.554	0.067	0.002
BK6903	1	6.800	3.084	0.598	0.017	P7055	12	1.154	0.523	0.128	0.004	P7178	12	0.404	0.183	0.034	0.001
BK6923	1	7.350	3.334	0.520	0.015	P7058	1	1.000	0.454	0.116	0.003	B7179	12	1.679	0.762	0.071	0.002
BK6930	1	13.350	6.056	0.755	0.021	P7059	1	1.550	0.703	0.189	0.005	B7180	6	4.392	1.992	0.189	0.005
BK6931	1	12.400	5.625	0.865	0.024	P7081	12	0.563	0.255	0.065	0.002	B7181	12	1.204	0.546	0.066	0.002
BK6933	1	2.400	1.089	0.423	0.012	B7082	12	1.167	0.529	0.052	0.001	B7182	6	3.683	1.671	0.171	0.005
BK6934	1	6.750	3.062	0.535	0.015	P7083	12	0.517	0.235	0.057	0.002	P7183	4	4.200	1.905	0.810	0.023
BK6942	1	12.100	5.489	0.749	0.021	P7084	12	1.183	0.537	0.107	0.003	P7185	12	2.158	0.979	0.222	0.006
BK6943	1	10.450	4.740	0.835	0.024	B7089	12	1.304	0.591	0.062	0.002	BC7186 KIT	12	0.158	0.072	0.051	0.001
BK6944	1	6.450	2.926	0.513	0.015	B7091	12	0.913	0.414	0.042	0.001	B7187	6	4.358	1.977	0.231	0.007
BK6945	1	9.050	4.105	0.833	0.024	P7092	12	1.308	0.593	0.132	0.004	P7188	12	0.500	0.227	0.101	0.003
BK6946	1	8.400	3.810	0.520	0.015	P7093	12	1.787	0.811	0.131	0.004	B7189	12	1.521	0.690	0.059	0.002
BK6947	1	11.600	5.262	0.749	0.021	BD7095	12	1.438	0.652	0.069	0.002	P7190	1	1.000	0.454	0.127	0.004
BK6948	1	12.400	5.625	0.870	0.025	B7097	1	3.650	1.656	0.215	0.006	B7191	12	2.592	1.176	0.123	0.003
BK6949	1	5.050	2.291	0.809	0.023	B7099	12	1.104	0.501	0.043	0.001	P7192	1	0.950	0.431	0.241	0.007
BK6950	1	9.650	4.377	0.823	0.023	P7102	1	2.800	1.270	0.241	0.007	P7193	1	2.950	1.338	0.321	0.009
BK6951	1	11.500	5.216	0.836	0.024	P7103	12	0.325	0.147	0.034	0.001	BC7194	12	0.904	0.410	0.062	0.002
BK6952	1	7.700	3.493	0.831	0.024	P7104	12	0.804	0.365	0.080	0.002	P7195	1	4.950	2.245	0.460	0.013
BK6953	1	7.650	3.470	0.847	0.024	BD7105	6	3.200	1.452	0.136	0.004	P7196	12	0.467	0.212	0.066	0.002
BK6954	1	8.300	3.765	0.809	0.023	P7106	12	1.517	0.688	0.085	0.002	B7197	12	1.121	0.508	0.050	0.001
BK6955	1	8.600	3.901	0.758	0.021	P7107	12	0.875	0.397	0.120	0.003	P7199	12	0.458	0.208	0.056	0.002
BK6956	1	11.700	5.307	0.783	0.022	B7113	12	1.875	0.851	0.089	0.003	B7215	12	1.325	0.601	0.064	0.002
BK6980	1	8.750	3.969	0.578	0.016	P7114	12	0.504	0.229	0.062	0.002	B7216	12	0.642	0.291	0.033	0.001
BK6981	1	6.650	3.016	0.591	0.017	B7116	12	1.950	0.885	0.087	0.002	B7217	6	2.408	1.092	0.119	0.003
BK6982	1	7.800	3.538	0.736	0.021	B7117	12	1.067	0.484	0.053	0.001	B7219	12	1.454	0.660	0.061	0.002
BK6983	1	9.600	4.355	0.854	0.024	B7119	12	0.788	0.357	0.032	0.001	B7220	12	1.042	0.473	0.050	0.001
BK6984	1	24.850	11.272	2.921	0.083	BD7120	1	1.750	0.794	0.128	0.004	B7221	12	0.917	0.416	0.046	0.001
BK6985	1	6.500	2.948	0.591	0.017	B7121	12	2.021	0.917	0.086	0.002	B7222	12	0.671	0.304	0.030	0.001
BK6986	1	6.500	2.948	0.520	0.015	B7124	12	1.646	0.747	0.071	0.002	B7223	12	1.746	0.792	0.070	0.002
BK6987	1	3.750	1.701	0.489	0.014	B7125	12	1.296	0.588	0.062	0.002	B7224	6	4.992	2.264	0.230	0.007
BK6988	1	15.250	6.917	1.144	0.032	P7126	1	4.050	1.837	0.353	0.010	B7225	12	2.425	1.100	0.121	0.003
BK6993	1	10.750	4.876	0.803	0.023	P7127	1	2.750	1.247	0.132	0.004	B7227	12	1.813	0.822	0.086	0.002
BK6996	1	4.950	2.245	0.446	0.013	B7128	12	1.088	0.494	0.045	0.001	BC7228	12	1.133	0.514	0.079	0.002
BK6997	1	2.850	1.293	0.423	0.012	V7129-C	7	5.021	2.278	0.416	0.012	B7229	6	4.358	1.977	0.222	0.006
P7000 KIT	6	3.350	1.520	0.463	0.013	B7130	12	1.662	0.754	0.072	0.002	P7230	6	1.242	0.563	0.208	0.006
B7001	12	1.167	0.529	0.051	0.001	B7131	12	1.537	0.697	0.049	0.001	B7231	12	1.321	0.599	0.069	0.002
P7003	3	3.933	1.784	0.394	0.011	P7132	12	0.140	0.064	0.013	**	P7232	12	0.575	0.261	0.109	0.003
B7004	6	2.358	1.070	0.123	0.003	P7134	12	0.358	0.162	0.038	0.001	P7233	12	0.917	0.416	0.133	0.004
B7005	6	2.375	1.077	0.122	0.003	B7135	6	4.317	1.958	0.225	0.006	P7235	12	0.450	0.204	0.081	0.002
P7007	4	3.863	1.752	0.522	0.015	P7136	12	0.275	0.125	0.040	0.001	BT7237	12	1.330	0.603	0.060	0.002
B7009	12	1.479	0.671	0.071	0.002	P7137	12	0.371	0.168	0.063	0.002	B7238	12	0.654	0.297	0.035	0.001
B7010	12	0.704	0.319	0.036	0.001	P7138	12	0.267	0.121	0.039	0.001	B7239	6	2.367	1.074	0.121	0.003
B7011	6	3.458	1.569	0.268	0.008	B7139	12	0.788	0.357	0.036	0.001	B7240	12	1.038	0.471	0.050	0.001
P7012	4	4.838	2.195	0.723	0.020	BD7141	6	2.725	1.236	0.120	0.003	B7241	6	2.667	1.210	0.146	0.004
P7013	12	0.638	0.289	0.090	0.003	B7142	12	1.900	0.862	0.095	0.003	BC7242	12	1.179	0.535	0.081	0.002
B7014	12	1.096	0.497	0.051	0.001	B7143	12	1.475	0.669	0.078	0.002	B7243	12	0.725	0.329	0.032	0.001
P7015	12	0.563	0.255	0.079	0.002	B7144	12	1.671	0.758	0.072	0.002	B7245	6	4.367	1.981	0.224	0.006
P7016	12	0.546	0.248	0.099	0.003	P7145	12	0.475	0.215	0.101	0.003	B7246	6	3.450	1.565	0.176	0.005
P7017	12	0.387	0.176	0.056	0.002	B7151	12	2.167	0.983	0.112	0.003	P7247	12	0.158	0.072	0.020	0.001
B7018	12	1.754	0.796	0.073	0.002	B7152	12	0.975	0.442	0.050	0.001	B7249-MPG	6	4.500	2.041	0.227	0.006
B7019	6	2.650	1.202	0.146	0.004	BD7153	6	4.350	1.973	0.197	0.006	BD7250	6	4.367	1.981	0.204	0.006
B7020	12	0.717	0.325	0.035	0.001	BD7154	6	4.083	1.852	0.171	0.005	BD7252	6	3.475	1.576	0.149	0.004
P7021	12	1.004	0.455	0.119	0.003	B7155	6	2.442	1.108	0.119	0.003	P7255	12	0.304	0.138	0.051	0.001
B7022	12	1.179	0.535	0.060	0.002	B7156	12	1.154	0.523	0.054	0.002	P7256	12	0.100	0.045	0.014	**
B7023	12	1.229	0.557	0.049	0.001	B7157	6	4.292	1.947	0.225	0.006	P7259	12	0.150	0.068	0.008	**
B7024	12	0.954	0.433	0.050	0.001	BD7158	1	2.900	1.315	0.133	0.004	P7260	12	0.150	0.068	0.023	0.001
B7025	12	1.179	0.535	0.052	0.001	BD7159	6	2.117	0.960	0.077	0.002	P7261	12	0.100	0.045	0.007	**
B7026-MPG	12	1.188	0.539	0.054	0.002	BD7160	1	1.450	0.658	0.072	0.002	P7262	12	0.020	0.009	0.008	**
BD7028	12	1.917	0.870	0.069	0.002	B7161	6	3.550	1.610	0.171	0.005	P7263	12	0.092	0.042	0.011	**
BD7029	12	1.783	0.809	0.064	0.002	B7162	6	4.358	1.977	0.231	0.007	P7264	12	1.404	0.637	0.128	0.004
B7030	6	4.333	1.965	0.239	0.007	B7163	12	2.150	0.975	0.076	0.002	P7265	12	0.517	0.235	0.063	0.002
B7031	12	1.304	0.591	0.062	0.002	B7164	12	2.121	0.962	0.095	0.003	P7267	1	1.550	0.703	0.194	0.005
B7033	12	0.713	0.323	0.033	0.001	B7165	12	0.629	0.285	0.025	0.001	P7268	1	2.000	0.907	0.149	0.004
B7034	12	1.246	0.565	0.047	0.001	BD7166	6	2.700	1.225	0.119	0.003	P7269	12	0.508	0.230	0.063	0.002
P7035	12	1.000	0.454	0.120	0.003	B7167	12	0.688	0.312	0.027	0.001	B7271	12	1.175	0.533	0.061	0.002
B7039	12	1.833	0.831	0.087	0.002	BD7168	1	3.350	1.520	0.178	0.005	B7273	12	1.163	0.528	0.063	0.002
B7042	12	1.183	0.537	0.053	0.001	BD7169	6	2.117	0.960	0.076	0.002	B7274	12	1.090	0.494	0.044	0.001
B7044	12	1.508	0.684	0.063	0.002	B71											

BALDWIN WEIGHTS AND VOLUMES

BALDWIN NUMBER	CASE QTY.	WEIGHT (ea.) lbs.	WEIGHT (ea.) kgs.	Volume (ea.) ft ³	Volume (ea.) m ³	BALDWIN NUMBER	CASE QTY.	WEIGHT (ea.) lbs.	WEIGHT (ea.) kgs.	Volume (ea.) ft ³	Volume (ea.) m ³	BALDWIN NUMBER	CASE QTY.	WEIGHT (ea.) lbs.	WEIGHT (ea.) kgs.	Volume (ea.) ft ³	Volume (ea.) m ³
B7283	12	0.783	0.355	0.044	0.001	B7385	12	1.571	0.713	0.066	0.002	B7470	12	1.280	0.581	0.053	0.001
B7285	12	0.517	0.235	0.035	0.001	B7386	12	1.613	0.732	0.064	0.002	B7472	12	1.371	0.622	0.060	0.002
B7286	12	0.546	0.248	0.031	0.001	B7387	12	1.409	0.639	0.065	0.002	B7473	12	1.280	0.581	0.054	0.002
B7287	12	0.629	0.285	0.029	0.001	B7388	12	1.258	0.571	0.056	0.002	B7474	12	1.477	0.670	0.062	0.002
B7289	12	0.725	0.329	0.028	0.001	B7389	12	1.628	0.738	0.085	0.002	B7475	12	1.565	0.710	0.068	0.002
B7290	12	0.780	0.354	0.030	0.001	B7390	12	0.938	0.425	0.035	0.001	B7476	12	1.368	0.621	0.065	0.002
B7291	12	1.079	0.489	0.050	0.001	B7392	12	1.496	0.679	0.063	0.002	B7477	12	1.717	0.779	0.080	0.002
B7292	12	0.650	0.295	0.020	0.001	B7393	12	2.188	0.992	0.093	0.003	B7478	12	2.179	0.988	0.102	0.003
B7293	12	0.617	0.280	0.030	0.001	BC7394	12	1.179	0.535	0.078	0.002	B7481	12	2.838	1.287	0.100	0.003
B7294	12	0.679	0.308	0.028	0.001	B7395	12	1.404	0.637	0.053	0.001	B7482	12	3.200	1.452	0.135	0.004
B7295	12	0.646	0.293	0.028	0.001	B7396	6	2.908	1.319	0.165	0.005	B7483	12	2.317	1.051	0.077	0.002
B7298	12	1.129	0.512	0.051	0.001	B7397	12	1.871	0.849	0.086	0.002	P7484	12	1.321	0.599	0.099	0.003
B7299	6	4.283	1.943	0.225	0.006	P7398	12	0.154	0.070	0.023	0.001	BC7485	12	1.029	0.467	0.091	0.003
P7302	12	0.125	0.057	0.000	**	P7399	12	0.225	0.102	0.039	0.001	B7486	12	1.588	0.720	0.064	0.002
P7303	12	0.125	0.057	0.021	0.001	P7400	12	0.275	0.125	0.275	0.008	B7487	12	0.767	0.348	0.028	0.001
P7305	12	0.633	0.287	0.101	0.003	B7401	12	0.679	0.308	0.033	0.001	P7488	12	0.263	0.119	0.041	0.001
B7306	12	1.150	0.522	0.050	0.001	B7402	6	3.583	1.625	0.171	0.005	P7489	12	0.163	0.074	0.034	0.001
P7308	12	0.333	0.151	0.050	0.001	B7403	12	1.133	0.514	0.046	0.001	B7491	12	0.658	0.298	0.026	0.001
BD7309	6	3.508	1.591	0.162	0.005	P7406	12	0.250	0.113	0.040	0.001	P7492	12	0.221	0.100	0.032	0.001
BD7310	6	3.517	1.595	0.160	0.005	B7407	12	0.750	0.340	0.033	0.001	P7493	12	0.108	0.049	0.035	0.001
B7311-MPG	12	1.467	0.665	0.067	0.002	P7408	12	0.192	0.087	0.034	0.001	P7494	6	1.108	0.503	0.165	0.005
P7312	6	2.233	1.013	0.284	0.008	B7409	12	2.279	1.034	0.122	0.003	P7495	12	3.150	1.429	0.282	0.008
P7313	12	0.142	0.064	0.024	0.001	B7410	12	0.608	0.276	0.034	0.001	B7496	12	1.092	0.495	0.045	0.001
B7314	6	4.092	1.856	0.222	0.006	P7411	12	0.150	0.068	0.017	**	B7497	12	1.533	0.695	0.074	0.002
BT7316	12	1.617	0.733	0.071	0.002	P7413	12	0.221	0.100	0.034	0.001	B7499	12	1.155	0.524	0.045	0.001
BD7317	12	1.558	0.707	0.069	0.002	P7414	12	0.254	0.115	0.048	0.001	F7500	4	5.438	2.467	0.592	0.017
B7318	12	0.567	0.257	0.031	0.001	P7415	12	0.313	0.142	0.049	0.001	P7500	4	5.425	2.461	0.582	0.016
P7319	12	0.746	0.338	0.129	0.004	B7416	6	2.575	1.168	0.123	0.003	B7501	12	2.454	1.113	0.120	0.003
B7320	12	1.150	0.522	0.052	0.001	P7417	12	0.217	0.098	0.038	0.001	P7502	6	0.875	0.397	0.210	0.006
P7321	12	2.250	1.021	0.182	0.005	P7418	12	0.225	0.102	0.048	0.001	B7503	6	3.425	1.554	0.180	0.005
B7322	6	2.067	0.938	0.071	0.002	B7419	12	0.521	0.236	0.033	0.001	BD7504	6	3.450	1.565	0.162	0.005
B7324	6	2.417	1.096	0.124	0.004	B7420	12	1.317	0.597	0.051	0.001	P7505	6	1.858	0.843	0.206	0.006
BD7325	6	2.717	1.232	0.119	0.003	B7422	12	0.667	0.303	0.032	0.001	B7506	12	2.783	1.262	0.140	0.004
BC7326	12	0.779	0.353	0.091	0.003	P7423	12	0.430	0.195	0.060	0.002	B7507	6	4.275	1.939	0.238	0.007
B7327	12	1.492	0.677	0.063	0.002	B7424	12	1.033	0.469	0.050	0.001	P7508	6	1.200	0.544	0.162	0.005
B7328	12	1.150	0.522	0.052	0.001	P7426	12	0.225	0.102	0.033	0.001	BD7509	6	4.067	1.845	0.170	0.005
P7329	6	1.042	0.473	0.173	0.005	P7427	12	0.217	0.098	0.033	0.001	P7510	12	1.100	0.499	0.046	0.001
P7330	6	0.475	0.215	0.142	0.004	B7428	12	0.700	0.318	0.036	0.001	B7511	12	1.050	0.476	0.050	0.001
PT7332	12	1.142	0.518	0.109	0.003	B7429	12	0.700	0.318	0.030	0.001	P7512	12	1.600	0.726	0.140	0.004
B7333	12	0.521	0.236	0.018	0.001	B7430	12	0.800	0.363	0.040	0.001	B7513	6	2.583	1.172	0.120	0.003
B7334	12	0.692	0.314	0.031	0.001	B7431	12	1.120	0.508	0.050	0.001	P7514	12	10.100	4.581	0.587	0.017
B7335-MPG	6	2.925	1.327	0.132	0.004	B7432	12	0.916	0.415	0.040	0.001	P7515	12	0.250	0.113	0.037	0.001
P7336 KIT	12	0.392	0.178	0.067	0.002	B7433	12	0.788	0.357	0.036	0.001	P7517	12	0.254	0.115	0.037	0.001
P7337	1	7.850	3.561	0.678	0.019	B7434	12	0.725	0.329	0.033	0.001	BF7519	12	0.379	0.172	0.037	0.001
P7338	12	0.204	0.093	0.033	0.001	B7435	1	3.050	1.383	0.125	0.004	BF7522	1	0.900	0.408	0.092	0.003
BT7349	12	1.442	0.654	0.065	0.002	P7436	6	0.942	0.427	0.111	0.003	BF7528	12	1.100	0.499	0.045	0.001
B7350	12	1.733	0.786	0.075	0.002	P7437	12	1.146	0.520	0.122	0.003	BF7529	12	1.379	0.626	0.063	0.002
B7351-MPG	12	1.304	0.591	0.051	0.001	P7438	12	0.196	0.089	0.034	0.001	BF7531	12	0.917	0.416	0.040	0.001
B7352	12	0.770	0.349	0.028	0.001	B7440	12	1.408	0.639	0.049	0.001	BF7532	12	1.504	0.682	0.057	0.002
BD7355	6	4.342	1.970	0.172	0.005	B7441	12	0.590	0.268	0.022	0.001	BF7534	12	1.496	0.679	0.056	0.002
B7356	12	0.525	0.238	0.034	0.001	P7442	12	0.175	0.079	0.033	0.001	BF7535	12	1.496	0.679	0.056	0.002
B7357	12	1.670	0.758	0.076	0.002	B7443	12	0.679	0.308	0.033	0.001	BF7537	12	0.624	0.283	0.050	0.001
B7359	12	1.342	0.609	0.052	0.001	B7444	12	0.758	0.344	0.036	0.001	BF7538	12	1.083	0.491	0.044	0.001
B7360	12	1.196	0.543	0.053	0.001	B7445	12	0.763	0.346	0.028	0.001	BF7541	12	0.904	0.410	0.046	0.001
B7361	12	0.675	0.306	0.031	0.001	B7446	12	0.584	0.265	0.025	0.001	BF7544	12	0.704	0.319	0.030	0.001
B7362	12	1.654	0.750	0.062	0.002	B7449	12	0.729	0.331	0.033	0.001	PF7545	12	0.075	0.034	0.011	**
B7363	6	3.550	1.610	0.260	0.007	P7450	12	0.213	0.097	0.033	0.001	BF7546	12	1.329	0.603	0.066	0.002
P7364	12	0.246	0.112	0.034	0.001	B7451	12	1.310	0.594	0.054	0.002	PF7549	12	0.117	0.053	0.011	**
P7365	12	0.288	0.131	0.037	0.001	B7452	12	1.133	0.514	0.055	0.002	PF7550	12	0.213	0.097	0.020	0.001
B7367	12	1.695	0.769	0.080	0.002	B7453	12	1.042	0.473	0.042	0.001	PF7551	12	0.371	0.168	0.034	0.001
P7368	12	1.846	0.837	0.191	0.005	BC7456 KIT	12	0.167	0.076	0.052	0.001	BF7552	12	1.008	0.457	0.051	0.001
B7369	12	1.330	0.603	0.054	0.002	P7454	12	0.129	0.059	0.021	0.001	PF7553	12	0.892	0.405	0.090	0.003
B7370	12	1.320	0.599	0.054	0.002	P7455	12	0.383	0.174	0.054	0.002	PF7554	12	0.633	0.287	0.081	0.002
B7372	12	1.442	0.654	0.066	0.002	B7457	12	1.317	0.597	0.055	0.002	PF7556	12	0.550	0.249	0.095	0.003
B7373	12	1.517	0.688	0.059	0.002	B7458	12	0.950	0.431	0.035	0.001	BF7557	12	1.208	0.548	0.067	0.002
B7375	12	1.375	0.624	0.067	0.002	B7459	12	3.288	1.491	0.142	0.004	BF7558	12	1.513	0.686	0.083	0.002
B7376	12	1.492	0.677	0.063	0.002	B7460	12	3.060	1.388	0.129	0.004	BF7559	12	1.079	0.489	0.044	0.001
B7377	12	1.242	0.563	0.057	0.002	B7461	12	1.483	0.673	0.067	0.002	BF7571	6	3.400	1.542	0.266	0.008
B7378	12	1.621	0.735	0.078	0.002	B7462	12	1.280	0.581	0.054	0.002	PF7572	12	0.746	0.338	0.081	0.002
B7379	12	1.446</															

BALDWIN WEIGHTS AND VOLUMES

BALDWIN NUMBER	CASE QTY.	WEIGHT (ea.) lbs.	WEIGHT (ea.) kgs.	Volume (ea.) ft ³	Volume (ea.) m ³	BALDWIN NUMBER	CASE QTY.	WEIGHT (ea.) lbs.	WEIGHT (ea.) kgs.	Volume (ea.) ft ³	Volume (ea.) m ³	BALDWIN NUMBER	CASE QTY.	WEIGHT (ea.) lbs.	WEIGHT (ea.) kgs.	Volume (ea.) ft ³	Volume (ea.) m ³
BF7584	12	2.158	0.979	0.109	0.003	BF7681-D	12	0.612	0.278	0.047	0.001	BF7800	12	0.413	0.187	0.046	0.001
B7585	12	1.721	0.781	0.089	0.003	BF7682-D	12	0.771	0.350	0.064	0.002	BF7801	12	0.675	0.306	0.062	0.002
BF7586	12	1.304	0.591	0.061	0.002	BF7683	12	0.638	0.289	0.032	0.001	BF7802	12	0.383	0.174	0.046	0.001
BF7587	12	1.992	0.904	0.097	0.003	B7685	12	2.258	1.024	0.124	0.004	BF7803	12	0.638	0.289	0.061	0.002
PF7588	12	0.387	0.176	0.032	0.001	BF7686	12	0.108	0.049	0.020	0.001	BF7804	12	0.621	0.282	0.060	0.002
P7490	12	0.150	0.068	0.010	0.001	PF7687	12	0.596	0.270	0.047	0.001	BF7805	12	0.521	0.236	0.077	0.002
BF7591-D	12	0.942	0.427	0.041	0.001	BF7690	12	0.313	0.142	0.039	0.001	BF7806	12	1.342	0.609	0.065	0.002
PF7592	12	0.621	0.282	0.064	0.002	BF7691	12	0.238	0.108	0.020	0.001	BF7807	12	0.188	0.085	0.037	0.001
BF7593	12	1.371	0.622	0.050	0.001	BF7693	12	0.233	0.106	0.038	0.001	BF7808	12	0.375	0.170	0.038	0.001
PF7594	12	0.725	0.329	0.062	0.002	BF7695	6	1.133	0.514	0.104	0.003	BF7809	12	0.438	0.199	0.047	0.001
PF7595	12	0.271	0.123	0.037	0.001	BF7696	12	1.538	0.698	0.078	0.002	PF7812 KIT	12	0.529	0.240	0.079	0.002
PF7596	12	0.258	0.117	0.033	0.001	BF7697	6	2.708	1.228	0.141	0.004	BF7813	12	1.354	0.614	0.066	0.002
PF7597	12	1.213	0.550	0.120	0.003	PF7698	12	0.996	0.452	0.079	0.002	BF7814	12	2.521	1.144	0.122	0.003
BF7598	12	0.992	0.450	0.046	0.001	BF7699-D	12	0.683	0.310	0.047	0.001	BF7815	12	1.446	0.656	0.069	0.002
B7600	12	2.292	1.040	0.118	0.003	B7700	12	2.421	1.098	0.121	0.003	PF7816	12	0.175	0.079	0.034	0.001
B7600-SS	12	2.396	1.087	0.120	0.003	BF7711	12	0.704	0.319	0.131	0.004	PF7817	12	0.150	0.068	0.016	0.001
BF7602	12	1.004	0.455	0.042	0.001	BF7713	12	0.513	0.233	0.094	0.003	PF7818	24	0.054	0.024	0.005	0.001
BF7606	12	1.287	0.584	0.067	0.002	PF7715	6	2.058	0.934	0.271	0.008	PF7819	12	0.050	0.023	0.015	0.001
PT6707	1	0.500	0.227	0.077	0.002	PF7716	12	2.450	1.111	0.396	0.011	PF7820	12	0.050	0.023	0.015	0.001
BF7608	12	0.779	0.353	0.036	0.001	BF7717	12	1.933	0.877	0.076	0.002	BF7821	12	0.783	0.355	0.063	0.002
BF7609	12	0.513	0.233	0.037	0.001	PF7718	12	1.204	0.546	0.107	0.003	PF7822	30	0.070	0.032	0.008	0.001
BF7612	12	2.004	0.909	0.095	0.003	BF7719	12	0.379	0.172	0.046	0.001	PF7823	12	0.167	0.076	0.022	0.001
BF7613	12	2.479	1.124	0.121	0.003	BF7720	12	0.450	0.204	0.038	0.001	PF7824	30	0.065	0.029	0.005	0.001
BF7614	12	1.417	0.643	0.050	0.001	BF7721	12	0.879	0.399	0.060	0.002	PF7825	12	0.146	0.066	0.034	0.001
PT6715	12	0.921	0.418	0.078	0.002	BF7725	12	0.067	0.030	0.013	0.001	PF7826	12	0.221	0.100	0.033	0.001
PT7616	1	1.550	0.703	0.140	0.004	BF7726	12	1.125	0.510	0.078	0.002	PF7828	6	0.100	0.045	0.025	0.001
PT7617	6	3.446	1.563	0.277	0.008	PF7733	12	1.204	0.546	0.107	0.003	PF7829	12	0.308	0.140	0.029	0.001
PF7618	12	1.354	0.614	0.135	0.004	PF7734	12	1.258	0.571	0.108	0.003	PF7830	12	0.020	0.009	0.016	0.001
BF7619	12	1.008	0.457	0.039	0.001	PF7735	12	0.538	0.244	0.052	0.001	PF7832	12	0.171	0.078	0.020	0.001
BF7623	6	3.383	1.535	0.265	0.007	BF7736	12	0.090	0.041	0.010	0.001	PF7833	12	0.221	0.100	0.028	0.001
BF7624	12	1.450	0.658	0.057	0.002	BF7736-K1	12	0.208	0.094	0.029	0.001	PF7834	12	0.288	0.131	0.037	0.001
BF7625	12	0.196	0.089	0.034	0.001	BF7742	12	0.467	0.212	0.046	0.001	PF7836	12	0.179	0.081	0.028	0.001
BF7626	12	0.600	0.272	0.061	0.002	PF7744	12	0.821	0.372	0.080	0.002	BF7837	12	0.688	0.312	0.028	0.001
PF7627	6	0.608	0.276	0.092	0.003	BF7745-D	12	0.654	0.297	0.045	0.001	BF7838	12	0.917	0.416	0.046	0.001
BF7628	12	1.858	0.843	0.074	0.002	BF7746-D	12	0.888	0.403	0.064	0.002	BF7839	20	0.600	0.272	0.029	0.001
BF7629	12	1.846	0.837	0.087	0.002	BF7747	12	1.242	0.563	0.053	0.001	BF7840	12	0.683	0.310	0.029	0.001
BF7630	1	1.000	0.454	0.399	0.011	PF7748	12	0.904	0.410	0.080	0.002	BF7841	12	0.792	0.359	0.036	0.001
BF7631	12	1.983	0.899	0.095	0.003	PF7749	12	1.479	0.671	0.130	0.004	BF7842	12	1.221	0.554	0.060	0.002
BF7632	12	1.383	0.627	0.066	0.002	BF7750	12	1.146	0.520	0.053	0.001	BF7843	12	0.001	0.001	0.004	0.001
BF7633	12	1.338	0.607	0.065	0.002	PF7751	12	0.508	0.230	0.071	0.002	BF7844	12	0.892	0.405	0.078	0.002
BF7634	12	1.200	0.544	0.046	0.001	BF7753	12	2.046	0.928	0.099	0.003	BF7845	12	0.188	0.085	0.020	0.001
BF7635	6	3.992	1.811	0.227	0.006	PF7755	12	0.842	0.382	0.081	0.002	BF7847	12	0.179	0.081	0.021	0.001
B7637	1	2.800	1.270	0.231	0.007	BF7756	12	0.900	0.408	0.062	0.002	BF7848	12	0.100	0.045	0.025	0.001
BF7637	12	1.104	0.501	0.045	0.001	PF7758	12	0.642	0.291	0.056	0.002	BF7849	12	0.175	0.079	0.021	0.001
BF7639	6	4.433	2.011	0.228	0.006	BF7759	12	1.371	0.622	0.077	0.002	BF7850	12	0.242	0.110	0.080	0.002
BF7639-D	6	4.392	1.992	0.229	0.006	BF7760	12	1.260	0.572	0.057	0.002	BF7851	12	0.050	0.023	0.013	0.001
BF7640	12	1.508	0.684	0.065	0.002	PF7761	12	0.575	0.261	0.092	0.003	PF7852 KIT	12	0.471	0.214	0.081	0.002
BF7641	1	0.800	0.363	0.174	0.005	BF7762	12	0.321	0.146	0.038	0.001	BF7853	12	1.862	0.845	0.088	0.002
BF7644	12	1.546	0.701	0.075	0.002	BF7763	1	1.050	0.476	0.825	0.023	BF7855	12	0.067	0.030	0.011	0.001
BF7645	12	1.296	0.588	0.062	0.002	BF7765	12	0.604	0.274	0.046	0.001	BF7857	12	0.010	0.005	0.008	0.001
BF7648	12	0.817	0.371	0.032	0.001	BF7766	12	2.317	1.051	0.087	0.002	BF7859	6	0.150	0.068	0.017	0.001
BF7653	12	1.571	0.713	0.075	0.002	PF7767	12	0.610	0.277	0.100	0.003	BF7860	12	0.010	0.005	0.007	0.001
PF7655	12	1.125	0.510	0.128	0.004	BF7768	12	0.367	0.166	0.047	0.001	BF7861	12	0.050	0.023	0.008	0.001
BF7656	12	1.933	0.877	0.095	0.003	BF7769	12	0.375	0.170	0.046	0.001	BF7863	12	0.138	0.063	0.022	0.001
BF7657	12	2.517	1.142	0.121	0.003	PF7770	12	2.150	0.975	0.227	0.006	BF7864	12	0.079	0.036	0.019	0.001
BF7658	12	0.346	0.157	0.037	0.001	BF7771	12	0.400	0.181	0.046	0.001	BF7865	12	0.050	0.023	0.015	0.001
BF7659	12	0.504	0.229	0.038	0.001	BF7772	12	1.096	0.497	0.045	0.001	BF7866	12	0.746	0.338	0.060	0.002
BF7661	12	0.408	0.185	0.036	0.001	BF7773	12	2.100	0.953	0.095	0.003	PF7869	12	0.001	0.001	0.008	0.001
BF7663	12	0.929	0.421	0.046	0.001	BF7774	12	1.100	0.499	0.051	0.001	BF7870	12	0.783	0.355	0.049	0.001
BF7664	12	1.271	0.577	0.051	0.001	BF7775	12	0.413	0.187	0.047	0.001	BF7871	12	0.571	0.259	0.050	0.001
BF7666	12	0.950	0.431	0.051	0.001	BF7776	12	0.413	0.187	0.047	0.001	PF7872	12	0.200	0.091	0.019	0.001
BF7667	12	0.379	0.172	0.038	0.001	PF7777	12	0.392	0.178	0.039	0.001	PF7873	12	0.079	0.036	0.012	0.001
BF7668	12	0.379	0.172	0.045	0.001	BF7778	12	1.146	0.520	0.061	0.002	PF7874	12	0.100	0.045	0.007	0.001
BF7669	1	0.950	0.431	0.752	0.021	PF7779	12	0.712	0.323	0.062	0.002	PF7875	12	0.040	0.018	0.007	0.001
BF7670	12	0.667	0.303	0.080	0.002	BF7780	12	0.813	0.369	0.126	0.004	PF7876	12	0.355	0.161	0.046	0.001
BF7671	1	0.760	0.345	0.233	0.007	PF7782	6	0.850	0.386	0.108	0.003	PF7877	12	0.005	0.002	0.007	0.001
BF7672-D	12	0.683	0.310	0.054	0.002	BF7783-D	12	0.629	0.285	0.048	0.001	PF7878	12	0.640	0.290	0.070	0.002
BF7673-D	12	0.650	0.295	0.050	0.001	BF7784-D	12	0.775	0.352	0.053	0.001	BF7879	12	1.175	0.533	0.051	0.001

BALDWIN WEIGHTS AND VOLUMES

BALDWIN NUMBER	CASE QTY.	WEIGHT (ea.) lbs.	WEIGHT (ea.) kgs.	Volume (ea.) ft ³	Volume (ea.) m ³	BALDWIN NUMBER	CASE QTY.	WEIGHT (ea.) lbs.	WEIGHT (ea.) kgs.	Volume (ea.) ft ³	Volume (ea.) m ³	BALDWIN NUMBER	CASE QTY.	WEIGHT (ea.) lbs.	WEIGHT (ea.) kgs.	Volume (ea.) ft ³	Volume (ea.) m ³
PF7889	12	0.638	0.289	0.080	0.002	BF7967	12	0.858	0.389	0.030	0.001	PT8366	1	4.100	1.860	0.471	0.013
PF7889-10	12	0.638	0.289	0.081	0.002	BF7968	12	1.079	0.489	0.044	0.001	BT8368	6	3.783	1.716	0.267	0.008
PF7889-30	12	0.596	0.270	0.080	0.002	BF7968-O	12	1.075	0.488	0.052	0.001	PT8370-MPG	12	1.946	0.883	0.131	0.004
PF7890	12	1.067	0.484	0.137	0.004	BF7969	12	0.710	0.322	0.026	0.001	PT8371-MPG	6	3.358	1.523	0.269	0.008
PF7890-10	12	0.996	0.452	0.131	0.004	BF7970	12	1.330	0.603	0.060	0.002	PT8372	12	0.150	0.068	0.016	**
PF7890-30	12	1.025	0.465	0.134	0.004	BF7971-D	12	0.729	0.331	0.063	0.002	PT8375-MPG	6	1.725	0.782	0.144	0.004
BF7892	12	0.779	0.353	0.036	0.001	BF7971-DM	12	0.742	0.337	0.063	0.002	PT8376-MPG	6	3.933	1.784	0.463	0.013
PF7894	6	0.925	0.420	0.106	0.003	BF7972	12	0.929	0.421	0.062	0.002	PT8378-MPG	1	1.800	0.816	0.111	0.003
PF7895	6	0.890	0.404	0.110	0.003	PF7973	1	1.850	0.839	0.239	0.007	PT8380	1	5.450	2.472	0.465	0.013
PF7896	12	0.479	0.217	0.066	0.002	PF7974	12	0.071	0.032	0.011	**	BT8381	6	5.010	2.273	0.264	0.007
BF7898-D	12	0.779	0.353	0.064	0.002	PF7975	12	0.050	0.023	0.003	**	BT8382	6	3.925	1.780	0.227	0.006
PF7899	1	1.250	0.567	0.158	0.004	BF7976	12	1.108	0.503	0.060	0.002	PT8383	1	4.400	1.996	0.464	0.013
PF7900	1	1.700	0.771	0.180	0.005	PF7977	12	0.438	0.199	0.040	0.001	BT8384	12	1.133	0.514	0.040	0.001
BF7903	12	0.050	0.023	0.013	**	PF7978	12	0.583	0.264	0.065	0.002	PT8385	12	0.696	0.316	0.040	0.001
BF7904-D	12	0.550	0.249	0.041	0.001	BF7979	12	1.808	0.820	0.081	0.002	BT8386	12	0.396	0.180	0.032	0.001
BF7905-D	12	0.654	0.297	0.053	0.001	PF7980	1	2.200	0.998	0.334	0.009	PT8387	1	3.000	1.361	0.245	0.007
BF7906-D	12	0.771	0.350	0.053	0.001	BF7981	12	1.458	0.661	0.063	0.002	PT8388	1	3.300	1.497	0.258	0.007
BF7907	12	1.183	0.537	0.053	0.001	PF7982	12	0.642	0.291	0.071	0.002	PT8389	1	3.300	1.497	0.248	0.007
BF7908	12	1.450	0.658	0.054	0.002	PF7983	12	0.704	0.319	0.087	0.002	BT8391	12	1.088	0.494	0.053	0.001
BF7909	12	0.671	0.304	0.032	0.001	PF7984	12	0.820	0.372	0.098	0.003	PT8392	12	0.196	0.089	0.021	0.001
PF7910	12	0.275	0.125	0.032	0.001	BF7985	12	1.442	0.654	0.050	0.001	BT8393	12	1.608	0.729	0.079	0.002
BF7911	12	1.942	0.881	0.087	0.002	PF7986	12	0.558	0.253	0.080	0.002	PT8394-MPG	1	2.850	1.293	0.236	0.007
BF7912	12	0.300	0.136	0.035	0.001	BF7987	12	1.663	0.754	0.053	0.001	PT8395	1	9.250	4.196	0.641	0.018
BF7913	6	3.433	1.557	0.163	0.005	BF7988	12	1.638	0.743	0.053	0.001	PT8396	1	9.950	4.513	0.646	0.018
PF7914	1	1.700	0.771	0.187	0.005	BF7989-D	12	0.690	0.313	0.060	0.002	BT8397-MPG	1	3.400	1.542	0.118	0.003
BF7915	12	0.642	0.291	0.031	0.001	BF7990	12	1.220	0.553	0.043	0.001	BT8398-MPG	12	1.379	0.626	0.060	0.002
PF7916	12	0.254	0.115	0.034	0.001	BF7993	12	1.288	0.584	0.066	0.002	PT8400-MPG	1	1.000	0.454	0.091	0.003
BF7917	12	1.417	0.643	0.081	0.002	PF7994	12	1.000	0.045	0.023	0.001	BT8401-MPG	6	4.820	2.186	0.226	0.006
BF7919	12	1.229	0.557	0.057	0.002	BF7995	12	1.288	0.584	0.062	0.002	PT8402-MPG	1	3.300	1.497	0.188	0.005
BF7921	12	1.063	0.482	0.040	0.001	BF7996	6	4.280	1.941	0.290	0.008	PT8403-MPG	12	1.300	0.590	0.111	0.003
BF7922	12	1.596	0.724	0.070	0.002	BF7997	12	2.070	0.939	0.075	0.002	PT8404-MPG	12	2.525	1.145	0.122	0.003
BF7923	12	1.379	0.626	0.063	0.002	BF7998	12	1.050	0.476	0.045	0.001	PT8407	12	0.575	0.261	0.081	0.002
BF7924	12	1.454	0.660	0.072	0.002	BT8301	12	0.933	0.423	0.045	0.001	PT8408	1	3.100	1.406	0.342	0.010
BF7925	12	1.288	0.584	0.065	0.002	BT8302	12	2.083	0.945	0.109	0.003	BT8409	12	0.667	0.303	0.029	0.001
FD7926	1	0.300	0.136	0.062	0.002	BT8304	12	1.496	0.679	0.062	0.002	PT8410	1	3.500	1.588	0.626	0.018
BF7927	12	1.967	0.892	0.086	0.002	PT8305	4	2.825	1.281	0.539	0.015	PT8411	1	2.850	1.293	0.325	0.009
PF7928	12	1.154	0.523	0.107	0.003	PT8306-10	12	1.325	0.601	0.100	0.003	BT8412	12	1.396	0.633	0.090	0.003
BF7929 KIT	1	2.650	1.202	0.185	0.005	PT8306-25	12	1.287	0.584	0.098	0.003	BT8413	12	0.904	0.410	0.028	0.001
PF7930	6	1.075	0.488	0.108	0.003	BT8307-MPG	6	2.750	1.247	0.156	0.004	PT8414-MPG	1	2.600	1.179	0.198	0.006
BF7931	12	0.990	0.449	0.030	0.001	BT8308-MPG	6	3.650	1.656	0.263	0.007	BT8415	12	1.658	0.752	0.080	0.002
BF7932	6	4.158	1.886	0.155	0.004	BT8308-MPG KIT	1	7.050	3.198	0.924	0.026	BT8416	6	1.900	0.862	0.088	0.002
PF7934 KIT	12	1.004	0.455	0.128	0.004	BT8309-MPG	1	2.650	1.202	0.148	0.004	BT8417	12	1.088	0.494	0.032	0.001
PF7935	12	0.717	0.325	0.110	0.003	BT8310-MPG	1	3.550	1.610	0.225	0.006	BT8418	6	2.390	1.084	0.133	0.004
PF7936	12	0.567	0.257	0.067	0.002	BT8312	6	2.900	1.315	0.132	0.004	PT8419	12	1.075	0.488	0.080	0.002
BF7937	12	0.671	0.304	0.079	0.002	BT8314	12	1.050	0.476	0.053	0.001	BT8420	12	1.213	0.550	0.051	0.001
PF7938	6	0.642	0.291	0.072	0.002	BT8316-MPG	12	1.350	0.612	0.061	0.002	BT8421-MPG	1	2.650	1.202	0.136	0.004
PF7939	12	0.058	0.026	0.013	**	PT8318-MPG	12	1.575	0.714	0.096	0.003	BT8422-MPG	6	3.575	1.622	0.264	0.007
BF7940	12	1.583	0.718	0.069	0.002	PT8319	12	0.433	0.196	0.034	0.001	BT8423	1	2.650	1.202	0.162	0.005
BF7941	12	1.600	0.726	0.074	0.002	BT8320	6	4.950	2.245	0.224	0.006	BT8424-MPG	1	2.750	1.247	0.127	0.004
BF7942	12	1.704	0.773	0.075	0.002	BT8323	12	0.679	0.308	0.025	0.001	PT8425	1	0.600	0.272	0.112	0.003
BF7943	12	2.671	1.212	0.121	0.003	BT8328	12	1.421	0.645	0.052	0.001	BT8426-MPG	6	2.450	1.111	0.091	0.003
BF7944	12	0.400	0.181	0.033	0.001	PT8329	12	1.229	0.557	0.129	0.004	PT8427	1	1.450	0.658	0.138	0.004
BF7945	12	0.583	0.264	0.037	0.001	PT8330-MPG	6	1.242	0.563	0.143	0.004	BT8428-MPG	12	1.412	0.640	0.050	0.001
PF7946	6	0.783	0.355	0.159	0.004	PT8331-MPG	1	2.650	1.202	0.146	0.004	BT8429	12	0.425	0.193	0.031	0.001
PF7947	12	0.808	0.367	0.132	0.004	BT8333	6	1.617	0.733	0.085	0.002	BT8432-MPG	6	4.717	2.140	0.232	0.007
BF7948	6	3.017	1.369	0.161	0.005	PT8334	6	3.250	1.474	0.333	0.009	PT8433-MPG	1	3.200	1.452	0.301	0.009
BF7949-D	12	0.770	0.349	0.060	0.002	PT8335	6	2.292	1.040	0.225	0.006	PT8435-MPG	1	1.950	0.885	0.140	0.004
BF7949-DM	12	0.750	0.340	0.063	0.002	PT8338	12	1.233	0.559	0.134	0.004	PT8436	1	4.300	1.950	0.472	0.013
BF7950-D	12	0.650	0.295	0.045	0.001	PT8339	12	1.108	0.503	0.106	0.003	BT8437	6	3.550	1.610	0.146	0.004
BF7951-D	12	0.750	0.340	0.062	0.002	PT8341	12	0.238	0.108	0.020	0.001	BT8439-MPG	6	2.375	1.077	0.091	0.003
BF7952-D	12	0.617	0.280	0.051	0.001	PT8344	12	0.833	0.378	0.101	0.003	BT8440-MPG	12	1.471	0.667	0.064	0.002
BF7954-D	12	0.629	0.285	0.051	0.001	PT8345	12	0.725	0.329	0.081	0.002	PT8441	1	2.000	0.907	0.238	0.007
BF7956-D	12	0.583	0.264	0.061	0.002	BT8347	6	1.733	0.786	0.104	0.003	PT8442	1	3.050	1.383	0.232	0.007
BF7955	12	1.425	0.646	0.055	0.002	PT8350	12	0.579	0.263	0.048	0.001	BT8443	12	1.696	0.769	0.076	0.002
BF7957	12	1.746	0.792	0.062	0.002	PT8351	12	0.533	0.242	0.063	0.002	BT8444	12	2.158	0.979	0.076	0.002
BF7958	12	1.038	0.471	0.085	0.002	PT8352	12	0.387	0.176	0.037	0.001	BT8445	12	1.117	0.507	0.053	0.001
BF7959	12	0.588	0.267	0.047	0.001	PT8353	6	1.792	0.813	0.208	0.006	PT8446-MPG	1	3.550	1.610	0.214	0.006
BF7960	12	0.383	0.174	0.047	0.001	PT8354	12	0.454	0.206	0.047	0.001	PT8447-MPG	1	3.250	1.474	0.23	

BALDWIN WEIGHTS AND VOLUMES

BALDWIN NUMBER	CASE QTY.	WEIGHT (ea.) lbs.	WEIGHT (ea.) kgs.	Volume (ea.) ft ³	Volume (ea.) m ³	BALDWIN NUMBER	CASE QTY.	WEIGHT (ea.) lbs.	WEIGHT (ea.) kgs.	Volume (ea.) ft ³	Volume (ea.) m ³	BALDWIN NUMBER	CASE QTY.	WEIGHT (ea.) lbs.	WEIGHT (ea.) kgs.	Volume (ea.) ft ³	Volume (ea.) m ³
PT8453	4	2.000	0.907	0.208	0.006	OB8732	1	1.700	0.771	0.074	0.002	BT8903	12	1.500	0.680	0.084	0.002
PT8455-MPG	1	3.650	1.656	0.321	0.009	OB8741	1	1.600	0.726	0.072	0.002	BT8904-MPG	6	2.367	1.074	0.089	0.003
PT8456-MPG	1	1.700	0.771	0.116	0.003	OB8742	1	1.600	0.726	0.072	0.002	BT8905	12	1.088	0.494	0.050	0.001
BT8457-MPG	6	5.617	2.548	0.243	0.007	OB8743	1	1.600	0.726	0.072	0.002	BT8906	6	3.342	1.516	0.137	0.004
PT8458-MPG	1	0.950	0.431	0.048	0.001	OB8744	1	1.600	0.726	0.073	0.002	PT8907-MPG	12	1.054	0.478	0.071	0.002
PT8459	12	0.921	0.418	0.099	0.003	OB8745	1	1.600	0.726	0.074	0.002	BT8908	12	0.700	0.318	0.029	0.001
BT8460	12	0.950	0.431	0.031	0.001	OP8750	12	0.058	0.026	0.065	0.002	PT8909	1	4.400	1.996	0.464	0.013
PT8461	6	2.433	1.104	0.268	0.008	OP8751	12	0.040	0.018	0.065	0.002	BT8910-MPG	6	5.092	2.310	0.222	0.006
PT8462-MPG	12	1.188	0.539	0.089	0.003	OP8752	12	0.010	0.005	0.003	**	BT8911-MPG	6	4.950	2.245	0.222	0.006
BT8463-MPG	6	2.442	1.108	0.090	0.003	OP8753	12	0.010	0.005	0.004	**	PT8912	12	1.671	0.758	0.188	0.005
BT8464	6	2.208	1.002	0.089	0.003	OB8771	1	2.600	1.179	0.103	0.003	BT8913-MPG	12	1.671	0.758	0.062	0.002
BT8465	6	3.490	1.583	0.138	0.004	OB8772	1	2.700	1.225	0.102	0.003	BT8914	12	1.612	0.731	0.081	0.002
BT8466-MPG	1	3.400	1.542	0.113	0.003	OB8773	1	2.250	1.021	0.106	0.003	BT8915	1	3.450	1.565	0.197	0.006
PT8467	1	2.300	1.043	0.170	0.005	CFB8784	1	1.750	0.794	0.071	0.002	BT8916	12	0.800	0.363	0.037	0.001
PT8468	12	0.587	0.266	0.037	0.001	BT8800-MPG	1	4.600	2.087	0.227	0.006	BT8917	12	0.708	0.321	0.029	0.001
PT8470	12	0.971	0.440	0.100	0.003	BT8801-MPG	6	3.658	1.659	0.148	0.004	BT8918	12	1.104	0.501	0.048	0.001
BT8471-MPG	1	3.800	1.724	0.221	0.006	BT8802-MPG	6	3.517	1.595	0.148	0.004	BT8919	12	1.338	0.607	0.063	0.002
BT8472	12	1.229	0.557	0.051	0.001	BT8803-MPG	6	3.667	1.663	0.256	0.007	BT8920	12	2.296	1.041	0.112	0.003
BT8473	12	1.608	0.729	0.078	0.002	BT8805-MPG	1	5.050	2.291	0.231	0.007	BT8921	1	3.300	1.497	0.142	0.004
BT8474	12	1.542	0.699	0.074	0.002	BT8812-MPG	6	3.508	1.591	0.147	0.004	BT8922	12	1.779	0.807	0.059	0.002
BT8475	12	2.488	1.129	0.115	0.003	BT8813-MPG	1	4.250	1.928	0.231	0.007	BT8926	12	1.900	0.862	0.079	0.002
BT8475-MPG	6	3.170	1.438	0.130	0.004	BT8830	6	1.817	0.824	0.083	0.002	BT8927	6	2.858	1.296	0.124	0.004
BT8476	6	2.892	1.312	0.146	0.004	BT8831	1	1.900	0.862	0.090	0.003	BT8928	12	1.683	0.763	0.061	0.002
BT8476-MPG	6	3.575	1.622	0.155	0.004	BT8832	6	2.067	0.938	0.115	0.003	BT8930	6	2.825	1.281	0.125	0.004
BT8477	6	2.775	1.259	0.150	0.004	BT8833	6	2.092	0.949	0.115	0.003	BT8931	6	3.158	1.432	0.154	0.004
BT8477-MPG	6	3.658	1.659	0.156	0.004	BT8834-MPG	1	3.250	1.474	0.098	0.003	BT8935	12	1.483	0.673	0.059	0.002
PT8478	1	5.850	2.654	0.683	0.019	BT8840-MPG	6	2.258	1.024	0.091	0.003	BT8937	6	3.033	1.376	0.128	0.004
PT8479	1	1.450	0.658	0.204	0.006	BT8841-MPG	6	2.292	1.040	0.091	0.003	PT8938-MPG	1	7.050	3.198	0.589	0.017
PT8480	1	5.000	2.268	0.325	0.009	BT8842-MPG	6	2.233	1.013	0.091	0.003	PT8939-MPG	1	1.700	0.771	0.138	0.004
PT8481	12	0.750	0.340	0.063	0.002	BT8844	6	2.208	1.002	0.089	0.003	PT8940-MPG	1	1.250	0.567	0.040	0.001
PT8484	1	1.046	0.474	0.059	0.002	BT8843-MPG	6	2.358	1.070	0.092	0.003	PT8941-MPG	1	4.400	1.996	0.338	0.010
PT8485	12	0.325	0.147	0.047	0.001	BT8845	6	2.192	0.994	0.090	0.003	PT8943-MPG	1	15.950	7.235	1.161	0.033
BT8486	12	0.992	0.450	0.048	0.001	BT8846	6	2.300	1.043	0.092	0.003	PT8945-MPG	1	1.550	0.703	0.097	0.003
PT8487	12	0.712	0.323	0.083	0.002	BT8847	6	2.433	1.104	0.090	0.003	PT8946-MPG	1	0.500	0.227	0.030	0.001
BT8488	12	1.696	0.769	0.075	0.002	BT8848-MPG	6	2.700	1.225	0.130	0.004	PT8947-MPG	1	1.650	0.748	0.123	0.003
PT8489	1	1.700	0.771	0.276	0.008	BT8849-MPG	6	2.333	1.058	0.091	0.003	PT8948-MPG	1	0.800	0.363	0.053	0.001
PT8490-MPG	1	1.950	0.885	0.304	0.009	BT8850-MPG	6	3.133	1.421	0.130	0.004	PT8950-MPG	1	4.800	2.177	0.363	0.010
PT8491	1	6.250	2.835	0.479	0.014	BT8851-MPG	6	3.017	1.369	0.129	0.004	PT8951-MPG	1	2.550	1.157	0.201	0.006
PT8492	1	6.200	2.812	0.683	0.019	BT8852-MPG	6	3.375	1.531	0.133	0.004	PT8952-MPG	1	0.400	0.181	0.015	**
BT8493	12	1.229	0.557	0.049	0.001	BT8853-MPG	6	3.075	1.395	0.130	0.004	PT8954-MPG	1	0.500	0.227	0.022	0.001
PT8494	1	3.050	1.383	0.340	0.010	BT8855-MPG	6	3.067	1.391	0.130	0.004	PT8955-MPG	1	1.300	0.590	0.033	0.001
PT8495-MPG	1	1.750	0.794	0.295	0.008	BT8856-MPG	6	3.275	1.486	0.127	0.004	PT8956-MPG	1	0.700	0.318	0.042	0.001
PT8496-MPG	12	2.121	0.962	0.187	0.005	BT8861	6	2.983	1.353	0.128	0.004	PT8957-MPG	1	0.350	0.159	0.026	0.001
BT8497-MPG	12	1.987	0.901	0.086	0.002	BT8862	6	2.900	1.315	0.132	0.004	PT8958-MPG	1	1.100	0.499	0.125	0.004
PT8498	1	1.000	0.454	0.050	0.001	BT8863	6	3.008	1.364	0.132	0.004	PT8959-MPG	1	1.000	0.454	0.054	0.002
BT8499	12	0.929	0.421	0.051	0.001	BT8870-MPG	6	5.617	2.548	0.276	0.008	PT8960-MPG	1	0.200	0.091	0.009	**
BT8501-MPG	12	1.608	0.729	0.049	0.001	BT8873	6	4.550	2.064	0.221	0.006	PT8962-MPG	1	0.250	0.113	0.013	**
BT8502	12	1.162	0.527	0.050	0.001	BT8874-MPG	6	4.658	2.113	0.224	0.006	PT8963-MPG	1	0.550	0.249	0.033	0.001
BT8503-MPG	6	3.958	1.795	0.127	0.004	BT8875-MPG	6	3.692	1.675	0.157	0.004	PT8967-MPG	1	2.000	0.907	0.154	0.004
BT8504	12	1.275	0.578	0.062	0.002	BT8876-MPG	6	4.950	2.245	0.221	0.006	PT8969-MPG	1	2.500	1.134	0.211	0.006
BT8505	12	1.125	0.510	0.053	0.001	BT8877-MPG	6	4.725	2.143	0.223	0.006	PT8970-MPG	1	3.100	1.406	0.314	0.009
PT8506-MPG	1	2.850	1.293	0.229	0.006	BT8878-MPG	6	4.733	2.147	0.222	0.006	PT8971-MPG	1	3.550	1.610	0.396	0.011
PT8507-MPG	12	1.458	0.661	0.111	0.003	BT8879-MPG	6	5.142	2.332	0.225	0.006	PT8972-MPG	1	0.250	0.113	0.015	**
BT8509-MPG	12	2.267	1.028	0.086	0.002	BT8880-MPG	6	3.658	1.659	0.156	0.004	PT8974-MPG	1	0.550	0.249	0.033	0.001
BT8510-MPG	1	3.600	1.633	0.227	0.006	PT8883	12	0.992	0.450	0.079	0.002	PT8975-MPG	1	0.300	0.136	0.013	**
PT8511	1	1.900	0.862	0.272	0.008	PT8884-MPG	12	1.783	0.809	0.109	0.003	PT8978-MPG	1	0.650	0.295	0.037	0.001
BT8512	12	1.875	0.851	0.062	0.002	PT8885-MPG	12	1.933	0.877	0.130	0.004	PT8980-MPG	1	1.500	0.680	0.067	0.002
PT8517-MPG	1	3.100	1.406	0.318	0.009	BT8886-MPG	6	2.530	1.148	0.130	0.004	PT8981-MPG	1	3.750	1.701	0.194	0.005
PT8519-MPG	1	1.800	0.816	0.188	0.005	PT8887	1	0.550	0.249	0.037	0.001	PT8982-MPG	1	1.600	0.726	0.131	0.004
OV8700	1	0.350	0.159	0.067	0.002	PT8888	12	0.946	0.429	0.130	0.004	PT8984-MPG	1	0.700	0.318	0.032	0.001
OV8701	1	0.200	0.091	0.067	0.002	PT8889	4	3.113	1.412	0.377	0.011	PT8985-MPG	1	1.400	0.635	0.072	0.002
OS8703	1	0.250	0.113	0.067	0.002	BT8890-MPG	6	2.242	1.017	0.096	0.003	PT8986-MPG	1	0.550	0.249	0.034	0.001
OS8704	1	0.008	0.004	0.001	**	PT8891-MPG	1	3.350	1.520	0.276	0.008	PT8987-MPG	1	0.500	0.227	0.030	0.001
OS8705	1	0.006	0.003	0.001	**	BT8892-MPG	6	4.708	2.136	0.225	0.006	PT8989-MPG	1	0.600	0.272	0.043	0.001
OS8707	1	0.200	0.091	0.065	0.002	PT8893	6	2.083	0.945	0.211	0.006	PT8990-MPG	1	8.800	3.992	0.898	0.025
OP8709	1	0.030	0.014	0.001	**	PT8894-MPG	1	0.400	0.181	0.015	**	PT8991-MPG	1	0.500	0.227	0.016	**
OB8711	1	1.700	0.771	0.071	0.002	PT8895-MPG	1	0.400	0.181	0.018	0.001	PT8992-MPG	1	1.800	0.816	0.118	0.003
OB8712	1	1.850	0.839	0.072	0.002	PT8896	1	4.500	2.041	0.464	0.013	PT8993-MPG	1	2.250	1.021	0.217	0.

BALDWIN WEIGHTS AND VOLUMES

BALDWIN NUMBER	CASE QTY.	WEIGHT (ea.) lbs.	WEIGHT (ea.) kgs.	Volume (ea.) ft ³	Volume (ea.) m ³	BALDWIN NUMBER	CASE QTY.	WEIGHT (ea.) lbs.	WEIGHT (ea.) kgs.	Volume (ea.) ft ³	Volume (ea.) m ³	BALDWIN NUMBER	CASE QTY.	WEIGHT (ea.) lbs.	WEIGHT (ea.) kgs.	Volume (ea.) ft ³	Volume (ea.) m ³
H9001	1	3.100	1.406	0.228	0.006	PT9136	1	0.350	0.159	0.026	0.001	PT9236-MPG	1	0.350	0.159	0.020	0.001
H9007	1	5.950	2.699	0.430	0.012	PT9137	1	0.350	0.159	0.016	**	PT9237	1	0.450	0.204	0.040	0.001
H9013	1	13.700	6.214	0.966	0.027	PT9139	1	1.150	0.522	0.133	0.004	PT9238	12	1.104	0.501	0.080	0.002
H9014	1	12.150	5.511	0.936	0.026	PT9140	1	0.375	0.170	0.033	0.001	PT9239	12	0.504	0.229	0.036	0.001
H9020	1	6.650	3.016	0.494	0.014	PT9142	12	0.150	0.068	0.016	**	PT9240	1	0.250	0.113	0.015	**
H9021	1	6.950	3.153	0.501	0.014	PT9143	12	0.408	0.185	0.082	0.002	PT9242	1	0.600	0.272	0.040	0.001
H9024	1	9.500	4.309	0.970	0.027	PT9144	12	0.996	0.452	0.101	0.003	PT9244	1	4.650	2.109	0.338	0.010
H9036	1	1.700	0.771	0.144	0.004	PT9145	1	0.700	0.318	0.033	0.001	PT9245	1	1.550	0.703	0.131	0.004
H9037	1	1.800	0.816	0.190	0.005	PT9147	12	0.397	0.180	0.014	**	PT9246	1	1.400	0.635	0.155	0.004
H9039	1	3.450	1.565	0.310	0.009	PT9148	1	1.450	0.658	0.141	0.004	PT9247	1	7.350	3.334	0.614	0.017
H9041	1	0.300	0.136	0.017	**	PT9149	1	1.150	0.522	0.053	0.001	PT9248	1	0.700	0.318	0.051	0.001
H9042	1	0.300	0.136	0.023	0.001	PT9150	1	1.100	0.499	0.053	0.001	PT9250	1	3.500	1.588	0.397	0.011
H9043	1	0.350	0.159	0.023	0.001	PT9152	1	1.350	0.612	0.060	0.002	PT9251	1	3.000	1.361	0.236	0.007
H9043-V	1	0.350	0.159	0.023	0.001	PT9153	1	0.850	0.386	0.040	0.001	PT9254	1	2.150	0.975	0.195	0.006
H9044	1	0.300	0.136	0.019	0.001	PT9154	1	0.750	0.340	0.075	0.002	PT9255	1	0.350	0.159	0.015	**
H9045	1	0.550	0.249	0.041	0.001	PT9155	1	1.550	0.703	0.125	0.004	PT9256-MPG	1	0.550	0.249	0.040	0.001
H9046	1	0.500	0.227	0.037	0.001	PT9157	1	0.800	0.363	0.039	0.001	PT9257	1	1.050	0.476	0.163	0.005
H9047	1	0.500	0.227	0.035	0.001	PT9158	1	1.100	0.499	0.054	0.002	PT9258	1	2.100	0.953	0.203	0.006
H9048	1	0.500	0.227	0.035	0.001	PT9159	1	3.850	1.746	0.203	0.006	PT9259	1	1.600	0.726	0.079	0.002
H9049	1	0.450	0.204	0.021	0.001	PT9161	1	2.200	0.998	0.134	0.004	PT9260	12	0.538	0.244	0.061	0.002
H9050	1	0.200	0.091	0.014	**	PT9162	1	3.450	1.565	0.211	0.006	PT9261-MPG	1	3.250	1.474	0.293	0.008
H9051	1	0.950	0.431	0.032	0.001	PT9163	1	0.450	0.204	0.039	0.001	PT9264	1	0.650	0.295	0.056	0.002
H9052	1	0.500	0.227	0.038	0.001	BT9164	1	4.750	2.155	0.211	0.006	PT9266	1	0.400	0.181	0.024	0.001
H9054	1	0.600	0.272	0.020	0.001	PT9165	1	0.600	0.272	0.031	0.001	PT9267	1	0.400	0.181	0.024	0.001
H9055	1	0.900	0.408	0.019	0.001	PT9167	1	0.533	0.242	0.033	0.001	PT9268	1	1.800	0.816	0.082	0.002
H9056	1	0.950	0.431	0.020	0.001	PT9168	1	2.150	0.975	0.212	0.006	PT9272	1	2.500	1.134	0.238	0.007
H9058	1	2.550	1.157	0.178	0.005	PT9169	10	1.830	0.830	0.127	0.004	PT9277	1	1.700	0.771	0.161	0.005
H9060	1	2.750	1.247	0.173	0.005	PT9170	1	1.600	0.726	0.123	0.003	PT9278	1	0.700	0.318	0.056	0.002
H9062	1	4.150	1.882	0.281	0.008	PT9171	1	2.700	1.225	0.251	0.007	PT9279	1	1.050	0.476	0.090	0.003
H9069	1	0.800	0.363	0.044	0.001	PT9172	1	2.050	0.930	0.139	0.004	PT9282-MPG	1	0.650	0.295	0.024	0.001
H9070	1	0.700	0.318	0.036	0.001	PT9174	12	0.679	0.308	0.034	0.001	PT9283-MPG	1	5.100	2.313	0.332	0.009
H9071	1	0.750	0.340	0.034	0.001	PT9175	1	1.267	0.575	0.121	0.003	PT9284-MPG	1	1.250	0.567	0.082	0.002
H9072	1	0.750	0.340	0.037	0.001	PT9176	1	2.100	0.953	0.239	0.007	PT9285-MPG	1	0.600	0.272	0.040	0.001
H9072-V	1	0.700	0.318	0.033	0.001	PT9178	1	0.500	0.227	0.032	0.001	PT9286-MPG	1	0.800	0.363	0.038	0.001
H9073	1	1.150	0.522	0.058	0.002	PT9179	1	0.300	0.136	0.018	0.001	PT9287-MPG	1	0.500	0.227	0.030	0.001
H9074	1	1.100	0.499	0.059	0.002	PT9180	1	0.400	0.181	0.023	0.001	PT9288-MPG	1	2.850	1.293	0.249	0.007
H9075	1	1.100	0.499	0.059	0.002	PT9181	1	1.300	0.590	0.110	0.003	PT9289-MPG	1	0.450	0.204	0.024	0.001
H9075-V	1	1.150	0.522	0.059	0.002	PT9182	1	2.200	0.998	0.198	0.006	PT9290-MPG	1	3.350	1.520	0.253	0.007
H9076	1	1.100	0.499	0.058	0.002	PT9183	1	2.150	0.975	0.205	0.006	PT9291-MPG	1	1.300	0.590	0.095	0.003
H9076-V	1	1.150	0.522	0.059	0.002	PT9185	12	0.429	0.195	0.037	0.001	PT9293-MPG	1	0.650	0.295	0.033	0.001
H9077	1	1.850	0.839	0.149	0.004	PT9186	1	0.750	0.340	0.044	0.001	PT9295-MPG	1	0.300	0.136	0.017	**
H9078	1	1.600	0.726	0.090	0.003	PT9187	1	0.500	0.227	0.040	0.001	PT9296-MPG	1	0.450	0.204	0.024	0.001
H9078-V	1	1.750	0.794	0.160	0.005	PT9188	1	1.500	0.680	0.131	0.004	PT9297-MPG	1	1.850	0.839	0.103	0.003
H9079	1	1.650	0.748	0.090	0.003	PT9189	1	2.900	1.315	0.252	0.007	PT9300-MPG	1	1.150	0.522	0.052	0.001
H9080	1	1.650	0.748	0.090	0.003	PT9190	1	2.700	1.225	0.293	0.008	PT9302-MPG	1	0.500	0.227	0.014	**
H9081	1	1.600	0.726	0.090	0.003	PT9191	1	2.950	1.338	0.387	0.011	PT9303-MPG	1	2.800	1.270	0.139	0.004
H9082	1	1.700	0.771	0.093	0.003	PT9193	1	0.500	0.227	0.025	0.001	PT9304-MPG	1	0.750	0.340	0.022	0.001
H9083	1	2.300	1.043	0.177	0.005	PT9195	1	0.350	0.159	0.017	**	PT9306-MPG	1	3.800	1.724	0.396	0.011
H9084	1	2.100	0.953	0.117	0.003	PT9196	1	0.900	0.408	0.072	0.002	PT9307-MPG	1	1.050	0.476	0.056	0.002
H9085	1	2.150	0.975	0.117	0.003	PT9197	1	0.550	0.249	0.040	0.001	PT9308-MPG	1	0.300	0.136	0.015	**
H9086	1	2.200	0.998	0.118	0.003	PT9198	1	0.650	0.295	0.022	0.001	PT9309-MPG	1	0.650	0.295	0.031	0.001
H9087	1	2.000	0.907	0.117	0.003	PT9199	1	1.300	0.590	0.136	0.004	PT9310-MPG	1	0.250	0.113	0.014	**
H9092	1	2.600	1.179	0.095	0.003	PT9200	1	0.550	0.249	0.040	0.001	PT9311-MPG	1	0.400	0.181	0.016	**
H9093	1	4.300	1.950	0.146	0.004	PT9202	1	6.650	3.016	0.722	0.020	PT9312-MPG	1	0.850	0.386	0.032	0.001
H9096	1	1.150	0.522	0.059	0.002	PT9203	1	0.450	0.204	0.032	0.001	PT9313-MPG	1	1.550	0.703	0.067	0.002
H9097	1	1.050	0.476	0.068	0.002	PT9205	1	1.500	0.680	0.067	0.002	PT9315 KIT	1	0.700	0.318	0.043	0.001
H9103	1	2.500	1.134	0.068	0.002	PT9206	1	0.300	0.136	0.012	**	BT9316-MPG	1	2.100	0.953	0.088	0.002
H9107	1	0.500	0.227	0.017	**	PT9207	1	1.300	0.590	0.111	0.003	BT9318	12	1.467	0.665	0.044	0.001
H9108	1	0.500	0.227	0.018	0.001	PT9208	1	0.300	0.136	0.013	**	BT9320	1	3.300	1.497	0.162	0.005
H9110	1	0.500	0.227	0.017	**	PT9209	1	0.300	0.136	0.013	**	BT9321	12	1.517	0.688	0.069	0.002
H9111	1	0.550	0.249	0.066	0.002	PT9210	1	0.350	0.159	0.030	0.001	BT9324	6	2.958	1.342	0.124	0.004
H9112	1	0.700	0.318	0.039	0.001	PT9212	1	1.900	0.862	0.184	0.005	BT9326	1	1.050	0.476	0.044	0.001
H9113	1	0.800	0.363	0.041	0.001	PT9213	1	0.750	0.340	0.057	0.002	H9327	1	0.400	0.181	0.020	0.001
H9114	1	0.700	0.318	0.040	0.001	PT9214	12	0.650	0.295	0.056	0.002	PT9328-MPG	1	9.150	4.150	0.968	0.027
H9123	1	2.400	1.089	0.190	0.005	PT9215	1	0.600	0.272	0.057	0.002	PT9329	12	0.521	0.236	0.035	0.001
PT9125-MPG	1	7.150	3.243	0.650	0.018	PT9217	1	2.600	1.179	0.247	0.007	PT9330-MPG	1	0.550	0.249	0.024	0.001
PT9126	1	0.150	0.068	0.029	0.001	PT9221	1	0.200	0.091	0.015	**	PT9331	1	1.250	0.567	0.115	0.003
PT9127	12	0.521	0.236	0.048	0.001	PT9222	1	0.100	0.045	0.022	0.001	PT9332	1	1.000	0.454	0.089	0.003
PT9129	1	1.350	0.612	0.166	0.005	PT9223	1	0.400	0.181	0.026	0.001	PT9335-MPG	1	2.500	1.134	0.136	0.004
PT9130	1	2.000	0.907	0.140	0.004	PT9224	1	0.900	0.408								

BALDWIN WEIGHTS AND VOLUMES

BALDWIN NUMBER	CASE QTY.	WEIGHT (ea.) lbs.	WEIGHT (ea.) kgs.	Volume (ea.) ft ³	Volume (ea.) m ³	BALDWIN NUMBER	CASE QTY.	WEIGHT (ea.) lbs.	WEIGHT (ea.) kgs.	Volume (ea.) ft ³	Volume (ea.) m ³	BALDWIN NUMBER	CASE QTY.	WEIGHT (ea.) lbs.	WEIGHT (ea.) kgs.	Volume (ea.) ft ³	Volume (ea.) m ³
BT9343-MPG	6	3.900	1.769	0.149	0.004	PT9417	12	0.242	0.110	0.035	0.001	PT9500-MPG	1	6.900	3.130	0.421	0.012
PT9344	12	0.725	0.329	0.082	0.002	PT9418	12	1.746	0.792	0.189	0.005	PT9501-MPG	1	2.050	0.930	0.128	0.004
BT9345	6	3.367	1.527	0.259	0.007	PT9419-MPG	12	0.542	0.246	0.038	0.001	PT9502-MPG	1	1.100	0.499	0.057	0.002
BT9346-MPG	12	1.450	0.658	0.061	0.002	PT9420-MPG	1	1.250	0.567	0.088	0.002	PT9503-MPG	1	1.250	0.567	0.086	0.002
BT9347-MPG	6	5.345	2.424	0.168	0.005	BT9421-MPG	6	5.633	2.555	0.224	0.006	PT9504-MPG	1	1.700	0.771	0.111	0.003
PT9348-MPG	1	7.500	3.402	0.464	0.013	BT9422	6	3.080	1.397	0.140	0.004	PT9505-MPG	1	1.400	0.635	0.088	0.002
BT9349-MPG	6	1.658	0.752	0.084	0.002	PT9423	12	0.325	0.147	0.022	0.001	PT9506	1	2.350	1.066	0.141	0.004
PT9350-MPG	1	10.300	4.672	1.250	0.035	PT9424	12	0.129	0.059	0.011	0.000	PT9507	1	2.200	0.998	0.241	0.007
PT9351-MPG	1	2.650	1.202	0.213	0.006	PT9425-MPG	6	2.100	0.953	0.176	0.005	PT9508	1	0.700	0.318	0.030	0.001
PT9352	1	2.050	0.930	0.189	0.005	PT9426	12	0.133	0.060	0.009	0.000	PT9509	1	2.350	1.066	0.218	0.006
BT9353-MPG	6	5.183	2.351	0.224	0.006	PT9427-MPG	6	5.183	2.351	0.337	0.010	PT9510	1	0.250	0.113	0.016	0.000
PT9354-MPG	12	0.688	0.312	0.040	0.001	PT9429-MPG	1	2.850	1.293	0.182	0.005	PT9511	1	1.500	0.680	0.110	0.003
PT9355-MPG	1	10.900	4.944	0.639	0.018	PT9430-MPG	12	2.083	0.945	0.140	0.004	PT9512	1	0.550	0.249	0.022	0.001
BT9356	6	2.575	1.168	0.127	0.004	PT9432-MPG	1	2.450	1.111	0.201	0.006	PT9513	1	1.650	0.748	0.172	0.005
PT9357	1	4.850	2.200	0.474	0.013	BT9433	6	3.250	1.474	0.129	0.004	PT9514	1	0.800	0.363	0.042	0.001
PT9358	1	3.000	1.361	0.076	0.002	PT9434	12	0.696	0.316	0.070	0.002	PT9515	1	3.250	1.474	0.281	0.008
PT9359-MPG	1	2.400	1.089	0.138	0.004	PT9435-MPG	12	0.375	0.170	0.037	0.001	PT9516	1	0.400	0.181	0.025	0.001
BT9360	1	6.350	2.880	0.182	0.005	BT9436-MPG	6	2.433	1.104	0.091	0.003	PT9517	1	2.150	0.975	0.203	0.006
PT9361	1	4.400	1.996	0.474	0.013	BT9437	12	2.613	1.185	0.117	0.003	PT9518-MPG	1	5.100	2.313	0.431	0.012
BT9362-MPG	6	4.708	2.136	0.222	0.006	BT9439	6	2.900	1.315	0.154	0.004	PT9519-MPG	1	1.900	0.862	0.105	0.003
BT9363-MPG	6	3.183	1.444	0.130	0.004	BT9440	6	1.833	0.831	0.066	0.002	PT9520-MPG	1	5.300	2.404	0.642	0.018
BT9364	6	2.242	1.017	0.089	0.003	PT9441-MPG	6	3.742	1.697	0.329	0.009	PT9522-MPG	1	1.000	0.454	0.053	0.001
BT9365-MPG	6	4.950	2.245	0.227	0.006	BT9442-MPG	12	1.217	0.552	0.051	0.001	PT9523-MPG	1	3.250	1.474	0.238	0.007
BT9366-MPG	6	3.325	1.508	0.131	0.004	PT9443	1	4.450	2.019	0.263	0.007	PT9524-MPG	1	14.950	6.781	1.550	0.044
BT9367-MPG	6	5.467	2.480	0.169	0.005	PT9444-MPG	6	3.925	1.780	0.328	0.009	PT9525-MPG	1	2.300	1.043	0.118	0.003
BT9368-MPG	6	3.450	1.565	0.110	0.003	PT9445-MPG	1	4.300	1.950	0.375	0.011	PT9526-MPG	1	1.300	0.590	0.083	0.002
BT9369-MPG	6	4.410	2.000	0.149	0.004	PT9446	12	1.642	0.745	0.123	0.003	PT9528	1	5.500	2.495	0.601	0.017
BT9370-MPG	6	3.433	1.557	0.129	0.004	PT9447	12	1.038	0.471	0.071	0.002	PT9529	1	3.000	1.361	0.137	0.004
BT9371-MPG	6	2.775	1.259	0.160	0.005	PT9448	12	1.067	0.484	0.078	0.002	PT9530	1	1.750	0.794	0.232	0.007
PT9372	1	1.300	0.590	0.109	0.003	PT9449	12	0.546	0.248	0.041	0.001	PT9531	1	1.700	0.771	0.085	0.002
PT9373-MPG	1	2.400	1.089	0.114	0.003	PT9450-MPG	12	1.633	0.741	0.093	0.003	PT9532	6	2.892	1.312	0.151	0.004
PT9374	12	0.521	0.236	0.052	0.001	PT9451-MPG	1	10.950	4.967	0.709	0.020	BT9533	1	3.650	1.656	0.165	0.005
PT9375	4	3.600	1.633	0.366	0.010	PT9452	1	5.000	2.268	0.500	0.014	PT9535-MPG	1	0.950	0.431	0.058	0.002
PT9376	1	2.150	0.975	0.171	0.005	PT9453-MPG	4	2.840	1.288	0.240	0.007	PT9536-MPG	1	0.750	0.340	0.068	0.002
BT9377	1	3.950	1.792	0.229	0.006	BT9454	1	4.150	1.882	0.124	0.004	PT9537-MPG	12	0.225	0.102	0.020	0.001
PT9378-MPG	1	0.500	0.227	0.024	0.001	BT9456	12	1.200	0.544	0.046	0.001	BT9553	12	1.360	0.617	0.050	0.001
PT9379	1	6.150	2.790	0.693	0.020	PT9459-MPG	1	15.500	7.031	1.015	0.029	PT9554-MPG	1	4.350	1.973	0.328	0.009
PT9381-MPG	1	1.450	0.658	0.114	0.003	PT9462	12	0.363	0.165	0.020	0.001	PT9555	12	1.300	0.590	0.134	0.004
PT9380-MPG	12	2.575	1.168	0.139	0.004	PT9463	12	0.858	0.389	0.100	0.003	PT9556-MPG	1	5.750	2.608	0.452	0.013
BT9382	12	1.271	0.577	0.055	0.002	BT9464	6	1.925	0.873	0.091	0.003	PT9557	1	6.000	2.722	0.481	0.014
PT9383-MPG	1	6.000	2.722	0.551	0.016	BT9465	12	1.104	0.501	0.051	0.001	BT9558-MPG	6	2.850	1.293	0.123	0.003
PT9384-MPG	1	1.350	0.612	0.049	0.001	BT9466-MPG	6	3.350	1.520	0.138	0.004	PT9559-MPG	1	1.950	0.885	0.093	0.003
PT9385-MPG	1	3.400	1.542	0.322	0.009	PT9468	1	0.450	0.204	0.015	0.000	BT9560-MPG	6	5.516	2.502	0.280	0.008
PT9386-MPG	12	1.333	0.605	0.140	0.004	PT9469	12	0.100	0.045	0.007	0.000	PT9561	12	1.250	0.567	0.047	0.001
BT9387	6	3.892	1.765	0.165	0.005	PT9470	12	1.075	0.488	0.019	0.001	P9600	12	0.192	0.087	0.030	0.001
BT9388	12	0.579	0.263	0.033	0.001	BT9471	12	1.117	0.507	0.041	0.001	B9601	12	1.908	0.865	0.092	0.003
PT9389-MPG	1	1.400	0.635	0.114	0.003	PT9472	1	3.050	1.383	0.295	0.008	P9602	12	0.258	0.117	0.029	0.001
PT9390-MPG	1	1.800	0.816	0.091	0.003	PT9473	6	4.158	1.886	0.078	0.002	P9603	12	0.104	0.047	0.012	0.000
BT9391-MPG	6	4.800	2.177	0.221	0.006	PT9474	12	0.625	0.284	0.020	0.001	B9604	12	2.330	1.057	0.121	0.003
BT9392-MPG	6	2.533	1.149	0.131	0.004	S9475	12	0.013	0.006	0.005	0.000	P9605	12	0.175	0.079	0.027	0.001
BT9393-MPG	6	1.500	0.680	0.085	0.002	PT9476-MPG	1	1.200	0.544	0.166	0.005	B9606	12	2.440	1.107	0.134	0.004
PT9394-MPG	12	0.871	0.395	0.054	0.002	PT9477	1	0.250	0.113	0.016	0.000	B9607	12	2.320	1.052	0.134	0.004
PT9395-MPG	6	1.100	0.499	0.141	0.004	PT9478-MPG	1	0.300	0.136	0.013	0.000	BF9800	12	2.654	1.204	0.122	0.003
PT9396	12	0.467	0.212	0.038	0.001	PT9479-MPG	1	1.450	0.658	0.081	0.002	PF9801	12	0.388	0.176	0.040	0.001
PT9397-MPG	1	1.950	0.885	0.113	0.003	PT9480-MPG	1	5.400	2.449	0.540	0.015	BF9802	12	2.660	1.207	0.123	0.003
BT9398-MPG	6	1.975	0.896	0.085	0.002	PT9481-MPG	1	0.250	0.113	0.025	0.001	PF9803	12	0.538	0.244	0.051	0.001
PT9399-MPG	1	5.050	2.291	0.474	0.013	PT9482-MPG	1	0.550	0.249	0.024	0.001	PF9804	6	2.408	1.092	0.259	0.007
BT9400-MPG	6	2.558	1.160	0.105	0.003	PT9483-MPG	1	2.950	1.338	0.197	0.006	BF9805	12	0.510	0.231	0.048	0.001
PT9401	1	2.700	1.225	0.300	0.008	PT9484-MPG	1	0.900	0.408	0.016	0.000	BF9807	12	0.313	0.142	0.037	0.001
BT9402	12	1.113	0.505	0.039	0.001	PT9485-MPG	1	2.000	0.907	0.032	0.001	BF9808-D	12	0.617	0.280	0.047	0.001
PT9403-MPG	1	5.200	2.359	0.244	0.007	PT9486-MPG	1	1.000	0.454	0.043	0.001	BF9809-D	12	0.925	0.420	0.088	0.002
PT9404-MPG	1	0.700	0.318	0.036	0.001	PT9487-MPG	1	4.250	1.928	0.285	0.008	BF9810-D	12	0.767	0.348	0.064	0.002
PT9405	12	1.479	0.671	0.121	0.003	PT9488-MPG	1	4.300	1.950	0.291	0.008	BF9811-SP	12	2.308	1.047	0.101	0.003
PT9406-MPG	1	0.950	0.431	0.033	0.001	PT9489-MPG	1	2.850	1.293	0.141	0.004	BF9812	12	1.220	0.553	0.060	0.002
PT9407-MPG	1	2.400	1.089	0.231	0.007	PT9490-MPG	1	1.050	0.476	0.041	0.001	BF9813	12	1.325	0.601	0.069	0.002
BT9408	12	0.725	0.329	0.031	0.001	PT9491-MPG	1	1.058	0.480	0.038	0.001	PF9814	12	1.117	0.507	0.106	0.003
PT9409-MPG	1	1.400	0.635	0.072	0.002	PT9492-MPG	1	2.600	1.179	0.074	0.002	BF9815	12	1.408	0.639	0.066	0.002
PT9410-MPG	1	1.850	0.839	0.093	0.003	PT9493-MPG	1	0.550	0.249								

BALDWIN WEIGHTS AND VOLUMES

BALDWIN NUMBER	CASE QTY.	WEIGHT (ea.) lbs.	WEIGHT (ea.) kgs.	Volume (ea.) ft ³	Volume (ea.) m ³	BALDWIN NUMBER	CASE QTY.	WEIGHT (ea.) lbs.	WEIGHT (ea.) kgs.	Volume (ea.) ft ³	Volume (ea.) m ³	BALDWIN NUMBER	CASE QTY.	WEIGHT (ea.) lbs.	WEIGHT (ea.) kgs.	Volume (ea.) ft ³	Volume (ea.) m ³
PF9823	12	0.246	0.112	0.037	0.001	PF9900	12	1.000	0.454	0.061	0.002	PA10046	6	1.050	0.476	0.206	0.006
PF9824	12	0.575	0.261	0.059	0.002	PF9901 KIT	12	0.729	0.331	0.102	0.003	PA10047	6	1.058	0.480	0.145	0.004
PF9825	12	0.200	0.091	0.036	0.001	PF9902	12	0.183	0.083	0.055	0.002	PA10057	6	0.800	0.363	0.122	0.003
PF9826	12	1.238	0.562	0.108	0.003	BF9903-SP	12	2.562	1.162	0.123	0.003	PA10058	6	0.883	0.401	0.135	0.004
BF9827-D	12	0.692	0.314	0.064	0.002	BF9904	12	1.079	0.489	0.086	0.002	PA10060	6	1.050	0.476	0.210	0.006
BF9828-D	12	0.596	0.270	0.051	0.001	BF9905	12	0.246	0.112	0.029	0.001	PA10061	1	2.350	1.066	0.776	0.022
PF9829 KIT	1	1.500	0.680	0.403	0.011	BF9906	12	0.138	0.063	0.034	0.001	PA10062	6	0.975	0.442	0.296	0.008
BF9830-D	12	0.463	0.210	0.053	0.001	PF9907	12	0.121	0.055	0.013	**	PA10066	6	0.283	0.128	0.064	0.002
BF9831	12	1.364	0.619	0.082	0.002	PF9908 KIT	1	1.900	0.862	0.191	0.005	PA10067	6	0.583	0.264	0.089	0.003
BF9832	12	2.266	1.028	0.069	0.002	PF9909	12	0.292	0.132	0.033	0.001	PA10068	1	1.900	0.862	0.507	0.014
BF9833-D	12	0.588	0.267	0.051	0.001	BF9910	12	1.042	0.473	0.040	0.001	PA10070	6	0.717	0.325	0.102	0.003
BF9834	12	1.613	0.732	0.080	0.002	PF9911	12	0.079	0.036	0.007	**	PA10071	6	0.792	0.359	0.097	0.003
BF9835-D	12	0.591	0.268	0.053	0.001	BF9912-O	12	1.550	0.703	0.061	0.002	PA10072	6	1.267	0.575	0.204	0.006
BF9836-D	12	0.521	0.236	0.051	0.001	BF9913	12	0.750	0.340	0.079	0.002	PA10073	6	0.891	0.404	0.107	0.003
BF9837-D	12	0.780	0.354	0.058	0.002	PF9914 KIT	6	1.292	0.586	0.183	0.005	PA30183	1	2.950	1.338	0.231	0.007
PF9838	12	0.362	0.164	0.039	0.001	BF9915	12	0.592	0.269	0.035	0.001	CV15000	4	1.637	0.743	0.240	0.007
BF9839-D	12	0.667	0.303	0.063	0.002	BF9916	12	0.196	0.089	0.017	**	CV15001	12	0.338	0.153	0.033	0.001
BF9840	12	1.000	0.454	0.038	0.001	BF9917	12	2.950	1.338	0.130	0.004	CV15002	1	0.700	0.318	0.075	0.002
BF9841	12	0.867	0.393	0.035	0.001	BF9918 KIT	6	2.075	0.941	0.156	0.004	CV15003	12	0.496	0.225	0.106	0.003
BF9842	12	0.750	0.340	0.041	0.001	PF9919	12	0.600	0.272	0.061	0.002	CV15004	1	1.050	0.476	0.173	0.005
BF9843	12	1.290	0.585	0.056	0.002	BF9920	6	3.567	1.618	0.173	0.005	CV15005	6	1.008	0.457	0.221	0.006
BF9844	12	2.550	1.157	0.115	0.003	BF9921-O	12	2.704	1.227	0.180	0.005	CV15006	1	0.800	0.363	0.086	0.002
PF9845	12	0.287	0.130	0.032	0.001	BF9922-O	12	1.204	0.546	0.059	0.002	BA16000	1	4.700	2.132	0.234	0.007
BF9846	12	0.750	0.340	0.060	0.002	BF9923-O	12	1.313	0.596	0.066	0.002	PE17001	12	0.225	0.102	0.020	0.001
BF9847-D	12	0.621	0.282	0.051	0.001	PF9924 KIT	6	2.350	1.066	0.226	0.006	18003	6	0.758	0.344	0.073	0.002
BF9848	12	0.483	0.219	0.060	0.002	BF9925-O	12	1.650	0.748	0.108	0.003	18004	6	0.833	0.378	0.096	0.003
BF9849	12	1.463	0.664	0.066	0.002	BF9926-O	12	1.171	0.531	0.057	0.002	18007	6	1.030	0.467	0.225	0.006
BF9850	12	1.655	0.751	0.070	0.002	BF9927	12	1.833	0.831	0.077	0.002	18010	6	1.375	0.624	0.293	0.008
BF9851	12	0.675	0.306	0.078	0.002	PF9928	12	1.080	0.490	0.124	0.004	18015	6	0.575	0.261	0.076	0.002
BF9852	12	1.546	0.701	0.085	0.002	PF9929	12	1.033	0.469	0.107	0.003	18022	6	1.250	0.567	0.146	0.004
BF9853	12	0.728	0.330	0.037	0.001	PA10000	6	7.000	3.181	0.134	0.004	18024	6	1.000	0.454	0.145	0.004
BF9854	12	1.346	0.611	0.065	0.002	PA10001	6	1.358	0.616	0.211	0.006	18025	6	1.017	0.461	0.142	0.004
BF9857	12	0.363	0.165	0.063	0.002	PA10002	6	0.400	0.181	0.062	0.002	18027	6	1.108	0.503	0.292	0.008
BF9858 KIT	1	2.550	1.157	0.188	0.005	PA10003	6	0.808	0.367	0.194	0.005	18029	6	1.042	0.473	0.147	0.004
BF9860	6	5.150	2.336	0.175	0.005	PA10004	6	0.916	0.415	0.129	0.004	18032	6	0.675	0.306	0.059	0.002
PF9861	12	0.379	0.172	0.047	0.001	RS10005	1	0.900	0.408	0.151	0.004	18033	6	1.010	0.458	0.144	0.004
PF9862	12	0.183	0.083	0.018	0.001	PA10006	6	1.033	0.469	0.147	0.004	18034	6	0.966	0.438	0.143	0.004
BF9863	12	0.179	0.081	0.019	0.001	PA10007	6	0.716	0.325	0.211	0.006	18055	6	0.858	0.389	0.074	0.002
BF9864	6	3.228	1.464	0.166	0.005	PA10008	6	0.825	0.374	0.104	0.003	18056	6	1.100	0.499	0.230	0.007
PF9865	12	0.442	0.200	0.056	0.002	PA10009	1	0.300	0.136	0.063	0.002	18057	6	1.392	0.631	0.207	0.006
BF9866-O	12	2.460	1.116	0.130	0.004	PA10010	6	0.767	0.348	0.136	0.004	18104	6	0.633	0.287	0.059	0.002
BF9867-O	12	2.317	1.051	0.127	0.004	PA10011	6	0.500	0.227	0.196	0.006	18155	6	1.150	0.522	0.229	0.006
PF9868	12	0.729	0.331	0.086	0.002	PA10012	6	1.550	0.703	0.370	0.010	18171	6	0.933	0.423	0.145	0.004
BF9869	12	2.213	1.004	0.100	0.003	PA10013	6	0.692	0.314	0.123	0.003	18198	6	1.217	0.552	0.146	0.004
PF9870	12	0.650	0.295	0.084	0.002	PA10014	6	0.450	0.204	0.091	0.003	18236	6	1.330	0.603	0.137	0.004
BF9871-O	12	1.900	0.862	0.089	0.003	PA10015	6	1.091	0.495	0.154	0.004	18245	6	1.016	0.461	0.146	0.004
PF9872	12	0.554	0.251	0.056	0.002	PA10016	6	0.200	0.091	0.042	0.001	18264	6	1.425	0.646	0.295	0.008
PF9873	12	0.050	0.023	0.005	**	PA10017	6	0.458	0.208	0.103	0.003	18265	6	1.450	0.658	0.290	0.008
BF9874-DM	12	0.613	0.278	0.052	0.001	PA10018	1	0.900	0.408	0.103	0.003	18267	6	0.742	0.337	0.143	0.004
BF9875-DM	12	0.650	0.295	0.053	0.001	PA10020	1	0.700	0.318	0.309	0.009	19593	6	1.033	0.469	0.144	0.004
BF9876	12	1.267	0.575	0.059	0.002	RS10021	1	1.650	0.748	0.358	0.010	19739	1	2.400	1.089	0.194	0.005
BF9877	12	1.075	0.488	0.041	0.001	PA10022	6	1.666	0.756	0.218	0.006	19828	6	0.525	0.238	0.074	0.002
BF9878	12	1.442	0.654	0.068	0.002	PA10023	6	1.158	0.525	0.172	0.005	19992	6	1.325	0.601	0.145	0.004
PF9879	6	1.042	0.473	0.162	0.005	PA10024	6	1.375	0.624	0.255	0.007	19996	6	1.700	0.771	0.289	0.008
BF9880	12	2.790	1.266	0.144	0.004	PA10025	6	0.808	0.367	0.117	0.003	19999	6	1.620	0.735	0.292	0.008
BF9881	12	1.020	0.463	0.079	0.002	PA10026	6	1.097	0.498	0.126	0.004	20000	6	1.750	0.794	0.287	0.008
BF9882	12	1.850	0.839	0.080	0.002	PA10027	6	0.975	0.442	0.134	0.004	20001	6	1.050	0.476	0.141	0.004
BF9883	12	1.383	0.627	0.067	0.002	PA10028	6	0.625	0.284	0.087	0.002	20002	6	1.267	0.575	0.303	0.009
BF9884	12	0.071	0.032	0.010	**	PA10030	6	0.375	0.170	0.073	0.002	20003	6	1.375	0.624	0.293	0.008
BF9885	6	4.217	1.913	0.140	0.004	PA10031	6	0.450	0.204	0.086	0.002	20004	6	1.342	0.609	0.293	0.008
BF9886	12	0.300	0.136	0.018	0.001	PA10032	6	0.442	0.200	0.131	0.004	20005	6	0.942	0.427	0.289	0.008
BF9887	12	0.975	0.442	0.046	0.001	PA10033	6	1.625	0.737	0.410	0.012	20008	6	0.725	0.329	0.073	0.002
BF9888	6	2.533	1.149	0.147	0.004	PA10034	1	0.350	0.159	0.096	0.003	20009	6	0.992	0.450	0.072	0.002
PF9889	12	0.833	0.378	0.085	0.002	RS10035	1	2.000	0.907	0.415	0.012	20010	6	0.692	0.314	0.059	0.002
PF9890	12	0.592	0.269	0.050	0.001	PA10036	6	1.267	0.575	0.165	0.005	20011	6	1.142	0.518	0.288	0.008
BF9891-D	12	0.850	0.386	0.063	0.002	PA10037	6	0.833	0.378	0.160	0.005	20012	6	1.042	0.473	0.142	0.004
BF9892-D	12	0.642	0.291	0.048	0.001	PA10038	6	0.692	0.314	0.098	0.003	20013	6	1.067	0.484	0.144	0.004
BF9893	12	1.333	0.605	0.068	0.002	PA10039	6	0.742	0.337	0.110	0.003	20014	6	1.333	0.605	0.197	0.006
BF9894	12	1.279	0.580														

BALDWIN WEIGHTS AND VOLUMES

BALDWIN NUMBER	CASE QTY.	WEIGHT (ea.) lbs.	WEIGHT (ea.) kgs.	Volume (ea.) ft ³	Volume (ea.) m ³	BALDWIN NUMBER	CASE QTY.	WEIGHT (ea.) lbs.	WEIGHT (ea.) kgs.	Volume (ea.) ft ³	Volume (ea.) m ³	BALDWIN NUMBER	CASE QTY.	WEIGHT (ea.) lbs.	WEIGHT (ea.) kgs.	Volume (ea.) ft ³	Volume (ea.) m ³
20022	1	1.050	0.476	0.433	0.012	PT23069-MPG	1	0.350	0.159	0.014	**	PT23146	1	1.100	0.499	0.082	0.002
20023	6	1.342	0.609	0.147	0.004	PT23070-MPG	1	3.350	1.520	0.336	0.010	PT23147	1	1.750	0.794	0.135	0.004
20024	1	0.850	0.386	0.225	0.006	PT23071-MPG	1	1.150	0.522	0.042	0.001	PT23148	1	1.250	0.567	0.082	0.002
20025	6	1.000	0.454	0.275	0.008	PT23072-MPG	1	2.750	1.247	0.157	0.004	PT23149	1	1.400	0.635	0.085	0.002
BW21000	12	1.504	0.682	0.064	0.002	PT23073-MPG	1	0.309	0.140	0.013	**	PT23150	1	1.200	0.544	0.116	0.003
PT23000	1	2.350	1.066	0.247	0.007	PT23074-MPG	1	0.650	0.295	0.016	**	PT23151	1	3.150	1.429	0.522	0.015
PT23001	1	2.550	1.157	0.251	0.007	PT23075-MPG	1	1.350	0.612	0.038	0.001	PT23152	1	3.400	1.542	0.378	0.011
PT23002	1	1.058	0.480	0.049	0.001	PT23076-MPG	1	1.191	0.540	0.049	0.001	PT23154	1	1.600	0.726	0.157	0.004
PT23003	1	1.900	0.862	0.212	0.006	PT23077-MPG	1	0.550	0.249	0.023	0.001	PT23155	1	2.500	1.134	0.104	0.003
PT23004	1	2.600	1.179	0.233	0.007	PT23078-MPG	1	0.850	0.386	0.055	0.002	PT23156	1	2.800	1.270	0.241	0.007
PT23005	1	0.650	0.295	0.054	0.002	PT23079-MPG	1	1.700	0.771	0.093	0.003	PT23157	1	14.400	6.532	1.972	0.056
PT23006	1	0.485	0.220	0.025	0.001	PT23080-MPG	1	1.800	0.816	0.082	0.002	PT23158	1	2.600	1.179	0.301	0.009
PT23007	1	0.500	0.227	0.031	0.001	PT23081-MPG	1	2.750	1.247	0.137	0.004	PT23159	1	2.150	0.975	0.192	0.005
PT23008	1	0.550	0.249	0.039	0.001	PT23082-MPG	1	0.450	0.204	0.032	0.001	PT23160	1	1.200	0.544	0.059	0.002
PT23009	1	0.750	0.340	0.053	0.001	PT23083-MPG	1	0.450	0.204	0.033	0.001	PT23161	1	1.550	0.703	0.085	0.002
PT23010	1	2.050	0.930	0.124	0.004	PT23084-MPG	1	0.750	0.340	0.029	0.001	PT23162	1	0.838	0.380	0.046	0.001
PT23011	1	2.600	1.179	0.277	0.008	PT23085-MPG	1	1.550	0.703	0.072	0.002	PT23163	1	1.500	0.680	0.081	0.002
PT23012	1	1.250	0.567	0.098	0.003	PT23086-MPG	1	0.300	0.136	0.016	**	PT23164	1	0.300	0.136	0.015	**
PT23013	1	1.550	0.703	0.114	0.003	PT23087-MPG	1	0.300	0.136	0.013	**	PT23165	1	1.250	0.567	0.152	0.004
PT23014	1	2.601	1.180	0.099	0.003	PT23088-MPG	1	0.300	0.136	0.013	**	PT23166	1	1.550	0.703	0.082	0.002
PT23015	1	0.900	0.408	0.057	0.002	PT23089-MPG	1	2.250	1.021	0.121	0.003	PT23167	1	2.250	1.021	0.237	0.007
PT23016	1	0.850	0.386	0.056	0.002	PT23090-MPG	1	0.450	0.204	0.015	**	PT23168	1	2.600	1.179	0.104	0.003
PT23017	1	0.500	0.227	0.023	0.001	PT23091-MPG	1	0.700	0.318	0.033	0.001	PT23169	1	2.200	0.998	0.188	0.005
PT23018	1	0.300	0.136	0.017	**	PT23092-MPG	1	0.700	0.318	0.032	0.001	PT23170	1	2.700	1.225	0.241	0.007
PT23019	1	2.469	1.120	0.222	0.006	PT23093-MPG	1	1.150	0.522	0.053	0.001	PT23171	1	0.300	0.136	0.018	0.001
PT23020	1	2.000	0.907	0.110	0.003	PT23094-MPG	1	1.500	0.680	0.084	0.002	PT23172	1	0.800	0.363	0.053	0.001
PT23021	1	0.500	0.227	0.023	0.001	PT23095-MPG	1	0.550	0.249	0.024	0.001	PT23173	1	2.450	1.111	0.241	0.007
PT23022	1	2.161	0.980	0.099	0.003	PT23096-MPG	1	0.485	0.220	0.010	**	PT23174	1	3.350	1.520	0.245	0.007
PT23023	1	2.954	1.340	0.146	0.004	PT23097-MPG	1	0.300	0.136	0.017	**	PT23175	1	0.550	0.249	0.032	0.001
PT23024	1	1.250	0.567	0.098	0.003	PT23098-MPG	1	2.900	1.315	0.302	0.009	PT23176	1	0.850	0.386	0.057	0.002
PT23025	1	1.455	0.660	0.060	0.002	PT23099-MPG	1	2.850	1.293	0.243	0.007	PT23178	1	1.050	0.476	0.082	0.002
PT23026	1	1.499	0.680	0.060	0.002	PT23100-MPG	1	0.300	0.136	0.017	**	PT23179	1	1.250	0.567	0.110	0.003
PT23027	1	2.400	1.089	0.158	0.004	PT23101-MPG	1	3.350	1.520	0.231	0.007	PT23180	1	2.400	1.089	0.229	0.006
PT23028-MPG	1	1.720	0.780	0.038	0.001	PT23102-MPG	1	0.900	0.408	0.044	0.001	PT23181	1	1.750	0.794	0.113	0.003
PT23029-MPG	1	1.455	0.660	0.060	0.002	PT23103-MPG	1	1.050	0.476	0.053	0.001	PT23182	1	1.800	0.816	0.110	0.003
PT23030-MPG	1	2.910	1.320	0.146	0.004	PT23104-MPG	1	15.350	6.963	0.951	0.027	PT23183	1	1.000	0.454	0.099	0.003
PT23031-MPG	1	0.250	0.113	0.014	**	PT23105-MPG	1	0.400	0.181	0.017	**	PT23184	1	1.200	0.544	0.099	0.003
PT23032-MPG	1	0.309	0.140	0.010	**	PT23106-MPG	1	3.900	1.769	0.198	0.006	PT23185	1	2.350	1.066	0.214	0.006
PT23033-MPG	1	4.250	1.928	0.232	0.007	PT23107-MPG	1	0.400	0.181	0.017	**	PT23186	1	2.500	1.134	0.247	0.007
PT23034-MPG	1	1.750	0.794	0.081	0.002	PT23108-MPG	1	0.750	0.340	0.029	0.001	PT23187	1	1.950	0.885	0.156	0.004
PT23035-MPG	1	0.850	0.386	0.053	0.001	PT23109-MPG	1	0.750	0.340	0.037	0.001	PT23188	1	2.200	0.998	0.201	0.006
PT23036-MPG	1	0.350	0.159	0.014	**	PT23110-MPG	1	1.150	0.522	0.044	0.001	PT23189	1	0.794	0.360	0.072	0.002
PT23037-MPG	1	0.353	0.160	0.010	**	PT23111-MPG	1	1.700	0.771	0.072	0.002	PT23190	1	0.850	0.386	0.025	0.001
PT23038-MPG	1	0.550	0.249	0.021	0.001	PT23112-MPG	1	1.700	0.771	0.072	0.002	PT23193-MPG	1	0.350	0.159	0.013	**
PT23039-MPG	1	0.550	0.249	0.022	0.001	PT23113-MPG	1	2.650	1.202	0.164	0.005	PT23195-MPG	1	0.550	0.249	0.032	0.001
PT23040-MPG	1	1.300	0.590	0.058	0.002	PT23114-MPG	1	2.600	1.179	0.189	0.005	PT23196-MPG	1	0.800	0.363	0.043	0.001
PT23041-MPG	1	1.650	0.748	0.115	0.003	PT23115-MPG	1	0.600	0.272	0.043	0.001	PT23197-MPG	1	1.150	0.522	0.056	0.002
PT23042-MPG	1	1.400	0.635	0.104	0.003	PT23116-MPG	1	6.350	2.880	0.413	0.012	PT23198-MPG	1	0.700	0.318	0.053	0.001
PT23043-MPG	1	0.750	0.340	0.021	0.001	PT23117-MPG	1	0.850	0.386	0.053	0.001	PT23200-MPG	1	0.950	0.431	0.050	0.001
PT23044-MPG	1	1.300	0.590	0.096	0.003	PT23118-MPG	1	1.700	0.771	0.072	0.002	PT23201-MPG	1	1.050	0.476	0.057	0.002
PT23045-MPG	1	1.700	0.771	0.078	0.002	PT23119-MPG	1	3.350	1.520	0.206	0.006	PT23202-MPG	1	0.350	0.159	0.024	0.001
PT23046-MPG	1	1.650	0.748	0.070	0.002	PT23120-MPG	1	4.750	2.155	0.310	0.009	PT23203-MPG	1	0.700	0.318	0.029	0.001
PT23047-MPG	1	0.600	0.272	0.034	0.001	PT23122	12	0.846	0.384	0.101	0.003	PT23204-MPG	1	1.300	0.590	0.058	0.002
PT23048-MPG	1	2.900	1.315	0.243	0.007	PT23123	12	0.650	0.295	0.069	0.002	PT23205-MPG	1	0.450	0.204	0.016	**
PT23049-MPG	1	2.800	1.270	0.105	0.003	PT23124	12	1.310	0.594	0.109	0.003	PT23206-MPG	1	0.794	0.360	0.022	0.001
PT23050-MPG	1	2.450	1.111	0.103	0.003	PT23125-MPG	12	3.270	1.483	0.100	0.003	PT23207-MPG	1	0.850	0.386	0.024	0.001
PT23051-MPG	1	15.100	6.849	1.423	0.040	PT23126-MPG	12	0.775	0.352	0.031	0.001	PT23208-MPG	1	0.350	0.159	0.017	**
PT23052-MPG	1	4.300	1.950	0.151	0.004	PT23127-MPG	12	0.816	0.370	0.040	0.001	PT23209-MPG	1	1.800	0.816	0.110	0.003
PT23053-MPG	1	3.950	1.792	0.111	0.003	PT23128-MPG	12	0.617	0.280	0.030	0.001	PT23211-MPG	1	4.200	1.905	0.279	0.008
PT23054-MPG	1	2.350	1.066	0.105	0.003	PT23129-MPG	12	1.150	0.522	0.062	0.002	PT23212-MPG	1	0.950	0.431	0.032	0.001
PT23055-MPG	1	0.300	0.136	0.014	**	PT23131-MPG	1	3.071	1.393	0.083	0.002	PT23213-MPG	1	1.750	0.794	0.113	0.003
PT23056-MPG	1	2.750	1.247	0.072	0.002	PT23132-MPG	12	0.875	0.397	0.032	0.001	PT23214-MPG	1	2.050	0.930	0.157	0.004
PT23057-MPG	1	2.300	1.043	0.119	0.003	PT23133-MPG	1	6.250	2.835	0.496	0.014	PT23215-MPG	1	1.700	0.771	0.131	0.004
PT23058-MPG	1	0.300	0.136	0.017	**	PT23135-MPG	1	1.800	0.816	0.074	0.002	PT23216-MPG	1	1.750	0.794	0.082	0.002
PT23059-MPG	1	1.000	0.454	0.053	0.001	PT23136	12	0.700	0.318	0.070	0.002	PT23217-MPG	1	0.500	0.227	0.055	0.002
PT23060-MPG	1	1.146	0.520	0.049	0.001	PT23137	6	2.630	1.193	0.275	0.008	PT23218-MPG	1	0.650	0.295	0.017	**
PT23061-MPG	1	1.750	0.794	0.086	0.002	PT23138	1	1.100	0.499	0.097	0.003	PT23219-MPG	1	0.900	0.408	0.029	0.001
PT23062-MPG	1	8.800	3.9														

BALDWIN WEIGHTS AND VOLUMES

BALDWIN NUMBER	CASE QTY.	WEIGHT (ea.) lbs.	kg.	Volume (ea.) ft ³	m ³	BALDWIN NUMBER	CASE QTY.	WEIGHT (ea.) lbs.	kg.	Volume (ea.) ft ³	m ³	BALDWIN NUMBER	CASE QTY.	WEIGHT (ea.) lbs.	kg.	Volume (ea.) ft ³	m ³
PT23228-MPG	1	2.800	1.270	0.153	0.004	PT23314	1	0.450	0.204	0.030	0.001	PT23387-MPG	1	0.400	0.181	0.017	0.001
PT23229-MPG	1	2.700	1.225	0.247	0.007	PT23315	1	3.360	1.524	0.243	0.007	PT23388-MPG	1	0.700	0.318	0.040	0.001
PT23230-MPG	1	1.750	0.794	0.085	0.002	PT23316	1	1.450	0.658	0.074	0.002	PT23389-MPG	1	1.300	0.590	0.031	0.001
PT23231-MPG	1	2.800	1.270	0.139	0.004	PT23317	1	1.800	0.816	0.091	0.003	PT23390-MPG	1	2.700	1.225	0.243	0.007
PT23232-MPG	1	3.150	1.429	0.276	0.008	PT23318	1	2.400	1.089	0.330	0.009	PT23391-MPG	1	1.000	0.454	0.056	0.002
PT23233-MPG	1	0.550	0.249	0.034	0.001	PT23319	1	0.200	0.091	0.017	0.001	PT23392-MPG	1	3.400	1.542	0.283	0.008
PT23234-MPG	1	4.050	1.837	0.380	0.011	PT23320	1	0.350	0.159	0.023	0.001	PT23393-MPG	1	2.200	0.998	0.140	0.004
PT23235-MPG	1	1.500	0.680	0.279	0.008	PT23321	1	0.550	0.249	0.043	0.001	PT23394-MPG	1	3.300	1.497	0.292	0.008
PT23236-MPG	1	1.500	0.680	0.283	0.008	PT23322	1	0.550	0.249	0.016	0.001	PT23395-MPG	1	1.450	0.658	0.055	0.002
PT23237-MPG	1	2.700	1.225	0.166	0.005	PT23323	1	1.550	0.703	0.159	0.004	PT23396-MPG	1	2.750	1.247	0.056	0.002
PT23238-MPG	1	2.150	0.975	0.143	0.004	PT23324	1	2.200	0.998	0.282	0.008	PT23397-MPG	1	2.750	1.247	0.055	0.002
PT23239-MPG	1	7.550	3.425	0.519	0.015	PT23325	1	3.150	1.429	0.084	0.002	PT23398-MPG	1	2.750	1.247	0.060	0.002
PT23240-MPG	1	1.300	0.590	0.030	0.001	PT23326	1	0.900	0.408	0.042	0.001	PT23399-MPG	1	1.450	0.658	0.240	0.008
PT23241-MPG	1	2.800	1.270	0.137	0.004	PT23327	1	0.950	0.431	0.055	0.002	PT23400-MPG	1	0.900	0.408	0.016	0.001
PT23242-MPG	1	2.650	1.202	0.175	0.005	PT23328	1	0.850	0.386	0.057	0.002	PT23401-MPG	1	2.800	1.270	0.143	0.004
PT23243-MPG	1	2.450	1.111	0.110	0.003	PT23329	1	0.550	0.249	0.029	0.001	PT23402-MPG	1	3.400	1.542	0.165	0.005
PT23244-MPG	1	2.850	1.293	0.137	0.004	PT23330	1	1.150	0.522	0.100	0.003	PT23403-MPG	1	4.250	1.928	0.212	0.006
PT23245-MPG	1	4.850	2.200	0.312	0.009	PT23331	1	3.250	1.474	0.251	0.007	PT23404-MPG	1	4.250	1.928	0.210	0.006
PT23246-MPG	1	1.450	0.658	0.057	0.002	PT23332	1	0.700	0.318	0.033	0.001	PT23405-MPG	1	4.300	1.950	0.212	0.006
PT23247-MPG	1	2.500	1.134	0.137	0.004	PT23333	1	0.485	0.220	0.022	0.001	PT23406-MPG	1	1.100	0.499	0.204	0.006
PT23248-MPG	1	16.250	7.371	1.039	0.029	PT23334	1	0.800	0.363	0.059	0.002	PT23407-MPG	1	0.500	0.227	0.055	0.002
PT23249-MPG	1	7.600	3.447	0.517	0.015	PT23335	1	2.650	1.202	0.284	0.008	PT23408-MPG	1	1.950	0.885	0.029	0.001
PT23250-MPG	1	3.900	1.769	0.280	0.008	PT23336	1	1.100	0.499	0.075	0.002	PT23409-MPG	1	3.850	1.746	0.299	0.008
PT23251-MPG	1	4.000	1.814	0.253	0.007	PT23337	1	0.400	0.181	0.024	0.001	PT23410-MPG	1	1.150	0.522	0.058	0.002
PT23252-MPG	1	4.050	1.837	0.271	0.008	PT23338-MPG	1	0.400	0.181	0.016	0.001	PT23411-MPG	1	5.550	2.517	1.026	0.029
PT23253-MPG	1	8.850	4.014	0.522	0.015	PT23339-MPG	1	3.300	1.497	0.070	0.002	PT23412-MPG	1	1.950	0.885	0.091	0.003
PT23254-MPG	1	4.300	1.950	0.104	0.003	PT23340-MPG	1	2.800	1.270	0.114	0.003	PT23413-MPG	1	8.900	4.037	0.266	0.008
PT23255-MPG	1	15.800	7.167	1.026	0.029	PT23341-MPG	1	4.000	1.814	0.104	0.003	PT23414-MPG	1	1.400	0.635	0.059	0.002
PT23256-MPG	1	15.750	7.144	1.919	0.054	PT23342-MPG	1	2.250	1.021	0.123	0.003	PT23415-MPG	1	2.700	1.225	0.174	0.005
PT23257-MPG	1	2.200	0.998	0.115	0.003	PT23343-MPG	1	18.700	8.482	1.972	0.056	PT23416-MPG	1	2.200	0.998	0.141	0.004
PT23258-MPG	1	0.600	0.272	0.017	0.001	PT23344-MPG	1	1.350	0.612	0.085	0.002	PT23417-MPG	1	0.900	0.408	0.170	0.005
PT23259-MPG	1	3.900	1.769	0.190	0.005	PT23345-MPG	1	2.050	0.930	0.165	0.005	PT23418-MPG	1	0.900	0.408	0.016	0.001
PT23260-MPG	1	0.250	0.113	0.017	0.001	PT23346-MPG	1	1.150	0.522	0.058	0.002	PT23419-MPG	1	1.300	0.590	0.058	0.002
PT23261-MPG	1	1.450	0.658	0.072	0.002	PT23347-MPG	1	1.100	0.454	0.052	0.001	PT23420-MPG	1	5.350	2.427	0.268	0.008
PT23262-MPG	1	2.700	1.225	0.160	0.005	PT23348-MPG	1	2.650	1.202	0.140	0.004	PT23421-MPG	1	8.000	3.629	0.376	0.011
PT23263-MPG	1	0.900	0.408	0.017	0.001	PT23349-MPG	1	5.400	2.449	0.396	0.011	PT23422-MPG	1	8.800	3.992	0.266	0.008
PT23264-MPG	1	2.350	1.066	0.136	0.004	PT23350-MPG	1	0.705	0.320	0.027	0.001	PT23423-MPG	1	4.600	2.087	0.161	0.005
PT23265-MPG	1	2.050	0.930	0.099	0.003	PT23351-MPG	1	1.150	0.522	0.059	0.002	PT23424-MPG	1	4.750	2.155	1.026	0.029
PT23266-MPG	1	0.750	0.340	0.025	0.001	PT23352-MPG	1	0.309	0.140	0.010	0.001	PT23425-MPG	1	4.700	2.132	1.003	0.028
PT23267-MPG	1	1.050	0.476	0.053	0.001	PT23353-MPG	1	2.400	1.089	0.098	0.003	PT23426-MPG	1	5.650	2.563	0.996	0.028
PT23269-MPG	1	0.850	0.386	0.030	0.001	PT23354-MPG	1	2.400	1.089	0.104	0.003	PT23427-MPG	1	2.150	0.975	0.449	0.013
PT23270-MPG	1	0.300	0.136	0.016	0.001	PT23355-MPG	1	7.450	3.379	0.511	0.014	PT23428-MPG	1	4.900	2.223	0.996	0.028
PT23271-MPG	1	2.700	1.225	0.170	0.005	PT23356-MPG	1	2.954	1.340	0.088	0.002	PT23429-MPG	1	3.750	1.701	0.101	0.003
PT23272-MPG	1	2.050	0.930	0.101	0.003	PT23357-MPG	1	0.850	0.386	0.024	0.001	PT23430-MPG	1	1.700	0.771	0.040	0.001
PT23273-MPG	1	2.650	1.202	0.135	0.004	PT23358-MPG	1	0.550	0.249	0.022	0.001	PT23431-MPG	1	5.750	2.608	1.041	0.029
PT23274-MPG	1	2.650	1.202	0.073	0.002	PT23359-MPG	1	2.400	1.089	0.116	0.003	PT23432-MPG	1	1.800	0.816	0.061	0.002
PT23275-MPG	1	3.100	1.406	0.070	0.002	PT23360-MPG	1	8.550	3.878	0.538	0.015	PT23433-MPG	1	1.950	0.885	0.090	0.003
PT23276-MPG	1	4.250	1.928	0.136	0.004	PT23361-MPG	1	1.150	0.522	0.042	0.001	PT23434-MPG	1	7.750	3.515	0.395	0.011
PT23277-MPG	1	2.850	1.293	0.143	0.004	PT23362-MPG	1	4.800	2.177	0.233	0.007	PT23435-MPG	1	4.400	1.996	0.267	0.008
PT23278-MPG	1	1.950	0.885	0.104	0.003	PT23363-MPG	1	1.650	0.748	0.074	0.002	PT23436-MPG	1	2.050	0.930	0.041	0.001
PT23279-MPG	1	2.650	1.202	0.170	0.005	PT23364-MPG	1	3.950	1.792	0.200	0.006	PT23437-MPG	1	1.250	0.567	0.031	0.001
PT23280-MPG	1	0.450	0.204	0.017	0.001	PT23365-MPG	1	1.700	0.771	0.040	0.001	PT23438-MPG	1	2.200	0.998	0.101	0.003
PT23281-MPG	1	1.450	0.658	0.072	0.002	PT23366-MPG	1	2.400	1.089	0.111	0.003	PT23439-MPG	1	5.800	2.631	1.040	0.029
PT23282-MPG	1	6.200	2.812	0.403	0.011	PT23367-MPG	1	0.300	0.136	0.016	0.001	PT23440-MPG	1	2.550	1.157	0.141	0.004
PT23283-MPG	1	1.900	0.862	0.094	0.003	PT23368-MPG	1	2.950	1.338	0.140	0.004	PT23441-MPG	1	0.750	0.340	0.104	0.003
PT23284-MPG	1	0.850	0.386	0.053	0.001	PT23369-MPG	1	0.750	0.340	0.020	0.001	PT23442-MPG	1	0.750	0.340	0.025	0.001
PT23285-MPG	1	0.450	0.204	0.032	0.001	PT23370-MPG	1	1.650	0.748	0.074	0.002	PT23443-MPG	1	0.750	0.340	0.031	0.001
PT23286-MPG	1	0.450	0.204	0.017	0.001	PT23371-MPG	1	0.600	0.272	0.022	0.001	PT23444-MPG	1	0.800	0.363	0.054	0.002
PT23287-MPG	1	1.950	0.885	0.101	0.003	PT23372-MPG	1	2.650	1.202	0.072	0.002	PT23445-MPG	1	1.700	0.771	0.079	0.002
PT23289-MPG	1	1.300	0.590	0.058	0.002	PT23373-MPG	1	0.700	0.318	0.030	0.001	PT23446-MPG	1	3.300	1.497	0.287	0.008
PT23290-MPG	1	0.400	0.181	0.016	0.001	PT23374-MPG	1	0.485	0.220	0.010	0.001	PT23447-MPG	1	0.350	0.159	0.017	0.001
PT23291-MPG	1	2.850	1.293	0.137	0.004	PT23375-MPG	1	0.600	0.272	0.022	0.001	PT23448-MPG	1	0.550	0.249	0.030	0.001
PT23292-MPG	1	0.450	0.204	0.024	0.001	PT23376-MPG	1	1.300	0.590	0.024	0.001	PT23449-MPG	1	6.050	2.744	0.390	0.011
PT23294-MPG	1	0.300	0.136	0.017	0.001	PT23377-MPG	1	0.200	0.091	0.016	0.001	PT23450-MPG	1	5.650	2.563	0.280	0.008
PT23295-MPG	1	1.550	0.703	0.055	0.002	PT23378-MPG	1	0.700	0.318	0.030	0.001	PT23451	1	4.700	2.132	0.519	0.015
PT23296-MPG	1	1.200	0.544	0.057	0.002	PT23379-MPG	1	0.353	0.160	0.010	0.001	PT23452	1	5.300	2.404	0.402	0.011
PT23297	1	1.350															

BALDWIN WEIGHTS AND VOLUMES

BALDWIN NUMBER	CASE QTY.	WEIGHT (ea.) lbs.	WEIGHT (ea.) kgs.	Volume (ea.) ft ³	Volume (ea.) m ³	BALDWIN NUMBER	CASE QTY.	WEIGHT (ea.) lbs.	WEIGHT (ea.) kgs.	Volume (ea.) ft ³	Volume (ea.) m ³	BALDWIN NUMBER	CASE QTY.	WEIGHT (ea.) lbs.	WEIGHT (ea.) kgs.	Volume (ea.) ft ³	Volume (ea.) m ³
PT23461	1	1.900	0.862	0.160	0.005	BT23537	1	2.750	1.247	0.113	0.003	PA30032	1	2.400	1.089	0.282	0.008
PT23462	1	1.400	0.635	0.136	0.004	BT23539	1	3.250	1.474	0.184	0.005	PA30033	1	0.500	0.227	0.084	0.002
PT23463	1	0.200	0.091	0.016	0.001	BT23540	1	2.700	1.225	0.117	0.003	PA30034	12	0.475	0.215	0.040	0.001
PT23464	1	0.650	0.295	0.041	0.001	BT23542-MPG	1	4.800	2.177	0.226	0.006	PA30035	12	0.370	0.168	0.043	0.001
PT23465	1	0.700	0.318	0.051	0.001	BT23543-MPG	6	5.475	2.483	0.161	0.005	PA30036	1	0.800	0.363	0.127	0.004
PT23467	1	4.150	1.882	0.378	0.011	PT23544-MPG	12	0.929	0.421	0.126	0.004	PA30037	1	11.700	5.307	1.378	0.039
PT23468	1	1.450	0.658	0.089	0.003	PT23556-MPG	1	1.050	0.476	0.100	0.003	PA30038	1	10.500	4.763	1.515	0.043
PT23469	1	2.100	0.953	0.201	0.006	PT23560	6	4.650	2.109	0.065	0.002	PA30039	1	21.750	9.866	3.666	0.104
PT23470	1	0.450	0.204	0.032	0.001	PT23565-MPG	1	2.350	1.066	0.238	0.007	PA30040	1	12.600	5.715	1.659	0.047
PT23471	1	2.400	1.089	0.201	0.006	PT23566-MPG	1	2.950	1.338	0.286	0.008	PA30041	1	17.150	7.779	2.923	0.083
PT23472	1	1.050	0.476	0.082	0.002	PT23567-MPG	1	0.400	0.181	0.040	0.001	PA30042	1	3.350	1.520	0.533	0.015
PT23473	1	1.400	0.635	0.165	0.005	PT23568-MPG	1	0.650	0.295	0.021	0.001	PA30043	1	19.100	8.664	2.824	0.080
PT23474	1	0.650	0.295	0.034	0.001	PT23569-MPG	1	1.000	0.454	0.065	0.002	PA30044	6	0.233	0.106	0.064	0.002
PT23475	1	1.450	0.658	0.095	0.003	PT23570-MPG	1	0.550	0.249	0.023	0.001	PA30045	1	0.900	0.408	0.197	0.006
PT23476	1	1.000	0.454	0.053	0.001	PT23571-MPG	1	0.200	0.091	0.013	0.001	PA30048	1	4.200	1.905	0.380	0.011
PT23477	1	1.700	0.771	0.115	0.003	PT23572-MPG	1	0.550	0.249	0.030	0.001	PA30049	1	6.100	2.767	0.376	0.011
PT23478	1	0.450	0.204	0.025	0.001	PT23573-MPG	1	0.300	0.136	0.016	0.001	PA30050	6	0.408	0.185	0.066	0.002
PT23479	1	1.700	0.771	0.141	0.004	PT23574-MPG	1	0.200	0.091	0.024	0.001	PA30051	6	0.283	0.128	0.046	0.001
PT23480	1	1.450	0.658	0.089	0.003	PT23575-MPG	1	0.450	0.204	0.016	0.001	PA30052	6	0.516	0.234	0.085	0.002
PT23481	1	1.250	0.567	0.083	0.002	PT23576-MPG	1	0.700	0.318	0.030	0.001	PA30053	6	0.183	0.083	0.022	0.001
PT23482	1	1.190	0.540	0.072	0.002	PT23577-MPG	1	1.650	0.748	0.243	0.007	PA30054	6	0.375	0.170	0.064	0.002
PT23483-MPG	1	8.250	3.742	0.937	0.027	PT23578-MPG	1	1.300	0.590	0.059	0.002	PA30055	6	0.275	0.125	0.046	0.001
PT23484-MPG	1	2.000	0.907	0.030	0.001	PT23579-MPG	1	2.450	1.111	0.196	0.006	PA30056	6	0.291	0.132	0.044	0.001
PT23485-MPG	1	8.000	3.629	0.519	0.015	PT23580-MPG	1	1.600	0.726	0.069	0.002	RS30057	1	8.000	3.629	1.897	0.054
PT23486-MPG	1	14.100	6.396	1.147	0.032	PT23581-MPG	1	5.000	2.268	0.331	0.009	RS30058	1	2.750	1.247	0.690	0.020
PT23487-MPG	1	3.450	1.565	0.282	0.008	PT23582-MPG	1	2.700	1.225	0.194	0.005	RS30059-FN	1	4.250	1.928	0.987	0.028
PT23488-MPG	1	2.200	0.998	0.160	0.005	PT23583-MPG	1	2.450	1.111	0.244	0.007	RS30060-FN	1	2.150	0.975	0.462	0.013
PT23489-MPG	1	0.700	0.318	0.030	0.001	PT23585	1	2.500	1.134	0.137	0.004	RS30061	1	0.650	0.295	0.220	0.006
PT23490-MPG	1	1.150	0.522	0.057	0.002	PT23586	1	0.800	0.363	0.082	0.002	RS30062	1	5.550	2.517	1.283	0.036
PT23491-MPG	1	0.500	0.227	0.030	0.001	PT23587	1	1.350	0.612	0.121	0.003	PA30063	1	0.850	0.386	0.133	0.004
PT23492-MPG	1	0.200	0.091	0.017	0.001	PT23588	1	2.650	1.202	0.333	0.009	PA30064	1	2.200	0.998	0.372	0.011
PT23493-MPG	1	1.850	0.839	0.083	0.002	PT23589	1	5.950	2.699	0.516	0.015	RS30065	1	11.650	5.284	2.340	0.066
PT23494-MPG	1	0.300	0.136	0.014	0.001	PT23590	1	3.200	1.452	0.086	0.002	RS30065 KIT	1	15.400	6.985	4.117	0.117
PT23495-MPG	1	0.450	0.204	0.031	0.001	PT23591-MPG	1	5.450	2.472	0.417	0.012	PA30066	1	13.150	5.965	2.260	0.064
PT23496-MPG	1	2.850	1.293	0.243	0.007	PT23592	6	1.667	0.756	0.148	0.004	PA30067	1	4.600	2.087	0.604	0.017
PT23497-MPG	1	6.850	3.107	0.408	0.012	PT23595-MPG	1	3.350	1.520	0.265	0.007	PA30068	1	1.350	0.612	0.122	0.003
PT23498-MPG	1	0.750	0.340	0.025	0.001	PT23600	1	4.700	2.132	0.477	0.013	PA30069	1	4.300	1.950	1.529	0.043
PT23499-MPG	1	1.250	0.567	0.039	0.001	BT23603-MPG	6	2.542	1.153	0.094	0.003	PA30070	1	3.950	1.792	0.561	0.016
PT23500-MPG	1	0.450	0.204	0.023	0.001	BT23607-MPG	6	2.100	0.953	0.102	0.003	CA30071	1	3.450	1.565	0.784	0.022
PT23501-MPG	1	0.600	0.272	0.042	0.001	BT23609-MPG	1	4.800	2.177	0.226	0.006	PA30072	6	1.150	0.522	0.158	0.004
PT23502-MPG	1	2.600	1.179	0.197	0.006	BT23611	12	1.563	0.709	0.051	0.001	PA30073	1	15.100	6.849	1.981	0.056
PT23503-MPG	1	0.650	0.295	0.037	0.001	PT23616-MPG	1	3.400	1.542	0.228	0.006	PA30074	1	16.150	7.326	1.941	0.055
PT23504-MPG	1	1.450	0.658	0.081	0.002	PA30000	1	0.350	0.159	0.089	0.003	PA30075	1	2.350	1.066	0.410	0.012
PT23505-MPG	1	4.600	2.087	0.378	0.011	PA30001	1	0.200	0.091	0.076	0.002	PA30076	1	2.950	1.338	0.896	0.025
PT23506-MPG	1	2.900	1.315	0.141	0.004	PA30002	1	2.100	0.953	0.280	0.008	RS30077	1	1.200	0.544	0.197	0.006
PT23507-MPG	1	2.200	0.998	0.105	0.003	PA30003	1	2.800	1.270	0.581	0.016	RS30078	1	0.450	0.204	0.106	0.003
PT23508-MPG	1	8.150	3.697	0.527	0.015	PA30004	1	2.400	1.089	0.306	0.009	CA30079	1	3.350	1.520	0.581	0.016
PT23509-MPG	1	1.450	0.658	0.060	0.002	PA30005	1	1.400	0.635	0.189	0.005	PA30080	6	0.716	0.325	0.045	0.001
PT23510-MPG	1	0.200	0.091	0.017	0.001	PA30006	1	0.550	0.249	0.178	0.005	PA30081	1	0.450	0.204	0.082	0.002
PT23511-MPG	1	3.850	1.746	0.245	0.007	PA30007	6	1.041	0.472	0.214	0.006	PA30086	6	0.591	0.268	0.112	0.003
PT23512-MPG	1	0.500	0.227	0.033	0.001	RS30008	1	14.050	6.373	3.351	0.095	RS30087	1	14.600	6.623	3.431	0.097
PT23513-MPG	1	0.485	0.220	0.028	0.001	RS30009	1	3.600	1.633	1.078	0.031	RS30088	1	4.950	2.245	1.339	0.038
PT23514-MPG	1	1.650	0.748	0.113	0.003	PA30010	1	9.000	4.082	1.898	0.054	RS30090-FN	1	6.000	2.722	1.650	0.047
PT23515-MPG	1	4.200	1.905	0.287	0.008	PA30011	6	0.808	0.367	0.125	0.004	RS30091	1	6.750	3.062	1.630	0.046
PT23516-MPG	1	0.750	0.340	0.053	0.001	PA30012	6	0.666	0.302	0.076	0.002	RS30092	1	1.950	0.885	0.481	0.014
PT23517-MPG	1	5.300	2.404	0.382	0.011	PA30013	1	1.900	0.862	0.408	0.012	PA30093	6	0.425	0.193	0.098	0.003
PT23518-MPG	1	1.250	0.567	0.115	0.003	PA30014	12	0.445	0.202	0.086	0.002	PA30094	1	0.300	0.136	0.147	0.004
PT23519-MPG	1	4.250	1.928	0.282	0.008	PA30015	1	0.450	0.204	0.118	0.003	PA30095	1	2.650	1.202	0.464	0.013
PT23520-MPG	1	6.400	2.903	0.380	0.011	PA30016	12	0.529	0.240	0.062	0.002	PA30096	1	0.350	0.159	0.097	0.003
PT23521-MPG	1	1.300	0.590	0.245	0.007	PA30017	12	0.508	0.230	0.082	0.002	PA30098	1	0.900	0.408	0.114	0.003
PT23522-MPG	1	2.350	1.066	0.170	0.005	PA30018	12	0.562	0.255	0.065	0.002	RS30099	1	1.300	0.590	0.144	0.004
PT23523-MPG	1	1.900	0.862	0.135	0.004	PA30019	12	0.475	0.215	0.058	0.002	PA30100	1	0.150	0.068	0.024	0.001
PT23524-MPG	1	0.550	0.249	0.022	0.001	PA30020	1	0.400	0.181	0.084	0.002	PA30101	1	0.350	0.159	0.067	0.002
BT23525-MPG	12	1.429	0.648	0.063	0.002	PA30021	1	0.850	0.386	0.081	0.002	CA30102	1	8.150	3.697	1.002	0.028
PT23528-MPG	1	0.350	0.159	0.014	0.001	PA30022	12	0.500	0.227	0.066	0.002	CA30103	1	9.250	4.196	1.617	0.046
PT23526	1	2.150	0.975	0.106	0.003	PA30023	1	3.050	1.383	0.587	0.017	CA30104	1	9.750	4.423	1.765	0.050
PT23527	12	0.350	0.159	0.030	0.001	PA30024	12	0.554	0.251	0.056	0.002	CA30105	1	7.550	3.425	1.371	

BALDWIN WEIGHTS AND VOLUMES

BALDWIN NUMBER	CASE QTY.	WEIGHT (ea.) lbs.	WEIGHT (ea.) kgs.	Volume (ea.) ft ³	Volume (ea.) m ³	BALDWIN NUMBER	CASE QTY.	WEIGHT (ea.) lbs.	WEIGHT (ea.) kgs.	Volume (ea.) ft ³	Volume (ea.) m ³	BALDWIN NUMBER	CASE QTY.	WEIGHT (ea.) lbs.	WEIGHT (ea.) kgs.	Volume (ea.) ft ³	Volume (ea.) m ³
PA30114	1	0.450	0.204	0.177	0.005	RS30192	1	6.250	2.835	1.328	0.038	P40052	12	0.258	0.117	0.034	0.001
PA30115	6	0.383	0.174	0.063	0.002	PA30204	12	0.783	0.355	0.066	0.002	B40053	6	3.067	1.391	0.152	0.004
RS30116	1	9.950	4.513	2.143	0.061	PA30206	1	2.550	1.157	0.416	0.012	B40054	12	1.804	0.818	0.074	0.002
PA30117	1	0.150	0.068	0.064	0.002	PA30207	1	2.550	1.157	0.387	0.011	B40056	12	1.342	0.609	0.050	0.001
PA30118	1	1.800	0.816	0.361	0.010	PA30208	1	0.500	0.227	0.178	0.005	P40058	12	0.150	0.068	0.017	**
PA30119	6	0.550	0.249	0.077	0.002	RS30209	1	1.000	0.454	0.159	0.004	P40061	12	0.204	0.093	0.036	0.001
RS30120	1	1.200	0.544	0.302	0.009	PA30211	1	1.600	0.726	0.334	0.009	P40062	1	1.200	0.544	0.217	0.006
RS30121	1	5.100	2.313	1.170	0.033	RS30216	1	8.050	3.651	1.966	0.056	BF45000	12	0.129	0.059	0.020	0.001
PA30122	1	0.750	0.340	0.178	0.005	RS30217	1	2.000	0.907	0.489	0.014	BF46000	12	0.962	0.436	0.063	0.002
PA30123	1	1.000	0.454	0.186	0.005	RS30223	1	7.050	3.198	1.332	0.038	BF46001	12	0.900	0.408	0.064	0.002
PA30124	1	0.850	0.386	0.172	0.005	RS30224	1	2.250	1.021	0.555	0.016	BF46002	6	3.883	1.761	0.149	0.004
PA30125	1	5.600	2.540	1.287	0.036	RS30225	1	6.250	2.835	1.402	0.040	PF46003	12	0.792	0.359	0.108	0.003
PA30126	6	1.117	0.507	0.194	0.005	RS30226	1	2.050	0.930	0.513	0.015	PF46004	12	0.750	0.340	0.105	0.003
PA30127	1	0.600	0.272	0.090	0.003	PA30228	1	0.250	0.113	0.070	0.002	BF46005	12	0.413	0.187	0.030	0.001
RS30128	1	11.550	5.239	2.567	0.073	PA30229	1	0.150	0.068	0.029	0.001	BF46006	12	0.658	0.298	0.034	0.001
RS30129	1	4.050	1.837	1.400	0.030	RS30232	1	9.150	4.150	1.924	0.054	BF46007	12	0.100	0.045	0.019	0.001
RS30130	1	6.300	2.858	1.511	0.043	PA30233-FN	1	4.950	2.245	0.930	0.026	BF46008	12	0.170	0.077	0.011	**
CA30131	1	8.250	3.742	1.195	0.034	RS30234	1	0.450	0.204	0.138	0.004	PF46009	12	0.200	0.091	0.019	0.001
CA30132	1	8.650	3.924	1.400	0.040	PA30235	1	10.550	4.785	1.815	0.051	PF46010 KIT	1	2.500	1.157	0.474	0.013
RS30133	1	9.150	4.150	2.048	0.058	RS30236	1	5.400	2.449	0.967	0.027	BF46012	12	1.212	0.550	0.066	0.002
RS30134	1	2.950	1.338	0.805	0.023	RS30237	1	3.100	1.406	0.881	0.025	BF46013	12	1.290	0.585	0.061	0.002
RS30135	1	8.850	4.014	2.090	0.059	RS30242	1	0.500	0.227	0.129	0.004	BF46014	12	1.180	0.535	0.065	0.002
RS30136	1	2.550	1.157	0.676	0.019	PA30243	1	5.250	2.381	0.891	0.025	BF46015	12	2.350	1.066	0.144	0.004
PA30137	1	0.450	0.204	0.098	0.003	PA30244	1	1.700	0.771	0.217	0.006	BF46016-O	12	1.862	0.845	0.107	0.003
PA30138	12	0.637	0.289	0.312	0.009	PA30251	1	0.441	0.200	0.091	0.003	BF46017-O	12	0.658	0.298	0.052	0.001
PA30139	12	0.700	0.318	0.353	0.010	PA30252	6	0.675	0.306	0.079	0.002	BF46018-O	6	1.842	0.836	0.124	0.004
PA30140	6	0.475	0.215	0.103	0.003	PA31000	1	9.850	4.468	1.213	0.034	BF46019-O	12	1.033	0.469	0.051	0.001
PA30141	6	0.641	0.291	0.141	0.004	PA31001	1	1.400	0.635	0.145	0.004	BF46020-O	12	1.041	0.472	0.051	0.001
RS30142	1	8.300	3.765	1.677	0.047	PA31002	1	6.600	2.994	0.873	0.025	BF46021-O	12	1.112	0.504	0.051	0.001
RS30142 KIT	1	10.900	4.944	3.146	0.089	PA31003	1	1.250	0.567	0.076	0.002	BF46022-O	12	1.116	0.506	0.051	0.001
RS30143	1	9.900	4.491	2.012	0.057	PA31004	1	5.200	2.359	0.474	0.013	BF46023-O	12	1.045	0.474	0.052	0.001
RS30143 KIT	1	12.750	5.783	4.084	0.116	PA31005	1	0.850	0.386	0.056	0.002	BF46024-O	12	1.050	0.476	0.052	0.001
PA30144	6	0.441	0.200	0.095	0.003	PA31006	1	7.000	3.175	0.647	0.018	BF46025-O	12	1.300	0.590	0.065	0.002
PA30145	1	10.800	4.899	2.457	0.070	PA31007	1	9.000	4.008	0.058	0.002	BF46026-O	12	1.175	0.533	0.063	0.002
PA30146	1	4.000	1.814	0.847	0.024	PA31010	1	2.800	1.270	0.296	0.008	BF46027-O	12	1.362	0.618	0.150	0.004
RS30147	1	1.050	0.476	0.175	0.005	PA31011	1	0.900	0.408	0.061	0.002	BF46028-O	12	1.141	0.518	0.081	0.002
PA30148	1	0.150	0.068	0.030	0.001	PA31012	1	5.300	2.404	0.672	0.019	BF46029-O	12	1.079	0.489	0.050	0.001
PA30149	6	1.625	0.737	0.392	0.011	PA32001	1	4.950	2.245	0.654	0.019	BF46030-O	12	1.237	0.561	0.065	0.002
PA30150	1	0.300	0.136	0.065	0.002	PA32004	1	0.400	0.181	0.029	0.001	BF46031	12	1.508	0.684	0.091	0.003
PA30151	6	0.675	0.306	0.104	0.003	B40000	12	0.500	0.227	0.027	0.001	BF46032	12	2.116	0.960	0.087	0.002
PA30152	6	0.300	0.136	0.053	0.001	P40001	12	0.229	0.104	0.037	0.001	PF46033	12	0.570	0.259	0.064	0.002
PA30153	12	0.329	0.149	0.038	0.001	P40002	12	0.100	0.045	0.008	**	BF46034	12	2.595	1.177	0.128	0.004
PA30154	6	0.216	0.098	0.066	0.002	P40003	12	0.492	0.223	0.089	0.003	BF46037	12	1.025	0.465	0.060	0.002
PA30155	1	0.250	0.113	0.103	0.003	C40004	1	1.000	0.454	0.073	0.002	BF46038-D	12	0.750	0.340	0.046	0.001
PA30156	1	0.850	0.386	0.090	0.003	C40005	12	0.804	0.365	0.064	0.002	BF46039-D	12	0.721	0.327	0.065	0.002
PA30157	12	0.001	**	0.007	**	B40006	12	0.758	0.344	0.028	0.001	BF46040-D	12	0.562	0.255	0.049	0.001
PA30158	1	7.650	3.470	1.154	0.033	BC40007	12	0.400	0.181	0.022	0.001	BF46041-D	12	0.792	0.359	0.065	0.002
RS30159	1	8.400	3.810	2.174	0.062	P40008	6	1.100	0.499	0.194	0.005	BF46042-D	6	1.833	0.831	0.166	0.005
RS30160	1	2.450	1.111	0.691	0.020	BC40009	6	0.800	0.363	0.099	0.003	BF46043-D	6	1.883	0.854	0.164	0.005
RS30161	1	8.450	3.833	2.124	0.060	P40010	12	0.129	0.059	0.020	0.001	BF46044-D	12	0.800	0.363	0.063	0.002
RS30162	1	6.200	2.812	1.662	0.047	P40011	12	0.400	0.181	0.034	0.001	BF46045-D	12	0.708	0.321	0.051	0.001
PA30163	1	0.300	0.136	0.165	0.005	P40012	12	0.833	0.378	0.107	0.003	PF46046	12	0.650	0.295	0.081	0.002
PA30164	1	0.350	0.159	0.071	0.002	B40013	1	5.700	2.586	0.246	0.007	BF46048	12	1.692	0.767	0.066	0.002
PA30165	1	0.100	0.045	0.045	0.001	P40014	12	0.171	0.078	0.029	0.001	PF46049	12	0.500	0.227	0.058	0.002
PA30166	1	0.015	0.007	0.017	**	BT40015	12	0.595	0.270	0.027	0.001	BF46050	12	1.650	0.748	0.074	0.002
RS30168	1	4.300	1.950	0.856	0.024	P40017	12	0.400	0.181	0.067	0.002	BF46051	12	1.367	0.620	0.079	0.002
RS30169	1	1.000	0.454	0.238	0.007	P40019	1	0.800	0.363	0.127	0.004	BF46052	12	1.300	0.590	0.066	0.002
PA30170	1	9.450	4.287	2.087	0.059	P40020	12	0.354	0.161	0.053	0.001	PF46056	12	0.567	0.257	0.055	0.002
PA30171	1	6.000	2.722	1.456	0.041	P40021	12	0.304	0.138	0.049	0.001	PF46057	12	0.446	0.202	0.033	0.001
PA30172	6	0.833	0.378	0.285	0.008	B40022-MPG	12	2.017	0.915	0.099	0.003	BF46062	6	1.150	0.522	0.077	0.002
PA30173	1	0.250	0.113	0.060	0.002	P40023	12	0.325	0.147	0.048	0.001	BF46065-SPS	12	1.825	0.828	0.079	0.002
PA30174	6	0.858	0.389	0.181	0.005	P40024	12	0.238	0.108	0.032	0.001	BF46071	12	2.650	1.202	0.158	0.004
RS30175	1	7.950	3.606	1.901	0.054	P40025	1	0.329	0.149	0.046	0.001	BF46072	12	2.608	1.183	0.153	0.004
PA30177	6	0.533	0.242	0.103	0.003	BD40027	6	4.167	1.890	0.168	0.005	PF46077	12	0.158	0.072	0.020	0.001
PA30179	6	0.392	0.178	0.123	0.003	BT40028	12	1.042	0.473	0.049	0.001	BF46078-D	12	0.567	0.257	0.051	0.001
RS30180	1	5.800	2.631	1.544	0.044	P40030	12	0.463	0.210	0.088	0.002	BF46083-O	6	1.558	0.707	0.083	0.002
RS30181	1	2.500	1.134	0.768	0.022	P40031-MPG	6	1.383	0.627	0.188	0.005	BF46084	12	0.358	0.162	0.048	0.001
RS30182	1	8.400	3.810	1.974	0.056	BT40032	12	1.346	0.611	0.06							

BALDWIN WEIGHTS AND VOLUMES

BALDWIN NUMBER	CASE QTY.	WEIGHT (ea.) lbs.	WEIGHT (ea.) kgs.	Volume (ea.) ft ³	Volume (ea.) m ³	BALDWIN NUMBER	CASE QTY.	WEIGHT (ea.) lbs.	WEIGHT (ea.) kgs.	Volume (ea.) ft ³	Volume (ea.) m ³	BALDWIN NUMBER	CASE QTY.	WEIGHT (ea.) lbs.	WEIGHT (ea.) kgs.	Volume (ea.) ft ³	Volume (ea.) m ³
BF46100-O	6	1.550	0.703	0.092	0.003	OAS99002	1	3.600	1.633	0.315	0.009	G183	10	0.010	0.005	0.001	0.000
PF46103	12	0.300	0.136	0.035	0.001	OAS99003	1	6.650	3.016	0.861	0.024	G184-A	1	0.010	0.005	0.002	0.000
BF46111	12	0.929	0.421	0.048	0.001	OAS99004	1	17.100	7.757	1.279	0.036	G193	1	0.001	0.000	0.007	0.000
PF46112	12	0.358	0.162	0.037	0.001	OAS99005	1	3.704	1.680	0.280	0.008	G196-B	1	0.001	0.000	0.002	0.000
BF46113-D	12	0.575	0.261	0.050	0.001	OAS99006	1	13.900	6.305	1.966	0.056	G202	1	0.001	0.000	0.001	0.000
BF46117	6	2.150	0.975	0.106	0.003	OAS99008	1	20.500	9.299	2.695	0.076	G203	1	0.020	0.009	0.002	0.000
BF46122	12	2.238	1.015	0.101	0.003	OAS99010	1	5.600	2.540	0.385	0.011	G204-A	1	0.001	0.000	0.001	0.000
PF46119	12	0.038	0.017	0.004	0.000	OAS99011	1	5.750	2.608	0.475	0.013	G206	1	0.080	0.036	0.008	0.000
BF46125	12	0.150	0.068	0.012	0.000	OAS99014	1	20.000	9.072	2.260	0.064	G207-AF	1	0.100	0.045	0.014	0.000
BF46127	12	1.596	0.724	0.065	0.002	OAS99015	1	6.200	2.812	0.616	0.017	G208-A	1	0.010	0.005	0.001	0.000
BF46129	6	4.200	1.905	0.131	0.004	OAS99016	1	8.000	3.629	0.971	0.027	G210	1	0.020	0.009	0.003	0.000
PF46130	12	0.396	0.180	0.065	0.002	OAS99017	1	5.700	2.586	0.669	0.019	G211	1	0.001	0.000	0.003	0.000
BF46147-O	12	1.404	0.637	0.074	0.002	OAS99018	1	36.420	16.520	5.278	0.149	G214	1	0.001	0.000	0.001	0.000
BD50000	6	4.425	2.007	0.166	0.005	OAS99019	1	2.100	0.953	0.279	0.008	G219	1	0.020	0.009	0.002	0.000
OAS98000	12	0.920	0.417	0.032	0.001	OAS99020	1	6.100	2.767	0.408	0.012	G220	1	0.020	0.009	0.001	0.000
OAS98001	1	5.850	2.654	0.662	0.019	OAS99021	1	6.550	2.971	0.959	0.027	G222-B	1	0.020	0.009	0.001	0.000
OAS98002	1	6.100	2.767	0.605	0.017	OAS99023	1	5.800	2.631	0.431	0.012	G225-AF	1	0.180	0.082	0.193	0.005
OAS98003	1	6.550	2.971	0.569	0.016	OAS99024	1	4.900	2.223	0.483	0.014	G229	1	0.001	0.000	0.001	0.000
OAS98004	1	6.600	2.994	0.569	0.016	OAS99025	1	4.500	2.041	0.422	0.012	G232	1	0.020	0.009	0.001	0.000
OAS98005	1	4.950	2.245	0.595	0.017	OAS99028	1	3.800	1.724	0.210	0.006	G233-A	1	0.001	0.000	0.001	0.000
OAS98006	1	7.400	3.357	0.241	0.007	OAS99029	1	5.150	2.336	0.145	0.004	G233-B	1	0.001	0.000	0.001	0.000
OAS98007	1	7.400	3.357	1.443	0.041	OAS99032	1	2.450	1.111	0.088	0.002	G236-A	1	0.020	0.009	0.003	0.000
OAS98008	1	3.900	1.769	0.569	0.016	OAS99034	1	10.000	4.536	1.280	0.036	G238	1	0.001	0.000	0.007	0.000
OAS98009	1	13.150	5.965	2.356	0.067	OAS99035	12	1.679	0.762	0.128	0.004	G239	1	0.020	0.009	0.001	0.000
OAS98010	1	12.950	5.874	2.189	0.062	OAS99037	1	1.950	0.885	0.106	0.003	G240	1	0.020	0.009	0.001	0.000
OAS98011	1	3.750	1.701	0.538	0.015	OAS99038	1	9.550	4.332	1.493	0.042	G241	1	0.001	0.000	0.001	0.000
OAS98012	1	2.050	0.930	0.281	0.008	OAS99040	1	2.500	1.134	0.287	0.008	G243-A	1	0.010	0.005	0.001	0.000
OAS98013	1	34.300	15.558	6.493	0.184	OAS99042	1	6.300	2.858	0.403	0.011	G247	1	0.001	0.000	0.001	0.000
OAS98014	1	6.650	3.016	0.560	0.016	OAS99043	1	4.600	2.087	0.382	0.011	G251	1	0.001	0.000	0.001	0.000
OAS98015	1	19.650	8.913	3.062	0.087	OAS99046	1	15.200	6.895	2.057	0.058	G252	1	0.001	0.000	0.008	0.000
OAS98016	1	5.000	2.268	0.651	0.018	OAS99047	1	6.450	2.926	0.282	0.008	G253-A	1	0.020	0.009	0.002	0.000
OAS98017	1	22.600	10.251	3.844	0.109	OAS99048	1	2.750	1.247	0.080	0.002	G255	1	0.001	0.000	0.001	0.000
OAS98018	1	9.450	4.287	1.735	0.049	G15-AF	1	0.160	0.073	0.001	0.000	G257	1	0.010	0.005	0.002	0.000
OAS98019	1	6.050	2.744	0.939	0.027	G21-AF	1	0.020	0.009	0.019	0.001	G260	1	0.001	0.000	0.002	0.000
OAS98020	1	8.500	3.856	1.590	0.045	ES24-B	1	0.001	0.000	0.001	0.000	G261	1	0.001	0.000	0.004	0.000
OAS98021	1	33.650	15.264	4.768	0.135	ES24-D	1	0.001	0.000	0.001	0.000	G263	1	0.030	0.014	0.004	0.000
OAS98022	1	5.850	2.654	1.027	0.029	G25-AF	1	0.160	0.073	0.026	0.001	G264-A	1	0.001	0.000	0.001	0.000
OAS98023	1	6.200	2.812	1.777	0.050	G31-AF	1	0.040	0.018	0.022	0.001	G265	1	0.020	0.009	0.002	0.000
OAS98024	1	25.500	11.567	3.476	0.098	G34-AF	1	0.020	0.009	0.010	0.000	G268	1	0.001	0.000	0.001	0.000
OAS98025	1	9.700	4.400	1.519	0.043	G37-AF	1	0.060	0.027	0.025	0.001	G269	1	0.020	0.009	0.002	0.000
OAS98026	1	22.950	10.410	3.843	0.109	G39-AF	1	0.006	0.003	0.001	0.000	G270	1	0.001	0.000	0.001	0.000
OAS98027	1	14.400	6.532	3.970	0.112	G102-A	1	0.020	0.009	0.002	0.000	G273	1	0.010	0.005	0.001	0.000
OAS98028	1	4.400	1.996	0.250	0.007	G103	1	0.001	0.000	0.001	0.000	G274	1	0.019	0.009	0.001	0.000
OAS98029	1	2.150	0.975	0.309	0.009	G103-N	1	0.001	0.000	0.000	0.000	G275	1	0.020	0.009	0.001	0.000
OAS98030	1	97.000	43.999	17.916	0.507	G104	1	0.020	0.009	0.001	0.000	G278	1	0.040	0.018	0.004	0.000
OAS98031	1	8.750	3.969	1.463	0.041	G105	1	0.001	0.000	0.001	0.000	G280	1	0.001	0.000	0.002	0.000
OAS98032	1	7.050	3.198	0.613	0.017	G106	1	0.010	0.005	0.001	0.000	G281	1	0.020	0.009	0.002	0.000
OAS98033	1	15.700	7.122	2.194	0.062	G107	1	0.001	0.000	0.001	0.000	G283	1	0.001	0.000	0.000	0.000
OAS98034	1	30.850	13.994	3.804	0.108	G115-A	1	0.001	0.000	0.001	0.000	G285-AF	1	0.150	0.068	0.039	0.001
OAS98035	1	2.850	1.293	0.582	0.016	G115-MSB	1	0.001	0.000	0.001	0.000	G286-C	1	0.001	0.000	0.006	0.000
OAS98036	1	4.300	1.950	0.534	0.015	G120-A	1	0.025	0.011	0.001	0.000	G288	1	0.040	0.018	0.001	0.000
OAS98037	1	70.200	31.843	9.176	0.260	G123	1	0.010	0.005	0.001	0.000	G289	1	0.020	0.009	0.005	0.000
OAS98038	1	11.350	5.148	1.575	0.045	G127	1	0.020	0.009	0.001	0.000	G291	1	0.020	0.009	0.001	0.000
OAS98039	1	20.150	9.140	3.417	0.097	G132	1	0.020	0.009	0.001	0.000	G293-B	1	0.060	0.027	0.006	0.000
OAS98040	1	29.350	13.313	6.309	0.179	G133	1	0.001	0.000	0.001	0.000	G296	1	0.020	0.009	0.002	0.000
OAS98041	1	24.100	10.932	4.019	0.114	G140-A	1	0.016	0.007	0.002	0.000	G298-AF	1	0.100	0.045	0.040	0.001
OAS98042	1	21.800	9.888	3.450	0.098	G141-AF	1	0.267	0.121	0.402	0.011	G299	1	0.020	0.009	0.001	0.000
OAS98043	1	3.000	1.361	0.270	0.008	G143	1	0.001	0.000	0.002	0.000	G302	1	0.010	0.005	0.001	0.000
OAS98044	1	5.250	2.381	0.678	0.019	G144	1	0.020	0.009	0.002	0.000	G303	1	0.020	0.009	0.001	0.000
OAS98045	1	1.000	0.454	0.104	0.003	G145-AF	1	0.140	0.064	0.028	0.001	G304	1	0.020	0.009	0.027	0.001
OAS98046	1	13.900	6.305	2.662	0.075	G147-A	1	0.001	0.000	0.000	0.000	G305	1	0.001	0.000	0.006	0.000
OAS98047	1	38.100	17.282	4.770	0.135	G148	1	0.020	0.009	0.002	0.000	G306	1	0.080	0.036	0.007	0.000
OAS98048	1	94.000	42.638	13.790	0.390	G153	1	0.001	0.000	0.001	0.000	G307	1	0.001	0.000	0.002	0.000
OAS98049	1	11.650	5.284	3.970	0.112	G155	1	0.001	0.000	0.006	0.000	G309-B	1	0.001	0.000	0.009	0.000
OAS98050	1	28.050	12.723	3.724	0.105	G157	1	0.001	0.000	0.008	0.000	G310	1	0.001	0.000	0.002	0.000
OAS98052	1	24.400	11.068	3.851	0.109	G161	1	0.001	0.000	0.001	0.000	G314	1	0.020	0.009	0.004	0.000
OAS98053	1	32.850	14.901	6.309	0.179	G162	1	0.001	0.000	0.001	0.000	G315	1	0.001	0.000	0.002	0.000
OAS98054	1	25.350	11.499	5.715	0.162	G164-A	1	0.020	0.009	0.002	0.000	G323	1	0.001	0.000	0.001	0.000
OAS98056	1	4.750	2.155	0.651	0.018	G165	1	0.001	0.000	0.000	0.000	G332	1	0.010	0.005	0.001	0.000
OAS98057	1</																

BALDWIN WEIGHTS AND VOLUMES

BALDWIN NUMBER	CASE QTY.	WEIGHT (ea.) lbs.	WEIGHT (ea.) kgs.	Volume (ea.) ft ³	Volume (ea.) m ³	BALDWIN NUMBER	CASE QTY.	WEIGHT (ea.) lbs.	WEIGHT (ea.) kgs.	Volume (ea.) ft ³	Volume (ea.) m ³	BALDWIN NUMBER	CASE QTY.	WEIGHT (ea.) lbs.	WEIGHT (ea.) kgs.	Volume (ea.) ft ³	Volume (ea.) m ³
G344	1	0.008	0.004	0.001	**	ES1030	1	0.020	0.009	0.001	**	100-W30	1	4.850	2.200	0.235	0.007
G347	1	0.012	0.005	0.002	**	ES1031	1	0.018	0.008	0.001	**	101	18	0.364	0.165	0.032	0.001
G348-AF	1	0.120	0.054	0.028	0.001	ES1032	1	0.010	0.005	0.001	**	101-30	18	0.375	0.170	0.034	0.001
G354	1	0.014	0.006	0.003	**	ES1034	1	0.001	**	0.001	**	101-W	18	0.400	0.181	0.034	0.001
G356	1	0.028	0.013	0.003	**	ES1036	1	0.001	**	0.001	**	140-10	1	0.980	0.445	0.224	0.006
G359	1	0.016	0.007	0.003	**	ES1039	1	0.020	0.009	0.001	**	140-50 KIT	1	0.150	0.068	0.014	**
G360	1	0.014	0.006	0.002	**	ES1049	1	0.001	**	0.001	**	150	1	6.150	2.790	0.368	0.010
G362	1	0.020	0.009	0.002	**	ES1066	1	0.001	**	0.001	**	150-31	1	0.100	0.045	0.001	**
G363	1	0.014	0.006	0.002	**	ES1067	1	0.001	**	0.001	**	150-GK	1	0.010	0.005	0.007	**
G366	1	0.008	0.004	0.001	**	ES1068	1	0.001	**	0.001	**	150-H	1	6.400	2.903	0.387	0.011
G368	1	0.020	0.009	0.002	**	ES1071	1	0.001	**	0.001	**	150-M	1	7.250	3.289	0.379	0.011
G369-B	1	0.001	**	0.001	**	ES1074	1	0.001	**	0.001	**	150-W30	1	6.200	2.812	0.379	0.011
G369-V	1	0.010	0.005	0.002	**	G1086-AF	1	0.080	0.036	0.002	**	151	18	0.550	0.249	0.068	0.002
G372	1	0.032	0.015	0.002	**	ES1092	1	0.020	0.009	0.000	**	151-30	18	0.533	0.242	0.068	0.002
G376	1	0.013	0.006	0.001	**	ES1303-A	1	0.020	0.009	0.001	**	151-W	18	0.600	0.272	0.070	0.002
G379	1	0.006	0.003	0.001	**	ES1303-B	1	0.001	**	0.001	**	185-DS	1	0.300	0.136	0.042	0.001
G380	1	0.044	0.020	0.002	**	ES1369-A	1	0.020	0.009	0.001	**	186-SK	1	0.650	0.295	0.015	**
G381-A	1	0.013	0.006	0.001	**	ES1375	1	0.001	**	0.001	**	200	1	12.100	5.489	0.641	0.018
G382	1	0.016	0.007	0.003	**	ES1376	1	0.001	**	0.001	**	200-15	1	0.010	0.005	0.003	**
G382-V	1	0.024	0.011	0.003	**	ES1377	1	0.001	**	0.001	**	200-21	1	0.400	0.181	0.122	0.003
G385	1	0.001	**	0.003	**	G1972	1	0.060	0.027	0.014	**	200-21AL	1	1.700	0.771	0.113	0.003
G386	1	0.024	0.011	0.003	**	G1973	1	0.800	0.363	0.684	0.019	200-21BP	1	0.450	0.204	0.117	0.003
G392	1	0.032	0.015	0.003	**	ES3012	1	0.001	**	0.001	**	200-21H	1	0.550	0.249	0.111	0.003
G394	1	0.034	0.015	0.004	**	ES3028	1	0.001	**	0.001	**	200-21HBP	1	0.650	0.295	0.117	0.003
G397	1	0.001	**	0.002	**	ES3029	1	0.001	**	0.001	**	200-21M	1	0.550	0.249	0.118	0.003
G400	1	0.064	0.029	0.005	**	ES3063	1	0.001	**	0.001	**	200-30U	1	0.300	0.136	0.002	**
G401	1	0.001	**	0.001	**	ES3231	1	0.040	0.018	0.007	**	200-31	1	0.100	0.045	0.001	**
G402	1	0.010	0.005	0.001	**	ES4007	1	0.010	0.005	0.001	**	200-DEPR KIT	1	0.400	0.181	0.106	0.003
G403	1	0.006	0.003	0.001	**	ES4008	1	0.001	**	0.001	**	200-GK	1	0.020	0.009	0.012	**
G406	1	0.018	0.008	0.002	**	1S-9133	1	0.020	0.009	0.003	**	200-H	1	12.000	5.443	0.622	0.018
G409	1	0.026	0.012	0.002	**	4L-8212-R	1	0.020	0.009	0.002	**	200-M	1	13.300	6.033	0.642	0.018
G410	1	0.010	0.005	0.001	**	5H-5601	1	0.001	**	0.001	**	200-MFV	1	36.100	16.375	2.821	0.080
G411	1	0.028	0.013	0.002	**	5M-954	1	0.025	0.011	0.002	**	200-MMV	1	39.200	17.781	2.821	0.080
G412	1	0.020	0.009	0.004	**	6L-1540	1	0.010	0.005	0.004	**	200-W30	1	11.900	5.398	0.547	0.015
G416	1	0.056	0.025	0.005	**	7B-7635	1	0.010	0.005	0.002	**	201	8	0.894	0.406	0.128	0.004
G417	1	0.042	0.019	0.003	**	8M-7830	1	0.020	0.009	0.004	**	201-30	8	1.143	0.518	0.129	0.004
G422-AF	1	0.220	0.100	0.026	0.001	24-WLK	1	0.300	0.136	0.023	0.001	201-W	8	0.950	0.431	0.129	0.004
G431	1	0.012	0.005	0.001	**	55-EK	1	0.550	0.249	0.125	0.004	285-DS	1	0.200	0.091	0.082	0.002
G432	1	0.001	**	0.001	**	60-21	1	0.250	0.113	0.037	0.001	286-SK	1	0.800	0.363	0.013	**
G433	1	0.030	0.014	0.004	**	60-21A	1	0.150	0.068	0.041	0.001	300	1	15.750	7.144	0.863	0.024
G434	1	0.014	0.006	0.001	**	60-30	1	0.100	0.045	0.001	**	300-DHRAP5	1	120.000	54.432	37.875	1.072
G435	1	0.008	0.004	0.001	**	60-GK	1	0.100	0.045	0.005	**	300-DHRAS5	1	143.000	64.865	41.427	1.172
G436	1	0.016	0.007	0.001	**	61	12	0.238	0.108	0.016	**	300-H	1	15.800	7.167	0.871	0.025
G438	1	0.044	0.020	0.009	**	61-W	12	0.233	0.106	0.016	**	300-M	1	17.050	7.734	0.856	0.024
G439	1	0.024	0.011	0.003	**	65	1	1.550	0.703	0.111	0.003	300-MFV	1	49.250	22.340	3.737	0.106
G441	1	0.006	0.003	0.001	**	65-35A	1	0.050	0.023	0.018	0.001	300-MFV3	1	76.500	34.700	7.038	0.199
G442	1	0.007	0.003	0.001	**	65-W30	1	1.550	0.703	0.108	0.003	300-MMV	1	52.650	23.882	3.737	0.106
G443	1	0.012	0.005	0.002	**	66	12	0.229	0.104	0.016	**	300-MMV3	1	80.500	36.515	7.038	0.199
G444	1	0.001	**	0.002	**	66-30	12	0.217	0.098	0.016	**	300-W30	1	15.550	7.053	0.871	0.025
G445	1	0.026	0.012	0.003	**	66-W	12	0.229	0.104	0.016	**	301	4	1.600	0.726	0.254	0.007
G446	1	0.048	0.022	0.004	**	75	1	2.050	0.930	0.107	0.003	301-30	4	1.425	0.646	0.260	0.007
G447	1	0.011	0.005	0.001	**	75-21	1	0.600	0.272	0.036	0.001	301-CS	4	2.338	1.061	0.251	0.007
G449-B	1	0.001	**	0.001	**	75-W30	1	2.050	0.930	0.110	0.003	301-MPG	1	2.550	1.157	0.330	0.009
G458	1	0.001	**	0.001	**	85-EK	1	1.100	0.499	0.352	0.010	301-W	4	1.563	0.709	0.258	0.007
G467	1	0.003	0.001	0.001	**	85-P	1	0.300	0.136	0.008	**	500	1	248.000	112.493	34.050	0.964
G468	1	0.006	0.003	0.001	**	85-V	1	0.350	0.159	0.008	**	500-12	1	4.750	2.155	0.360	0.010
G472-AF	1	0.160	0.073	0.014	**	100	1	4.850	2.200	0.273	0.008	500-15	1	0.500	0.227	0.029	0.001
G480	1	0.020	0.009	0.001	**	100-12	1	0.300	0.136	0.042	0.001	500-BP	1	284.000	128.822	38.080	1.078
G483	1	0.020	0.009	0.001	**	100-21	1	0.250	0.113	0.040	0.001	500-BP22	1	289.500	131.317	38.250	1.082
G494	1	0.026	0.012	0.003	**	100-21AL	1	0.650	0.295	0.040	0.001	500-MFVBP22	1	780.000	353.808	72.575	2.054
G498-A	1	0.044	0.020	0.003	**	100-21BP	1	0.300	0.136	0.040	0.001	501	4	1.475	0.669	0.251	0.007
G499-AF	1	0.240	0.109	0.028	0.001	100-21M	1	0.300	0.136	0.040	0.001	501-30	4	1.438	0.652	0.252	0.007
G501-AF	1	0.107	0.049	0.053	0.001	100-28	1	0.010	0.005	0.001	**	501-W	4	1.588	0.720	0.258	0.007
AF521-WN	1	0.050	0.023	0.001	**	100-29	1	0.050	0.023	0.001	**	PKG50	1	0.850	0.386	0.033	0.001
G523-AF	1	0.290	0.132	0.010	**	100-30	1	0.100	0.045	0.001	**	PKG400	1	1.900	0.862	0.133	0.004
AF525-WN	1	0.001	**	0.001	**	100-BP	1	4.900	2.223	0.269	0.008	PKG401	1	1.950	0.885	0.134	0.004
G534-AF	1	0.020	0.009	0.024	0.001	100-DEPR KIT	1	0.250	0.113	0.064	0.002	PKG402	1	2.500	1.134	0.347	0.010
G704	1	0.040	0.018	0.001	**	100-GK	1	0.001	**	0.001	**	PKG406	1	2.750	1.247	0.200	0.006
G710	1	0.022	0.010	0.001	**	100-H	1	5.050	2.291	0.264	0.007	PKG406-W	1	0.001	**	0.001	**
G717	1	0.038	0.017	0.004	**	100-M	1	5.850	2.654	0.267	0.008	PKG411	1	0.550	0.249	0.063	0.002
G725	1	0.001	**	0.003	**	100-MFV	1	17.500	7.938	1.606	0.045	PKG412	1	1.250	0.567	0.333	0.009
ES1001	1	0.001	**	0.001	**	100-MMV	1	19.650	8.913	1.603	0.045	PKG475	1	0.040	0.018	0.001	**
ES1023	1	0.001	**	0.001	**	100-MNTG KIT	1	0.900	0.408	0.023	0.001	PKG490-BANK	12	0.708	0.321	0.050	0.001
ES1026	1	0.020	0.009	0.001	**	100-W	1	5.000	2.268	0.264	0.007						

BALDWIN WEIGHTS AND VOLUMES

BALDWIN NUMBER	CASE QTY.	WEIGHT (ea.) lbs.	WEIGHT (ea.) kgs.	Volume (ea.) ft ³	Volume (ea.) m ³	BALDWIN NUMBER	CASE QTY.	WEIGHT (ea.) lbs.	WEIGHT (ea.) kgs.	Volume (ea.) ft ³	Volume (ea.) m ³	BALDWIN NUMBER	CASE QTY.	WEIGHT (ea.) lbs.	WEIGHT (ea.) kgs.	Volume (ea.) ft ³	Volume (ea.) m ³		
Stanadyned Fuel Additives																			
38557P	24	0.542	0.246	0.025	0.001	43570P	12	1.092	0.495	0.049	0.001	43564C	12	1.096	0.497	0.047	0.001		
38559P	24	0.527	0.239	0.023	0.001	43572P	6	3.900	1.769	0.129	0.004	43566C	12	2.010	0.912	0.061	0.002		
38560P	12	1.000	0.454	0.042	0.001	43573P	1	524.000	237.686	10.622	0.301	43568C	24	0.500	0.227	0.020	0.001		
38561P	6	3.900	1.769	0.121	0.003	43574P	1	38.700	17.554	0.945	0.027	43570C	12	1.309	0.594	0.035	0.001		
38562P	1	49.420	22.417	1.356	0.038	38557C	24	0.529	0.240	0.027	0.001	43572C	6	3.983	1.807	0.127	0.004		
38563P	1	524.000	237.686	10.623	0.301	38559C	24	0.527	0.239	0.023	0.001	43573C	1	524.000	237.686	10.622	0.301		
38564P	24	0.556	0.252	0.024	0.001	38560C	12	1.000	0.454	0.043	0.001	43574C	1	39.050	17.713	0.945	0.027		
38565P	12	1.108	0.503	0.049	0.001	38561C	6	3.933	1.784	0.128	0.004	38557S	24	0.542	0.246	0.025	0.001		
38566P	6	4.200	1.905	0.129	0.004	38562C	1	49.420	22.417	1.356	0.038	38568S	1	435.330	197.466	10.622	0.301		
38567P	1	40.900	18.552	0.945	0.027	38563C	1	524.000	237.686	10.623	0.301	43562S	24	0.500	0.227	0.020	0.001		
38568P	1	435.330	197.466	10.622	0.301	38564C	24	0.556	0.252	0.024	0.001	43564S	12	1.071	0.486	0.048	0.001		
38574P	12	1.000	0.454	0.042	0.001	38565C	12	1.108	0.503	0.049	0.001	43566S	12	2.010	0.912	0.061	0.002		
38575P	1	38.800	17.600	0.945	0.027	38566C	6	4.208	1.909	0.126	0.004	43568S	24	0.538	0.244	0.024	0.001		
38576P	1	524.000	237.686	10.622	0.301	38567C	1	41.200	18.688	0.894	0.025	43570S	12	1.063	0.482	0.049	0.001		
43562P	24	0.546	0.248	0.023	0.001	38568C	1	524.000	237.686	10.622	0.301	43572S	6	4.725	2.143	0.148	0.004		
43564P	12	1.029	0.467	0.043	0.001	38574C	12	0.983	0.446	0.043	0.001	43573S	1	524.000	237.686	10.622	0.301		
43566P	12	2.010	0.912	0.061	0.002	38575C	1	49.420	22.417	1.356	0.038	43574S	1	49.420	22.417	1.356	0.038		
43568P	24	0.575	0.261	0.029	0.001	38576C	1	524.000	237.686	10.622	0.301								

NOTES

* Sold in Full Cases Only. TBD To be Determined. ** Measurement is less than 0.001.



WARNING: These products can expose you to chemicals, including Diisononyl Phthalate, Carbon black extracts, Nickel, 1,3 Butadiene, Ethylene Oxide, Epichlorohydrin, which are known to the State of California to cause cancer, and Bisphenol-A, Ethylene Glycol, Ethylene Oxide, 1,3 Butadiene, Epichlorohydrin, which are known to the State of California to cause birth defects or other reproductive harm. For more information go to www.P65Warnings.ca.gov.

FILTER WRENCHES

**PKG400 4 1/8" - 5" O.D.
(104.8 - 127.0)**



BT5	BT564	BF1346-O	B7164
B45	BF584	BF1346-SP	BD7166
B49	BF584-B	BF1347	BD7168
B75	BF588	BF1347-O	BD7169
B76	BF596	BF1348	B7171
B76-MPG	B605	BF1348-O	B7174-MPG
B76-SS	BT610-MPG	BF1348-SP	BD7176
B95	BT611-MPG	BF1349	B7179
B95-MPG	BT774	BF1353-SPS	B7189
B95-SS	BT775	BF1354-SPS	B7191
B96	BF783	BF1355	B7217
B96-MPG	BF784	BF1355-O	B7219
B96-SS	BF785	BF1355-SP	B7223
B97	BF786	BF1357	B7225
BD103	BF876	BF1358-O	B7227
BD103-MPG	BF877	BF1358-SP	B7239
BD103-SS	BF880-FP	BF1359-SP	B7241
B105	BF976	BF1360	B7246
BT124	BF1210	BF1360-O	BD7250
B128	BF1211	BF1360-SP	BD7252
B129	BF1216	BF1362	B7280
B134	BF1218	BF1363	BD7309
BD142	BF1219	BF1370	BD7310
B157	BF1222	BF1373-SP	BT7316
B196	BF1222-O	BF1374-SP	B7324
B201-S	BF1222-SP	BF1375	BD7325
B205	BF1223	BF1377	BD7353
B211	BF1223-O	BF1382-SP	BD7355
B218	BF1223-SP	BF1383-O	B7373
B220	BF1224	BF1386-O	B7383
BT221	BF1231	BF1387-O	B7385
B222	BF1240	BF1388-O	B7386
BD232	BF1256	BF1389-O	B7389
BT234	BF1262	BF1390-O	B7393
BT238	BF1265	BF1391-O	B7396
B263	BF1273-SP	BF1395-O	B7397
BT267	BF1274-SP	BF1395-SP	B7409
B309	BF1274-SPS	BF1397-SP	B7416
BD324	BF1277-SP	BF1399-SP	B7459
BD325	BF1277-SPS	B5177	B7460
B326	BF1281	BW5179	B7466
B333	BF1281-O	B7004	B7468
B337	BF1283	B7005	B7477
BT340	BF1283-O	B7009	B7478
BT347	BF1283-SP	B7018	B7481
BT348	BF1285-SP	B7019	B7482
BT349	BF1286	BD7028	B7483
BT350	BF1287-O	B7039	B7501
BT351	BF1288-O	B7045	B7503
BT351-MPG	BF1290-O	B7051	BD7504
BT355	BF1292-O	BD7105	B7506
BT359	BF1294-O	B7113	BD7509
BT398	BF1295-O	B7116	B7513
BT402	BF1296-O	B7121	B7577
B404	BF1297-O	B7124	BF7584
BT440	BF1298-O	B7130	B7585
BT443	BF1299-O	B7131	BF7593
B447	BF1329	BD7141	B7600
BT470	BF1329-O	B7142	B7600-SS
BT472	BF1329-SP	B7144	BF7612
B494	BF1330-SP	B7151	BF7613
B495	BF1339-SP	BD7153	BF7628
B495-MPG	BF1345	BD7154	BF7629
B495-SS	BF1345-O	B7155	B7637
BT521	BF1345-SP	BD7158	BF7656
BT556-10	BF1346	BD7159	BF7657

**PKG400 4 1/8" - 5" O.D. (Cont'd.)
(104.8 - 127.0)**

B7685	BT8805-MPG	BT9421-MPG	BF9898-O
BF7697	BT8812-MPG	BT9437	BF9903-SP
B7700	BT8813-MPG	BT9439	BF9912-O
BF7717	BT8870-MPG	BT9454	BF9917
BF7773	BT8873	BT9558-MPG	BF9920
BF7814	BT8874-MPG	BT9560-MPG	BF9921-O
BF7853	BT8875-MPG	B9604	BF9925-O
BF7911	BT8876-MPG	B9606	BT23542-MPG
BF7913	BT8877-MPG	B9607	BT23543-MPG
BF7927	BT8878-MPG	BF9800	BT23603-MPG
BF7932	BT8879-MPG	BF9802	BT23609-MPG
BF7943	BT8880-MPG	BF9811-SP	BD40027
BF7948	BT8890-MPG	BF9816	B40054
BT8302	BT8892-MPG	BF9817	BF46016-O
BT8320	BT8910-MPG	BF9818	BF46018-O
BT8381	BT8911-MPG	BF9832	BF46027-O
BT8401-MPG	BT8920	BF9844	BF46028-O
BT8432-MPG	BT9320	BF9860	BF46031
BT8450	BT9343-MPG	BF9864	BF46034
BF8457-MPG	BT9347-MPG	BF9866-O	BF46083-O
BT8475	BT9353-MPG	BF9867-O	BF46085
BT8503-MPG	BT9362-MPG	BF9869	BF46098-O
BT8800-MPG	BT9365-MPG	BF9871-O	BF46099-O
BT8801-MPG	BT9367-MPG	BF9880	BF46100-O
BT8802-MPG	BT9369-MPG	BF9885	BF46117
BT8803-MPG	BT9391-MPG	BF9888	BD50000

**PKG401 4 3/8" - 5 1/4" O.D.
(111.1 - 133.4)**



B49	BT425	BA5371	BD7509
B95	BT443	B7004	B7513
B95-MPG	BT486	B7005	BF7571
B95-SS	B495	B7011	B7577
B96	B495-MPG	B7019	BF7623
B96-MPG	B495-SS	BD7105	BF7697
B96-SS	BF596	BD7141	BF7717
B97	BT610-MPG	BD7153	BF7913
BD103	BT611-MPG	BD7154	BF7932
BD103-MPG	BT774	B7155	BF7948
BD103-SS	BT775	BD7159	BT8307-MPG
B105	BF784	BD7166	BT8308-MPG
B196	BF785	BD7169	BT8308-MPG KIT
B205	BF1216	BD7176	BT8309-MPG
B220	BF1239	B7217	BT8310-MPG
BT287	BF1262	B7239	BT8320
BT287-10	BF1274-SP	B7241	BT8368
BT287-3	BF1274-SPS	B7246	BT8381
BD324	BF1277-SP	BD7250	BT8401-MPG
B333	BF1277-SPS	BD7252	BT8421-MPG
BT345 KIT	BF1281-O	BD7309	BT8422-MPG
BT351	BF1283-O	BD7310	BT8423
BT351-MPG	BF1287-O	B7324	BT8424-MPG
BT359	BF1288-O	BD7325	BT8432-MPG
BT387	BF1347-O	B7335-MPG	BT8450
BT387-10	BF1355	BD7353	BT8457-MPG
BT388	BF1355-O	BD7355	BT8471-MPG
BT388-10	BF1355-SP	B7396	BT8475
BT389	BF1357	B7416	BT8475-MPG
BT389-10	BF1358-O	B7468	BT8476
B404	BF1395-O	B7503	BT8476-MPG
BT424	BD1403	BD7504	BT8477



WARNING: These products can expose you to chemicals, including Diisononyl Phthalate, Carbon black extracts, Nickel, 1,3 Butadiene, Ethylene Oxide, Epichlorohydrin, which are known to the State of California to cause cancer, and Bisphenol-A, Ethylene Glycol, Ethylene Oxide, 1,3 Butadiene, Epichlorohydrin, which are known to the State of California to cause birth defects or other reproductive harm. For more information go to www.P65Warnings.ca.gov.

FILTER WRENCHES

**PKG401 4 3/8" - 5 1/4" O.D. (Cont'd.)
(111.1 - 133.4)**

BT8477-MPG	BT8878-MPG	BT9345
BT8503-MPG	BT8879-MPG	BT9347-MPG
BT8510-MPG	BT8880-MPG	BT9353-MPG
BT8800-MPG	BT8890-MPG	BT9356
BT8801-MPG	BT8892-MPG	BT9360
BT8802-MPG	BT8901-MPG	BT9362-MPG
BT8803-MPG	BT8910-MPG	BT9365-MPG
BT8805-MPG	BT8911-MPG	BT9367-MPG
BT8812-MPG	BT8915	BT9369-MPG
BT8813-MPG	BT8927	BT9371-MPG
BT8870-MPG	BT8930	BT9391-MPG
BT8873	BT8931	BT9421-MPG
BT8874-MPG	BT8937	BT9439
BT8875-MPG	BT9320	BT9558-MPG
BT8876-MPG	BT9324	BT9560-MPG
BT8877-MPG	BT9343-MPG	BF9860

**PKG411 2 9/16" - 3 11/16" O.D.
(65.1 - 93.7)**

B2	BT261	BF592
B2-HPG	B262	BT595
B4	BT264	BF597
B6	BT274	BT606-MPG
B6-HPG	B279	BF614
B7	B281	BF719
B9	BT292	BF720
BF13	B295	BT778
BD28	B296	BT779
B30	B299	BF781
B31	T300-M	BF782
B33	B301	BF788
B34	BT305	BF789
B35-S	B307	BF790
B37	T308-M	BF791
B39	BT310	BF797
B43-S	B329	BF798
B50	BF330	BT839
B56	BT334	BT839-10
BT111	B336	BF862
BT112	BT338	BF863
B113	BT339	BF888
B118	BT341	BF891
B120	BT342	BF892
BT126	BT346	BF896
B131	BT353	BF900
B132	BT354	BF915
B141	BT357	BF938
B143	B358	BF939
B156	BT361	BF940
B159	BT364	BF941
B160	BT365	BF948
B161-S	BT365-10	BF948-JD
B163	BT366-10	BF954
B164	BT367	BF955
B167	BT367-S	BF956
B168	BT368	BF957
B173-S	B369	BF957-D
B178	BT372-10	BF958
B179	BT372-MPG	BF962
B195	B378	BF968
B199	B378-10	BF970
B202	BT395	BF971
BT215	B403	BF972
BT216	BT420	BF974-D
BT217	B421	B975
BT223	BT427	BF978
B227	BT452	BF979
B228	B474	BF980
B229	B481	BF984
BT230	B488	BF988
B233	BT525	BF991
B236	BT526	BF992
BT237	BT526-10	BF1056
B243	BT536	BF1102
B244	BT541	BF1110
B247	BF577	BF1204
BT248	BF582	BF1204-SP
BT251	BF583	BF1205
B252	BF585	BF1205-SP
B253	BF586	BF1212
B255	BF586-D	BF1213
BT259	BF587	BF1214
BT260	BF587-D	BF1217
BT260-10	BF591	BF1220



**PKG402 4 3/4" - 5 1/2" O.D.
(120.7 - 139.7)**



B99	BA5375	BF7639-D	BT8813-MPG
B99-B	BA5376	BF7996	BT8873
B99-MPG	BA5378	BT8307-MPG	BT8876-MPG
B99-SS	BA5379	BT8308-MPG	BT8899
B239	BA5566	BT8308-MPG	BT8901-MPG
BT287	BA5592	KIT	BT8906
BT287-10	B7011	BT8309-MPG	BT8915
BT287-3	B7030	BT8310-MPG	BT8921
BT343	B7097	BT8368	BT8927
BT345 KIT	B7135	BT8381	BT8930
BT351	B7157	BT8382	BT8931
BT351-MPG	B7161	BT8421-MPG	BT8937
BT387	B7162	BT8422-MPG	BT9164
BT387-10	B7175	BT8423	BT9320
BT388	B7180	BT8424-MPG	BT9324
BT388-10	B7182	BT8437	BT9343-MPG
BT389	B7187	BT8450	BT9345
BT389-10	B7224	BT8457-MPG	BT9356
BT424	B7229	BT8471-MPG	BT9360
BT425	B7245	BT8475	BT9371-MPG
BT486	B7246	BT8475-MPG	BT9377
BT774	B7249-MPG	BT8476	BT9387
BT775	B7299	BT8476-MPG	BT9533
BF799	B7314	BT8477	BT23140-MPG
BF1239	B7335-MPG	BT8477-MPG	BT23537
BF1287-O	B7363	BT8510-MPG	BT23539
BF1288-O	B7402	BT8800-MPG	BT23542-MPG
BF1355-O	B7507	BT8801-MPG	BT23609-MPG
BD1403	BF7571	BT8802-MPG	B40013
BA5284	BF7623	BT8803-MPG	
BA5371	BF7635	BT8805-MPG	
BA5374	BF7639	BT8812-MPG	



WARNING: These products can expose you to chemicals, including Diisononyl Phthalate, Carbon black extracts, Nickel, 1,3 Butadiene, Ethylene Oxide, Epichlorohydrin, which are known to the State of California to cause cancer, and Bisphenol-A, Ethylene Glycol, Ethylene Oxide, 1,3 Butadiene, Epichlorohydrin, which are known to the State of California to cause birth defects or other reproductive harm. For more information go to www.P65Warnings.ca.gov.

FILTER WRENCHES

**PKG411 2 9/16" - 3 11/16" O.D. (Cont'd.)
(65.1 - 93.7)**

B1432	B7128	B7384	BF7591-D
B1434	B7139	B7387	BF7598
B1435	B7143	B7388	BF7601
B1438	B7152	B7390	BF7602
B1441	B7156	B7392	BF7606
B1444	BD7160	B7395	BF7608
B1447	B7165	B7401	BF7609
BW5070	B7167	B7403	BF7614
BW5071	B7170	B7407	BF7619
BW5072	B7172	B7410	BF7624
BW5073	B7177	B7419	BF7631
BW5074	B7181	B7420	BF7632
BW5075	B7197	B7422	BF7633
BW5076	B7215	B7424	BF7634
BW5082	B7216	B7428	BF7637
B5088	B7220	B7429	BF7640
B5089	B7221	B7430	BF7644
B5090	B7222	B7432	BF7648
B5091	B7231	B7433	BF7653
B5134	BT7237	B7434	BF7663
BW5136	B7238	B7440	BF7664
BW5137	B7240	B7441	BF7666
BW5138	B7243	B7443	BF7683
BW5139	B7271	B7444	BF7695
BW5140	B7273	B7445	BF7696
BW5141	B7274	B7446	BF7747
BW5142	B7275	B7449	BF7750
BW5143	B7276	B7451	BF7753
B5144	B7277	B7453	BF7759
B5145	B7281	B7457	BF7760
B5176	B7283	B7458	BF7772
BW5178	B7285	B7461	BF7774
BW5182	B7286	B7462	BF7798-SP
BW5183	B7287	B7464	BF7806
BW5200	B7289	B7465	BF7813
BW5201	B7290	B7467	BF7837
BW5250	B7291	B7469	BF7838
BF5587-D	B7292	B7470	BF7840
BF5800	B7293	B7472	BF7841
BF5801	B7294	B7473	BF7879
BF5810	B7295	B7474	BF7880
BF5812	B7306	B7475	BF7883
BF5813	B7311-MPG	B7476	BF7886
BF5815	BD7317	B7487	BF7888
BF5816	B7318	B7491	BF7892
B7001	B7320	B7496	BF7907
B7010	B7327	B7497	BF7908
B7014	B7333	B7499	BF7909
B7020	B7334	B7511	BF7915
B7023	BT7349	BF7528	BF7917
B7024	B7351-MPG	BF7529	BF7919
B7025	B7352	BF7531	BF7921
B7026-MPG	B7356	BF7532	BF7922
B7031	B7360	BF7534	BF7923
B7033	B7361	BF7535	BF7925
B7042	B7362	BF7538	BF7931
B7049	B7367	BF7541	BF7940
B7082	B7369	BF7544	BF7957
B7089	B7370	BF7546	BF7966
B7091	B7372	BF7552	BF7967
BD7095	B7375	BF7557	BF7968
B7099	B7376	BF7558	BF7969
B7117	B7377	BF7559	BF7970
B7119	B7378	BF7586	BF7976
B7125	B7379	BF7587	BF7981

**PKG411 2 9/16" - 3 11/16" O.D. (Cont'd.)
(65.1 - 93.7)**

BF7985	BT8474	BT9388	BF9877
BF7990	BT8493	BT9392-MPG	BF9878
BF7993	BT8499	BT9393-MPG	BF9883
BF7998	BT8501-MPG	BT9402	BF9887
BT8304	BT8502	BT9408	BF9893
BT8314	BT8504	BT9440	BF9894
BT8316-MPG	BT8505	BT9442-MPG	BF9910
BT8323	BT8509-MPG	BT9464	BF9913
BT8328	BT8830	BT9465	BF9922-O
BT8333	BT8831	BF9812	BF9926-O
BT8357	BT8832	BF9813	BW21000
BT8384	BT8833	BF9815	B40000
BT8391	BT8886-MPG	BF9819	B40006
BT8393	BT8898	BF9821	BT40015
BT8398-MPG	BT8900	BF9821	BT40028
BT8409	BT8902	BF9831	BT40032
BT8413	BT8903	BF9834	BT40034
BT8415	BT8908	BF9840	B40036
BT8417	BT8916	BF9841	BF46012
BT8418	BT8917	BF9842	BF46014
BT8420	BT8918	BF9843	BF46015
BT8428-MPG	BT8926	BF9849	BF46021-O
BT8440-MPG	BT9325	BF9850	BF46022-O
BT8445	BT9346-MPG	BF9852	BF46032
BT8460	BT9349-MPG	BF9853	BF46048
BT8472	BT9366-MPG	BF9854	OAS98000
BT8473	BT9382	BF9876	

**PKG412 3 5/8" - 4" O.D.
(92.1 - 101.6)**



B2	B229	BT334	B403
B2-HPG	BT230	B336	BT420
B6	B233	BT338	BT427
B6-HPG	B236	BT339	BT438
B7	BT237	BT341	BT452
B9	BT241	BT342	B481
B27	B244	BT344-S	B488
BD28	B246	BT346	BT525
B34	BT248	BT354	BT526
B39	BT251	BT357	BT526-10
B50	B252	B358	BT536
B74	B253	B360	BT541
B109	B255	BT361	BF553
BT111	BT259	BT364	BF577
BT112	BT260	BT365	BF582
B114	BT260-10	BT365-10	BF583
B118	BT261	BT366-10	BF585
B120	B262	BT366-MPG	BF591
BT126	BT264	BT367	BF592
B132	BT274	BT367-S	BF593
B141	B279	BT368	BT595
B156	B281	B369	BF597
B163	BT292	BT371-10	BT606-MPG
B164	B296	BT371-5	BF614
B166	B299	BT371-MPG	BF719
B167	PT302	BT372-10	BF720
B173-S	T303-M	BT372-MPG	BT732
B202	PT304	B378	BT735
BT216	BT305	BT378-10	BT739
BT217	B329	BT395	BT778



WARNING: These products can expose you to chemicals, including Diisononyl Phthalate, Carbon black extracts, Nickel, 1,3 Butadiene, Ethylene Oxide, Epichlorohydrin, which are known to the State of California to cause cancer, and Bisphenol-A, Ethylene Glycol, Ethylene Oxide, 1,3 Butadiene, Epichlorohydrin, which are known to the State of California to cause birth defects or other reproductive harm. For more information go to www.P65Warnings.ca.gov.

FILTER WRENCHES

**PKG412 3 5/8" - 4" O.D. (Cont'd.)
(92.1 - 101.6)**

**PKG412 3 5/8" - 4" O.D. (Cont'd.)
(92.1 - 101.6)**

BT779 BF1278-O BF5815 B7420
 BF781 BF1279 BF5816 B7424
 BF789 BF1280 B7001 B7431
 BF791 BF1282 B7014 B7440
 BF791-O BF1282-O B7022 B7451
 BF792 BF1289-SP B7023 B7453
 BF797 BF1293-SPS B7024 B7467
 BF798 BF1350-SP B7025 B7486
 BT839 BF1352-SPS B7026-MPG B7496
 BT839-10 BF1356 BD7029 B7497
 BT841 BF1361 B7031 B7499
 BF862 BF1365 B7034 B7511
 BF863 BF1366-O B7042 BF7528
 BF888 BF1371 B7044 BF7529
 BF891 BF1376 B7047 BF7538
 BF892 BF1378-SPS B7082 BF7541
 BF896 BF1384-SP B7089 BF7546
 BF900 BF1385-SPS BD7095 BF7552
 BF915 BF1393-SP B7099 BF7557
 BF948 BF1394-SP B7117 BF7558
 BF948-JD BF1398-O BD7120 BF7559
 BF955 B1428 B7125 BF7586
 BF956 B1429 B7128 BF7587
 BF957 B1434 B7143 BF7602
 BF957-D B1438 B7152 BF7606
 BF958 B1441 B7156 BF7614
 BF962 B1446 B7163 BF7624
 BF968 BW5070 B7170 BF7631
 BF970 BW5071 B7177 BF7632
 BF971 BW5072 B7181 BF7633
 BF974-D BW5073 B7197 BF7640
 B975 BW5074 B7215 BF7644
 BF978 BW5075 B7220 BF7645
 BF979 BW5076 B7221 BF7653
 BF980 BW5082 B7231 BF7664
 BF984 BW5086 BT7237 BF7666
 BF991 B5087 B7240 BF7695
 BF992 B5088 B7271 BF7696
 BF1102 B5089 B7273 BF7747
 BF1204 B5090 B7274 BF7750
 BF1204-O B5091 B7291 BF7753
 BF1204-SP B5134 B7298 BF7759
 BF1205 BW5136 B7306 BF7760
 BF1205-SP BW5137 B7311-MPG BF7766
 BF1212 BW5138 BD7317 BF7774
 BF1213 BW5139 B7320 BF7798-SP
 BF1214 BW5140 B7322 BF7806
 BF1217 BW5141 B7327 BF7813
 BF1220 BW5142 B7328 BF7815
 BF1225 BW5143 BT7349 BF7842
 BF1233 B5144 B7350 BF7879
 BF1248 B5145 B7351-MPG BF7883
 BF1249 B5176 B7357 BF7886
 BF1249-O BW5178 B7359 BF7888
 BF1249-SP BW5182 B7360 BF7907
 BF1252 BW5183 B7362 BF7908
 BF1253 BW5200 B7372 BF7917
 BF1258 BW5201 B7375 BF7919
 BF1259 BW5250 B7376 BF7922
 BF1266 BF5800 B7377 BF7923
 BF1268 BF5801 B7378 BF7924
 BF1270-SP BF5810 B7379 BF7925
 BF1271 BF5812 B7388 BF7940
 BF1272-SPS BF5813 B7395 BF7941
 BF1278 BF5813-O B7403 BF7942

BF7955 BT8466-MPG BT8900 BF9877
 BF7957 BT8472 BT8903 BF9878
 BF7966 BT8473 BT8904-MPG BF9887
 BF7968 BT8474 BT8905 BF9893
 BF7968-O BT8486 BT8913-MPG BF9894
 BF7979 BT8488 BT8916 BF9904
 BF7981 BT8493 BT8918 BF9913
 BF7985 BT8497-MPG BT8919 BF9922-O
 BF7987 BT8499 BT8922 BF9923-O
 BF7988 BT8501-MPG BT8926 BF9926-O
 BF7993 BT8502 BT8928 BF9927
 BF7995 BT8504 BT8935 BW21000
 BF7997 BT8505 BT9211 BT23525-MPG
 BF8301 BT8509-MPG BT9316-MPG BT23540
 BT8304 BT8512 BT9318 BT23611
 BT8312 BT8830 BT9321 B40022-MPG
 BT8314 BT8831 BT9325 BT40028
 BT8316-MPG BT8832 BT9326 BT40032
 BT8328 BT8833 BT9346-MPG B40056
 BT8347 BT8834-MPG BT9358 BF46015
 BT8357 BT8840-MPG BT9363-MPG BF46017-O
 BT8391 BT8841-MPG BT9364 BF46019-O
 BT8393 BT8842-MPG BT9366-MPG BF46020-O
 BT8397-MPG BT8843-MPG BT9368-MPG BF46021-O
 BT8398-MPG BT8844 BT9370-MPG BF46022-O
 BT8415 BT8845 BT9382 BF46023-O
 BT8416 BT8846 BT9398-MPG BF46024-O
 BT8420 BT8847 BT9400-MPG BF46026-O
 BT8426-MPG BT8848-MPG BT9433 BF46029-O
 BT8428-MPG BT8849-MPG BT9436-MPG BF46030-O
 BT8439-MPG BT8850-MPG BT9442-MPG BF46032
 BT8440-MPG BT8851-MPG BT9456 BF46048
 BT8443 BT8852-MPG BT9465 BF46050
 BT8444 BT8853-MPG BT9466-MPG BF46065-SPS
 BT8445 BT8855-MPG BT9471 BF46111
 BT8449 BT8856-MPG BT9553 BF46127
 BT8449-10 BT8861 BT9561 OAS98060
 BT8463-MPG BT8862 B9601
 BT8464 BT8863 BF9820
 BT8465 BT8898 BF9834



WARNING: These products can expose you to chemicals, including Diisononyl Phthalate, Carbon black extracts, Nickel, 1,3 Butadiene, Ethylene Oxide, Epichlorohydrin, which are known to the State of California to cause cancer, and Bisphenol-A, Ethylene Glycol, Ethylene Oxide, 1,3 Butadiene, Epichlorohydrin, which are known to the State of California to cause birth defects or other reproductive harm. For more information go to www.P65Warnings.ca.gov.

BALDWIN FILTER DATE CODING METHODS

You will find several different date coding methods used on Baldwin products and packaging. Please look for one of these coding methods whenever you are trying to find the date of manufacture for a Baldwin product.

■ **Six (6) Digit Numeric Code - e.g. 010318**

Introduced November 8, 2002 (Replaces (3) Digit Numeric Code)

1st Two Digits	- 01 -	indicate month (January)
2nd Two Digits	- 03 -	indicate day of month (3rd)
Last Two Digits	- 18 -	indicate year (2018)

■ **Eleven (11) Digit Numeric Code - e.g. 08291314301**

Introduced November 8, 2002 (Replaces (10) Digit Numeric Code)

1st Two Digits	- 08 -	indicate month (August)
2nd Two Digits	- 29 -	indicate day of month (29th)
5th and 6th Digits	- 18 -	indicate year (2018)
Next 4 Digits	- 1430 -	indicate time of day (Military) (2:30 p.m.)
Last Digit	- 1 -	indicates filter line

Date Coding Methods Used Prior to 2003

■ **Three (3) Digit Numeric Code - e.g. 082**

1st Two Digits	- 08 -	indicate month (August)
Last Digit	- 2 -	indicates year (2002)

■ **Ten (10) Digit Numeric Code - e.g. 0829214303**

1st Two Digits	- 08 -	indicate month (August)
2nd Two Digits	- 29 -	indicate day of month (29th)
5th Digit	- 2 -	indicates year (2002)
Next 4 Digits	- 1430 -	indicate time of day (Military) (2:30 p.m.)
Last Digit	- 3 -	for internal control purposes

■ **Numeric Digits and Diamonds - e.g. 234 ◆◆◆◆◆**

1st Digit	- 2 -	indicates last digit of the year (2002)
Diamonds	- ◆◆◆◆◆ -	indicate month (August) Number of diamonds subtracted from 13 equals the month (13 - 5 = 8 = August)

A WORD ABOUT WARRANTIES

Heavy-duty equipment manufacturers and dealers like to sell their brand of filter. But, the law does not permit them to require you to use their brand in order to keep the warranty in effect. Baldwin filters meet or exceed manufacturers' requirements and specifications. If engine damage is caused by our filter, our warranty applies regardless of whether your equipment is still under the manufacturer's warranty.

If a filter is suspected of causing a failure, don't throw away the evidence. Instead, in order to process a warranty claim, follow the Product Investigation Procedure . . .

1. Complete a Field Report Form (Form 387). Describe the events on a separate sheet.

2. Obtain a sample of oil, fuel or coolant in the system at the time of the failure.
3. Save damaged parts for evidence of the claimed damage.
4. For an air filter, cover the open ends with tape to prevent dust from entering the element during shipping.
5. Send copies of any repair bills.
6. Send the entire suspect filter, including the gaskets. Do not cut open the filter or tamper with it in any way. Package the filter carefully to prevent damage to packaging or paperwork.

طرق تسجيل التاريخ الخاصة بمرشحات بولدوين (BALDWIN)

سوف تجد عدة طرق مختلفة لتسجيل التاريخ على منتجات وعبوات بولدوين Baldwin لذلك نرجو عند محاولة التعرف على تاريخ صنع أحد منتجات بولدوين (Baldwin) أن تطابق التاريخ مع إحدى هذه الطرق.

■ رمز عددي مكون من ستة (٦) أرقام - مثلاً: 010318

طرح هذه الطريقة للاستخدام في ٨ نوفمبر/تشرين الثاني ٢٠٠٣ (تحل محل الرمز العددي المكون من (٣) أرقام)	أول رقمين	01 -
يمثلان الشهر (يناير/كانون الثاني)	الرقمان الثالث والرابع	03 -
يمثلان اليوم بالنسبة إلى الشهر (اليوم الثالث)	آخر رقمين	18 -
يمثلان السنة (٢٠٠٥)		

■ رمز عددي مكون من أحد عشر (١١) رقماً - مثلاً: 08291814301

طرح هذه الطريقة للاستخدام في ٨ نوفمبر/تشرين الثاني ٢٠٠٣ (تحل محل الرمز العددي المكون من (١٠) أرقام)	أول رقمين	08 -
يمثلان الشهر (أغسطس/آب)	الرقمان الثالث والرابع	29 -
يمثلان اليوم بالنسبة إلى الشهر (التاسع والعشرون)	الرقمان الخامس والسادس	18 -
يمثلان السنة (٢٠٠٥)	الأربعة أرقام التالية	1430 -
تمثل الساعة (بالتوقيت العسكري) (٢:٣٠ عصراً)	الرقم الأخير	1 -
يمثل خط منتجات المرشح		

طرق تسجيل التاريخ المستخدمة قبل عام ٢٠٠٣

■ رمز عددي مكون من (٣) أرقام - مثلاً: 082

أول رقمين	08 -
الرقم الأخير	2 -

■ رمز عددي مكون من (١٠) أرقام - مثلاً: 0829214303

أول رقمين	08 -
الرقمان الثالث والرابع	29 -
الرقم الخامس	2 -
الأربعة أرقام التالية	1430 -
الرقم الأخير	3 -

■ الأرقام والعلامات المعينة مثلاً: 34 ◆◆◆◆◆

الرقم الأول	2 -
العلامات المعينة	◆◆◆◆◆ -
يمثل آخر رقم في السنة (٢٠٠٢)	
تمثل الشهر (أغسطس/آب)	
نتج طرح عدد العلامات من العدد ١٣ يعطي الشهر (١٣ - ٥ = ٨ = أغسطس/آب)	

كلمة عن الضمانات

(٢) أحصل على عينة من الزيت أو الوقود أو سائل التبريد الذي كان في الآلة وقت حدوث العطل.
(٣) احتفظ بالأجزاء المعطوبة كدليل على الخلل الذي تبلغ عنه.
(٤) وعليك في حالة مرشحات الهواء أن تغطي الأطراف المفتوحة بشريط لاصق لمنع التراب من الدخول إلى القطعة أثناء الشحن.
(٥) أرسل أيضاً صوراً بفواتير الإصلاحات.
(٦) أرسل المرشح المشكوك فيه كاملاً بما في ذلك حشو منع التسرب (الجوانات أو الكاسكيت). لا تشق المرشح لتفتحه أو تعث به بأي طريقة كانت. قم بتعبئة المرشح بعناية وحرصاً لتحمي العبوة والأوراق المرفقة من التلف.

إن منتجي وموزعي المعدات الثقيلة يحبون أن يبيعوا أصناف المرشحات الخاصة بهم. ولكن القانون لا يسمح لهم أن يلزموك باستخدام أصنافهم من أجل الحفاظ على صلاحية الضمان. إن مرشحات بولدوين (Baldwin Filters) تستوفي أو تفوق متطلبات ومواصفات المنتجين. ويسري ضماننا في حالة إصابة المحرك بتلف بسبب أحد مرشحاتنا، سواءً كان ضمان المنتج مازال سارياً أم لا.
فعليك إذا شككت في تسبب المرشح في خلل ما، ألا تتخلص من الأدلة. إنما تتمكن من طلب تطبيق الضمان عليك أن تبع إجراءات التحقق في المنتجس التالية:
(١) املاً نموذج بلاغ ميداني (نموذج رقم 387). صف الوقائع على ورقة منفردة.

BALDWIN 滤清器编码方法

Baldwin产品和包装上有几种日期编码方法。如果您想了解某一产品的制造日期，可采用其中之一编码方法。

■ 六(6) 位数字代码 - 如 010318

2002年11月8日开始采用 (代替三(3)位数字代码)

开头两位数字	- 01 -	表示月份 (1月)
中间两位数字	- 03 -	表示该月中的哪一天 (3日)
最后两位数字	- 18 -	表示年份 (2018年)

■ 十一(11) 位数字代码 - 如 08291814301

2002年11月8日开始采用 (代替十(10)位数字代码)

第一、二位数字	- 08 -	表示月份 (8月)
第三、四位数字	- 29 -	表示该月中的哪一天 (29日)
第五、六位数字	- 18 -	表示年份 (2018年)
接下来四位数字	- 1430 -	表示时间 (按军用方式, 下午2:30)
最后一位数字	- 1 -	表示滤清器类别

2003年以前使用的日期编码方法

■ 三(3) 位数字代码 - 如 082

1第一、二位数字	- 08 -	表示月份 (8月)
最后一位数字	- 2 -	表示年份 (2002年)

■ 十(10) 位数字代码 - 如 0829214303

第一、二位数字	- 08 -	表示月份 (8月)
第三、四位数字	- 29 -	表示该月中的哪一天 (29日)
第五位数字	- 2 -	表示年份 (2002年)
接下来四位数字	- 1430 -	表示时间 (按军用方式, 下午2:30)
最后一位数字	- 3 -	用于内部控制

■ 数字与菱形符号 - 如 234 ◆◆◆◆◆

第一位数字	- 2 -	表示年份(2002)的最后一个数字
菱形符号	- ◆◆◆◆◆ -	表示月份 (8月) 从13减去菱形符号的个数等于月份 (13 - 5 = 8 = 8月)

关于保用的说明

重型设备制造厂和经销商与销售他们自己品牌的滤清器。但是法律不允许他们要求您为了保持保用有效而一定要使用他们的品牌。Baldwin 滤清器未和或超过了制造厂的要求和规格。如果引擎损坏是由我们的滤清器造成的，则不论您的设备是否仍在制造厂的保用期内，我们的保用总是有效的。

如果怀疑滤清器造成故障，不要丢弃证据，而是应该按照产品调查程序办事，一边提出保用补偿。

1. 填写现场报告表格(表387)。另纸描述问题。

2. 在发生故障时，取得系统中油、燃油或冷却剂的样品。
3. 保留损坏的零部件作为索赔的证据。
4. 如果是空气滤清器，用胶带封好敞开端以防止运输过程中灰尘进入部件。
5. 寄来任何修理收费单的副本。
6. 将整个有怀疑的滤清器，包括垫圈寄来。请勿切开或撞动滤清器。小心包装滤清器以防损坏包装或单据。

MÉTHODES DE CODAGE DE DATE DES FILTRES BALDWIN

Vous trouverez plusieurs méthodes de codage de date sur les produits et emballages Baldwin. Veuillez rechercher une de ces méthodes de codage lorsque vous essayez de trouver la date de fabrication d'un produit Baldwin.

■ Code numérique à six (6) chiffres - Ex.: 010318

Introduit le 8 novembre 2002 (remplace le code numérique à trois (3) chiffres)

Deux premiers chiffres	- 01 -	indiquent le mois (janvier)
Deux chiffres du milieu	- 03 -	indiquent le jour du mois (3 ^e)
Deux derniers chiffres	- 18 -	indiquent l'année (2013)

■ Code numérique à onze (11) chiffres - Ex.: 08291814301

Introduit le 8 novembre 2002 (remplace le code numérique à dix (10) chiffres)

Deux premiers chiffres	- 08 -	indiquent le mois (août)
Deux chiffres suivants	- 29 -	indiquent le jour du mois (29 ^e)
5 ^e et 6 ^e chiffres	- 18 -	indiquent l'année (2018)
Quatre chiffres suivants	- 1430 -	indiquent l'heure (14h30)
Dernier chiffre	- 1 -	indique la gamme du filtre

Méthodes de codage de date utilisées avant 2003

■ Code numérique à trois (3) chiffres - Ex.: 082

Deux premiers chiffres	- 08 -	indiquent le mois (août)
Dernier chiffre	- 2 -	indique l'année (2002)

■ Code numérique à dix (10) chiffres - Ex.: 0829214303

Deux premiers chiffres	- 08 -	indiquent le mois (août)
Deux chiffres suivants	- 29 -	indiquent le jour du mois (29 ^e)
5 ^e chiffre	- 2 -	indique l'année (2002)
Quatre chiffres suivants	- 1430 -	indiquent l'heure (14h30)
Dernier chiffre	- 3 -	pour contrôle interne

■ Chiffres et losanges - Ex.: 234 ◆◆◆◆◆

Premier chiffre	- 2 -	indique le dernier chiffre de l'année (2002)
Losanges	- ◆◆◆◆◆ -	indiquent le mois (août) Nombre de losanges soustrait de 13 égal le mois (13 - 5 = 8 = août)

UN MOT SUR LES GARANTIES

Les concessionnaires et les fabricants de gros équipement aiment vendre les filtres de leur marque. Mais la loi ne les autorise pas à vous obliger d'utiliser leur marque pour conserver la garantie active. Les filtres Baldwin répondent ou surpassent les exigences et spécifications des fabricants. Si votre moteur est endommagé par nos filtres, notre garantie s'applique que votre équipement soit encore ou non sous la garantie du fabricant.

Si un filtre est soupçonné causer une défaillance, n'en jetez pas la preuve. Afin de pouvoir faire une réclamation au titre de la garantie, suivez la Procédure d'investigation de produit . . .

1. Remplissez un formulaire de rapport terrain (Form. 387). Décrivez les événements sur une feuille séparée.

2. Obtenez un échantillon d'huile, de carburant ou de liquide de refroidissement du système au moment de la défaillance.
3. Conservez les pièces endommagées comme preuve des dégâts pour la réclamation.
4. Pour un filtre à air, couvrez de ruban adhésif les extrémités ouvertes pour éviter que la poussière n'entre dans la cartouche pendant l'expédition.
5. Envoyez des copies des factures de réparation éventuelles.
6. Envoyez le filtre suspect entier, y compris les joints. N'ouvrez pas le filtre et n'essayez pas de le modifier de quelque façon que ce soit. Emballez-le soigneusement pour éviter d'endommager l'emballage ou les papiers.

BALDWIN FILTERS-DATUMSSCHLÜSSEL

Sie werden feststellen, dass mehrere verschiedene Datumsschlüssel auf Baldwin-Produkten und -Verpackungen in Gebrauch sind. Bitte suchen Sie nach einem dieser Schlüssel, wenn Sie nach dem Herstellungsdatum eines Baldwin-Produkts suchen.

■ Sechsstelliger Zifferncode - z.B. 010318

eingeführt am 8. November 2002 (tritt an die Stelle des dreistelligen Zifferncodes)

erste 2 Stellen	- 01 -	stehen für den Monat (Januar)
3. und 4. Stelle	- 03 -	stehen für Tag des Monats (3.)
5. und 6. Stelle	- 18 -	stehen für das Jahr (2018)

■ Elfstelliger Zifferncode - z.B. 08291814301

eingeführt am 8. November 2002 (tritt an die Stelle des zehnstelligen Zifferncodes)

erste 2 Stellen	- 08 -	stehen für den Monat (August)
3. und 4. Stelle	- 29 -	stehen für Tag des Monats (29.)
5. und 6. Stelle	- 18 -	stehen für das Jahr (2018)
nächste 4 Stellen	- 1430 -	stehen für die Tageszeit (14.30 Uhr)
letzte Stelle	- 1 -	steht für die Filterserie

Datierungsschlüssel vor 2003

■ Dreistelliger Zifferncode - z.B. 082

erste 2 Stellen	- 08 -	stehen für den Monat (August)
letzte Stelle	- 2 -	steht für das Jahr (2002)

■ Zehnstelliger (10) Zifferncode - z.B. 0829214303

erste 2 Stellen	- 08 -	stehen für den Monat (August)
nächste 2 Stellen	- 29 -	stehen für den Tag des Monats (29.)
fünfte Stelle	- 2 -	steht für das Jahr (2002)
nächste 4 Stellen	- 1430 -	stehen für die Uhrzeit (14.30 Uhr)
letzte Stelle	- 3 -	dient zu internen Prüfzwecken

■ Ziffern und Rauten - z.B. 234 ◆◆◆◆

1. Stelle	- 2 -	stehen für die letzte Ziffer der Jahreszahl (2002)
Rauten	- ◆◆◆◆ -	Monat (August) Anzahl der Rauten von 13 subtrahieren = Monat (13-5 = 8, d. h. August)

EIN WORT ZUR GARANTIE

Hersteller und Händler von Hochleistungsfahrzeugen und -maschinen möchten verständlicherweise ihre eigenen Filtermarken verkaufen. Das Gesetz untersagt es ihnen jedoch, Sie zur Verwendung ihrer Marken zu verpflichten, um Garantieansprüche aufrecht zu erhalten. Baldwin-Filter erfüllen oder übertreffen die Anforderungen und Spezifikationen der Hersteller. Bei Motorschäden, die durch unsere Filter hervorgerufen werden, gilt unsere Garantieleistung, ungeachtet der Frage, ob Ihr Fahrzeug/Ihre Maschine noch unter die Garantieleistung des Herstellers fällt.

Steht ein Filter im Verdacht, einen Ausfall hervorgerufen zu haben, werfen Sie das Beweisstück nicht weg. Um einen Garantieanspruch geltend zu machen, richten Sie sich bitte nach dem folgenden Produktuntersuchungsverfahren.

1. Füllen Sie einen Feldbericht aus (Form 387). Beschreiben Sie die Ereignisse auf einem anderen Blatt.

2. Nehmen Sie eine Öl-, Treibstoff- oder Kühlmittelprobe aus der Anlage zum Zeitpunkt des Ausfalls.
3. Heben Sie beschädigte Teile als Beweismaterial für reklamierte Schäden auf.
4. Bei einem Luftfilter verschließen Sie die offenen Enden mit Klebeband, um ein Eindringen von Staub in den Einsatz während des Versands zu vermeiden.
5. Schicken Sie Kopien der Reparaturrechnungen mit ein.
6. Schicken Sie den gesamten unter Verdacht stehenden Filter einschließlich Flachdichtung ein. Schneiden Sie den Filter nicht auf und manipulieren Sie ihn nicht. Verpacken Sie den Filter sorgfältig, um eine Beschädigung der Verpackung oder der Dokumente zu verhindern.

METODI PER LA CODIFICA DELLA DATA SUI FILTRI BALDWIN

Sui prodotti e gli imballaggi Baldwin vengono utilizzati diversi metodi per la codifica della data. Per trovare la data di produzione di un prodotto Baldwin ricercare uno dei metodi riportati di seguito.

■ Codice numerico a sei (6) cifre - ad es. 010318

Data di introduzione: 8 novembre 2002 (sostituisce il codice numerico a (3) cifre)

Le prime due cifre	- 01 -	indicano il mese (gennaio)
Le seconde due cifre	- 03 -	indicano il giorno (tre)
Le ultime due cifre	- 18 -	indicano l'anno (2018)

■ Codice numerico a undici (11) cifre - ad es. 08291814301

Data di introduzione: 8 novembre 2002 (sostituisce il codice numerico a (10) cifre)

Le prime due cifre	- 08 -	indicano il mese (agosto)
Le seconde due cifre	- 29 -	indicano il giorno (29)
La quinta e la sesta cifra	- 18 -	indicano l'anno (2018)
Le successive quattro cifre	- 1430 -	indicano l'ora (in formato 24 ore) (2:30 p.m.)
L'ultima cifra	- 1 -	indica la linea del filtro

Metodi per la codifica della data utilizzati prima del 2003

■ Codice numerico a tre (3) cifre - ad es. 082

Le prime due cifre	- 08 -	indicano il mese (agosto)
L'ultima cifra	- 2 -	indica l'anno (2002)

■ Codice numerico a dieci (10) cifre - ad es. 0829214303

Le prime due cifre	- 08 -	indicano il mese (agosto)
Le seconde due cifre	- 29 -	indicano il giorno (29)
La quinta cifra	- 2 -	indica l'anno (2002)
Le successive quattro cifre	- 1430 -	indicano l'ora (in formato 24 ore) (2:30 p.m.)
L'ultima cifra	- 3 -	per controllo interno

■ Codici numerici e rombi - ad es. 234 ◆◆◆◆

La prima cifra	- 2 -	indica l'ultima cifra dell'anno (2002)
I rombi	- ◆◆◆◆ -	indicano il mese (agosto) Il risultato della sottrazione tra il numero 13 e il numero di rombi fornisce l'indicazione del mese (13 - 5 = 8 = agosto)

NOTA SULLE GARANZIE

I produttori e i rivenditori di apparecchiature "heavy-duty" privilegiano la vendita della propria marca di filtri. Tuttavia, la legge vieta a produttori e rivenditori di richiedere al cliente l'utilizzo dei loro filtri per conservare la validità della garanzia. I filtri Baldwin soddisfano o superano i requisiti e le specifiche dei produttori. Se il danno al motore è causato da un filtro Baldwin, la garanzia viene applicata indipendentemente dalla validità della garanzia fornita dal produttore dell'apparecchiatura.

Se la causa del guasto può essere imputabile ad un filtro Baldwin, conservare le eventuali prove. Al contrario, per inoltrare un reclamo in garanzia, seguire la "Product Investigation Procedure" (procedura per l'analisi del prodotto).

1. Compilare un Field Report Form (modulo di relazione sul campo) (Modulo 387) in ogni sua parte. Allegare una descrizione dei fatti su un foglio separato.
2. Procurarsi un campione di olio, carburante o liquido

refrigerante del sistema presenti al momento del guasto.

3. Conservare i pezzi danneggiati a prova del danno oggetto del reclamo.
4. In caso di filtri aria, coprire le estremità aperte con del nastro per impedire che la polvere penetri nell'elemento durante la spedizione.
5. Inviare copia delle fatture relative alle spese per la riparazione.
6. Inviare tutti i componenti del filtro, comprese le guarnizioni. Non aprire il filtro né manometterlo in alcun modo. Imballare accuratamente il filtro per evitare danni all'imballaggio o alla relativa documentazione.

MÉTODOS DE CODIFICAÇÃO POR DATA DOS FILTROS BALDWIN

Você encontrará diversos métodos de codificação por data nos produtos e embalagens Baldwin. Por favor, procure um destes métodos de codificação sempre que tentar encontrar a data de fabricação de um produto Baldwin.

■ Código Numérico de Seis (6) Dígitos - Exemplo: 010318

Introduzido em 8 de novembro de 2002 (Substitui o código numérico de 3 dígitos)

Primeiros Dois Dígitos	- 01 -	indicam o mês (janeiro)
Segundos Dois Dígitos	- 03 -	indicam o dia do mês (3)
Últimos Dois Dígitos	- 18 -	indicam o ano (2018)

■ Código Numérico de Onze (11) Dígitos - Exemplo: 08291814301

Introduzido em 8 de novembro de 2002 (Substitui o código numérico de 10 dígitos)

Primeiros Dois Dígitos	- 08 -	indicam o mês (agosto)
Segundos Dois Dígitos	- 29 -	indicam o dia do mês (29)
Quinto e Sexto Dígitos	- 18 -	indicam o ano (2018)
Próximos 4 Dígitos	- 1430 -	indicam a hora do dia (14h 30m)
Último Dígitos	- 1 -	indica a linha de filtro

Métodos de Codificação por Data Usados Antes de 2003

■ Código Numérico de Três (3) Dígitos - Exemplo: 082

Primeiros Dois Dígitos	- 08 -	indicam o mês (agosto)
Último Dígitos	- 2 -	indica o ano (2002)

■ Código Numérico de Dez (10) Dígitos - Exemplo: 0829214303

Primeiros Dois Dígitos	- 08 -	indicam o mês (agosto)
Segundos Dois Dígitos	- 29 -	indicam o dia do mês (29)
Quinto Dígitos	- 2 -	indica o ano (2002)
Próximos 4 Dígitos	- 1430 -	indicam a hora do dia (14h 30m)
Último Dígitos	- 3 -	para fins de controle interno

■ Dígitos Numéricos e Sinais de Diamantes - Exemplo: 234 ◆◆◆◆

Primeiro Dígitos	- 2 -	indica o último dígitos do ano (2002)
Sinais de Diamantes	- ◆◆◆◆ -	indicam o mês (agosto)

O número de sinais de diamantes subtraído de 13 é igual ao número do mês (13 – 5 = 8 = agosto)

UMA NOTA SOBRE GARANTIA

Os fabricantes e comerciantes de equipamentos para serviços pesados gostam de vender filtros de suas marcas. Porém, a lei não permite que eles exijam que você use as suas marcas a fim de manter a garantia válida. Os filtros Baldwin atendem ou excedem as especificações e requisitos dos fabricantes. Se um dano ao motor for causado por nosso filtro, a nossa garantia é válida, a despeito do seu equipamento ainda estar dentro da garantia do fabricante.

Se um filtro for suspeito de causar um defeito, não jogue fora as evidências. Ao invés, a fim de processar a reclamação de garantia, siga o Procedimento de Investigação de Produto...

1. Preencha o Formulário de Relatório de Campo (Formulário 387). Descreva os fatos numa folha separada.

2. Obtenha uma amostra de óleo, combustível ou refrigerante no sistema na ocasião do defeito.
3. Guarde as peças danificadas como prova do defeito alegado.
4. Para um filtro de ar, cubra as extremidades abertas com fita adesiva para impedir a entrada de pó no elemento durante o transporte.
5. Envie cópias de quaisquer faturas de reparos.
6. Envie todo o filtro suspeito, incluindo as juntas. Não abra o filtro nem o modifique. Acondicione o filtro cuidadosamente para evitar avarias na embalagem ou nos documentos.

МЕТОДЫ УКАЗАНИЯ ДАТЫ НА ФИЛЬТРАХ КОМПАНИИ “БОЛДУИН”

Для обозначения дат на изделиях и упаковке компании “Болдуин” применяется несколько различных методов. В тех случаях, когда вам требуется найти дату изготовления изделия “Болдуин”, следует искать один из указанных ниже вариантов обозначений.

■ Цифровое обозначение из 6 (шести) цифр - например: 010318

— данные обозначения применяются с 8 ноября 2002 г. (и заменяют обозначения из 3 цифр)

Первые две цифры	- 01 -	обозначают месяц (январь)
Вторые две цифры	- 03 -	обозначают день месяца (3-е)
Последние две цифры	- 18 -	обозначают год (2018)

■ Обозначение из 11 (одиннадцати) цифр - например: 08291814301

— данные обозначения применяются с 8 ноября 2002 г. (и заменяют обозначения из 10 цифр)

Первые две цифры	- 08 -	обозначают месяц (август)
Вторые две цифры	- 29 -	обозначают день месяца (29-е)
Пятая и шестая цифры	- 18 -	обозначают год (2018)
Следующие четыре цифры	- 1430 -	обозначают время (14:30)
Последняя цифра	- 1 -	обозначает серию фильтра

Методы указания даты, применявшиеся до 2003 г.

■ Обозначение из 3 (трех) цифр - например: 082

Первые две цифры	- 08 -	обозначают месяц (август)
Последняя цифра	- 2 -	обозначает год (2002)

■ Обозначение из 10 (десяти) цифр - например: 0829214303

Первые две цифры	- 08 -	обозначают месяц (август)
Вторые две цифры	- 29 -	обозначают день месяца (29-е)
Пятая цифра	- 2 -	обозначает год (2002)
Следующие четыре цифры	- 1430 -	обозначают время (14:30)
Последняя цифра	- 3 -	предназначается для внутреннего контроля

■ Цифры и ромбики - например: 234 ◆◆◆◆

Первые цифра	- 2 -	обозначает последнюю цифру года (2002)
Ромбики	- ◆◆◆◆ -	обозначают месяц (август) При вычитании числа ромбиков из числа 13 мы получаем месяц (13 - 5 = 8, т.е. август)

ПРИМЕЧАНИЕ О ГАРАНТИИ

Изготовители и дилеры, предлагающие оборудование, предназначенное для эксплуатации в тяжелом режиме, предпочитают продавать фильтры собственных торговых марок. Однако согласно законодательству они не вправе потребовать от вас использования продукции их торговых марок в качестве условия сохранения гарантии. Характеристики фильтров “Болдуин” соответствуют параметрам, установленным на основании требований и технических условий изготовителей, или превышают данные параметры. Если использование одного из наших фильтров послужило причиной повреждения двигателя, наша гарантия действует независимо от того, находится ли ваше оборудование на гарантии производителя.

Если имеются основания считать, что фильтр послужил причиной отказа, не следует выбрасывать доказательства. Вместо этого, для предъявления гарантийной рекламации, необходимо выполнить инструкцию по расследованию причин отказа изделия . . .

1. Заполните форму протокола по отказам на месте эксплуатации (форма 387). —айте описание событий на отдельном листе.
2. Возьмите пробу масла, топлива или охлаждающей жидкости, находящейся в системе во время отказа.
3. Сохраните поврежденные детали в качестве едоказательств наличия повреждений согласно рекламации.
4. В случае с воздушным фильтром заклейте открытые торцы клейкой лентой для того, чтобы предотвратить пыли внутрь детали во время транспортировки.
5. Пришлите копии счетов за все ремонтные работы.
6. Пришлите блок фильтра, в котором предполагается наличие неисправностей, в сборе с прокладками. Не открывайте фильтр и не вносите в его конструкции никаких изменений. Аккуратно упакуйте фильтр для того, чтобы предотвратить повреждение упаковки или документации.

MÉTODOS DE CODIFICACIÓN DE LA FECHA EN LOS FILTROS BALDWIN

En los productos y envases de Baldwin se encontrarán varios métodos distintos de codificación de la fecha. Rogamos buscar uno de estos métodos de codificación cuando se desee encontrar la fecha de fabricación de un producto Baldwin.

■ Código numérico de seis (6) dígitos - por ej., 010318

Presentado el 8 de noviembre de 2002 (reemplaza al código numérico de tres (3) dígitos)

Primeros dos dígitos	- 01 -	indican el mes (enero)
Segundos dos dígitos	- 03 -	indican el día del mes (tercer)
Últimos dos dígitos	- 18 -	indican el año (2018)

■ Código numérico de once (11) dígitos - por ej., 08291814301

Presentado el 8 de noviembre de 2002 (reemplaza al código numérico de diez (10) dígitos)

Primeros dos dígitos	- 08 -	indican el mes (agosto)
Segundos dos dígitos	- 29 -	indican el día del mes (29)
Quinto y sexto dígito	- 18 -	indican el año (2018)
Siguientes 4 dígitos	- 1430 -	indican la hora del día (militar) (2:30 p.m.)
Último dígito	- 1 -	indica la línea de filtro

Métodos de codificación de fecha utilizados antes de 2003

■ Código numérico de tres (3) dígitos - por ej., 082

Primeros dos dígitos	- 08 -	indican el mes (agosto)
Último dígito	- 2 -	indica el año (2002)

■ Código numérico de 10 dígitos - por ej., 0829214303

Primeros dos dígitos	- 08 -	indican el mes (agosto)
Segundos dos dígitos	- 29 -	indican el día del mes (29)
Quinto dígito	- 2 -	indica el año (2002)
Próximos 4 dígitos	- 1430 -	indican la hora del día (militar) (2:30 pm)
Último dígito	- 3 -	para propósitos de control interno

■ Dígitos numéricos y rombos - por ej., 234 ◆◆◆◆◆

Primer dígito	- 2 -	indica el último dígito del año (2002)
Rombos	- ◆◆◆◆◆ -	indican el mes (agosto) 13 menos el número de rombos es igual al mes (13 - 5 = 8 = Agosto)

UNA PALABRA ACERCA DE LAS GARANTÍAS

Los fabricantes y concesionarios de equipos para servicio pesado prefieren vender su marca de filtro. Pero, por ley no les está permitido a exigir el uso de su marca para mantener vigente la garantía. Los filtros Baldwin cumplen o exceden los requerimientos y las especificaciones de los fabricantes. Si el motor se llegara a dañar por culpa de nuestro filtro, nuestra garantía es la que es válida indiferente a si el equipo todavía está cubierto por la garantía del fabricante.

Si se sospecha que un filtro es el causante de la avería, no tire a la basura la evidencia. En vez, para poder tramitar el reclamo de garantía, siga el procedimiento de investigación del producto...

1. Llene un formulario de informe de campo (Form 387). Describa los eventos en una hoja aparte.

2. Saque una muestra del aceite, combustible o refrigerante del sistema al momento de ocurrir la avería.
3. Guarde las piezas dañadas como evidencia del daño reclamado.
4. Para un filtro de aire, tape los extremos abiertos con cinta adhesiva con el fin de evitar la entrada de polvo al elemento durante el transporte.
5. Envíe copias de cualquier factura de reparación.
6. Envíe el filtro sospechoso completo, incluidas las juntas. No abra el filtro ni lo estorbe de manera alguna. Empaquete el filtro cuidadosamente para impedir que se dañe el empaquetado o los documentos.

BALDWIN FILTER WARRANTY

BALDWIN WARRANTY (English)

Baldwin Filters, Inc. ("Baldwin") warrants that each new product manufactured by Baldwin will be made free of defects in workmanship and material. Baldwin will replace any product found to be defective when you return it to Baldwin or to your Baldwin distributor where you purchased the product.

Return Process

You should first contact your salesperson at Baldwin or at your Baldwin distributor if you purchased a product that you believe does not meet the warranty stated above. The salesperson will help you complete the necessary paperwork, and will also help you return the suspected defective product to Baldwin for analysis.

Warranty Fulfillment

If Baldwin finds that a returned product does not meet the warranty stated above, Baldwin will promptly replace the defective product. If the defective product directly caused damage to the machine on which it was installed, Baldwin will promptly reimburse the machine owner for that portion of the repair costs that were necessary to restore the machine to its condition immediately prior to the damage caused by the defective product.

Conditions

Baldwin's warranty fulfillment obligations above do not apply if: a) the product is not returned to Baldwin for analysis, b) Baldwin finds that the product was not defective, c) the product was improperly installed or used, d) the product was re-used or not replaced inside a normal service interval, or e) the product is tampered with or damaged in a manner that may inhibit Baldwin's ability to conduct a warranty investigation.

The above warranty and warranty fulfillment obligations are exclusive and in lieu of all other warranties or related remedies. Baldwin is not liable for indirect, incidental, punitive or consequential damages arising in any way from the products it manufactures or sells.

(العربية / Arabic) ضمان شركة بولدوين

تضمن شركة بولدوين فلترز («بولدوين») أن كل منتج جديد تصنعه الشركة خال من العيوب سواء عيوب الصناعة أو مواد التصنيع. وفي حال وجود عيب في المنتج؛ فإن الشركة ستستبدله بأخر سليم عند إرجاعه إليها أو إلى موزع الشركة الذي تم شراء المنتج منه.

عملية الإرجاع

يجب عليك أولاً الاتصال بمندوب المبيعات في شركة بولدوين أو في موزع شركة بولدوين في حال شراء منتج تعتقد أنه لا يفي بالضمان المذكور أعلاه. بعد ذلك، سيساعدك مندوب المبيعات على استكمال الأوراق اللازمة كما سيساعدك في إرجاع المنتج الذي تشبه في وجود عيب به إلى شركة بولدوين كي يتم تحليله.

استيفاء الضمان

إذا وجدت شركة بولدوين أن المنتج الذي تم إرجاعه لا يستوفي الضمان المذكورة أعلاه؛ فإنها ستستبدل المنتج المعيب على الفور. إذا تسبب المنتج المعيب في إحداث أضرار مباشرة بالآلة التي تم تركيبه بها، فإن شركة بولدوين ستعوض مالك الآلة بتحمل تكاليف الإصلاحات اللازمة للجزء الذي به الضرر لإعادة الجهاز إلى حالته السابقة التي كان عليها قبل حدوث الضرر الناجم عن المنتج المعيب.

الشروط

لا تنطبق التزامات استيفاء ضمان شركة بولدوين الواردة أعلاه في حالة: أ) عدم إرجاع المنتج إلى شركة بولدوين كي يتم تحليله أو ب) إذا وجدت الشركة أن المنتج خال من العيوب أو ج) في حالة تركيب المنتج أو استخدامه بطريقة غير سليمة أو د) في حالة إعادة استخدام المنتج أو عدم تركيبه بداخل فاصل الخدمة العادية أو هـ) في حالة العبث بالمنتج أو إحداث أضرار به على النحو الذي قد يحول دون تمكن الشركة من إجراء التحقيق اللازم للضمان.

يقتصر الضمان والتزامات استيفاء الضمان الواردة أعلاه على المنتج ويُعمل بهم بدلاً من جميع الضمانات أو التعويضات الأخرى. إن شركة بولدوين غير مسؤولة عن الأضرار غير المباشرة أو العرضية أو التأديبية أو اللاحقة الناشئة بأي شكل من الأشكال من المنتجات التي تصنعها أو تبيعها.

BALDWIN FILTER WARRANTY

宝德威保用说明 (Chinese / 中文)

宝德威过滤器公司（下称“宝德威”）保证由本公司制造的每件新的产品在工艺和材料上均无缺陷。任何产品若发现有缺陷，可退回宝德威或您向其购买产品的宝德威经销商，本公司负责更换。

退货流程

如果您认为购买的产品不符合以上保用说明，首先应联系宝德威或宝德威经销商的销售人员。销售人员将帮助您完成必要的文书手续，并协助您将怀疑有缺陷的产品退回宝德威分析。

履行保用

如果宝德威认为退回的产品不符合上述保用说明，宝德威将及时更换有缺陷的产品。如果有缺陷的产品直接造成其所安装的机器损坏，宝德威将及时赔偿机器业主将机器恢复到缺陷产品造成损坏之前状态所必需的修理费用。

条件

如果存在以下情况，宝德威的履行保用的义务即不适用： a)产品未退回宝德威供分析； b)宝德威认为产品并无缺陷； c)产品安装或使用不当； d)产品系重复使用或未在正常服务间隔内更换，或 e)产品遭到篡改或损坏，以致宝德威无法进行保用调查。

以上保用及保用履行义务具排他性并取代所有其它保用或相关补救措施。宝德威对由其制造或销售的产品以任何方式造成的间接性、偶然性、惩罚性或后果性损失赔偿概不承担责任。

WARRANTY NG BALDWIN (Filipino)

Tinitiyak ng Baldwin Filters, Inc. ("Baldwin") na ang bawat bagong produktong lilikhain ng Baldwin ay gagawin nang walang mga depekto sa pagkakagawa at materyales. Papalitan ng Baldwin ang anumang produktong nakitang depektibo kapag isinauli ninyo ito sa Baldwin o sa inyong distributor ng Baldwin kung saan ninyo binili ang produkto.

Proseso ng Pagsauli

Dapat muna kayong makipag-ugnayan sa inyong salesperson sa Baldwin o sa inyong distributor ng Baldwin kung sa tingin ninyo ay bumili kayo ng produktong hindi natutugunan ang warranty na inihayag sa itaas. Tutulungan kayo ng salesperson na kumpletuhin ang kinakailangang papeles, at tutulungan din kayong isauli sa Baldwin ang produktong pinaghihinalaang depektibo para suriin.

Pagtupad sa Warranty

Kung malaman ng Baldwin na hindi natutugunan ng isang isinauling produkto ang warranty na inihayag sa itaas, papalitan kaagad ng Baldwin ang depektibong produkto. Kung direktang nagdulot ng sira ang depektibong produkto sa machine kung saan ito inilagay, babayaran ng Baldwin ang may-ari ng machine para sa bahagi ng gastusin sa pagkumpuni na kinailangan upang ibalik ang machine sa kundisyon nito bago ang sira na idinulot ng depektibong produkto

Mga Kundisyon

Walang bisa ang mga obligasyon ng pagpapatupad ng warranty ng Baldwin kung: a) hindi isinauli sa Baldwin ang produkto para sa pagsusuri, b) nakita ng Baldwin na hindi depektibo ang produkto, c) na-install o ginamit nang mali ang produkto, d) ginamit muli o hindi pinalitan ang produkto sa loob ng normal na tagal ng serbisyo, o e) pinakialaman o nasira ang produkto sa isang paraan na humahadlang sa kakayahang ng Baldwin na magsagawa ng pagsisiyasat sa warranty.

Eksklusibo ang warranty at mga obligasyon ng pagpapatupad ng warranty sa itaas at pumapalit ang mga ito sa lahat ng iba pang mga warranty o nauugnay na pagwawasto. Hindi mananagot ang Baldwin sa hindi direkta, nagkataon, punitive o consequential na mga sira na buhat sa mga produktong ginagawa o binebenta nito, anuman ang paraan.

BALDWIN FILTER WARRANTY

GARANTIE BALDWIN (French / Français)

Baldwin Filters, Inc. (« Baldwin ») garantit que chaque produit neuf fabriqué par Baldwin est exempt de défauts de matière et de main-d'œuvre. Baldwin remplacera tout produit qui a été déterminé défectueux si vous le renvoyez à Baldwin ou au distributeur Baldwin qui vous a vendu le produit.

Procédure de retour

Vous devez tout d'abord contacter votre vendeur chez Baldwin ou votre distributeur Baldwin si vous pensez que le produit que vous avez acheté ne satisfait pas aux conditions de la garantie énoncée ci-dessus. Le vendeur vous aidera à remplir les documents nécessaires et à renvoyer le produit supposé défectueux à Baldwin pour analyse.

Traitements des demandes de remplacement au titre de la garantie

Si Baldwin détermine que le produit renvoyé ne satisfait pas aux conditions de la garantie énoncée ci-dessus, Baldwin remplacera rapidement le produit défectueux. Si le produit défectueux a causé directement des dommages à la machine sur laquelle il a été installé, Baldwin remboursera rapidement le propriétaire de la machine des coûts des réparations qui ont été nécessaires pour remettre la machine dans l'état où elle était immédiatement avant d'être endommagée par le produit défectueux.

Conditions

Les obligations de Baldwin au titre de la garantie ne s'appliquent pas si : a) le produit n'est pas renvoyé à Baldwin pour analyse, b) Baldwin détermine que le produit n'est pas défectueux, c) le produit a été incorrectement installé ou utilisé, d) le produit a été ré-utilisé ou n'a pas été remplacé dans l'intervalle de service normal, ou e) le produit a été modifié sans autorisation ou endommagé de manière pouvant empêcher Baldwin de l'analyser au titre de la garantie.

La garantie ci-dessus et les obligations au titre de la garantie sont exclusives et remplacent toutes les autres garanties ou recours associés. Baldwin n'est pas responsable des dommages indirects, accessoires ou punitifs découlant de quelque forme que ce soit des produits qu'elle fabrique ou vend.

BALDWIN - GARANTIE (German / Deutsch)

Baldwin Filters, Inc. („Baldwin“) garantiert, dass jedes von Baldwin hergestellte neue Produkt im Herstellungszustand frei von Verarbeitungs- und Materialmängeln ist. Baldwin ersetzt jedes Produkt, das Sie an Baldwin oder an Ihren Baldwin-Händler, bei dem Sie es gekauft haben, zurückgeben und das für mangelhaft befunden wird.

Reklamation

Wenden Sie sich bitte zunächst an den zuständigen Vertriebsmitarbeiter bei Baldwin oder Ihrem Baldwin-Händler, wenn Sie zu der Auffassung gelangen, dass ein von Ihnen gekauftes Produkt nicht der obigen Garantieaussage entspricht. Der Vertriebsmitarbeiter hilft Ihnen gerne, die erforderlichen Unterlagen auszufüllen und das mutmaßlich mangelhafte Produkt zur Prüfung an Baldwin einzusenden.

Garantieleistung

Stellt Baldwin fest, dass ein reklamiertes Produkt tatsächlich nicht der obigen Garantieaussage entspricht, ersetzt Baldwin das mangelhafte Produkt unverzüglich. Hat das mangelhafte Produkt unmittelbar zu einem Schaden an der Maschine, in das es eingebaut wurde, geführt, erstattet Baldwin dem Maschineneigentümer unverzüglich den Anteil der Reparaturkosten, der zur Wiederherstellung des Maschinenzustands unmittelbar vor dem aufgrund des mangelhaften Produkts eingetretenen Schaden aufgewendet werden musste.

Bedingungen

Die Pflichten von Baldwin gemäß den obigen Garantiezusagen gelten nicht, wenn a) das Produkt nicht zur Prüfung an Baldwin zurückgegeben wird, b) Baldwin feststellt, dass das Produkt nicht mangelhaft war, c) das Produkt unsachgemäß eingebaut oder verwendet wurde, d) das Produkt wiederverwendet oder nicht innerhalb eines normalen Wartungszeitraums gewechselt wurde, oder d) das Produkt auf eine Weise manipuliert oder beschädigt wurde, die Baldwin an einer Garantieprüfung hindern kann.

Die obige Garantie und die damit verbundenen Pflichten gelten ausschließlich und anstelle aller sonstigen Garantien oder entsprechenden Rechtsbehelfe. Baldwin haftet nicht für indirekte, Begleit- oder Folgeschäden, Schadenersatz oder Bußgelder, die sich auf irgendeine Weise aus den von Baldwin hergestellten bzw. verkauften Produkten ergeben.

BALDWIN FILTER WARRANTY

GARANZIA BALDWIN (Italian / Italiano)

Baldwin Filters, Inc. ("Baldwin") garantisce che ciascun nuovo prodotto creato da Baldwin sarà privo di difetti di produzione e materiale. Baldwin sostituirà qualsiasi prodotto per il quale verrà rilevato un difetto, a seguito della sua restituzione a Baldwin o al distributore Baldwin presso il quale il prodotto è stato acquistato.

Procedimento di restituzione

Per prima cosa è necessario contattare il responsabile vendite di Baldwin o del distributore Baldwin presso il quale è stato acquistato il prodotto che si ritiene non soddisfa la garanzia qui riportata. Il responsabile vendite vi aiuterà a completare i documenti necessari e a restituire a Baldwin il prodotto ritenuto difettoso per la relativa analisi.

Adempimento della garanzia

Se Baldwin riscontra che il prodotto restituito non soddisfa la garanzia riportata, procederà a sostituire velocemente il prodotto difettoso. Se il prodotto difettoso ha provocato direttamente un danno alla macchina in cui è stato installato, Baldwin rimborserà subito il proprietario della macchina per quella parte dei costi di riparazione ritenuti necessari a ripristinare la macchina alla condizione immediatamente precedente al danno causato dal prodotto difettoso.

Condizioni

Gli obblighi di adempimento della garanzia Baldwin non si applicano se: a) Il prodotto non viene restituito a Baldwin per l'analisi; b) Baldwin rileva che il prodotto non era difettoso; c) Il prodotto è stato installato o utilizzato in modo non corretto; d) Il prodotto è stato riutilizzato o non sostituito entro un intervallo di servizio normale; e) Il prodotto è stato manomesso o danneggiato in modo tale da impedire a Baldwin di condurre un'investigazione per la garanzia.

La garanzia qui riportata e gli obblighi di adempimento della stessa sono esclusivi e sostituiscono qualsiasi altra garanzia o rimedio correlato. Baldwin non deve essere ritenuta responsabile per danni indiretti, accidentali, punitivi o diretti risultanti in qualsiasi modo dai prodotti creati o venduti.

ボールドウィンの品質保証 (Japanese)

Baldwin Filters, Inc. (ボールドウィン・フィルターズ・インク、以下「ボールドウィン」) は、ボールドウィンが製造した製品は、新品の製品個々について、製造上および素材における欠陥がないことを保証します。欠陥が発見された場合、ボールドウィンまたは、当該製品をお買い上げいただいたボールドウィン・ディストリビューターにご返却いただければ、製品を交換いたします。

返却の手続き

もし、お買い上げの製品が上記の保証を満たさないとお考えの場合は、まず、ボールドウィン社あるいはボールドウィン・ディストリビューターの販売員にご連絡ください。皆様の必要書類の作成をしたり、分析のために、欠陥が疑われる製品を弊社に返送するお手伝いをいたします。

製品保証の実行

返却された製品が、上記の保証内容を満たさないと確認されれば、弊社は、速やかにその欠陥製品を交換いたします。もし当該欠陥製品が直接的な原因となって、取り付けられた機械に損害を引き起こした場合、ボールドウィンは、その機械の所有者に対し、当該欠陥製品により損害が引き起こされる直前の状態に機械を復元するための修理費の一部を、速やかに払い戻します。

状態

上記のボールドウィン社の製品保証実施義務は、次の場合には当てはまりません: a) 製品が分析のためにボールドウィンに返却されなかった時、 b) ボールドウィンにおいて、当該製品には欠陥がないと判明した時、 c) 当該製品の不適切な取り付けや使用が為されていた時、 d) 当該製品が、再使用された時、あるいは、正常な点検修理のインターバル期間内に交換されなかった時、 e) 当該製品の改ざん又は損傷が為され、それがボールドウィンによる製品保証調査実施を妨げ得る方法だった時

上記製品保証および製品保証実行の義務は、排他的であり、他のあらゆる製品保証ないし関連賠償に代わるものです。ボールドウィンは、ボールドウィンが製造あるいは販売する製品から発生する、間接的、偶然的、懲罰的、あるいは結果として引き起こされる損傷に対し、どの様な形であれ、責任を負いません。

BALDWIN FILTER WARRANTY

Baldwin 보증 (Korean)

Baldwin Filters, Inc. ("Baldwin")는 Baldwin에서 제조한 각 신제품이 재질 및 제조상의 결함이 없음을 보증합니다. Baldwin은 귀하가 결함이 있는 제품을 Baldwin 또는 제품을 구입한 유통업체에 반납할 경우 결함이 있는 것으로 확인된 해당 제품을 교체합니다.

반납 과정

귀하가 위의 보증을 만족시키지 않는다고 믿는 제품을 구입한 경우에는 먼저 Baldwin 또는 Baldwin 유통업체의 판매직원에게 연락해야 합니다. 판매직원이 필요한 서류 작성 및 의심되는 결함 제품을 분석할 수 있도록 Baldwin에 반납하는 과정에 대해 도움을 드립니다.

보증 이행

반납한 제품이 위의 보증을 만족시키지 않는다는 것을 Baldwin이 확인하는 경우, Baldwin은 해당 결함 제품을 즉시 교체합니다. 결함 제품으로 인해 해당 제품이 설치된 기계에 직접적인 손상이 발생한 경우, Baldwin은 결함 제품에 의해 손상이 발생되기 바로 전의 상태로 기계를 복원하는 데 필요한 복구 비용 부분에 대해 해당 기계 소유주에게 즉시 배상합니다.

조건

위에 명시된 Baldwin의 보증 이행 의무는 다음의 경우에는 해당되지 않습니다. a) 분석을 위해 제품을 Baldwin에 반납하지 않은 경우, b) 해당 제품에 결함이 없다고 Baldwin이 확인하는 경우, c) 제품이 부적절하게 설치 또는 사용된 경우, d) 제품이 재사용되었거나 정상적인 서비스 기간 내에 교체되지 않은 경우, 또는 e) Baldwin의 보증 조사 수행을 제약할 수 있는 방식으로 제품이 조작되거나 손상된 경우.

위의 보증 및 보증 이행 의무는 배타적이며 기타 모든 보증 또는 관련 구제 방법을 대신합니다. Baldwin은 Baldwin이 제조하거나 판매하는 제품으로부터 어떠한 방식으로든 발생한 간접, 부수적, 징벌적 또는 파생적 손해에 대해 책임을 지지 않습니다.

A GARANTIA BALDWIN (Portuguese / Português)

A Baldwin Filters, Inc. ("Baldwin") garante que cada novo produto fabricado por ela será isento de defeitos de mão-de-obra e materiais. A Baldwin substituirá qualquer produto com defeito quando você o devolver à Baldwin ou ao seu distribuidor Baldwin onde o comprou.

Processo de Devolução

Em primeiro lugar, você deve contatar o vendedor que o atendeu na Baldwin ou no seu distribuidor Baldwin, se você comprou um produto que acredita não atender à garantia acima declarada. O vendedor o ajudará a preencher os documentos necessários e no processo de devolver o produto com suspeita de defeito à Baldwin para análise.

Atendimento da Garantia

Se a Baldwin determinar que um produto devolvido não atende à garantia acima declarada, a Baldwin o substituirá imediatamente. Se o produto defeituoso tiver causado danos diretos à máquina no qual estava instalado, a Baldwin imediatamente reembolsará o proprietário da máquina pela parte dos custos de reparo que tiverem sido necessários para restaurar a máquina a sua condição anterior aos danos causados pelo produto defeituoso.

Condições

As obrigações acima de atendimento da garantia da Baldwin não se aplicam se: a) o produto não for devolvido à Baldwin para análise, b) a Baldwin determinar que o produto não estava defeituoso, c) o produto tiver sido incorretamente instalado ou usado, d) o produto tiver sido reutilizado ou não substituído dentro do intervalo normal em serviço, ou e) o produto tiver sido adulterado ou danificado de maneira a inibir a capacidade da Baldwin conduzir uma investigação de garantia.

A garantia acima e as obrigações do seu atendimento são exclusivas e substituem quaisquer outras garantias ou soluções relacionadas. A Baldwin não se responsabiliza por danos indiretos, supervenientes, punitivos ou consequentes resultantes de qualquer forma dos produtos que fabrica ou vende.

BALDWIN FILTER WARRANTY

ГАРАНТИЯ КОМПАНИИ BALDWIN ("Болдуин") (Russian / Русский)

Компания Baldwin Filters, Inc. ("Baldwin") гарантирует, что в каждом новом товаре, произведенном компанией Baldwin, отсутствуют дефекты производства и материалов. Компания Baldwin произведет замену любого товара, в котором обнаружится брак, после возврата его в компанию Baldwin или дистрибьютору компании Baldwin, у которого был приобретен товар.

Процедура возврата товара

Если Вы считаете, что приобрели товар, который не соответствует вышеуказанным условиям гарантии, Вам сначала необходимо обратиться к сотруднику компании Baldwin или дистрибьютору компании Baldwin, у которого был приобретен товар. Данное лицо поможет Вам заполнить необходимые документы и произвести возврат товара с предполагаемым браком в компанию Baldwin для проведения анализа.

Исполнение гарантии

Если компания Baldwin придет к выводу, что товар не соответствует вышеуказанным условиям гарантии, она незамедлительно заменит бракованный товар. Если бракованный товар явился непосредственной причиной причинения повреждения оборудованию, на котором он был установлен, компания Baldwin незамедлительно вернет владельцу оборудования средства на ремонт, которые были необходимы для приведения оборудования в состояние, в котором оно находилось непосредственно перед возникновением повреждения, вызванного бракованным товаром.

Условия гарантии

Указанные выше обязательства по исполнению гарантии не применяются, если: а) товар не возвращен в компании Baldwin для проведения анализа, б) компания Baldwin придет к выводу, что товар не является бракованным, с) товар был неправильно установлен или неправильно использовался, d) товар был использован повторно или не был заменен в рамках нормального интервала обслуживания или e) товар подвергся таким изменениям или повреждениям, которые могут воспрепятствовать проведению компанией Baldwin расследования.

Вышеуказанная гарантия и обязательства по исполнению гарантии являются исчерпывающими и применяются вместо всех прочих гарантий или соответствующих средств судебной защиты. Компания Baldwin не несет ответственности за любые косвенные, побочные, штрафные и непрямые убытки, возникшие в любом виде из-за производимых или продаваемых ею товаров.

GARANTÍA DE BALDWIN (Spanish / Español)

Baldwin Filters, Inc. ("Baldwin") garantiza que cada producto nuevo fabricado por Baldwin estará libre de defectos de mano de obra y materiales. Baldwin reemplazará todo producto defectuoso cuando lo devuelva a Baldwin o al distribuidor de Baldwin donde lo compró.

Proceso de devolución

Primero debe contactar a su asociado de ventas en Baldwin o a su distribuidor de Baldwin si compró un producto que cree que no cumple con la garantía indicada arriba. El asociado de ventas le ayudará a completar la documentación necesaria y a devolver el producto sospechoso a Baldwin para su análisis.

Cumplimiento de la garantía

Si Baldwin determina que un producto devuelto no cumple con la garantía indicada arriba, reemplazará inmediatamente el producto defectuoso. Si el producto defectuoso causó daños directos a la máquina en la cual se instaló, Baldwin reembolsará con prontitud al propietario de la máquina por la parte de los costos de reparación que fueron necesarios para restaurar la máquina a su condición inmediatamente anterior al daño causado por el producto defectuoso.

Condiciones

Las obligaciones de cumplimiento de la garantía de Baldwin no corresponden si: a) el producto no es devuelto a Baldwin para su análisis, b) Baldwin determina que el producto no estaba defectuoso, c) el producto se había instalado o utilizado en forma inapropiada, d) el producto se reutilizó o no se reemplazó en el intervalo de servicio normal o e) el producto se manipuló o se dañó en una forma que no permite que Baldwin realice una investigación de garantía.

La garantía y las obligaciones de cumplimiento de garantía son exclusivas y en lugar de toda otra garantía o recursos asociados. Baldwin no es responsable por daños indirectos, incidentales, punitivos o consiguientes derivados en alguna forma de los productos que fabrica o vende.

NOTES

NOTES

PRODUCT INVESTIGATION

Procedure for Service Engineering Product Investigation

This procedure outlines the steps necessary for Baldwin Filters Service Engineering to complete an investigation of products from the field. The steps of this procedure are necessary to provide the most accurate and timely investigation possible.

If a filter is suspected of causing a failure, don't throw away the evidence. In order to process a warranty claim, follow the Product Investigation Procedure . . .

1. Complete a Field Report Form (Form 387) (see next page). Describe the events on a separate sheet.
2. Obtain a sample of oil, fuel or coolant in the system at the time of the failure.
3. Save damaged parts for evidence of the claimed damage.
4. For an air filter, cover the open end(s) with tape to prevent dust from entering the element during shipping.

5. Send copies of any repair bills.

6. Send the entire suspect filter, including the gaskets.

If the investigation is being requested for warranty consideration, repair bills (not estimates) should also accompany the request. Damaged equipment components such as bearings, liners, etc. should be retained by the customer for possible examination by Service Engineering.

Filter products are **NOT** to be cut open or otherwise tampered with. This may prevent objective analysis and testing, and **may void the warranty**.

Notice of damages and claims should be made immediately when the damage occurs. Every claim will receive careful and objective consideration. If a Baldwin product is proven to have caused damage, Baldwin will pay the cost required to repair the equipment to its condition at the time the failure occurred. Liability payment will not include consequential damages such as downtime, motel bills, etc.

If you have any questions regarding this procedure, or any product investigation, please contact our Service Engineering Team at

(308) 237-9729



FIELD REPORT FORM

DISTRIBUTOR

Company Name _____
 Address _____
 City _____
 State _____ ZIP _____
 Contact Person _____
 Phone _____

EQUIPMENT OWNER

Company Name _____
 Address _____
 City _____
 State _____ ZIP _____
 Contact Person _____
 Phone _____

Filter Number _____ Installation Date _____ Removal Date _____
 Repair Shop Name _____ Cost of Repairs \$ _____
 (ATTACH ITEMIZED REPAIR BILL)
 Street _____ Contact _____
 City _____ Phone _____
 State _____ ZIP _____ FAX _____

EQUIPMENT Model _____ Year _____ Serial No. _____
 Type of Equipment _____ Make _____
 Damaged Part (Engine, Pump, Etc.) _____ Total Miles or Hours on Unit _____

AIR FILTER Has the system recently been worked on? _____
 Has the filter been washed? _____ Miles/Hours on Oil _____ Oil Sump Capacity _____
 Pressure/Restriction Gauge reading at removal _____ (psi/inches of H₂O/Mercury)
 Usual Filter Change Interval _____ (Miles/Hours)

COOLANT How often is the system tested? _____
 Type of Antifreeze Used _____ Cooling System Capacity _____ Type of SCA Used _____
 Cooling System Last Cleaned _____ (Miles/Hours)

OIL/HYDRAULIC Has the system recently been worked on? _____
 Type of Oil _____ Oil Sump Capacity _____ Miles/Hours on Oil _____
 Usual Oil Change Interval _____ (Miles/Hours)

FUEL Has the system recently been worked on? _____
 Type of Fuel _____ Miles/Hours on Filter _____ Fuel System Pressure _____

PLEASE USE A SEPARATE PAGE TO DESCRIBE WHAT HAPPENED!

Signature of Distributor _____ Signature of Owner _____

Please send this Report, any Repair Bills, Explanation, Oil/Coolant Samples and Filters to:

ATTN: SERVICE ENGINEERING
BALDWIN FILTERS
 4400 E Hwy 30
 Kearney, NE 68847



ONLINE CATALOG

The Baldwin Filters eCatalog provides fast, easy access to product specifications, cross-reference searches, application (year, make, model) lookups and much more.

FEATURES

- Streamlined Application Searches
- Multiple Line Cross-Reference Lookup
- Searchable Size Charts
- Searchable UPC Codes
- New Product Releases

BALDWIN FILTERS **ECATALOG**

BaldwinFilter.com Home Product Searches Resources Product Announcements Contact Us

Cross-Reference
An "*" may be used as a wild card anywhere in the number.

Find Crosses
Add Lines
New Search

Searches
Cross-Reference Search
Product Guide
Application Search
Keyword Search
Size Chart Search
UPC Codes Search
Product Announcements

Quick Links
Abbreviations
Date Code Methods
Manufacturing Codes
Prefixes & Suffixes
Weights & Volumes
Warranties & Certificates

Contact Customer Support
Phone: (800) 822-5394
Email: hotline@baldwinfilter.com

Check Applications Catalog to Verify Cross-Reference
The word "Manufacturer" is used only for ease of reference. It may include distributors, resellers, etc. that do not actually manufacture the applicable part.

© 2017 Baldwin Filters, Inc. | 4400 East Highway 30 | Kearney, NE 68647 | Ph: 800-822-5394 | Fax: 800-828-4453

TS 16949
ISO 9001



QUALITY SYSTEM
CERTIFIED



WARNING: These products can expose you to chemicals, including Diisononyl Phthalate, Carbon black extracts, Nickel, 1,3 Butadiene, Ethylene Oxide, Epichlorohydrin, which are known to the State of California to cause cancer, and Bisphenol-A, Ethylene Glycol, Ethylene Oxide, 1,3 Butadiene, Epichlorohydrin, which are known to the State of California to cause birth defects or other reproductive harm. For more information go to www.P65Warnings.ca.gov.